



This is a digital copy of a book that was preserved for generations on library shelves before it was carefully scanned by Google as part of a project to make the world's books discoverable online.

It has survived long enough for the copyright to expire and the book to enter the public domain. A public domain book is one that was never subject to copyright or whose legal copyright term has expired. Whether a book is in the public domain may vary country to country. Public domain books are our gateways to the past, representing a wealth of history, culture and knowledge that's often difficult to discover.

Marks, notations and other marginalia present in the original volume will appear in this file - a reminder of this book's long journey from the publisher to a library and finally to you.

Usage guidelines

Google is proud to partner with libraries to digitize public domain materials and make them widely accessible. Public domain books belong to the public and we are merely their custodians. Nevertheless, this work is expensive, so in order to keep providing this resource, we have taken steps to prevent abuse by commercial parties, including placing technical restrictions on automated querying.

We also ask that you:

- + *Make non-commercial use of the files* We designed Google Book Search for use by individuals, and we request that you use these files for personal, non-commercial purposes.
- + *Refrain from automated querying* Do not send automated queries of any sort to Google's system: If you are conducting research on machine translation, optical character recognition or other areas where access to a large amount of text is helpful, please contact us. We encourage the use of public domain materials for these purposes and may be able to help.
- + *Maintain attribution* The Google "watermark" you see on each file is essential for informing people about this project and helping them find additional materials through Google Book Search. Please do not remove it.
- + *Keep it legal* Whatever your use, remember that you are responsible for ensuring that what you are doing is legal. Do not assume that just because we believe a book is in the public domain for users in the United States, that the work is also in the public domain for users in other countries. Whether a book is still in copyright varies from country to country, and we can't offer guidance on whether any specific use of any specific book is allowed. Please do not assume that a book's appearance in Google Book Search means it can be used in any manner anywhere in the world. Copyright infringement liability can be quite severe.

About Google Book Search

Google's mission is to organize the world's information and to make it universally accessible and useful. Google Book Search helps readers discover the world's books while helping authors and publishers reach new audiences. You can search through the full text of this book on the web at <http://books.google.com/>

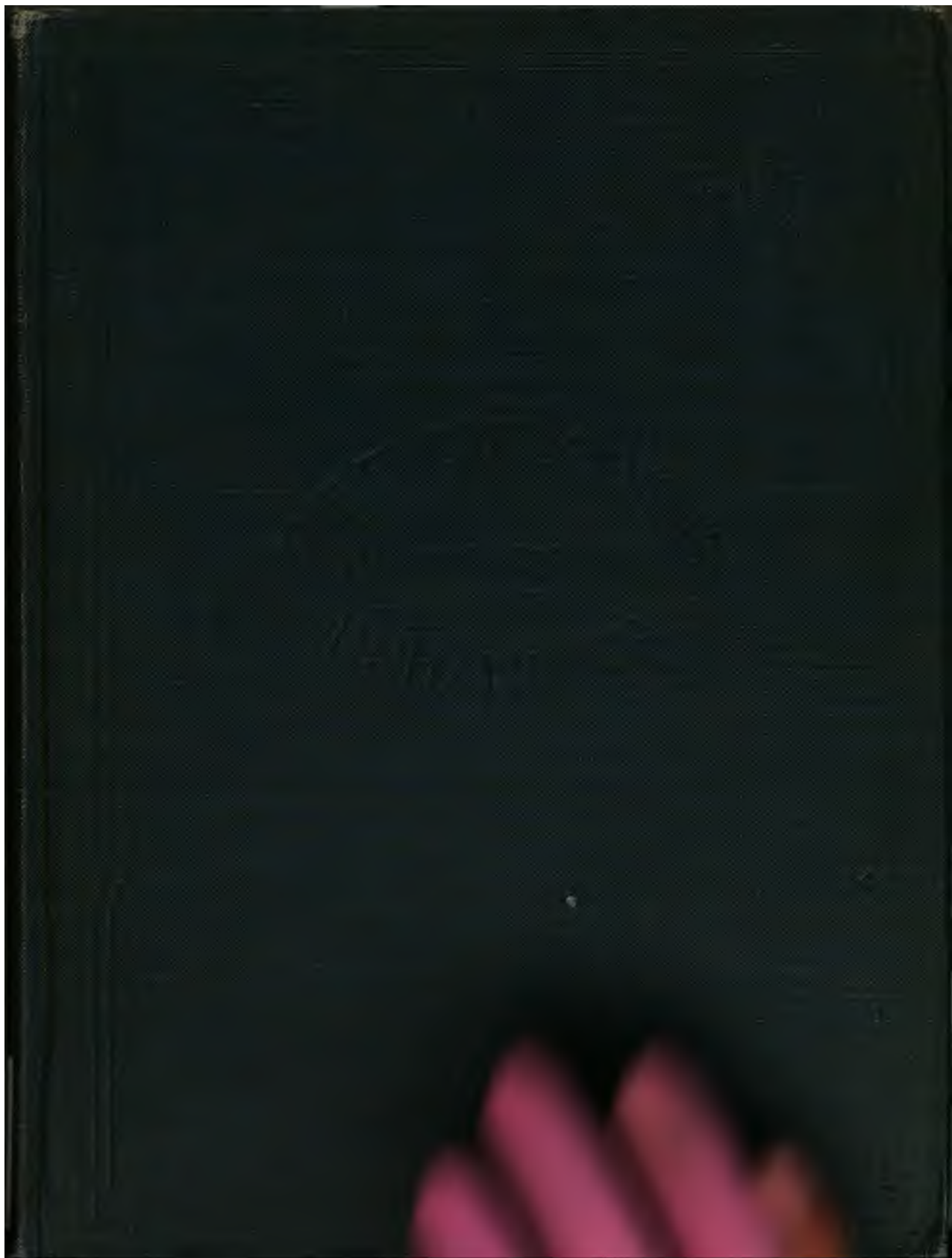

Gift of

John Rawlings



STANFORD UNIVERSITY LIBRARIES



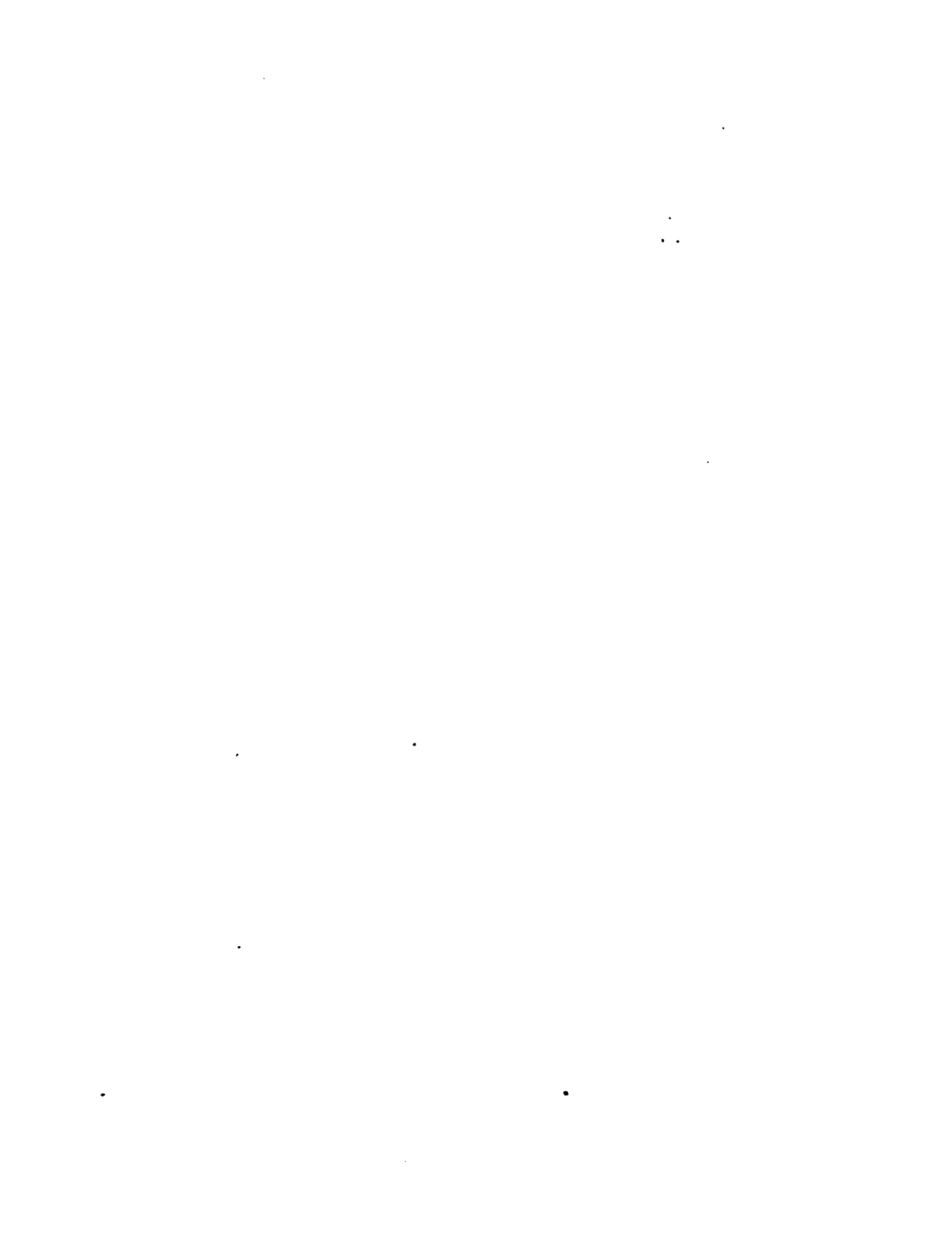





Gift of

John Rawlings



STANFORD UNIVERSITY LIBRARIES

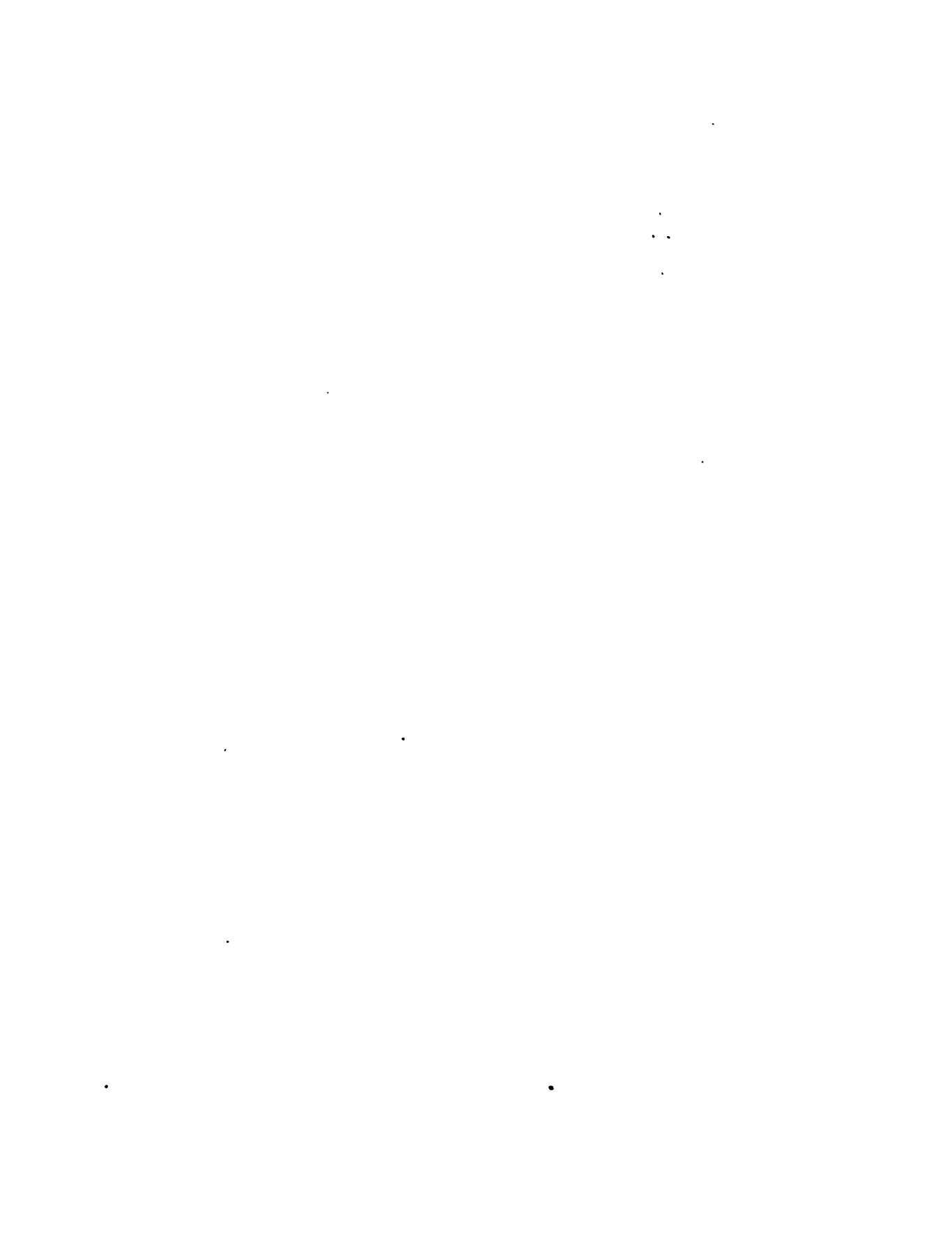

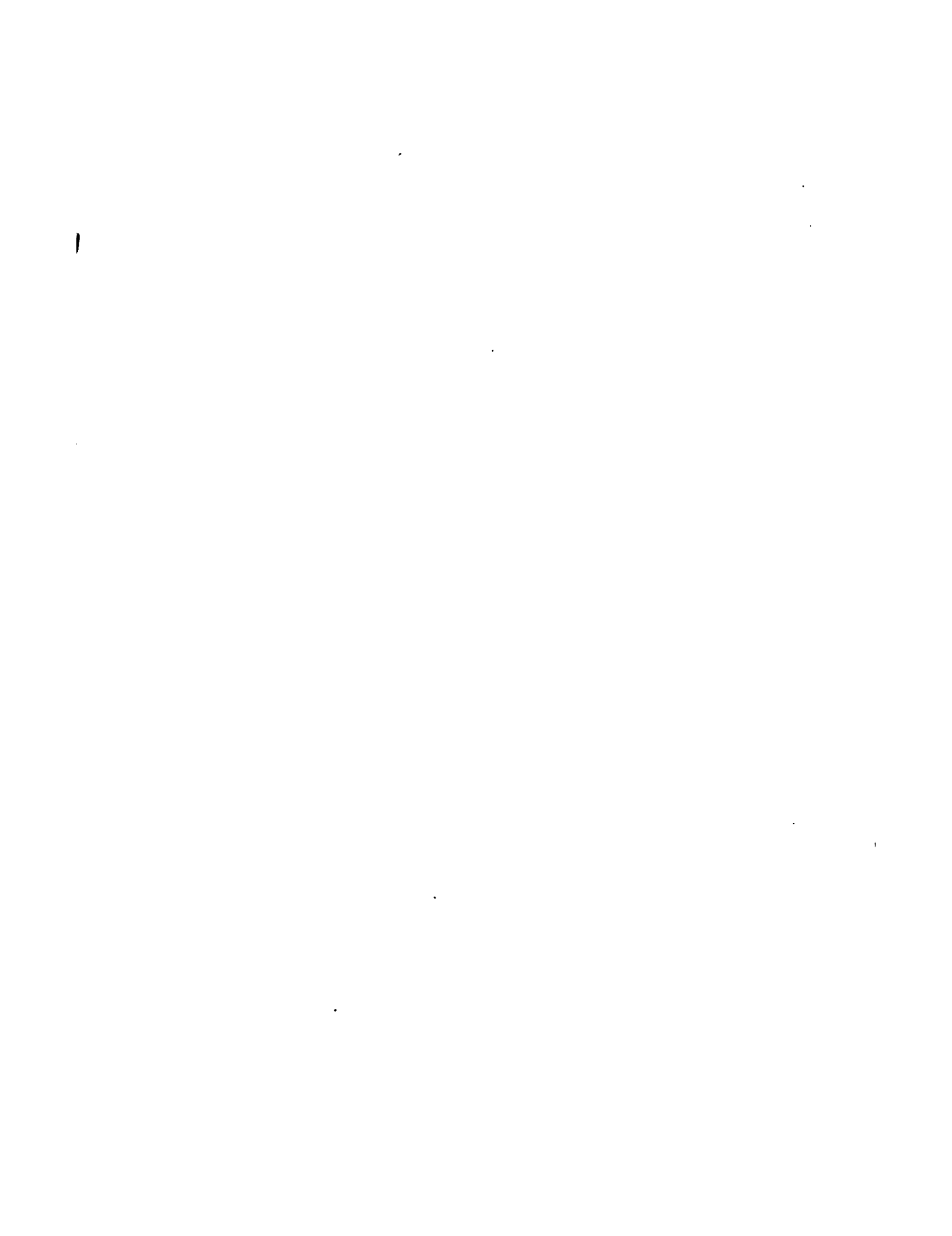

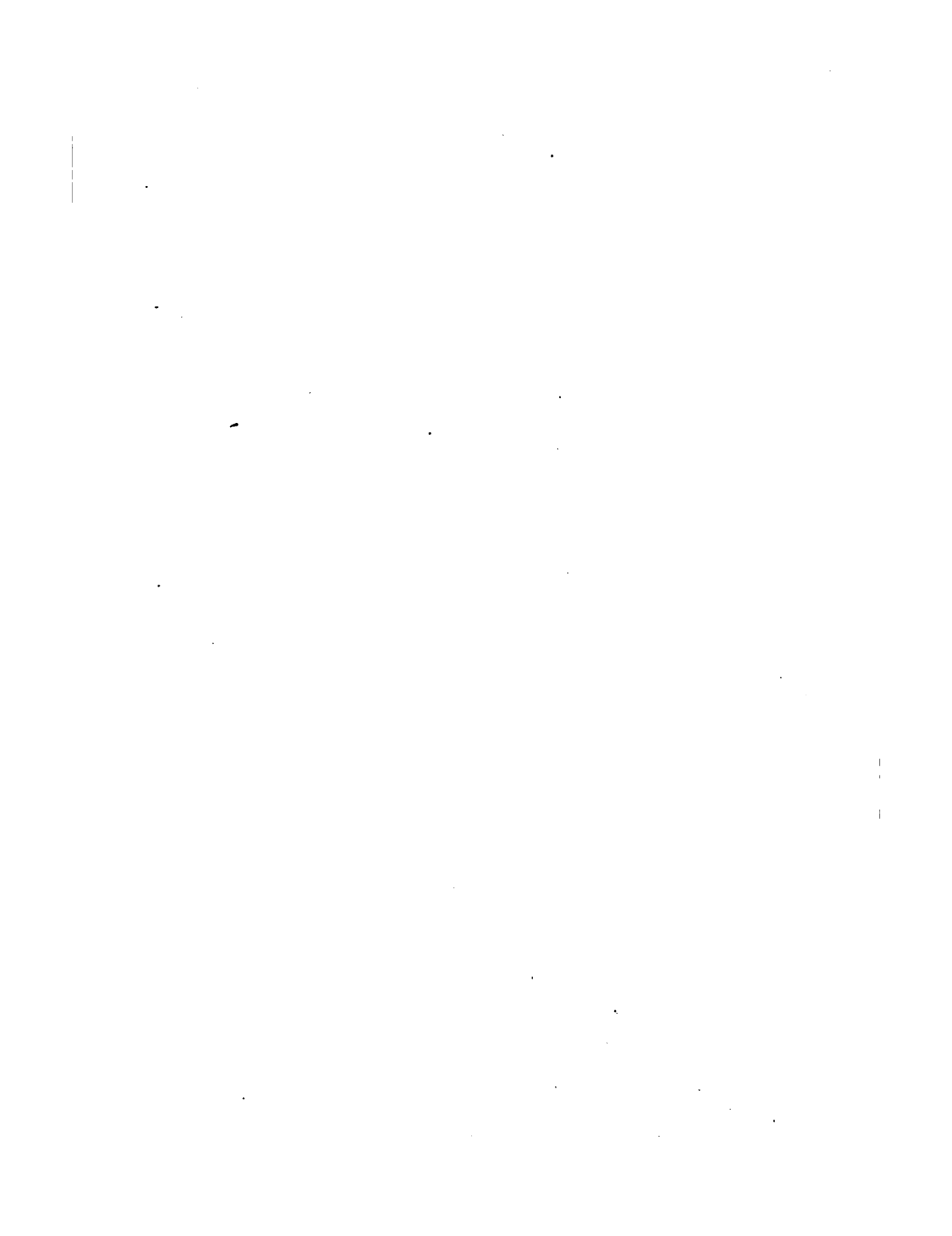

THE ENCYCLOPÆDIA BRITANNICA

ELEVENTH EDITION

FIRST	edition, published in three	volumes,	1768—1771.
SECOND	“ “ ten	“	1771—1784.
THIRD	“ “ eighteen	“	1788—1797.
FOURTH	“ “ twenty	“	1801—1810.
FIFTH	“ “ twenty	“	1815—1817.
SIXTH	“ “ twenty	“	1821—1824.
SEVENTH	“ “ twenty-one	“	1830—1842.
EIGHTH	“ “ twenty-two	“	1853—1860.
NINTH	“ “ twenty-five	“	1875—1880.
TENTH	“ ninth edition and eleven		
	supplementary volumes,		1902—1903.
ELEVENTH	“ published in twenty-nine volumes,		1910—1911.

THE
ENCYCLOPÆDIA BRITANNICA

A
DICTIONARY
OF
ARTS, SCIENCES, LITERATURE AND GENERAL
INFORMATION

ELEVENTH EDITION

VOLUME XII
GICHTEL to HARMONIUM

NEW YORK
THE ENCYCLOPÆDIA BRITANNICA COMPANY
1910

Copyright, in the United States of America, 1910,
by
The Encyclopædia Britannica Company.

**INITIALS USED IN VOLUME XII. TO IDENTIFY INDIVIDUAL
CONTRIBUTORS, WITH THE HEADINGS OF THE
ARTICLES IN THE VOLUME SO SIGNED.**

A. A. R.*	ARTHUR ALCOCK RAMBAUT, M.A., D.Sc., F.R.S., F.R.A.S. Radcliffe Observer, Oxford. Professor of Astronomy in the University of Dublin and Royal Astronomer of Ireland, 1892-1897.	}	Grant, Robert.
A. C. Se.	ALBERT CHARLES SEWARD, M.A., F.R.S. Professor of Botany in the University of Cambridge. Hon. Fellow of Emmanuel College, Cambridge. President of the Yorkshire Naturalists' Union, 1910.	}	Gymnosperms.
A. F. P.	ALBERT FREDERICK POLLARD, M.A., F.R.HIST.S. Fellow of All Souls College, Oxford. Professor of English History in the University of London. Assistant Editor of the <i>Dictionary of National Biography</i> , 1893-1901. Author of <i>England under the Protector Somerset</i> ; <i>Life of Thomas Cranmer</i> ; &c.	}	Grindal.
A. Go.*	REV. ALEXANDER GORDON, M.A. Lecturer on Church History in the University of Manchester.	}	Grynaeus, Simon; Haetszer.
A. G. B.*	HON. ARCHIBALD GRAEME BELL, M.INST.C.E. Director of Public Works and Inspector of Mines, Trinidad. Member of Executive and Legislative Councils, Inst.C.E.	}	Gulana.
A. H.-S.	SIR A. HOUTUM-SCHINDLER, C.I.E. General in the Persian Army. Author of <i>Eastern Persian Irak</i> .	}	Gilan; Hamadân.
A. He.	ARTHUR HERVEY. Formerly Musical Critic to <i>Morning Post</i> and <i>Vanity Fair</i> . Author of <i>Masters of French Music</i> ; <i>French Music in the XIX. Century</i> .	}	Gounod.
A. H. S.	REV. A. H. SAYCE, D.D. See the biographical article, SAYCE, A. H.	}	Grammar; Gyges.
A. J. G.	REV. ALEXANDER JAMES GRIEVE, M.A., B.D. Professor of New Testament and Church History at the United Independent College, Bradford. Sometime Registrar of Madras University and Member of Mysore Educational Service.	}	Haggal (<i>in part</i>).
A. J. H.	ALFRED JAMES HIPKINS. Formerly Member of Council and Hon. Curator of Royal College of Music. Member of Committee of the Inventions and Music Exhibition, 1885; of the Vienna Exhibition, 1892; and of the Paris Exhibition, 1900. Author of <i>Musical Instruments</i> ; <i>A Description and History of the Pianoforte</i> ; &c.	}	Harmonium (<i>in part</i>).
A. L.	ANDREW LANG. See the biographical article, LANG, ANDREW.	}	Gurney, Edmund.
A. M. C.	AGNES MARY CLERKE. See the biographical article, CLERKE, A. M.	}	Halley; Hansen. Goatsucker; Godwit; Golden-eye; Goldfinch; Goose; Gos-Hawk; Grackle; Grebe; Greenfinch; Greenshank; Grosbeak; Greuse; Guacharo; Guan; Guillemot; Guinea-Fowl; Gull, Hammer-Kop.
A. N.	ALFRED NEWTON, F.R.S. See the biographical article, NEWTON, ALFRED.	}	Glass: <i>History of Manufacture</i> (<i>in part</i>).
A. No.	ALEXANDER NESBITT, F.S.A. Author of the <i>Introduction to A Descriptive Catalogue of the Glass Vessels in South Kensington Museum</i> .	}	Gold and Silver Thread
A. S. C.	ALAN SUMMERLY COLE, C.B. Assistant Secretary for Art, Board of Education, 1900-1908. Author of <i>Ancient Needle Point and Pillow Lace</i> ; <i>Embroidery and Lace</i> ; <i>Ornament in European Silks</i> ; &c.	}	Goncourt, De; Hardy, Thomas.
A. Sy.	ARTHUR SYMONS. See the biographical article, SYMONS, A.	}	

* A complete list, showing all individual contributors, appears in the final volume.

INITIALS AND HEADINGS OF ARTICLES

- A. W. H.*** ARTHUR WILLIAM HOLLAND.
Formerly Scholar of St John's College, Oxford. Bacon Scholar of Gray's Inn, 1900. { Godfrey of Viterbo;
Golden Bull; Habsburg.
- A. W. R.** ALEXANDER WOOD RENTON, M.A., LL.B.
Puisne Judge of the Supreme Court of Ceylon. Editor of *Encyclopaedia of the*
Laws of England. { Ground Rent;
Handwriting.
- A. W. W.** ADOLPHUS WILLIAM WARD, LL.D., LITT.D.
See the biographical article, WARD A. W. { Greené, Robert.
- C. F. A.** CHARLES FRANCIS ATKINSON.
Formerly Scholar of Queen's College, Oxford. Captain, 1st City of London (Royal
Fusiliers). Author of *The Wilderness and Cold Harbour.* { Grand Alliance, War of the;
Grant, Ulysses S. (*in part*);
Great Rebellion.
- C. Gr.** CHARLES GROSS, A.M., PH.D., LL.D. (1857-1909).
Professor of History at Harvard University, 1888-1909. Author of *The Guild*
Merchant; Sources and Literature of English History; &c. { Gilds.
- C. H.*** SIR C. HOLROYD.
See the biographical article, HOLROYD, SIR C. { Haden, Sir F. C.
- C. H. C.** CHARLES H. COOTE.
Formerly of Map Department, British Museum. { Hakluyt (*in part*).
- C. H. Ha.** CARLTON HUNTLEY HAYES, A.M., PH.D.
Assistant Professor of History in Columbia University, New York City. Member
of the American Historical Association. { Gregory, Popes, VIII to
XII; Guibert.
- C. J. L.** SIR CHARLES JAMES LYALL, K.C.S.I., C.I.E., LL.D. (Edin.)
Secretary, Judicial and Public Department, India Office. Fellow of King's College,
London. Secretary to Government of India in Home Department, 1889-1894.
Chief Commissioner, Central Provinces, India, 1895-1898. Author of *Translations*
of Ancient Arabic Poetry; &c. { Hamasa.
- C. L.*** CHARLES LAPWORTH, M.Sc., LL.D., F.R.S., F.G.S.
Professor of Geology and Physiography in the University of Birmingham. Editor
of *Monograph on British Graptolites*, Palaeontographical Society, 1900-1908. { Graptolites.
- C. L. K.** CHARLES LETHBRIDGE KINGSFORD, M.A., F.R.HIST.S., F.S.A.
Assistant Secretary to the Board of Education. Author of *Life of Henry V.*
Editor of *Chronicles of London*, and *Stow's Survey of London.* { Glendower, Owen;
Gloucester, Humphrey,
Duke of;
Hallam, Bishop;
Hardyng, John.
- C. M.** CARL THEODOR MIRBT, D.TH.
Professor of Church History in the University of Marburg. Author of *Publizistik*
im Zeitalter Gregor VII.; Quellen zur Geschichte des Papstthums; &c. { Gregory VII.
- C. MI.** CREDOMILÉ MIJATOVICH.
Senator of the Kingdom of Servia. Envoy Extraordinary and Minister Pleni-
potentiary of the King of Servia to the Court of St James', 1895-1900 and 1902-
1903. { Gundallah.
- C. M. W.** SIR CHARLES MOORE WATSON, K.C.M.G., C.B.
Colonel, Royal Engineers. Deputy-Inspector-General of Fortifications, 1896-1902.
Served under General Gordon in the Soudan, 1874-1875. { Gordon, General.
- C. Pl.** CHRISTIAN PFISTER, D.-ès-L.
Professor at the Sorbonne, Paris. Chevalier of the Legion of Honour. Author
of *Études sur le règne de Robert le Pieux.* { Gregory, St, of Tours;
Gunther of Schwarzburg.
- C. R. B.** CHARLES RAYMOND BEAZLEY, M.A., D.LITT., F.R.G.S., F.R.HIST.S.
Professor of Modern History in the University of Birmingham. Formerly Fellow
of Merton College, Oxford, and University Lecturer in the History of Geography.
Lothian Prizeman, Oxford, 1889. Lowell Lecturer, Boston, 1908. Author of
Henry the Navigator; The Dawn of Modern Geography; &c. { Gomez; Hakluyt
(*in part*).
- C. We.** CECIL WEATHERLY.
Formerly Scholar of Queen's College, Oxford. Barrister-at-Law. { Grafito.
- C. W. E.** CHARLES WILLIAM ELIOT.
See the biographical article, ELIOT, C. W. { Gray, Asa.
- D. C. To.** REV. DUNCAN CROOKES TOVEY, M.A.
Editor of *The Letters of Thomas Gray; &c.* { Gray, Thomas.
- D. P. T.** DONALD FRANCIS TOVEY.
Author of *Essays in Musical Analysis*: comprising *The Classical Concerto, The*
Goldberg Variations, and analysis of many other classical works. { Gluck; Handel.
- D. G. H.** DAVID GEORGE HOGARTH, M.A.
Keeper of the Ashmolean Museum, Oxford. Fellow of Magdalen College, Oxford.
Fellow of the British Academy. Excavated at Paphos, 1888; Naucratis, 1899 and
1903; Ephesus, 1904-1905; Assiut, 1906-1907; Director, British School at Athens,
1897-1900; Director, Cretan Exploration Fund, 1899. { Hallicarnassus.
- D. H.** DAVID HANNAY.
Formerly British Vice-Consul at Barcelona. Author of *Short History of Royal Navy,*
1217-1688: Life of Emilio Castelar; &c. { Gondomar, Count;
Grand Alliance, War of
the: Naval Operations;
Guichen; Hamilton, Emma.

INITIALS AND HEADINGS OF ARTICLES

vii

D. LL. T.	DANIEL LLEUFER THOMAS. Barrister-at-Law, Lincoln's Inn. Stipendiary Magistrate at Pontypridd and Rhondda.	{ Glamorganshire; Gower.
D. MR.	REV. DUGALD MACFADYEN, M.A. Minister of South Grove Congregational Church, Highgate. Author of <i>Constructive Congregational Ideals</i> ; &c.	{ Glas, John; Glasites.
D. M. W.	SIR DONALD MACKENZIE WALLACE, K.C.I.E., K.C.V.O. Extra Groom-in-Waiting to H.M. King George V. Director of the Foreign Department of <i>The Times</i> , 1891-1899. Member of Institut de Droit International and Officer de l'Instruction Publique of France. Joint-editor of new volumes (10th edition) of the <i>Encyclopaedia Britannica</i> . Author of <i>Russia</i> ; <i>Egypt and the Egyptian Question</i> ; <i>The Web of Empire</i> ; &c.	{ Giers; Gorchakov.
E. A. F.	EDWARD AUGUSTUS FREEMAN, LL.D. See the biographical article, FREEMAN, E. A.	{ Goths (<i>in part</i>).
E. A. J.	E. ALFRED JONES. Author of <i>Old English Gold Plate</i> ; <i>Old Church Plate of the Isle of Man</i> ; <i>Old Silver Sacramental Vessels of Foreign Protestant Churches in England</i> ; <i>Illustrated Catalogue of Leopold de Rothschild's Collection of Old Plate</i> ; <i>A Private Catalogue of The Royal Plate at Windsor Castle</i> ; &c.	{ Golden Rose (<i>in part</i>).
E. B.*	ERNEST CHARLES FRANÇOIS BABELON. Professor at the Collège de France. Keeper of the department of Medals and Antiquities at the Bibliothèque Nationale. Member of the Académie des Inscriptions et Belles Lettres, Paris. Chevalier of the Legion of Honour. Author of <i>Descriptions historiques des monnaies de la république romaine</i> ; <i>Traité des monnaies grecques et romaines</i> ; <i>Catalogue des camées de la bibliothèque nationale</i> .	{ Hadrumetum.
E. BR.	ERNEST BARKER, M.A. Fellow and Lecturer in Modern History at St John's College, Oxford. Formerly Fellow and Tutor of Merton College. Craven Scholar, 1895.	{ Godfrey of Bouillon.
E. C. B.	RT. REV. EDWARD CUTHBERT BUTLER, O.S.B., M.A., D.LITT. (Dublin). Abbot of Downside Abbey, Bath. Author of "The Lausiac History of Palladius" in <i>Cambridge Texts and Studies</i> , vol. vi.	{ Gilbert of Sempringham, St; Grandmontines; Groot.
E. C. Sp.	REV. EDWARD CLARKE SPICER, M.A. New College, Oxford. Geographical Scholar, 1900.	{ Glacier.
E. F. G.	EDWIN FRANCIS GAY, PH.D. Professor of Economics and Dean of the Graduate School of Business Administration, Harvard University.	{ Hanseatic League.
E. F. S. D.	LADY DILKE. See the biographical article, DILKE, SIR C. W., Bart.	{ Greuze.
E. G.	EDMUND GOSSE, LL.D. See the biographical article, GOSSE, E.	{ Gnome.
E. H. P.	EDWARD HENRY PALMER, M.A. See the biographical article, PALMER, E. H.	{ Hiss.
E. J. P.	EDWARD JOHN PAYNE, M.A. (1844-1904). Formerly Fellow of University College, Oxford. Editor of the <i>Select Works of Burke</i> . Author of <i>History of European Colonies</i> ; <i>History of the New World called America</i> ; <i>The Colonies</i> , in the "British Citizen" Series; &c.	{ Grey, 2nd Earl.
EA. M.	EDUARD MEYER, PH.D., D.LITT. (Oxon), LL.D. (Chicago). Professor of Ancient History in the University of Berlin. Author of <i>Geschichte des Alterthums</i> ; <i>Geschichte des alten Aegyptens</i> ; <i>Die Israeliten und ihre Nachbarstämme</i> .	{ Gotazes.
E. M. W.	REV. EDWARD MEWBURN WALKER, M.A. Fellow, Senior Tutor and Librarian of Queen's College, Oxford.	{ Greece: History, Ancient, to 146 B.C.
E. O.*	EDMUND OWEN, M.B., F.R.C.S., LL.D., D.Sc. Consulting Surgeon to St Mary's Hospital, London, and to the Children's Hospital, Great Ormond Street, London. Chevalier of the Legion of Honour. Late Examiner in Surgery at the Universities of Cambridge, London and Durham. Author of <i>A Manual of Anatomy for Senior Students</i> .	{ Goltre; Haemorrhoids.
E. PR.	EDGAR PRESTAGE. Special Lecturer in Portuguese Literature in the University of Manchester. Examiner in Portuguese in the Universities of London, Manchester, &c. Comendador, Portuguese Order of S. Thiago. Corresponding Member of Lisbon Royal Academy of Sciences, Lisbon Geographical Society, &c. Editor of <i>Letters of a Portuguese Nun</i> ; <i>Azurara's Chronicle of Guinea</i> ; &c.	{ Goes, Damião De; Gonzaga.
E. R.	LORD LOCHEE OF GOWRIE (Edmund Robertson), P.C., LL.D., K.C. Civil Lord of the Admiralty, 1892-1895. Secretary to the Admiralty, 1905-1908. M.P. for Dundee, 1885-1906. Fellow of Corpus Christi College, Oxford.	{ Hallam, Henry.
E. S. G.	EDWIN STEPHEN GOODRICH, M.A., F.R.S. Fellow and Librarian of Merton College, Oxford. Aldrichian Demonstrator of Comparative Anatomy, University Museum, Oxford.	{ Haplodril.
F. C. C.	FREDERICK CORNWALLIS CONYBEARE, M.A., D.TH. (Glissen). Fellow of the British Academy. Formerly Fellow of University College, Oxford. Author of <i>The Ancient Armenian Texts of Aristotle</i> ; <i>Myth, Magic and Morals</i> ; &c.	{ Gregory the Illuminator.
F. G. M. B.	FREDERICK GEORGE MEZSON BECK, M.A. Fellow and Lecturer in Classics, Clare College, Cambridge.	{ Goths (<i>in part</i>).

INITIALS AND HEADINGS OF ARTICLES

- F. G. S.** F. G. STEPHENS. Formerly Art Critic of the *Athenaeum*. Author of *Artists at Home*; *George Cruikshank*; *Memorials of W. Mulready*; *French and Flemish Pictures*; *Sir E. Landseer*; *T. C. Hook, R.A.*; &c. { Gilbert, Sir John.
- F. H. D.** REV. FREDERICK HOMES DUDDEN, D.D. Fellow, Tutor and Lecturer in Theology, Lincoln College, Oxford. Author of *Gregory the Great, his Place in History and Thought*; &c. { Gregory I.
- F. H. H.** FRANKLIN HENRY HOOPER. Assistant Editor of the *Century Dictionary*. { Hancock, Winfield Scott.
- F. J. H.** FRANCIS JOHN HAVERFIELD, M.A., LL.D., F.S.A. Camden Professor of Ancient History in the University of Oxford. Fellow of Brasenose College. Fellow of the British Academy. Author of Monographs on Roman History, especially Roman Britain; &c. { Graham's Dyke.
- F. N.** FRIDTJOF NANSEN. See the biographical article, NANSEN, FRIDTJOF. { Greenland.
- F. R. C.** FRANK R. CANA. Author of *South Africa from the Great Trek to the Union*. { Gold Coast.
- F. S. P.** FRANCIS SAMUEL PHILBRICK, A.M., PH.D. Formerly Scholar and Resident Fellow of Harvard University. Member of American Historical Association. { Hamilton, Alexander.
- F. W. R.*** FREDERICK WILLIAM RUDLER, I.S.O., F.G.S. Curator and Librarian of the Museum of Practical Geology, London, 1879-1902. President of the Geologists' Association, 1887-1889. { Gypsum; Haematite.
- G. A. Gr.** GEORGE ABRAHAM GRIERSON, C.I.E., PH.D., D.LITT. (Dublin). Member of the Indian Civil Service, 1873-1903. In charge of Linguistic Survey of India, 1898-1902. Gold Medallist, Royal Asiatic Society, 1909. Vice-President of the Royal Asiatic Society. Formerly Fellow of Calcutta University. Author of *The Languages of India*; &c. { Gujarati and Rajasthani.
- G. C. M.** GEORGE CAMPBELL MACAULAY, M.A. Lecturer in English in the University of Cambridge. Formerly Professor of English Language and Literature in the University of Wales. Editor of the *Works of John Gower*; &c. { Gower, John.
- G. C. W.** GEORGE CHARLES WILLIAMSON, LITT.D. Chevalier of the Legion of Honour. Author of *Portrait Miniatures*; *Life of Richard Conway, R.A.*; *George Engleheart*; *Portrait Drawings*; &c. Editor of new edition of Bryan's *Dictionary of Painters and Engravers*. { Greco, El.
- G. F. Z.** GEORGE FREDERICK ZIMMER, A.M. INST. C.E. Author of *Mechanical Handling of Material*. { Granaries.
- G. G.** SIR ALFRED GEORGE GREENHILL, M.A., F.R.S. Formerly Professor of Mathematics in the Ordnance College, Woolwich. Examiner in the University of Wales. Member of the Aeronautical Committee. Author of *Notes on Dynamics*; *Hydrostatics*; *Differential and Integral Calculus, with Applications*; &c. { Gyroscope and Gyrostat.
- G. Sn.** GRANT SHOWERMAN, A.M., PH.D. Professor of Latin in the University of Wisconsin. Member of the Archaeological Institute of America. Member of American Philological Association. Author of *With the Professor*; *The Great Mother of the Gods*; &c. { Great Mother of the Gods.
- G. S. C.** SIR GEORGE SYDENHAM CLARKE, G.C.M.G., G.C.I.E., F.R.S. Governor of Bombay. Author of *Imperial Defence*; *Russia's Great Sea Power*; *The Last Great Naval War*; &c. { Greco-Turkish War, 1897.
- G. W. E. R.** Rt. HON. GEORGE WILLIAM ERSKINE RUSSELL, P.C., M.A., LL.D. Under-Secretary of State for the Home Department, 1894-1895; for India, 1892-1894. M.P. for Aylesbury, 1880-1885; for North Beds., 1892-1895. Author of *Life of W. E. Gladstone*; *Collections and Recollections*; &c. { Gladstone, W. E.
- G. W. T.** REV. GRIFFITHS WHEELER THATCHER, M.A., B.D. Warden of Camden College, Sydney, N.S.W. Formerly Tutor in Hebrew and Old Testament History at Mansfield College, Oxford. { HAJJI KHALIFĀ; Hamadhāni; Handāni; Hammad ar-Rāwīya; Harīf.
- H. A. de C.** HENRY ANSELM DE COLYAR, K.C. Author of *The Law of Guarantees and of Principal and Surety*; &c. { Guarantee.
- H. B. Wo.** HORACE BOLINGBROKE WOODWARD, F.R.S., F.G.S. Formerly Assistant Director of the Geological Survey of England and Wales. President, Geologists' Association, 1893-1894. Wollaston Medallist, 1908. { Haldinger, W. K.
- H. Ch.** HUGH CHISHOLM, M.A. Formerly Scholar of Corpus Christi College, Oxford. Editor of the 11th edition of the *Encyclopaedia Britannica*; co-editor of the 10th edition. { Goschen, 1st Viscount; Granville, 2nd Earl; Hamilton, Alexander (in part); Harcourt, Sir William.
- H. De.** HIPPOLYTE DELERHAYE, S. J. Assistant in the compilation of the Bollandist publications: *Analecta Bollandiana* and *Acta sanctorum*. { Gfies, St; Hagiology.
- H. G. H.** HORATIO GORDON HUTCHINSON. Amateur Golf Champion, 1886-1887. Author of *Hints on Golf*; *Golf* (Badminton Library); *Book of Golf and Golfers*; &c. { Golf.

INITIALS AND HEADINGS OF ARTICLES

ix

H. J. P.	HARRY JAMES POWELL, F.C.S. Of Messrs James Powell & Sons, Whitefriars Glass Works, London. Member of Committee of six appointed by Board of Education to prepare the scheme for the re-arrangement of the Art Collection of the Victoria and Albert Museum. Author of <i>Glass Making</i> ; &c.	}	Glass.
H. Lb.	HORACE LAMB, M.A., LL.D., D.Sc., F.R.S. Professor of Mathematics, University of Manchester. Formerly Fellow and Assistant Tutor of Trinity College, Cambridge. Member of Council of Royal Society, 1894-1896. Royal Medalist, 1902. President of London Mathematical Society, 1902-1904. Author of <i>Hydrodynamics</i> ; &c.	}	Harmonic Analysis.
H. L. H.	HARRIET L. HENNESSY, L.R.C.S.I., L.R.C.P.I., M.D. (Brux.)	}	Gynaecology.
H. M. C.	HECTOR MUNRO CHADWICK, M.A. Librarian and Fellow of Clare College, Cambridge. Author of <i>Studies on Anglo-Saxon Institutions</i> .	}	Goths: Gothic Language.
H. M. Wo.	HAROLD MELLOR WOODCOCK, D.Sc. Assistant to the Professor of Proto-Zoology, London University. Fellow of University College, London. Author of <i>Haemoflagellates</i> in Sir E. Ray Lankester's <i>Treatise of Zoology</i> , and of various scientific papers	}	Gregarines; Haemosporidia.
H. R.	HENRY REEVE, D.C.L. See the biographical article, REEVE, HENRY.	}	Gulzot (in part).
H. Sw.	HENRY SWEET, M.A., PH.D., LL.D. University Reader in Phonetics, Oxford. Member of the Academies of Munich, Berlin, Copenhagen and Helsingfors. Author of <i>A History of English Sounds since the Earliest Period; A Handbook of Phonetics</i> ; &c.	}	Grimm, J. L. G.; Grimm, Wilhelm Carl.
H. S.-K.	SIR HENRY SETON-KARR, C.M.G., M.A. M.P. for St. Helen's, 1885-1906. Author of <i>My Sporting Holidays</i> ; &c.	}	Gun.
H. W. C. D.	HENRY WILLIAM CARLESS DAVIS, M.A. Fellow and Tutor of Balliol College, Oxford. Fellow of All Souls College, Oxford, 1895-1902. Author of <i>England under the Normans and Angevins; Charlemagne</i> .	}	Gilbert, Foliot; Gloucester, Robert, Earl of; Grosseteste.
H. W. R.*	REV. HENRY WHEELER ROBINSON, M.A. Professor of Church History in Rawdon College, Leeds. Senior Kennicott Scholar, Oxford University, 1901. Author of <i>Hebrew Psychology in Relation to Pauline Anthropology</i> (in <i>Mansfield College Essays</i>); &c.	}	Habakkuk.
I. A.	ISRAEL ABRAHAMS, M.A. Reader in Talmudic and Rabbinic Literature, University of Cambridge. President, Jewish Historical Society of England. Author of <i>A Short History of Jewish Literature; Jewish Life in the Middle Ages</i> .	}	Graets; Haddala; Halakha; Halevi; Haptara; Harizl.
J. A. F. M.	JOHN ALEXANDER FULLER MAITLAND, M.A., F.S.A. Musical Critic of <i>The Times</i> . Author of <i>Life of Schumann; The Musician's Pilgrimage; Masters of German Music; English Music in the Nineteenth Century; The Age of Bach and Handel</i> . Editor of new edition of <i>Grove's Dictionary of Music</i> ; &c.	}	Grove, Sir George.
J. A. H.	JOHN ALLEN HOWE, B.Sc. Curator and Librarian of the Museum of Practical Geology, London. Author of <i>The Geology of Building Stones</i> .	}	Glacial Period; Greensand.
J. A. S.	JOHN ADDINGTON SYMONDS, LL.D. See the biographical article, SYMONDS, J. A.	}	Guarini.
J. Bl.	JAMES BLYTH, M.A., LL.D. Formerly Professor of Natural Philosophy, Glasgow and West of Scotland Technical College. Editor of <i>Ferguson's Electricity</i> .	}	Graduation.
J. Bl.	JAMES BARTLETT. Lecturer on Construction, Architecture, Sanitation, Quantities, &c., King's College, London. Member of Society of Architects, Institute of Junior Engineers, Quantity Surveyors' Association. Author of <i>Quantities</i> .	}	Glazing.
J. D. B.	JAMES DAVID BOURCHIER, M.A., F.R.G.S. King's College, Cambridge. Correspondent of <i>The Times</i> in South-Eastern Europe. Commander of the Orders of Prince Danilo of Montenegro and of the Saviour of Greece, and Officer of the Order of St Alexander of Bulgaria.	}	Greece: Geography and History: Modern; Greek Literature: III. Modern.
J. E. S.*	JOHN EDWIN SANDYS, M.A., LITT.D., LL.D. Public Orator in the University of Cambridge. Fellow of St John's College, Cambridge. Fellow of the British Academy. Author of <i>History of Classical Scholarship</i> ; &c.	}	Greek Law.
J. Fl.	JOHN FISKE. See the biographical article, FISKE, J.	}	Grant, Ulysses S.
J. G. C. A.	JOHN GEORGE CLARK ANDERSON, M.A. Censor and Tutor of Christ Church, Oxford. Formerly Fellow of Lincoln College. Craven Fellow (Oxford), 1896. Conington Prizeman, 1893.	}	Gordium.
J. G. R.	JOHN GEORGE ROBERTSON, M.A., PH.D. Professor of German Language and Literature, University of London. Author of <i>History of German Literature; Schiller after a Century</i> ; &c. Editor of the <i>Modern Language Journal</i> .	}	Goethe; Grillparzer.
J. H. F.	JOHN HENRY FREESE, M.A. Formerly Fellow of St John's College, Cambridge.	}	Graecus; Gratian; Hadrian (in part).

INITIALS AND HEADINGS OF ARTICLES

- J. H. H.** JOHN HENRY HESSELS, M.A.
Author of *Gutenberg: an Historical Investigation.* { Gloss; Gutenberg.
- J. H. P.** JOHN HENRY POYNTING, D.Sc., F.R.S.
Professor of Physics and Dean of the Faculty of Science in the University of Birmingham. Formerly Fellow of Trinity College, Cambridge. Joint-author of *Text-Book of Physics.* { Gravitation (*in part*).
- J. H. R.** JOHN HOLLAND ROSE, M.A., Litt.D.
Lecturer on Modern History to the Cambridge University Local Lectures Syndicate. Author of *Life of Napoleon I.*; *Napoleonic Studies*; *The Development of the European Nations*; *The Life of Pitt*; &c. { Gourgaud, Baron.
- J. L. W.** MISS JESSIE LADLAY WESTON.
Author of *Arthurian Romances unrepresented in Malory.* { Grail, The Holy; Guenevere.
- J. M. M.** JOHN MALCOLM MITCHELL.
Sometime Scholar of Queen's College, Oxford. Lecturer in Classics, East London College (University of London). Joint-editor of *Grote's History of Greece.* { Grote; Hamilton, Sir William, Bart. (*in part*); Harem.
- J. S. F.** JOHN SMITH FLETT, D.Sc., F.G.S.
Petrographer to the Geological Survey. Formerly Lecturer on Petrology in Edinburgh University. Neill Medallist of the Royal Society of Edinburgh. Bigsby Medallist of the Geological Society of London. { Glauconite; Gneiss; Granite; Granulite; Gravel; Greisen; Greywacke.
- J. T. Be.** JOHN T. BEALBY.
Joint author of *Stanford's Europe*. Formerly Editor of the *Scottish Geographical Magazine*. Translator of Sven Hedin's *Through Asia, Central Asia and Tibet*; &c. { Gobl.
- J. T. S.*** JAMES THOMSON SHOTWELL, Ph.D.
Professor of History in Columbia University, New York City. { Golden Rose (*in part*); Gollad; Guizot (*in part*).
- K. G. J.** KINGSLEY GARLAND JAYNE.
Sometime Scholar of Wadham College, Oxford. Matthew Arnold Prizeman, 1903. Author of *Vasco da Gama and his Successors.* { Goa.
- K. Kr.** KARL KRUMBACHER.
See the biographical article, KRUMBACHER, CARL. { Greek Literature: II. Byzantine.
- K. S.** MISS KATHLEEN SCHLESINGER.
Editor of the *Portfolio of Musical Archaeology*. Author of *The Instruments of the Orchestra*; &c. { Glockenspiel; Gong; Guitar; Guitar Fiddle; Gusla; Harmonica; Harmonichord; Harmonium (*in part*).
- L. D.*** LOUIS DUCHESNE.
See the biographical article, DUCHESNE, L. M. O. { Gregory: *Popes*, II.-VI.
- L. F. D.** LEWIS FOREMAN DAY, F.S.A. (1845-1909).
Formerly Vice-President of the Society of Arts. Past Master of the Art Workers' Guild. Author of *Windows, a book about Stained Glass*; &c. { Glass, Stained.
- L. F. V.-H.** LEVESON FRANCIS VERNON-HARCOURT, M.A., M.Inst.C.E. (1830-1907).
Formerly Professor of Civil Engineering at University College, London. Author of *Rivers and Canals*; *Harbours and Docks*; *Civil Engineering as applied in Construction*; &c. { Harbour.
- L. J. S.** LEONARD JAMES SPENCER, M.A.
Assistant in the Department of Mineralogy, British Museum. Formerly Scholar of Sidney Sussex College, Cambridge, and Harkness Scholar. Editor of the *Mineralogical Magazine*. { Goniometer; Gôthite; Graphite (*in part*); Greenockite.
- L. R. F.** LEWIS RICHARD FARNELL, M.A., Litt.D.
Fellow and Senior Tutor of Exeter College, Oxford; University Lecturer in Classical Archaeology; Wilde Lecturer in Comparative Religion. Author of *Cults of the Greek States*; *Evolution of Religion*. { Greek Religion.
- M.** LORD MACAULAY.
See the biographical article, MACAULAY, T. B. M., Baron. { Goldsmith, Oliver.
- M. G.** MOSES GASTER, Ph.D.
Chief Rabbi of the Sephardic Communities of England. Vice-President, Zionist Congress, 1898, 1899, 1900. Hchester Lecturer at Oxford on Slavonic and Byzantine Literature, 1886 and 1891. President, Folk-lore Society of England. Vice-President, Anglo-Jewish Association. Author of *History of Rumanian Popular Literature*; &c. { Gipsies.
- M. H. S.** MARION H. SPIELMANN, F.S.A.
Formerly Editor of the *Magazine of Art*. Member of Fine Art Committee of International Exhibitions of Brussels, Paris, Buenos Aires, Rome and the Franco-British Exhibition, London. Author of *History of "Punch"*; *British Portrait Painting to the opening of the Nineteenth Century*; *Works of G. F. Watts, R.A.*; *British Sculpture and Sculptors of To-day*; *Henriette Renner*; &c. { Gilbert, Alfred; Greenaway, Kate
- M. Ja.** MORRIS JASTROW, JUN., Ph.D.
Professor of Semitic Languages, University of Pennsylvania, U.S.A. Author of *Religion of the Babylonians and Assyrians*; &c. { Gilgamesh, Epic of; Gula.
- M. M.** MAX ARTHUR MACAULIFFE.
Formerly Divisional Judge in the Punjab. Author of *The Sikh Religion, its Gurus, Sacred Writings and Authors*; &c. Editor of *Life of Guru Nanak, in the Punjabi language.* { Granth.

INITIALS AND HEADINGS OF ARTICLES

XI

M. H. T.	<p>MARCUS NIEBUHR TOD, M.A. Fellow and Tutor of Oriel College, Oxford. University Lecturer in Epigraphy. Joint-author of <i>Catalogue of the Sparta Museum</i></p>	<p>{ Gythium.</p>
M. O. B. C.	<p>MAXIMILIAN OTTO BISMARCK CASPARY, M.A. Reader in Ancient History at London University. Lecturer in Greek at Birmingham University, 1905-1908.</p>	<p>{ Greece: History: <i>146 B.C. 1800 A.D.</i>; Hamlicar Barca; Hannibal.</p>
M. P.	<p>MARK PATTISON. See the biographical article, PATTISON, MARK.</p>	<p>{ Grotius.</p>
M. P. ^o	<p>LEON JACQUES MAXIME PRINET. Formerly Archivist to the French National Archives. Auxiliary of the Institute of France (Academy of Moral and Political Sciences).</p>	<p>{ Gouffier; Harcourt.</p>
O. Ba.	<p>OSWALD BARRON, F.S.A. Editor of <i>The Ancestor</i>, 1902-1905. Hon. Genealogist to Standing Council of the Honourable Society of the Baronetage.</p>	<p>{ Girdle.</p>
P. A.	<p>PAUL DANIEL ALPHANDÉRY. Professor of the History of Dogma, École Pratique des Hautes Études, Sorbonne, Paris. Author of <i>Les Idées morales chez les hétérodoxes latines au début du XII^e siècle.</i></p>	<p>{ Gonzalo de Berceo.</p>
P. A. A.	<p>PHILIP A. ASHWORTH, M.A., DOC. JURIS. New College, Oxford. Barrister-at-Law. Translator of H. R. von Gneist's <i>History of the English Constitution.</i></p>	<p>{ Gneist.</p>
P. C. Y.	<p>PHILIP CHESNEY YORKE, M.A. Magdalen College, Oxford.</p>	<p>{ Gunpowder Plot; Halifax, 1st Marquess of; Hamilton, 1st Duke of.</p>
P. G.	<p>PERCY GARDNER, M.A. See the biographical article, GARDNER, PERCY.</p>	<p>{ Greek Art.</p>
P. GL.	<p>PETER GILES, M.A., LL.D., LITT.D. Fellow and Classical Lecturer of Emmanuel College, Cambridge, and University Reader in Comparative Philology. Formerly Secretary of the Cambridge Philological Society. Author of <i>Manual of Comparative Philology.</i></p>	<p>{ Greek Language; H.</p>
P. G. K.	<p>PAUL GEORGE KONODY. Art Critic of the <i>Observer</i> and the <i>Daily Mail</i>. Formerly Editor of <i>The Artist</i>. Author of <i>The Art of Walter Crane; Velasquez, Life and Work; &c.</i></p>	<p>{ Hals, Frans.</p>
P. G. T.	<p>PETER GUTHRIE TAIT, LL.D. See the biographical article, TAIT, PETER GUTHRIE.</p>	<p>{ Hamilton, Sir William Rowan.</p>
P. La.	<p>PHILIP LAKE, M.A., F.G.S. Lecturer on Physical and Regional Geography in Cambridge University. Formerly of the Geological Survey of India. Author of <i>Monograph of British Cambrian Trilobites</i>. Translator and Editor of Kayser's <i>Comparative Geology</i>.</p>	<p>{ Greece: Geology.</p>
P. McC.	<p>PRIMROSE MCCONNELL, F.G.S. Member of the Royal Agricultural Society. Author of <i>Diary of a Working Farmer; &c.</i></p>	<p>{ Grass and Grassland.</p>
R. A. W.	<p>COLONEL ROBERT ALEXANDER WAHAB, C.B., C.M.G., C.I.E. Formerly H. M. Commissioner, Aden Boundary Delimitation. Served with Tirah Expeditionary Force, 1897-1898, and on the Anglo-Russian Boundary Commission, Pamirs, 1895.</p>	<p>{ Hadramut.</p>
R. A. S. M.	<p>ROBERT ALEXANDER STEWART MACALISTER, M.A., F.S.A. St John's College, Cambridge. Director of Excavations for the Palestine Exploration Fund.</p>	<p>{ Gilead; Gilgal; Goshen.</p>
R. C. J.	<p>SIR RICHARD CLAVERHOUSE JEBB, LL.D., D.C.L. See the biographical article, JEBB, SIR R. C.</p>	<p>{ Greek Literature: I. Ancient.</p>
R. J. M.	<p>RONALD JOHN MCNEILL, M.A. Christ Church, Oxford. Barrister-at-Law. Formerly Editor of the <i>St James's Gazette</i>, London.</p>	<p>{ Gowrie, 3rd Earl of; Gratton, Henry; Green Ribbon Club; Gymnastics; Harcourt, 1st Viscount; Hardwicke, 1st Earl of.</p>
R. L. ^o	<p>RICHARD LYDEKKER, M.A., F.R.S., F.G.S., F.Z.S. Member of the Staff of the Geological Survey of India, 1874-1882. Author of <i>Catalogues of Fossil Mammals, Reptiles and Birds in British Museum; The Deer of all Lands; The Game Animals of Africa; &c.</i></p>	<p>{ Giraffe; Glutton; Glyptodon; Goat; Gorilla; Hamster; Hare.</p>
R. N. B.	<p>ROBERT NIBBET BAIN (d. 1909). Assistant Librarian, British Museum, 1883-1909. Author of <i>Scandinavia, the Political History of Denmark, Norway and Sweden, 1513-1900; The First Romanovs, 1613-1725; Slavonic Europe, the Political History of Poland and Russia from 1469 to 1769; &c.</i></p>	<p>{ Golitsuin, Boris, Dmitry, and Vasily; Golevin, Count; Golovkin, Count; Görts, Baron von; Griffenfeldt, Count; Gustavus I., and IV. Gyllenstjerna; Hall, C. C.</p>
R. S. T.	<p>RALPH STOCKMAN TARR. Professor of Physical Geography, Cornell University.</p>	<p>{ Grand Canyon.</p>

INITIALS AND HEADINGS OF ARTICLES

- R. We.** RICHARD WEBSTER, A.M. (Princeton).
Formerly Fellow in Classics, Princeton University. Editor of *The Elegies of Maximianus*; &c. { Great Awakening.
- S. A. C.** STANLEY ARTHUR COOK, M.A.
Editor for Palestine Exploration Fund. Lecturer in Hebrew and Syriac, and formerly Fellow, Gonville and Caius College, Cambridge. Examiner in Hebrew and Aramaic, London University, 1906-1908. Author of *Glossary of Aramaic Inscriptions*; *The Laws of Moses and the Code of Hammurabi*; *Critical Notes on Old Testament History*; *Religion of Ancient Palestine*; &c. { Gideon.
- S. Bl.** SIGFUS BLÖNDAL.
Librarian of the University of Copenhagen. { Hallgrímsson.
- S. C.** SIDNEY COLVIN, LL.D.
See the biographical article, COLVIN, SIDNEY. { Giorgione; Giotto.
- St. C.** VISCOUNT ST. CYRES.
See the biographical article, IDDESLEIGH, 1ST EARL OF. { Guyon, Madame.
- S. N.** SIMON NEWCOMB, LL.D., D.Sc.
See the biographical article, NEWCOMB, SIMON. { Gravitation (*in part*).
- T. As.** THOMAS ASHBY, M.A., D.LITT., F.S.A.
Director of the British School of Archaeology at Rome. Corresponding Member of the Imperial German Archaeological Institute. Formerly Scholar of Christ Church, Oxford. Craven Fellow, Oxford, 1897. Author of *The Classical Topography of the Roman Campagna*; &c. { Gigenti; Gnatic; Grottaferrata; Grumentum; Gubbio; Hadria; Halaeusa.
- T. A. J.** THOMAS ATHOL JOYCE, M.A.
Assistant in Department of Ethnography, British Museum. Hon. Sec., Royal Anthropological Institute. { Hamitic Races (I).
- T. Ba.** SIR THOMAS BARCLAY, M.P.
Member of the Institute of International Law. Member of the Supreme Council of the Congo Free State. Officer of the Legion of Honour. Author of *Problems of International Practice and Diplomacy*; &c. M.P. for Blackburn, 1910. { Guerrilla.
- T. E. H.** THOMAS ERSKINE HOLLAND, K.C., D.C.L., LL.D.
Fellow of the British Academy. Fellow of All Souls College, Oxford. Professor of International Law in the University of Oxford, 1874-1910. Bencher of Lincoln's Inn. Author of *Studies in International Law*; *The Elements of Jurisprudence*; *Alberti Gentilis de jure belli*; *The Laws of War on Land*; *Neutral Duties in a Maritime War*; &c. { Hall, William E.
- T. F. C.** THEODORE FREYLINGHUYSEN COLLIER, PH.D.
Assistant Professor of History, Williams College, Williamstown, Mass., U.S.A. { Gregory: Popes, XIII.—XV.
- T. H. H.*** SIR THOMAS HUNGERFORD HOLDICH, K.C.M.G., K.C.I.E., D.Sc., F.R.G.S.
Colonel in the Royal Engineers. Superintendent Frontier Surveys, India, 1892-1898. Gold Medallist, R.G.S. (London), 1887. H.M. Commissioner for the Persa-Beluch Boundary, 1896. Author of *The Indian Borderland*; *The Gates of India*; &c. { Gligit; Hart-Rud.
- T. K.** THOMAS KIRKUP, M.A., LL.D.
Author of *An Inquiry into Socialism*; *Primer of Socialism*; &c. { Hadrian (*in part*).
- T. Se.** THOMAS SECCOMBE, M.A.
Lecturer in History, East London and Birkbeck Colleges, University of London. Stanhope Prizeman, Oxford, 1887. Formerly Assistant Editor of *Dictionary of National Biography*, 1891-1901. Author of *The Age of Johnson*; &c.; Joint-author of *The Bookman's History of English Literature*. { Gilbert, Sir W. S.
- V. H. S.** REV. VINCENT HENRY STANTON, M.A., D.D.
Ely Professor of Divinity in the University of Cambridge. Canon of Ely and Fellow of Trinity College, Cambridge. Author of *The Gospels as Historical Documents*; *The Jewish and the Christian Messiahs*; &c. { Gospel.
- W. A. B. C.** REV. WILLIAM AUGUSTUS BREVOORT COOLIDGE, M.A., F.R.G.S., PH.D. (Bern).
Fellow of Magdalen College, Oxford. Professor of English History, St David's College, Lampeter, 1880-1881. Author of *Guide du Haut Dauphin*; *The Range of the Tâbi*; *Guide to Grindelwald*; *Guide to Switzerland*; *The Alps in Nature and in History*; &c. Editor of *The Alpine Journal*, 1880-1889; &c. { Glarus; Goldast Ab Halminsfeld; Grasse; Grenoble; Grindelwald; Grisons; Gruner, G. S.; Gruyère.
- W. A. P.** WALTER ALIBON PHILLIPS, M.A.
Formerly Exhibitioner of Merton College and Senior Scholar of St John's College, Oxford. Author of *Modern Europe*; &c. { Girondists; Goethe: Descendants of; Greek Independence, War of.
- W. Bo.** WILHELM BOUSSET, D.Th.
Professor of New Testament Exegesis in the University of Göttingen. Author of *Das Wesen der Religion*; *The Antichrist Legend*; &c. { Gnosticism.
- W. Bu.** WILLIAM BURNSIDE, M.A., D.Sc., LL.D., F.R.S.
Professor of Mathematics, Royal Naval College, Greenwich. Hon. Fellow of Pembroke College, Cambridge. Author of *The Theory of Groups of Finite Order*. { Groups, Theory of.
- W. F. C.** WILLIAM FELDEN CRAIES, M.A.
Barrister-at-Law, Inner Temple. Lecturer on Criminal Law, King's College, London. Author of *Craies on Statute Law*. Editor of Archbold's *Criminal Pleading* (23rd edition). { Habeas Corpus; Hanging.
- W. G. H.** WALTER GEORGE McMILLAN, F.C.S., M.I.M.E. (d. 1904).
Formerly Secretary of the Institute of Electrical Engineers and Lecturer on Metallurgy, Mason College, Birmingham. Author of *A Treatise on Electro-Metallurgy*. { Graphite (*in part*).

INITIALS AND HEADINGS OF ARTICLES

xiii

W. Hn.	REV. WILLIAM HUNT, M.A., Litt.D. President of Royal Historical Society, 1905-1909. Author of <i>History of English Church, 597-1906</i> ; <i>The Church of England in the Middle Ages</i> ; <i>Political History of England 1760-1801</i> .	}	Green J. R.
W. H. Be.	WILLIAM HENRY BENNETT, M.A., D.D., D.Litt. (CANTAB.). Professor of Old Testament Exegesis in New and Hackney Colleges, London. Formerly Fellow of St John's College, Cambridge. Lecturer in Hebrew at Firth College, Sheffield. Author of <i>Religion of the Post-Exilic Prophets</i> ; &c.	}	Gomer; Ham.
W. H. F.*	WILLIAM HENRY FAIRBROTHER, M.A., Formerly Fellow and Lecturer, Lincoln College, Oxford. Author of <i>Philosophy of Thomas Hill Green</i> .	}	Green, Thomas Hill.
W. J. F.	WILLIAM JUSTICE FORD (d. 1904). Formerly Scholar of St John's College, Cambridge. Headmaster of Leamington College.	}	Grace, W. G.
W. McD.	WILLIAM MCDUGALL, M.A. Reader in Mental Philosophy in the University of Oxford. Author of <i>A Primer of Physiological Psychology</i> ; <i>An Introduction to Social Psychology</i> ; &c.	}	Hallucination.
W. M. M.	W. MAX MÜLLER, Ph.D. Professor of Exegesis in the R.E. Seminary, Philadelphia. Author of <i>Asien und Europa nach den Aegyptischen Denkmälern</i> ; &c.	}	Hamitic Races: Il. Languages.
W. M. R.	WILLIAM MICHAEL ROSSETTI. See the biographical article, ROSSETTI, DANTE G.	}	Giulio Romano; Gossoli; Guido Reni.
W. P. A	LIEUT.-COLONEL WILLIAM PATRICK ANDERSON, M.Inst C.E., F.R.G.S. Chief Engineer, Department of Marine and Fisheries of Canada. Member of the Geographic Board of Canada. Past President of Canadian Society of Civil Engineers.	}	Great Lakes.
W. P. R.	HON. WILLIAM PEMBER REEVES. Director of London School of Economics. Agent-General and High Commissioner for New Zealand, 1896-1909. Minister of Education, Labour and Justice, New Zealand, 1891-1896. Author of <i>The Long White Cloud: a History of New Zealand</i> ; &c.	}	Grey, Sir George.
W. R.	WHITELAW REID, LL.D. See the biographical article, REID, WHITELAW.	}	Greeley, Horace.
W. RL	WILLIAM RIDGEWAY, M.A., D.Sc. Professor of Archaeology, Cambridge University, and Brereton Reader in Classics. Fellow of Gonville and Caius College, Cambridge. Fellow of the British Academy. President of Royal Anthropological Institute, 1908. President of Anthropological Section, British Association, 1908. Author of <i>The Early Age of Greece</i> ; &c.	}	Hallstatt.
W. Rn.	W. ROSENHAIN, D.Sc. Superintendent of the Metallurgical Department, National Physical Laboratory	}	Glass (in part).
W. R. D.	WYNDHAM ROWLAND DUNSTAN, M.A., LL.D., F.R.S., F.C.S. Director of the Imperial Institute. President of the International Association of Tropical Agriculture. Member of the Advisory Committee for Tropical Agriculture, Colonial Office.	}	Gutta-Percha.
W. R. E. H.	WILLIAM RICHARD EATON HODGKINSON, Ph.D., F.R.S. (EDIN.), F.C.S. Professor of Chemistry and Physics, Ordnance College, Woolwich. Formerly Professor of Chemistry and Physics, R.M.A., Woolwich. Part-author of Valentin-Hodgkinson's <i>Practical Chemistry</i> ; &c.	}	Gun Cotton; Gunpowder.
W. R. S.	WILLIAM ROBERTSON SMITH, LL.D. See the biographical article, SMITH, WILLIAM ROBERTSON.	}	Haggai (in part).
W. R. S. R.	WILLIAM RALSTON SHEDDEN-RALSTON, M.A. Assistant in the Department of Printed Books, British Museum. Author of <i>Russian Folk Tales</i> ; &c.	}	Gogol.
W. W. R.*	WILLIAM WALKER ROCKWELL, Lic.Theol. Assistant Professor of Church History, Union Theological Seminary, New York.	}	Gregory XVI.

PRINCIPAL UNSIGNED ARTICLES

Gilding.
Ginger.
Gironde.
Gladiators.
Glasgow.
Glastonbury.
Gloucestershire.
Glove.
Gluconic.
Gluo.
Glycerin.

Goat.
Gold.
Goldbeating.
Golland.
Gourd.
Government.
Grain Trade.
Granada.
Grasses.
Great Salt Lake.

Griqualand East and West.
Guanches.
Guards.
Guatemala.
Guelphs and Ghibellines.
Gulaeum.
Guilotine.
Gulse, House of
Gum.

Gwallor.
Haddingtonshire.
Hair.
Haiti.
Halo.
Hamburg.
Hamlet.
Hampshire.
Hampton Roads.
Hanover.

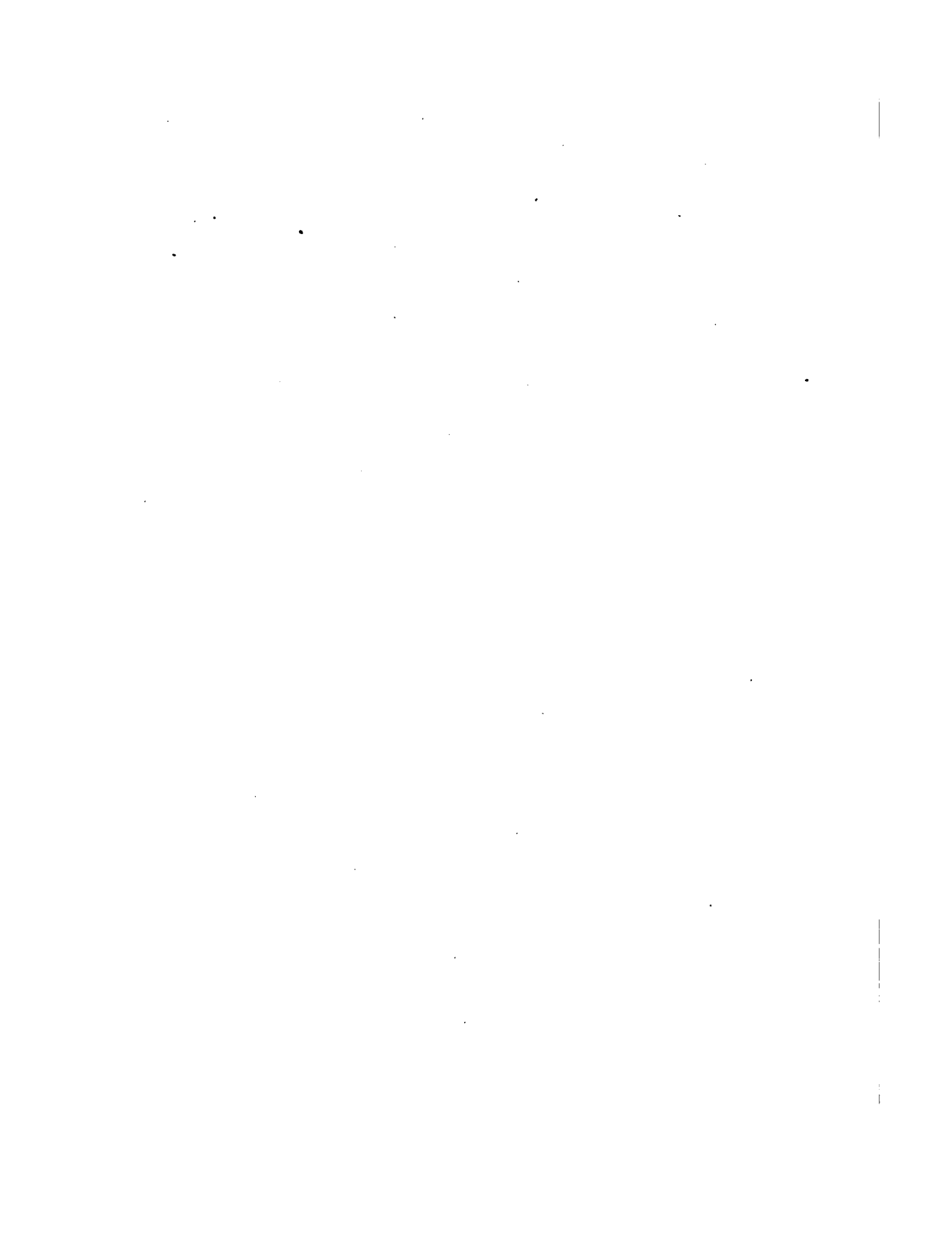

ENCYCLOPÆDIA BRITANNICA

ELEVENTH EDITION

VOLUME XII

GICHTEL, JOHANN GEORG (1638-1710), German mystic, was born at Regensburg, where his father was a member of senate, on the 14th of March 1638. Having acquired at school an acquaintance with Greek, Hebrew, Syriac and even Arabic, he proceeded to Strassburg to study theology; but finding the theological prelections of J. S. Schmidt and P. J. Spener distasteful, he entered the faculty of law. He was admitted an advocate, first at Spires, and then at Regensburg; but having become acquainted with the baron Justinianus von Weltz (1621-1668), a Hungarian nobleman who cherished schemes for the reunion of Christendom and the conversion of the world, and having himself become acquainted with another world in dreams and visions, he abandoned all interest in his profession, and became an energetic promoter of the "*Christenbauliche Jesusgesellschaft*," or Christian Edification Society of Jesus. The movement in its beginnings provoked at least no active hostility; but when Gichtel began to attack the teaching of the Lutheran clergy and church, especially upon the fundamental doctrine of justification by faith, he exposed himself to a prosecution which resulted in sentence of banishment and confiscation (1665). After many months of wandering and occasionally romantic adventure, he reached Holland in January 1667, and settled at Zwolle, where he co-operated with Friedrich Breckling (1629-1711), who shared his views and aspirations. Having become involved in the troubles of this friend, Gichtel, after a period of imprisonment, was banished for a term of years from Zwolle, but finally in 1668 found a home in Amsterdam, where he made the acquaintance of Antoinette Bourignon (1616-1680), and in a state of poverty (which, however, never became destitution) lived out his strange life of visions and day-dreams, of prophecy and prayer. He became an ardent disciple of Jakob Boehme, whose works he published in 1682 (Amsterdam, 2 vols.); but before the time of his death, on the 21st of January 1710, he had attracted to himself a small band of followers known as Gichtelians or Brethren of the Angels, who propagated certain views at which he had arrived independently of Boehme. Seeking ever to hear the authoritative voice of God within them, and endeavouring to attain to a life altogether free from carnal desires, like that of "the angels in heaven, who neither marry nor are given in marriage," they claimed to exercise a priesthood "after the order of Melchizedek," appeasing the wrath of God, and ransoming the souls of the lost by sufferings endured vicariously after the example of Christ. While, however, Boehme "desired to remain a faithful son of the Church," the

Gichtelians became Separatists (cf. J. A. Dorner, *History of Protestant Theology*, ii. p. 185).

Gichtel's correspondence was published without his knowledge by Gottfried Arnold, a disciple, in 1701 (2 vols.), and again in 1708 (3 vols.). It has been frequently reprinted under the title *Theosophia practica*. The seventh volume of the Berlin edition (1768) contains a notice of Gichtel's life. See also G. C. A. von Harless, *Jakob Böhme und die Alchimisten* (1870, 2nd ed. 1882); article in *Allgemeine deutsche Biographie*.

GIDDINGS, JOSHUA REED (1795-1864), American statesman, prominent in the anti-slavery conflict, was born at Tioga Point, now Athens, Bradford county, Pennsylvania, on the 6th of October 1795. In 1806 his parents removed to Ashtabula county, Ohio, then sparsely settled and almost a wilderness. The son worked on his father's farm, and, though he received no systematic education, devoted much time to study and reading. For several years after 1814 he was a school teacher, but in February 1821 he was admitted to the Ohio bar and soon obtained a large practice, particularly in criminal cases. From 1831 to 1837 he was in partnership with Benjamin F. Wade. He served in the lower house of the state legislature in 1826-1828, and from December 1838 until March 1859 was a member of the national House of Representatives, first as a Whig, then as a Free-soiler, and finally as a Republican. Recognizing that slavery was a state institution, with which the Federal government had no authority to interfere, he contended that slavery could only exist by a specific state enactment, that therefore slavery in the District of Columbia and in the Territories was unlawful and should be abolished, that the coastwise slave-trade in vessels flying the national flag, like the international slave-trade, should be rigidly suppressed, and that Congress had no power to pass any act which in any way could be construed as a recognition of slavery as a national institution. His attitude in the so-called "Creole Case" attracted particular attention. In 1841 some slaves who were being carried in the brig "Creole" from Hampton Roads, Virginia, to New Orleans, revolted, killed the captain, gained possession of the vessel, and soon afterwards entered the British port of Nassau. Thereupon, according to British law, they became free. The minority who had taken an active part in the revolt were arrested on a charge of murder, and the others were liberated. Efforts were made by the United States government to recover the slaves, Daniel Webster, then secretary of state, asserting that on an American ship they were under the jurisdiction of the United States and that they were legally property. On the 21st of March 1842, before the case

was settled, Giddings introduced in the House of Representatives a series of resolutions, in which he asserted that "in resuming their natural rights of personal liberty" the slaves "violated no law of the United States." For offering these resolutions Giddings was attacked with rancour, and was formally censured by the House. Thereupon he resigned, appealed to his constituents, and was immediately re-elected by a large majority. In 1859 he was not renominated, and retired from Congress after a continuous service of more than twenty years. From 1861 until his death, at Montreal, on the 27th of May 1864, he was U.S. consul-general in Canada. Giddings published a series of political essays signed "Pacificus" (1843); *Speeches in Congress* (1853); *The Exiles of Florida* (1858); and a *History of the Rebellion: Its Authors and Causes* (1864).

See *The Life of Joshua R. Giddings* (Chicago, 1892), by his son-in-law, George Washington Julian (1817-1899), a Free-soil leader and a representative in Congress in 1849-1851, a Republican representative in Congress in 1861-1871, a Liberal Republican in the campaign of 1872, and afterwards a Democrat.

GIDEON (in Hebrew, perhaps "מַעֲרָה" or "warrior"), liberator, reformer and "judge" of Israel, was the son of Joash, of the Manasseh clan of Abiezer, and had his home at Ophrah near Shechem. His name occurs in Heb. xi. 32, in a list of those who became heroes by faith; but, except in Judges vi.-viii., is not to be met with elsewhere in the Old Testament. He lived at a time when the nomad tribes of the south and east made inroads upon Israel, destroying all that they could not carry away. Two accounts of his deeds are preserved (see **JUDGES**). According to one (Judges vi. 11-24) Yahweh appeared under the holy tree which was in the possession of Joash and summoned Gideon to undertake, in dependence on supernatural direction and help, the work of liberating his country from its long oppression, and, in token that he accepted the mission, he erected in Ophrah an altar which he called "Yahweh-Shalom" (Yahweh is peace). According to another account (vi. 25-32) Gideon was a great reformer who was commanded by Yahweh to destroy the altar of Baal belonging to his father and the *asherah* or sacred post by its side. The townsmen discovered the sacrilege and demanded his death. His father, who, as guardian of the sacred place, was priest of Baal, enjoined the men not to take up Baal's quarrel, for "if Baal be a god, let him contend (*rib*) for himself." Hence Gideon received the name Jerubbaal.¹ From this latter name appearing regularly in the older narrative (cf. ix.), and from the varying usage in vi.-viii., it has been held that stories of two distinct heroes (Gideon and Jerubbaal) have been fused in the complicated account which follows.²

The great gathering of the Midianites and their allies on the north side of the plain of Jezreel; the general muster first of Abiezer, then of all Manasseh, and lastly of the neighbouring tribes of Asher, Zebulun and Naphtali; the signs by which the wavering faith of Gideon was steadied; the methods by which an unwieldy mob was reduced to a small but trusty band of energetic and determined men; and the stratagem by which the vast army of Midian was surprised and routed by the handful of Israelites descending from "above Endor," are indicated fully in the narratives, and need not be detailed here. The difficulties in the account of the subsequent flight of the Midianites appear to have arisen from the composite character of the narratives, and there are signs that in one of them Gideon was accompanied only by his own clansmen (vi. 34). So, when the Midianites are put to flight, according to one representation, the Ephraimites are called out to intercept them, and the two chiefs, Oreb ("raven") and Zeeb ("wolf"), in making for the fords of the Jordan, are slain at "the raven's rock" and "the wolf's press" respectively. As the sequel of this we are told that the Ephraimites quarrelled with Gideon because their assistance had not been invoked earlier, and their anger was "Baal contends" (or Jeru-baal, "Baal founds," cf. Jeru-el), but artificially explained in the narrative to mean "let Baal contend against him" or "let Baal contend for himself," v. 31. In 2 Sam. xi. 21 he is called Jerubbesheth, in accordance with the custom explained in the article **BAAL**.

¹ See, on this, Cheyne, *Ency. Bib.* col. 1719 seq.; Ed. Meyer, *Die Israeliten*, pp. 482 seq.

only appeased by his tactful reply (viii. 1-3; contrast xii. 1-6). The other narrative speaks of the pursuit of the Midianite chiefs Zebah and Zalmunna³ across the northern end of Jordan, past Succoth and Penuel to the unidentified place Karkor. Having taken relentless vengeance on the men of Penuel and Succoth, who had shown a timid neutrality when the patriotic struggle was at its crisis, Gideon puts the two chiefs to death to avenge his brothers whom they had killed at Tabor.⁴ The overthrow of Midian (cf. Is. ix. 4, x. 26; Ps. lxxxiii. 9-12) induced "Israel" to offer Gideon the kingdom. It was refused—out of religious scruples (viii. 22 seq.; cf. 1 Sam. viii. 7, x. 19, xii. 12, 17, 19), and the ephod idol which he set up, at Ophrah in commemoration of the victory was regarded by a later editor (v. 27) as a cause of apostasy to the people and a snare to Gideon and his house; see, however, **EPHOD**. Gideon's achievements would naturally give him a more than merely local authority, and after his death the attempt was made by one of his sons to set himself up as chief (see **ABIMELECH**).

See further **JWS**, section 1; and the literature to the book of Judges. (S. A. C.)

GIEBEL, CHRISTOPH GOTTFRIED ANDREAS (1820-1881), German zoologist and palaentologist, was born on the 13th of September 1820 at Quedlinburg in Saxony, and educated at the university of Halle, where he graduated Ph. D. in 1845. In 1858 he became professor of zoology and director of the museum in the university of Halle. He died at Halle on the 14th of November 1881. His chief publications were *Palaentologie* (1846); *Fauna der Vorwelt* (1847-1856); *Deutschlands Petrefacten* (1852); *Odonographie* (1855); *Lehrbuch der Zoologie* (1857); *Thesaurus ornithologiae* (1872-1877).

GIEN, a town of central France, capital of an arrondissement in the department of Loiret, situated on the right bank of the Loire, 39 m. E.S.E. of Orleans by rail. Pop. (1906) 6325. Gien is a picturesque and interesting town and has many curious old houses. The Loire is here crossed by a stone bridge of twelve arches, built by Anne de Beaujeu, daughter of Louis XI., about the end of the 15th century. Near it stands a statue of Vercingetorix. The principal building is the old castle used as a law-court, constructed of brick and stone arranged in geometrical patterns, and built in 1494 by Anne de Beaujeu. The church of St Pierre possesses a square tower dating from the end of the 15th century. Porcelain is manufactured.

GIERS, NICHOLAS KARLOVICH DE (1820-1895), Russian statesman, was born on the 21st of May 1820. Like his predecessor, Prince Gorchakov, he was educated at the lyceum of Tsarskoye Selo, near St Petersburg, but his career was much less rapid, because he had no influential protectors, and was handicapped by being a Protestant of Teutonic origin. At the age of eighteen he entered the service of the Eastern department of the ministry of foreign affairs, and spent more than twenty years in subordinate posts, chiefly in south-eastern Europe, until he was promoted in 1863 to the post of minister plenipotentiary in Persia. Here he remained for six years, and, after serving as a minister in Switzerland and Sweden, he was appointed in 1875 director of the Eastern department and assistant minister for foreign affairs under Prince Gorchakov, whose niece he had married. No sooner had he entered on his new duties than his great capacity for arduous work was put to a severe test. Besides events in central Asia, to which he had to devote much attention, the Herzegovinian insurrection had broken out, and he could perceive from secret official papers that the incident had far-reaching ramifications unknown to the general public. Soon this became apparent to all the world. While the Austrian officials in Dalmatia, with hardly a pretence of concealment, were assisting the insurgents, Russian volunteers were flocking to Servia with the connivance of the Russian and Austrian governments, and General Ignatiev, as ambassador in

³ The names are vocalized to suggest the fanciful interpretations "victim" and "protection withheld."

⁴ As the account of this has been lost and the narrative is concerned not with the plain of Jezreel but rather with Shechem, it has been inferred that the episode implies the existence of a distinct story wherein Gideon's pursuit is such an act of vengeance.

Constantinople, was urging his government to take advantage of the palpable weakness of Turkey for bringing about a radical solution of the Eastern question. Prince Gorchakov did not want a radical solution involving a great European war, but he was too fond of ephemeral popularity to stem the current of popular excitement. Alexander II., personally averse from war, was not insensible to the patriotic enthusiasm, and halted between two opinions. M. de Giers was one of the few who gauged the situation accurately. As an official and a man of non-Russian extraction he had to be extremely reticent, but to his intimate friends he condemned severely the ignorance and light-hearted recklessness of those around him. The event justified his sombre provisions, but did not cure the recklessness of the so-called patriots. They wished to defy Europe in order to maintain intact the treaty of San Stefano, and again M. de Giers found himself in an unpopular minority. He had to remain in the background, but all the influence he possessed was thrown into the scale of peace. His views, energetically supported by Count Shuvalov, finally prevailed, and the European congress assembled at Berlin. He was not present at the congress, and consequently escaped the popular odium for the concessions which Russia had to make to Great Britain and Austria. From that time he was practically minister of foreign affairs, for Prince Gorchakov was no longer capable of continued intellectual exertion, and lived mostly abroad. On the death of Alexander II. in 1881 it was generally expected that M. de Giers would be dismissed as deficient in Russian nationalist feeling, for Alexander III. was credited with strong anti-German Slavophil tendencies. In reality the young tsar had no intention of embarking on wild political adventures, and was fully determined not to let his hand be forced by men less cautious than himself. What he wanted was a minister of foreign affairs who would be at once vigilant and prudent, active and obedient, and who would relieve him from the trouble and worry of routine work while allowing him to control the main lines, and occasionally the details, of the national policy. M. de Giers was exactly what he wanted, and accordingly the tsar not only appointed him minister of foreign affairs on the retirement of Prince Gorchakov in 1882, but retained him to the end of his reign in 1894. In accordance with the desire of his august master, M. de Giers followed systematically a pacific policy. Accepting as a *fait accompli* the existence of the triple alliance, created by Bismarck for the purpose of resisting any aggressive action on the part of Russia and France, he sought to establish more friendly relations with the cabinets of Berlin, Vienna and Rome. To the advances of the French government he at first turned a deaf ear, but when the *rapprochement* between the two countries was effected with little or no co-operation on his part, he utilized it for restraining France and promoting Russian interests. He died on the 26th of January 1895, soon after the accession of Nicholas II. (D. M. W.)

GIESEBRECHT, WILHELM VON (1814-1880), German historian, was a son of Karl Giesebrecht (d. 1832), and a nephew of the poet Ludwig Giesebrecht (1792-1873). Born in Berlin on the 5th of March 1814, he studied under Leopold von Ranke, and his first important work, *Geschichte Ottos II.*, was contributed to Ranke's *Jahrbücher des deutschen Reichs unter dem sächsischen Hause* (Berlin, 1837-1840). In 1841 he published his *Jahrbücher des Klosters Altaich*, a reconstruction of the lost *Annales Altaichenses*, a medieval source of which fragments only were known to be extant, and these were obscured in other chronicles. The brilliance of this performance was shown in 1867, when a copy of the original chronicle was found, and it was seen that Giesebrecht's text was substantially correct. In the meantime he had been appointed *Oberlehrer* in the Joachimsthaler Gymnasium in Berlin; had paid a visit to Italy, and as a result of his researches there had published *De litterarum studiis apud Italos primis mediæ ævi seculis* (Berlin, 1845), a study upon the survival of culture in Italian cities during the middle ages, and also several critical essays upon the sources for the early history of the popes. In 1851 appeared his translation of the *Historiae* of Gregory of Tours, which is the standard German translation. Four years later appeared the first volume of his great work,

Geschichte der deutschen Kaiserzeit, the fifth volume of which was published in 1888. This work was the first in which the results of the scientific methods of research were thrown open to the world at large. Largeness of style and brilliance of portrayal were joined to an absolute mastery of the sources in a way hitherto unachieved by any German historian. Yet later German historians have severely criticized his glorification of the imperial era with its Italian entanglements, in which the interests of Germany were sacrificed for idle glory. Giesebrecht's history, however, appeared when the new German empire was in the making, and became popular owing both to its patriotic tone and its intrinsic merits. In 1857 he went to Königsberg as professor ordinarius, and in 1862 succeeded H. von Sybel as professor of history in the university of Munich. The Bavarian government honoured him in various ways, and he died at Munich on the 17th of December 1880. In addition to the works already mentioned, Giesebrecht published a good monograph on Arnold of Brescia (Munich, 1873), a collection of essays under the title *Deutsche Reden* (Munich, 1871), and was an active member of the group of scholars who took over the direction of the *Monumenta Germaniae historica* in 1875. In 1895 B. von Simson added a sixth volume to the *Geschichte der deutschen Kaiserzeit*, thus bringing the work down to the death of the emperor Frederick I. in 1190.

See S. Riezler, *Gedächtnisrede auf Wilhelm von Giesebrecht* (Munich, 1891); and Lord Acton in the *English Historical Review*, vol. v. (London, 1890).

GIESELER, JOHANN KARL LUDWIG (1792-1854), German writer on church history, was born on the 3rd of March 1792 at Petershagen, near Minden, where his father, Georg Christof Friedrich, was preacher. In his tenth year he entered the orphanage at Halle, whence he duly passed to the university, his studies being interrupted, however, from October 1813 till the peace of 1815 by a period of military service, during which he was enrolled as a volunteer in a regiment of chasseurs. On the conclusion of peace (1815) he returned to Halle, and, having in 1817 taken his degree in philosophy, he in the same year became assistant head master (*Conrector*) in the Minden gymnasium, and in 1818 was appointed director of the gymnasium at Cleves. Here he published his earliest work (*Historisch-kritischer Versuch über die Entstehung u. die frühesten Schicksale der schriftlichen Evangelien*), a treatise which had considerable influence on subsequent investigations as to the origin of the gospels. In 1819 Gieseler was appointed a professor ordinarius in theology in the newly founded university of Bonn, where, besides lecturing on church history, he made important contributions to the literature of that subject in Ernst Rosenmüller's *Repertorium*, K. F. Staudlin and H. G. Tschirner's *Archiv*, and in various university "programs." The first part of the first volume of his well-known *Church History* appeared in 1824. In 1831 he accepted a call to Göttingen as successor to J. G. Planck. He lectured on church history, the history of dogma, and dogmatic theology. In 1837 he was appointed a *Consistorialrath*, and shortly afterwards was created a knight of the Guelphic order. He died on the 8th of July 1854. The fourth and fifth volumes of the *Kirchengeschichte*, embracing the period subsequent to 1814, were published posthumously in 1855 by E. R. Redepenning (1810-1883); and they were followed in 1856 by a *Dogmengeschichte*, which is sometimes reckoned as the sixth volume of the *Church History*. Among church historians Gieseler continues to hold a high place. Less vivid and picturesque in style than Karl Hase, conspicuously deficient in Neander's deep and sympathetic insight into the more spiritual forces by which church life is pervaded, he excels these and all other contemporaries in the fulness and accuracy of his information. His *Lehrbuch der Kirchengeschichte*, with its copious references to original authorities, is of great value to the student: "Gieseler wished that each age should speak for itself, since only by this means can the peculiarity of its ideas be fully appreciated" (Otto Pfeiderer, *Development of Theology*, p. 284). The work, which has passed through several editions in Germany, has partially appeared also in two English translations. That

published in New York (*Text Book of Ecclesiastical History*, 5 vols.) brings the work down to the peace of Westphalia, while that published in "Clark's Theological Library" (*Compendium of Ecclesiastical History*, Edinburgh, 5 vols.) closes with the beginning of the Reformation. Gieseler was not only a devoted student but also an energetic man of business. He frequently held the office of pro-rector of the university, and did much useful work as a member of several of its committees.

GIESSEN, a town of Germany, capital of the province of Upper Hesse, in the grand-duchy of Hesse-Darmstadt, is situated in a beautiful and fruitful valley at the confluence of the Wiesek with the Lahn, 41 m. N.N.W. of Frankfort-on-Main on the railway to Cassel, and at the junction of important lines to Cologne and Coblenz. Pop. (1885) 18,836; (1905) 29,149. In the old part of the town the streets are narrow and irregular. Besides the university, the principal buildings are the Stadtkirche, the provincial government offices, comprising a portion of the old castle dating from the 12th century, the arsenal (now barracks) and the town-hall (containing an historical collection). The university, founded in 1607 by Louis V, landgrave of Hesse, has a large and valuable library, a botanic garden, an observatory, medical schools, a museum of natural history, a chemical laboratory which was directed by Justus von Liebig, professor here from 1824 to 1852, and an agricultural college. The industries include the manufacture of woollen and cotton cloth of various kinds, machines, leather, candles, tobacco and beer.

Giessen, the name of which is probably derived from the streams which pour (*giessen*) their waters here into the Lahn, was formed in the 12th century out of the villages Selters, Aster and Kropbach, for whose protection Count William of Gleiberg built the castle of Giessen. Through marriage the town came, in 1203, into the possession of the count palatine; Rudolph of Tübingen, who sold it in 1265 to the landgrave Henry of Hesse. It was surrounded with fortifications in 1530, which were demolished in 1547, but rebuilt in 1560. In 1805 they were finally pulled down, and their site converted into promenades.

See O. Buchner, *Führer für Giessen und das Lahntal* (1891); and *Aus Giessens Vergangenheit* (1885).

GIFFARD, GODFREY (c. 1235-1302), chancellor of England and bishop of Worcester, was a son of Hugh Giffard of Boyton, Wiltshire. Having entered the church he speedily obtained valuable preferments owing to the influence of his brother Walter, who became chancellor of England in 1265. In 1266 Godfrey became chancellor of the exchequer, succeeding Walter as chancellor of England when, in the same year, the latter was made archbishop of York. In 1268 he was chosen bishop of Worcester, resigning the chancellorship shortly afterwards; and both before and after 1279, when he inherited the valuable property of his brother the archbishop, he was employed on public business by Edward I. His main energies, however, were devoted to the affairs of his see. He had one long dispute with the monks of Worcester, another with the abbot of Westminster, and was vigilant in guarding his material interests. The bishop died on the 26th of January 1302, and was buried in his cathedral. Giffard, although inclined to nepotism, was a benefactor to his cathedral, and completed and fortified the episcopal castle at Hartlebury.

See W. Thomas, *Survey of Worcester Cathedral; Episcopal Registers; Register of Bishop Godfrey Giffard*, edited by J. W. Willis-Bund (Oxford, 1898-1899); and the Annals of Worcester in the *Annales monastici*, vol. iv., edited by H. R. Luard (London, 1869).

GIFFARD, WALTER (d. 1279), chancellor of England and archbishop of York, was a son of Hugh Giffard of Boyton, Wiltshire, and after serving as canon and archdeacon of Wells, was chosen bishop of Bath and Wells in May 1264. In August 1265 Henry III. appointed him chancellor of England, and he was one of the arbitrators who drew up the *dictum de Kenilworth* in 1266. Later in this year Pope Clement IV. named him archbishop of York, and having resigned the chancellorship he was an able and diligent ruler of his see, although in spite of his great wealth he was frequently in pecuniary difficulties. When

Henry III. died in November 1272 the archbishopric of Canterbury was vacant, and consequently the great seal was delivered to the archbishop of York, who was the chief of the three regents who successfully governed the kingdom until the return of Edward I. in August 1274. Having again acted in this capacity during the king's absence in 1275, Giffard died in April 1279, and was buried in his cathedral.

See *Fasti Eboracenses*, edited by J. Raine (London, 1863). Giffard's Register from 1266 to 1279 has been edited for the Surtees Society by W. Brown.

GIFFARD, WILLIAM (d. 1129), bishop of Winchester, was chancellor of William II. and received his see, in succession to Bishop Walkelin, from Henry I. (1100). He was one of the bishops elect whom Anselm refused to consecrate (1101) as having been nominated and invested by the lay power. During the investitures dispute Giffard was on friendly terms with Anselm, and drew upon himself a sentence of banishment through declining to accept consecration from the archbishop of York (1103). He was, however, one of the bishops who pressed Anselm, in 1106, to give way to the king. He was consecrated after the settlement of 1107. He became a close friend of Anselm, aided the first Cistercians to settle in England, and restored Winchester cathedral with great magnificence.

See Eadmer, *Historia novorum*, edited by M. Rule (London, 1884); and S. H. Cass, *Bishops of Winchester* (London, 1827).

GIFFEN, SIR ROBERT (1837-1910), British statistician and economist, was born at Strathaven, Lanarkshire. He entered a solicitor's office in Glasgow, and while in that city attended courses at the university. He drifted into journalism, and after working for the *Stirling Journal* he went to London in 1862 and joined the staff of the *Globe*. He also assisted Mr John (afterwards Lord) Morley, when the latter edited the *Fortnightly Review*. In 1868 he became Walter Bagehot's assistant-editor on the *Economist*; and his services were also secured in 1873 as city-editor of the *Daily News*, and later of *The Times*. His high reputation as a financial journalist and statistician, gained in these years, led to his appointment in 1876 as head of the statistical department in the Board of Trade, and subsequently he became assistant secretary (1882) and finally controller-general (1892), retiring in 1897. In connexion with his position as chief statistical adviser to the government, he was constantly employed in drawing up reports, giving evidence before commissions of inquiry, and acting as a government auditor, besides publishing a number of important essays on financial subjects. His principal publications were *Essays on Finance* (1879 and 1884), *The Progress of the Working Classes* (1884), *The Growth of Capital* (1890), *The Case against Bimetallism* (1892), and *Economic Inquiries and Studies* (1904). He was president of the Statistical Society (1882-1884); and after being made a C.B. in 1891 was created K.C.B. in 1895. In 1892 he was elected a Fellow of the Royal Society. Sir Robert Giffen continued in later years to take a leading part in all public controversies connected with finance and taxation, and his high authority and practical experience were universally recognized. He died somewhat suddenly in Scotland on the 12th of April 1910.

GIFFORD, ROBERT SWAIN (1840-1905), American marine and landscape painter, was born on Nausobon Island, Massachusetts, on the 23rd of December 1840. He studied art with the Dutch marine painter Albert van Beest, who had a studio in New Bedford, and in 1864 he opened a studio for himself in Boston, subsequently settling in New York, where he was elected an associate of the National Academy of Design in 1867 and an academician in 1878. He was also a charter member of the American Water Color Society and the Society of American Artists. From 1878 until 1896 he was teacher of painting and chief master of the Woman's Art School of Cooper Union, New York, and from 1896 until his death he was director. Gifford painted longshore views, sand dunes and landscapes generally, with charm and poetry. He was an etcher of considerable reputation, a member of the Society of American Etchers, and an honorary member of the Society of Painter-Etchers of London. He died in New York on the 13th of January 1905.

GIFFORD, SANDFORD ROBINSON (1823-1880), American landscape painter, was born at Greenfield, New York, on the 10th of July 1823. He studied (1842-1845) at Brown University, then went to New York, and entered the art schools of the National Academy of Design, of which organization he was elected an associate in 1851, and an academician in 1854. Subsequently he studied in Paris and Rome. He was one of the best known of the Hudson River school group, though it was at Lake George that he found most of his themes. In his day he enjoyed an enormous popularity, and his canvases are in many well-known American collections. He died in New York City on the 29th of August 1880.

GIFFORD, WILLIAM (1756-1826), English publicist and man of letters, was born at Ashburton, Devon, in April 1756. His father was a glazier of indifferent character, and before he was thirteen William had lost both parents. The business was seized by his godfather, on whom William and his brother, a child of two, became entirely dependent. For about three months William was allowed to remain at the free school of the town. He was then put to follow the plough, but after a day's trial he proved unequal to the task, and was sent to sea with the Brixham fishermen. After a year at sea his godfather, driven by the opinion of the townsfolk, put the boy to school once more. He made rapid progress, especially in mathematics, and began to assist the master. In 1772 he was apprenticed to a shoemaker, and when he wished to pursue his mathematical studies, he was obliged to work his problems with an awl on beaten leather. By the kindness of an Ashburton surgeon, William Cooksley, a subscription was raised to enable him to return to school. Ultimately he proceeded in his twenty-third year to Oxford, where he was appointed a Bible clerk in Exeter College. Leaving the university shortly after graduation in 1782, he found a generous patron in the first Earl Grosvenor, who undertook to provide for him, and sent him on two prolonged continental tours in the capacity of tutor to his son, Lord Belgrave. Settling in London, Gifford published in 1794 his first work, a clever satirical piece, after Persius, entitled the *Baviad*, aimed at a coterie of second-rate writers at Florence, then popularly known as the Della Cruscan, of which Mrs Piozzi was the leader. A second satire of a similar description, the *Mæviad*, directed against the corruptions of the drama, appeared in 1795. About this time Gifford became acquainted with Canning, with whose help he in August 1797 originated a weekly newspaper of Conservative politics entitled the *Anti-Jacobin*, which, however, in the following year ceased to be published. An English version of Juvenal, on which he had been for many years engaged, appeared in 1802; to this an autobiographical notice of the translator, reproduced in Nichol's *Illustrations of Literature*, was prefixed. Two years afterwards Gifford published an annotated edition of the plays of Massinger; and in 1809, when the *Quarterly Review* was projected, he was made editor. The success which attended the *Quarterly* from the outset was due in no small degree to the ability and tact with which Gifford discharged his editorial duties. He took, however, considerable liberties with the articles he inserted, and Southey, who was one of his regular contributors, said that Gifford looked on authors as Izaak Walton did on worms. His bitter opposition to Radicals and his onslaughts on new writers, conspicuous among which was the article on Keats's *Endymion*, called forth Hazlitt's *Letter to W. Gifford* in 1819. His connexion with the *Review* continued until within about two years of his death, which took place in London on the 31st of December 1826. Besides numerous contributions to the *Quarterly* during the last fifteen years of his life, he wrote a metrical translation of Persius, which appeared in 1821. Gifford also edited the dramas of Ben Jonson in 1816, and his edition of Ford appeared posthumously in 1827. His notes on Shirley were incorporated in Dyce's edition in 1833. His political services were acknowledged by the appointments of commissioner of the lottery and paymaster of the gentleman pensioners. He left a considerable fortune, the bulk of which went to the son of his first benefactor, William Cooksley.

GIFT (a common Teutonic word, cf. Ger. *die Gift*, gift, *das Gift*, poison, formed from the Teut. stem *gab-*, to give, cf. Dutch *geven*, Ger. *geben*; in O. Eng. the word appears with initial *ȝ*, the guttural of later English is due to Scandinavian influence), a general English term for a present or thing bestowed, *i.e.* an alienation of property otherwise than for a legal consideration, although in law it is often used to signify alienation with or without consideration. By analogy the terms "gift" and "gifted" are also used to signify the natural endowment of some special ability, or a miraculous power, in a person, as being not acquired in the ordinary way. The legal effect of a gratuitous gift only need be considered here. Formerly in English law property in land could be conveyed by one person to another by a verbal gift of the estate accompanied by delivery of possession. The Statute of Frauds required all such conveyances to be in writing, and a later statute (8 & 9 Vict. c. 106) requires them to be by deed. Personal property may be verbally transferred from one person to another by a simple verbal gift accompanied by delivery. If A delivers a chattel to B, saying or signifying that he does so by way of gift, the property passes, and the chattel belongs to B. But unless the actual thing is bodily handed over to the donee, the mere verbal expression of the donor's desire or intention has no legal effect whatever. The persons are in the position of parties to an agreement which is void as being without consideration. When the nature of the thing is such that it cannot be bodily handed over, it will be sufficient to put the donee in such a position as to enable him to deal with it as the owner. For example, when goods are in a warehouse, the delivery of the key will make a verbal gift of them effectual; but it seems that part delivery of goods which are capable of actual delivery will not validate a verbal gift of the part undelivered. So when goods are in the possession of a warehouseman, the handing over of a delivery order might, by special custom (but not otherwise, it appears), be sufficient to pass the property in the goods, although delivery of a bill of lading for goods at sea is equivalent to an actual delivery of the goods themselves.

GIFU (IMAZUMI), a city of Japan, capital of the *ken* (government) of Central Nippon, which comprises the two provinces of Mino and Hida. Pop. about 41,000. It lies E. by N. of Lake Biwa, on the Central railway, on a tributary of the river Kiso, which flows to the Bay of Miya Uro. Manufactures of silk and paper goods are carried on. The *ken* has an area of about 4000 sq. m. and is thickly peopled, the population exceeding 1,000,000. The whole district is subject to frequent earthquakes.

GIG, apparently an onomatopoeic word for any light whirling object, and so used of a top, as in Shakespeare's *Love's Labour's Lost*, v. i. 70 ("Goe whip thy gigge"), or of a revolving lure made of feathers for snaring birds. The word is now chiefly used of a light two-wheeled cart or carriage for one horse, and of a narrow, light, ship's boat for oars or sails, and also of a clinker-built rowing-boat used for rowing on the Thames. "Gig" is further applied, in mining, to a wooden chamber or box divided in the centre and used to draw miners up and down a pit or shaft, and to a textile machine, the "gig-mill" or "gigging machine," which raises the nap on cloth by means of teazels. A "gig" or "fish-gig" (properly "fiz-gig," possibly an adaptation of Span. *fsga*, harpoon) is an instrument used for spearing fish.

GIGLIO (anc. *Igilium*), an island of Italy, off the S.W. coast of Italy, in the province of Grosseto, 11 m. to the W. of Monte Argentario, the nearest point on the coast. It measures about 5 m. by 3 and its highest point is 1634 ft. above sea-level. Pop. (1901) 2062. It is partly composed of granite, which was quarried here by the Romans, and is still used; the island is fertile, and produces wine and fruit, the cultivation of which has taken the place of the forests of which Rutilius spoke (*Itin.* i. 325, "eminus Igilii silvosa cacumina miror"). Julius Caesar mentions its sailors in the fleet of Domitius Ahenobarbus. In Rutilius's time it served as a place of refuge from the barbarian invaders. Charlemagne gave it to the abbey of Tre Fontane at Rome. In the 14th century it belonged to Pisa, then to Florence,

then, after being seized by the Spanish fleet, it was ceded to Antonio Piccolomini, nephew of Pius II. In 1558 it was sold to the wife of Cosimo I. of Florence.

See Archduke Ludwig Salvator, *Die Insel Gijón* (Prague, 1900).

GIJÓN, a seaport of northern Spain, in the province of Oviedo; on the Bay of Biscay, and at the terminus of railways from Avilés, Oviedo and Langreo. Pop. (1900) 47,544. The older parts of Gijón, which are partly enclosed by ancient walls, occupy the upper slopes of a peninsular headland, Santa Catalina Point; while its more modern suburbs extend along the shore to Cape Torres, on the west, and Cape San Lorenzo, on the east. These suburbs contain the town-hall, theatre, markets, and a bull-ring with seats for 12,000 spectators. Few of the buildings of Gijón are noteworthy for any architectural merit, except perhaps the 15th-century parish church of San Pedro, which has a triple row of aisles on each side, the palace of the marquesses of Revillajigedo (or Revilla Gigedo), and the Asturian Institute or Jovellanos Institute. The last named has a very fine collection of drawings by Spanish and other artists, a good library and classes for instruction in seamanship, mathematics and languages. It was founded in 1797 by the poet and statesman Gaspar Melchor de Jovellanos (1744-1811). Jovellanos, a native of Gijón, is buried in San Pedro.

The Bay of Gijón is the most important roadstead on the Spanish coast between Ferrol and Santander. Its first quay was constructed by means of a grant from Charles V. in 1552-1554; and its arsenal, added in the reign of Philip II. (1556-1598), was used in 1588 as a repairing station for the surviving ships of the Invincible Armada. A new quay was built in 1766-1768, and extended in 1859; the harbour was further improved in 1864, and after 1892, when the Musel harbour of refuge was created at the extremity of the bay. It was, however, the establishment of railway communication in 1884 which brought the town its modern prosperity, by rendering it the chief port of shipment for the products of Langreo and other mining centres in Oviedo. A rapid commercial development followed. Besides large tobacco, glass and porcelain factories, Gijón possesses iron foundries and petroleum refineries; while its minor industries include fisheries, and the manufacture of preserved foods, soap, chocolate, candles and liqueurs. In 1903 the harbour accommodated 2180 vessels of 358,375 tons. In the same year the imports, consisting chiefly of machinery, iron, wood and food-stuffs, were valued at £660,889; while the exports, comprising zinc, copper, iron and other minerals, with fish, nuts and farm produce, were valued at £100,941.

Gijón is usually identified with the *Gigia* of the Romans, which, however, occupied the site of the adjoining suburb of Cima de Villa. Early in the 8th century Gijón was captured and strengthened by the Moors, who used the stones of the Roman city for their fortifications, but were expelled by King Pelayo (720-737). In 844 Gijón successfully resisted a Norman raid; in 1395 it was burned down; but thenceforward it gradually rose to commercial importance.

GILÁN (GILAN, GULAN), one of the three small but important Caspian provinces of Persia, lying along the south-western shore of the Caspian Sea between 48° 50' and 50° 30' E. with a breadth varying from 15 to 50 m. It has an area of about 5000 sq. m. and a population of about 250,000. It is separated from Russia by the little river Astara, which flows into the Caspian, and bounded W. by Azerbáiján, S. by Kazvin and E. by Mazandaran. The greater portion of the province is a lowland region extending inland from the sea to the base of the mountains of the Elburz range and, though the Sefid Rúd (White river), which is called Kizil Uzun in its upper course and has its principal sources in the hills of Persian Kurdistan, is the only river of any size, the province is abundantly watered by many streams and an exceptionally great rainfall (in some years 50 in.).

The vegetation is very much like that of southern Europe, but in consequence of the great humidity and the mild climate almost tropically luxuriant, and the forests from the shore of the sea up to an altitude of nearly 5000 ft. on the mountain slopes facing the sea are as dense as an Indian jungle. The

prevailing types of trees are the oak, maple, hornbeam, beech, ash and elm. The box tree comes to rare perfection, but in consequence of indiscriminate cutting for export during many years, is now becoming scarce. Of fruit trees the apple, pear, plum, cherry, medlar, pomegranate, fig, quince, as well as two kinds of vine, grow wild; oranges, sweet and bitter, and other Aurantiaceae thrive well in gardens and plantations. The fauna also is well represented, but tigers which once were frequently seen are now very scarce; panther, hyena, jackal, wild boar, deer (*Cervus maral*) are common; pheasant, woodcock, ducks, teal, geese and various waterfowl abound; the fisheries are very productive and are leased to a Russian firm. The ordinary cattle of the province is the small humped kind, *Bos indicus*, and forms an article of export to Russia, the humps, smoked, being much in demand as a delicacy. Rice of a kind not much appreciated in Persia, but much esteemed in Gilán and Russia, is largely cultivated and a quantity valued at about £120,000 was exported to Russia during 1904-1905. Tea plantations, with seeds and plants from Assam, Ceylon and the Himalayas, were started in the early part of 1900 on the slopes of the hills south of Resht at an altitude of about 1000 ft. The results were excellent and very good tea was produced in 1904 and 1905, but the Persian government gave no support and the enterprise was neglected. The olive thrives well at Ródbár and Manjil in the Sefid Rúd valley and the oil extracted from it by a Provençal for some years until 1896, when he was murdered, was of very good quality and found a ready market at Baku. Since then the oil has been, as before, only used for the manufacture of soap. Tobacco from Turkish seed, cultivated since 1875, grows well, and a considerable quantity of it is exported. The most valuable produce of the province is silk. In 1866 it was valued at £743,000 and about two-thirds of it was exported. The silk-worm disease appeared in 1864 and the crops decreased in consequence until 1893 when the value of the silk exported was no more than £6500. Since then there has been a steady improvement, and in 1905-1906 the value of the produce was estimated at £300,000 and that of the quantity exported at £200,000. The eggs of the silk-worms, formerly obtained from Japan, are now imported principally from Brusa by Greeks under French protection and from France.

There is only one good road in the province, that from Enzeli to Kazvin by way of Resht; in other parts communication is by narrow and frequently impassable lanes through the thick forest, or by intricate pathways through the dense undergrowth.

The province is divided into the following administrative districts: Resht (with the capital and its immediate neighbourhood), Fumen (with Tulum and Mesula, where are iron mines), Geaker, Talish (with Shandarman, Kerganrud, Asalim, Gil-Dulab, Talish-Dulab), Enzeli (the port of Resht), Sheft, Manjil (with Rahmetabad and Amarlú), Lahijan (with Langarud, Rúdsar and Ranekkuh), Dilman and Lashtnisha. The revenue derived from taxes and customs is about £80,000. The crown lands have been much neglected and the revenue from them amounts to hardly £3000 per annum: The value of the exports and imports from and into Gilán, much of them in transit, is close upon £2,000,000.

Gilán was an independent khanate until 1567 when Khan Ahmed, the last of the Kargia dynasty, which had reigned 205 years, was deposed by Tahmasp I., the second Safawid shah of Persia (1524-1576). It was occupied by a Russian force in the early part of 1723; and Tahmasp III., the tenth Safawid shah (1722-1731), then without a throne and his country occupied by the Afghans, ceded it, together with Mazandaran and Astarabad, to Peter the Great by a treaty of the 12th of September of the same year. Russian troops remained in Gilán until 1734, when they were compelled to evacuate it.

The derivation of the name Gilán from the modern Persian word *gil* meaning mud (hence "land of mud") is incorrect. It probably means "land of the Gil," an ancient tribe which classical writers mention as the Gelae. (A. H. S.)

GILBART, JAMES WILLIAM (1794-1863), English writer on banking, was born in London on the 21st of March 1794. From

1813 to 1825 he was clerk in a London bank. After a two years' residence in Birmingham, he was appointed manager of the Kilkenny branch of the Provincial Bank of Ireland, and in 1829 he was promoted to the Waterford branch. In 1834 he became manager of the London and Westminster Bank; and he did much to develop the system of joint-stock banking. On more than one occasion he rendered valuable services to the joint-stock banks by his evidence before committees of the House of Commons; and, on the renewal of the bank charter in 1844, he procured the insertion of a clause granting to joint-stock banks the power of suing by their public officer, and also the right of accepting bills at less than six months' date. In 1846 he was elected a fellow of the Royal Society. He died in London on the 8th of August 1863. The Gilbert lectures on banking at King's College are called after him.

The following are his principal works on banking, most of which have passed through more than one edition: *Practical Treatise on Banking* (1827); *The History and Principles of Banking* (1834); *The History of Banking in America* (1837); *Lectures on the History and Principles of Ancient Commerce* (1847); *Logic for the Million* (1851); and *Logic of Banking* (1857).

GILBERT, ALFRED (1854—), British sculptor and goldsmith, born in London, was the son of Alfred Gilbert, musician. He received his education mainly in Paris (École des Beaux-Arts, under Cavalier), and studied in Rome and Florence where the significance of the Renaissance made a lasting impression upon him and his art. He also worked in the studio of Sir J. Edgar Boehm, R.A. His first work of importance was the charming group of the "Mother and Child," then "The Kiss of Victory," followed by "Perseus Arming" (1883), produced directly under the influence of the Florentine masterpieces he had studied. Its success was great, and Lord Leighton forthwith commissioned "Icarus," which was exhibited at the Royal Academy in 1884, along with a remarkable "Study of a Head," and was received with general applause. Then followed "The Enchanted Chair," which, along with many other works deemed by the artist incomplete or unworthy of his powers, was ultimately broken by the sculptor's own hand. The next year Mr Gilbert was occupied with the Shaftesbury Memorial Fountain, in Piccadilly, London, a work of great originality and beauty, yet shorn of some of the intended effect through restrictions put upon the artist. In 1888 was produced the statue of H.M. Queen Victoria, set up at Winchester, in its main design and in the details of its ornamentation the most remarkable work of its kind produced in Great Britain, and perhaps, it may be added, in any other country in modern times. Other statues of great beauty, at once novel in treatment and fine in design, are those set up to Lord Reay in Bombay, and John Howard at Bedford (1898), the highly original pedestal of which did much to direct into a better channel what is apt to be the eccentricities of what is called the "New Art" School. The sculptor rose to the full height of his powers in his "Memorial to the Duke of Clarence," and his fast developing fancy and imagination, which are the main characteristics of all his work, are seen in his "Memorial Candelabrum to Lord Arthur Russell" and "Memorial Font to the son of the 4th Marquess of Bath." Gilbert's sense of decoration is paramount in all he does, and although in addition to the work already cited he produced busts of extraordinary excellence of Cyril Flower, John R. Clayton (since broken up by the artist—the fate of much of his admirable work), G. F. Watts, Sir Henry Tate, Sir George Birdwood, Sir Richard Owen, Sir George Grove and various others, it is on his goldsmithery that the artist would rest his reputation; on his mayoral chain for Preston, the epergne for Queen Victoria, the figurines of "Victory" (a statuette designed for the orb in the hand of the Winchester statue), "St Michael" and "St George," as well as smaller objects such as seals, keys and the like. Mr Gilbert was chosen associate of the Royal Academy in 1887, full member in 1892 (resigned 1909), and professor of sculpture (afterwards resigned) in 1900. In 1889 he won the *Grand Prix* at the Paris International Exhibition. He was created a member of the Victorian Order in 1897. (See SCULPTURE.)

See *The Life and Work of Alfred Gilbert, R.A., M.V.O., D.C.L.*, by Joseph Hatton (*Art Journal Office*, 1903). (M. H. S.)

GILBERT, ANN (1821–1904), American actress, was born at Rochdale, Lancashire, on the 21st of October 1821, her maiden name being Hartley. At fifteen she was a pupil at the ballet school connected with the Haymarket theatre, conducted by Paul Taglioni, and became a dancer on the stage. In 1846 she married George H. Gilbert (d. 1866), a performer in the company of which she was a member. Together they filled many engagements in English theatres, moving to America in 1849. Mrs Gilbert's first success in a speaking part was in 1857 as Wichavenda in Brougham's *Pocahontas*. In 1869 she joined Daly's company, playing for many years wives to James Lewis's husbands, and old women's parts, in which she had no equal. Mrs Gilbert held a unique position on the American stage, on account of the admiration, esteem and affection which she enjoyed both in front and behind the footlights. She died at Chicago on the 2nd of December 1904.

See *Mrs Gilbert's Stage Reminiscences* (1901).

GILBERT, GROVE KARL (1843—), American geologist, was born at Rochester, N.Y., on the 6th of May 1843. In 1860 he was attached to the Geological Survey of Ohio and in 1879 he became a member of the United States Geological Survey, being engaged on parts of the Rocky Mountains, in Nevada, Utah, California and Arizona. He is distinguished for his researches on mountain-structure and on the Great Lakes, as well as on glacial phenomena, recent earth movements, and on topographic features generally. His report on the *Geology of the Henry Mountains* (1877), in which the volcanic structure known as a laccolite was first described; his *History of the Niagara River* (1890) and *Lake Bonneville* (1891—the first of the Monographs issued by the United States Geological Survey) are specially important. He was awarded the Wollaston medal by the Geological Society of London in 1900.

GILBERT, SIR HUMPHREY (c. 1530–1583), English soldier, navigator and pioneer colonist in America, was the second son of Otho Gilbert, of Compton, near Dartmouth, Devon, and step-brother of Sir Walter Raleigh. He was educated at Eton and Oxford; intended for the law; introduced at court by Raleigh's aunt, Catherine Ashley, and appointed (July 1566) captain in the army of Ireland under Sir Henry Sidney. In April 1566 he had already joined with Antony Jenkinson in a petition to Elizabeth for the discovery of the North-East Passage; in November following he presented an independent petition for the "discovering of a passage by the north to go to Cataia." In October 1569 he became governor of Munster; on the 1st of January 1570 he was knighted; in 1571 he was returned M.P. for Plymouth; in 1572 he campaigned in the Netherlands against Spain without much success; from 1573 to 1578 he lived in retirement at Limehouse, devoting himself especially to the advocacy of a North-West Passage (his famous *Discourse* on this subject was published in 1576). Gilbert's arguments, widely circulated even before 1575, were apparently of weight in promoting the Frobisher enterprises of 1576–1578. On the 11th of June 1578, Sir Humphrey obtained his long-coveted charter for North-Western discovery and colonization, authorizing him, his heirs and assigns, to discover, occupy and possess such remote "heathen lands not actually possessed of any Christian prince or people, as should seem good to him or them." Disposing not only of his patrimony but also of the estates in Kent which he had through his wife, daughter of John Aucher of Ollerden, he fitted out an expedition which left Dartmouth on the 23rd of September 1578, and returned in May 1579, having accomplished nothing. In 1579 Gilbert aided the government in Ireland; and in 1583, after many struggles—illustrated by his appeal to Walsingham on the 11th of July 1582, for the payment of moneys due to him from government, and by his agreement with the Southampton venturers—he succeeded in equipping another fleet for "Western Planting." On the 11th of June 1583, he sailed from Plymouth with five ships and the queen's blessing; on the 13th of July the "Ark Raleigh," built and manned at his brother's expense, deserted

'the fleet; on the 30th of July he was off the north coast of Newfoundland; on the 3rd of August he arrived off the present St John's, and selected this site as the centre of his operations; on the 5th of August he began the plantation of the first English colony in North America. Proceeding southwards with three vessels, exploring and prospecting, he lost the largest near Cape Breton (20th of August); immediately after (31st of August) he started to return to England with the "Golden Hind" and the "Squirrel," of forty and ten tons respectively. Obstinate refusing to leave the "frigate" and sail in his "great ship," he shared the former's fate in a tempest off the Azores. "Monday the 9th of September," reports Hayes, the captain of the "Hind," "the frigate was near cast away, . . . yet at that time recovered; and, giving forth signs of joy, the general, sitting abaft with a book in his hand, cried out unto us in the 'Hind,' 'We are as near to heaven by sea as by land.' . . . The same Monday night, about twelve, the frigate being ahead of us in the 'Golden Hind,' suddenly her lights were out, . . . in that moment the frigate was devoured and swallowed up of the sea."

See Hakluyt, *Principal Navigations* (1599), vol. iii. pp. 135-181; Gilbert's *Discourse of a Discovery for a New Passage to Calatia*, published by George Gascoigne in 1576, with additions, probably without Gilbert's authority; Hooker's *Supplement to Holinshed's Irish Chronicle*; Roger Williams, *The Actions of the Low Countries* (1618); *State Papers, Domestic* (1577-1583); Wood's *Athenae Oxonienses*; *North British Review*, No. 45; Fox Bourne's *English Seamen under the Tudors*; Carlos Slafter, *Sir H. Gilbert and his Enterprise* (Boston, 1903), with all important documents. Gilbert's interesting writings on the need of a university for London, anticipating the provisions of the Copyright Act, have been printed by Furnivall (*Queen Elizabeth's Academy*) in the Early English Text Society Publications, extra series, No. viii.

GILBERT, JOHN (1810-1889), American actor, whose real name was Gibbs, was born in Boston, Massachusetts, on the 27th of February 1810, and made his first appearance there as Jaffier in *Venice Preserved*. He soon found that his true vein was in comedy, particularly in old-men parts. When in London in 1847 he was well received both by press and public, and played with Macready. He was the leading actor at Wallack's from 1861-1888. He died on the 17th of June 1889.

See William Winter's *Life of John Gilbert* (New York, 1890).

GILBERT, SIR JOHN (1817-1897), English painter and illustrator, one of the eight children of George Felix Gilbert, a member of a Derbyshire family, was born at Blackheath on the 21st of July 1817. He went to school there, and even in childhood displayed an extraordinary fondness for drawing and painting. Nevertheless, his father's lack of means compelled him to accept employment for the boy in the office of Messrs Dickson & Bell, estate agents, in Charlotte Row, London. Yielding, however, to his natural bent, his parents agreed that he should take up art in his own way, which included but little advice from others, his only teacher being Haydon's pupil, George Lance, the fruit painter. This artist gave him brief instructions in the use of colour. In 1836 Gilbert appeared in public for the first time. This was at the gallery of the Society of British Artists, where he sent drawings, the subjects of which were characteristic, being "The Arrest of Lord Hastings," from Shakespeare, and "Abbot Boniface," from *The Monastery* of Scott. "Inez de Castro" was in the same gallery in the next year; it was the first of a long series of works in the same medium, representing similar themes, and was accompanied, from 1837, by a still greater number of works in oil which were exhibited at the British Institution. These included "Don Quixote giving advice to Sancho Panza," 1841; "Brunette and Phillis," from *The Spectator*, 1844; "The King's Artillery at Marston Moor," 1860; and "Don Quixote comes back for the last time to his Home and Family," 1867. In that year the Institution was finally closed. Gilbert exhibited at the Royal Academy from 1838, beginning with the "Portrait of a Gentleman," and continuing, except between 1851 and 1867, till his death to exhibit there many of his best and more ambitious works. These included such capital instances as "Holbein

painting the Portrait of Anne Boleyn," "Don Quixote's first Interview with the Duke and Duchesse," 1842, "Charlemagne visiting the Schools," 1846. "Touchstone and the Shepherd," and "Rembrandt," a very fine piece, were both there in 1867; and in 1873 "Naseby," one of his finest and most picturesque designs, was also at the Royal Academy. Gilbert was elected A.R.A. 29th January 1872, and R.A. 29th June 1876. Besides these mostly large and powerful works, the artist's true arena of display was undoubtedly the gallery of the Old Water Colour Society, to which from 1852, when he was elected an Associate exhibitor, till he died forty-five years later, he contributed not fewer than 270 drawings, most of them admirable because of the largeness of their style, massive coloration, broad chiaroscuro, and the surpassing vigour of their designs. These qualities induced the leading critics to claim for him opportunities for painting mural pictures of great historic themes as decorations of national buildings. "The Trumpeter," "The Standard-Bearer," "Richard II. resigning his Crown" (now at Liverpool), "The Drug Bazaar at Constantinople," "The Merchant of Venice" and "The Turkish Water-Carrier" are but examples of that wealth of art which added to the attractions of the gallery in Pall Mall. There Gilbert was elected a full Member in 1855, and president of the Society in 1871, shortly after which he was knighted. As an illustrator of books, magazines and periodicals of every kind he was most prolific. To the success of the *Illustrated London News* his designs lent powerful aid, and he was eminently serviceable in illustrating the *Shakespeare* of Mr Howard Staunton. He died on the 6th of October 1897.

(F.G.S.)

GILBERT, SIR JOSEPH HENRY (1817-1901), English chemist, was born at Hull on the 1st of August 1817. He studied chemistry first at Glasgow under Thomas Thomson; then at University College, London, in the laboratory of A. T. Thomson (1778-1849), the professor of medical jurisprudence, also attending Thomas Graham's lectures; and finally at Giessen under Liebig. On his return to England from Germany he acted for a year or so as assistant to his old master A. T. Thomson at University College, and in 1843, after spending a short time in the study of calico dyeing and printing near Manchester, accepted the directorship of the chemical laboratory at the famous experimental station established by Sir J. B. Lawes at Rothamsted, near St Albans, for the systematic and scientific study of agriculture. This position he held for fifty-eight years, until his death on the 23rd of December 1901. The work which he carried out during that long period in collaboration with Lawes was of a most comprehensive character, involving the application of many branches of science, such as chemistry, meteorology, botany, animal and vegetable physiology, and geology; and its influence in improving the methods of practical agriculture extended all over the civilized world. Gilbert was chosen a fellow of the Royal Society in 1860, and in 1867 was awarded a royal medal jointly with Lawes. In 1880 he presided over the Chemical Section of the British Association at its meeting at Swansea, and in 1882 he was president of the London Chemical Society, of which he had been a member almost from its foundation in 1841. For six years from 1884 he filled the Sibthorpian chair of rural economy at Oxford, and he was also an honorary professor at the Royal Agricultural College, Cirencester. He was knighted in 1893, the year in which the jubilee of the Rothamsted experiments was celebrated.

GILBERT, MARIE DOLORES ELIZA ROSANNA ["LOLA MONTEZ"] (1818-1861), dancer and adventuress, the daughter of a British army officer, was born at Limerick, Ireland, in 1818. Her father dying in India when she was seven years old, and her mother marrying again, the child was sent to Europe to be educated, subsequently joining her mother at Bath. In 1837 she made a runaway match with a Captain James of the Indian army, and accompanied him to India. In 1842 she returned to England, and shortly afterwards her husband obtained a decree nisi for divorce. She then studied dancing, making an unsuccessful first appearance at Her Majesty's theatre, London, in 1843, billed as "Lola Montez, Spanish dancer." Subsequently

she appeared with considerable success in Germany, Poland and Russia. Thence she went to Paris, and in 1847 appeared at Munich, where she became the mistress of the old king of Bavaria, Ludwig I.; she was naturalized, created comtesse de Landsfeld, and given an income of £3000 a year. She soon proved herself the real ruler of Bavaria, adopting a liberal and anti-Jesuit policy. Her political opponents proved, however, too strong for her, and in 1848 she was banished. In 1849 she came to England, and in the same year was married to George Heald, a young officer in the Guards. Her husband's guardian instituted a prosecution for bigamy against her on the ground that her divorce from Captain James had not been made absolute, and she fled with Heald to Spain. In 1851 she appeared at the Broadway theatre, New York, and in the following year at the Walnut Street theatre, Philadelphia. In 1853 Heald was drowned at Lisbon, and in the same year she married the proprietor of a San Francisco newspaper, but did not live long with him. Subsequently she appeared in Australia, but returned, in 1857, to act in America, and to lecture on gallantry. Her health having broken down, she devoted the rest of her life to visiting the outcasts of her own sex in New York, where, stricken with paralysis, she died on the 17th of January 1861. See E. B. D'Auvergne, *Lola Montes* (New York, 1909).

GILBERT, NICOLAS JOSEPH LAURENT (1751-1780), French poet, was born at Fontenay-le-Château in Lorraine in 1751. Having completed his education at the college of Dôle, he devoted himself for a time to a half-scholastic, half-literary life at Nancy, but in 1774 he found his way to the capital. As an opponent of the Encyclopædists and a panegyrist of Louis XV., he received considerable pensions. He died in Paris on the 12th of November 1780 from the results of a fall from his horse. The satiric force of one or two of his pieces, as *Mons Apologie* (1778) and *Le Dix-huitième Siècle* (1775), would alone be sufficient to preserve his reputation, which has been further increased by modern writers, who, like Alfred de Vigny in his *Stello* (chapa. 7-13), considered him a victim to the spite of his philosophic opponents. His best-known verses are the *Ode imitée de plusieurs poèmes*, usually entitled *Adieu à la vie*.

Among his other works may be mentioned *Les Familles de Darius et d'Erismas, histoire persane* (1770), *Le Carnaval des auteurs* (1773), *Odes nouvelles et patriotiques* (1775). Gilbert's *Œuvres complètes* were first published in 1788, and they have since been edited by Mestrelle (Paris, 1823), by Charles Nodier (1817 or 1825), and by M. de Lescurie (1882).

GILBERT (or **GILBERDE**), **WILLIAM** (1544-1603), the most distinguished man of science in England during the reign of Queen Elizabeth, and the father of electric and magnetic science, was a member of an ancient Suffolk family, long resident in Clare, and was born on the 24th of May 1544 at Colchester, where his father, Hierome Gilbert, became recorder. Educated at Colchester school, he entered St John's College, Cambridge, in 1558, and after taking the degrees of B.A. and M.A. in due course, graduated M.D. in 1560, in which year he was elected a senior fellow of his college. Soon afterwards he left Cambridge, and after spending three years in Italy and other parts of Europe, settled in 1573 in London, where he practised as a physician with "great success and applause." He was admitted to the College of Physicians probably about 1576, and from 1581 to 1590 was one of the censors. In 1587 he became treasurer, holding the office till 1592, and in 1589 he was one of the committee appointed to superintend the preparation of the *Pharmacopœia Londinensis* which the college in that year decided to issue, but which did not actually appear till 1618. In 1597 he was again chosen treasurer, becoming at the same time consiliarius, and in 1599 he succeeded to the presidency. Two years later he was appointed physician to Queen Elizabeth, with the usual emolument of £100 a year. After this time he seems to have removed to the court, vacating his residence, Wingfield House, which was on Peter's Hill, between Upper Thames Street and Little Knight-riding Street, and close to the house of the College of Physicians. On the death of the queen in 1603 he was reappointed by her successor; but he did not long enjoy the honour, for he died, probably of the plague, on the 30th of November (10th of December, N.S.)

1603, either in London or in Colchester. He was buried in the latter town, in the chancel of Holy Trinity church, where a monument was erected to his memory. To the College of Physicians he left his books, globes, instruments and minerals, but they were destroyed in the great fire of London.

Gilbert's principal work is his treatise on magnetism, entitled *De magnete, magneticisque corporibus, et de magno magnetice tellure* (London, 1600; later editions—Stettin, 1628, 1633; Frankfurt, 1629, 1638). This work, which embodied the results of many years' research, was distinguished by its strict adherence to the scientific method of investigation by experiment, and by the originality of its matter, containing, as it does, an account of the author's experiments on magnets and magnetical bodies and on electrical attractions, and also his great conception that the earth is nothing but a large magnet, and that it is this which explains, not only the direction of the magnetic needle north and south, but also the variation and dipping or inclination of the needle. Gilbert's is therefore not merely the first, but the most important, systematic contribution to the sciences of electricity and magnetism. A posthumous work of Gilbert's was edited by his brother, also called William, from two MSS. in the possession of Sir William Boswell; its title is *De mundo nostro subturnari philosophia nova* (Amsterdam, 1651). He is the reputed inventor besides of two instruments to enable sailors "to find out the latitude without seeing of sun, moon or stars," an account of which is given in Thomas Blondenille's *Theoriques of the Planets* (London, 1602). He was also the first advocate of Copernican views in England, and he concluded that the fixed stars are not all at the same distance from the earth.

It is a matter of great regret for the historian of chemistry that Gilbert left nothing on that branch of science, to which he was deeply devoted, "attaining to great exactness therein." So at least says Thomas Fuller, who in his *Worthies of England* prophesied truly how he would be afterwards known: "Mahomet's tomb at Mecca," he says, "is said strangely to hang up, attracted by some invisible loadstone; but the memory of this doctor will never fall to the ground, which his incomparable book *De magnete* will support to eternity."

An English translation of the *De magnete* was published by P. F. Mottelay in 1893, and another, with notes by S. P. Thompson, was issued by the Gilbert Club of London in 1900.

GILBERT, SIR WILLIAM SCHWENK (1836-), English playwright and humorist, son of William Gilbert (a descendant of Sir Humphrey Gilbert), was born in London on the 18th of November 1836. His father was the author of a number of novels, the best-known of which were *Shirley Hall Asylum* (1863) and *Dr Austin's Guests* (1866). Several of these novels—which were characterized by a singular acuteness and lucidity of style, by a dry, subacid humour, by a fund of humanitarian feeling and by a considerable medical knowledge, especially in regard to the psychology of lunatics and monomaniacs—were illustrated by his son, who developed a talent for whimsical draughtsmanship. W. S. Gilbert was educated at Boulogne, at Ealing and at King's College, graduating B.A. from the university of London in 1856. The termination of the Crimean War was fatal to his project of competing for a commission in the Royal Artillery, but he obtained a post in the education department of the privy council office (1857-1861). Disliking the routine work, he left the Civil Service, entered the Inner Temple, was called to the bar in November 1864, and joined the northern circuit. His practice was inconsiderable, and his military and legal ambitions were eventually satisfied by a captaincy in the volunteers and appointment as a magistrate for Middlesex (June 1891). In 1861 the comic journal *Fun* was started by H. J. Byron, and Gilbert became from the first a valued contributor. Failing to obtain an *entrée* to *Punch*, he continued sending excellent comic verse to *Fun*, with humorous illustrations, the work of his own pen, over the signature of "Bab." A collection of these lyrics, in which deft craftsmanship unites a titillating satire on the deceptiveness of appearances with the irrepressible nonsense of a Lewis Carroll, was issued separately in 1869 under the title of *Bab Ballads*, and was followed by *More Bab Ballads*. The

two collections and *Songs of a Savoyard* were united in a volume issued in 1898, with many new illustrations. The best of the old cuts, such as those depicting the "Bishop of Rum-ti-Foo" and the "Discontented Sugar Broker," were preserved intact.

While remaining a staunch supporter of *Fun*, Gilbert was soon immersed in other journalistic work, and his position as dramatic critic to the *Illustrated Times* turned his attention to the stage. He had not to wait long for an opportunity. Early in December 1866 T. W. Robertson was asked by Miss Herbert, lessee of the St James's theatre, to find some one who could turn out a bright Christmas piece in a fortnight, and suggested Gilbert; the latter promptly produced *Dulcamara*, a burlesque of *L'Elisir d'amore*, written in ten days, rehearsed in a week, and duly performed at Christmas. He sold the piece outright for £30, a piece of rashness which he had cause to regret, for it turned out a commercial success. In 1870 he was commissioned by Buckstone to write a blank verse fairy comedy, based upon *Le Palais de la vérité*, the novel by Madame de Genlis. The result was *The Palace of Truth*, a fairy drama, poor in structure but clever in workmanship, which served the purpose of Mr and Mrs Kendal in 1870 at the Haymarket. This was followed in 1871 by *Pygmalion and Galatea*, another three-act "mythological comedy," a clever and effective but artificial piece. Another fairy comedy, *The Wicked World*, written for Buckstone and the Kendals, was followed in March 1873 by a burlesque version, in collaboration with Gilbert & Beckett, entitled *The Happy Land*. Gilbert's next dramatic ventures inclined more to the conventional pattern, combining sentiment and a cynical humour in a manner strongly reminiscent of his father's style. Of these pieces, *Sweethearts* was given at the Prince of Wales's theatre, 7th November 1874; *Tom Cobb* at the St James's, 24th April 1875; *Broken Hearts* at the Court, 9th December 1875; *Dan'l Druce* (a drama in darker vein, suggested to some extent by *Silas Marner*) at the Haymarket, 11th September 1876; and *Engaged* at the Haymarket, 3rd October 1877. The first and last of these proved decidedly popular. *Gretchen*, a verse drama in four acts, appeared in 1870. A one-act piece, called *Comedy and Tragedy*, was produced at the Lyceum, 26th January, 1884. Two dramatic trifles of later date were *Fogarty's Fairy* and *Rosenkrantz and Guildenstern*, a travesty of *Hamlet*, performed at the Vaudeville in June 1891. Several of these dramas were based upon short stories by Gilbert, a number of which had appeared from time to time in the Christmas numbers of various periodicals. The best of them have been collected in the volume entitled *Fogarty's Fairy, and other Stories*. In the autumn of 1871 Gilbert commenced his memorable collaboration (which lasted over twenty years) with Sir Arthur Sullivan. The first two comic operas, *Thespis; or The Gods grown Old* (26th September 1871) and *Trial by Jury* (Royalty, 25th March 1875) were merely essays. Like one or two of their successors, they were, as regards plot, little more than extended "Bab Ballads." Later (especially in the *Yeomen of the Guard*), much more elaboration was attempted. The next piece was produced at the Opera Comique (17th November 1877) as *The Sorcerer*. At the same theatre were successfully given *H.M.S. Pinafore* (25th May 1878), *The Pirates of Penzance; or The Slave of Duty* (3rd April 1880), and *Patience; or Bunthorne's Bride* (23rd April 1881). In October 1881 the successful *Patience* was removed to a new theatre, the Savoy, specially built for the Gilbert and Sullivan operas by Richard D'Oyly Carte. *Patience* was followed, on 25th November 1882, by *Iolanthe; or The Peer and the Peri*; and then came, on 5th January 1884, *Princess Ida; or Castle Adamant*, a re-cast of a charming and witty fantasia which Gilbert had written some years previously, and had then described as a "respectful perversion of Mr. Tennyson's exquisite poem." The impulse reached its fullest development in the operas that followed next in order—*The Mikado; or The Town of Titipu* (14th March 1885); *Ruddigore* (22nd January 1887); *The Yeomen of the Guard* (3rd October 1888); and *The Gondoliers* (7th December 1889). After the appearance of *The Gondoliers* a coolness occurred between the composer and librettist, owing to Gilbert's considering that Sullivan had not supported him in

a business disagreement with D'Oyly Carte. But the estrangement was only temporary. Gilbert wrote several more librettos, and of these *Utopia Limited* (1893) and the exceptionally witty *Grand Duke* (1896) were written in conjunction with Sullivan. As a master of metre Gilbert had shown himself consummate, as a dealer in quips and paradoxes and ludicrous dilemmas, unrivalled. Even for the music of the operas he deserves some credit, for the rhythms were frequently his own (as in "I have a Song to Sing, O"), and the metres were in many cases invented by himself. One or two of his librettos, such as that of *Patience*, are virtually flawless. Enthusiasts are divided only as to the comparative merit of the operas. *Princess Ida* and *Patience* are in some respects the daintiest. There is a genuine vein of poetry in *The Yeomen of the Guard*. Some of the drollest songs are in *Pinafore* and *Ruddigore*. *The Gondoliers* shows the most charming lightness of touch, while with the general public *The Mikado* proved the favourite. The enduring popularity of the Gilbert and Sullivan operas was abundantly proved by later revivals. Among the birthday honours in June 1907 Gilbert was given a knighthood. In 1909 his *Fallen Fairies* (music by Edward German) was produced at the Savoy. (T. St.)

GILBERT DE LA PORRÉE, frequently known as Gilbertus Porretanus or Pictaviensis (1070-1154), scholastic logician and theologian, was born at Poitiers. He was educated under Bernard of Chartres and Anselm of Laon. After teaching for about twenty years in Chartres, he lectured on dialectics and theology in Paris (from 1137) and in 1141 returned to Poitiers, being elected bishop in the following year. His heterodox opinions regarding the doctrine of the Trinity drew upon his works the condemnation of the church. The synod of Reims in 1148 procured papal sanction for four propositions opposed to certain of Gilbert's tenets, and his works were condemned until they should be corrected in accordance with the principles of the church. Gilbert seems to have submitted quietly to this judgment; he yielded assent to the four propositions, and remained on friendly terms with his antagonists till his death on the 4th of September 1154. Gilbert is almost the only logician of the 12th century who is quoted by the greater scholastics of the succeeding age. His chief logical work, the treatise *De sex principiis*, was regarded with a reverence almost equal to that paid to Aristotle, and furnished matter for numerous commentators, amongst them Albertus Magnus. Owing to the fame of this work, he is mentioned by Dante as the *Magister sex principiorum*. The treatise itself is a discussion of the Aristotelian categories, specially of the six subordinate modes. Gilbert distinguishes in the ten categories two classes, one essential, the other derivative. Essential or inhering (*formae inherentes*) in the objects themselves are only substance, quantity, quality and relation in the stricter sense of that term. The remaining six, when, where, action, passion, position and habit, are relative and subordinate (*formae assistentes*). This suggestion has some interest, but is of no great value, either in logic or in the theory of knowledge. More important in the history of scholasticism are the theological consequences to which Gilbert's realism led him. In the commentary on the treatise *De Trinitate* (erroneously attributed to Boëtius) he proceeds from the metaphysical notion that pure or abstract being is prior in nature to that which is. This pure being is God, and must be distinguished from the triune God as known to us. God is incomprehensible, and the categories cannot be applied to determine his existence. In God there is no distinction or difference, whereas in all substances or things there is duality, arising from the element of matter. Between pure being and substances stand the ideas or forms, which subsist, though they are not substances. These forms, when materialized, are called *formae substantiales* or *formae natae*; they are the essences of things, and in themselves have no relation to the accidents of things. Things are temporal, the ideas perpetual, God eternal. The pure form of existence, that by which God is God, must be distinguished from the three persons who are God by participation in this form. The form or essence is one, the persons or substances three. It was this distinction between Deitas or

Divinitas and Deus that led to the condemnation of Gilbert's doctrine.

De sex principis and commentary on the De Trinitate in Migne, Patrologia Latina, lxxv, 1285 and clxxviii, 1287; see also Abbé Berthaud, Gilbert de la Forêt (Poitiers, 1892); B. Hauréau, De la philosophie scolastique, pp. 294-318; R. Schmid's article "Gilbert Porretanus" in Herzog-Hauck, Realencycl. f. protest. Theol. (vol. 6, 1899); Prantl, Geschichte d. Logik, ii, 215; Bach, Dogmengeschichte, ii, 133; article SCHOLASTICISM.

GILBERT OF SEMPRINGHAM, ST, founder of the Gilbertines, the only religious order of English origin, was born at Sempringham in Lincolnshire, c. 1083-1089. He was educated in France, and ordained in 1123, being presented by his father to the living of Sempringham. About 1135 he established there a convent for nuns; and to perform the heavy work and cultivate the fields he formed a number of labourers into a society of lay brothers attached to the convent. Similar establishments were founded elsewhere, and in 1147 Gilbert tried to get them incorporated in the Cistercian order. Failing in this, he proceeded to form communities of priests and clerics to perform the spiritual ministrations needed by the nuns. The women lived according to the Benedictine rule as interpreted by the Cistercians; the men according to the rule of St Augustine, and were canons regular. The special constitutions of the order were largely taken from those of the Premonstratensian canons and of the Cistercians. Like Fontevault (q.v.) it was a double order, the communities of men and women living side by side; but, though the property all belonged to the nuns, the superior of the canons was the head of the whole establishment, and the general superior was a canon, called "Master of Sempringham." The general chapter was a mixed assembly composed of two canons and two nuns from each house; the nuns had to travel to the chapter in closed carts. The office was celebrated together in the church, a high stone screen separating the two choirs of canons and nuns. The order received papal approbation in 1148. By Gilbert's death (1189) there were nine double monasteries and four of canons only, containing about 700 canons and 1000 nuns in all. At the dissolution there were some 25 monasteries, whereof 4 ranked among the greater monasteries (see list in F. A. Gasquet's *English Monastic Life*). The order never spread beyond England. The habit of the Gilbertines was black, with a white cloak.

See Bollandists' *Acta Sanctorum* (4th of Feb.); William Dugdale, *Monasticon* (1846); Helyot, *Hist. des ordres religieux* (1714), ii, c. 29. The best modern account is St Gilbert of Sempringham, and the Gilbertines, by Rose Graham (1901). The art. in *Dictionary of National Biography* gives abundant information on St Gilbert, but is unsatisfactory on the order, as it might easily convey the impression that the canons and nuns lived together, whereas they were most carefully separated; and altogether undue prominence is given to a single scandal. Miss Graham declares that the reputation of the order was good until the end. (E. C. B.)

GILBERT POLIOT (d. 1187), bishop of Hereford, and of London, is first mentioned as a monk of Cluny, whence he was called in 1136 to plead the cause of the empress Matilda against Stephen at the Roman court. Shortly afterwards he became prior of Cluny; then prior of Abbéville, a house dependent upon Cluny. In 1139 he was elected abbot of Gloucester. The appointment was confirmed by Stephen, and from the ecclesiastical point of view was unexceptionable. But the new abbot proved himself a valuable ally of the empress, and her ablest controversialist. Gilbert's reputation grew rapidly. He was respected at Rome; and he acted as the representative of the primate, Theobald, in the supervision of the Welsh church. In 1148, on being nominated by the pope to the see of Hereford, Gilbert with characteristic wariness sought confirmation both from Henry of Anjou and from Stephen. But he was an Angevin at heart, and after 1154 was treated by Henry II. with every mark of consideration. He was Becket's rival for the primacy, and the only bishop who protested against the king's choice. Becket, with rare forbearance, endeavoured to win his friendship by procuring for him the see of London (1163). But Gilbert evaded the customary profession of obedience to the primate, and apparently aspired to make his see independent of Canterbury. On the questions raised by the Constitutions of Clarendon he sided with the king, whose confessor he had now

become. He urged Becket to yield, and, when this advice was rejected, encouraged his fellow-bishops to repudiate the authority of the archbishop. In the years of controversy which followed Becket's flight the king depended much upon the bishop's skill as a disputant and diplomatist. Gilbert was twice excommunicated by Becket, but both on these and on other occasions he showed great dexterity in detaching the pope from the cause of the exile. To him it was chiefly due that Henry avoided an open conflict with Rome of the kind which John afterwards provoked. Gilbert was one of the bishops whose excommunication in 1170 provoked the king's knights to murder Becket; but he cannot be reproached with any share in the crime. His later years were uneventful, though he enjoyed great influence with the king and among his fellow-bishops. Scholarly, dignified, ascetic in his private life, devoted to the service of the Church, he was nevertheless more respected than loved. His nature was cold; he made few friends; and the taint of a calculating ambition runs through his whole career. He died in the spring of 1187.

See Gilbert's *Letters*, ed. J. A. Giles (Oxford, 1845); *Materials for the History of Thomas Becket*, ed. J. C. Robertson (Rolls series, 1875-1885); and Miss K. Norgate's *England under the Angevin Kings* (1887). (H. W. C. D.)

GILBERT (KINGSMILL) ISLANDS, an extensive archipelago belonging to Great Britain in the mid-western Pacific Ocean, lying N. and S. of the equator, and between 170° and 180° E. There are sixteen islands, all coral reefs or atolls, extending in crescent form over about five degrees of latitude. The principal is Taputenea or Drummond Island. The soil, mostly of coral sand, is productive of little else than the coco-nut palm, and the chief source of food supply is the sea. The population of these islands presents a remarkable phenomenon; in spite of adverse conditions of environment and complete barbarism it is exceedingly dense, in strong contradistinction to that of many other more favoured islands. The land area of the group is only 166 m., yet the population is about 30,000. The Gilbert Islanders are a dark and coarse type of the Polynesian race, and show signs of much crossing. They are tall and stout, with an average height of 5 ft. 8 in., and are of a vigorous, energetic temperament. They are nearly always naked, but wear a conical hat of pandanus leaf. In war they have an armour of plaited coco-nut fibres. They are fierce fighters, their chief weapon being a sword armed with sharks' teeth. Their canoes are well made of coco-nut wood boards sewn neatly together and fastened on frames. British and American missionary work has been prosecuted with some success. The large population led to the introduction of natives from these islands into Hawaii as labourers in 1878-1884, but they were not found satisfactory. The islands were discovered by John Byron in 1765 (one of them bearing his name); Captains Gilbert and Marshall visited them in 1788; and they were annexed by Great Britain in 1892.

GILBEY, SIR WALTER, 1ST BART. (1831-), English wine-merchant, was born at Bishop Stortford, Hertfordshire, in 1831. His father, the owner and frequently the driver of the daily coach between Bishop Stortford and London, died when he was eleven years old, and young Gilbey was shortly afterwards placed in the office of an estate agent at Tring, subsequently obtaining a clerkship in a firm of parliamentary agents in London. On the outbreak of the Crimean War, Walter Gilbey and his younger brother, Alfred, volunteered for civilian service at the front, and were employed at a convalescent hospital on the Dardanelles. Returning to London on the declaration of peace, Walter and Alfred Gilbey, on the advice of their eldest brother, Henry Gilbey, a wholesale wine-merchant, started in the retail wine and spirit trade. The heavy duty then levied by the British government on French, Portuguese and Spanish wines was prohibitive of a sale among the English middle classes, and especially lower middle classes, whose usual alcoholic beverage was accordingly beer. Henry Gilbey was of opinion that these classes would gladly drink wine if they could get it at a moderate price, and by his advice Walter and Alfred determined to push the sales of colonial, and particularly of Cape, wines, on which

the duty was comparatively light. Backed by capital obtained through Henry Gilbey, they accordingly opened in 1857 a small retail business in a basement in Oxford Street, London. The Cape wines proved popular, and within three years the brothers had 20,000 customers on their books. The creation of the off-licence system by Mr Gladstone, then chancellor of the exchequer, in 1860, followed by the large reduction in the duty on French wines effected by the commercial treaty between England and France in 1861, revolutionized their trade and laid the foundation of their fortunes. Three provincial grocers, who had been granted the new off-licence, applied to be appointed the Gilbeys' agents in their respective districts, and many similar applications followed. These were granted, and before very long a leading local grocer was acting as the firm's agents in every district in England. The grocer who dealt in the Gilbeys' wines and spirits was not allowed to sell those of any other firm, and the Gilbeys in return handed over to him all their existing customers in his district. This arrangement was of mutual advantage, and the Gilbeys' business increased so rapidly that in 1864 Henry Gilbey abandoned his own undertaking to join his brothers. In 1867 the three brothers secured the old Pantheon theatre and concert hall in Oxford Street for their headquarters. In 1875 the firm purchased a large claret-producing estate in Médoc, on the banks of the Gironde, and became also the proprietors of two large whisky-distilleries in Scotland. In 1893 the business was converted, for family reasons, into a private limited liability company, of which Walter Gilbey, who in the same year was created a baronet, was chairman. Sir Walter Gilbey also became well known as a breeder of shire horses, and he did much to improve the breed of English horses (other than race-horses) generally, and wrote extensively on the subject. He became president of the Shire Horse Society, of the Hackney Horse Society, and of the Hunters' Improvement Society, and he was the founder and chairman of the London Cart Horse Parade Society. He was also a practical agriculturist, and president of the Royal Agricultural Society.

GILDAS, or **GILDUS** (c. 516-570), the earliest of British historians (see **CELT: Literature**, "Welsh"), surnamed by some Sapiens, and by others Badonicus, seems to have been born in the year 516. Regarding him little certain is known, beyond some isolated particulars that may be gathered from hints dropped in the course of his work. Two short treatises exist, purporting to be lives of Gildas, and ascribed respectively to the 11th and 12th centuries; but the writers of both are believed to have confounded two, if not more, persons that had borne the name. It is from an incidental remark of his own, namely, that the year of the siege of Mount Badon—one of the battles fought between the Saxons and the Britons—was also the year of his own nativity, that the date of his birth has been derived; the place, however, is not mentioned. His assertion that he was moved to undertake his task mainly by "zeal for God's house and for His holy law," and the very free use he has made of quotations from the Bible, leave scarcely a doubt that he was an ecclesiastic of some order or other. In addition, we learn that he went abroad, probably to France, in his thirty-fourth year, where, after 10 years of hesitation and preparation, he composed, about 560, the work bearing his name. His materials, he tells us, were collected from foreign rather than native sources, the latter of which had been put beyond his reach by circumstances. The *Cambrian Annals* give 570 as the year of his death.

The writings of Gildas have come down to us under the title of *Gildas Sapiens de excidio Britanniae liber querius*. Though at first written consecutively, the work is now usually divided into three portions,—a preface, the history proper, and an epistle,—the last, which is largely made up of passages and texts of Scripture brought together for the purpose of condemning the vices of his countrymen and their rulers, being the least important, though by far the longest of the three. In the second he passes in brief review the history of Britain from its invasion by the Romans till his own times. Among other matters reference is made to the introduction of Christianity in the reign of Tiberius; the persecution under Diocletian; the spread of the

Arian heresy; the election of Maximus as emperor by the legions in Britain, and his subsequent death at Aquileia; the incursions of the Picts and Scots into the southern part of the island; the temporary assistance rendered to the harassed Britons by the Romans; the final abandonment of the island by the latter; the coming of the Saxons and their reception by Guortigern (Vortigern); and, finally, the conflicts between the Britons, led by a noble Roman, Ambrosius Aurelianus, and the new invaders. Unfortunately, on almost every point on which he touches, the statements of Gildas are vague and obscure. With one exception already alluded to, no dates are given, and events are not always taken up in the order of their occurrence. These faults are of less importance during the period when Greek and Roman writers notice the affairs of Britain; but they become more serious when, as is the case from nearly the beginning of the 5th century to the date of his death, Gildas's brief narrative is our only authority for most of what passes current as the history of our island during those years. Thus it is on his sole, though in this instance perhaps trustworthy, testimony that the famous letter rests, said to have been sent to Rome in 446 by the despairing Britons, commencing:—"To Agitius (Actius), consul for the third time, the groans of the Britons."

Gildas's treatise was first published in 1525 by Polydore Vergil, but with many avowed alterations and omissions. In 1568 John Josseline, secretary to Archbishop Parker, issued a new edition of it more in conformity with manuscript authority; and in 1691 a still more carefully revised edition appeared at Oxford by Thomas Gale. It was frequently reprinted on the Continent during the 16th century, and once or twice since. The next English edition, described by Potthast as *editio pessima*, was that published by the English Historical Society in 1838, and edited by the Rev. J. Stevenson. The text of Gildas founded on Gale's edition collated with two other MSS., with elaborate introductions, is included in the *Monumenta historica Britannica*, edited by Petrie and Sharp (London, 1848). Another edition is in A. W. Haddan and W. Stubbs, *Councils and Eccles. Documents* relating to Great Britain (Oxford, 1869); the latest edition is that by Theodor Mommsen in *Monum. Germ. hist. auct. antig. xiii.* (Chronica min. iii.), 1894.

GILDER, RICHARD WATSON (1844-1909), American editor and poet, was born in Bordentown, New Jersey, on the 8th of February 1844, a brother of William Henry Gilder (1838-1900), the Arctic explorer. He was educated at Bellevue Seminary, an institution conducted by his father, the Rev. William Henry Gilder (1812-1864), in Flushing, Long Island. After three years (1865-1868) on the Newark, New Jersey, *Daily Advertiser*, he founded, with Newton Crane, the Newark *Morning Register*. In 1869 he became editor of *Hours at Home*, and in 1870 assistant editor of *Scribner's Monthly* (eleven years later re-named *The Century Magazine*), of which he became editor in 1881. He was one of the founders of the Free Art League, of the International Copyright League, and of the Authors' Club; was chairman of the New York Tenement House Commission in 1894; and was a prominent member of the National Institute of Arts and Letters, of the Council of the National Civil Service Reform League, and of the executive committee of the Citizens' Union of New York City. His poems, which are essentially lyrical, have been collected in various volumes, including *Five Books of Song* (1894), *In Palestine and other Poems* (1898), *Poems and Inscriptions* (1901), and *In the Heights* (1905). A complete edition of his poems was published in 1908. He also edited "*Sonnets from the Portuguese*" and other poems by Elizabeth Barrett Browning; "*One Word More*" and other poems by Robert Browning (1905). He died in New York on the 18th of November 1909. His wife, Helena de Kay, a grand-daughter of Joseph Rodman Drake, assisted, with Saint Gaudens and others, in founding the Society of American Artists, now merged in the National Academy, and the Art Students' League of New York. She translated Sensier's biography of Millet, and painted, before her marriage in 1874, studies in flowers and ideal heads, much admired for their feeling and delicate colouring.

GILDERSLEEVE, BASIL LANNEAU (1831-), American classical scholar, was born in Charleston, South Carolina, on the 23rd of October 1831, son of Benjamin Gildersleeve (1791-1875), a Presbyterian evangelist, and editor of the Charleston *Christian Observer* in 1826-1845, of the Richmond (Va.) *Watchman* and

Observer in 1845-1856, and of *The Central Presbyterian* in 1856-1860. The son graduated at Princeton in 1849, studied under Franz in Berlin, under Friedrich Ritschl at Bonn and under Schneidewin at Göttingen, where he received his doctor's degree in 1853. From 1856 to 1876 he was professor of Greek in the University of Virginia, holding the chair of Latin also in 1861-1866; and in 1876 he became professor of Greek in the newly founded Johns Hopkins University. In 1880 *The American Journal of Philology*, a quarterly published by the Johns Hopkins University, was established under his editorial charge, and his strong personality was expressed in the department of the *Journal* headed "Brief Report" or "Lanx Saturna," and in the earliest years of its publication every petty detail was in his hands. His style in it, as elsewhere, is in striking contrast to that of the typical classical scholar, and accords with his conviction that the true aim of scholarship is "that which is." He published a *Latin Grammar* (1867; revised with the co-operation of Gonzalez B. Lodge, 1894 and 1899) and a Latin Series for use in secondary schools (1875), both marked by lucidity of order and mastery of grammatical theory and methods. His edition of *Persius* (1875) is of great value. But his bent was rather toward Greek than Latin. His special interest in Christian Greek was partly the cause of his editing in 1877 *The Apologies of Justin Martyr*, "which" (to use his own words) "I used unblushingly as a repository for my syntactical formulæ." Gildersleeve's studies under Franz had no doubt quickened his interest in Greek syntax, and his logic, untrammelled by previous categories, and his marvellous sympathy with the language were displayed in this most unlikely of places. His *Syntax of Classic Greek* (Part I., 1900, with C. W. E. Miller) collects these formulæ. Gildersleeve edited in 1885 *The Olympian and Pythian Odes of Pindar*, with a brilliant and valuable introduction. His views on the function of grammar were summarized in a paper on *The Spiritual Rights of Minus Research* delivered at Bryn Mawr on the 16th of June 1895. His collected contributions to literary periodicals appeared in 1899 under the title *Essays and Studies Educational and Literary*.

GILDING, the art of spreading gold, either by mechanical or by chemical means, over the surface of a body for the purpose of ornament. The art of gilding was known to the ancients. According to Herodotus, the Egyptians were accustomed to gild wood and metals; and gilding by means of gold plates is frequently mentioned in the Old Testament. Pliny informs us that the first gilding seen at Rome was after the destruction of Carthage, under the censorship of Lucius Mummius, when the Romans began to gild the ceilings of their temples and palaces, the Capitol being the first place on which this enrichment was bestowed. But he adds that luxury advanced on them so rapidly that in a little time you might see all, even private and poor persons, gild the walls, vaults, and other parts of their dwellings. Owing to the comparative thickness of the gold-leaf used in ancient gilding, the traces of it which yet remain are remarkably brilliant and solid. Gilding has in all times occupied an important place in the ornamental arts of Oriental countries; and the native processes pursued in India at the present day may be taken as typical of the arts as practised from the earliest periods. For the gilding of copper, employed in the decoration of temple domes and other large works, the following is an outline of the processes employed. The metal surface is thoroughly scraped, cleaned and polished, and next heated in a fire sufficiently to remove any traces of grease or other impurity which may remain from the operation of polishing. It is then dipped in an acid solution prepared from dried unripe apricots, and rubbed with pumice or brick powder. Next, the surface is rubbed over with mercury which forms a superficial amalgam with the copper, after which it is left some hours in clean water, again washed with the acid solution, and dried. It is now ready for receiving the gold, which is laid on in leaf, and, on adhering, assumes a grey appearance from combining with the mercury, but on the application of heat the latter metal volatilizes, leaving the gold a dull greyish hue. The colour is brought up by means of rubbing with agate burnishers. The weight of mercury used in this process is double that of the gold laid on,

and the thickness of the gilding is regulated by the circumstances or necessities of the case. For the gilding of iron or steel, the surface is first scratched over with chequered lines, then washed in a hot solution of green apricots, dried and heated just short of red-heat. The gold-leaf is then laid on, and rubbed in with agate burnishers, when it adheres by catching into the prepared scratched surface.

Modern gilding is applied to numerous and diverse surfaces and by various distinct processes, so that the art is prosecuted in many ways, and is part of widely different ornamental and useful arts. It forms an important and essential part of frame-making (see CARVING AND GILDING); it is largely employed in connexion with cabinet-work, decorative painting and house ornamentation; and it also bulks largely in bookbinding and ornamental leather work. Further, gilding is much employed for coating baser metals, as in button-making, in the gilt toy trade, in electro-gilt reproductions and in electro-plating; and it is also a characteristic feature in the decoration of pottery, porcelain and glass. The various processes fall under one or other of two heads—mechanical gilding and gilding by chemical agency.

Mechanical Gilding embraces all the operations by which gold-leaf is prepared (see GOLDBEATING), and the several processes by which it is mechanically attached to the surfaces it is intended to cover. It thus embraces the burnish or water-gilding and the oil-gilding of the carver and gilder, and the gilding operations of the house decorator, the sign-painter, the bookbinder, the paper-stainer and several others. Polished iron, steel and other metals are gilt mechanically by applying gold-leaf to the metallic surface at a temperature just under red-heat, pressing the leaf on with a burnisher and reheating, when additional leaf may be laid on. The process is completed by cold burnishing.

Chemical Gilding embraces those processes in which the gold used is at some stage in a state of chemical combination. Of these the following are the principal:—

Cold Gilding.—In this process the gold is obtained in a state of extremely fine division, and applied by mechanical means. Cold gilding on silver is performed by a solution of gold in aqua-regia, applied by dipping a linen rag into the solution; burning it, and rubbing the black and heavy ashes on the silver with the finger or a piece of leather or cork. *Wet gilding* is effected by means of a dilute solution of chloride of gold with twice its quantity of ether. The liquids are agitated and allowed to rest, when the ether separates and floats on the surface of the acid. The whole mixture is then poured into a funnel with a small aperture, and allowed to rest for some time, when the acid is run off and the ether separated. The ether will be found to have taken up all the gold from the acid, and may be used for gilding iron or steel, for which purpose the metal is polished with the finest emery and spirits of wine. The ether is then applied with a small brush, and as it evaporates it deposits the gold, which can now be heated and polished. For small delicate figures a pen or a fine brush may be used for laying on the ether solution. *Fire-gilding* or *Wash-gilding* is a process by which an amalgam of gold is applied to metallic surfaces, the mercury being subsequently volatilized, leaving a film of gold or an amalgam containing from 13 to 16% of mercury. In the preparation of the amalgam the gold must first be reduced to thin plates or grains, which are heated red hot, and thrown into mercury previously heated, till it begins to smoke. Upon stirring the mercury with an iron rod, the gold totally disappears. The proportion of mercury to gold is generally as six or eight to one. When the amalgam is cold it is squeezed through chamois leather for the purpose of separating the superfluous mercury; the gold, with about twice its weight of mercury, remains behind, forming a yellowish silvery mass of the consistence of butter. When the metal to be gilt is wrought or chased, it ought to be covered with mercury before the amalgam is applied, that this may be more easily spread; but when the surface of the metal is plain, the amalgam may be applied to it direct. When no such preparation is applied, the surface to be gilded is simply bitten and cleaned with nitric acid. A deposit of mercury is obtained on a metallic surface by means of "quicksilver water," a solution of nitrate of mercury,—the nitric acid attacking the metal to which it is applied, and thus leaving a film of free metallic mercury. The amalgam being equally spread over the prepared surface of the metal, the mercury is then sublimed by a heat just sufficient for that purpose; for, if it is too great, part of the gold may be driven off, or it may run together and leave some of the surface of the metal bare. When the mercury has evaporated, which is known by the surface having entirely become of a dull yellow colour, the metal must undergo other operations, by which the fine gold colour is given to it. First, the gilded surface is rubbed with a scratch brush of brass wire, until its surface be smooth; then it is covered over with a composition called "gilding wax," and again exposed to the fire until the wax is burnt off. This wax is composed of beeswax mixed with some of the following substances,

viz. red ochre, verdigris, copper scales, alum, vitriol, borax. By this operation the colour of the gilding is heightened; and the effect seems to be produced by a perfect dissipation of some mercury remaining after the former operation. The dissipation is well effected by this equable application of heat. The gilt surface is then covered over with nitre, alum or other salts, ground together, and mixed up into a paste with water or weak ammonia. The piece of metal thus covered is exposed to a certain degree of heat, and then quenched in water. By this method its colour is further improved and brought nearer to that of gold, probably by removing any particles of copper that may have been on the gilt surface. This process, when skilfully carried out, produces gilding of great solidity and beauty; but owing to the exposure of the workmen to mercurial fumes, it is very unhealthy, and further there is much loss of mercury. Numerous contrivances have been introduced to obviate these serious evils. Gilt brass buttons used for uniforms are gilt by this process, and there is an act of parliament (1796) yet unrepealed which prescribes 5 grains of gold as the smallest quantity that may be used for the gilding of 12 dozen of buttons 1 in. in diameter.

Gilding of Pottery and Porcelain.—The quantity of gold consumed for these purposes is very large. The gold used is dissolved in aqua-regia, and the acid is driven off by heat, or the gold may be precipitated by means of sulphate of iron. In this pulverulent state the gold is mixed with $\frac{1}{2}$ th of its weight of oxide of bismuth, together with a small quantity of borax and gum water. The mixture is applied to the articles with a camel's hair pencil, and after passing through the fire the gold is of a dingy colour, but the lustre is brought out by burnishing with agate and bloodstone, and afterwards cleaning with vinegar or white-lead.

GILDS, or GUILDS. Medieval guilds were voluntary associations formed for the mutual aid and protection of their members. Among the gildsmen there was a strong spirit of fraternal co-operation or Christian brotherhood, with a mixture of worldly and religious ideals—the support of the body and the salvation of the soul. Early meanings of the root *gild* or *geld* were expiation, penalty, sacrifice or worship, feast or banquet, and contribution or payment; it is difficult to determine which is the earliest meaning, and we are not certain whether the gildsmen were originally those who contributed to a common fund or those who worshipped or feasted together. Their fraternities or societies may be divided into three classes: religious or benevolent, merchant and craft guilds. The last two categories, which do not become prominent anywhere in Europe until the 12th century, had, like all guilds, a religious tinge, but their aims were primarily worldly, and their functions were mainly of an economic character.

1. *Origin.*—Various theories have been advanced concerning the origin of guilds. Some writers regard them as a continuation of the Roman *collegia* and *sodalitates*, but there is little evidence to prove the unbroken continuity of existence of the Roman and Germanic fraternities. A more widely accepted theory derives guilds wholly or in part from the early Germanic or Scandinavian sacrificial banquets. Much influence is ascribed to this heathen element by Lujo Brentano, Karl Hegel, W. E. Wilda and other writers. This view does not seem to be tenable, for the old sacrificial carousals lack two of the essential elements of the guilds, namely corporative solidarity or permanent association and the spirit of Christian brotherhood. Dr Max Pappenheim has ascribed the origin of Germanic guilds to the northern "foster-brotherhood" or "sworn-brotherhood," which was an artificial bond of union between two or more persons. After intermingling their blood in the earth and performing other peculiar ceremonies, the two contracting parties with grasped hands swore to avenge any injury done to either of them. The objections to this theory are fully stated by Hegel (*Städte und Gilden*, i. 250-253). The foster-brotherhood seems to have been unknown to the Franks and the Anglo-Saxons, the nations in which medieval guilds first appear; and hence Dr Pappenheim's conclusions, if tenable at all, apply only to Denmark or Scandinavia.

No theory on this subject can be satisfactory which wholly ignores the influence of the Christian church. Imbued with the idea of the brotherhood of man, the church naturally fostered the early growth of guilds and tried to make them displace the old heathen banquets. The work of the church was, however, directive rather than creative. Guilds were a natural manifestation of the associative spirit which is inherent in mankind. The same needs produce in different ages associations which have striking resemblances, but those of each age have peculiarities

which indicate a spontaneous growth. It is not necessary to seek the germ of guilds in any antecedent age or institution. When the old kin-bond or *maegth* was beginning to weaken or dissolve, and the state did not yet afford adequate protection to its citizens, individuals naturally united for mutual help.

Gilds are first mentioned in the Carolingian capitularies of 779 and 789, and in the enactments made by the synod of Nantes early in the 9th century, the text of which has been preserved in the ecclesiastical ordinances of Hincmar of Rheims (A.D. 852). The capitularies of 805 and 821 also contain vague references to sworn unions of some sort, and a capitulary of 884 prohibits villeins from forming associations "vulgarly called gilds" against those who have despoiled them. The Carolingians evidently regarded such "conjurations" as "conspirations" dangerous to the state. The guilds of Norway, Denmark and Sweden are first mentioned in the 11th, 12th and 14th centuries respectively; those of France and the Netherlands in the 11th.

Many writers believe that the earliest references to guilds come from England. The laws of Ine speak of *gegildan* who help each other pay the *wergeld*, but it is not entirely certain that they were members of gild fraternities in the later sense. These are more clearly referred to in England in the second half of the 9th century, though we have little information concerning them before the 11th century. To the first half of that century belong the statutes of the fraternities of Cambridge, Abbotsbury and Exeter. They are important because they form the oldest body of gild ordinances extant in Europe. The thanes' gild at Cambridge afforded help in blood-feuds, and provided for the payment of the *wergeld* in case a member killed any one. The religious element was more prominent in Orcy's gild at Abbotsbury and in the fraternity at Exeter; their ordinances exhibit much solicitude for the salvation of the brethren's souls. The Exeter gild also gave assistance when property was destroyed by fire. Prayers for the dead, attendance at funerals of gildsmen, periodical banquets, the solemn entrance oath, fines for neglect of duty and for improper conduct, contributions to a common purse, mutual assistance in distress, periodical meetings in the gildhall,—in short, all the characteristic features of the later guilds already appear in the statutes of these Anglo-Saxon fraternities. Some continental writers, in dealing with the origin of municipal government throughout western Europe, have, however, ascribed too much importance to the Anglo-Saxon guilds, exaggerating their prevalence and contending that they form the germ of medieval municipal government. This view rests almost entirely on conjecture; there is no good evidence to show that there was any organic connexion between guilds and municipal government in England before the coming of the Normans. It should also be noted that there is no trace of the existence of either craft or merchant guilds in England before the Norman Conquest. Commerce and industry were not yet sufficiently developed to call for the creation of such associations.

2. *Religious Guilds after the Norman Conquest.*—Though we have not much information concerning the religious guilds in the 12th century, they doubtless flourished under the Anglo-Norman kings, and we know that they were numerous, especially in the boroughs, from the 13th century onward. In 1388 parliament ordered that every sheriff in England should call upon the masters and wardens of all gilds and brotherhoods to send to the king's council in Chancery, before the 2nd of February 1389, full returns regarding their foundation, ordinances and property. Many of these returns were edited by J. Toulmin Smith (1816-1869), and they throw much light on the functions of the guilds. Their ordinances are similar to those of the above-mentioned Anglo-Saxon fraternities. Each member took an oath of admission, paid an entrance-fee, and made a small annual contribution to the common fund. The brethren were aided in old age, sickness and poverty, often also in cases of loss by robbery, shipwreck and conflagration; for example, any member of the gild of St Catherine, Aldersgate, was to be assisted if he "fall into poverty or be injured through age, or through fire or water, thieves or sickness." Alms were often

given even to non-gildsmen; lights were supported at certain altars; feasts and processions were held periodically; the funerals of brethren were attended; and masses for the dead were provided from the common purse or from special contributions made by the gildsmen. Some of the religious gilds supported schools, or helped to maintain roads, bridges and town-walls, or even came, in course of time, to be closely connected with the government of the borough; but, as a rule, they were simply private societies with a limited sphere of activity. They are important because they played a prominent rôle in the social life of England, especially as eleemosynary institutions, down to the time of their suppression in 1547. Religious gilds, closely resembling those of England, also flourished on the continent during the middle ages.

3. *The Gild Merchant.*—The merchant and craft fraternities are particularly interesting to students of economic and municipal history. The gild merchant came into existence in England soon after the Norman Conquest, as a result of the increasing importance of trade, and it may have been transplanted from Normandy. Until clearer evidence of foreign influence is found, it may, however, be safer to regard it simply as a new application of the old gild principle, though this new application may have been stimulated by continental example. The evidence seems to indicate the pre-existence of the gild merchant in Normandy, but it is not mentioned anywhere on the continent before the 11th century. It spread rapidly in England, and from the reign of John onward we have evidence of its existence in many English boroughs. But in some prominent towns, notably London, Colchester, Norwich and the Cinque Ports, it seems never to have been adopted. In fact it played a more conspicuous rôle in the small boroughs than in the large ones. It was regarded by the townsmen as one of their most important privileges. Its chief function was to regulate the trade monopoly conveyed to the borough by the royal grant of *gilda mercatoria*. A grant of this sort implied that the gildsmen had the right to trade freely in the town, and to impose payments and restrictions upon others who desired to exercise that privilege. The ordinances of a gild merchant thus aim to protect the brethren from the commercial competition of strangers or non-gildsmen. More freedom of trade was allowed at all times in the selling of wares by wholesale, and also in retail dealings during the time of markets and fairs. The ordinances were enforced by an alderman with the assistance of two or more deputies, or by one or two masters, wardens or keepers. The *Morwenspeches* were periodical meetings at which the brethren feasted, revised their ordinances, admitted new members, elected officers and transacted other business.

It has often been asserted that the gild merchant and the borough were identical, and that the former was the basis of the whole municipal constitution. But recent research has discredited this theory both in England and on the continent. Much evidence has been produced to show that gild and borough, gildsmen and burgesses, were originally distinct conceptions, and that they continued to be discriminated in most towns throughout the middle ages. Admission to the gild was not restricted to burgesses; nor did the brethren form an aristocratic body having control over the whole municipal polity. No good evidence has, moreover, been advanced to prove that this or any other kind of gild was the germ of the municipal constitution. On the other hand, the gild merchant was certainly an official organ or department of the borough administration, and it exerted considerable influence upon the economic and corporative growth of the English municipalities.

Historians have expressed divergent views regarding the early relations of the craftsmen and their fraternities to the gild merchant. One of the main questions in dispute is whether artisans were excluded from the gild merchant. Many of them seem to have been admitted to membership. They were regarded as merchants, for they bought raw material and sold the manufactured commodity; no sharp line of demarcation was drawn between the two classes in the 12th and 13th centuries. Separate societies of craftsmen were formed in England soon after the

gild merchant came into existence; but at first they were few in number. The gild merchant did not give birth to craft fraternities or have anything to do with their origin; nor did it delegate its authority to them. In fact, there seems to have been little or no organic connexion between the two classes of gilds. As has already been intimated, however, many artisans probably belonged both to their own craft fraternity and to the gild merchant, and the latter, owing to its great power in the town, may have exercised some sort of supervision over the craftsmen and their societies. When the king bestowed upon the tanners or weavers or any other body of artisans the right to have a gild, they secured the monopoly of working and trading in their branch of industry. Thus with every creation of a craft fraternity the gild merchant was weakened and its sphere of activity was diminished, though the new bodies were subsidiary to the older and larger fraternity. The greater the commercial and industrial prosperity of a town, the more rapid was the multiplication of craft gilds, which was a natural result of the ever-increasing division of labour. The old gild merchant remained longest intact and powerful in the smaller boroughs, in which, owing to the predominance of agriculture, few or no craft gilds were formed. In some of the larger towns the crafts were prominent already in the 13th century, but they became much more prominent in the first half of the 14th century. Their increase in number and power was particularly rapid in the time of Edward III., whose reign marks an era of industrial progress. Many master craftsmen now became wealthy employers of labour, dealing extensively in the wares which they produced. The class of dealers or merchants, as distinguished from trading artisans, also greatly increased and established separate fraternities. When these various unions of dealers and of craftsmen embraced all the trades and branches of production in the town, little or no vitality remained in the old gild merchant; it ceased to have an independent sphere of activity. The tendency was for the single organization, with a general monopoly of trade, to be replaced by a number of separate organizations representing the various trades and handicrafts. In short, the function of guarding and supervising the trade monopoly split up into various fragments, the aggregate of the crafts superseding the old general gild merchant. This transference of the authority of the latter to a number of distinct bodies and the consequent disintegration of the old organization was a gradual spontaneous movement,—a process of slow displacement, or natural growth and decay, due to the play of economic forces,—which, generally speaking, may be assigned to the 14th and 15th centuries, the very period in which the craft gilds attained the zenith of their power. While in most towns the name and the old organization of the gild merchant thus disappeared and the institution was displaced by the aggregate of the crafts towards the close of the middle ages, in some places it survived long after the 15th century either as a religious fraternity, shorn of its old functions, or as a periodical feast, or as a vague term applied to the whole municipal corporation.

On the continent of Europe the medieval gild merchant played a less important rôle than in England. In Germany, France and the Netherlands it occupies a less prominent place in the town charters and in the municipal polity, and often corresponds to the later fraternities of English dealers established either to carry on foreign commerce or to regulate a particular part of the local trade monopoly.

4. *Craft Gilds.*—A craft gild usually comprised all the artisans in a single branch of industry in a particular town. Such a fraternity was commonly called a "mistry" or "company" in the 15th and 16th centuries, though the old term "gild" was not yet obsolete. "Gild" was also a common designation in north Germany, while the corresponding term in south Germany was *Zunft*, and in France *métier*. These societies are not clearly visible in England or on the continent before the early part of the 12th century. With the expansion of trade and industry the number of artisans increased, and they banded together for mutual protection. Some German writers have maintained that these craft organizations emanated from

manorial groups of workmen, but strong arguments have been advanced against the validity of this theory (notably by F. Keutgen). It is unnecessary to elaborate any profound theory regarding the origin of the craft guilds. The union of men of the same occupation was a natural tendency of the age. In the 13th century the trade of England continued to expand and the number of craft guilds increased. In the 14th century they were fully developed and in a flourishing condition; by that time each branch of industry in every large town had its gild. The development of these societies was even more rapid on the continent than in England.

Their organization and aims were in general the same throughout western Europe. Officers, commonly called wardens in England, were elected by the members, and their chief function was to supervise the quality of the wares produced, so as to secure good and honest workmanship. Therefore, ordinances were made regulating the hours of labour and the terms of admission to the gild, including apprenticeship. Other ordinances required members to make periodical payments to a common fund, and to participate in certain common religious observances, festivities and pageants. But the regulation of industry was always paramount to social and religious aims; the chief object of the craft gild was to supervise the processes of manufacture and to control the monopoly of working and dealing in a particular branch of industry.

We have already called attention to the gradual displacement of the gild merchant by the craft organizations. The relations of the former to the latter must now be considered more in detail. There was at no time a general struggle in England between the gild merchant and the craft guilds, though in a few towns there seems to have been some friction between merchants and artisans. There is no exact parallel in England to the conflict between these two classes in Scotland in the 16th century, or to the great continental revolution of the 13th and 14th centuries, by which the crafts threw off the yoke of patrician government and secured more independence in the management of their own affairs and more participation in the civic administration. The main causes of these conflicts on the continent were the monopoly of power by the patricians, acts of violence committed by them, their bad management of the finances and their partisan administration of justice. In some towns the victory of the artisans in the 14th century was so complete that the whole civic constitution was remodelled with the craft fraternities as a basis. A widespread movement of this sort would scarcely be found in England, where trade and industry were less developed than on the continent, and where the motives of a class conflict between merchants and craftsmen were less potent. Moreover, borough government in England seems to have been mainly democratic until the 14th or 15th century; there was no oligarchy to be depressed or suppressed. Even if there had been motives for uprisings of artisans such as took place in Germany and the Netherlands, the English kings would probably have intervened. True, there were popular uprisings in England, but they were usually conflicts between the poor and the rich; the crafts as such seldom took part in these tumults. While many continental municipalities were becoming more democratic in the 14th century, those of England were drifting towards oligarchy, towards government by a close "select body." As a rule the craft guilds secured no dominant influence in the boroughs of England, but remained subordinate to the town government. Whatever power they did secure, whether as potent subsidiary organs of the municipal polity for the regulation of trade, or as the chief or sole medium for the acquisition of citizenship, or as integral parts of the common council, was, generally speaking, the logical sequence of a gradual economic development, and not the outgrowth of a revolutionary movement by which oppressed craftsmen endeavoured to throw off the yoke of an arrogant patrician gild merchant.

Two new kinds of craft fraternities appear in the 14th century and become more prominent in the 15th, namely, the merchants' and the journeymen's companies. The mysteries or companies of merchants traded in one or more kinds of wares. They were

pre-eminently dealers, who sold what others produced. Hence they should not be confused with the old gild merchant, which originally comprised both merchants and artisans, and had the whole monopoly of the trade of the town. In most cases, the company of merchants was merely one of the craft organizations which superseded the gild merchant.

In the 14th century the journeymen or yeomen began to set up fraternities in defence of their rights. The formation of these societies marks a cleft within the ranks of some particular class of artisans—a conflict between employers, or master artisans, and workmen. The journeymen combined to protect their special interests, notably as regards hours of work and rates of wages, and they fought with the masters over the labour question in all its aspects. The resulting struggle of organized bodies of masters and journeymen was widespread throughout western Europe, but it was more prominent in Germany than in France or England. This conflict was indeed one of the main features of German industrial life in the 15th century. In England the fraternities of journeymen, after struggling a while for complete independence, seem to have fallen under the supervision and control of the masters' guilds; in other words, they became subsidiary or affiliated organs of the older craft fraternities.

An interesting phenomenon in connexion with the organization of crafts is their tendency to amalgamate, which is occasionally visible in England in the 15th century, and more frequently in the 16th and 17th. A similar tendency is visible in the Netherlands and in some other parts of the continent already in the 14th century. Several fraternities—old guilds or new companies, with their respective cognate or heterogeneous branches of industry and trade—were fused into one body. In some towns all the crafts were thus consolidated into a single fraternity, in this case a body was reproduced which regulated the whole trade monopoly of the borough, and hence bore some resemblance to the old gild merchant.

In dealing briefly with the modern history of craft guilds, we may confine our attention to England. In the Tudor period the policy of the crown was to bring them under public or national control. Laws were passed, for example in 1503, requiring that new ordinances of "fellowships of crafts or misteries" should be approved by the royal justices or by other crown officers; and the authority of the companies to fix the price of wares was thus restricted. The statute of 5 Elizabeth, c. 4, also curtailed their jurisdiction over journeymen and apprentices (see APPRENTICESHIP).

The craft fraternities were not suppressed by the statute of 1547 (1 Edward VI.). They were indeed expressly exempted from its general operation. Such portions of their revenues as were devoted to definite religious observances were, however, appropriated by the crown. The revenues confiscated were those used for "the finding, maintaining or sustentation of any priest or of any anniversary, or obit, lamp, light or other such things." This has been aptly called "the disendowment of the religion of the misteries." Edward VI.'s statute marks no break of continuity in the life of the craft organizations. Even before the Reformation, however, signs of decay had already begun to appear, and these multiplied in the 16th and 17th centuries. The old gild system was breaking down under the action of new economic forces. Its dissolution was due especially to the introduction of new industries, organized on a more modern basis, and to the extension of the domestic system of manufacture. Thus the companies gradually lost control over the regulation of industry, though they still retained their old monopoly in the 17th century, and in many cases even in the 18th. In fact, many craft fraternities still survived in the second half of the 18th century, but their usefulness had disappeared. The medieval form of association was incompatible with the new ideas of individual liberty and free competition, with the greater separation of capital and industry, employers and workmen, and with the introduction of the factory system. Intent only on promoting their own interests and disregarding the welfare of the community, the old companies had become an unmitigated evil. Attempts have been made to find in them the progenitors of the trades

unions, but there seems to be no immediate connexion between the latter and the craft guilds. The privileges of the old fraternities were not formally abolished until 1835; and the substantial remains or spectral forms of some are still visible in other towns besides London.

BIBLIOGRAPHY.—W. E. Wilda, *Das Gildenwesen im Mittelalter* (Halle, 1831); E. Levasseur, *Histoire des classes ouvrières en France* (2 vols., Paris, 1859, new ed. 1900); Gustav von Schönberg, "Zur wirtschaftlichen Bedeutung des deutschen Zunftwesens im Mittelalter," in *Jahrbücher für Nationalökonomie und Statistik*, ed. B. Hildebrand, vol. ix, pp. 1-72, 97-169 (Jena, 1867); Joshua Toulmin Smith, *English Guilds*, with Lujo Brentano's introductory essay on the *History and Development of Guilds* (London, 1870); Max Pappenheim, *Die altägyptischen Schutzgilden* (Breslau, 1885); W. J. Ashley, *Introduction to English Economic History* (2 vols., London, 1888-1893; 3rd ed. of vol. i., 1894); C. Gross, *Die Gild Merchant* (2 vols., Oxford, 1890); Karl Hegel, *Städte und Gilden der germanischen Völker* (2 vols., Leipzig, 1891); J. Malet Lambert, *Two Thousand Years of Guild Life* (Hull, 1891); Alfred Doren, *Untersuchungen zur Geschichte der Kaufmannsgilden* (Leipzig, 1893); H. Vander Linden, *Les Gildes marchandes dans les Pays-Bas au moyen âge* (Ghent, 1896); E. Martin Saint-Léon, *Histoire des corporations de métiers* (Paris, 1897); C. Nyrop, *Danmarks Gilde- og Lavsskraaer fra middelalderen* (2 vols., Copenhagen, 1899-1904); F. Keutgen, *Ämter und Zünfte* (Jena, 1903); George Unwin, *Industrial Organization in the Sixteenth and Seventeenth Centuries* (Oxford, 1904). For bibliographies of guilds, see H. Blanc, *Bibliographie des corporations ouvrières* (Paris, 1885); G. Conetta, *Bibliografia delle corporazioni d'arti e mestieri* (Rome, 1891); C. Gross, *Bibliography of British Municipal History*, including *Guilds* (New York, 1897); W. Steida, in *Handwörterbuch der Staatswissenschaften*, ed. J. Conrad (2nd ed., Jena, 1901, under "Zunftwesen"). (C. Gr.)

GILEAD (i.e. "hard" or "rugged," a name sometimes used, both in earlier and in later writers, to denote the whole of the territory occupied by the Israelites eastward of Jordan, extending from the Arnon to the southern base of Hermon (Deut. xxiv. 1; Judg. xx. 1; Jos. Ant. xii. 8. 3, 4). More precisely, however, it was the usual name of that picturesque hill country which is bounded on the N. by the Hieromax (Yarmuk), on the W. by the Jordan, on the S. by the Arnon, and on the E. by a line which may be said to follow the meridian of Ammán (Philadelphia or Rabbath-Ammon). It thus lies wholly within 31° 25' and 32° 42' N. lat. and 35° 34' and 36° E. long., and is cut in two by the Jabbok. Excluding the narrow strip of low-lying plain along the Jordan, it has an average elevation of 2500 ft. above the Mediterranean; but, as seen from the west, the relative height is very much increased by the depression of the Jordan valley. The range from the same point of view presents a singularly uniform outline, having the appearance of an unbroken wall; in reality, however, it is traversed by a number of deep ravines (wadis), of which the most important are the Yābis, the Ajlūn, the Rājib, the Zerka (Jabbok), the Hesban, and the Zerka Ma'in. The great mass of the Gilead range is formed of Jura limestone, the base slopes being sandstone partly covered by white marls. The eastern slopes are comparatively bare of trees; but the western are well supplied with oak, terebinth and pine. The pastures are everywhere luxuriant, and the wooded heights and winding glens, in which the tangled shrubbery is here and there broken up by open glades and flat meadows of green turf, exhibit a beauty of vegetation such as is hardly to be seen in any other district of Palestine.

The first biblical mention of "Mount Gilead" occurs in connexion with the reconciliation of Jacob and Laban (Genesis xxxi.). The composite nature of the story makes an identification of the exact site difficult, but one of the narrators (E) seems to have in mind the ridge of what is now known as Jebel Ajlūn, probably not far from Ma'neh (Mahanaim), near the head of the wadi Yābis. Some investigators incline to Sūf, or to the Jebel Kaskafa. At the period of the Israelite conquest the portion of Gilead northward of the Jabbok (Zerka) belonged to the dominions of Og, king of Bashan, while the southern half was ruled by Sihon; king of the Amorites, having been at an earlier date wrested from Moab (Numb. xxi. 24; Deut. iii. 12-16). These two sections were allotted respectively to Manasseh and to Reuben and Gad, both districts being peculiarly suited to the pastoral and nomadic character of these tribes. A somewhat wild Bedouin disposition, fostered by their surroundings, was retained by the Israelite in-

habitants of Gilead to a late period of their history, and seems to be to some extent discernible in what we read alike of Jephthah, of David's Gadites, and of the prophet Elijah. As the eastern frontier of Palestine, Gilead bore the first brunt of Syrian and Assyrian attacks.

After the close of the Old Testament history the word Gilead seldom occurs. It seems to have soon passed out of use as a precise geographical designation; for though occasionally mentioned by Apocryphal writers, by Josephus, and by Eusebius, the allusions are all vague, and show that those who made them had no definite knowledge of Gilead proper. In Josephus and the New Testament the name Peræa or *πέραν τοῦ Ἰορδάνου* is most frequently used; and the country is sometimes spoken of by Josephus as divided into small provinces called after the capitals in which Greek colonists had established themselves during the reign of the Seleucidæ. At present Gilead south of the Jabbok alone is known by the name of Jebel Jilad (Mount Gilead), the northern portion between the Jabbok and the Yarmuk being called Jebel Ajlūn. Jebel Jilad includes Jebel Osha, and has for its capital the town of Es-Salt. The cities of Gilead expressly mentioned in the Old Testament are Ramoth, Jabesh and Jazer. The first of these has been variously identified with Es-Salt, with Reimun, with Jerash or Gerasa, with er-Remtha, and with Sālah. Opinions are also divided on the question of its identity with Mizpeh-Gilead (see *Encyc. Biblica*, art. "Ramoth-Gilead"). Jabesh is perhaps to be found at Meriamin, less probably at ed-Deir; Jazer, at Yajuz near Jogbehah, rather than at Sar. The city named Gilead (Judg. x. 17, xii. 7; Hos. vi. 8, xii. 11) has hardly been satisfactorily explained; perhaps the text has suffered.

The "balm" (Heb. *šorī*) for which Gilead was so noted (Gen. xlvii. 11; Jer. viii. 22, xlvii. 11; Ezek. xxvii. 17), is probably to be identified with mastic (Gen. xxxvii. 25, R.V. marg.) i.e. the resin yielded by the *Pistachia Lentiscus*. The modern "balm of Gilead" or "Mecca balsam," an aromatic gum produced by the *Balsamodendron opobalsamum*, is more likely the Hebrew *mōr*, which the English Bible wrongly renders "myrrh."

See G. A. Smith, *Hist. Geog.* xxiv. foll.

(R. A. S. M.)

GILES (GIL, GILLES), ST, the name given to an abbot whose festival is celebrated on the 1st of September. According to the legend, he was an Athenian (*Alybius*, Aegidius) of royal descent. After the death of his parents he distributed his possessions among the poor, took ship, and landed at Marscilles. Thence he went to Arles, where he remained for two years with St. Caesarius. He then retired into a neighbouring desert, where he lived upon herbs and upon the milk of a hind which came to him at stated hours. He was discovered there one day by Flavius, the king of the Goths, who built a monastery on the place, of which he was the first abbot. Scholars are very much divided as to the date of his life, some holding that he lived in the 6th century, others in the 7th or 8th. It may be regarded as certain that St. Giles was buried in the hermitage which he had founded in a spot which was afterwards the town of St. Gilles (diocese of Nîmes, department of Gard). His reputation for sanctity attracted many pilgrims. Important gifts were made to the church which contained his body, and a monastery grew up hard by. It is probable that the Visigothic princes who were in possession of the country protected and enriched this monastery, and that it was destroyed by the Saracens at the time of their invasion in 721. But there are no authentic data before the 9th century concerning his history. In 808 Charlemagne took the abbey of St. Gilles under his protection, and it is mentioned among the monasteries from which only prayers for the prince and the state were due. In the 12th century the pilgrimages to St. Gilles are cited as among the most celebrated of the time. The cult of the saint, who came to be regarded as the special patron of lepers, beggars and cripples, spread very extensively over Europe, especially in England, Scotland, France, Belgium and Germany. The church of St. Giles, Cripplegate, London, was built about 1090, while the hospital for lepers at St. Giles-in-the-Fields (near New Oxford Street) was

founded by Queen Matilda in 1117. In England alone there are about 150 churches dedicated to this saint. In Edinburgh the church of St Giles could boast the possession of an arm-bone of its patron. Representations of St Giles are very frequently met with in early French and German art, but are much less common in Italy and Spain.

See *Acta Sanctorum* (September), i. 284-299; Devic and Vaissete, *Histoire générale de Languedoc*, pp. 514-522 (Toulouse, 1876); E. Rembry, *Saint Gilles, sa vie, ses reliques, son culte en Belgique et dans le nord de la France* (Bruges, 1881); F. Arnold-Forster, *Studies in Church Dedications, or England's Patron Saints*, ii. 46-51, iii. 15, 363-365 (1899); A. Jameson, *Sacred and Legendary Art*, 768-770 (1896); A. Bell, *Lives and Legends of the English Bishops and Kings, Medieval Monks, and other later Saints*, pp. 61, 70, 74-78, 84, 197 (1904). (H. Dr.)

GILFILLAN, GEORGE (1813-1878), Scottish author, was born on the 30th of January 1813, at Comrie, Perthshire, where his father, the Rev. Samuel Gilfillan, the author of some theological works, was for many years minister of a Secession congregation. After an education at Glasgow University, in March 1836 he was ordained pastor of a Secession congregation in Dundee. He published a volume of his discourses in 1839, and shortly afterwards another sermon on "Hades," which brought him under the scrutiny of his co-presbyters, and was ultimately withdrawn from circulation. Gilfillan next contributed a series of sketches of celebrated contemporary authors to the *Dumfries Herald*, then edited by Thomas Aird; and these, with several new ones, formed his first *Gallery of Literary Portraits*, which appeared in 1846, and had a wide circulation. It was quickly followed by a *Second* and a *Third Gallery*. In 1851 his most successful work, the *Bards of the Bible*, appeared. His aim was that it should be "a poem on the Bible"; and it was far more rhapsodical than critical. His *Martyrs and Heroes of the Scottish Covenant* appeared in 1832, and in 1856 he produced a partly autobiographical, partly fabulous, *History of a Man*. For thirty years he was engaged upon a long poem, on *Night*, which was published in 1867, but its theme was too vast, vague and unmanageable, and the result was a failure. He also edited an edition of the *British Poets*. As a lecturer and as a preacher he drew large crowds, but his literary reputation has not proved permanent. He died on the 13th of August 1878. He had just finished a new life of Burns designed to accompany a new edition of the works of that poet.

GILGAL (Heb. for "circle" of sacred stones), the name of several places in Palestine, mentioned in the Old Testament. The name is not found east of the Jordan.

1. The first and most important was situated "in the east border of Jericho" (Josh. iv. 19), on the border between Judah and Benjamin (Josh. xv. 7). Josephus (*Ant.* v. 1. 4) places it 50 stadia from Jordan and 10 from Jericho (the New Testament site). Jerome (*Onomasticon*, s.v. "Galgal") places Gilgal 2 Roman miles from Jericho, and speaks of it as a deserted place held in wonderful veneration ("miro cultu") by the natives. This site, which in the middle ages appears to have been lost—Gilgal being shown farther north—was in 1865 recovered by a German traveller (Hermann Zachokke), and fixed by the English survey party, though not beyond dispute. It is about 2 m. east of the site of Byzantine Jericho, and 1 m. from modern er-Riha. A fine tamarisk, traces of a church (which is mentioned in the 8th century), and a large reservoir, now filled up with mud, remain. The place is called Jiljülieh, and its position north of the valley of Achor (Wadi Kelt) and east of Jericho agrees well with the biblical indications above mentioned. A tradition connected with the fall of Jericho is attached to the site (see C. R. Conder, *Tent Work*, 203 ff.). This sanctuary and camp of Israel held a high place in the national regard, and is often mentioned in Judges and Samuel. But whether this is the Gilgal spoken of by Amos and Hosea in connexion with Bethel is by no means certain (see (3) below).

2. Gilgal, mentioned in Josh. xii. 23 in connexion with Dor, appears to have been situated in the maritime plain. Jerome (*Onomasticon*, s.v. "Gelgel") speaks of a town of the name

6 Roman miles north of Antipatris (Ras el 'Ain). This is apparently the modern Kalkilia, but about 4 m. north of Antipatris is a large village called Jiljülieh, which is more probably the biblical town.

3. The third Gilgal (2 Kings iv. 38) was in the mountains (compare 1 Sam. vii. 16, 2 Kings ii. 1-3) near Bethel. Jerome mentions this place also (*Onomasticon*, s.v. "Galgal"). It appears to be the present village of Jiljilia, about 7 English miles north of Beitin (Bethel). It may have absorbed the old shrine of Shiloh and been the sanctuary famous in the days of Amos and Hosea.

4. Deut. xi. 30 seems to imply a Gilgal near Gerizim, and there is still a place called Julcijil on the plain of Makhna, 2½ m. S. E. of Shechem. This may have been Amos's Gilgal and was almost certainly that of 1 Macc. ix. 2.

5. The Gilgal described in Josh. xv. 7 is the same as the Beth-Gilgal of Neh. xii. 29; its site is not known. (R. A. S. M.)

GILGAMESH, EPIC OF, the title given to one of the most important literary products of Babylonia, from the name of the chief personage in the series of tales of which it is composed.

Though the Gilgamesh Epic is known to us chiefly from the fragments found in the royal collection of tablets made by Assur-bani-pal, the king of Assyria (668-626 B.C.) for his palace at Nineveh, internal evidence points to the high antiquity of at least some portions of it, and the discovery of a fragment of the epic in the older form of the Babylonian script, which can be dated as 2000 B.C., confirms this view. Equally certain is a second observation of a general character that the epic originating as the greater portion of the literature in Assur-bani-pal's collection in Babylonia is a composite product, that is to say, it consists of a number of independent stories or myths originating at different times, and united to form a continuous narrative with Gilgamesh as the central figure. This view naturally raises the question whether the independent stories were all told of Gilgamesh or, as almost always happens in the case of ancient tales, were transferred to Gilgamesh as a favourite popular hero. Internal evidence again comes to our aid to lend its weight to the latter theory.

While the existence of such a personage as Gilgamesh may be admitted, he belongs to an age that could only have preserved a dim recollection of his achievements and adventures through oral traditions. The name¹ is not Babylonian, and what evidence as to his origin there is points to his having come from Elam, to the east of Babylonia. He may have belonged to the people known as the Kassites who at the beginning of the 18th century B.C. entered Babylonia from Elam, and obtained control of the Euphrates valley. Why and how he came to be a popular hero in Babylonia cannot with our present material be determined, but the epic indicates that he came as a conqueror and established himself at Erech. In so far we have embodied in the first part of the epic dim recollections of actual events, but we soon leave the solid ground of fact and find ourselves soaring to the heights of genuine myth. Gilgamesh becomes a god, and in certain portions of the epic clearly plays the part of the sun-god of the spring-time, taking the place apparently of Tammuz or Adonis, the youthful sun-god, though the story shows traits that differentiate it from the ordinary Tammuz myths. A separate stratum in the Gilgamesh epic is formed by the story of Eabani—introduced as the friend of Gilgamesh, who joins him in his adventures. There can be no doubt that Eabani, who symbolizes primeval man, was a figure originally entirely independent of Gilgamesh, but his story was incorporated into the epic by that natural process to be observed in the national epics of other peoples, which tends to connect the favourite hero with all kinds of tales that for one reason or the other become embedded in the popular mind. Another stratum is represented by the story of a favourite of the gods known as Ut-Napishtim, who is saved from a destructive storm and flood that destroys

¹ The name of the hero, written always ideographically, was for a long time provisionally read *Indubar*; but a tablet discovered by T. C. Pinches gave the equivalent *Gilgamesh* (see Jastrow, *Religion of Babylonia and Assyria*, p. 468).

the Baroghil group over the main Hindu Kush watershed. The Aashkuman is headed by the Gazar and Kora Bohrt passes, leading to the valley of the Ab-i-Punja; and the Hunza by the Kilik and Mintaka, the connecting links between the Taghdumbash Pamir and the Gilgit basin. They are all about the same height—13,000 ft. All are passable at certain times of the year to small parties, and all are uncertain. In no case do they present insuperable difficulties in themselves, glaciers and snow-fields and mountain staircases being common to all; but the gorges and precipices which distinguish the approaches to them from the south, the slippery sides of abelving spurs whose feet are washed by raging torrents, the perpetual weary monotony of ascent and descent over successive ridges multiplying the gradient indefinitely—these form the real obstacles blocking the way to these northern passes.

Gilgit Station.—The pretty little station of Gilgit (4890 ft. above sea) spreads itself in terraces above the right bank of the river nearly opposite the opening leading to Hunza, almost nestling under the cliffs of the Hindu Koh, which separates it on the south from the savage mountain wilderness of Darel and Kohistan. It includes a residency for the British political officer, with about half a dozen homes for the accommodation of officials, barracks suitable for a battalion of Kashmir troops, and a hospital. Evidences of Buddhist occupation are not wanting in Gilgit, though they are few and unimportant. Such as they are, they appear to prove that Gilgit was once a Buddhist centre, and that the old Buddhist route between Gilgit and the Peshawar plain passed through the gorges and clefts of the unexplored Darul valley to Thakot under the northern spurs of the Black Mountain.

Connections with India.—The Gilgit river joins the Indus a few miles above the little post of Bunji, where an excellent suspension bridge spans the river. The valley is low and hot, and the scenery between Gilgit and Bunji is monotonous; but the road is now maintained in excellent condition. A little below Bunji the Astor river joins the Indus from the south-east, and this deep pine-clad valley indicates the continuation of the highroad from Gilgit to Kashmir via the Tragbal and Buzil passes. Another well-known route connecting Gilgit with the Abbottabad frontier of the Punjab lies across the Babusar pass (13,000 ft.), linking the lovely Hazara valley of Kaghan to Chilas; Chilas (4150 ft.) being on the Indus, some 50 m. below Bunji. This is a more direct connexion between Gilgit and the plains of the Punjab than that afforded by the Kashmir route via Gurais and Astor, which latter route involves two considerable passes—the Tragbal (11,400) and the Buzil (13,500); but the intervening strip of absolutely independent territory (independent alike of Kashmir and the Punjab), which includes the hills bordering the road from the Babusar pass to Chilas, renders it a risky route for travellers unprotected by a military escort. Like the Kashmir route, it is now defined by a good military road.

History.—The Dards are located by Ptolemy with surprising accuracy (*Daradæ*) on the west of the Upper Indus, beyond the head-waters of the Swat river (*Soastus*), and north of the *Gandaræ*, i.e. the Gandharis, who occupied Peshawar and the country north of it. The *Dardas* and *Chinas* also appear in many of the old Pauranic lists of peoples, the latter probably representing the *Shis* branch of the Dards. This region was traversed by two of the Chinese pilgrims of the early centuries of our era, who have left records of their journeys, viz. Fabien, coming from the north, c. 400, and Hsüan Tsang, ascending from Swat, c. 631. The latter says: "Perilous were the roads, and dark the gorges. Sometimes the pilgrim had to pass by loose cords, sometimes by light stretched iron chains. Here there were ledges hanging in mid-air; there flying bridges across abysses; elsewhere paths cut with the chisel, or footings to climb by." Yet even in these inaccessible regions were found great convents, and miraculous images of Buddha. How old the name of *Gilgit* is we do not know, but it occurs in the writings of the great Mahomedan savant al-Biruni, in his notices of Indian geography. Speaking of Kashmir, he says: "Leaving the ravine by which you enter Kashmir and entering the plateau, then you have for a march of two more days on your left the mountains of Bolor and Shamlian, Turkish tribes who are called *Bhullavaryan*. Their king has the title Bhatta-Shah. Their towns are *Gilgit*, *Aswira* and *Shiltash*, and their language is the Turkish. Kashmir suffers much from their inroads" (Trs. Sachau, i. 207). There are difficult matters for discussion here. It is impossible to say what ground the writer had for calling the people *Turks*. But it is curious that the *Shins* say they are all of the same race as the Moguls of India, whatever they may mean by that. *Gilgit*, as far back as tradition goes, was ruled by rajahs of a family called *Trakane*. When this family became extinct the valley was desolated by successive invasions

of neighbouring rajahs, and in the 20 or 30 years ending with 1842 there had been five dynastic revolutions. The most prominent character in the history was a certain Gaur Rahman or Gauhar Aman, chief of Yasin, a cruel savage and man-seller, of whom many evil deeds are told. Being remonstrated with for selling a *mullah*, he said, "Why not? The Koran, the word of God is sold; why not sell the expounder thereof?" The Sikhs entered Gilgit about 1842, and kept a garrison there. When Kashmir was made over to Maharaja Gulab Singh of Jammu in 1846, by Lord Hardinge, the Gilgit claims were transferred with it. And when a commission was sent to lay down boundaries of the tracts made over, Mr Vans Agnew (afterwards murdered at Multan) and Lieut. Ralph Young of the Engineers visited Gilgit, the first Englishmen who did so. The Dogras (Gulab Singh's race) had much ado to hold their ground, and in 1852 a catastrophe occurred, parallel on a smaller scale to that of the English troops at Kabul. Nearly 2000 men of theirs were exterminated by Gaur Rahman and a combination of the Dards; only one person, a soldier's wife, escaped, and the Dogras were driven away for eight years. Gulab Singh would not again cross the Indus, but after his death (in 1857) Maharaja Ranbir Singh longed to recover lost prestige. In 1860 he sent a force into Gilgit. Gaur Rahman just then died, and there was little resistance. The Dogras after that took Yasin twice, but did not hold it. They also, in 1866, invaded Darel, one of the most secluded Dard states, to the south of the Gilgit basin, but withdrew again. In 1889, in order to guard against the advance of Russia, the British government, acting as the suzerain power of Kashmir, established the Gilgit agency; in 1901, on the formation of the North-West Frontier province, the rearrangement was made as stated above.

AUTHORITIES.—Biddulph, *The Tribes of the Hindu Kush* (Calcutta, 1880); W. Lawrence, *The Kashmir Valley* (London, 1895); Tanner, "Our Present Knowledge of the Himalaya," *Proc. R.G.S.* vol. xiii., 1891; Durand, *Making a Frontier* (London, 1899); *Report of Lockhart's Mission* (Calcutta, 1886); E. F. Knight, *Where Three Empires Meet* (London, 1892); F. Tounghusband, "Journeys in the Pamirs and Adjacent Countries," *Proc. R.G.S.* vol. xiv., 1892; Curzon, "Pamirs," *Jour. R.G.S.* vol. viii., 1896; Leitner, *Daradistan* (1877). (T. H. H.)

GILL, JOHN (1697-1771), English Nonconformist divine, was born at Kettering, Northamptonshire. His parents were poor and he owed his education chiefly to his own perseverance. In November 1716 he was baptized and began to preach at Higham Ferrers and Kettering, until the beginning of 1719, when he became pastor of the Baptist congregation at Horsleydown in Southwark. There he continued till 1757, when he removed to a chapel near London Bridge. From 1729 to 1756 he was Wednesday evening lecturer in Great Eastcheap. In 1748 he received the degree of D.D. from the university of Aberdeen. He died at Camberwell on the 14th of October 1771. Gill was a great Hebrew scholar, and in his theology a sturdy Calvinist.

His principal works are *Exposition of the Song of Solomon* (1728); *The Prophecies of the Old Testament respecting the Messiah* (1728); *The Doctrine of the Trinity* (1731); *The Cause of God and Truth* (4 vols., 1731); *Exposition of the Bible*, in 10 vols. (1746-1766), in preparing which he formed a large collection of Hebrew and Rabbinical books and MSS.; *The Antiquity of the Hebrew Language—Letters, Vowel Points, and Accents* (1767); *A Body of Doctrinal Divinity* (1767); *A Body of Practical Divinity* (1770); and *Sermons and Tracts*, with a memoir of his life (1773). An edition of his *Exposition of the Bible* appeared in 1816 with a memoir by John Rippon, which has also appeared separately.

GILL. (1) One of the *branchiæ* which form the breathing apparatus of fishes and other animals that live in the water. The word is also applied to the *branchiæ* of some kinds of worm and arachnids, and by transference to objects resembling the *branchiæ* of fishes, such as the wattles of a fowl, or the radiating films on the under side of fungi. The word is of obscure origin. Danish has *gjaelle*, and Swedish *gill* with the same meaning. The root which appears in "yawn," "chasm," has been suggested. If this be correct, the word will be in origin the same as "gill," often spelled "ghyll," meaning a glen or ravine, common in northern English dialects and also in Kent and Surrey. The *g* in both these words is hard. (2) A liquid measure usually holding

one-fourth of a pint. The word comes through the O. Fr. *gello*, from Low Lat. *gello* or *gillo*, a measure for wine. It is thus connected with "gallon." The *g* is soft. (3) An abbreviation of the feminine name Gillian, also often spelled Jill, as it is pronounced. Like Jack for a boy, with which it is often coupled, as in the nursery rhyme, it is used as a homely generic name for a girl.

GILLES DE ROYE, or **ECIDRUS DE ROYA** (d. 1478), Flemish chronicler, was born probably at Montdidier, and became a Cistercian monk. He was afterwards professor of theology in Paris and abbot of the monastery of Royaumont at Asnières-sur-Oise, retiring about 1458 to the convent of Notre Dame des Dunes, near Furnes, and devoting his time to study. Gilles wrote the *Chronicon Dunense* or *Annales Belgici*, a résumé and continuation of the work of another monk, Jean Brandon (d. 1428), which deals with the history of Flanders, and also with events in Germany, Italy and England from 792 to 1478.

The Chronicle was published by F. R. Sweet in the *Rerum Belgicarum annales* (Frankfort, 1620); and the earlier part of it by C. B. Kervyn de Lettenhove in the *Chroniques relatives à l'histoire de la Belgique* (Brussels, 1870).

GILLES LI MUISIS, or **LE MUISSET** (c. 1272-1352), French chronicler, was born probably at Tournai, and in 1289 entered the Benedictine abbey of St Martin in his native city, becoming prior of this house in 1327, and abbot four years later. He only secured the latter position after a contest with a competitor, but he appears to have been a wise ruler of the abbey. Gilles wrote two Latin chronicles, *Chronicon majus* and *Chronicon minus*, dealing with the history of the world from the creation until 1349. This work, which was continued by another writer to 1352, is valuable for the history of northern France, and Flanders during the first half of the 14th century. It is published by J. J. de Senet in the *Corpus chronicorum Flandriae*, tome ii. (Brussels, 1841). Gilles also wrote some French poems, and these *Poésies de Gilles li Muisis* have been published by Baron Kervyn de Lettenhove (Louvain, 1882).

See A. Molinier, *Les Sources de l'histoire de France*, tome iii. (Paris, 1903).

GILLESPIE, GEORGE (1613-1648), Scottish divine, was born at Kirkcaldy, where his father, John Gillespie, was parish minister, on the 21st of January 1613, and entered the university of St Andrews as a "presbytery bursar" in 1629. On the completion of a brilliant student career, he became domestic chaplain to John Gordon, 1st Viscount Kenmure (d. 1634), and afterwards to John Kennedy, earl of Cassillis, his conscience not permitting him to accept the episcopal ordination which was at that time in Scotland an indispensable condition of induction to a parish. While with the earl of Cassillis he wrote his first work, *A Dispute against the English Popish Ceremonies obtruded upon the Church of Scotland*, which, opportunely published shortly after the "Jenny Geddes" incident (but without the author's name) in the summer of 1637, attracted considerable attention, and within a few months had been found by the privy council to be so damaging that by their orders all available copies were called in and burnt. In April 1638, soon after the authority of the bishops had been set aside by the nation, Gillespie was ordained minister of Wemyss (Fife) by the presbytery of Kirkcaldy, and in the same year was a member of the famous Glasgow Assembly, before which he preached (November 21st) a sermon against royal interference in matters ecclesiastical so pronounced, as to call for some remonstrance on the part of Argyll, the lord high commissioner. In 1642 Gillespie was translated to Edinburgh; but the brief remainder of his life was chiefly spent in the conduct of public business in London. Already, in 1640, he had accompanied the commissioners of the peace to England as one of their chaplains; and in 1643 he was appointed by the Scottish Church one of the four commissioners to the Westminster Assembly. Here, though the youngest member of the Assembly, he took a prominent part in almost all the protracted discussions on church government, discipline and worship, supporting Presbyterianism by numerous controversial writings, as well as by an unusual fluency and readiness in debate. Tradition long preserved and probably enhanced the record of his victories in debate, and

especially of his encounter, with John Selden on Matt. xviii. 15-17. In 1645 he returned to Scotland, and is said to have drawn the act of assembly sanctioning the directory of public worship. On his return to London he had a hand in drafting the Westminster confession of faith, especially chap. i. Gillespie was elected moderator of the Assembly in 1648, but the laborious duties of that office (the court continued to sit from the 12th of July to the 12th of August) told fatally on an overtaxed constitution; he fell into consumption, and, after many weeks of great weakness, he died at Kirkcaldy on the 17th of December 1648. In acknowledgment of his great public services, a sum of £1000 Scots was voted, though destined never to be paid, to his widow and children by the committee of estates. A simple tombstone, which had been erected to his memory in Kirkcaldy parish church, was in 1661 publicly broken at the cross by the hand of the common hangman, but was restored in 1746.

His principal publications were controversial and chiefly against Erastianism: Three sermons against Thomas Coleman; *A Sermon before the House of Lords* (August 27th), on Matt. iii. 2, *Nihil Respondendum ad Male Audis: Aaron's Rod Blossoming, or the Divine Ordinance of Church-government vindicated* (1649), which is deservedly regarded as a really able statement of the case for an exclusive spiritual jurisdiction in the church; *One Hundred and Eleven Propositions concerning the Ministry and Government of the Church* (Edinburgh, 1647). The following were posthumously published by his brother: *A Treatise of Miscellany Questions* (1649); *The Ark of the New Testament* (2 vols., 1661-1667); *Notes of Debates and Proceedings of the Assembly of Divines at Westminster, from February 1644 to January 1645*. See Works, with memoir, published by Hetherington (Edinburgh, 1843-1846).

GILLESPIE, THOMAS (1708-1774), Scottish divine, was born at Clearburn, in the parish of Duddingston, Midlothian, in 1708. He was educated at the university of Edinburgh, and studied divinity first at a small theological seminary at Perth, and afterwards for a brief period under Philip Doddridge at Northampton, where he received ordination in January 1741. In September of the same year he was admitted minister of the parish of Carnock, Fife, the presbytery of Dunfermline agreeing not only to sustain as valid the ordination he had received in England, but also to allow a qualification of his subscription to the church's doctrinal symbol, so far as it had reference to the sphere of the civil magistrate in matters of religion. Having on conscientious grounds persistently absented himself from the meetings of presbytery held for the purpose of ordaining one Andrew Richardson, an unacceptable presentee, as minister of Inverkeithing, he was, after an unobtrusive but useful ministry of ten years, deposed by the Assembly of 1752 for maintaining that the refusal of the local presbytery to act in this case was justified. He continued, however, to preach, first at Carnock, and afterwards in Dunfermline, where a large congregation gathered round him. His conduct under the sentence of deposition produced a reaction in his favour, and an effort was made to have him reinstated; this he declined unless the policy of the church were reversed. In 1761, in conjunction with Thomas Boston of Jedburgh and Collier of Colinsburgh, he formed a distinct communion under the name of "The Presbytery of Relief,"—relief, that is to say, "from the yoke of patronage and the tyranny of the church courts." The Relief Church eventually became one of the communions combining to form the United Presbyterian Church.—He died on the 19th of January 1774. His only literary efforts were an *Essay on the Continuation of Immediate Revelations in the Church*, and a *Practical Treatise on Temptation*. Both works appeared posthumously (1774). In the former he argues that immediate revelations are no longer vouchsafed to the church, in the latter he traces temptation to the work of a personal devil.

See Lindsay's *Life and Times of the Rev. Thomas Gillespie*; Smithers's *History of the Relief Church*; for the Relief Church see UNITED PRESBYTERIAN CHURCH.

GILLIE (from the Gael. *gille*, Irish *gille* or *giolla*, a servant or boy), an attendant on a Gaelic chieftain; in this sense its use, save historically, is rare. The name is now applied in the Highlands of Scotland to the man-servant who attends a sportsman in shooting or fishing. A *gillie-welfoot*, a term now obsolete (a translation of *gillie-casfich*, from the Gaelic *cas*, foot, and

finch, wet), was the gillie whose duty it was to carry his master over streams. It became a term of contempt among the Lowlanders for the "tail" (as his attendants were called) of a Highland chief.

GILLIES, JOHN (1747-1836), Scottish historian and classical scholar, was born at Brechin, in Forfarshire, on the 18th of January 1747. He was educated at Glasgow University, where, at the age of twenty, he acted for a short time as substitute for the professor of Greek. In 1784 he completed his *History of Ancient Greece, its Colonies and Conquests* (published 1786). This work, valuable at a time when the study of Greek history was in its infancy, and translated into French and German, was written from a strong Whig bias, and is now entirely superseded (see GREECE: *Ancient History*, "Authorities"). On the death of William Robertson (1721-1793), Gillies was appointed historiographer-royal for Scotland. In his old age he retired to Clapham, where he died on the 15th of February 1836.

Of his other works, none of which are much read, the principal are: *View of the Reign of Frederic II. of Prussia, with a Parallel between that Prince and Philip II. of Macdon* (1789), rather a panegyric than a critical history; translations of Aristotle's *Rhetoric* (1823) and *Ethics and Politics* (1786-1797); of the *Orations of Lysias and Isocrates* (1778); and *History of the World from Alexander to Augustus* (1807), which, although deficient in style, was commended for its learning and research.

GILLINGHAM, a market town in the northern parliamentary division of Dorsetshire, England, 205 m. W.S.W. from London by the London & South-Western railway. Pop. (1901) 3380. The church of St Mary the Virgin has a Decorated chancel. There is a large agricultural trade, and manufactures of bricks and tiles, cord, sacking and silk, brewing and bacon-curing are carried on. The rich undulating district in which Gillingham is situated was a forest preserved by King John and his successors, and the site of their lodge is traceable near the town.

GILLINGHAM, a municipal borough of Kent, England, in the parliamentary borough of Chatham and the mid-division of the county, on the Medway immediately east of Chatham, on the South-Eastern & Chatham railway. Pop. (1891) 27,809; (1901) 42,530. Its population is largely industrial, employed in the Chatham dockyards, and in cement and brick works in the neighbourhood. The church of St Mary Magdalene ranges in date from Early English to Perpendicular, retaining also traces of Norman work and some early brasses. A great battle between Edmund Ironside and Canute, c. 1016, is placed here; and there was formerly a palace of the archbishops of Canterbury. Gillingham was incorporated in 1903, and is governed by a mayor, 6 aldermen and 18 councillors. The borough includes the populous districts of Brompton and New Brompton. Area, 4355 acres.

GILLOT, CLAUDE (1673-1722), French painter, best known as the master of Watteau and Lancret, was born at Langres. His sportive mythological landscape pieces, with such titles as "Feast of Pan" and "Feast of Bacchus," opened the Academy of Painting at Paris to him in 1715; and he then adapted his art to the fashionable tastes of the day, and introduced the decorative *fêtes champêtres*, in which he was afterwards surpassed by his pupils. He was also closely connected with the opera and theatre as a designer of scenery and costumes.

GILLOTT, JOSEPH (1790-1873), English pen-maker, was born at Sheffield on the 11th of October 1790. For some time he was a working cutler there, but in 1821 removed to Birmingham, where he found employment in the "steel toy" trade, the technical name for the manufacture of steel buckles, chains and light ornamental steel-work generally. About 1830 he turned his attention to the manufacture of steel pens by machinery, and in 1831 patented a process for placing elongated points on the nibs of pens. Subsequently he invented other improvements, getting rid of the hardness and lack of flexibility, which had been a serious defect in nibs, by cutting, in addition to the centre slit, side slits, and cross grinding the points. By 1859 he had built up a very large business. GilloTT was a liberal art-patron, and one of the first to recognise the merits of J. M. W. Turner. He died at Birmingham on the 5th of January 1873. His collection of pictures, sold after his death, realized £170,000.

GILLOW, ROBERT (d. 1773), the founder at Lancaster of a distinguished firm of English cabinet-makers and furniture designers whose books begin in 1731. He was succeeded by his eldest son Richard (1734-1811), who after being educated at the Roman Catholic seminary at Douai was taken into partnership about 1757, when the firm became Gillow & Barton, and his younger sons Robert and Thomas, and the business was continued by his grandson Richard (1778-1866). In its early days the firm of Gillow were architects as well as cabinet-makers, and the first Richard Gillow designed the classical Custom House at Lancaster. In the middle of the 18th century the business was extended to London, and about 1761 premises were opened in Oxford Street on a site which was continuously occupied until 1906. For a long period the Gillows were the best-known makers of English furniture—Sheraton and Heppelwhite both designed for them, and replicas are still made of pieces from the drawings of Robert Adam. Between 1760 and 1770 they invented the original form of the billiard-table; they were the patentees (about 1800) of the telescopic dining-table which has long been universal in English houses; for a Captain Davenport they made, if they did not invent, the first writing-table of that name. Their vogue is indicated by references to them in the works of Jane Austen, Thackeray and the first Lord Lytton, and more recently in one of Gilbert and Sullivan's comic operas.

GILLRAY, JAMES (1757-1815), English caricaturist, was born at Chelsea in 1757. His father, a native of Lanark, had served as a soldier, losing an arm at Fontenoy, and was admitted first as an inmate, and afterwards as an outdoor pensioner, at Chelsea hospital. Gillray commenced life by learning letter-engraving, in which he soon became an adept. This employment, however, proving irksome, he wandered about for a time with a company of strolling players. After a very checkered experience he returned to London, and was admitted a student in the Royal Academy, supporting himself by engraving, and probably issuing a considerable number of caricatures under fictitious names. Hogarth's works were the delight and study of his early years. "Paddy on Horseback," which appeared in 1779, is the first caricature which is certainly his. Two caricatures on Rodney's naval victory, issued in 1782, were among the first of the memorable series of his political sketches. The name of Gillray's publisher and printseller, Miss Humphrey—whose shop was first at 227 Strand, then in New Bond Street, then in Old Bond Street, and finally in St James's Street—is inextricably associated with that of the caricaturist. Gillray lived with Miss (often called Mrs) Humphrey during all the period of his fame. It is believed that he several times thought of marrying her, and that on one occasion the pair were on their way to the church, when Gillray said: "This is a foolish affair, methinks, Miss Humphrey. We live very comfortably together; we had better let well alone." There is no evidence, however, to support the stories which scandal-mongers invented about their relations. Gillray's plates were exposed in Humphrey's shop window, where eager crowds examined them. A number of his most trenchant satires are directed against George III., who, after examining some of Gillray's sketches, said, with characteristic ignorance and blindness to merit, "I don't understand these caricatures." Gillray revenged himself for this utterance by his splendid caricature entitled, "A Connoisseur Examining a Cooper," which he is doing by means of a candle on a "save-all"; so that the sketch satirizes at once the king's pretensions to knowledge of art and his miserly habits.

The excesses of the French Revolution made Gillray conservative; and he issued caricature after caricature, ridiculing the French and Napoleon, and glorifying John Bull. He is not, however, to be thought of as a keen political adherent of either the Whig or the Tory party; he dealt his blows pretty freely all round. His last work, from a design by Bunbury, is entitled "Interior of a Barber's Shop in Assize Time," and is dated 1811. While he was engaged on it he became mad, although he had occasional intervals of sanity, which he employed on his last work. The approach of madness must have been hastened by his intemperate habits. Gillray died on

the 1st of June 1815, and was buried in St James's churchyard, Piccadilly.

The times in which Gillray lived were peculiarly favourable to the growth of a great school of caricature. Party warfare was carried on with great vigour and not a little bitterness; and personalities were freely indulged in on both sides. Gillray's incomparable wit and humour, knowledge of life, fertility of resource, keen sense of the ludicrous, and beauty of execution, at once gave him the first place among caricaturists. He is honourably distinguished in the history of caricature by the fact that his sketches are real works of art. The ideas embodied in some of them are sublime and poetically magnificent in their intensity of meaning; while the coarseness by which others are disfigured is to be explained by the general freedom of treatment common in all intellectual departments in the 18th century. The historical value of Gillray's work has been recognized by accurate students of history. As has been well remarked: "Lord Stanhope has turned Gillray to account as a voracious reporter of speeches, as well as a suggestive illustrator of events." His contemporary political influence is borne witness to in a letter from Lord Bateman, dated November 3, 1798. "The Opposition," he writes to Gillray, "are as low as we can wish them. You have been of infinite service in lowering them, and making them ridiculous." Gillray's extraordinary industry may be inferred from the fact that nearly 1000 caricatures have been attributed to him; while some consider him the author of 1600 or 1700. He is invaluable to the student of English manners as well as to the political student. He attacks the social follies of the time with scathing satire; and nothing escapes his notice, not even a trifling change of fashion in dress. The great tact Gillray displays in hitting on the ludicrous side of any subject is only equalled by the exquisite finish of his sketches—the finest of which reach an epic grandeur and Miltonic sublimity of conception.

Gillray's caricatures are divided into two classes, the political series and the social. The political caricatures form really the best history extant of the latter part of the reign of George III. They were circulated not only over Britain but throughout Europe, and exerted a powerful influence. In this series, George III., the queen, the prince of Wales, Fox, Pitt, Burke and Napoleon are the most prominent figures. In 1788 appeared two fine caricatures by Gillray. "Blood on Thunder fording the Red Sea" represents Lord Thurlow carrying Warren Hastings through a sea of gore; Hastings looks very comfortable, and is carrying two large bags of money. "Market-Day" pictures the ministerialists of the time as horned cattle for sale. Among Gillray's best satires on the king are: "Farmer George and his Wife," two companion plates, in one of which the king is roasting muffins for breakfast, and in the other the queen is frying sprats; "The Anti-Saccharites," where the royal pair propose to dispense with sugar, to the great horror of the family; "A Connoisseur Examining a Cooper"; "Temperance enjoying a Frugal Meal"; "Royal Affability"; "A Lesson in Apple Dumplings"; and "The Pigs Possessed." Among his other political caricatures may be mentioned: "Britannia between Scylla and Charybdis," a picture in which Pitt, so often Gillray's butt, figures in a favourable light; "The Bridal Night"; "The Apotheosis of Hoche," which concentrates the excesses of the French Revolution in one view; "The Nursery with Britannia reposing in Peace"; "The First Kiss these Ten Years" (1803), another satire on the peace, which is said to have greatly amused Napoleon; "The Handwriting upon the Wall"; "The Confederated Coalition," a flag at the coalition which superseded the Addington ministry; "Uncorking Old Sherry"; "The Plum-Pudding in Danger"; "Making Decent," i.e., "Broad-bottomites getting into the Grand Costume"; "Comforts of a Bed of Roses"; "View of the Hustings in Covent Garden"; "Phæthon Alarmed"; and "Pandora opening her Box." The miscellaneous series of caricatures, although they have scarcely the historical importance of the political series, are more readily intelligible, and are even more amusing. Among the finest are: "Shakespeare Sacrificed"; "Flemish Characters" (two plates); "Twopenny Whist"; "Oh! that this too solid flesh would melt"; "Sandwich Carrots"; "The Gout"; "Comfort to the Corns"; "Begone Dull Care"; "The Cow-Pock," which gives humorous expression to the popular dread of vaccination; "Dillettant Theatricals"; and "Harmony before Matrimony" and "Matrimonial Harmonics"—two exceedingly good sketches in violent contrast to each other.

A selection of Gillray's works appeared in parts in 1818; but the first good edition was Thomas M'Lean's, which was published, with a key, in 1830. A somewhat bitter attack, not only on Gillray's character, but even on his genius, appeared in the *Athenaeum* for

October 1, 1831, which was successfully refuted by J. Landseer in the *Athenaeum* a fortnight later. In 1851 Henry G. Bohn put out an edition, from the original plates, in a handsome folio, the coarser sketches being published in a separate volume. For this edition Thomas Wright and R. H. Evans wrote a valuable commentary, which is a good history of the times embraced by the caricatures. The next edition, entitled *The Works of James Gillray, the Caricaturist: with the Story of his Life and Times* (Chatto & Windus, 1874), was the work of Thomas Wright, and, by its popular exposition and narrative, introduced Gillray to a very large circle formerly ignorant of him. This edition, which is complete in one volume, contains two portraits of Gillray, and upwards of 400 illustrations. Mr J. J. Cartwright, in a letter to the *Academy* (Feb. 28, 1874), drew attention to the existence of a MS. volume, in the British Museum, containing letters to and from Gillray, and other illustrative documents. The extracts he gave were used in a valuable article in the *Quarterly Review* for April 1874. See also the *Academy* for Feb. 21 and May 16, 1874.

There is a good account of Gillray in Wright's *History of Caricature and Grotesque in Literature and Art* (1865). See also the article CARICATURES.

GILLYFLOWER, a popular name applied to various flowers, but principally to the clove, *Dianthus Caryophyllus*, of which the carnation is a cultivated variety, and to the stock, *Matthiola incana*, a well-known garden favourite. The word is sometimes written gillyflower or gilloflower, and is reputedly a corruption of July-flower, "so called from the month they blow in." Henry Phillips (1775-1838), in his *Flora historica*, remarks that Turner (1568) "calls it gelouer, to which he adds the word stock, as we would say gelouers that grow on a stem or stock, to distinguish them from the clove-gelouers and the wall-gelouers. Gerard, who succeeded Turner, and after him Parkinson, calls it gilloflower, and thus it travelled from its original orthography until it was called July-flower by those who knew not whence it was derived." Dr Prior, in his useful volume on the *Popular Names of British Plants*, very distinctly shows the origin of the name. He remarks that it was "formerly spelt gylofer and gylfere with the o long, from the French *girofle*, Italian *garofalo* (M. Lat. *garofolum*), corrupted from the Latin *Caryophyllum*, and referring to the spicy odour of the flower, which seems to have been used in flavouring wine and other liquors to replace the more costly clove of India. The name was originally given in Italy to plants of the pink tribe, especially the carnation, but has in England been transferred of late years to several cruciferous-plants." The gillyflower of Chaucer and Spenser and Shakespeare was, as in Italy, *Dianthus Caryophyllus*; that of later writers and of gardeners, *Matthiola*. Much of the confusion in the names of plants has doubtless arisen from the vague use of the French terms *girofle*, *ailet* and *violette*, which were all applied to flowers of the pink tribe, but in England were subsequently extended and finally restricted to very different plants. The use made of the flowers to impart a spicy flavour to ale and wine is alluded to by Chaucer, who writes:

"And many a clove gylofere
To put in ale";

also by Spenser, who refers to them by the name of sops in wine, which was applied in consequence of their being steeped in the liquor. In both these cases, however, it is the clove-gillyflower which is intended, as it is also in the passage from Gerard, in which he states that the conserve made of the flowers with sugar "is exceeding cordial, and wonderfully above measure doth comfort the heart, being eaten now and then." The principal other plants which bear the name are the wallflower, *Cheiranthus Cheiri*, called wall-gillyflower in old books; the dame's violet, *Hesperis matronalis*, called variously the queen's, the rogue's and the winter gillyflower; the ragged-robin, *Lychnis Flos-cuculi*, called marsh-gillyflower and cuckoo-gillyflower; the water-violet, *Hottonia palustris*, called water-gillyflower; and the thrift, *Armeria vulgaris*, called sea-gillyflower. As a separate designation it is nowadays usually applied to the wallflower.

GILMAN, DANIEL COIT (1831-1908), American educationist, was born in Norwich, Connecticut, on the 6th of July 1831. He graduated at Yale in 1852, studied in Berlin, was assistant librarian at Yale in 1856-1858 and librarian in 1858-1865, and was professor of physical and political geography in the Sheffield Scientific School of Yale University and a member of the

Governing Board of this School in 1863-1872. From 1856 to 1860 he was a member of the school board of New Haven, and from August 1865 to January 1867 secretary of the Connecticut Board of Education. In 1872 he became president of the University of California at Berkeley. On the 30th of December 1874 he was elected first president of Johns Hopkins University (q.v.) at Baltimore. He entered upon his duties on the 1st of May 1875, and was formally inaugurated on the 22nd of February 1876. This post he filled until 1901. From 1901 to 1904 he was the first president of the Carnegie Institution at Washington, D.C. He died at Norwich, Conn., on the 13th of October 1908. He received the honorary degree of LL.D. from Harvard, St John's, Columbia, Yale, North Carolina, Princeton, Toronto, Wisconsin and Clark Universities, and William and Mary College: His influence upon higher education in America was great, especially at Johns Hopkins, where many wise details of administration, the plan of bringing to the university as lecturers for a part of the year scholars from other colleges, the choice of a singularly brilliant and able faculty, and the marked willingness to recognize workers in new branches of science were all largely due to him. To the organization of the Johns Hopkins hospital, of which he was made director in 1889, he contributed greatly. He was a singularly good judge of men and an able administrator, and under him Johns Hopkins had an immense influence, especially in the promotion of original and productive research. He was always deeply interested in the researches of the professors at Johns Hopkins, and it has been said of him that his attention as president was turned inside and not outside the university. He was instrumental in determining the policy of the Sheffield Scientific School of Yale University while he was a member of its governing board; on the 28th of October 1897 he delivered at New Haven a semi-centennial discourse on the school, which appears in his *University Problems*. He was a prominent member of the American Archaeological Society and of the American Oriental Society; was one of the original trustees of the John F. Slater Fund (for a time he was secretary, and from 1893 until his death was president of the board); from 1891 until his death was a trustee of the Peabody Educational Fund (being the vice-president of the board); and was an original member of the General Education Board (1902) and a trustee of the Russell Sage Foundation for Social Betterment (1907). In 1896-1897 he served on the Venezuela Boundary Commission appointed by President Cleveland. In 1901 he succeeded Carl Schurz as president of the National Civil Service Reform League and served until 1907. Some of his papers and addresses are collected in a volume entitled *University Problems in the United States* (1888). He wrote, besides, *James Monroe* (1883), in the American Statesmen Series; *a Life of James D. Dana*, the geologist (1899); *Science and Letters at Yale* (1901), and *The Launching of a University* (1906), an account of the early years of Johns Hopkins.

GILMORE, PATRICK SANSFIELD (1829-1892), American bandmaster, was born in Ireland, and settled in America about 1850. He had been in the band of an Irish regiment, and he had great success as leader of a military band at Salem, Massachusetts, and subsequently (1859) in Boston. He increased his reputation during the Civil War, particularly by organizing a monster orchestra of massed bands for a festival at New Orleans in 1864; and at Boston in 1869 and 1872 he gave similar performances. He was enormously popular as a bandmaster, and composed or arranged a large variety of pieces for orchestra. He died at St Louis on the 24th of September 1892.

GILPIN, BERNARD (1517-1583), the "Apostle of the North," was descended from a Westmorland family, and was born at Kentmere in 1517. He was educated at Queen's College, Oxford, graduating B.A. in 1540, M.A. in 1542 and B.D. in 1549. He was elected fellow of Queen's and ordained in 1542; subsequently he was elected student of Christ Church. At Oxford he first adhered to the conservative side, and defended the doctrines of the church against Hooper; but his confidence was somewhat shaken by another public disputation which he had with Peter Martyr. In 1552 he preached before King Edward VI. a sermon

on sacrilege, which was duly published, and displays the high ideal which even then he had formed of the clerical office; and about the same time he was presented to the vicarage of Norton, in the diocese of Durham, and obtained a licence, through William Cecil, as a general preacher throughout the kingdom as long as the king lived. On Mary's accession he went abroad to pursue his theological investigations at Louvain, Antwerp and Paris; and from a letter of his own, dated Louvain, 1554, we get a glimpse of the quiet student rejoicing in an "excellent library belonging to a monastery of Minorites." Returning to England towards the close of Queen Mary's reign, he was invested by his mother's uncle, Tunstall, bishop of Durham, with the archdeaconry of Durham, to which the rectory of Easington was annexed. The freedom of his attacks on the vices, and especially the clerical vices, of his times excited hostility against him, and he was formally brought before the bishop on a charge consisting of thirteen articles. Tunstall, however, not only dismissed the case, but presented the offender with the rich living of Houghton-le-Spring; and when the accusation was again brought forward, he again protected him. Enraged at this defeat, Gilpin's enemies laid their complaint before Bonner, bishop of London, who secured a royal warrant for his apprehension. Upon this Gilpin prepared for martyrdom; and, having ordered his house-steward to provide him with a long garment, that he might "goe the more comely to the stake," he set out for London. Fortunately, however, for him, he broke his leg on the journey, and his arrival was thus delayed till the news of Queen Mary's death freed him from further danger. He at once returned to Houghton, and there he continued to labour till his death on the 4th of March 1583. When the Roman Catholic bishops were deprived he was offered the see of Carlisle; but he declined this honour and also the provostship of Queen's, which was offered him in 1560. At Houghton his course of life was a ceaseless round of benevolent activity. In June 1560 he entertained Cecil and Dr Nicholas Wotton on their way to Edinburgh. His hospitable manner of living was the admiration of all. His living was a comparatively rich one, his house was better than many bishops' palaces, and his position was that of a clerical magnate. In his household he spent "every fortnight 40 bushels of corn, 20 bushels of malt and an ox, besides a proportional quantity of other kinds of provisions." Strangers and travellers found a ready reception; and even their horses were treated with so much care that it was humorously said that, if one were turned loose in any part of the country, it would immediately make its way to the rector of Houghton. Every Sunday from Michaelmas till Easter was a public day with Gilpin. For the reception of his parishioners he had three tables well covered—one for gentlemen, the second for husbandmen, the third for day-labourers; and this piece of hospitality he never omitted, even when losses or scarcity made its continuance difficult. He built and endowed a grammar-school at a cost of upwards of £500, educated and maintained a large number of poor children at his own charge, and provided the more promising pupils with means of studying at the universities. So many young people, indeed, flocked to his school that there was not accommodation for them in Houghton, and he had to fit up part of his house as a boarding establishment. Grieved at the ignorance and superstition which the remissness of the clergy permitted to flourish in the neighbouring parishes, he used every year to visit the most neglected parts of Northumberland, Yorkshire, Cheshire, Westmorland and Cumberland; and that his own flock might not suffer, he was at the expense of a constant assistant. Among his parishioners he was looked up to as a judge, and did great service in preventing law-suits amongst them. If an industrious man suffered a loss, he delighted to make it good; if the harvest was bad, he was liberal in the remission of tithes. The boldness which he could display at need is well illustrated by his action in regard to duelling. Finding one day a challenge-glove stuck up on the door of a church where he was to preach, he took it down with his own hand, and proceeded to the pulpit to inveigh against the unchristian custom. His theological position was not in accord with any of

the religious parties of his age, and Gladstone thought that the catholicity of the Anglican Church was better exemplified in his career than in those of more prominent ecclesiastics (pref. to A. W. Hutton's edition of S. R. Maitland's *Essays on the Reformation*). He was not satisfied with the Elizabethan settlement, had great respect for the Fathers, and was with difficulty induced to subscribe. Archbishop Sandys' views on the Eucharist horrified him; but on the other hand he maintained friendly relations with Bishop Pilkington and Thomas Lever, and the Puritans had some hope of his support.

A life of Bernard Gilpin, written by George Carleton, bishop of Chichester, who had been a pupil of Gilpin's at Houghton, will be found in Bates's *Vitae selectiorum aliquot virorum*, &c. (London, 1681). A translation of this sketch by William Freake, minister, was published at London, 1629; and in 1852 it was reprinted in Glasgow, with an introductory essay by Edward Irving. It forms one of the lives in Christopher Wordsworth's *Ecclesiastical Biography* (vol. iii., 4th ed.), having been compared with Carleton's Latin text. Another biography of Gilpin, which, however, adds little to Bishop Carleton's, was written by William Gilpin, M.A., prebendary of Alsbury (London, 1753 and 1854). See also *Dict. Nat. Biog.*

GILSONITE (so named after S. H. Gilson of Salt Lake City), or **UINTAMITE**, or **UINTAITE**, a description of asphalt occurring in masses several inches in diameter in the Uinta (or Uintah) valley, near Fort Duchesne, Utah. It is of black colour; its fracture is conchoidal, and it has a lustrous surface. When warmed it becomes plastic, and on further heating fuses perfectly. It has a specific gravity of 1.065 to 1.070. It dissolves freely in hot oil of turpentine. The output amounted to 10,916 short tons for the year 1905, and the value was \$4.31 per ton.

GILYAKS, a hybrid people, originally widespread throughout the Lower Amur district, but now confined to the Amur delta and the north of Sakhalin. They have been affiliated by some authorities to the Ainu of Sakhalin and Yezo; but they are more probably a mongrel people, and Dr A. Anuchin states that there are two types, a Mongoloid with sparse beard, high cheekbones and flat face, and a Caucasian with bushy beard and more regular features. The Chinese call them *Yupitaise*, "Fish-skin-clad people," from their wearing a peculiar dress made from salmon skin.

See E. G. Ravenstein, *The Russians on the Amur* (1861); Dr A. Anuchin, *Mem. Imp. Soc. Nat. Sc. xx.*, Supplement (Moscow, 1877); H. von Siebold, *Über die Aino* (Berlin, 1881); J. Deniker in *Revue d'ethnographie* (Paris, 1884); L. Schrenck, *Die Völker des Amurlandes* (St Petersburg, 1891).

GIMBAL, a mechanical device for hanging some object so that it should keep a horizontal and constant position, while the body from which it is suspended is in free motion, so that the motion of the supporting body is not communicated to it. It is thus used particularly for the suspension of compasses or chronometers and lamps at sea, and usually consists of a ring freely moving on an axis, within which the object swings on an axis at right angles to the ring.

The word is derived from the O. Fr. *gemel*, from Lat. *gemellus*, diminutive of *geminus*, a twin, and appears also in *gimmel* or *jimbel* and as *gemel*, especially as a term for a ring formed of two hoops linked together and capable of separation, used in the 16th and 17th centuries as betrothal and keepsake rings. They sometimes were made of three or more hoops linked together.

GIMLET (from the O. Fr. *guimbelet*, probably a diminutive of the O.E. *wimble*, and the Scandinavian *wammle*, to bore or twist; the modern French is *giblet*), a tool used for boring small holes. It is made of steel, with a shaft having a hollow side, and a screw at the end for boring the wood; the handle of wood is fixed transversely to the shaft. A gimlet is always a small tool. A similar tool of large size is called an "auger" (see **TOOL**).

GIMLI, in Scandinavian mythology, the great hall of heaven whither the righteous will go to spend eternity.

GIMP, or **GIMP**. (1) (Of somewhat doubtful origin, but probably a nasal form of the Fr. *guipure*, from *guiper*, to cover or "whip" a cord over with silk), a stiff trimming made of silk or cotton woven around a firm cord, often further ornamented by a metal cord running through it. It is also sometimes covered with bugles, beads or other glistening ornaments. The

trimming employed by upholsterers to edge curtains, draperies, the seats of chairs, &c., is also called gimp; and in lace work it is the firmer or coarser thread which outlines the pattern and strengthens the material. (2) A shortened form of gimple (the O.E. *wimþle*), the kerchief worn by a nun around her throat, sometimes also applied to a nun's stomacher.

GIN, an aromatized or compounded potable spirit, the characteristic flavour of which is derived from the juniper berry. The word "gin" is an abbreviation of Geneva, both being primarily derived from the Fr. *genièvre* (juniper). The use of the juniper for flavouring alcoholic beverages may be traced to the invention, or perfecting, by Count de Morret, son of Henry IV. of France, of juniper wine. It was the custom in the early days of the spirit industry, in distilling spirit from fermented liquors, to add in the working some aromatic ingredients, such as ginger, grains of paradise, &c., to take off the nauseous flavour of the crude spirits then made. The invention of juniper wine, no doubt, led some one to try the juniper berry for this purpose, and as this flavouring agent was found not only to yield an agreeable beverage, but also to impart a valuable medicinal quality to the spirit, it was generally made use of by makers of aromatized spirits thereafter. It is probable that the use of grains of paradise, pepper and so on, in the early days of spirit manufacture, for the object mentioned above, indirectly gave rise to the statements which are still found in current textbooks and works of reference as to the use of Cayenne pepper, *cocculus indicus*, sulphuric acid and so on, for the purpose of adulterating spirits. It is quite certain that such materials are not used nowadays, and it would indeed, in view of modern conditions of manufacture and of public taste, be hard to find a reason for their use. The same applies to the suggestions that such substances as acetate of lead, alum or sulphate of zinc are employed for the fining of gin.

There are two distinct types of gin, namely, the Dutch *geneva* or *hollands* and the British gin. Each of these types exists in the shape of numerous sub-varieties. Broadly speaking, British gin is prepared with a highly rectified spirit, whereas in the manufacture of Dutch gin a preliminary rectification is not an integral part of the process. The old-fashioned Hollands is prepared much after the following fashion. A mash consisting of about one-third of malted barley or bere and two-thirds rye-mal is prepared, and infused at a somewhat high temperature. After cooling, the whole is set to ferment with a small quantity of yeast. After two to three days the attenuation is complete, and the wash so obtained is distilled, and the resulting distillate (the low wines) is redistilled, with the addition of the flavouring matter (juniper berries, &c.) and a little salt. Originally the juniper berries were ground with the malt, but this practice no longer obtains, but some distillers, it is believed, still mix the juniper berries with the wort and subject the whole to fermentation. When the redistillation over juniper is repeated, the product is termed *double (geneva, &c.)*. There are numerous variations in the process described, wheat being frequently employed in lieu of rye. In the manufacture of British gin, a highly rectified spirit (see **SPIRITS**) is redistilled in the presence of the flavouring matter (principally juniper and coriander), and frequently this operation is repeated several times. The product so obtained constitutes the "dry" gin of commerce. Sweetened or cordialized gin is obtained by adding sugar and

¹ The precise origin of the term "Old Tom," as applied to unsweetened gin, appears to be somewhat obscure. In the English case of *Boord & Son v. Huddart* (1903), in which the plaintiffs established their right to the "Cat Brand" trade-mark, it was proved before Mr Justice Swinton Eady that this firm had first adopted about 1849 the punning association of the picture of a Tom cat on a barrel with the name of "Old Tom"; and it was at one time supposed that this was due to a tradition that a cat had fallen into one of the vats, the gin from which was highly esteemed. But the term "Old Tom" had been known before that, and Messrs Boord & Son inform us that previously "Old Tom" had been a man, namely "old Thomas Chamberlain of Hodge's distillery"; an old label book in their possession (1909) shows a label and bill-head with a picture of "Old Tom" the man on it, and another label shows a picture of a sailor lad on shipboard described as "Young Tom."

flavouring matter (juniper, coriander, angelica, &c.) to the dry variety. Inferior qualities of gin are made by simply adding essential oils to plain spirit, the distillation process being omitted. The essential oil of juniper is a powerful diuretic, and gin is frequently prescribed in affections of the urinary organs.

GINDELY, ANTON (1829-1892), German historian, was the son of a German father and a Slavonic mother, and was born at Prague on the 3rd of September 1829. He studied at Prague and at Olmütz, and, after travelling extensively in search of historical material, became professor of history at the university of Prague and archivist for Bohemia in 1862. He died at Prague on the 24th of October 1892. Gindely's chief work is his *Geschichte des dreissigjährigen Kriegs* (Prague, 1869-1880), which has been translated into English (New York, 1884); and his historical work is mainly concerned with the period of the Thirty Years' War. Perhaps the most important of his numerous other works are: *Geschichte der böhmischen Brüder* (Prague, 1857-1858); *Rudolf II. und seine Zeit* (1862-1868), and a criticism of Wallenstein, *Waldstein während seines ersten Generalats* (1886). He wrote a history of Bethlen Gabor in Hungarian, and edited the *Monumenta historiae Bohemica*. Gindely's posthumous work, *Geschichte der Gegenreformation in Böhmen*, was edited by T. Tupetz (1864).

See the *Allgemeine deutsche Biographie*, Band 49 (Leipzig, 1904). **GINCALL**, or **JINGAL** (Hindustani *janjal*), a gun used by the natives throughout the East, usually a light piece mounted on a swivel; it sometimes takes the form of a heavy musket fired from a rest.

GINGER (Fr. *gingembre*, Ger. *Ingwer*), the rhizome or underground stem of *Zingiber officinale* (nat. ord. Zingiberaceae), a perennial reed-like plant growing from 3 to 4 ft. high. The flowers and leaves are borne on separate stems, those of the former being shorter than those of the latter, and averaging from 6 to 12 in. The flowers themselves are borne at the apex of the stems in dense ovate-oblong cone-like spikes from 2 to 3 in. long, composed of obtuse strongly-imbriated bracts with membranous margins, each bract enclosing a single small sessile flower. The leaves are alternate and arranged in two rows, bright green, smooth, tapering at both ends, with very short stalks and long sheaths which stand away from the stem and end in two small rounded auricles. The plant rarely flowers and the fruit is unknown. Though not found in a wild state, it is considered with very good reason to be a native of the warmer parts of Asia, over which it has been cultivated from an early period and the rhizome imported into England. From Asia the plant has spread into the West Indies, South America, western tropical Africa, and Australia. It is commonly grown in botanic gardens in Britain.

The use of ginger as a spice has been known from very early times; it was supposed by the Greeks and Romans to be a product of southern Arabia, and was received by them by way of the Red Sea; in India it has also been known from a very remote period, the Greek and Latin names being derived from the Sanskrit. Flückiger and Hanbury, in their *Pharmacographia*, give the following notes on the history of ginger. On the authority of Vincent's *Commerce and Navigation of the Ancients*, it is stated that in the list of imports from the Red Sea into Alexandria, which in the second century of our era were there liable to the Roman fiscal duty, ginger occurs among other Indian spices. So frequent is the mention of ginger in similar lists during the middle ages, that it evidently constituted an important item in the commerce between Europe and the East. It thus appears in the tariff of duties levied at Acre in Palestine about 1173, in that of Barcelona in 1221, Marseilles in 1228 and Paris in 1206. Ginger seems to have been well known in England even before the Norman Conquest, being often referred to in the Anglo-Saxon leech-books of the 11th century. It was very common in the 13th and 14th centuries, ranking next in value to pepper, which was then the commonest of all spices, and costing on an average about 1s. 7d. per lb. Three kinds of ginger were known among the merchants of Italy about the middle of the 14th century: (1) *Belledi* or *Baladi*, an Arabic

name, which, as applied to ginger, would signify country or wild, and denotes common ginger; (2) *Colombino*, which refers to Columbum, Kolan or Quilon, a port in Travancore, frequently mentioned in the middle ages; and (3) *Micchino*, a name which denoted that the spice had been brought from or by way of Mecca. Marco Polo seems to have seen the ginger plant both in India and China between 1280 and 1290. John of Montecorvino, a missionary friar who visited India about 1292, gives a description of the plant, and refers to the fact of the root being dug up and transported. Nicolo di Conto, a Venetian merchant in the early part of the 15th century, also describes the plant and the collection of the root, as seen by him in India. Though the Venetians received ginger by way of Egypt, some of the superior kinds were taken from India overland by the Black Sea. The spice is said to have been introduced into America

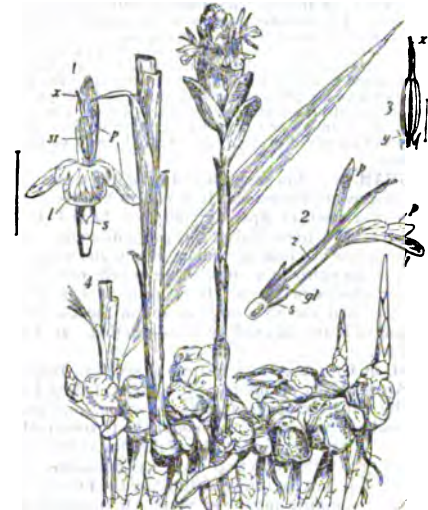

From Bentley & Trimen's *Medicinal Plants*, by permission of J & A. Churchill. Ginger (*Zingiber officinale*), about $\frac{1}{2}$ nat. size, with leafy and flowering stem; the former cut off short.

- | | |
|-----------------------------------|-------------------------------|
| 1. Flower. | 7. Labellum, representing two |
| 2. Flower in vertical section. | barren stamens. |
| 3. Fertile stamen, enveloping the | 8. Fertile stamen. |
| style which projects above it. | 9. Staminode. |
| 4. Piece of leafy stem. 1-3 | x. Tip of style bearing the |
| enlarged. | stigma. |
| 5. Sepals. | z. Style. |
| 6. Petals. | g. Honey-secreting glands. |

by Francisco de Mendoza, who took it from the East Indies to New Spain. It seems to have been shipped for commercial purposes from San Domingo as early as 1585, and from Barbados in 1654; so early as 1547 considerable quantities were sent from the West Indies to Spain.

Ginger is known in commerce in two distinct forms, termed respectively coated and uncoated ginger, as having or wanting the epidermis. For the first, the pieces, which are called "races" or "hands," from their irregular palmate form, are washed and simply dried in the sun. In this form ginger presents a brown, more or less irregularly wrinkled or striated surface, and when broken shows a dark brownish fracture, hard, and sometimes horny and resinous. To produce uncoated ginger the rhizomes are washed, scraped and sun-dried, and are often subjected to a system of bleaching, either from the fumes of burning sulphur or by immersion for a short time in a solution of chlorinated lime. The whitewashed appearance that much of the ginger has, as seen in the shops, is due to the fact of its being washed in whiting and water, or even coated with sulphate of

lime. This artificial coating is supposed by some to give the ginger a better appearance; it often, however, covers an inferior quality, and can readily be detected by the ease with which it rubs off, or by its leaving a white powdery substance at the bottom of the jar in which it is contained. Uncoated ginger, as seen in trade, varies from single joints an inch or less in length to flattish irregularly branched pieces of several joints, the "races" or "hands," and from 3 to 4 in. long; each branch has a depression at its summit showing the former attachment of a leafy stem. The colour, when not whitewashed, is a pale buff; it is somewhat rough or fibrous, breaking with a short mealy fracture, and presenting on the surfaces of the broken parts numerous short bristly fibres.

The principal constituents of ginger are starch, volatile oil (to which the characteristic odour of the spice is due) and resin (to which is attributed its pungency). Its chief use is as a condiment or spice, but as an aromatic and stomachic medicine it is also used internally. "The stimulant, aromatic and carminative properties render it of much value in atonic dyspepsia, especially if accompanied with much flatulence, and as an adjunct to purgative medicines to correct griping." Externally applied as a rubefacient, it has been found to relieve headache and toothache. The rhizomes, collected in a young green state, washed, scraped and preserved in syrup, form a delicious preserve, which is largely exported both from the West Indies and from China. Cut up into pieces like lozenges and preserved in sugar, ginger also forms a very agreeable sweetmeat.

GINGHAM, a cotton or linen cloth, for the name of which several origins are suggested. It is said to have been made at Guingamp, a town in Brittany; the *New English Dictionary* derives the word from Malay *ging-gang*, meaning "striped." The cloth is now of a light or medium weight, and woven of dyed or white yarns either in a single colour or different colours, and in stripes, checks or plaids. It is made in Lancashire and in Glasgow, and also to a large extent in the United States. Imitations of it are obtained by calico-printing. It is used for dresses, &c.

GINGI, or **GINGEE**, a rock fortress of southern India, in the South Arcot district of Madras. It consists of three hills, connected by walls enclosing an area of 7 sq. m., and practically impregnable to assault. The origin of the fortress is shrouded in legend. When occupied by the Mahrattas at the end of the 17th century, it withstood a siege of eight years against the armies of Aurangzeb. In 1750 it was captured by the French, who held it with a strong force for eleven years. It surrendered to the English in 1761, in the words of Orme, "terminated the long hostilities between the two rival European powers in Coromandel, and left not a single ensign of the French nation avowed by the authority of its government in any part of India."

GINGUENÉ, PIERRE LOUIS (1748-1815), French author, was born on the 27th of April 1748 at Rennes, in Brittany. He was educated at a Jesuit college in his native town, and came to Paris in 1772. He wrote criticisms for the *Mercure de France*, and composed a comic opera, *Pomponin* (1777). The *Satire des satires* (1778) and the *Confession de Zulmé* (1779) followed. The *Confession* was claimed by six or seven different authors, and though the value of the piece is not very great, it obtained great success. His defence of Piccini against the partisans of Gluck made him still more widely known. He hailed the first symptoms of the Revolution, joined Giuseppe Cerutti, the author of the *Mémoire pour le peuple français* (1788), and others in producing the *Feuille villageoise*, a weekly paper addressed to the villages of France. He also celebrated in an indifferent ode the opening of the states-general. In his *Lettres sur les confessions de J.-J. Rousseau* (1791) he defended the life and principles of his author. He was imprisoned during the Terror, and only escaped with life by the downfall of Robespierre. Some time after his release he assisted, as director-general of the "commission exécutive de l'instruction publique," in reorganizing the system of public instruction, and he was an original member of the Institute of France. In 1797 the directory appointed him minister plenipotentiary to the king of Sardinia. After fulfilling his duties for seven months, very little to the satisfaction of his employers, Ginguéné retired for a time to his country house of St Prix, in

the valley of Montmorency. He was appointed a member of the tribunate, but Napoleon, finding that he was not sufficiently tractable, had him expelled at the first "purge," and Ginguéné returned to his literary pursuits. He was one of the commission charged to continue the *Histoire littéraire de la France*, and he contributed to the volumes of this series which appeared in 1814, 1817 and 1820. Ginguéné's most important work is the *Histoire littéraire d'Italie* (14 vols., 1811-1835). He was putting the finishing touches to the eighth and ninth volumes when he died on the 11th of November 1815. The last five volumes were written by Francesco Salfi and revised by Pierre Daunou.

In the composition of his history of Italian literature he was guided for the most part by the great work of Girolamo Tiraboschi, but he avoids the prejudices and party views of his model.

Ginguéné edited the *Décade philosophique, politique et littéraire* till it was suppressed by Napoleon in 1807. He contributed largely to the *Biographie universelle*, the *Mercure de France* and the *Encyclopédie méthodique*; and he edited the works of Chamfort and of Lebrun. Among his minor productions are an opera, *Pomponin ou le liseur mystifié* (1777); *La Satire des satires* (1778); *De l'autorité de Rabelais dans la révolution présente* (1791); *De M. Noëkar* (1795); *Fables nouvelles* (1810); *Fables inédites* (1814). See "Eloge de Ginguéné" by Dacier, in the *Mémoires de l'institut*, tom. vii.; "Discours" by M. Daunou, prefixed to the 2nd ed. of the *Hist. litt. d'Italie*; J. D. J. Garat, *Notice sur la vie et les ouvrages de P. L. Ginguéné*, prefixed to a catalogue of his library (Paris, 1817).

GINKEL, GODART VAN (1630-1703), 1st earl of Athlone, Dutch general in the service of England, was born at Utrecht in 1630. He came of a noble family, and bore the title of Baron van Reede, being the eldest son of Godart Adrian van Reede, Baron Ginkel. In his youth he entered the Dutch army, and in 1688 he followed William, prince of Orange, in his expedition to England. In the following year he distinguished himself by a memorable exploit—the pursuit, defeat and capture of a Scottish regiment which had terminated at Ipswich, and was marching northward across the fens. It was the alarm excited by this mutiny that facilitated the passing of the first Mutiny Act. In 1690 Ginkel accompanied William III. to Ireland, and commanded a body of Dutch cavalry at the battle of the Boyne. On the king's return to England General Ginkel was entrusted with the conduct of the war. He took the field in the spring of 1691, and established his headquarters at Mullingar. Among those who held a command under him was the marquis of Ruvigny, the recognized chief of the Huguenot refugees. Early in June Ginkel took the fortress of Ballymore, capturing the whole garrison of 1000 men. The English lost only 8 men. After reconstructing the fortifications of Ballymore the army marched to Athlone, then one of the most important of the fortified towns of Ireland. The Irish defenders of the place were commanded by a distinguished French general, Saint-Ruth. The firing began on June 19th, and on the 30th the town was stormed, the Irish army retreating towards Galway, and taking up their position at Aughrim. Having strengthened the fortifications of Athlone and left a garrison there, Ginkel led the English, on July 12th, to Aughrim. An immediate attack was resolved on, and, after a severe and at one time doubtful contest, the crisis was precipitated by the fall of Saint-Ruth, and the disorganized Irish were defeated and fled. A horrible slaughter of the Irish followed the struggle, and 4000 corpses were left unburied on the field, besides a multitude of others that lay along the line of the retreat. Galway next capitulated, its garrison being permitted to retire to Limerick. There the viceroy Tyrconnel was in command of a large force, but his sudden death early in August left the command in the hands of General Sarsfield and the Frenchman D'Usson. The English came in sight of the town on the day of Tyrconnel's death, and the bombardment was immediately begun. Ginkel, by a bold device, crossed the Shannon and captured the camp of the Irish cavalry. A few days later he stormed the fort on Thomond Bridge, and after difficult negotiations a capitulation was signed, the terms of which were divided into a civil and a military treaty. Thus was completed the conquest or pacification of Ireland, and the services of the Dutch general were amply recognized and rewarded. He received the formal thanks of the House of Commons, and was

created by the king 1st earl of Athlone and baron of Aughrim. The immense forfeited estates of the earl of Limerick were given to him, but the grant was a few years later revoked by the English parliament. The earl continued to serve in the English army, and accompanied the king to the continent in 1693. He fought at the sieges of Namur and the battle of Neerwinden, and assisted in destroying the French magazine at Givet. In 1702, waiving his own claims to the position of commander-in-chief, he commanded the Dutch serving under the duke of Marlborough. He died at Utrecht on the 11th of February 1703, and was succeeded by his son the 2nd earl (1668-1719), a distinguished soldier in the reigns of William III. and Anne. On the death of the 9th earl without issue in 1844, the title became extinct.

GINSBURG, CHRISTIAN DAVID (1831-), Hebrew scholar, was born at Warsaw on the 25th of December 1831. Coming to England shortly after the completion of his education in the Rabbinic College at Warsaw, Dr Ginsburg continued his study of the Hebrew Scriptures, with special attention to the Megilloth. The first result of these studies was a translation of the Song of Songs, with a commentary historical and critical, published in 1857. A similar translation of Ecclesiastes, followed by treatises on the Karaites, on the Esenes and on the Kabbala, kept the author prominently before biblical students while he was preparing the first sections of his *magnus opus*, the critical study of the Massorah. Beginning in 1867 with the publication of Jacob ben Chajim's Introduction to the Rabbinic Bible, Hebrew and English, with notices, and the Massoreth Ha-Massoreth of Elias Levita, in Hebrew, with translation and commentary, Dr Ginsburg took rank as an eminent Hebrew scholar. In 1870 he was appointed one of the first members of the committee for the revision of the English version of the Old Testament. His life-work culminated in the publication of the Massorah, in three volumes folio (1880-1886), followed by the Masoretico-critical edition of the Hebrew Bible (1894), and the elaborate introduction to it (1897). Dr Ginsburg had one predecessor in the field, the learned Jacob ben Chajim, who in 1524-1525 published the second Rabbinic Bible, containing what has ever since been known as the Massorah; but neither were the materials available nor was criticism sufficiently advanced for a complete edition. Dr Ginsburg took up the subject almost where it was left by those early pioneers, and collected portions of the Massorah from the countless MSS. scattered throughout Europe and the East. More recently Dr Ginsburg has published *Facsimiles of Manuscripts of the Hebrew Bible* (1897 and 1898), and *The Text of the Hebrew Bible in Abbreviations* (1903), in addition to a critical treatise "on the relationship of the so-called Codex Babylonius of A.D. 916 to the Eastern Recension of the Hebrew Text" (1899, for private circulation). In the last-mentioned work he seeks to prove that the St Petersburg Codex, for so many years accepted as the genuine text of the Babylonian school, is in reality a Palestinian text carefully altered so as to render it conformable to the Babylonian recension. He subsequently undertook the preparation of a new edition of the Hebrew Bible for the British and Foreign Bible Society. He also contributed many articles to J. Kitto's *Encyclopaedia*, W. Smith's *Dictionary of Christian Biography* and the *Encyclopaedia Britannica*.

GINSENG, the root of a species of *Panax* (*P. Ginseng*), native of Manchuria and Korea, belonging to the natural order Araliaceae, used in China as a medicine. Other roots are substituted for it, notably that of *Panax quinquefolium*, distinguished as American ginseng, and imported from the United States. At one time the ginseng obtained from Manchuria was considered to be the finest quality, and in consequence became so scarce that an imperial edict was issued prohibiting its collection. That prepared in Korea is now the most esteemed variety. The root of the wild plant is preferred to that of cultivated ginseng, and the older the plant the better is the quality of the root considered to be. Great care is taken in the preparation of the drug. The account given by Koempfer of the preparation of nindsin, the root of *Sium ninsi*, in Korea, will give a good idea of the preparation of ginseng, ninsi being a similar drug of supposed weaker

virtue, obtained from a different plant, and often confounded with ginseng. "In the beginning of winter nearly all the population of Sjansai turn out to collect the root, and make preparations for sleeping in the fields. The root, when collected, is macerated for three days in fresh water, or water in which rice has been boiled twice; it is then suspended in a closed vessel over the fire, and afterwards dried, until from the base to the middle it assumes a hard, resinous and translucent appearance, which is considered a proof of its good quality."

Ginseng of good quality generally occurs in hard, rather brittle, translucent pieces, about the size of the little finger, and varying in length from 2 to 4 in. The taste is mucilaginous, sweetish and slightly bitter and aromatic. The root is frequently forked, and it is probably owing to this circumstance that medicinal properties were in the first place attributed to it, its resemblance to the body of a man being supposed to indicate that it could restore virile power to the aged and impotent. In price it varies from 6 or 12 dollars to the enormous sum of 300 or 400 dollars an ounce.

Lockhart gives a graphic description of a visit to a ginseng merchant. Opening the outer box, the merchant removed several paper parcels which appeared to fill the box, but under them was a second box, or perhaps two small boxes, which, when taken out, showed the bottom of the large box and all the intervening space filled with more paper parcels. These parcels, he said, "contained quicklime, for the purpose of absorbing any moisture and keeping the boxes quite dry, the lime being packed in paper for the sake of cleanliness. The smaller box, which held the ginseng, was lined with sheet-lead; the ginseng further enclosed in silk wrappers was kept in little silken-covered boxes. Taking up a piece, he would request his visitor not to breathe upon it, nor handle it; he would dilate upon the many merits of the drug and the cures it had effected. The cover of the root, according to its quality, was silk, either embroidered or plain, cotton cloth or paper." In China the ginseng is often sent to friends as a valuable present; in such cases, "accompanying the medicine is usually given a small, beautifully-finished double kettle, in which the ginseng is prepared as follows. The inner kettle is made of silver, and between this and the outside vessel, which is a copper jacket, is a small space for holding water. The silver kettle, which fits on a ring near the top of the outer covering, has a cup-like cover in which rice is placed with a little water; the ginseng is put in the inner vessel with water, a cover is placed over the whole, and the apparatus is put on the fire. When the rice in the cover is sufficiently cooked, the medicine is ready, and is then eaten by the patient, who drinks the ginseng tea at the same time." The dose of the root is from 60 to 90 grains. During the use of the drug tea-drinking is forbidden for at least a month, but no other change is made in the diet. It is taken in the morning before breakfast, from three to eight days together, and sometimes it is taken in the evening before going to bed.

The action of the drug appears to be entirely psychic, and comparable to that of the mandrakes of the Hebrews. There is no evidence that it possesses any pharmacological or therapeutic properties.

See Porter Smith, *Chinese Materia Medica*, p. 103; *Reports on Trade at the Treaty Ports of China* (1868), p. 63; Lockhart, *Med. Missionary in China* (2nd ed.), p. 107; *Bull. de la Société Impériale de Nat. de Moscou* (1865), No. 1, pp. 70-76; *Pharmaceutical Journal* (2), vol. iii. pp. 197, 333, (2), vol. ix. p. 77; Lewis, *Materia Medica*, p. 324; Geoffroy, *Tract. de matiere medicale*, t. ii. p. 112; Koempfer, *Amoenitates exoticae*, p. 824.

GIOBERTI, VINCENZO (1801-1852), Italian philosopher, publicist and politician, was born in Turin on the 5th of April 1801. He was educated by the fathers of the Oratory with a view to the priesthood and ordained in 1825. At first he led a very retired life; but gradually took more and more interest in the affairs of his country and the new political ideas as well as in the literature of the day. Partly under the influence of Mazzini, the freedom of Italy became his ruling motive in life,—its emancipation, not only from foreign masters, but from modes of thought alien to its genius, and detrimental to its European authority. This authority was in his mind connected with papal supremacy, though in a way quite novel—intellectual rather than political. This must be remembered in considering nearly all his writings, and also in estimating his position, both in relation to the ruling clerical party—the Jesuits—and also to the politics of the court of Piedmont after the accession of Charles Albert in 1831. He was now noticed by the king and made one of his chaplains. His popularity and private influence, however, were reasons enough for the court party to mark him

for exile; he was not one of them, and could not be depended on. Knowing this, he resigned his office in 1833, but was suddenly arrested on a charge of conspiracy, and, after an imprisonment of four months, was banished without a trial. Gioberti first went to Paris, and, a year later, to Brussels, where he remained till 1845, teaching philosophy, and assisting a friend in the work of a private school. He nevertheless found time to write many works of philosophical importance, with special reference to his country and its position. An amnesty having been declared by Charles Albert in 1846, Gioberti (who was again in Paris) was at liberty to return to Italy, but refused to do so till the end of 1847. On his entrance into Turin on the 29th of April 1848 he was received with the greatest enthusiasm. He refused the dignity of senator offered him by Charles Albert, preferring to represent his native town in the Chamber of Deputies, of which he was soon elected president. At the close of the same year, a new ministry was formed, headed by Gioberti; but with the accession of Victor Emmanuel in March 1849, his active life came to an end. For a short time indeed he held a seat in the cabinet, though without a portfolio; but an irreconcilable disagreement soon followed, and his removal from Turin was accomplished by his appointment on a mission to Paris, whence he never returned. There, refusing the pension which had been offered him and all ecclesiastical preference, he lived frugally, and spent his days and nights as at Brussels in literary labour. He died suddenly, of apoplexy, on the 26th of October 1852.

Gioberti's writings are more important than his political career. In the general history of European philosophy they stand apart. As the speculations of Rosmini-Serbati, against which he wrote, have been called the last link added to medieval thought, so the system of Gioberti, known as "Ontologism," more especially in his greater and earlier works, is unrelated to other modern schools of thought. It shows a harmony with the Roman Catholic faith which caused Cousin to declare that "Italian philosophy was still in the bonds of theology," and that Gioberti was no philosopher. Method is with him a synthetic, subjective and psychological instrument. He reconstructs, as he declares, ontology, and begins with the "ideal formula," "the *Ens* creates *ex nihilo* the existent." God is the only being (*Ens*); all other things are merely existences. God is the origin of all human knowledge (called *idea*, thought), which is one and so to say identical with God himself. It is directly beheld (intuited) by reason, but in order to be of use it has to be reflected on, and this by means of language. A knowledge of being and existences (concrete, not abstract) and their mutual relations, is necessary as the beginning of philosophy. Gioberti is in some respects a Platonist. He identifies religion with civilization, and in his treatise *Del primato morale e civile degli Italiani* arrives at the conclusion that the church is the axis on which the well-being of human life revolves. In it he affirms the idea of the supremacy of Italy, brought about by the restoration of the papacy as a moral dominion, founded on religion and public opinion. In his later works, the *Rinnovamento* and the *Protologia*, he is thought by some to have shifted his ground under the influence of events. His first work, written when he was thirty-seven, had a personal reason for its existence. A young fellow-exile and friend, Paolo Pallia, having many doubts and misgivings as to the reality of revelation and a future life, Gioberti at once set to work with *La Teoria del sovrannaturale*, which was his first publication (1838). After this, philosophical treatises followed in rapid succession. The *Teoria* was followed by *Introduzione allo studio della filosofia* in three volumes (1839-1840). In this work he states his reasons for requiring a new method and new terminology. Here he brings out the doctrine that religion is the direct expression of the *idea* in this life, and is one with true civilization in history. Civilization is a conditioned mediate tendency to perfection, to which religion is the final completion if carried out; it is the end of the second cycle expressed by the second formula, the *Ens* redeems existences. Essays (not published till 1846) on the lighter and more popular subjects, *Del bello* and *Del buono*, followed the *Introduzione*. *Del primato morale e civile degli Italiani*; and the *Prolegomeni* to the same, and soon afterwards his triumphant exposure of the Jesuits, *Il Gesuita moderno*, no doubt hastened the transfer of rule from clerical to civil hands. It was the popularity of these semi-political works, increased by other occasional political articles, and his *Rinnovamento civile d'Italia*, that caused Gioberti to be welcomed with such enthusiasm on his return to his native country. All these works were perfectly orthodox, and aided in drawing the liberal clergy into the movement which has resulted since his time in the unification of Italy. The Jesuits, however, closed round the pope more firmly after his return to Rome, and in the end Gioberti's writings were placed on the *Index* (see J. Kleutgen, *Über die Vernichtung des Ontologismus durch den heiligen Stuhl*, 1867). The remainder of his works, especially *La Filosofia della Rivelazione* and the *Protologia*, give his mature

views on many points. The entire writings of Gioberti, including those left in manuscript, have been edited by Giuseppe Massari (Turin, 1856-1861).

See Massari, *Vita de V. Gioberti* (Florence, 1848); A. Rosmini-Serbati, *V. Gioberti e il panesimo* (Milan, 1848); C. B. Smyth, *Christian Metaphysics* (1851); B. Spaventa, *La Filosofia di Gioberti* (Naples, 1854); A. Mauri, *Della vita e delle opere di V. Gioberti* (Genoa, 1853); G. Prisco, *Gioberti e l'ontologismo* (Naples, 1867); P. Luciani, *Gioberti e la filosofia nuova italiana* (Naples, 1866-1872); D. Berti, *Di V. Gioberti* (Florence, 1881); see also L. Ferri, *L'Histoire de la philosophie en Italie au XIX^e siècle* (Paris, 1869); C. Werner, *Die italienische Philosophie des 19. Jahrhunderts*, ii. (1885); appendix to Ueberweg's *Hist. of Philosophy* (Eng. tr.); art. in *Brownson's Quarterly Review* (Boston, Mass.), xxi.; R. Mariano, *La Philosophie contemporaine en Italie* (1866); R. Seydel's exhaustive article in Ersch and Gruber's *Allgemeine Encyclopädie*. The centenary of Gioberti called forth several monographs in Italy.

GIOIOSA-IONICA, a town of Calabria, Italy, in the province of Reggio Calabria, from which it is 65 m. N.E. by rail, and 38 m. direct, 492 ft. above sea-level. Pop. (1901) town, 9072; commune, 11,200. Near the station, which is on the E. coast of Calabria 3 m. below the town to the S.E., the remains of a theatre belonging to the Roman period were discovered in 1883; the orchestra was 46 ft. in diameter (*Notizie degli scavi*, 1883, p. 423). The ruins of an ancient building called the Naviglio, the nature of which does not seem clear, are described (*ib.* 1884, p. 252).

GIOJA, MELCHIORRE (1767-1829), Italian writer on philosophy and political economy, was born at Piacenza, on the 20th of September 1767. Originally intended for the church, he took orders, but renounced them in 1796 and went to Milan, where he devoted himself to the study of political economy. Having obtained the prize for an essay on "the kind of free government best adapted to Italy" he decided upon the career of a publicist. The arrival of Napoleon in Italy drew him into public life. He advocated a republic under the dominion of the French in a pamphlet *I Tedeschi, i Francesi, ed i Russi in Lombardia*, and under the Cisalpine Republic he was named historiographer and director of statistics. He was several times imprisoned, once for eight months in 1820 on a charge of being implicated in a conspiracy with the Carbonari. After the fall of Napoleon he retired into private life, and does not appear to have held office again. He died on the 2nd of January 1829. Gioja's fundamental idea is the value of statistics or the collection of facts. Philosophy itself is with him classification and consideration of ideas. Logic he regarded as a practical art, and his *Esercizi logici* has the further title, *Art of deriving benefit from ill-constructed books*. In ethics Gioja follows Bentham generally, and his large treatise *Del merito e delle recompense* (1818) is a clear and systematic view of social ethics from the utilitarian principle. In political economy this avidity for facts produced better fruits. The *Nuovo Prospetto delle scienze economiche* (1815-1817), although long to excess, and overburdened with classifications and tables, contains much valuable material. The author prefers large properties and large commercial undertakings to small ones, and strongly favours association as a means of production. He defends a restrictive policy and insists on the necessity of the action of the state as a regulating power in the industrial world. He was an opponent of ecclesiastical domination. He must be credited with the finest and most original treatment of division of labour since the *Wealth of Nations*. Much of what Babbage taught later on the subject of combined work is anticipated by Gioja. His theory of production is also deserving of attention from the fact that it takes into account and gives due prominence to immaterial goods. Throughout the work there is continuous opposition to Adam Smith. Gioja's latest work *Filosofia della statistica* (2 vols., 1826; 4 vols., 1829-1830) contains in brief compass the essence of his ideas on human life, and affords the clearest insight into his aim and method in philosophy both theoretical and practical.

See monographs by G. D. Romagnosi (1829), F. Falco (1866); G. Pecchio, *Storia dell'economia pubblica in Italia* (1829), and article in Ersch and Gruber's *Allgemeine Encyclopädie*; for Gioja's philosophy, L. Ferri, *Essai sur l'histoire de la philosophie en Italie au XIX^e siècle* (1866); Ueberweg's *Hist. of Philosophy* (Eng. tr., appendix ii.); A. Rosmini-Serbati, *Opuscoli filosofici*, iii. (1844) (containing an attack on Gioja's "sensualism"); for his political

economy, list of works in J. Conrad's *Handwörterbuch der Staatswissenschaften* (1892); L. Cozza, *Introd. to Pol. Econ.* (Eng. trans., p. 488). Gioja's complete works were published at Lugano (1832-1849). He was one of the founders of the *Annali universali di statistica*.

GIOLITTI, GIOVANNI (1842-), Italian statesman, was born at Mondovì on the 27th of October 1842. After a rapid career in the financial administration he was, in 1882, appointed councillor of state and elected to parliament. As deputy he chiefly acquired prominence by attacks on Magliani, treasury minister in the Depretis cabinet, and on the 9th of March 1889 was himself selected as treasury minister by Crispi. On the fall of the Rudini cabinet in May 1892, Giolitti, with the help of a court clique, succeeded to the premiership. His term of office was marked by misfortune and misgovernment. The building crisis and the commercial rupture with France had impaired the situation of the state banks, of which one, the Banca Romana, had been further undermined by maladministration. A bank law, passed by Giolitti failed to effect an improvement. Moreover, he irritated public opinion by raising to senatorial rank the director-general of the Banca Romana, Signor Tanlongo, whose irregular practices had become a byword. The senate declined to admit Tanlongo, whom Giolitti, in consequence of an interpellation in parliament upon the condition of the Banca Romana, was obliged to arrest and prosecute. During the prosecution Giolitti abused his position as premier to abstract documents bearing on the case. Simultaneously a parliamentary commission of inquiry investigated the condition of the state banks. Its report, though acquitting Giolitti of personal dishonesty, proved disastrous to his political position, and obliged him to resign. His fall left the finances of the state disorganized, the pensions fund depleted, diplomatic relations with France strained in consequence of the massacre of Italian workmen at Aigues-Mortes, and Sicily and the Lunigiana in a state of revolt, which he had proved impotent to suppress. After his resignation he was impeached for abuse of power as minister, but the supreme court quashed the impeachment by denying the competence of the ordinary tribunals to judge ministerial acts. For several years he was compelled to play a passive part, having lost all credit. But by keeping in the background and giving public opinion time to forget his past, as well as by parliamentary intrigue, he gradually regained much of his former influence. He made capital of the Socialist agitation and of the repression to which other statesmen resorted, and gave the agitators to understand that were he premier they would be allowed a free hand. Thus he gained their favour, and on the fall of the Pelloux cabinet he became minister of the Interior in Zanardelli's administration, of which he was the real head. His policy of never interfering in strikes and leaving even violent demonstrations undisturbed at first proved successful, but indiscipline and disorder grew to such a pitch that Zanardelli, already in bad health, resigned, and Giolitti succeeded him as prime minister (November 1903). But during his tenure of office he, too, had to resort to strong measures in repressing some serious disorders in various parts of Italy, and thus he lost the favour of the Socialists. In March 1905, feeling himself no longer secure, he resigned, indicating Fortis as his successor. When Sonnino became premier in February 1906, Giolitti did not openly oppose him, but his followers did, and Sonnino was defeated in May, Giolitti becoming prime minister once more.

GIORDANO, LUCA (1632-1705), Italian painter, was born in Naples, son of a very indifferent painter, Antonio, who imparted to him the first rudiments of drawing. Nature predestined him for the art, and at the age of eight he painted a cherub into one of his father's pictures, a feat which was at once noised abroad, and induced the viceroy of Naples to recommend the child to Ribera. His father afterwards took him to Rome, to study under Pietro da Cortona. He acquired the nickname of Luca Fa-presto (Luke Work-fast). One might suppose this nickname to be derived merely from the almost miraculous celerity with which from an early age and throughout his life he handled the brush; but it is said to have had a more express origin. The father, we are told, poverty-stricken and greedy of gain, was perpetually

urging his boy to exertion with the phrase, "Luca, fa presto." The youth obeyed his parent to the letter, and would actually not so much as pause to snatch a hasty meal, but received into his mouth, while he still worked on, the food which his father's hand supplied. He copied nearly twenty times the "Battle of Constantine" by Julio Romano, and with proportionate frequency several of the great works of Raphael and Michelangelo. His rapidity, which belonged as much to invention as to mere hand-work, and his versatility, which enabled him to imitate other painters deceptively, earned for him two other epithets, "The Thunderbolt" (Fulmine), and "The Proteus," of Painting. He shortly visited all the main seats of the Italian school of art, and formed for himself a style combining in a certain measure the ornamental pomp of Paul Veronese and the contrasting compositions and large schemes of chiaroscuro of Pietro da Cortona. He was noted also for lively and showy colour. Returning to Naples, and accepting every sort of commission by which money was to be made, he practised his art with so much applause that Charles II. of Spain towards 1687 invited him over to Madrid, where he remained thirteen years. Giordano was very popular at the Spanish court, being a sprightly talker along with his other marvellously facile gifts, and the king created him a cavalier. One anecdote of his rapidity of work is that the queen of Spain having one day made some inquiry about his wife, he at once showed Her Majesty what the lady was like by painting her portrait into the picture on which he was engaged. Soon after the death of Charles in 1700 Giordano, gorged with wealth, returned to Naples. He spent large sums in acts of munificence, and was particularly liberal to his poorer brethren of the art. He again visited various parts of Italy, and died in Naples on the 12th of January 1705, his last words being "O Napoli, sospiro mio" (O Naples, my heart's love!). One of his maxims was that the good painter is the one whom the public like, and that the public are attracted more by colour than by design.

Giordano had an astonishing readiness and facility, in spite of the general commonness and superficiality of his performances. He left many works in Rome, and far more in Naples. Of the latter one of the most renowned is "Christ expelling the Traders from the Temple," in the church of the Padri Girolamini, a colossal work, full of expressive lazzaroni; also the frescoes of S. Martino, and those in the Tesoro della Certosa, including the subject of "Moses and the Brazen Serpent"; and the cupola-paintings in the Church of S. Brigida, which contains the artist's own tomb. In Spain he executed a surprising number of works, —continuing in the Escorial the series commenced by Cambiasi, and painting frescoes of the "Triumphs of the Church," the "Genealogy and Life of the Madonna," the stories of Moses, Gideon, David and Solomon, and the "Celebrated Women of Scripture," all works of large dimensions. His pupils, Aniello Rossi and Matteo Pacelli, assisted him in Spain. In Madrid he worked more in oil-colour, a Nativity there being one of his best productions. Other superior examples are the "Judgment of Paris" in the Berlin Museum, and "Christ with the Doctors in the Temple," in the Corsini Gallery of Rome. In Florence, in his closing days, he painted the Cappella Corsini, the Galleria Riccardi and other works. In youth he etched with considerable skill some of his own paintings, such as the "Slaughter of the Priests of Baal." He also painted much on the crystal borderings of looking-glasses, cabinets, &c., seen in many Italian palaces, and was, in this form of art, the master of Pietro Garofolo. His best pupil, in painting of the ordinary kind, was Paolo de Matteis.

Bellori, in his *Vite de' pittori moderni*, is a leading authority regarding Luca Giordano. P. Benvenuto (1882) has written a work on the Riccardi paintings.

GIORGIONE (1477-1510), Italian painter, was born at Castelfranco in 1477. In contemporary documents he is always called (according to the Venetian manner of pronunciation and spelling) Zorzi, Zorzo or Zorzon of Castelfranco. A tradition, having its origin in the 17th century, represented him as the natural son of some member of the great local family of the Barbarelli, by a peasant girl of the neighbouring village of Veduggio; consequently he is commonly referred to in histories and

catalogues under the name of Giorgio Barbarelli or Barbarella. This tradition has, however, on close examination been proved baseless. On the other hand mention has been found in a contemporary document of an earlier Zorzon, a native of Vedelago, living in Castelfranco in 1460. Vasari, who wrote before the Barbarella legend had sprung up, says that Giorgione was of very humble origin. It seems probable that he was simply the son or grandson of the afore-mentioned Zorzon the elder; that the after-claim of the Barbarelli to kindred with him was a mere piece of family vanity, very likely suggested by the analogous case of Leonardo da Vinci; and that, this claim once put abroad, the peasant-mother of Vedelago was invented on the ground of some dim knowledge that his real progenitors came from that village.

Of the facts of his life we are almost as meagrely informed as of the circumstances of his birth. The little city, or large fortified village, for it is scarcely more, of Castelfranco in the Trevisan stands in the midst of a rich and broken plain at some distance from the last spurs of the Venetian Alps. From the natural surroundings of Giorgione's childhood was no doubt derived his ideal of pastoral scenery, the country of pleasant copses, glades, brooks and hills amid which his personages love to wander or recline with lute and pipe. How early in boyhood he went to Venice we do not know, but internal evidence supports the statement of Ridolfi that he served his apprenticeship there under Giovanni Bellini; and there he made his fame and had his home. That his gifts were early recognized we know from the facts, recorded in contemporary documents, that in 1500, when he was only twenty-three (that is if Vasari gives rightly the age at which he died), he was chosen to paint portraits of the Doge Agostino Barberigo and the condottiere Consalvo Ferrante; that in 1504 he was commissioned to paint an altarpiece in memory of Matteo Costanzo in the cathedral of his native town, Castelfranco; that in 1507 he received at the order of the Council of Ten part payment for a picture (subject not mentioned) on which he was engaged for the Hall of the Audience in the ducal palace; and that in 1507-1508 he was employed, with other artists of his own generation, to decorate with frescoes the exterior of the newly rebuilt Fondaco dei Tedeschi or German merchants' hall at Venice, having already done similar work on the exterior of the Casa Soranzo, the Casa Grimani alli Servi and other Venetian palaces. Vasari gives also as an important event in Giorgione's life, and one which had influence on his work, his meeting with Leonardo da Vinci on the occasion of the Tuscan master's visit to Venice in 1500. In September or October 1510 he died of the plague then raging in the city, and within a few days of his death we find the great art-patroness and amateur, Isabella d'Este, writing from Mantua and trying in vain to secure for her collection a night-picce by his hand of which the fame had reached her.

All accounts agree in representing Giorgione as a personage of distinguished and romantic charm, a great lover, a great musician, made to enjoy in life and to express in art to the uttermost the delight, the splendour, the sensuous and imaginative grace and fulness, not untinged with poetic melancholy, of the Venetian existence of his time. They represent him further as having made in Venetian painting an advance analogous to that made in Tuscan painting by Leonardo more than twenty years before; that is as having released the art from the last shackles of archaic rigidity and placed it in possession of full freedom and the full mastery of its means. He also introduced a new range of subjects. Besides altarpieces and portraits he painted pictures that told no story, whether biblical or classical, or if they professed to tell such, neglected the action and simply embodied in form and colour moods of lyrical or romantic feeling, much as a musician might embody them in sounds. Innovating with the courage and felicity of genius, he had for a time an overwhelming influence on his contemporaries and immediate successors in the Venetian school, including Titian, Sebastiano del Piombo, the elder Palma, Cariani and the two Campagnolas, and not a little even on seniors of long-standing fame such as Giovanni Bellini. His name and work have

exercised, and continue to exercise, no less a spell on posterity. But to identify and define, among the relics of his age and school, precisely what that work is, and to distinguish it from the kindred work of other men whom his influence inspired, is a very difficult matter. There are inclusive critics who still claim for Giorgione nearly every painting of the time that at all resembles his manner, and there are exclusive critics who pare down to some ten or a dozen the list of extant pictures which they will admit to be actually his.

To name first those which are either certain or command the most general acceptance, placing them in something like an approximate and probable order of date. In the Uffizi at Florence are two companion pieces of the "Trial of Moses" and the "Judgment of Solomon," the latter the finer and better preserved of the two, which pass, no doubt justly, as typical works of Giorgione's youth, and exhibit, though not yet ripely, his special qualities of colour-richness and landscape romance, the peculiar facial types of his predilection, with the pure form of forehead, fine oval of cheek, and somewhat close-set eyes and eyebrows, and the intensity of that still and brooding sentiment with which, rather than with dramatic life and movement, he instinctively invests his figures. Probably the earliest of the portraits by common consent called his is the beautiful one of a young man at Berlin. His earliest devotional picture would seem to be the highly finished "Christ bearing his Cross" (the head and shoulders only, with a peculiarly serene and high-bred cast of features) formerly at Vicenza and now in the collection of Mrs Gardner at Boston. Other versions of this picture exist, and it has been claimed that one in private possession at Vienna is the true original: erroneously in the judgment of the present writer. Another "Christ bearing the Cross," with a Jew dragging at the rope round his neck, in the church of San Rocco at Venice, is a ruined but genuine work, quoted by Vasari and Ridolfi, and copied with the name of Giorgione appended, by Van Dyck in that master's Chatsworth sketch-book. (Vasari gives it to Giorgione in his first and to Titian in his second edition.) The composition of a lost early picture of the birth of Paris is preserved in an engraving of the "Teniers Gallery" series, and an old copy of part of the same picture is at Budapest. In the Giovanelli Palace at Venice is that fascinating and enigmatical mythology or allegory, known to the Anonimo Morelliano, who saw it in 1530 in the house of Gabriel Vendramin, simply as "the small landscape with the storm, the gipsy woman and the soldier"; the picture is conjecturally interpreted by modern authorities as illustrating a passage in Statius which describes the meeting of Adrastus with Hypsipyle when she was serving as nurse with the king of Nemea. Still belonging to the earlier part of the painter's brief career is a beautiful, virginally pensive Judith at St Petersburg, which passed under various alien names, as Raphael, Moretto, &c., until its kindred with the unquestioned work of Giorgione was in late years firmly established. The great Castelfranco altarpiece, still, in spite of many restorations, one of the most classically pure and radiantly impressive works of Renaissance painting, may be taken as closing the earlier phase of the young master's work (1504). It shows the Virgin loftily enthroned on a plain, sparsely draped stone structure with St Francis and a warrior saint (St Liberale) standing in attitudes of great simplicity on either side of the foot of the throne, a high parapet behind them, and a beautiful landscape of the master's usual type seen above it. Nearly akin to this masterpiece, not in shape or composition but by the type of the Virgin and the very Bellinesque St Francis, is the altarpiece of the Madonna with St Francis and St Roch at Madrid. Of the master's fully ripened time is the fine and again enigmatical picture formerly in the house of Taddeo Contarini at Venice, described by contemporary witnesses as the "Three Philosophers," and now, on slender enough grounds, supposed to represent Evander showing Aeneas the site of Troy as narrated in the eighth Aeneid. The portrait of a knight of Malta in the Uffizi at Florence has more power and authority, if less sentiment, than the earlier example at Berlin, and may be taken to be of the

master's middle time. Most entirely central and typical of all Giorgione's extant works is the Sleeping Venus at Dresden, first recognized by Morelli, and now universally accepted, as being the same as the picture seen by the Anonimo and later by Ridolfi in the Casa Marcello at Venice. An exquisitely pure and severe rhythm of line and contour chastens the sensuous richness of the presentment: the sweep of white drapery on which the goddess lies, and of glowing landscape that fills the space behind her, most harmoniously frame her divinity. It is recorded that the master left this piece unfinished and that the landscape, with a Cupid which subsequent restoration has removed, were completed after his death by Titian. The picture is the prototype of Titian's own Venus at the Uffizi and of many more by other painters of the school; but none of them attained the quality of the first exemplar. Of such small scenes of mixed classical mythology and landscape as early writers attribute in considerable number to Giorgione, there have survived at least two which bear strong evidences of his handiwork, though the action is in both of unwonted liveliness, namely the Apollo and Daphne of the Seminario at Venice and the Orpheus and Eurydice of Bergamo. The portrait of Antonio Grocardo at Budapest represents his fullest and most penetrating power in that branch of art. In his last years the purity and relative slenderness of form which mark his earlier female nudes, including the Dresden Venus, gave way to ideals of ampler mould, more nearly approaching those of Titian and his successors in Venetian art; as is proved by those last remaining fragments of the frescoes on the Grand Canal front of the Fondaco dei Tedeschi which were seen and engraved by Zanetti in 1760, but have now totally disappeared. Such change of ideal is apparent enough in the famous "Concert" or "Pastoral Symphony" of the Louvre, probably the latest, and certainly one of the most characteristic and harmoniously splendid, of Giorgione's creations that has come down to us, and has caused some critics too hastily to doubt its authenticity.

We pass now to pictures for which some affirm and others deny the right to bear Giorgione's name. As youthful in style as the two early pictures in the Uffizi, and closely allied to them in feeling, though less so in colour, is an unexplained subject in the National Gallery, sometimes called for want of a better title the "Golden Age"; this is officially and by many critics given only to the "school of" Giorgione, but may not unreasonably be claimed for his own work (No. 1173). There is also in England a group of three paintings which are certainly by one hand, and that a hand very closely related to Giorgione if not actually his own, namely the small oblong "Adoration of the Magi" in the National Gallery (No. 1160), the "Adoration of the Shepherds" belonging to Lord Allendale (with its somewhat inferior but still attractive replica at Vienna), and the small "Holy Family" in the collection of Mr R. H. Benson. The type of the Madonna in all these three pieces is different from that customary with the master, but there seems no reason why he should not at some particular moment have changed his model. The sentiment and gestures of the figures, the cast of draperies, the technical handling, and especially, in Lord Allendale's picture, the romantic richness of the landscape, all incline us to accept the group as original, notwithstanding the deviation of type already mentioned and certain weaknesses of drawing and proportion which we should have hardly looked for. Better known to European students in general are the two fine pictures commonly given to the master at the Pitti gallery in Florence, namely the "Three Ages" and the "Concert." Both are very Giorgionesque, the "Three Ages" leaning rather towards the early manner of Lorenzo Lotto, to whom by some critics it is actually given. The "Concert" is held on technical grounds by some of the best judges rather to bear the character of Titian at the moment when the inspiration of Giorgione was strongest on him, at least so far as concerns the extremely beautiful and expressive central figure of the monk playing on the clavicord with reverted head, a very incarnation of musical rapture and yearning—the other figures are too much injured to judge.

There are at least two famous single portraits as to which

critics will probably never agree whether they are among the later works of Giorgione or among the earliest of Titian under his influence: these are the jovial and splendid half-length of Catherine Cornaro (or a stout lady much resembling her) with a bas-relief, in the collection of Signor Crespi at Milan, and the so-called "Ariosto" from Lord Darnley's collection acquired for the National Gallery in 1904. Ancient and half-effaced inscriptions, of which there is no cause to doubt the genuineness, ascribe them both to Titian; both, to the mind of the present writer at least, are more nearly akin to such undoubted early Titians as the "Man with the Book" at Hampton Court and the "Man with the Glove" at the Louvre than to any authenticated work of Giorgione. At the same time it should be remembered that Giorgione is known to have actually enjoyed the patronage of Catherine Cornaro and to have painted her portrait. The Giorgionesque influence and feeling, to a degree almost of sentimental exaggeration, encounter us again in another beautiful Venetian portrait at the National Gallery which has sometimes been claimed for him, that of a man in crimson velvet with white-pleated shirt and a background of bays, long attributed to the elder Palma (No. 636). The same qualities are present with more virility in a very striking portrait of a young man at Temple Newsam, which stands indeed nearer than any other extant example to the Brocardo portrait at Budapest. The full-face portrait of a woman in the Borghese gallery at Rome has the marks of the master's design and inspiration, but in its present sadly damaged condition can hardly be claimed for his handiwork. The head of a boy with a pipe at Hampton Court, a little over life size, has been enthusiastically claimed as Giorgione's workmanship, but is surely too slack and soft in handling to be anything more than an early copy of a lost work, analogous to, though better than, the similar copy at Vienna of a young man with an arrow, a subject he is known to have painted. The early records prove indeed that not a few such copies of Giorgione's more admired works were produced in his own time or shortly afterwards. One of the most interesting and unmistakable such copies still extant is the picture formerly in the Manfrin collection at Venice, afterwards in that of Mr Barker in London, and now at Dresden, which is commonly called "The Horoscope," and represents a woman seated near a classic ruin with a young child at her feet, an armed youth standing looking down at them, and a turbaned sage seated near with compasses, disk and book. Of important subject pictures belonging to the debatable borderland between Giorgione and his imitators are the large and interesting unfinished "Judgment of Solomon" at Kingston Lacy, which must certainly be the same that Ridolfi saw and attributed to him in the Casa Grimani at Venice, but has weaknesses of design and drawing sufficiently baffling to criticism; and the "Woman taken in Adultery" in the public gallery at Glasgow, a picture truly Giorgionesque in richness of colour, but betraying in its awkward composition, the relative coarseness of its types and the insincere, mechanical animation of its movements, the hand of some lesser master of the school, almost certainly (by comparison with his existing engravings and woodcuts) that of Domenico Campagnola. It seems unnecessary to refer, in the present notice, to any of the numerous other and inferior works which have been claimed for Giorgione by a criticism unable to distinguish between a living voice and its echoes.

BIBLIOGRAPHY.—Morelli, *Notizie*, &c. (ed. Frizzoni, 1884): Vasari (ed. Milanesi), vol. iv.; Ridolfi, *Le Maraviglie dell'arte*, vol. i.; Zanetti, *Varie Pitture* (1760); Crowe-Cavalaselle, *History of Painting in North Italy*; Morelli, *Kunstkritische Studien*; Gronau, *Zorzon da Castelfranco, la sua origine*, &c. (1894); Herbert Cook, *Giorgione* (in "Great Masters" series, 1900); Ugo Monneret de Villard, *Giorgione da Castelfranco* (1905). The two last-named works are critically far too inclusive, but useful as going over the whole ground of discussion, with full references to earlier authorities, &c. (S. C.)

GIOTTINO (1324-1357), an early Florentine painter. Vasari is the principal authority in regard to this artist; but it is not by any means easy to bring the details of his narrative into harmony with such facts as can now be verified. It would appear that there was a painter of the name of Tommaso (or Maso) di Stefano

GIOTTO

of Giotto, and the Giotto of Vasari is said to have been born in 1267, and to have died early, of consumption, in 1337.—The date 1267 must be regarded as open to considerable doubt. Cimabue, the father of Tommaso, was himself a celebrated painter in the early revival of art; his naturalism was indeed so highly appreciated by contemporaries as to earn him the appellation of "Primizia della Natura" (ape of nature). He, it seems, instructed his son, who, however, applied himself with greater predilection to studying the works of the great Giotto, formed his style on these, and hence was called Giotto. It is even said that Giotto was really the son (others say the great-grandson) of Giotto. To this statement little or no importance can be attached. To Maso di Stefano, or Giotto, Vasari and Ghiberti attribute the frescoes in the chapel of S. Silvestro (or of the Bardi family) in the Florentine church of S. Croce; these represent the miracles of Pope S. Silvestro as narrated in the "Golden Legend," one conspicuous subject being the sealing of the lips of a malignant dragon. These works are animated and firm in drawing, with naturalism carried further than by Giotto. From the evidence of style, some modern connoisseurs assign to the same hand the paintings in the funeral vault of the Strozzi family, below the Cappella degli Spagnuoli in the church of S. Maria Novella, representing the crucifixion and other subjects. Vasari ascribes also to his Giotto the frescoes of the life of St. Nicholas in the lower church of Assisi. This series, however, is not really in that part of the church which Vasari designates, but is in the chapel of the Sacrament; and the works in that chapel are understood to be by Giotto di Stefano, who worked in the second half of the 14th century—very excellent productions of their period. They are much damaged, and the style is hardly similar to that of the Sylvester frescoes. It might hence be inferred that two different men produced the works which are unitedly fathered upon the half-legendary "Giotto," the consumptive youth, solitary and melancholic, but passionately devoted to his art. A large number of other works have been attributed to the same hand; we need only mention an "Apparition of the Virgin to St. Bernard," in the Florentine Academy; a lost painting, very popular in its day, commemorating the expulsion, which took place in 1343, of the duke of Athens from Florence; and a marble statue erected on the Florentine campanile. Vasari particularly praises Giotto for well-blended chiaroscuro.

GIOTTO (GIOTTO DI BONDONE¹) (1267?–1337), Italian painter, was born at Vespignano in the Mugello, a few miles north of Florence, according to one account in 1276, and according to another, which from the few known circumstances of his life seems more likely to be correct, in 1266 or 1267. His father was a landowner at Colle in the commune of Vespignano, described in a contemporary document as *vir praeclarus*, but by biographers both early and late as a poor peasant; probably therefore a peasant proprietor of no large possessions but of reputable stock and descent. It is impossible to tell whether there is any truth in the legend of Giotto's boyhood which relates how he first showed his disposition for art, and attracted the attention of Cimabue, by being found drawing one of his father's sheep with a sharp stone on the face of a smooth stone or slate. With his father's consent, the story goes on, Cimabue carried off the boy to be his apprentice, and it was under Cimabue's tuition that Giotto took his first steps in the art of which he was afterwards to be the great emancipator and renovator. The place where these early steps can still, according to tradition, be traced, is in the first and second, reckoning downwards, of the three courses of frescoes which adorn the walls of the nave in the Upper Church of St. Francis at Assisi. These frescoes represent subjects of the Old and New Testament, and great labour, too probably futile, has been spent in trying to pick out those in which the youthful handiwork of Giotto can be discerned, as it is imagined, among that of Cimabue and his other pupils. But the truth is that the figure of Cimabue himself, in spite of Dante's testimony to his having been the foremost painter of Italy until Giotto arose, has under the search-light of modern criticism melted into

¹ Not to be confused with Giotto di Buondone, a contemporary citizen and politician of Siena.

almost mythical vagueness. His accepted position as Giotto's instructor and the pioneer of reform in his art has been attacked from several sides as a mere invention of Florentine writers for the glorification of their own city. One group of critics maintain that the real advance in Tuscan painting before Giotto was the work of the Siennese school and not of the Florentine. Another group contend that the best painting done in Italy down to the last decade of the 13th century was not done by Tuscan hands at all, but by Roman craftsmen trained in the inherited principles of Italo-Byzantine decoration in mosaic and fresco, and that from such Roman craftsmen alone could Giotto have learnt anything worth his learning. The debate thus opened is far from closed, and considering how scanty, ambiguous and often defaced are the materials existing for discussion, it is perhaps never likely to be closed. But there is no debate as to the general nature of the reform effected by the genius of Giotto himself. He was the great humanizer of painting; it is his glory to have been the first among his countrymen to breathe life into wall-pictures and altar-pieces, and to quicken the dead conventionalism of inherited practice with the fire of natural action and natural feeling. Upon yet another point there is no question; and that is that the reform thus effected by Giotto in painting had been anticipated in the sister art of sculpture by nearly a whole generation. About the middle of the 13th century Nicola Pisano had renewed that art, first by strict imitation of classical models, and later by infusing into his work a fresh spirit of nature and humanity, perhaps partly caught from the Gothic schools of France. His son Giovanni had carried the same re-vitalising of sculpture a great deal further; and hence to some critics it would seem that the real inspirer and precursor of Giotto was Giovanni Pisano the sculptor, and not any painter or wall-decorator, whether of Florence, Siena or Rome.

In this division of opinion it is safer to regard the revival of painting in Giotto's hands simply as part of the general awakening of the time, and to remember that, as of all Italian communities Florence was the keenest in every form of activity both intellectual and practical, so it was natural that a son of Florence should be the chief agent in such an awakening. And in considering his career the question of his possible participation in the primitive frescoes of the upper courses at Assisi is best left out of account, the more so because of the deplorable condition in which they now exist. But with reference to the lowest course of paintings on the same walls, those illustrating the life of St. Francis according to the narrative of St. Bonaventura, no one has any doubt, at least in regard to nineteen or twenty of the twenty-eight subjects which compose the series, that Giotto himself was their designer and chief executant. In these, sadly as they too have suffered from time and wholesale repair, there can nevertheless be discerned the unmistakable spirit of the young Florentine master as we know him in his other works—his shrewd realistic and dramatic vigour, the deep sincerity and humanity of feeling which he knows how to express in every gesture of his figures without breaking up the harmony of their grouping or the grandeur of their linear design, qualities inherited from the earlier schools of impressive but lifeless hieratic decoration. The "Renunciation of the Saint by his Father," the "Pope's Dream of the Saint upholding the tottering Church," the "Saint before the Sultan," the "Miracle of the Spring of Water," the "Death of the Nobleman of Celano," the "Saint preaching before Pope Honorius"—these are some of the most noted and best preserved examples of the painter's power in this series. Where doubt begins again is as to the relations of date and sequence which the series bears to other works by the master executed at Assisi and at Rome in the same early period of his career, that is, probably between 1295 and 1300. Giotto's remaining undisputed works at Assisi are the four celebrated allegorical compositions in honour of St. Francis in the vaulting of the Lower Church,—the "Marriage of St. Francis to Poverty," the "Allegory of Chastity," the "Allegory of Obedience" and the "Vision of St. Francis in Glory." These works are scarcely at all retouched, and relatively little dimmed by time; they are of a singular beauty, at once severe and tender, both

in colour and design; the compositions, especially the first three, fitted with admirable art into the cramped spaces of the vaulting, the subjects, no doubt in the main dictated to the artist by his Franciscan employers, treated in no cold or mechanical spirit but with a full measure of vital humanity and original feeling. Had the career and influence of St Francis had no other of their vast and far-reaching effects in the world than that of inspiring these noble works of art, they would still have been entitled to no small gratitude from mankind. Other works at Assisi which most modern critics, but not all, attribute to Giotto himself are three miracles of St Francis and portions of a group of frescoes illustrating the history of Mary Magdalene, both in the Lower Church; and again, in one of the transepts of the same Lower Church, a series of ten frescoes of the Life of the Virgin and Christ, concluding with the Crucifixion. It is to be remarked as to this transept series that several of the frescoes present not only the same subjects, but with a certain degree of variation the same compositions, as are found in the master's great series executed in the Arena chapel at Padua in the fullness of his powers about 1306; and that the versions in the Assisi transept show a relatively greater degree of technical accomplishment than the Paduan versions, with a more attractive charm and more abundance of accessory ornament, but a proportionately less degree of that simple grandeur in composition and direct strength of human motive which are the special notes of Giotto's style. Therefore a minority of critics refuse to accept the modern attribution of this transept series to Giotto himself, and see in it later work by an accomplished pupil softening and refining upon his master's original creations at Padua. Others, insisting that these unquestionably beautiful works must be by the hand of Giotto and none but Giotto, maintain that in comparison with the Paduan examples they illustrate a gradual progress, which can be traced in other of his extant works, from the relatively ornate and soft to the austere grand and simple. This argument is enforced by comparison with early work of the master's at Rome as to the date of which we have positive evidence. In 1298 Giotto completed for Cardinal Stefaneschi for the price of 2000 gold ducats a mosaic of Christ saving St Peter from the waves (the celebrated "Navicella"); this is still to be seen, but in a completely restored and transformed state, in the vestibule of St Peter's. For the same patron he executed, probably just before the "Navicella," an elaborate ciborium or altar-piece for the high altar of St Peter's, for which he received 800 ducats. It represents on the principal face a colossal Christ enthroned with adoring angels beside him and a kneeling donor at his feet, and the martyrdoms of St Peter and St Paul on separate panels to right and left; on the reverse is St Peter attended by St George and other saints, receiving from the donor a model of his gift, with stately full-length figures of two apostles to right and two to left, besides various accessory scenes and figures in the predellas and the margins. The separated parts of this altar-piece are still to be seen, in a quite genuine though somewhat tarnished condition, in the sacristy of St Peter's. A third work by the master at Rome is a repainted fragment at the Lateran of a fresco of Pope Boniface VIII. proclaiming the jubilee of 1300. The "Navicella" and the Lateran fragment are too much ruined to argue from; but the ciborium panels, it is contended, combine with the aspects of majesty and strength a quality of ornate charm and suavity such as is remarked in the transept frescoes of Assisi. The sequence proposed for these several works is accordingly, first the St Peter's ciborium, next the allegories in the vaulting of the Lower Church, next the three frescoes of St Francis' miracles in the north transept, next the St Francis series in the Upper Church; and last, perhaps after an interval and with the help of pupils, the scenes from the life of Mary Magdalene in her chapel in the Lower Church. This involves a complete reversal of the prevailing view, which regards the unequal and sometimes clumsy compositions of this St Francis series as the earliest independent work of the master. It must be admitted that there is something paradoxical in the idea of a progress from the manner of the Lower Church transept series of the life of

Christ to the much ruder manner of the Upper Church series of St Francis.

A kindred obscurity and little less conflict of opinion await the inquirer at almost all stages of Giotto's career. In 1841 there were partially recovered from the whitewash that had overlain them a series of frescoes executed in the chapel of the Magdalene, in the Bargello or Palace of the Podestà at Florence, to celebrate (as was supposed) a pacification between the Black and White parties in the state effected by the Cardinal d'Acquasparta as delegate of the pope in 1302. In them are depicted a series of Bible scenes, besides great compositions of Hell and Paradise, and in the Paradise are introduced portraits of Dante, Brunetto Latini and Corso Donato. These recovered fragments, freely "restored" as soon as they were disclosed, were acclaimed as the work of Giotto and long held in especial regard for the sake of the portrait of Dante. Latterly it has been shown that if Giotto ever executed them at all, which is doubtful, it must have been at a later date than the supposed pacification, and that they must have suffered grievous injury in the fire which destroyed a great part of the building in 1332, and been afterwards repainted by some well-trained follower of the school. To about 1302 or 1303 would belong, if there is truth in it, the familiar story of Giotto's O. Pope Benedict XI., the successor of Boniface VIII., sent, as the tale runs, a messenger to bring him proofs of the painter's powers. Giotto would give no other sample of his talent than an O drawn with a free sweep of the brush from the elbow; but the pope was satisfied and engaged him at a great salary to go and adorn with frescoes the papal residence at Avignon. Benedict, however, dying at this time (1305), nothing came of this commission; and the remains of Italian 14th-century frescoes still to be seen at Avignon are now recognized as the work, not, as was long supposed, of Giotto, but of the Siennese Simone Martini and his school.

At this point in Giotto's life we come to the greatest by far of his undestroyed and undisputed enterprises, and one which can with some certainty be dated. This is the series of frescoes with which he decorated the entire internal walls of the chapel built at Padua in honour of the Virgin of the Annunciation by a rich citizen of the town, Enrico Scrovegni, perhaps in order to atone for the sins of his father, a notorious usurer whom Dante places in the seventh circle of hell. The building is on the site of an ancient amphitheatre, and is therefore generally called the chapel of the Arena. Since it is recorded that Dante was Giotto's guest at Padua, and since we know that it was in 1306 that the poet came from Bologna to that city, we may conclude that to the same year, 1306, belongs the beginning of Giotto's great undertaking in the Arena chapel. The scheme includes a Saviour in Glory over the altar, a Last Judgment, full of various and impressive incidents, occupying the whole of the entrance wall, with a series of subjects from the Old and New Testament and the apocryphal Life of Christ painted in three tiers on either side wall, and lowest of all a fourth tier with emblematic Virtues and Vices in monochrome; the Virtues being on the side of the chapel next the incidents of redemption in the entrance fresco of the Last Judgment, the Vices on the side next the incidents of perdition. A not improbable tradition asserts that Giotto was helped by Dante in the choice and disposition of the subjects. The frescoes, though not free from injury and retouching, are upon the whole in good condition, and nowhere else can the highest powers of the Italian mind and hand at the beginning of the 14th century be so well studied as here. At the close of the middle ages we find Giotto laying the foundation upon which all the progress of the Renaissance was afterwards securely based. In his day the knowledge possessed by painters of the human frame and its structure rested only upon general observation and not upon detailed or scientific study; while to facts other than those of humanity their observation had never been closely directed. Of linear perspective they possessed but elementary and empirical ideas, and their endeavours to express aerial perspective and deal with the problems of light and shade were rare and partial. As far as painting could possibly be carried under these conditions, it was carried by Giotto. In its choice of

subjects, his art is entirely subservient to the religious spirit of his age. Even in its mode of conceiving and arranging those subjects it is in part still trammelled by the rules and consecrated traditions of the past. Many of those truths of nature to which the painters of succeeding generations learned to give accurate and complete expression, Giotto was only able to express by way of imperfect symbol and suggestion. But among the elements of art over which he has control he maintains so just a balance that his work produces in the spectator less sense of imperfection than that of many later and more accomplished masters. In some particulars his mature painting, as we see it in the Arena chapel, has never been surpassed—in mastery of concise and expressive generalized line and of inventive and harmonious decorative tint; in the judicious division of the field and massing and scattering of groups; in the combination of high gravity with complete frankness in conception, and the union of noble dignity in the types with direct and vital truth in the gestures of the personages.

The frescoes of the Arena chapel must have been a labour of years, and of the date of their termination we have no proof. Of many other works said to have been executed by Giotto at Padua, all that remains consists of some scarce recognizable traces in the chapter-house of the great Franciscan church of St Antonio. For twenty years or more we lose all authentic data as to Giotto's doings and movements. Vasari, indeed, sends him on a giddy but in the main evidently fabulous round of travels, including a sojourn in France, which it is certain he never made. Besides Padua, he is said to have resided and left great works at Ferrara, Ravenna, Urbino, Rimini, Faenza, Lucca and other cities; in some of them paintings of his school are still shown, but nothing which can fairly be claimed to be by his hand. It is recorded also that he was much employed in his native city of Florence; but the vandalism of later generations has effaced nearly all that he did there. Among works whitewashed over by posterity were the frescoes with which he covered no less than five chapels in the church of Santa Croce. Two of these, the chapels of the Bardi and the Peruzzi families, were scraped in the early part of the 19th century, and very important remains were uncovered and immediately subjected to a process of restoration which has robbed them of half their authenticity. But through the ruins of time we can trace in some of these Santa Croce frescoes all the qualities of Giotto's work at an even higher and more mature development than in the best examples at Assisi or Padua. The frescoes of the Bardi chapel tell again the story of St Francis, to which so much of his best power had already been devoted; those of the Peruzzi chapel deal with the lives of St John the Baptist and St John the Evangelist. Such scenes as the Funeral of St Francis, the Dance of Herodias's Daughter, and the Resurrection of St John the Evangelist, which have to some extent escaped the disfigurements of the restorer, are among acknowledged classics of the world's art. The only clues to the dates of any of these works are to be found in the facts that among the figures in the Bardi chapel occurs that of St Louis of Toulouse, who was not canonized till 1317, therefore the painting must be subsequent to that year, and that the "Dance of Salome" must have been painted before 1331, when it was copied by the Lorenzetti at Siena. The only other extant works of Giotto at Florence are a fine "Crucifix," not undisputed, at San Marco, and the majestic but somewhat heavy altar-piece of the Madonna, probably an early work, which is placed in the Academy beside a more primitive Madonna supposed to be the work of Cimabue.

Towards the end of Giotto's life we escape again from confused legend, and from the tantalizing record of works which have not survived for us to verify, into the region of authentic document and fact. It appears that Giotto had come under the notice of Duke Charles of Calabria, son of King Robert of Naples, during the visits of the duke to Florence which took place between 1326 and 1328, in which year he died. Soon afterwards Giotto must have gone to King Robert's court at Naples, where he was enrolled as an honoured guest and member of the household by a royal decree dated the 20th of January 1330. Another document shows him to have been still at Naples two years later.

Tradition says much about the friendship of the king for the painter and the freedom of speech and jest allowed him; much also of the works he carried out at Naples in the Castel Nuovo, the Castel dell' Uovo, and the church and convent of Sta Chiara. Not a trace of these works remains; and others which later criticism have claimed for him in a hall which formerly belonged to the convent of Sta Chiara have been proved not to be his.

Meantime Giotto had been advancing, not only in years and worldly fame, but in prosperity. He was married young, and had, so far as is recorded, three sons, Francesco, Niccola and Donato, and three daughters, Bice, Caterina and Lucia. He had added by successive purchases to the plot of land inherited from his father at Vespiignano. His fellow-citizens of all occupations and degrees delighted to honour him. And now, in his sixty-eighth year (if we accept the birth-date 1266/7), on his return from Naples by way of Gaeta, he received the final and official testimony to the esteem in which he was held at Florence. By a solemn decree of the *Priors* on the 12th of April 1334, he was appointed master of the works of the cathedral of Sta Reparata (later and better known as Sta Maria del Fiore) and official architect of the city walls and the towns within her territory. What training as a practical architect his earlier career had afforded him we do not know, but his interest in the art from the beginning is made clear by the carefully studied architectural backgrounds of many of his frescoes. Dying on the 8th of January 1336 (old style 1337), Giotto only enjoyed his new dignities for two years. But in the course of them he had found time not only to make an excursion to Milan, on the invitation of Azzo Visconti and with the sanction of his own government, but to plan two great architectural works at Florence and superintend the beginning of their execution, namely the west front of the cathedral and its detached campanile or bell-tower. The unfinished enrichments of the cathedral front were stripped away in a later age. The foundation-stone of the Campanile was laid with solemn ceremony in the presence of a great concourse of magistrates and people on the 18th of July 1334. Its lower courses seem to have been completed from Giotto's design, and the first course of its sculptured ornaments (the famous series of primitive Arts and Industries) actually by his own hand, before his death. It is not clear what modifications of his design were made by Andrea Pisano, who was appointed to succeed him, or again by Francesco Talenti, to whom the work was next entrusted; but the incomparable structure as we now see it stands justly in the world's esteem as the most fitting monument to the genius who first conceived and directed it.

The art of painting, as re-created by Giotto, was carried on throughout Italy by his pupils and successors with little change or development for nearly a hundred years, until a new impulse was given to art by the combined influences of naturalism and classicism in the hands of men like Donatello and Masaccio. Most of the anecdotes related of the master are probably inaccurate in detail, but the general character both as artist and man which tradition has agreed in giving him can never be assailed. He was from the first a kind of popular hero. He is celebrated by the poet Petrarch and by the historian Villani. He is made the subject of tales and anecdotes by Boccaccio and by Franco Sacchetti. From these notices, as well as from Vasari, we gain a distinct picture of the man, as one whose nature was in keeping with his country origin; whose sturdy frame and plain features corresponded to a character rather distinguished for shrewd and genial strength than for sublimer or more ascetic qualities; a master craftsman, to whose strong combining and inventing powers nothing came amiss; conscious of his own deserts, never at a loss either in the things of art or in the things of life, and equally ready and efficient whether he has to design the scheme of some great spiritual allegory in colour or imperishable monument in stone, or whether he has to show his wit in the encounter of practical jest and repartee. From his own hand we have a contribution to literature which helps to substantiate this conception of his character. A large part of Giotto's fame as painter was won in the service of the Franciscans, and in the pictorial celebration of the life and ordinances of

their founder. As is well known, it was a part of the ordinances of Francis that his disciples should follow his own example in worshipping and being wedded to poverty,—poverty idealized and personified as a spiritual bride and mistress. Giotto, having on the commission of the order given the noblest pictorial embodiment to this and other aspects of the Franciscan doctrine, presently wrote an ode in which his own views on poverty are expressed; and in this he shows that, if on the one hand his genius was at the service of the ideals of his time, and his imagination open to their significance, on the other hand his judgment was shrewdly and humorously awake to their practical dangers and exaggerations.

AUTHORITIES.—Ghiberti, *Commentari*; Vasari, *Le Vite*, vol. i.; Crowe-Cavalcaelle, *History of Painting in Italy*, ed. Langton Douglas (1903); H. Thode, *Giotto* (1899); M. G. Zimmermann, *Giotto und die Kunst Italiens im Mittelalter* (1899); B. Berenson, *Florentine Painters of the Renaissance*; F. Mason Perkin, *Giotto* (in "Great Masters" series) (1902); Basil de Selincourt, *Giotto* (1905).

GIPSIES, or **GYPSES**, a wandering folk scattered through every European land, over the greater part of western Asia and Siberia; found also in Egypt and the northern coast of Africa, in America and even in Australia. No correct estimate of their numbers outside of Europe can be given, and even in Europe the information derived from official statistics is often contradictory and unreliable. The only country in which the figures have been given correctly is Hungary. In 1893 there were 274,940 in Transleithania, of whom 243,432 were settled, 20,406 only partly settled and 8938 nomads. Of these 91,603 spoke the Gipsy language in 1890, but the rest had already been assimilated. Next in numbers stands Rumania, the number varying between 250,000 and 200,000 (1895). Turkey in Europe counted 117,000 (1903), of whom 51,000 were in Bulgaria and Eastern Rumelia, 22,000 in the vilayet of Adrianople and 2500 in the vilayet of Kossovo. In Asiatic Turkey the estimates vary between 67,000 and 200,000. Servia has 41,000; Bosnia and Herzegovina, 18,000; Greece, 10,000; Austria (Cisleithania), 16,000, of whom 13,500 are in Bohemia and Moravia; Germany, 2000; France, 2000 (5000?); Basque Provinces, 500 to 700; Italy, 32,000; Spain, 40,000; Russia, 58,000; Poland, 15,000; Sweden and Norway, 1500; Denmark and Holland, 5000; Persia, 15,000; Transcaucasia, 3000. The rest is mere guesswork. For Africa, America and Australia the numbers are estimated between 135,000 and 166,000. The estimate given by Miklosich (1878) of 700,000 fairly agrees with the above statistics. No statistics are forthcoming for the number in the British Isles. Some estimate their number at 12,000.

The Gipsies are known principally by two names, which have been modified by the nations with whom they came in contact, but which can easily be traced to either the one or the other of these two distinct stems. The one group, embracing the majority of Gipsies in Europe, the compact masses living in the Balkan Peninsula, Rumania and Transylvania and extending also as far as Germany and Italy, are known by the name *Atsigan* or *Atsigan*, which becomes in time Tshingian (Turkey and Greece), Tsigan (Bulgarian, Servian, Rumanian), Czigany (Hungarian), Zigeuner (Germany), Zingari (Italian), and it is not unlikely that the English word Tinker or Tinkler (the latter no doubt due to a popular etymology connecting the gaudy gipsy with the tinkling coins or the metal wares which he carried on his back as a smith and tinker) may be a local transformation of the German *Zigewer*. The second name, partly known in the East, where the word, however, is used as an expression of contempt, whilst Zigan is not felt by the gipsies as an insult, is *Egyptians*; in England, Gipsy; in some German documents of the 16th century *Aegypter*; Spanish *Gitano*; modern Greek *Gyphos*. They are also known by the parallel expressions *Paraon* (Rumanian) and *Phrao Nepka* (Hungarian) or Pharaoh's people, which are only variations connected with the Egyptian origin. In France they are known as *Bohémien*s, a word the importance of which will appear later. To the same category belong other names bestowed upon them, such as *Walachi*, *Saraceni*, *Agareni*, *Nubiani*, &c. They were also known

by the name of Tartars, given to them in Germany, or as "Heathen," *Heydens*. All these latter must be considered as nicknames without thereby denoting their probable origin. The same may have now been the case with the first name with which they appear in history, *Atsigan*. Much ingenuity has been displayed in attempts to explain the name, for it was felt that a true explanation might help to settle the question of their origin and the date of their arrival in Europe. Here again two extreme theories have been propounded, the one supported by Bataillard, who connected them with the Signynoi of Herodotus and identified them with the Komodromoi of the later Byzantine writers, known already in the 6th century. Others bring them to Europe as late as the 14th century; and the name has also been explained by de Goeffe from the Persian *Chang*, a kind of harp or zither, or the Persian *Zang*, black, swarthy. Rienzi (1832) and Trumpp (1872) have connected the name with the Changars of North-East India, but all have omitted to notice that the real form was Atzingan or (more correct) Atzingan and not Tsigan. The best explanation remains that suggested by Miklosich, who derives the word from the Athinganoi, a name originally belonging to a peculiar heretical sect living in Asia Minor near Phrygia and Lycaonia, known also as the Melki-Zedekites. The members of this sect observed very strict rules of purity, as they were afraid to be defiled by the touch of other people whom they considered unclean. They therefore acquired the name of Athinganoi (i.e. "Touch-me-nots").

Miklosich has collected seven passages where the Byzantine historians of the 9th century describe the Athinganoi as soothsayers, magicians and serpent-charmers. From these descriptions nothing definite can be proved as to the identity of the Athinganoi with the Gipsies, or the reason why this name was given to soothsayers, charmers, &c. But the inner history of the Byzantine empire of that period may easily give a clue to it and explain how it came about that such a nickname was given to a new sect or to a new race which suddenly appeared in the Greek Empire at that period. In the history of the Church we find them mentioned in one breath with the Paulicians and other heretical sects which were transplanted in their tens of thousands from Asia Minor to the Greek empire and settled especially in Rumelia, near Adrianople and Philippopolis. The Greeks called these heretical sects by all kinds of names, derived from ancient Church traditions, and gave to each sect such names as first struck them, on the scantiest of imaginary similarities. One sect was called Paulician, another Melki-Zedekite; so also these were called Athinganoi, probably being considered the descendants of the outcast Samar, who, according to ancient tradition, was a goldsmith and the maker of the Golden Calf in the desert. For this sin Samar was banished and compelled to live apart from human beings and even to avoid their touch (Athinganos: "Touch-me-not"). Travelling from East to West these heretical sects obtained different names in different countries, in accordance with the local traditions or to imaginary origins. The Bogomils and Patarenes became Bulgarians in France, and so the gypsies *Bohémien*s, a name which was also connected with the heretical sect of the Bohemian brothers (*Böhmische Brüder*). Curiously enough the Kutzo-Vlachs living in Macedonia (q.v.) and Rumelia are also known by the nickname Tsintsari, a word that has not yet been explained. Very likely it stands in close connexion with Zingari, the name having been transferred from one people to the other without the justification of any common ethnical origin, except that the Kutzo-Vlachs, like the Zingari, differed from their Greek neighbours in race, as in language, habits and customs; while they probably followed similar pursuits to those of the Zingari, as smiths, &c. As to the other name, *Egyptians*, this is derived from a peculiar tale which the gipsies spread when appearing in the west of Europe. They alleged that they had come from a country of their own called Little Egypt, either a confusion between Little Armenia and Egypt or the Peloponnesus.

Attention may be drawn to a remarkable passage in the Syriac version of the apocryphal Book of Adam, known as the *Case of Treasures* and compiled probably in the 6th century: "And

of the seed of Canaan were as I said the Egyptians; and, lo, they were scattered all over the earth and served as slaves of slaves" (ed. Bezold, German translation, p. 25). No reference to such a scattering and serfdom of the Egyptians is mentioned anywhere else. This must have been a legend, current in Asia Minor, and hence probably transferred to the swarthy Gipsies.

A new explanation may now be ventured upon as to the name which the Gipsies of Europe give to themselves, which, it must be emphasized, is not known to the Gipsies outside of Europe. Only those who starting from the ancient Byzantine empire have travelled westwards and spread over Europe, America and Australia call themselves by the name of Rom, the woman being Romni and a stranger Gazi. Many etymologies have been suggested for the word Rom. Paspatis derived it from the word Droma (Indian), and Miklosich had identified it with Domba or Domba, a "low caste musician," rather an extraordinary name for a nation to call itself by. Having no home and no country of their own and no political traditions and no literature, they would naturally try to identify themselves with the people in whose midst they lived, and would call themselves by the same name as other inhabitants of the Greek empire, known also as the Empire of New Rom, or of the Romaioi, Romelioti, Romanoii, as the Byzantines used to call themselves before they assumed the prouder name of Hellenes. The Gipsies would therefore call themselves also Rom, a much more natural name, more flattering to their vanity, and geographically and politically more correct than if they called themselves "low caste musicians." This Greek origin of the name would explain why it is limited to the European Gipsies, and why it is not found among that stock of Gipsies which has migrated from Asia Minor southwards and taken a different route to reach Egypt and North Africa.

Appearance in Europe.—Leaving aside the doubtful passages in the Byzantine writers where the Athinganoi are mentioned, the first appearance of Gipsies in Europe cannot be traced positively further back than the beginning of the 14th century. Some have hitherto believed that a passage in what was erroneously called the Rhymed Version of Genesis of Vienna, but which turns out to be the work of a writer before the year 1122, and found only in the Klagenfurt manuscript (edited by Ditmar, 1862), referred to the Gipsies. It runs as follows: Gen. xiii. 15—"Hagar had a son from whom were born the Chaltsmide. When Hagar had that child, she named it Ismael, from whom the Ismaelites descend who journey through the land, and we call them Chaltsmide, may evil befall them! They sell only things with blemishes, and for whatever they sell they always ask more than its real value. They cheat the people to whom they sell. They have no home, no country, they are satisfied to live in tents, they wander over the country, they deceive the people; they cheat men but rob no one noisily."

This reference to the Chaltsmide (not goldsmiths, but very likely ironworkers, smiths) has wrongly been applied to the Gipsies. For it is important to note that at least three centuries before historical evidence proves the immigration of the genuine Gipsy, there had been wayfaring smiths, travelling from country to country, and practically paving the way for their successors, the Gipsies, who not only took up their crafts but who probably have also assimilated a good proportion of these vagrants of the west of Europe. The name given to the former, who probably were Oriental or Greek smiths and pedlars, was then transferred to the new-comers. The Komodromoi mentioned by Theophanes (758-818), who speaks under the date 554 of one hailing from Italy, and by other Byzantine writers, are no doubt the same as the Chaltsmide of the German writer of the 12th century translated by Ducange as *Chaudroneurs*. We are on surer ground in the 14th century. Hopf has proved the existence of Gipsies in Corfu before 1326. Before 1346 the empress Catherine de Valois granted to the governor of Corfu authority to reduce to vassalage certain vagrants who came from the mainland; and in 1386, under the Venetians, they formed the *Feudum Acindanorum*, which lasted for many centuries. About 1378 the Venetian governor of Nauplia

confirmed to the "Acingani" of that colony the privileges granted by his predecessor to their leader John. It is even possible to identify the people described by Friar Simon in his *Itinerarium*, who, speaking of his stay in Crete in 1322, says: "We saw there a people outside the city who declare themselves to be of the race of Ham and who worship according to the Greek rite. They wander like a cursed people from place to place, not stopping at all or rarely in one place longer than thirty days; they live in tents like the Arabs, a little oblong black tent." But their name is not mentioned, and although the similarity is great between these "children of Ham" and the Gipsies, the identification has only the value of an hypothesis. By the end of the 15th century they must have been settled for a sufficiently long time in the Balkan Peninsula and the countries north of the Danube, such as Transylvania and Walachia, to have been reduced to the same state of serfdom as they evidently occupied in Corfu in the second half of the 14th century. The voivode Mircea I. of Walachia confirms the grant made by his uncle Vladislav Voivode to the monastery of St Anthony of Voditsa as to forty families of "Atsigane," for whom no taxes should be paid to the prince. They were considered crown property. The same gift is renewed in the year 1424 by the voivode Dan, who repeats the very same words (i Acigane, m, celiudi. da su slobodni ot vstkih rabot i dankov) (Hajdu, *Arhiva*, i. 20). At that time there must already have been in Walachia settled Gipsies treated as serfs, and migrating Gipsies plying their trade as smiths, musicians, dancers, sooth-sayers, horse-dealers, &c., for we find the voivode Alexander of Moldavia granting these Gipsies in the year 1478 "freedom of air and soil to wander about and free fire and iron for their smithy." But a certain portion, probably the largest, became serfs, who could be sold, exchanged, bartered and inherited. It may be mentioned here that in the 17th century a family when sold fetched forty Hungarian florins, and in the 18th century the price was sometimes as high as 700 Rumanian piastres, about £8, 10s. As late as 1845 an auction of 200 families of Gipsies took place in Bucharest, where they were sold in batches of no less than 5 families and offered at a "ducat" cheaper per head than elsewhere. The Gipsies followed at least four distinct pursuits in Rumania and Transylvania, where they lived in large masses. A goodly proportion of them were tied to the soil; in consequence their position was different from that of the Gipsies who had started westwards and who are nowhere found to have obtained a permanent abode for any length of time, or to have been treated, except for a very short period, with any consideration of humanity.

Their appearance in the West is first noted by chroniclers early in the 15th century. In 1414 they are said to have already arrived in Hesse. This date is contested, but for 1417 the reports are unanimous of their appearance in Germany. Some count their number to have been as high as 1400, which of course is exaggeration. In 1418 they reached Hamburg, 1419 Augsburg, 1428 Switzerland. In 1427 they had already entered France (Provence). A troupe is said to have reached Bologna in 1422, whence they are said to have gone to Rome, on a pilgrimage alleged to have been undertaken for some act of apostasy. After this first immigration a second and larger one seems to have followed in its wake, led by Zumbel. The Gipsies spread over Germany, Italy and France between the years 1438 and 1512. About 1500 they must have reached England. On the 5th of July 1505 James IV. of Scotland gave to "Antonius Gaginae," count of Little Egypt, letters of recommendation to the king of Denmark; and special privileges were granted by James V. on the 15th of February 1540 to "oure louit johanne Faw Lord and Erie of Litill Egypt," to whose son and successor he granted authority to hang and punish all Egyptians within the realm (May 26, 1540).

It is interesting to hear what the first writers who witnessed their appearance have to tell us; for ever since the Gipsies have remained the same. Albert Krantzius (Krantz), in his *Saxonia* (xi. 2), was the first to give a full description, which was afterwards repeated by Munster in his *Cosmographia* (iii. 5).

He says that in the year 1417 there appeared for the first time in Germany a people uncouth, black, dirty, barbarous, called in Italian "Ciani," who indulge specially in thieving and cheating. They had among them a count and a few knights well dressed, others followed afoot. The women and children travelled in carts. They also carried with them letters of safe-conduct from the emperor Sigismund and other princes, and they professed that they were engaged on a pilgrimage of expiation for some act of apostasy.

The guilt of the Gipsies varies in the different versions of the story, but all agree that the Gipsies asserted that they came from their own country called "Litill Egypt," and they had to go to Rome, to obtain pardon for that alleged sin of their forefathers. According to one account it was because they had not shown mercy to Joseph and Mary when they had sought refuge in Egypt from the persecution of Herod (*Basel Chronicle*). According to another, because they had forsaken the Christian faith for a while (*Rhaetia*, 1656), &c. But these were fables, no doubt connected with the legend of Cartaphylus or the Wandering Jew.

Krantz's narrative continues as follows: This people have no country and travel through the land. They live like dogs and have no religion although they allow themselves to be baptized in the Christian faith. They live without care and gather unto themselves also other vagrants, men and women. Their old women practise fortune-telling, and whilst they are telling men of their future they pick their pockets. Thus far Krantz. It is curious that he should use the name by which these people were called in Italy, "Ciani." Similarly Crusius, the author of the *Annales Suevici*, knows their Italian name *Zigani* and the French *Bohémiens*. Not one of these oldest writers mentions them as coppersmiths or farriers or musicians. The immunity which they enjoyed during their first appearance in western Europe is due to the letter of safe-conduct of the emperor. As it is of extreme importance for the history of civilization as well as the history of the Gipsies, it may find a place here. It is taken from the compilation of Felix Oefelius, *Rerum Boicarum scriptores* (Augsburg, 1763), ii. 15, who reproduces the "Diarium sexennale" of "Andreas Presbyter," the contemporary of the first appearance of the Gipsies in Germany.

"Sigismundus Dei gratia Romanorum Rex semper Augustus, ac Hungariae, Bohemiae, Dalmatiae, Croatiae, &c. Rex Fidelibus nostris universis Nobilibus, Militibus, Castellanis, Officialibus, Tributariis, civitatibus liberis, opidis et eorum iudicibus in Regno et sub domino nostro constitutis ex existentibus salutem cum dilectione. Fideles nostri adierunt in praesentiam personaliter Ladislaus Wayuoda Ciganorum cum aliis ad ipsum spectantibus, nobis humilimas porreuerunt supplicationes, huc in sepus in nostra praesentia supplicationum precum cum instantia, ut ipsis gratia nostra uberiori providere dignaremur. Unde nos illorum supplicatione illecti eisdem hanc libertatem duximus concedendam, qua re quodcumque idem Ladislaus Wayuoda et sua gens ad dicta nostra dominia videlicet civitates vel oppida pervenerint, ex tunc vestris fidelitatibus praesentibus firmiter committimus et mandamus ut eosdem Ladislaum Wayuodam et Ciganos sibi subiectos omni sine impedimento ac perturbatione aliqui fovere ac conservare debeatis, immo ab omnibus impetitionibus seu offensionibus tueri velitis: Si autem inter ipsos aliqua Zizania seu perturbatio evenerit ex parte, quorumcumque ex tunc non vos nec aliquis alter vestrum, sed idem Ladislaus Wayuoda iudicandi et liberandi habeat facultatem. Praesentes autem post earum lecturam semper reddi iubemus praesentanti.

"Datum in Sepus Dominica die ante festum St Georgii Martyris Anno Domini MCCCCXIII., Regnorum nostrorum anno Hungar. XXXVI., Romanorum vero XII., Bohemiae tertio."

Freely translated this reads: "We Sigismund by the grace of God emperor of Rome, king of Hungary, Bohemia, &c. unto all true and loyal subjects, noble soldiers, commanders, castellans, open districts, free towns and their judges in our kingdom established and under our sovereignty, kind greetings. Our faithful vojvode of the Tsigani with others belonging to him has

humbly requested us that we might graciously grant them our abundant favour. We grant them their supplication, we have vouchsafed unto them this liberty. Whenever therefore this vojvode Ladislaus and his people should come to any part of our realm in any town, village or place, we commit them by these presents, strongly to your loyalty and we command you to protect in every way the same vojvode Ladislaus and the Tsigani his subjects without hindrance, and you should show kindness unto them and you should protect them from every trouble and persecution. But should any trouble or discord happen among them from whichever side it may be, then none of you nor anyone else belonging to you should interfere, but this vojvode Ladislaus alone should have the right of punishing and pardoning. And we moreover command you to return these presents always after having read them. Given in our court on Sunday the day before the Feast of St George in the year of our Lord 1423. The 36th year of our kingdom of Hungary, the 12th of our being emperor of Rome and the 3rd of our being king of Bohemia."

There is no reason to doubt the authenticity of this document, which is in no way remarkable considering that at that time the Gipsies must have formed a very considerable portion of the inhabitants of Hungary, whose king Sigismund was. They may have presented the emperor's grant of favours to Alexander prince of Moldavia in 1472, and obtained from him safe-conduct and protection, as mentioned above.

No one has yet attempted to explain the reason why the Gipsies should have started in the 14th and especially in the first half of the 15th century on their march westwards. But if, as has been assumed above, the Gipsies had lived for some length of time in Rumelia, and afterwards spread thence across the Danube and the plains of Transylvania, the incursion of the Turks into Europe, their successive occupation of those very provinces, the overthrow of the Servian and Bulgarian kingdoms and the dislocation of the native population, would account to a remarkable degree for the movement of the Gipsies: and this movement increases in volume with the greater successes of the Turks and with the peopling of the country by immigrants from Asia Minor. The first to be driven from their homes would no doubt be the nomadic element, which felt itself ill at ease in its new surroundings, and found it more profitable first to settle in larger numbers in Walachia and Transylvania and thence to spread to the western countries of Europe. But their immunity from persecution did not last long.

Later History.—Less than fifty years from the time that they emerge out of Hungary, or even from the date of the Charter of the emperor Sigismund, they found themselves exposed to the fury and the prejudices of the people whose good faith they had abused, whose purses they had lightened, whose barns they had emptied, and on whose credulity they had lived with ease and comfort. Their inborn tendency to roaming made them the terror of the peasantry and the despair of every legislator who tried to settle them on the land. Their foreign appearance, their unknown tongue and their unscrupulous habits forced the legislators of many countries to class them with rogues and vagabonds, to declare them outlaws and felons and to treat them with extreme severity. More than one judicial murder has been committed against them. In some places they were suspected as Turkish spies and treated accordingly, and the murderer of a Gypsy was often regarded as innocent of any crime.

Weissenbruch describes the wholesale murder of a group of Gipsies, of whom five men were broken on the wheel, nine perished on the gallows, and three men and eight women were decapitated. This took place on the 14th and 15th of November 1726. Acts and edicts were issued in many countries from the end of the 15th century onwards sentencing the "Egyptians" to exile under pain of death. Nor was this an empty threat. In Edinburgh four "Faas" were hanged in 1611 "for abiding within the kingdom, they being Egyptian," and in 1636 at Haddington the Egyptians were ordered "the men to be hanged and the women to be drowned, and such of the women as hes children to be scourgit throw the burg and burnt in the cheeks." The burning on the cheek or on the back was a common penalty.

In 1692 four Estrémadura Gipsies caught by the Inquisition were charged with cannibalism and made to own that they had eaten a friar, a pilgrim and even a woman of their own tribe, for which they suffered the penalty of death. And as late as 1782, 45 Hungarian Gipsies were charged with a similar monstrous crime, and when the supposed victims of a supposed murder could not be found on the spot indicated by the Gipsies, they owned under torture and said on the rack, "We ate them." Of course they were forthwith beheaded or hanged. The emperor Joseph II., who was also the author of one of the first edicts in favour of the Gipsies, and who abolished serfdom throughout the Empire, ordered an inquiry into the incident; it was then discovered that no murder had been committed, except that of the victims of this monstrous accusation.

The history of the legal status of the Gipsies, of their treatment in various countries and of the penalties and inflictions to which they have been subjected, would form a remarkable chapter in the history of modern civilization. The materials are slowly accumulating, and it is interesting to note as one of the latest instances, that not further back than the year 1907 a "drive" was undertaken in Germany against the Gipsies, which fact may account for the appearance of some German Gipsies in England in that year, and that in 1904 the Prussian Landtag adopted unanimously a proposition to examine anew the question of granting peddling licences to German Gipsies; that on the 17th of February 1906 the Prussian minister issued special instructions to combat the Gipsy nuisance; and that in various parts of Germany and Austria a special register is kept for the tracing of the genealogy of vagrant and sedentary Gipsy families.

Different has been the history of the Gipsies in what originally formed the Turkish empire of Europe, notably in Rumania, i.e. Walachia and Moldavia, and a careful search in the archives of Rumania would offer rich materials for the history of the Gipsies in a country where they enjoyed exceptional treatment almost from the beginning of their settlement. They were divided mainly into two classes, (1) *Robi* or Serfs, who were settled on the land and deprived of all individual liberty, being the property of the nobles and of churches or monastic establishments, and (2) the Nomadic vagrants. They were subdivided into four classes according to their occupation, such as the *Lingurari* (woodcarvers; lit. "spoonmakers"), *Caldarari* (tinkers, coppersmiths and ironworkers), *Ursari* (lit. "bear drivers") and *Rudari* (miners), also called *Aurari* (gold-washers), who used formerly to wash the gold out of the auriferous river-sands of Walachia. A separate and smaller class consisted of the *Gipsy Lăeshi* or *Vătrăshi* (settled on a homestead or "having a fireplace" of their own). Each *shatra* or Gipsy community was placed under the authority of a judge or leader, known in Rumania as *jude*, in Hungary as *aga*; these officials were subordinate to the *dulubasha* or *voivod*, who was himself under the direct control of the *yuzbasha* (or governor appointed by the prince from among his nobles). The *yuzbasha* was responsible for the regular income to be derived from the vagrant Gipsies, who were considered and treated as the prince's property. These *voivodi* or *yuzbashi* who were not Gipsies by origin often treated the Gipsies with great tyranny. In Hungary down to 1648 they belonged to the aristocracy. The last Polish *Królestwo cyganski* or Gipsy king died in 1790. The *Robi* could be bought and sold, freely exchanged and inherited, and were treated as the negroes in America down to 1836, when their final freedom in Moldavia was proclaimed. In Hungary and in Transylvania the abolition of servitude in 1781-1782 carried with it the freedom of the Gipsies. In the 18th and 19th centuries many attempts were made to settle and to educate the roaming Gipsies; in Austria this was undertaken by the empress Maria Theresa and the emperor Francis II. (1761-1783), in Spain by Charles III. (1788). In Poland (1791) the attempt succeeded. In England (1827) and in Germany (1830) societies were formed for the reclamation of the Gipsies, but nothing was accomplished in either case. In other countries, however, definite progress was made. Since 1866 the Gipsies have become Rumanian citizens, and the latest official statistics no longer distinguish between

the Rumanians and the Gipsies, who are becoming thoroughly assimilated, forgetting their language, and being slowly absorbed by the native population. In Bulgaria the Gipsies were declared citizens, enjoying equal political rights in accordance with the treaty of Berlin in 1878, but through an arbitrary interpretation they were deprived of that right, and on the 6th of January 1906 the first Gipsy Congress was held in Sofia, for the purpose of claiming political rights for the Turkish Gipsies or *Gopti* as they call themselves. Ramadan Alief, the *tari-bashi* (i.e. the head of the Gipsies in Sofia), addressed the Gipsies assembled; they decided to protest and subsequently sent a petition to the *Sobrane*, demanding the recognition of their political rights. A curious reawakening, and an interesting chapter in the history of this peculiar race.

Origin and Language of the Gipsies.—The real key to their origin is, however, the Gipsy language. The scientific study of that language began in the middle of the 19th century with the work of Pott, and was brought to a high state of perfection by Miklosich. From that time on monographs have multiplied and minute researches have been carried on in many parts of the world, all tending to elucidate the true origin of the Gipsy language. It must remain for the time being an open question whether the Gipsies were originally a pure race. Many a strange element has contributed to swell their ranks and to introduce discordant elements into their vocabulary. Ruediger (1782), Grelmann (1783) and Marsden (1783) almost simultaneously and independently of one another came to the same conclusion, that the language of the Gipsies, until then considered a thieves' jargon, was in reality a language closely allied with some Indian speech. Since then the two principal problems to be solved have been, firstly, to which of the languages of India the original Gipsy speech was most closely allied, and secondly, by which route the people speaking that language had reached Europe and then spread westwards. Despite the rapid increase in our knowledge of Indian languages, no solution has yet been found to the first problem, nor is it likely to be found. For the language of the Gipsies, as shown now by recent studies of the Armenian Gipsies, has undergone such a profound change and involves so many difficulties, that it is impossible to compare the modern Gipsy with any modern Indian dialect owing to the inner developments which the Gipsy language has undergone in the course of centuries. All that is known, moreover, of the Gipsy language, and all that rests on reliable texts, is quite modern, scarcely earlier than the middle of the 19th century. Followed up in the various dialects into which that language has split, it shows such a thorough change from dialect to dialect, that except as regards general outlines and principles of inflexion, nothing would be more misleading than to draw conclusions from apparent similarities between Gipsy, or any Gipsy dialect, and any Indian language; especially as the Gipsies must have been separated from the Indian races for a much longer period than has elapsed since their arrival in Europe and since the formation of their European dialects. It must also be borne in mind that the Indian languages have also undergone profound changes of their own, under influences totally different from those to which the Gipsy language has been subjected. The problem would stand differently if by any chance an ancient vocabulary were discovered representing the oldest form of the common stock from which the European dialects have sprung; for there can be no doubt of the unity of the language of the European Gipsies. The question whether Gipsy stands close to Sanskrit or Prakrit, or shows forms more akin to Hindi dialects, specially those of the North-West frontier, or Dardistan and Kafiristan, to which may be added now the dialects of the *Pisāca* language (Grierson, 1906), is affected by the fact established by Fink that the dialect of the Armenian Gipsies shows much closer resemblance to Prakrit than the language of the European Gipsies, and that the dialects of Gipsy spoken throughout Syria and Asia Minor differ profoundly in every respect from the European Gipsy, taken as a whole spoken. The only explanation possible is that the European Gipsy represents the first wave of the Westward movement of an Indian tribe or caste which, dislocated

at a certain period by political disturbances, had travelled through Persia, making a very short stay there, thence to Armenia staying there a little longer, and then possibly to the Byzantine Empire at an indefinite period between 1100 and 1200; and that another clan had followed in their wake, passing through Persia, settling in Armenia and then going farther down to Syria, Egypt and North Africa. These two tribes though of a common remote Indian origin must, however, be kept strictly apart from one another in our investigation, for they stand to each other in the same relation as they stand to the various dialects in India. The linguistic proof of origin can therefore now not go further than to establish the fact that the Gipsy language is in its very essence an originally Indian dialect, enriched in its vocabulary from the languages of the peoples among whom the Gipsies had sojourned, whilst in its grammatical inflection it has slowly been modified, to such an extent that in some cases, like the English or the Servian, barely a skeleton has remained.

Notwithstanding the statements to the contrary, a Gipsy from Greece or Rumania could no longer understand a Gipsy of England or Germany, so profound is the difference. But the words which have entered into the Gipsy language, borrowed as they were from the Greeks, Hungarians, Rumanians, &c., are not only an indication of the route taken—and this is the only use that has hitherto been made of the vocabulary—but they are of the highest importance for fixing the time when the Gipsies had come in contact with these languages. The absence of Arabic is a positive proof that not only did the Gipsies not come via Arabia (as maintained by De Goeje) before they reached Europe, but that they could not even have been living for any length of time in Persia after the Mahomedan conquest, or at any rate that they could not have come in contact with such elements of the population as had already adopted Arabic in addition to Persian. But the form of the Persian words found among European Gipsies, and similarly the form of the Armenian words found in that language, are a clear indication that the Gipsies could not have come in contact with these languages before Persian had assumed its modern form and before Armenian had been changed from the old to the modern form of language. Still more strong and clear is the evidence in the case of the Greek and Rumanian words. If the Gipsies had lived in Greece, as some contend, from very ancient times, some at least of the old Greek words would be found in their language, and similarly the Slavonic words would be of an archaic character, whilst on the contrary we find medieval Byzantine forms, nay, modern Greek forms, among the Gipsy vocabulary collected from Gipsies in Germany or Italy, England or France; a proof positive that they could not have been in Europe much earlier than the approximate date given above of the 11th or 12th century. We then find from a grammatical point of view the same deterioration, say among the English or Spanish Gipsies, as has been noticed in the Gipsy dialect of Armenia. It is no longer Gipsy, but a corrupt English or Spanish adapted to some remnants of Gipsy inflections. The purest form has been preserved among the Greek Gipsies and to a certain extent among the Rumanian. Notably through Miklosich's researches and comparative studies, it is possible to follow the slow change step by step and to prove, at any rate, that, as far as Europe is concerned, the language of these Gipsies was one and the same, and that it was slowly split up into a number of dialects (13 Miklosich, 14 Colocci) which shade off into one another, and which by their transitional forms mark the way in which the Gipsies have travelled, as also proved by historical evidence. The Welsh dialect, known by few, has retained, through its isolation, some of the ancient forms.

Religion, Habits and Customs.—Those who have lived among the Gipsies will readily testify that their religious views are a strange medley of the local faith, which they everywhere embrace, and some old-world superstitions which they have in common with many nations. Among the Greeks they belong to the Greek Church, among the Mahomedans they are Mahomedans, in Rumania they belong to the National Church. In Hungary they are mostly Catholics, according to the faith of the inhabitants of

that country. They have no ethical principles and they do not recognize the obligations of the Ten Commandments. There is extreme moral laxity in the relation of the two sexes, and on the whole they take life easily, and are complete fatalists. At the same time they are great cowards, and they play the rôle of the fool or the jester in the popular anecdotes of eastern Europe. There the poltroon is always a Gipsy, but he is good-humoured and not so malicious as those Gipsies who had endured the hardships of outlawry in the west of Europe.

There is nothing specifically of an Oriental origin in their religious vocabulary, and the words *Devla* (God), *Bang* (devil) or *Trushul* (Cross), in spite of some remote similarity, must be taken as later adaptations, and not as remnants of an old Sky-worship or Serpent-worship. In general their beliefs, customs, tales, &c. belong to the common stock of general folklore, and many of their symbolical expressions find their exact counterpart in Rumanian and modern Greek, and often read as if they were direct translations from these languages. Although they love their children, it sometimes happens that a Gipsy mother will hold her child by the legs and beat the father with it. In Rumania and Turkey among the settled Gipsies a good number are carriers and bricklayers; and the women take their full share in every kind of work, no matter how hard it may be. The nomadic Gipsies carry on the ancient craft of coppersmiths, or workers in metal; they also make sieves and traps, but in the East they are seldom farriers or horse-dealers. They are far-famed for their music, in which art they are unsurpassed. The Gipsy musicians belong mostly to the class who originally were serfs. They were retained at the courts of the boyars for their special talent in reciting old ballads and love songs and their deftness in playing, notably the guitar and the fiddle. The former was used as an accompaniment to the singing of either love ditties and popular songs or more especially in recital or heroic ballads and epic songs; the latter for dances and other amusements. They were the troubadours and minstrels of eastern Europe; the largest collection of Rumanian popular ballads and songs was gathered by G. Dem. Teodorescu from a Gipsy minstrel, Petre Sholkan; and not a few of the songs of the gulsars among the Servians and other Slavonic nations in the Balkans come also from the Gipsies. They have also retained the ancient tunes and airs, from the dreamy "doina" of the Rumanian to the fiery "czardas" of the Hungarian or the stately "hora" of the Bulgarian. Liszt went so far as to ascribe to the Gipsies the origin of the Hungarian national music. This is an exaggeration, as seen by the comparison of the Gipsy music in other parts of south-east Europe; but they undoubtedly have given the most faithful expression to the national temperament. Equally famous is the Gipsy woman for her knowledge of occult practices. She is the real witch; she knows charms to injure the enemy or to help a friend. She can break the charm if made by others. But neither in the one case nor in the other, and in fact as little as in their songs, do they use the Gipsy language. It is either the local language of the natives as in the case of charms, or a slightly Romanized form of Greek, Rumanian or Slavonic. The old Gipsy woman is also known for her skill in palmistry and fortune-telling by means of a special set of cards, the well-known Tarok of the Gipsies. They have also a large stock of fairy tales resembling in each country the local fairy tales, in Greece agreeing with the Greek, and in Rumania with the Rumanian fairy tales. It is doubtful, however, whether they have contributed to the dissemination of these tales throughout Europe, for a large number of Gipsy tales can be shown to have been known in Europe long before the appearance of the Gipsies, and others are so much like those of other nations that the borrowing may be by the Gipsy from the Greek, Slav or Rumanian. It is, however, possible that playing-cards might have been introduced to Europe through the Gipsies. The oldest reference to cards is found in the Chronicle of Nicolaus of Cavellazzo, who says that the cards were first brought into Viterbo in 1370 from the land of the Saracens, probably from Asia Minor or the Balkans. They spread very quickly, but no one has been able as yet to trace definitely the source whence they were first brought. Without

entering here into the history of the playing-cards and of the different forms of the faces and of the symbolical meaning of the different designs, one may assume safely that the cards, before they were used for mere pastime or for gambling, may originally have had a mystical meaning and been used as *sortes* in various combinations. To this very day the oldest form is known by the hitherto unexplained name of Tarock, played in Bologna at the beginning of the 15th century and retained by the French under the form Tarot, connected direct with the Gipsies, "Le Tarot des Bohémiens." It was noted above that the oldest chronicler (Presbyter) who describes the appearance of the Gipsies in 1416 in Germany knows them by their Italian name "Cianos," so evidently he must have known of their existence in Italy previous to any date recorded hitherto anywhere, and it is therefore not impossible that coming from Italy they brought with them also their book of divination.

Physical Characteristics.—As a race they are of small stature, varying in colour from the dark tan of the Arab to the whitish hue of the Servian and the Pole. In fact there are some white-coloured Gipsies, especially in Servia and Dalmatia, and these are often not easily distinguishable from the native peoples, except that they are more lithe and sinewy, better proportioned and more agile in their movements than the thick-set Slavs and the mixed race of the Rumanians. By one feature, however, they are easily distinguishable and recognize one another, viz. by the lustre of their eyes and the whiteness of their teeth. Some are well built; others have the features of a mongrel race, due no doubt to intermarriage with outcasts of other races. The women age very quickly and the mortality among the Gipsies is great, especially among children; among adults it is chiefly due to pulmonary diseases. They love display and Oriental showiness, bright-coloured dresses, ornaments, bangles, &c.; red and green are the colours mostly favoured by the Gipsies in the East. Along with a showy handkerchief or some shining gold coins round their necks, they will wear torn petticoats and no covering on their feet. And even after they have been assimilated and have forgotten their own language they still retain some of the prominent features of their character, such as the love of inordinate display and gorgeous dress; and their moral defects not only remain for a long time as glaring as among those who live the life of vagrants, but even become more pronounced. The Gipsy of to-day is no longer what his forefathers have been. The assimilation with the nations in the near East and the steps taken for the suppression of vagrancy in the West, combine to denationalize the Gipsy and to make "Romani Chib" a thing of the past.

BIBLIOGRAPHY.—The scientific study of the Gipsy language and its origin, as well as the critical history of the Gipsy race, dates (with the notable exception of Grellmann) almost entirely from Pott's researches in 1844.

I. *Collections of Documents, &c.*—Lists of older publications appeared in the books of Pott, Miklosich and the archduke Joseph; Pott adds a critical appreciation of the scientific value of the books enumerated. See also *Verzeichniss von Werken und Aufsätzen . . . über die Geschichte und Sprache der Zigeuner, &c.*, 248 entries (Leipzig, 1886); J. Tipray, "Adalékok a cigányokról szóló irodalomhoz," in *Magyar Könyvszemle* (Budapest, 1877); Ch. G. Leland, *A Collection of Cuttings . . . relating to Gypsies* (1874-1891), bequeathed by him to the British Museum. See also the *Orientalischer Jahresbericht*, ed. Müller (Berlin, 1887 ff.).

II. *History.*—(a) The first appearance of the Gipsies in Europe. Sources: A. F. Oetelius, *Reserua Boicorum scriptores, &c.* (Augsburg, 1763); M. Freher, *Andreas Presbyteri . . . chronicon de Incursibus Boemias . . .* (1602); S. Munster, *Cosmographia . . . &c.* (Basel, 1545); J. Thurnaeus, *Analusium Boiorum libri septem*, ed. T. Zieglerus (Ingolstadt, 1554); M. Crusius, *Annales Svecici, &c.* (Frankfurt, 1595-1596); *Schwedische Chronik . . .* (Frankfurt, 1733); A. Krantz, *Saxonia* (Cologne, 1520); Simon Simeon, *Itineraria, &c.*, ed. J. Nasmyth (Cambridge, 1778). (b) Origin and spread of the Gipsies: H. M. G. Grellmann, *Die Zigeuner, &c.* (1st ed., Dessau and Leipzig, 1783; 2nd ed., Göttingen, 1787); English by M. Roper (London, 1787; 2nd ed., London, 1807), entitled *Dissertation on the Gipsies, &c.*; Carl von Heister, *Ethnographische . . . Notizen über die Zigeuner* (Königsberg, 1842), a third and greatly improved edition of Grellmann and the best book of its kind up to that date; A. F. Pott, *Die Zigeuner in Europa und Asien* (2 vols., Halle, 1844-1845), the first scholarly work with complete and critical bibliography, detailed grammar, etymological dictionary and important

texts: C. Hopf, *Die Einwanderung der Zigeuner in Europa* (Gotha, 1870); F. von Miklosich, "Beiträge zur Kenntnis der Zigeuner-Mundarten," l.-iv. in *Sitzungsber. d. Wiener Acad. d. Wissenschaften* (Vienna, 1874-1878), "Über die Mundarten und die Wanderungen der Zigeuner Europas," l.-xii., in *Denkschriften d. Wiener Acad. d. Wissenschaften* (1872-1880); M. J. de Goeye, *Bijdrage tot de geschiedenis der Zigeuners* (Amsterdam, 1875). English translation by MacRitchie, *Account of the Gipsies of India* (London, 1886); Zedler, *Universal-Lexicon*, vol. lxii., s.v. "Zigeuner," pp. 520-544 containing a rich bibliography; many publications of P. Bataillard from 1844 to 1885; A. Colocci, *Storia d' un popolo errante*, with illustrations, map and Gipsy-Ital. and Ital.-Gipsy glossaries (Turin, 1889); F. H. Groome, "The Gipsies," in E. Magnusson, *National Life and Thought* (1891), and art., "Gipsies" in *Encyclopaedia Britannica* (9th ed., 1879); C. Améro, *Bohémiens, Triganes et Gypsies* (Paris, 1895); M. Kogalnitshan, *Esquisse sur l'histoire, les mœurs et la langue des Cigains* (Berlin, 1837; German trans. Stuttgart, 1840)—valuable more for the historical part than for the linguistic; J. Czacki, *Dziela*, vol. iii. (1844-1845)—for historic data about Gipsies in Poland; I. Kopenicki and J. Mayer, *Charakterystyka języka ludności galicyjskiej* (1876)—for the history and customs of Galician gipsies; *Ungarisch statistische Mittheilungen*, vol. ix. (Budapest, 1895), containing the best statistical information on the Gipsies; V. Dittrich, *A nagy-idei csigányok* (Budapest, 1808); T. H. Schwicker, "Die Zigeuner in Ungarn u. Siebenbürgen," in vol. xii. of *Die Völker Österreich-Ungarns* (Vienna, 1883), and in *Mittheilungen d. K. K. geographischen Gesellschaft* (Vienna, 1896); Dr. J. Polek, *Die Zigeuner in der Bukowina* (Czernowitz, 1908); Ficker, "Die Zigeuner der Bukowina," in *Statist. Monatschrift*, v. 6, *Hundert Jahre 1775-1875: Zigeuner in d. Bukowina* (Vienna, 1875), *Die Völkerstämme der österr.-ungar. Monarchie, &c.* (Vienna, 1869); V. S. Morwood, *Our Gypsies* (London, 1885); D. MacRitchie, *Scottish Gypsies under the Stewarts* (Edinburgh, 1894); F. A. Coelho, "Os Ciganos de Portugal," in *Bol. Soc. Geog.* (Lisbon, 1892); A. Dumbarton, *Gypsy Life in the Mysore Jungle* (London, 1902).

III. *Linguistic.*—[Armenia], F. N. Finck, "Die Sprache der armenischen Zigeuner," in *Mémoires de l'Acad. Imp. des Sciences*, viii. (St. Petersburg, 1907). [Austria-Hungary], R. von Sowa, "Die Mundart der slowakischen Zigeuner" (Göttingen, 1887), and *Die mährische Mundart der Romsprache* (Vienna, 1893); A. J. Puchmayer, *Románi Čib* (Prague, 1821); P. Josef Ješina, *Románi Čib* (in Czech, 1880; in German, 1886); G. Ihatko, *Csigány nyelvetan* (Losoncon, 1877); A. Kalina, *La Langue des Tziganes slovaques* (Pozsen, 1882); the archduke Joseph, *Csigány nyelvetan* (Budapest, 1888); H. von Wislocki, *Die Sprache der transsylvanischen Zigeuner* (Leipzig, 1884). [Brazil], A. T. de Mello Moraes, *Os ciganos no Brasil* (Rio de Janeiro, 1886). [France, the Basques], A. Baudrimont, *Vocabulaire de la langue des Bohémiens habitant les pays basques-français* (Bordeaux, 1862). [Germany], R. Pischel, *Beiträge zur Kenntnis der deutschen Zigeuner* (Halle, 1894); R. von Sowa, "Wörterbuch des Dialekts der deutschen Zigeuner," in *Abhandlungen f. d. Kunde d. Morgenlandes*, xi. 1, very valuable (Leipzig, 1898); F. N. Finck, *Lehrbuch des Dialekts der deutschen Zigeuner*—very valuable (Marburg, 1903). [Great Britain, &c.], Ch. G. Leland, *The English Gypsies and their Language* (London and New York, 1873; 2nd ed., 1874); *The Gypsies of Russia, Austria, England, America, &c.* (London, 1882)—the validity of Leland's conclusions is often doubtful; B. C. Smart and H. J. Crofton, *The Dialect of the English Gypsies* (2nd ed., London, 1875); G. Borrow, *Romano lano-lid* (London, 1874, 1905), *Lavengro*, ed. F. H. Groome (London, 1899). [Rumania], B. Constantinescu, *Probe de Limba și literatura țigănilor din România* (Bucharest, 1878). [Russia, Bessarabia], O. Boethlingk, *Über die Sprache der Zigeuner in Russland* (St Petersburg, 1852; supplement, 1854). [Russia, Caucasus], K. Badjanian, *Cygary. Neshakiko slovi o narbi-jahá zakavkasskikh cyganá* (St Petersburg, 1887); Istomim, *Ciganskij Jazyk* (1900). [Spain], G. H. Borrow, *The Zincali, or an Account of the Gipsies of Spain* (London, 1841, and numerous later editions); R. Campuzano, *Origen . . . de los Gitanos, y diccionario de su dialecto* (2nd ed., Madrid, 1857); A. de C., *Diccionario del dialecto gitano, &c.* (Barcelona, 1851); M. de Sales y Guindale, *Historia, costumbres y dialecto de los Gitanos* (Madrid, 1870); M. de Sales, *El Gitanismo* (Madrid, 1870); J. Tineo Rebollo, *A Chispallá: la lengua gitana: diccionario gitano-español* (Granada, 1900). [Turkey], A. G. Paspati, *Études sur les Tchigianians, ou Bohémiens de l'empire ottoman* (Constantinople, 1870), with grammar, vocabulary, tales and French glossary; very important. [General], John Sampson, "Gypsy Language and Origin," in *Journ. Gypsy Lore Soc.* vol. i. (2nd ser., Liverpool, 1907); J. A. Decourdemanche, *Grammaire du Tchigianá, &c.* (Paris, 1908)—fantastic in some of its philology; F. Kluge, *Retenelche Quellen* (Strassburg, 1901); L. Günther, *Das Retenelch des deutschen Gwainers* (Leipzig, 1905), for the influence of Gipsy on argot; L. Besses, *Diccionario de argot español* (Barcelona); G. A. Grierson, *The P'isáca Languages of North-Western India* (London, 1906), for parallels in Indian dialects; G. Borrow, *Crisole e majaró Lucas . . . El evangelio segun S. Lucas . . .* (London, 1837; 2nd ed., 1872)—this is the only complete translation of any one of the gospels into Gipsy. For other fragments of such translations, see Pott ii. 464-521.

IV. *Folklore, Tales, Songs, &c.*—Many songs and tales are found

in the books enumerated above, where they are mostly accompanied by literal translations. See also Ch. G. Leland, E. H. Palmer and T. Tuckey, *English Gipsy Songs in Romany, with Metrical English Translation* (London, 1875); G. Smith, *Gipsy Life, &c.* (London, 1880); M. Rosenfeld, *Lieder der Zigeuner* (1882); Ch. G. Leland, *The Gypsies* (Boston, Mass., 1882); *Gypsy Stories and Fortune-Telling* (London, 1891); H. von Wilslocki, *Märchen und Sagen der transsylvanischen Zigeuner* (Berlin, 1886)—containing 63 tales, very freely translated; *Volksdichtungen der siebenbürgischen und südungarischen Zigeuner* (Vienna, 1890)—songs, ballads, charms, proverbs and 100 tales; *Vom wandernden Zigeunervolke* (Hamburg, 1890); *Wesen und Wirkungskreis der Zauberfrauen bei den siebenbürgischen Zigeuner* (1891); "Aus dem inneren Leben der Zigeuner," in *Ethnologische Mitteilungen* (Berlin, 1892); R. Pischel, *Bericht über Wilslocki vom wandernden Zigeunervolke* (Göttingen, 1890)—a strong criticism of Wilslocki's method, &c.; F. H. Groome, *Gypsy Folk-Tales* (London, 1899), with historical introduction and a complete and trustworthy collection of 76 gipsy tales from many countries; Katada, *Comes gitanos* (Logroño, 1907); M. Gaster, *Zigeunermärchen aus Rumänien* (1881); "Iganii, &c.," in *Revista pentru Istorie, &c.*, i. p. 409 ff. (Bucharest, 1883); *Gypsy Fairy-Tales "in Folklore. The Journal of the Gipsy-Lore Society* (Edinburgh, 1888-1892) was revived in Liverpool in 1907.

V. Legal Status.—A few of the books in which the legal status of the Gipsies (either alone or in conjunction with "vagrants") is treated from a juridical point of view are here mentioned, also the history of the trial in 1726. J. B. Weissenbruch, *Ausführliche Relation von der famosen Zigeuner-Diebes-Mord und Räuber* (Frankfurt and Leipzig, 1727); A. Ch. Thomasius, *Tractatus juridica de vagabundo, &c.* (Leipzig, 1731); F. Ch. B. Avé-Lallemant, *Das deutsche Casuertum, &c.* (Leipzig, 1858-1862); V. de Rochas, *Les Parias de France et d'Espagne* (Paris, 1876); P. Chuchul, *Zum Kampfe gegen Landstreicher und Bettler* (Kassel, 1881); R. Breithaupt, *Die Zigeuner und der deutsche Staat* (Würzburg, 1907); G. Steinhäuser, *Geschichte der deutschen Kultur* (Leipzig and Vienna, 1904). (M. G.)

GIRAFFE, a corruption of *Zardfah*, the Arabic name for the tallest of all mammals, and the typical representative of the family *Giraffidae*, the distinctive characters of which are given in the article *PECORA*, where the systematic position of the group is indicated. The classic term "camelopard," probably introduced when these animals were brought from North Africa to the Roman amphitheatre, has fallen into complete disuse.

In common with the okapi, giraffes have skin-covered horns on the head, but in these animals, which form the genus *Giraffa*, these appendages are present in both sexes; and there is often an unpaired one in advance of the pair on the forehead. Among other characteristics of these animals may be noticed the great length of the neck and limbs, the complete absence of lateral toes and the long and tufted tail. The tongue is remarkable for its great length, measuring about 17 in. in the dead animal, and for its great elasticity and power of muscular contraction while living. It is covered with numerous large papillae, and forms, like the trunk of the elephant, an admirable organ for the examination and prehension of food. Giraffes are inhabitants of open country, and owing to their length of neck and long flexible tongues are enabled to browse on tall trees, mimosas being favourites. To drink or graze they are obliged to straddle the fore-legs apart; but they seldom feed on grass and are capable of going long without water. When standing among mimosas they so harmonize with their surroundings that they are difficult of detection. Formerly giraffes were found in large herds, but persecution has reduced their number and led to their extermination from many districts. Although in late Tertiary times widely spread over southern Europe and India, giraffes are now confined to Africa south of the Sahara.

Apart from the distinct Somali giraffe (*Giraffa reticulata*), characterized by its deep liver-red colour marked with a very coarse network of fine white lines, there are numerous local forms of the ordinary giraffe (*Giraffa camelopardalis*). The northern races, such as the Nubian *G. c. typica* and the Kordofan *G. c. antiquorum*, are characterized by the large frontal horn of the bulls, the white legs, the network type of coloration and the pale tint. The latter feature is specially developed in the Nigerian *G. c. peralta*, which is likewise of the northern type. The Baringo *G. c. rothschildi* also has a large frontal horn and white legs, but the spots in the bulls are very dark and those of the females jagged. In the Kilimanjaro *G. c. tippelskirchi* the frontal horn

is often developed in the bulls, but the legs are frequently spotted to the fetlocks. Farther south the frontal horn tends to disappear more or less completely, as in the Angola *G. c. angolensis*, the Transvaal *G. c. wordii* and the Cape *G. c. capensis*, while the legs are fully spotted and the colour-pattern on the body (especially in the last-named) is more of a blotched type, that



The North African or Nubian Giraffe (*Giraffa camelopardalis*).

is to say, consists of dark blotches on a fawn ground, instead of a network of light lines on a dark ground.

For details, see a paper on the subspecies *Giraffa camelopardalis*, by R. Lydekker in the *Proceedings of the Zoological Society of London* for 1904. (R. L.)

GIRALDI, GIGLIO GREGORIO [LILIVS GREGORIUS GYRALDUS] (1479-1552), Italian scholar and poet, was born on the 14th of June 1479, at Ferrara, where he early distinguished himself by his talents and acquirements. On the completion of his literary course he removed to Naples, where he lived on familiar terms with Jovianus Pontanus and Sannazaro; and subsequently to Lombardy, where he enjoyed the favour of the Mirandola family. At Milan in 1507 he studied Greek under Chalcondylas; and shortly afterwards, at Modena, he became tutor to Erolo (afterwards Cardinal) Rangone. About the year 1514 he removed to Rome, where, under Clement VII., he held the office of apostolic protonotary; but having in the sack of that city (1527), which almost coincided with the death of his patron Cardinal Rangone, lost all his property, he returned in poverty once more to Mirandola, whence again he was driven by the troubles consequent on the assassination of the reigning prince in 1533. The rest of his life was one long struggle with ill-health, poverty and neglect; and he is alluded to with sorrowful regret by Montaigne in one of his *Essays* (i. 34), as having, like Sebastian Castalio, ended his days in utter destitution. He died at Ferrara in February 1552; and his epitaph makes touching and graceful allusion to the sadness of his end. Giraldi was a man of very

extensive erudition; and numerous testimonies to his profundity and accuracy have been given both by contemporary and by later scholars. His *Historia de diis gentium* marked a distinctly forward step in the systematic study of classical mythology; and by his treatises *De annis et mensibus*, and on the *Calendarium Romanum et Graecum*, he contributed to bring about the reform of the calendar, which was ultimately effected by Pope Gregory XIII. His *Progymnasma adversus literas et literatos* deserves mention at least among the curiosities of literature; and among his other works to which reference is still occasionally made are *Historiae poetarum Graecorum ac Latinorum*; *De poetis suorum temporum*; and *De sepultura ac vario sepeliendi ritu*. Giraldis was also an elegant Latin poet.

His *Opera omnia* were published at Leiden in 1696.

GIRALDI, GIOVANNI BATTISTA (1504–1573), surnamed **CYNTHIUS**, **CINTHEO** or **CINTIO**, Italian novelist and poet, born at Ferrara in November 1504, was educated at the university of his native town, where in 1525 he became professor of natural philosophy, and, twelve years afterwards, succeeded Celio Calcagnini in the chair of belles-lettres. Between 1542 and 1560 he acted as private secretary, first to Ercole II. and afterwards to Alphonso II. of Este; but having, in connexion with a literary quarrel in which he had got involved, lost the favour of his patron in the latter year, he removed to Mondovi, where he remained as a teacher of literature till 1568. Subsequently, on the invitation of the senate of Milan, he occupied the chair of rhetoric at Pavia till 1573, when, in search of health, he returned to his native town, where on the 30th of December he died. Besides an epic entitled *Ercole* (1557), in twenty-six cantos, Giraldis wrote nine tragedies, the best known of which, *Orbecche*, was produced in 1541. The sanguinary and disgusting character of the plot of this play, and the general poverty of its style, are, in the opinion of many of its critics, almost fully redeemed by occasional bursts of genuine and impassioned poetry; of one scene in the third act in particular it has even been affirmed that, if it alone were sufficient to decide the question, the *Orbecche* would be the finest play in the world. Of the prose works of Giraldis the most important is the *Hecatommithi* or *Ecatomiti*, a collection of tales told somewhat after the manner of Boccaccio, but still more closely resembling the novels of Giraldis's contemporary Bandello, only much inferior in workmanship to the productions of either author in vigour, liveliness and local colour. Something, but not much, however, may be said in favour of their professed claim to represent a higher standard of morality. Originally published at Montereale, Sicily, in 1565, they were frequently reprinted in Italy, while a French translation by Chappuys appeared in 1583 and one in Spanish in 1590. They have a peculiar interest to students of English literature, as having furnished, whether directly or indirectly, the plots of *Measure for Measure* and *Othello*. That of the latter, which is to be found in the *Hecatommithi* (iii. 7), is conjectured to have reached Shakespeare through the French translation; while that of the former (*Hecat.* viii. 5) is probably to be traced to Whetstone's *Promos and Cassandra* (1578), an adaptation of Cinthio's story, and to his *Heptamerone* (1582), which contains a direct English translation. To Giraldis also must be attributed the plot of Beaumont and Fletcher's *Custom of the Country*.

GIRALDUS CAMBRENSIS (1146?–1220), medieval historian, also called **GERALD DE BARRI**, was born in Pembrokeshire. He was the son of William de Barri and Auoharat, a daughter of Gerald, the ancestors of the Fitzgeralds and the Welsh princess, Nesta, formerly mistress of King Henry I. Falling under the influence of his uncle, David Fitzgerald, bishop of St David's, he determined to enter the church. He studied at Paris, and his works show that he had applied himself closely to the study of the Latin poets. In 1172 he was appointed to collect tithes in Wales, and showed such vigour that he was made archdeacon. In 1176 an attempt was made to elect him bishop of St David's, but Henry II. was unwilling to see any one with powerful native connexions a bishop in Wales. In 1180, after another visit to Paris, he was appointed commissary to the bishop of St David's,

who had ceased to reside. But Giraldis threw up his post, indignant at the indifference of the bishop to the welfare of his see. In 1184 he was made one of the king's chaplains, and was elected to accompany Prince John on his voyage to Ireland. While there he wrote a *Topographia Hibernica*, which is full of information, and a strongly prejudiced history of the conquest, the *Expugnatio Hibernica*. In 1186 he read his work with great applause before the masters and scholars of Oxford. In 1188 he was sent into Wales with the primate Baldwin to preach the Third Crusade. Giraldis declares that the mission was highly successful; in any case it gave him the material for his *Itinerarium Cambrense*, which is, after the *Expugnatio*, his best known work. He accompanied the archbishop, who intended him to be the historian of the Crusade, to the continent, with the intention of going to the Holy Land. But in 1189 he was sent back to Wales by the king, who knew his influence was great, to keep order among his countrymen. Soon after he was absolved from his crusading vow. According to his own statements, which often tend to exaggeration, he was offered both the sees of Bangor and Llandaff, but refused them. From 1192 to 1198 he lived in retirement at Lincoln and devoted himself to literature. It is probably during this period that he wrote the *Gemma ecclesiastica* (discussing disputed points of doctrine, ritual, &c.) and the *Vita S. Remigii*. In 1198 he was elected bishop of St David's. But Hubert Walter, the archbishop of Canterbury, was determined to have in that position no Welshman who would dispute the metropolitan pretensions of the English primates. The king, for political reasons, supported Hubert Walter. For four years Giraldis exerted himself to get his election confirmed, and to vindicate the independence of St David's from Canterbury. He went three times to Rome. He wrote the *De jure Menoviensis ecclesiae* in support of the claims of his diocese. He made alliances with the princes of North and South Wales. He called a general synod of his diocese. He was accused of stirring up rebellion among the Welsh, and the justiciar proceeded against him. At length in 1202 the pope annulled all previous elections, and ordered a new one. The prior of Llanthony was finally elected. Gerald was immediately reconciled to the king and archbishop; the utmost favour was shown to him; even the expenses of his unsuccessful election were paid. He spent the rest of his life in retirement, though there was some talk of his being made a cardinal. He certainly survived John.

The works of Giraldis are partly polemical and partly historical. His value as a historian is marred by his violent party spirit; some of his historical tracts, such as the *Liber de instructione principum* and the *Vita Galfridi Archiepiscopi Eboracensis*, seem to have been designed as political pamphlets. Henry II., Hubert Walter and William Longchamp, the chancellor of Richard I., are the objects of his worst invectives. His own pretensions to the see of St David are the motive of many of his misrepresentations. But he is one of the most vivid and witty of our mediæval historians.

See the Rolls edition of his works, ed. J. S. Brewer, J. F. Dimock and G. F. Warner in 8 vols. (London, 1861–1891), some of which have valuable introductions.

GIRANDOLE (from the Ital. *girandola*), an ornamental branched candlestick of several lights. It came into use about the second half of the 17th century, and was commonly made and used in pairs. It has always been, comparatively speaking, a luxurious appliance for lighting, and in the great 18th-century period of French house decoration the famous *ciseleurs* designed some exceedingly beautiful examples. A great variety of metals has been used for the purpose—sometimes, as in the case of the candlestick, girandoles have been made in hard woods. Gilded bronze has been a very frequent medium, but for table purposes silver is still the favourite material.

GIRARD, JEAN BAPTISTE [known as "Le Père Girard" or "Le Père Gregoire"] (1765–1850), French-Swiss educationalist, was born at Fribourg and educated for the priesthood at Lucerne. He was the fifth child in a family of fourteen, and his gift for teaching was early shown at home in helping his mother with the

younger children; and after passing through his novitiate he spent some time as an instructor in convents, notably at Würzburg (1785-1788). Then for ten years he was busy with religious duty. In 1798, full of Kantian ideas, he published an essay outlining a scheme of national Swiss education; and in 1804 he began his career as a public teacher, first in the elementary school at Fribourg (1805-1823), then (being driven away by Jesuit hostility) in the gymnasium at Lucerne till 1834, when he retired to Fribourg and devoted himself with the production of his books on education, *De l'enseignement régulier de la langue maternelle* (1834, 9th ed. 1894; Eng. trans. by Lord Ebrington, *The Mother Tongue*, 1847), and *Cours éducatif* (1844-1846). Father Girard's reputation and influence as an enthusiast in the cause of education became potent not only in Switzerland, where he was hailed as a second Pestalozzi, but in other countries. He had a genius for teaching, his method of stimulating the intelligence of the children at Fribourg and interesting them actively in learning, and not merely cramming them with rules and facts, being warmly praised by the Swiss educationalist François Naville (1784-1846) in his treatise on public education (1832). His undogmatic method and his Liberal Christianity brought him into conflict with the Jesuits, but his aim was, in all his teaching, to introduce the moral idea into the minds of his pupils by familiarizing them with the right or wrong working of the facts he brought to their attention, and thus to elevate character all through the educational curriculum.

GIRARD, PHILIPPE HENRI DE (1775-1845), French mechanic, was born at Lourmarin, Vaucluse, on the 1st of February 1775. He is chiefly known in connexion with flax-spinning machinery. Napoleon having in 1810 decreed a reward of one million francs to the inventor of the best machine for spinning flax, Girard succeeded in producing what was required. But he never received the promised reward, although in 1853, after his death, a comparatively small pension was voted to his heirs, and having relied on the money to pay the expenses of his invention he got into serious financial difficulties. He was obliged, in 1815, to abandon the flax mills he had established in France, and at the invitation of the emperor of Austria founded a flax mill and a factory for his machines at Hirtenberg. In 1825, at the invitation of the emperor Alexander I. of Russia, he went to Poland, and erected near Warsaw a flax manufactory, round which grew up a village which received the name of Girardow. In 1838 he built a steamer to run on the Danube. He did not return to Paris till 1844, where he still found some of his old creditors ready to press their claims, and he died in that city on the 26th of August 1845. He was also the author of numerous minor inventions.

GIRARD, STEPHEN (1750-1831), American financier and philanthropist, founder of Girard College in Philadelphia, was born in a suburb of Bordeaux, France, on the 20th of May 1750. He lost the sight of his right eye at the age of eight and had little education. His father was a sea captain, and the son cruised to the West Indies and back during 1764-1773, was licensed captain in 1773, visited New York in 1774, and thence with the assistance of a New York merchant began to trade to and from New Orleans and Port au Prince. In May 1776 he was driven into the port of Philadelphia by a British fleet and settled there as a merchant; in June of the next year he married Mary (Polly) Lum, daughter of a shipbuilder, who, two years later, after Girard's becoming a citizen of Pennsylvania (1778), built for him the "Water Witch," the first of a fleet trading with New Orleans and the West Indies—most of Girard's ships being named after his favourite French authors, such as "Rousseau," "Voltaire," "Hévétius" and "Montesquieu." His beautiful young wife became insane and spent the years from 1790 to her death in 1815 in the Pennsylvania Hospital. In 1810 Girard used about a million dollars deposited by him with the Barings of London for the purchase of shares of the much depreciated stock of the Bank of the United States—a purchase of great assistance to the United States government in bolstering European confidence in its securities. When the Bank was not rechartered the building and the cashier's house in Philadelphia were purchased

at a third of the original cost by Girard, who in May 1812 established the Bank of Stephen Girard. He subscribed in 1814 for about 95% of the government's war loan of \$5,000,000, of which only \$20,000 besides had been taken, and he generously offered at par shares which upon his purchase had gone to a premium. He pursued his business vigorously in person until the 12th of February 1830, when he was injured in the street by a truck; he died on the 26th of December 1831. His public spirit had been shown during his life not only financially but personally; in 1793, during the plague of yellow fever in Philadelphia, he volunteered to act as manager of the wretched hospital at Bush Hill, and with the assistance of Peter Helm had the hospital cleansed and its work systematized; again during the yellow fever epidemic of 1797-1798 he took the lead in relieving the poor and caring for the sick. Even more was his philanthropy shown in his disposition by will of his estate, which was valued at about \$7,500,000, and doubtless the greatest fortune accumulated by any individual in America up to that time. Of his fortune he bequeathed \$116,000 to various Philadelphia charities, \$500,000 to the same city for the improvement of the Delaware water front, \$300,000 to Pennsylvania for internal improvements, and the bulk of his estate to Philadelphia, to be used in founding a school or college, in providing a better police system, and in making municipal improvements and lessening taxation. Most of his bequest to the city was to be used for building and maintaining a school "to provide for such a number of poor male white orphan children . . . a better education as well as a more comfortable maintenance than they usually receive from the application of the public funds." His will planned most minutely for the erection of this school, giving details as to the windows, doors, walls, &c.; and it contained the following phrase: "I enjoin and require that no ecclesiastic, missionary or minister of any sect whatsoever, shall ever hold or exercise any duty whatsoever in the said college; nor shall any such person ever be admitted for any purpose, or as a visitor, within the premises appropriated to the purposes of the said college. . . . I desire to keep the tender minds of orphans . . . free from the excitements which clashing doctrines and sectarian controversy are so apt to produce." Girard's heirs-at-law contested the will in 1836, and they were greatly helped by a public prejudice aroused by the clause cited; in the Supreme Court of the United States in 1844 Daniel Webster, appearing for the heirs, made a famous plea for the Christian religion, but Justice Joseph Story handed down an opinion adverse to the heirs (*Vidals v. Girard's Executors*). Webster was opposed in this suit by John Sergeant and Horace Binney. Girard specified that those admitted to the college must be white male orphans, of legitimate birth and good character, between the ages of six and ten; that no boy was to be permitted to stay after his eighteenth year; and that as regards admissions preference was to be shown, first to orphans born in Philadelphia, second to orphans born in any other part of Pennsylvania, third to orphans born in New York City, and fourth to orphans born in New Orleans. Work upon the buildings was begun in 1833, and the college was opened on the 1st of January 1848, a technical point of law making instruction conditioned upon the completion of the five buildings, of which the principal one, planned by Thomas Ustick Walter (1804-1887), has been called "the most perfect Greek temple in existence." To a sarcophagus in this main building the remains of Stephen Girard were removed in 1851. In the 40 acres of the college grounds there were in 1909 18 buildings (valued at \$3,350,000), 1513 pupils, and a total "population," including students, teachers and all employes, of 1907. The value of the Girard estate in the year 1907 was \$35,000,000, of which \$550,000 was devoted to other charities than Girard College. The control of the college was under a board chosen by the city councils until 1860, when by act of the legislature it was transferred to trustees appointed by the Common Pleas judges of the city of Philadelphia. The course of training is partly industrial—for a long time graduates were indentured till they came of age—but it is also preparatory to college entrance.

See H. A. Ingram, *The Life and Character of Stephen Girard* (Philadelphia, 1884), and George P. Rupp, "Stephen Girard—Merchant and Mariner," in *1840-1898: Semi-Centennial of Girard College* (Philadelphia, 1898).

GIRARDIN, DELPHINE DE (1804-1855), French author, was born at Aix-la-Chapelle on the 26th of January 1804. Her mother, the well-known Madame Sophie Gay, brought her up in the midst of a brilliant literary society. She published two volumes of miscellaneous pieces, *Essais poétiques* (1824) and *Nouveaux Essais poétiques* (1825). A visit to Italy in 1827, during which she was enthusiastically welcomed by the literati of Rome and even crowned in the capitol, was productive of various poems, of which the most ambitious was *Napoléon* (1833). Her marriage in 1831 to Émile de Girardin (see below) opened up a new literary career. The contemporary sketches which she contributed from 1836 to 1839 to the feuilleton of *La Presse*, under the nom de plume of Charles de Launay, were collected under the title of *Lettres parisiennes* (1843), and obtained a brilliant success. *Contes d'une vieille fille à ses neveux* (1832), *La Canne de Monsieur de Balsac* (1836) and *Il ne faut pas jouer avec la douleur* (1853) are among the best-known of her romances; and her dramatic pieces in prose and verse include *L'École des journalistes* (1840), *Judith* (1843), *Cleopâtre* (1847), *Lady Tartufe* (1853), and the one-act comedies, *C'est la faute du mari* (1851), *La Joie fait peur* (1854), *Le Chapeau d'un horloger* (1854) and *Une Femme qui déteste son mari*, which did not appear till after the author's death. In the literary society of her time Madame Girardin exercised no small personal influence, and among the frequenters of her drawing-room were Théophile Gautier and Balzac, Alfred de Musset and Victor Hugo. She died on the 29th of June 1855. Her collected works were published in six volumes (1860-1861).

See Sainte-Beuve, *Causeries du lundi*, t. iii.; G. de Moléna, "Les Femmes poètes," in *Revue des deux mondes* (July 1842); Taxile Delord, *Les Mémoires littéraires* (1860); *L'Esprit de Madame Girardin, avec une préface par M. Lamarino* (1862); G. d'Heilly, *Madame de Girardin, sa vie et ses œuvres* (1868); Imbert de Saint Amand, *Mme de Girardin* (1875).

GIRARDIN, ÉMILE DE (1802-1881), French publicist, was born, not in Switzerland in 1806 of unknown parents, but (as was recognised in 1837) in Paris in 1802, the son of General Alexandre de Girardin and of Madame Dupuy, wife of a Parisian advocate. His first publication was a novel, *Émile*, dealing with his birth and early life, and appeared under the name of Girardin in 1827. He became inspector of fine arts under the Martignac ministry just before the revolution of 1830, and was an energetic and passionate journalist. Besides his work on the daily press he issued miscellaneous publications which attained an enormous circulation. His *Journal des connaissances utiles* had 120,000 subscribers, and the initial edition of his *Almanach de France* (1834) ran to a million copies. In 1836 he inaugurated cheap journalism in a popular Conservative organ, *La Presse*, the subscription to which was only forty francs a year. This undertaking involved him in a duel with Armand Carrel, the fatal result of which made him refuse satisfaction to later opponents. In 1839 he was excluded from the Chamber of Deputies, to which he had been four times elected, on the plea of his foreign birth, but was admitted in 1842. He resigned early in February 1847, and on the 24th of February 1848 sent a note to Louis Philippe demanding his resignation and the regency of the duchess of Orleans. In the Legislative Assembly he voted with the Mountain. He pressed eagerly in his paper for the election of Prince Louis Napoleon, of whom he afterwards became one of the most violent opponents. In 1856 he sold *La Presse*, only to resume it in 1865, but its vogue was over, and Girardin started a new journal, *La Liberté*, the sale of which was forbidden in the public streets. He supported Émile Olivier and the Liberal Empire, but plunged into vehement journalism again to advocate war against Prussia. Of his many subsequent enterprises the most successful was the purchase of *Le Petit Journal*, which served to advocate the policy of Thiers, though he himself did not contribute. The crisis of the 16th of May 1877, when Jules Simon fell from power, made him

resume his pen to attack MacMahon and the party of reaction in *La France* and in *Le Petit Journal*. Émile de Girardin married in 1831 Delphine Gay (see above), and after her death in 1855 Guillemette Joséphine Brunold, countess von Tieffenbach, widow of Prince Frederick of Nassau. He was divorced from his second wife in 1872.

The long list of his social and political writings includes: *De la presse périodique au XIX^e siècle* (1837); *De l'instruction publique* (1838); *Études politiques* (1838); *De la liberté de la presse et du journalisme* (1842); *Le Droit au travail au Luxembourg et à l'Assemblée Nationale* (2 vols., 1848); *Les Cinquante-deux* (1849, &c.), a series of articles on current parliamentary questions; *La Politique universelle, décrets de l'avenir* (Brussels, 1852); *Le Condamné du 6 mars* (1867), an account of his own differences with the government in 1867 when he was fined 5000 fr. for an article in *La Liberté*; *Le Dossier de la guerre* (1877), a collection of official documents; *Questions de mon temps, 1830 à 1870*, articles extracted from the daily and weekly press (12 vols., 1858).

GIRARDON, FRANÇOIS (1628-1715), French sculptor, was born at Troyes on the 17th of March 1628. As a boy he had for master a joiner and wood-carver of his native town, named Baudesson, under whom he is said to have worked at the châteaueau of Liébault, where he attracted the notice of Chancellor Séguier. By the chancellor's influence Girardon was first removed to Paris and placed in the studio of François Anguier, and afterwards sent to Rome. In 1652 he was back in France, and seems at once to have addressed himself with something like ignoble subserviency to the task of conciliating the court painter Charles Le Brun. Girardon is reported to have declared himself incapable of composing a group, whether with truth or from motives of policy it is impossible to say. This much is certain, that a very large proportion of his work was carried out from designs by Le Brun, and shows the merits and defects of Le Brun's manner—a great command of ceremonial pomp in presenting his subject, coupled with a large treatment of forms which if it were more expressive might be imposing. The court which Girardon paid to the "premier peintre du roi" was rewarded. An immense quantity of work at Versailles was entrusted to him, and in recognition of the successful execution of four figures for the Bains d'Apollon, Le Brun induced the king to present his protégé personally with a purse of 300 louis, as a distinguishing mark of royal favour. In 1650 Girardon was made member of the Academy, in 1659 professor, in 1674 "adjoint au recteur," and finally in 1695 chancellor. Five years before (1690), on the death of Le Brun, he had also been appointed "inspecteur général des ouvrages de sculpture"—a place of power and profit. In 1699 he completed the bronze equestrian statue of Louis XIV., erected by the town of Paris on the Place Louis le Grand. This statue was melted down during the Revolution, and is known to us only by a small bronze model (Louvre) finished by Girardon himself. His Tomb of Richelieu (church of the Sorbonne) was saved from destruction by Alexandre Lenoir, who received a bayonet thrust in protecting the head of the cardinal from mutilation. It is a capital example of Girardon's work, and the theatrical pomp of its style is typical of the funeral sculpture of the reigns of Louis XIV. and Louis XV.; but amongst other important specimens yet remaining may also be cited the Tomb of Louvois (St Eustache), that of Bignon, the king's librarian, executed in 1656 (St Nicolas du Chardonnet), and decorative sculptures in the Galerie d'Apollon and Chambre du roi in the Louvre. Mention should not be omitted of the group, signed and dated 1699, "The Rape of Proserpine" at Versailles, which also contains the "Bull of Apollo." Although chiefly occupied at Paris Girardon never forgot his native Troyes, the museum of which town contains some of his best works, including the marble busts of Louis XIV. and Maria Theresa. In the hôtel de ville is still shown a medallion of Louis XIV., and in the church of St Rémy a bronze crucifix of some importance—both works by his hand. He died in Paris in 1715.

See Corrad de Breban, *Notices sur la vie et les œuvres de Girardon* (1850).

GIRART DE ROUSSILLON, an epic figure of the Carolingian cycle of romance. In the genealogy of romance he is a son of Doon de Mayence, and he appears in different and irreconcilable

circumstances in many of the *chansons de geste*. The legend of Girard de Roussillon is contained in a *Vie de Girard de Roussillon* (ed. P. Meyer, in *Romania*, 1878), dating from the beginning of the 12th century and written probably by a monk of the abbey of Pothières or of Vezelay, both of which were founded in 860 by Girard; in *Girard de Roussillon*, a *chanson de geste* written early in the 12th century in a dialect midway between French and Provençal, and apparently based on an earlier Burgundian poem; in a 14th century romance in alexandrines (ed. T. J. A. P. Mignard, Paris and Dijon, 1878); and in a prose romance by Jehan Wauquelin in 1447 (ed. L. de Montille, Paris, 1880). The historical Girard, son of Leuthard and Grimildis, was a Burgundian chief who was count of Paris in 837, and embraced the cause of Lothair against Charles the Bald. He fought at Fontenay in 841, and doubtless followed Lothair to Aix. In 855 he became governor of Provence for Lothair's son Charles, king of Provence (d. 863). His wife Bertha defended Vienna unsuccessfully against Charles the Bald in 870, and Girard, who had perhaps aspired to be the titular ruler of the northern part of Provence, which he had continued to administer under Lothair II. until that prince's death in 869, retired with his wife to Avignon, where he died probably in 877, certainly before 879. The tradition of his piety, of the heroism of his wife Bertha, and of his wars with Charles passed into romance; but the historical facts are so distorted that in *Girard de Roussillon* the *trouvère* makes him the opponent of Charles Martel, to whom he stands in the relation of brother-in-law. He is nowhere described in authentic historic sources as of Roussillon. The title is derived from his castle built on Mount Lassois, near Châtillon-sur-Seine. Southern traditions concerning Count Girard, in which he is made the son of Garin de Monglane, are embodied in *Girard de Viane* (13th century) by Bertrand de Bar-sur-l'Aube, and in the *Aspremonte* of Andrea da Barberino, based on the French *chanson of Aspremont*, where he figures as Girard de Frete or de Fratte.¹ *Girard de Viane* is the recital of a siege of Vienne by Charlemagne, and in *Aspremonte* Girard de Fratte leads an army of infidels against Charlemagne. *Girard de Roussillon* was long held to be of Provençal origin, and to be a proof of the existence of an independent Provençal epic, but its Burgundian origin may be taken as proved.

See F. Michel, *Gerard de Roussillon . . . publié en français et en provençal d'après les MSS. de Paris et de Londres* (Paris, 1856); P. Meyer, *Girard de Roussillon* (1884), a translation in modern French with a comprehensive introduction. For *Girard de Viane* (ed. P. Tarbé, Reims, 1850) see L. Gautier, *Épopées françaises*, vol. iv.; F. A. Wulff, *Notice sur les sagas de Magnus et de Geirard* (Lund, 1874).

GIRAUD, GIOVANNI, COUNT (1776-1834), Italian dramatist, of French origin, was born at Rome, and showed a precocious passion for the theatre. His first play, *L'Onestà non si vince*, was successfully produced in 1798. He took part in politics as an active supporter of Pius VI., but was mainly occupied with the production of his plays, and in 1809 became director-general of the Italian theatres. He died at Naples in 1834. Count Giraud's comedies, the best of which are *Gelosie per equivoco* (1807) and *L'Ajo nell' imbarazzo* (1824), were bright and amusing on the stage, but of no particular literary quality.

His collected comedies were published in 1823 and his *Teatro domestico* in 1825.

GIRDLE (O. Eng. *gyrdel*, from *gyrdan*, to gird; cf. Ger. *Gürtel*, Dutch *gordel*, from *gürten* and *gorden*; "gird" and its doublet "girth" together with the other Teutonic cognates have been referred by some to the root *ghar-* to seize, enclose, seen in Gr. *χῆρα*, hand, Lat. *hortus*, garden, and also English yard, garden, garth, &c.), a band of leather or other material worn round the waist, either to confine the loose and flowing outer robes so as to allow freedom of movement, or to fasten and support the garments of the wearer. Among the Romans it was used to confine the *stunicæ*, and it formed part of the dress of the soldier; when a man quitted military service he was said,

¹ It is of interest to note that Freta was the old name for the town of Saint Remy, and that it is close to the site of the ancient town of Glanum, the name of which is possibly preserved in Garin de Monglane, the ancestor of the heroes of the cycle of Guillaume d'Orange.

cingulum deponere, to lay aside the girdle. Money being carried in the girdle, *sonam perdere* signified to lose one's purse, and, among the Greeks, to cut the girdle was to rob a man of his money.

Girdles and girdle-buckles are not often found in Gallo-Roman graves, but in the graves of Franks and Burgundians they are constantly present, often ornamented with bosses of silver or bronze, chased or inlaid. Sidonius Apollinaris speaks of the Franks as belted round the waist, and Gregory of Tours in the 6th century says that a dagger was carried in the Frankish girdle.

In the Anglo-Saxon dress the girdle makes an unimportant figure, and the Norman knights, as a rule, wore their belts under their hauberks. After the Conquest, however, the artificers gave more attention to a piece whose buckle and tongue invited the work of the goldsmith. Girdles of varying richness are seen on most of the western medieval effigies. That of Queen Berengaria lets the long pendant hang below the knee, following a fashion which frequently reappears.

In the latter part of the 13th century the knight's surcoat is girdled with a narrow cord at the waist, while the great belt, which had become the pride of the well-equipped cavalier, loops across the hips carrying the heavy sword aslant over the thighs or somewhat to the left of the wearer.

But it is in the second half of the following century that the knightly belt takes its most splendid form. Under the year 1356 the continuator of the chronicle of Nangis notes that the increase of jewelled belts had mightily enhanced the price of pearls. The belt is then worn, as a rule, girdling the hips at some distance below the waist, being probably supported by hooks as is the belt of a modern infantry soldier. The end of the belt, after being drawn through the buckle, is knotted or caught up after the fashion of the tang of the Garter. The waist girdle either disappears from sight or as a narrow and ornamented strap is worn diagonally to help in the support of the belt. A mass of beautiful ornament covers the whole belt, commonly seen as an unbroken line of bosses enriched with curiously worked roundels or losenges which, when the loose strap-end is abandoned, meet in a splendid morse or clasp on which the enameller and jeweller had wrought their best. About 1420 this fashion tends to disappear, the loose tabards worn over armour in the jousting-yard hindering its display. The belt never regains its importance as an ornament, and, at the beginning of the 16th century, sword and dagger are sometimes seen hanging at the knight's sides without visible support.

In civil dress the magnificent belt of the 14th century is worn by men of rank over the hips of the tight short-skirted coat, and in that century and in the 15th and 16th there are sumptuary laws to check the extravagance of rich girdles worn by men and women whose humble station made them unseemly. Even priests must be rebuked for their silver girdles with baselards hanging from them. Purses, daggers, keys, penners and inkhorns, beads and even books, dangled from girdles in the 15th and early 16th centuries. Afterwards the girdle goes on as a mere strap for holding up the clothing or as a sword-belt. At the Restoration men contrasted the fashion of the court, a light rapier hung from a broad shoulder-belt, with the fashion of the countryside, where a heavy weapon was supported by a narrow waistbelt. Soon afterwards both fashions disappeared. Sword-hangers were concealed by the skirt, and the belt, save in certain military and sporting costumes, has no more been in sight in England. Even as a support for breeches or trousers, the use of braces has gradually supplanted the girdle during the past century.

In most of those parts of the Continent—Brittany, for example—where the peasantry maintains old fashions in clothing, the belt or girdle is still an important part of the clothing. Italian non-commissioned officers find that the Sicilian recruit's main objection to the first bath of his life-time lies in the fact that he must lay down the cherished belt which carries his few valuables. With the Circassian the belt still buckles on an arsenal of pistols and knives.

Folklore and ancient custom are much concerned with the girdle. Bankrupts at one time put it off in open court; French law refused courtesans the right to wear it; Saint Guthlac casts out devils by buckling his girdle round a possessed man; an earl is "a belted earl" since the days when the putting on of a girdle was part of the ceremony of his creation; and fairy tales of half the nations deal with girdles which give invisibility to the wearer.

GIRGA, or **GIRGH**, a town of Upper Egypt on the W. bank of the Nile, 313 m. S.S.E. of Cairo by rail and about 10 m. N.N.E. of the ruins of Abydos. Pop. (1907) 19,893, of whom about one-third are Copts. The town presents a picturesque appearance from the Nile, which at this point makes a sharp bend. A ruined mosque with a tall minaret stands by the river-brink. Many of the houses are of brick decorated with glazed tiles. The town is noted for the excellence of its pottery. Girga is the seat of a Coptic bishop. It also possesses a Roman Catholic monastery, considered the most ancient in the country. As lately as the middle of the 18th century the town stood a quarter of a mile from the river, but is now on the bank, the intervening space having been washed away, together with a large part of the town, by the stream continually encroaching on its left bank.

GIRGENTI (anc. *Agrigentum*; *q.v.*), a town of Sicily, capital of the province which bears its name, and an episcopal see, on the south coast, 58 m. S. by E. of Palermo direct and 84½ m. by rail. Population (1901) 25,024. The town is built on the western summit of the ridge which formed the northern portion of the ancient site; the main street runs from E. to W. on the level, but the side streets are steep and narrow. The cathedral occupies the highest point in the town; it was not founded till the 13th century, taking the place of the so-called temple of Concord. The campanile still preserves portions of its original architecture, but the interior has been modernized. In the chapter-house a famous sarcophagus, with scenes illustrating the myth of Hippolytus, is preserved. There are other scattered remains of 13th-century architecture in the town, while, in the centre of the ancient city, close to the so-called oratory of Phalaris, is the Norman church of S. Nicolo. A small museum in the town contains vases, terra-cottas, a few sculptures, &c. The port of Girgenti, 5½ m. S.W. by rail, now known as Porto Empedocle (population in 1901, 11,529), is the principal place of shipment for sulphur, the mining district beginning immediately north of Girgenti. (T. As.)

GIRISHK, a village and fort of Afghanistan. It stands on the right bank of the Helmund 78 m. W. of Kandahar on the road to Herat; 3641 ft. above the sea. The fort, which is garrisoned from Kandahar and is the residence of the governor of the district (Pushi-i-Rud), has little military value. It commands the fords of the Helmund and the road to Seistan, from which it is about 100 m. distant; and it is the centre of a rich agricultural district. Girishk was occupied by the British during the first Afghan War; and a small garrison of sepoy, under a native officer, successfully withstood a siege of nine months by an overwhelming Afghan force. The Dasht-i-Bak stretches beyond Girishk towards Farah, a level plain of considerable width, which tradition assigns as the field of the final contest for supremacy between Russia and England.

GIRNAR, a sacred hill in Western India, in the peninsula of Kathiawar, 10 m. E. of Junagarh town. It consists of five peaks, rising about 3500 ft. above the sea, on which are numerous old Jain temples, much frequented by pilgrims. At the foot of the hill is a rock, with an inscription of Asoka (2nd century B.C.), and also two other inscriptions (dated 150 and 455 A.D.) of great historical importance.

GIRODET DE ROUSSY, ANNE LOUIS (1767-1824), French painter, better known as Girodet-Trisson, was born at Montargis on the 5th of January 1767. He lost his parents in early youth, and the care of his fortune and education fell to the lot of his guardian, M. Trisson, "médecin de mesdames," by whom he was in later life adopted. After some preliminary studies under a painter named Luquin, Girodet entered the school of David,

and at the age of twenty-two he successfully competed for the Prix de Rome. At Rome he executed his "Hippocrate refusant les présents d'Artaxerxès" and "Endymion dormant" (Louvre), a work which was hailed with acclamation at the Salon of 1792. The peculiarities which mark Girodet's position as the herald of the romantic movement are already evident in his "Endymion." The firm-set forms, the grey cold colour, the hardness of the execution are proper to one trained in the school of David, but these characteristics harmonize ill with the literary, sentimental and picturesque suggestions which the painter has sought to render. The same incongruity marks Girodet's "Danaë" and his "Quatre Saisons," executed for the king of Spain (repeated for Compiègne), and shows itself to a ludicrous extent in his "Fingal" (St Petersburg, Leuchtenberg collection), executed for Napoleon I. in 1802. This work unites the defects of the classic and romantic schools, for Girodet's imagination ardently and exclusively pursued the ideas excited by varied reading both of classic and of modern literature, and the impressions which he received from the external world afforded him little stimulus or check; he consequently retained the mannerisms of his master's practice whilst rejecting all restraint on choice of subject. The credit lost by "Fingal" Girodet regained in 1806, when he exhibited "Scène de Déluge" (Louvre), to which (in competition with the "Sabines" of David) was awarded the decennial prize. This success was followed up in 1808 by the production of the "Reddition de Vienne" and "Atala au Tombeau"—a work which went far to deserve its immense popularity, by a happy choice of subject, and remarkable freedom from the theatricality of Girodet's usual manner, which, however, soon came to the front again in his "Révolte de Caire" (1810). His powers now began to fail, and his habit of working at night and other excesses told upon his constitution; in the Salon of 1812 he exhibited only a "Tête de Vierge"; in 1819 "Pygmalion et Galatée" showed a still further decline of strength; and in 1824—the year in which he produced his portraits of Cathelineau and Bonchamps—Girodet died on the 9th of December.

He executed a vast quantity of illustrations, amongst which may be cited those to the Didot *Virgil* (1798) and to the *Louvre Racine* (1801-1805). Fifty-four of his designs for *Anacreon* were engraved by M. Chatillon. Girodet wasted much time on literary composition, his poem *Le Peintre* (a string of commonplaces), together with poor imitations of classical poets, and essays on *Le Génie* and *La Grâce*, were published after his death (1829), with a biographical notice by his friend M. Coupin de la Couperie; and M. Delécluze, in his *Louis David et son temps*, has also a brief life of Girodet.

GIRONDE, a maritime department of south-western France, formed from four divisions of the old province of Guyenne, viz. Bordelais, Bazadais, and parts of Périgord and Agenais. Area, 4140 sq. m. Pop. (1906) 823,925. It is bounded N. by the department of Charente-Inférieure, E. by those of Dordogne and Lot-et-Garonne, S. by that of Landes, and W. by the Bay of Biscay. It takes its name from the river or estuary of the Gironde formed by the union of the Garonne and Dordogne. The department divides itself naturally into a western and an eastern portion. The former, which is termed the *Landes* (*q.v.*), occupies more than a third of the department, and consists chiefly of morass or sandy plain, thickly planted with pines and divided from the sea by a long line of dunes. These dunes are planted with pines, which, by binding the sand together with their roots, prevent it from drifting inland and afford a barrier against the sea. On the east the dunes are fringed for some distance by two extensive lakes, Carcans and Lacanau, communicating with each other and with the Bay of Arcachon, near the southern extremity of the department. The Bay of Arcachon contains numerous islands, and on the land side forms a vast shallow lagoon, a considerable portion of which, however, has been drained and converted into arable land. The eastern portion of the department consists chiefly of a succession of hill and dale, and, especially in the valley of the Gironde, is very fertile. The estuary of the Gironde is about 45 m. in length, and varies in breadth from 2 to 6 m. It presents a succession of islands and mud banks which divide it into two channels and render navigation somewhat difficult. It is, however, well

buoyed and lighted, and has a mean depth of 21 ft. There are extensive marshes on the right bank to the north of Blaye, and the shores on the left are characterized, especially towards the mouth, by low-lying polders protected by dikes and composed of fertile salt marshes. At the mouth of the Gironde stands the famous tower of Cordouan, one of the finest lighthouses of the French coast. It was built between the years 1585 and 1611 by the architect and engineer Louis de Foix, and added to towards the end of the 18th century. The principal affluent of the Dordogne in this department is the Isle. The feeders of the Garonne are, with the exception of the Dropt, all small. West of the Garonne the only river of importance is the Leyre, which flows into the Bay of Arcachon. The climate is humid and mild and very hot in summer. Wheat, rye, maize, oats and tobacco are grown to a considerable extent. The corn produced, however, does not meet the wants of the inhabitants. The culture of the vine is by far the most important branch of industry carried on (see WINE), the vineyards occupying about one-seventh of the surface of the department. The wine-growing districts are the Médoc, Graves, Côtes, Palus, Entre-deux-Mers and Sauternes. The Médoc is a region of 50 m. in length by about 6 m. in breadth, bordering the left banks of the Garonne and the Gironde between Bordeaux and the sea. The Graves country forms a zone 30 m. in extent, stretching along the left bank of the Garonne from the neighbourhood of Bordeaux to Barsac. The Sauternes country lies to the S.E. of the Graves. The Côtes lie on the right bank of the Dordogne and Gironde, between it and the Garonne, and on the left bank of the Garonne. The produce of the Palus, the alluvial land of the valleys, and of the Entre-deux-Mers, situated on the left bank of the Dordogne, is inferior. Fruits and vegetables are extensively cultivated, the peaches and pears being especially fine. Cattle are extensively raised, the Bazadais breed of oxen and the Bordelais breed of milk-cows being well known. Oyster-breeding is carried on on a large scale in the Bay of Arcachon. Large supplies of resin, pitch and turpentine are obtained from the pine woods, which also supply vine-props, and there are well-known quarries of limestone. The manufactures are various, and, with the general trade, are chiefly carried on at Bordeaux (*q.v.*), the chief town and third port in France. Pauillac, Blaye, Libourne and Arcachon are minor ports. Gironde is divided into the arrondissements of Bordeaux, Blaye, Lesparre, Libourne, Bazas and La Réole, with 49 cantons and 554 communes. The department is served by five railways, the chief of which are those of the Orleans and Southern companies. It forms part of the circumscription of the archbishopric, the appeal-court and the *académie* (educational division) of Bordeaux, and of the region of the XVIII. army corps, the headquarters of which are at that city. Besides Bordeaux, Libourne, La Réole, Bazas, Blaye, Arcachon, St Emilion and St Macaire are the most noteworthy towns and receive separate treatment. Among the other places of interest the chief are Cadillac, on the right bank of the Garonne, where there is a castle of the 16th century, surrounded by fortifications of the 14th century; Labrède, with a feudal château in which Montesquieu was born and lived; Villandraut, where there is a ruined castle of the 13th century; Uzeste, which has a church begun in 1370 by Pope Clement V.; Mazères with an imposing castle of the 14th century; La Sauve, which has a church (11th and 12th centuries) and other remains of a Benedictine abbey; and Ste Foy-la-Grande, a bastide created in 1255 and afterwards a centre of Protestantism, which is still strong there. La Teste (pop. in 1906, 5699) was the capital in the middle ages of the famous lords of Buch.

GIRONDISTS (Fr. *Girondins*), the name given to a political party in the Legislative Assembly and National Convention during the French Revolution (1791-1793). The Girondists were, indeed, rather a group of individuals holding certain opinions and principles in common than an organized political party, and the name was at first somewhat loosely applied to them owing to the fact that the most brilliant exponents of their point of view were deputies from the Gironde. These deputies were twelve in number, six of whom—the lawyers Vergniaud,

Guadet, Gensonne, Grangeneuve and Jay, and the tradesman Jean François Ducos—sat both in the Legislative Assembly and the National Convention. In the Legislative Assembly these represented a compact body of opinion which, though not as yet definitely republican, was considerably more advanced than the moderate royalism of the majority of the Parisian deputies. Associated with these views was a group of deputies from other parts of France, of whom the most notable were Condorcet, Fauchet, Lasource, Isnard, Kersaint, Henri Larivière, and, above all, Jacques Pierre Brissot, Roland and Pétion, elected mayor of Paris in succession to Bailly on the 16th of November 1791. On the spirit and policy of the Girondists Madame Roland, whose *salon* became their gathering-place, exercised a powerful influence (see ROLAND); but such party cohesion as they possessed they owed to the energy of Brissot (*q.v.*), who came to be regarded as their mouthpiece in the Assembly and the Jacobin Club. Hence the name *Brissotins*, coined by Camille Desmoulins, which was sometimes substituted for that of *Girondins*, sometimes closely coupled with it. As strictly party designations these first came into use after the assembling of the National Convention (September 20th, 1792), to which a large proportion of the deputies from the Gironde who had sat in the Legislative Assembly were returned. Both were used as terms of opprobrium by the orators of the Jacobin Club, who freely denounced "the Royalists, the Federalists, the Brissotins, the Girondins and all the enemies of the democracy" (F. Aulard, *Soc. des Jacobins*, vi. 531).

In the Legislative Assembly the Girondists' represented the principle of democratic revolution within and of patriotic defiance to the European powers without. They were all-powerful in the Jacobin Club (see JACOBINS), where Brissot's influence had not yet been ousted by Robespierre, and they did not hesitate to use this advantage to stir up popular passion and intimidate those who sought to stay the progress of the Revolution. They compelled the king in 1792 to choose a ministry composed of their partisans—among them Roland, Dumouriez, Clavière and Servan; and it was they who forced the declaration of war against Austria. In all this there was no apparent line of cleavage between "La Gironde" and the Mountain. *Montagnards* and Girondists alike were fundamentally opposed to the monarchy; both were democrats as well as republicans; both were prepared to appeal to force in order to realize their ideals; in spite of the accusation of "federalism" freely brought against them, the Girondists desired as little as the Montagnards to break-up the unity of France. Yet from the first the leaders of the two parties stood in avowed opposition, in the Jacobin Club as in the Assembly. It was largely a question of temperament. The Girondists were idealists, doctrinaires and theorists rather than men of action; they encouraged, it is true, the "armed petitions" which resulted, to their dismay, in the *émeute* of the 20th of June; but Roland, turning the ministry of the interior into a publishing office for tracts on the civic virtues, while in the provinces riotous mobs were burning the châteaux unchecked, is more typical of their spirit. With the ferocious fanaticism or the ruthless opportunism of the future organizers of the Terror they had nothing in common. As the Revolution developed they trembled at the anarchic forces they had helped to unchain, and tried in vain to curb them. The overthrow of the monarchy on the 10th of August and the massacres of September were not their work, though they claimed credit for the results achieved.

The crisis of their fate was not slow in coming. It was they who proposed the suspension of the king and the summoning of the National Convention; but they had only consented to overthrow the kingship when they found that Louis XVI. was impervious to their counsels, and, the republic once established, they were anxious to arrest the revolutionary movement which they had helped to set in motion. As Daunou shrewdly observes in his *Mémoires*, they were too cultivated and too polished to retain their popularity long in times of disturbance, and were therefore the more inclined to work for the establishment of order, which would mean the guarantee of their own

power.¹ Thus the Girondists, who had been the Radicals of the Legislative Assembly, became the Conservatives of the Convention. But they were soon to have practical experience of the fate that overtakes those who attempt to arrest in mid-career a revolution they themselves have set in motion. The ignorant populace, for whom the promised social millennium had by no means dawned, saw in an attitude seemingly so inconsistent obvious proof of corrupt motives, and there were plenty of prophets of misrule to encourage the delusion—orators of the clubs and the street corners, for whom the restoration of order would have meant well-deserved obscurity. Moreover, the *Septembriseurs*—Robespierre, Danton, Marat and their lesser satellites—realized that not only their influence but their safety depended on keeping the Revolution alive. Robespierre, who hated the Girondists, whose lustre had so long obscured his own, had proposed to include them in the proscription lists of September; the Mountain to a man desired their overthrow.

The crisis came in March 1793. The Girondists, who had a majority in the Convention, controlled the executive council and filled the ministry, believed themselves invincible. Their orators had no serious rivals in the hostile camp; their system was established in the purest reason. But the Montagnards made up by their fanatical, or desperate, energy and boldness for what they lacked in talent or in numbers. They had behind them the revolutionary Commune, the Sections and the National Guard of Paris, and they had gained control of the Jacobin club, where Brissot, absorbed in departmental work, had been superseded by Robespierre. And as the motive power of this formidable mechanism of force they could rely on the native suspiciousness of the Parisian populace, exaggerated now into madness by famine and the menace of foreign invasion. The Girondists played into their hands. At the trial of Louis XVI. the bulk of them had voted for the "appeal to the people," and so laid themselves open to the charge of "royalism"; they denounced the domination of Paris and summoned provincial levies to their aid, and so fell under suspicion of "federalism," though they rejected Buzot's proposal to transfer the Convention to Versailles. They strengthened the revolutionary Commune by decreeing its abolition, and then withdrawing the decree at the first sign of popular opposition; they increased the prestige of Marat by prosecuting him before the Revolutionary Tribunal, where his acquittal was a foregone conclusion. In the suspicious temper of the times this vacillating policy was doubly fatal. Marat never ceased his denunciations of the "*faction des hommes d'État*," by which France was being betrayed to her ruin, and his parrot cry of "*Nous sommes trahis!*" was re-echoed from group to group in the streets of Paris. The Girondists, for all their fine phrases, were sold to the enemy, as Lafayette, Dumouriez and a hundred others—once popular favourites—had been sold.

The hostility of Paris to the Girondists received a fateful advertisement by the election, on the 15th of February 1793, of the ex-Girondist Jean Nicolas Pache (1746-1823) to the mayoralty. Pache had twice been minister of war in the Girondist government; but his incompetence had laid him open to strong criticism, and on the 4th of February he had been superseded by a vote of the Convention. This was enough to secure him the suffrages of the Paris electors ten days later, and the Mountain was strengthened by the accession of an ally whose one idea was to use his new power to revenge himself on his former colleagues. Pache, with Chaumette, *procureur* of the Commune, and Hébert, deputy *procureur*, controlled the armed organization of the Paris Sections, and prepared to turn this against the Convention. The abortive *émeute* of the 10th of March warned the Girondists of their danger, but the Commission of Twelve appointed on the 18th of May, the arrest of Marat and Hébert, and other precautionary measures, were defeated by the popular risings of the 27th and 31st of May, and, finally, on the 2nd of June, Hanriot with the National

Guards purged the Convention of the Girondists. Isnard's threat, uttered on the 25th of May, to march France upon Paris had been met by Paris marching upon the Convention.

The list drawn up by Hanriot, and endorsed by a decree of the intimidated Convention, included twenty-two Girondist deputies and ten members of the Commission of Twelve, who were ordered to be detained at their lodgings "under the safeguard of the people." Some submitted, among them Gensonné, Guadet, Vergniaud, Pétion, Birotteau and Boyer-Fonfrède. Others, including Brissot, Louvet, Buzot, Lasource, Grangeneuve, Larivière and Bergoing, escaped from Paris and, joined later by Guadet, Pétion and Birotteau, set to work to organize a movement of the provinces against the capital. This attempt to stir up civil war determined the wavering and frightened Convention. On the 13th of June it voted that the city of Paris had deserved well of the country, and ordered the imprisonment of the detained deputies, the filling up of their places in the Assembly by their *suppléants*, and the initiation of vigorous measures against the movement in the provinces. The excuse for the Terror that followed was the imminent peril of France, menaced on the east by the advance of the armies of the Coalition, on the west by the Royalist insurrection of La Vendée, and the need for preventing at all costs the outbreak of another civil war. The assassination of Marat by Charlotte Corday (*q.v.*) only served to increase the unpopularity of the Girondists and to seal their fate. On the 28th of July a decree of the Convention proscribed, as traitors and enemies of their country, twenty-one deputies, the final list of those sent for trial comprising the names of Antiboul, Boilleau the younger, Boyer-Fonfrède, Brissot, Carra, Duchastel, the younger Ducos, Dufriche de Valazé, Duprat, Fauchet, Gardien, Gensonné, Lacaze, Lasource, Lauze-Deperret, Lehardi, Lesterpt-Beauvais, the elder Minvielle, Sillery, Vergniaud and Viger, of whom five were deputies from the Gironde. The names of thirty-nine others were included in the final *acte d'accusation*, accepted by the Convention on the 24th of October, which stated the crimes for which they were to be tried as their perfidious ambition, their hatred of Paris, their "federalism" and, above all, their responsibility for the attempt of their escaped colleagues to provoke civil war.

The trial of the twenty-one, which began before the Revolutionary Tribunal on the 24th of October, was a mere farce, the verdict a foregone conclusion. On the 31st they were borne to the guillotine in five tumbrils, the corpse of Dufriche de Valazé—who had killed himself—being carried with them. They met death with great courage, singing the refrain "*Plutôt la mort que l'esclavage!*" Of those who escaped to the provinces the greater number, after wandering about singly or in groups, were either captured and executed or committed suicide, among them Barbaroux, Buzot, Condorcet, Grangeneuve, Guadet, Kersaint, Pétion, Rabaut de Saint-Étienne and Rebecqui. Roland had killed himself at Rouen on the 15th of November, a week after the execution of his wife. Among the very few who finally escaped was Jean Baptiste Louvet, whose *Mémoires* give a thrilling picture of the sufferings of the fugitives. Incidentally they prove, too, that the sentiment of France was for the time against the Girondists, who were proscribed even in their chief centre, the city of Bordeaux. The survivors of the party made an effort to re-enter the Convention after the fall of Robespierre, but it was not until the 5th of March 1795 that they were formally reinstated. On the 3rd of October of the same year (11 Vendémiaire, year III.) a solemn fête in honour of the Girondist "martyrs of liberty" was celebrated in the Convention. See also the article FRENCH REVOLUTION and separate biographies.

Of the special works on the Girondists Lamartine's *Histoire des Girondins* (2 vols., Paris, 1847, new ed. 1902, in 6 vols.) is rhetoric rather than history and is untrustworthy; the *Histoire des Girondins*, by A. Gramier de Cassagnac (Paris, 1860) led to the publication of a *Protestation* by J. Guadet, a nephew of the Girondist orator, which was followed by his *Les Girondins, leur vie privée, leur vie publique, leur proscription et leur mort* (2 vols., Paris, 1861, new ed. 1890); with which cf. Alary, *Les Girondins par Guadet* (Bordeaux, 1863); also Charles Vatet, *Charlotte de Corday et les Girondins: pièces classées et annotées* (3 vols., Paris, 1864-1872); *Recherches historiques*

¹Daunou, "Mémoires pour servir à l'hist. de la Convention Nationale," p. 409, vol. xii. of M. Fr. Barrière, *Bibl. des mém. rel. à l'hist. de la France*, &c. (Paris, 1863).

sur les Girondins (2 vols., ib. 1873); Ducoq, *Les Trois Girondins* (Madame Roland, Charlotte Corday, Madame Bouquoy) et les Girondins (ib. 1896); Edmond Biré, *La Légende des Girondins* (Paris, 1881, new ed. 1896); also Helen Maria Williams, *State of Manners and Opinions in the French Republic towards the close of the 18th Century* (2 vols., London, 1801). Memoirs or fragments of memoirs also exist by particular Girondists, e.g. Barbaroux, Pétion, Louvet, Madame Roland. See, further, the bibliography to the article FRENCH REVOLUTION. (W. A. P.)

GIRTIN, THOMAS (1775-1802), English painter and etcher, was the son of a well-to-do cordage maker in Southwark, London. His father died while Thomas was a child, and his widow married Mr Vaughan, a pattern-draughtsman. Girtin learnt drawing as a boy, and was apprenticed to Edward Doyes (1763-1804), the mezzotint engraver, and he soon made J. M. W. Turner's acquaintance. His architectural and topographical sketches and drawings soon established his reputation, his use of water-colour for landscapes being such as to give him the credit of having created modern water-colour painting, as opposed to mere "tinting." His etchings also were characteristic of his artistic genius. His early death from consumption (9th of November 1802) led indeed to Turner saying that "had Tom Girtin lived I should have starved." From 1794 to his death he was an exhibitor at the Royal Academy; and some fine examples of his work have been bequeathed by private owners to the British Museum and the Victoria and Albert Museum.

GIRVAN, a police burgh, market and fishing town of Ayrshire, Scotland, at the mouth of the Girvan, 21 m. S.W. of Ayr, and 63 m. S.W. of Glasgow by the Glasgow & South-Western railway. Pop. (1901) 4024. The principal industry was weaving, but the substitution of the power-loom for the hand-loom nearly put an end to it. The herring fishery has developed to considerable proportions, the harbour having been enlarged and protected by piers and a breakwater. Moreover, the town has grown in repute as a health and holiday resort, its situation being one of the finest in the west of Scotland. There is excellent sea-bathing, and a good golf-course. The vale of Girvan, one of the most fertile tracts in the shire, is made so by the Water of Girvan, which rises in the loch of Girvan Eye, pursues a very tortuous course of 36 m. and empties into the sea. Girvan is the point of communication with Ailsa Craig. About 13 m. S.W. at the mouth of the Stinchar is the fishing village of Ballantrae (pop. 511).

GIRY (JEAN MARIE JOSEPH), ARTHUR (1848-1899), French historian, was born at Trévoux (Ain) on the 29th of February 1848. After rapidly completing his classical studies at the lycées at Chartres, he spent some time in the administrative service and in journalism. He then entered the École des Chartes, where, under the influence of J. Quicherat, he developed a strong inclination to the study of the middle ages. The lectures at the École des Hautes Études, which he attended from its foundation in 1868, revealed his true bent; and henceforth he devoted himself almost entirely to scholarship. He began modestly by the study of the municipal charters of St Omer. Having been appointed assistant lecturer and afterwards full lecturer at the École des Hautes Études, it was to the town of St Omer that he devoted his first lectures and his first important work, *Histoire de la ville de Saint-Omer et de ses institutions jusqu'au XIV^e siècle* (1877). He, however, soon realized that the charters of one town can only be understood by comparing them with those of other towns, and he was gradually led to continue the work which Augustin Thierry had broadly outlined in his studies on the *Tiers État*. A minute knowledge of printed books and a methodical examination of departmental and communal archives furnished him with material for a long course of successful lectures, which gave rise to some important works on municipal history and led to a great revival of interest in the origins and significance of the urban communities in France. Giry himself published *Les Établissements de Rouen* (1883-1885), a study, based on very minute researches, of the charter granted to the capital of Normandy by Henry II., king of England, and of the diffusion of similar charters throughout the French dominions of the Plantagenets; a collection of *Documents sur les relations de*

la royauté avec les villes de France de 1180 à 1314 (1885); and *Étude sur les origines de la commune de Saint-Quentin* (1887).

About this time personal considerations induced Giry to devote the greater part of his activity to the study of diplomatic, which had been much neglected at the École des Chartes, but had made great strides in Germany. As assistant (1883) and successor (1885) to Louis de Mas Latrie, Giry restored the study of diplomatic, which had been founded in France by Dom Jean Mabillon, to its legitimate importance. In 1894 he published his *Manuel de diplomatique*, a monument of lucid and well-arranged erudition, which contained the fruits of his long experience of archives, original documents and textual criticism; and his pupils, especially those at the École des Hautes Études, soon caught his enthusiasm. With their collaboration he undertook the preparation of an inventory and, subsequently, of a critical edition of the Carolingian diplomas. By arrangement with E. Mühlbacher and the editors of the *Monumenta Germaniae historica*, this part of the joint work was reserved for Giry. Simultaneously with this work he carried on the publication of the annals of the Carolingian epoch on the model of the German *Jahrbücher*, reserving for himself the reign of Charles the Bald. Of this series his pupils produced in his lifetime *Les Derniers Carolingiens* (by F. Lot, 1891), *Eudes, comte de Paris et roi de France* (by E. Favre, 1893), and *Charles le Simple* (by Eckel, 1899). The biographies of Louis IV. and Hugh Capet and the history of the kingdom of Provence were not published until after his death, and his own unfinished history of Charles the Bald was left to be completed by his pupils. The preliminary work on the Carolingian diplomas involved such lengthy and costly researches that the Académie des Inscriptions et Belles-Lettres took over the expenses after Giry's death.

In the midst of these multifarious labours Giry found time for extensive archaeological researches, and made a special study of the medieval treatises dealing with the technical processes employed in the arts and industries. He prepared a new edition of the monk Theophilus's celebrated treatise, *Diversarum artium schedula*, and for several years devoted his Saturday mornings to laboratory research with the chemist Aimé Girard at the Conservatoire des Arts et Métiers, the results of which were utilized by Marcellin Berthelot in the first volume (1894) of his *Chimie au moyen âge*. Giry took an energetic part in the *Collection de textes relatifs à l'histoire du moyen âge*, which was due in great measure to his initiative. He was appointed director of the section of French history in *La Grande Encyclopédie*, and contributed more than a hundred articles, many of which, e.g. "Archives" and "Diplomatique," were original works. In collaboration with his pupil André Réville, he wrote the chapters on "L'Émancipation des villes, les communes et les bourgeoisies" and "Le Commerce et l'industrie au moyen âge" for the *Histoire générale* of Lavissee and Rambaud. Giry took a keen interest in politics, joining the republican party and writing numerous articles in the republican newspapers, mainly on historical subjects. He was intensely interested in the Dreyfus case, but his robust constitution was undermined by the anxieties and disappointments occasioned by the Zola trial and the Rennes court-martial, and he died in Paris on the 13th of November 1899.

For details of Giry's life and works see the funeral orations published in the *Bibliothèque de l'École des Chartes*, and afterwards in a pamphlet (1899). See also the biography by Ferdinand Lot in the *Annuaire de l'École des Hautes Études* for 1901; and the bibliography of his works by Henry Maistre in the *Correspondance historique et archéologique* (1899 and 1900).

GISBORNE, a seaport of New Zealand, in Cook county, provincial district of Auckland, on Poverty Bay of the east coast of North Island. Pop. (1901) 2733; (1906) 5664. Wool, frozen mutton and agricultural produce are exported from the rich district surrounding. Petroleum has been discovered in the neighbourhood, and about 40 m. from the town there are warm medicinal springs. Near the site of Gisborne Captain Cook landed in 1769, and gave Poverty Bay its name from his inability to obtain supplies owing to the hostility of the natives. Young Nick's Head, the southern horn of the bay, was named from Nicholas Young, his ship's boy, who first observed it.

GISLEBERT (or **GILBERT**) OF MONS (c. 1150-1225), Flemish chronicler, became a clerk, and obtained the positions of provost of the churches of St Germanus at Mons and St Alban at Namur, in addition to several other ecclesiastical appointments. In official documents he is described as chaplain, chancellor or notary, of Baldwin V., count of Hainaut (d. 1195), who employed him on important business. After 1200 Gislebert wrote the *Chronicon Hanoniense*, a history of Hainaut and the neighbouring lands from about 1050 to 1195, which is specially valuable for the latter part of the 12th century, and for the life and times of Baldwin V.

The chronicle is published in Band xxi. of the *Monumenta Germaniae historica* (Hanover, 1826 fol.); and separately with introduction by W. Arndt (Hanover, 1860). Another edition has been published by L. Vanderkindere in the *Recueil de textes pour servir à l'étude de l'histoire de Belgique* (Brussels, 1904); and there is a French translation by G. Menilglaize (Tournai, 1874).

See W. Meyer, *Das Werk des Konalers Gislebert von Mons als verfassungsgeschichtliche Quelle* (Königsberg, 1888); K. Huygens, *Sur la valeur historique de la chronique Gislebert de Mons* (Ghent, 1889); and W. Wattenbach, *Deutschlands Geschichtsquellen*, Band ii. (Berlin, 1894).

GISORS, a town of France, in the department of Eure, situated in the pleasant valley of the Epte, 44 m. N.W. of Paris on the railway to Dieppe. Pop. (1906) 4345. Gisors is dominated by a feudal stronghold built chiefly by the kings of England in the 11th and 12th centuries. The outer enceinte, to which is attached a cylindrical donjon erected by Philip Augustus, king of France, embraces an area of over 7 acres. On a mound in the centre of this space rises an older donjon, octagonal in shape, protected by another enceinte. The outer ramparts and the ground they enclose have been converted into promenades. The church of St Gervais dates in its oldest parts—the central tower, the choir and parts of the aisles—from the middle of the 13th century, when it was founded by Blanche of Castile. The rest of the church belongs to the Renaissance period. The Gothic and Renaissance styles mingle in the west façade, which, like the interior of the building, is adorned with a profusion of sculptures; the fine carving on the wooden doors of the north and west portals is particularly noticeable. The less interesting buildings of the town include a wooden house of the Renaissance era, an old convent now used as an hôtel de ville, and a handsome modern hospital. There is a statue of General de Blamont, born at Gisors in 1770. Among the industries of Gisors are felt manufacture, bleaching, dyeing and leather-dressing.

In the middle ages Gisors was capital of the Vexin. Its position on the frontier of Normandy caused its possession to be hotly contested by the kings of England and France during the 12th century, at the end of which it and the dependent fortresses of Neaufles and Dangu were ceded by Richard Coeur de Lion to Philip Augustus. During the wars of religion of the 16th century it was occupied by the duke of Mayenne on behalf of the League, and in the 17th century, during the Fronde, by the duke of Longueville. Gisors was given to Charles Auguste Fouquet in 1718 in exchange for Belle-Ile-en-Mer and made a duchy in 1742. It afterwards came into the possession of the count of Eu and the duke of Penthièvre.

GISSING, GEORGE ROBERT (1857-1903), English novelist, was born at Wakefield on the 22nd of November 1857. He was educated at the Quaker boarding-school of Alderley Edge and at Owens College, Manchester. His life, especially its earlier period, was spent in great poverty, mainly in London, though he was for a time also in the United States, supporting himself chiefly by private teaching. He published his first novel, *Workers in the Dawn*, in 1880. *The Unclashed* (1884) and *Isabel Clarendon* (1886) followed. *Demos* (1886), a novel dealing with socialistic ideas, was, however, the first to attract attention. It was followed by a series of novels remarkable for their pictures of lower middle class life. Gissing's own experiences had pre-occupied him with poverty and its brutalizing effects on character. He made no attempt at popular writing, and for a long time the sincerity of his work was appreciated only by a limited public. Among his more characteristic novels were: *Thyrza* (1887), *A Life's Morning* (1888), *The Nether World* (1889), *New*

Grub Street (1891), *Born in Exile* (1892), *The Odd Women* (1893), *In the Year of Jubilee* (1894), *The Whirlpool* (1897). Others, e.g. *The Town Traveller* (1901), indicate a humorous faculty, but the prevailing note of his novels is that of the struggling life of the shabby-genteel and lower classes and the conflict between education and circumstances. The quasi-autobiographical *Private Papers of Henry Rycroft* (1903) reflects throughout Gissing's studious and retiring tastes. He was a good classical scholar and had a minute acquaintance with the late Latin historians, and with Italian antiquities; and his posthumous *Veranilda* (1904), a historical romance of Italy in the time of Theodoric the Goth, was the outcome of his favourite studies. Gissing's powers as a literary critic are shown in his admirable study on Charles Dickens (1898). A book of travel, *By the Ionian Sea*, appeared in 1901. He died at St Jean de Luz in the Pyrenees on the 28th of December 1903.

See also the introductory essay by T. Scombe to *The House of Cobwebs* (1906), a posthumous volume of Gissing's short stories.

GITSCHIN (Czech *Jitín*), a town of Bohemia, Austria, 65 m. N.E. of Prague by rail. Pop. (1900) 9790, mostly Czech. The parish church was begun by Wallenstein after the model of the pilgrims' church of Santiago de Compostela in Spain, but not completed till 1655. The castle, which stands next to the church, was built by Wallenstein and finished in 1630. It was here that the emperor Francis I. of Austria signed the treaty of 1813 by which he threw in his lot with the Allies against Napoleon. Wallenstein was interred at the neighbouring Carthusian monastery, but in 1639 the head and right hand were taken by General Banér to Sweden, and in 1702 the other remains were removed by Count Vincent of Waldstein to his hereditary burying ground at Münchengrätz. Gitschin was originally the village of Zidiněves and received its present name when it was raised to the dignity of a town by Wenceslaus II. in 1302. The place belonged to various noble Bohemian families, and in the 17th century came into the hands of Wallenstein, who made it the capital of the duchy of Friedland and did much to improve and extend it. His murder, and the miseries of the Thirty Years' War, brought it very low; and it passed through several hands before it was bought by Prince Trauttmansdorf, to whose family it still belongs. On the 29th of June 1866 the Prussians gained here a great victory over the Austrians. This victory made possible the junction of the first and second Prussian army corps, and had as an ultimate result the Austrian defeat at Königgrätz.

GIUDICI, PAOLO EMILIANO (1812-1872), Italian writer, was born in Sicily. His *History of Italian Literature* (1844) brought him to the front, and in 1848 he became professor of Italian literature at Pisa, but after a few months was deprived of the chair on account of his liberal views in politics. On the re-establishment of the Italian kingdom he became professor of aesthetics (resigning 1862) and secretary of the Academy of Fine Arts at Florence, and in 1867 was elected to the chamber of deputies. He held a prominent place as an historian, his works including a *Storia del teatro* (1860), and *Storia dei comuni italiani* (1861), besides a translation of Macaulay's *History of England* (1856). He died at Tonbridge in England, on the 8th of September 1872.

A *Life* appeared at Florence in 1874.

GIULIO ROMANO, or **GIULIO PIPPI** (c. 1492-1546), the head of the Roman school of painting in succession to Raphael. This prolific painter, modeller, architect and engineer receives his common appellation from the place of his birth—Rome, in the Macello de' Corbi. His name in full was Giulio di Pietro de Filippo de' Giannuzzi—Giannuzzi being the true family name, and Pippi (which has practically superseded Giannuzzi) being an abbreviation from the name of his grandfather Filippo. The date of Giulio's birth is a little uncertain. Vasari (who knew him personally) speaks of him as fifty-four years old at the date of his death, 1st November 1546; thus he would have been born in 1492. Other accounts assign 1498 as the date of birth. This would make Giulio young indeed in the early and in such case most precocious stages of his artistic career, and

would show him as dying, after an infinity of hard work, at the comparatively early age of forty-eight.

Giulio must at all events have been quite youthful when he first became the pupil of Raphael, and at Raphael's death in 1520 he was at the utmost twenty-eight years of age. Raphael had loved him as a son, and had employed him in some leading works, especially in the Loggia of the Vatican; the series there popularly termed "Raphael's Bible" is done in large measure by Giulio,—as for instance the subjects of the "Creation of Adam and Eve," "Noah's Ark," and "Moses in the Bulrushes." In the saloon of the "Incendio del Borgo," also, the figures of "Benefactors of the Church" (Charlemagne, &c.) are Giulio's handiwork. It would appear that in subjects of this kind Raphael simply furnished the design, and committed the execution of it to some assistant, such as Giulio,—taking heed, however, to bring it up, by final retouching, to his own standard of style and type. Giulio at a later date followed out exactly the same plan; so that in both instances inferiorities of method, in the general blocking-out and even in the details of the work, are not to be precisely charged upon the *caposcuola*. Amid the multitude of Raphael's pupils, Giulio was eminent in pursuing his style, and showed universal aptitude; he did, among other things, a large amount of architectural planning for his chief. Raphael bequeathed to Giulio, and to his fellow-pupil Gianfrancesco Penni ("Il Fattore"), his implements and works of art; and upon them it devolved to bring to completion the vast fresco-work of the "Hall of Constantine" in the Vatican—consisting, along with much minor matter, of the four large subjects, the "Battle of Constantine," the "Apparition of the Cross," the "Baptism of Constantine" and the "Donation of Rome to the Pope." The two former compositions were executed by Pippi, the two latter by Penni. The whole of this onerous undertaking was completed within a period of only three years,—which is the more remarkable as, during some part of the interval since Raphael's decease, the Fleming, Adrian VI., had been pope, and his anti-aesthetic pontificate had left art and artists almost in a state of inanition. Clement VII. had now, however, succeeded to the papedom. By this time Giulio was regarded as the first painter in Rome; but his Roman career was fated to have no further sequel.

Towards the end of 1524 his friend the celebrated writer Baldassar Castiglione seconded with success the urgent request of the duke of Mantua, Federigo Gonzaga, that Giulio should migrate to that city, and enter the duke's service for the purpose of carrying out his projects in architecture and pictorial decoration. These projects were already considerable, and under Giulio's management they became far more extensive still. The duke treated his painter munificently as to house, table, horses and whatever was in request; and soon a very cordial attachment sprang up between them. In Pippi's multifarious work in Mantua three principal undertakings should be noted. (1) In the Castello he painted the "History of Troy," along with other subjects. (2) In the suburban ducal residence named the Palazzo del Te (this designation being apparently derived from the form of the roads which led towards the edifice) he rapidly carried out a rebuilding on a vastly enlarged scale,—the materials being brick and terra-cotta, as there is no local stone,—and decorated the rooms with his most celebrated works in oil and fresco painting—the story of Psyche, Icarus, the fall of the Titans, and the portraits of the ducal horses and hounds. The foreground figures of Titans are from 12 to 14 ft. high; the room, even in its structural details, is made to subservise the general artistic purpose, and many of its architectural features are distorted accordingly. Greatly admired though these pre-eminent works have always been, and at most times even more than can now be fully ratified, they have suffered severely at the hands of restorers, and modern eyes see them only through a dull and desending fog of renovation. The whole of the work on the Palazzo del Te, which is of the Doric order of architecture, occupied about five years. (3) Pippi recast and almost rebuilt the cathedral of Mantua; erected his own mansion, replete with numerous antiques and other articles of vertu; reconstructed

the street architecture to a very large extent, and made the city, sapped as it is by the shallows of the Mincio, comparatively healthy; and at Marmiruolo, some 5 m. distant from Mantua, he worked out other important buildings and paintings. He was in fact, for nearly a quarter of a century, a sort of Demiurgus of the arts of design in the Mantuan territory.

Giulio's activity was interrupted but not terminated by the death of Duke Federigo. The duke's brother, a cardinal who became regent, retained him in full employment. For a while he went to Bologna, and constructed the façade of the church of S. Petronio in that city. He was afterwards invited to succeed Antonio Sangallo as architect of St Peter's in Rome,—a splendid appointment, which, notwithstanding the strenuous opposition of his wife and of the cardinal regent, he had almost resolved to accept, when a fever overtook him, and, acting upon a constitution somewhat enfeebled by worry and labour, caused his death on the 1st of November 1546. He was buried in the church of S. Barnaba in Mantua. At the time of his death Giulio enjoyed an annual income of more than 1000 ducats, accruing from the liberalities of his patrons. He left a widow, and a son and daughter. The son, named Raffaello, studied painting, but died before he could produce any work of importance; the daughter, Virginia, married Ercole Malatesta.

Wide and solid knowledge of design, combined with a promptitude of composition that was never at fault, formed the chief motive power and merit of Giulio Romano's art. Whatever was wanted, he produced it at once, throwing off, as Vasari says, a large design in an hour; and he may in that sense, though not equally so when an imaginative or ideal test is applied, be called a great inventor. It would be difficult to name any other artist who, working as an architect, and as the plastic and pictorial embellisher of his architecture, produced a total of work so fully and homogeneously his own; hence he has been named "the prince of decorators." He had great knowledge of the human frame, and represented it with force and truth, though sometimes with an excess of movement; he was also learned in other matters, especially in medals, and in the plans of ancient buildings. In design he was more strong and emphatic than graceful, and worked a great deal from his accumulated stores of knowledge, without consulting nature direct. As a general rule, his designs are finer and freer than his paintings; whether in fresco or in oil—his easel pictures being comparatively few, and some of them the reverse of decent; his colouring is marked by an excess of blackish and heavy tints.

Giulio Romano introduced the style of Raphael into Mantua, and established there a considerable school of art, which surpassed in development that of his predecessor Mantegna, and almost rivalled that of Rome. Very many engravings—more than three hundred are mentioned—were made contemporaneously from his works; and this not only in Italy, but in France and Flanders as well. His plan of entrusting principally to assistants the pictorial execution of his cartoons has already been referred to; Primaticcio was one of the leading coadjutors. Rinaldo Mantovano, a man of great ability who died young, was the chief executant of the "Fall of the Giants"; he also co-operated with Benedetto Pagni da Pescia in painting the remarkable series of horses and hounds, and the story of Psyche. Another pupil was Fermo Guisoni, who remained settled in Mantua. The oil pictures of Giulio Romano are not generally of high importance; two leading ones are the "Martyrdom of Stephen," in the church of that saint in Genoa, and a "Holy Family" in the Dresden Gallery. Among his architectural works not already mentioned is the Villa Madama in Rome, with a fresco of Polyphemus, and boys and satyrs; the Ionic façade of this building may have been sketched out by Raphael.

Vasari gives a pleasing impression of the character of Giulio. He was very loving to his friends, genial, affable, well-bred, temperate in the pleasures of the table, but liking fine apparel and a handsome scale of living. He was good-looking, of middle height, with black curly hair and dark eyes, and an ample beard; his portrait, painted by himself, is in the Louvre.

Besides Vasari, Lanzi and other historians of art, the following works may be mentioned: C. D. Arco, *Vita di G. Pippi* (1828); G. C. von Murr, *Notice sur les estampes gravées après dessins de Jules Romain* (1865); R. Sanzio, two works on *Etchings and Paintings* (1800, 1836).

GIUNTA PISANO, the earliest Italian painter whose name is found inscribed on an extant work. He is said to have exercised his art from 1202 to 1236. He may perhaps have been born towards 1180 in Pisa, and died in or soon after 1236; but other accounts give 1202 as the date of his birth, and 1258 or thereabouts for his death. There is some ground for thinking that his family name was Capitenò. The inscribed work above referred to, one of his earliest, is a "Crucifix," long in the kitchen of the convent of St Anne in Pisa. Other Pisan works of like date are very barbarous, and some of them may be also from the hand of Giunta. It is said that he painted in the upper church of Assisi,—in especial a "Crucifixion" dated 1236, with a figure of Father Elias, the general of the Franciscans, embracing the foot of the cross. In the sacristy is a portrait of St Francis, also ascribed to Giunta; but it more probably belongs to the close of the 13th century. He was in the practice of painting upon cloth stretched on wood, and prepared with plaster.

GIURGEVO (*Giurgiu*), the capital of the department of Vlashca, Rumania; situated amid mud-flats and marshes on the left bank of the Danube. Pop. (1900) 13,977. Three small islands face the town, and a larger one shelters its port, Smarda, 2½ m. E. The rich corn-lands on the north are traversed by a railway to Bucharest, the first line opened in Rumania, which was built in 1866 and afterwards extended to Smarda. Steamers ply to Rutchuk, 2½ m. S.W. on the Bulgarian shore, linking the Rumanian railway system to the chief Bulgarian line north of the Balkans (Rutchuk-Varna). Thus Giurgevo, besides having a considerable trade with the home ports lower down the Danube, is the headquarters of commerce between Bulgaria and Rumania. It exports timber, grain, salt and petroleum; importing coal, iron and textiles. There are also large saw-mills.

Giurgevo occupies the site of Theodoropolis, a city built by the Roman emperor Justinian (A.D. 483-565). It was founded in the 14th century by Genoese merchant adventurers, who established a bank, and a trade in silks and velvets. They called the town, after the patron saint of Genoa, San Giorgio (St George); and hence comes its present name. As a fortified town, Giurgevo figured often in the wars for the conquest of the lower Danube; especially in the struggle of Michael the Brave (1593-1601) against the Turks, and in the later Russo-Turkish Wars. It was burned in 1650. In 1829, its fortifications were finally razed, the only defence left being a castle on the island of Slobosia, united to the shore by a bridge.

GIUSTI, GIUSEPPE (1809-1850), Tuscan satirical poet, was born at Monsummano, a small village of the Valdinievole, on the 12th of May 1809. His father, a cultivated and rich man, accustomed his son from childhood to study, and himself taught him, among other subjects, the first rudiments of music. Afterwards, in order to curb his too vivacious disposition, he placed the boy under the charge of a priest near the village, whose severity did perhaps more evil than good. At twelve Giusti was sent to school at Florence, and afterwards to Pistoia and to Lucca; and during those years he wrote his first verses. In 1826 he went to study law at Pisa; but, disliking the study, he spent eight years in the course, instead of the customary four. He lived gaily, however, though his father kept him short of money, and learned to know the world, seeing the vices of society, and the folly of certain laws and customs from which his country was suffering. The experience thus gained he turned to good account in the use he made of it in his satire.

His father had in the meantime changed his place of abode to Pescia; but Giuseppe did worse there, and in November 1832, his father having paid his debts, he returned to study at Pisa, seriously enamoured of a woman whom he could not marry, but now commencing to write in real earnest in behalf of his country. With the poem called *La Ghigliottina* (the guillotine), Giusti began to strike out a path for himself, and thus revealed his great genius. From this time he showed himself the Italian

Béranger, and even surpassed the Frenchman in richness of language, refinement of humour and depth of satirical conception. In Béranger there is more feeling for what is needed for popular poetry. His poetry is less studied, its vivacity perhaps more boisterous, more spontaneous; but Giusti, in both manner and conception, is perhaps more elegant, more refined, more penetrating. In 1834 Giusti, having at last entered the legal profession, left Pisa to go to Florence, nominally to practise with the advocate Capoquadri, but really to enjoy life in the capital of Tuscany. He fell seriously in love a second time, and as before was abandoned by his love. It was then he wrote his finest verses, by means of which, although his poetry was not yet collected in a volume, but for some years passed from hand to hand, his name gradually became famous. The greater part of his poems were published clandestinely at Lugano, at no little risk, as the work was destined to undermine the Austrian rule in Italy. After the publication of a volume of verses at Bastia, Giusti thoroughly established his fame by his *Gingillino*, the best in moral tone as well as the most vigorous and effective of his poems. The poet sets himself to represent the vileness of the treasury officials, and the base means they used to conceal the necessities of the state. The *Gingillino* has all the character of a classic satire. When first issued in Tuscany, it struck all as too impassioned and personal. Giusti entered heart and soul into the political movements of 1847 and 1848, served in the national guard, sat in the parliament for Tuscany; but finding that there was more talk than action, that to the tyranny of princes had succeeded the tyranny of demagogues, he began to fear, and to express the fear, that for Italy evil rather than good had resulted. He fell, in consequence, from the high position he had held in public estimation, and in 1848 was regarded as a reactionary. His friendship for the marquis Gino Capponi, who had taken him into his house during the last years of his life, and who published after Giusti's death a volume of illustrated proverbs, was enough to compromise him in the eyes of such men as Guerrazzi, Montanelli and Niccolini. On the 31st of May 1850 he died at Florence in the palace of his friend.

The poetry of Giusti, under a light trivial aspect, has a lofty civilizing significance. The type of his satire is entirely original, and it had also the great merit of appearing at the right moment, of wounding judiciously, of sustaining the part of the comedy that "castigat ridendo mores." Hence his verse, apparently jovial, was received by the scholars and politicians of Italy in all seriousness. Alexander Manzoni in some of his letters showed a hearty admiration of the genius of Giusti; and the weak Austrian and Bourbon governments regarded them as of the gravest importance.

His poems have often been reprinted, the best editions being those of Le Monnier, Carducci (1859; 3rd ed., 1879), Fioretti (1876) and Bragi (1890). Besides the poems and the proverbs already mentioned, we have a volume of select letters, full of vigour and written in the best Tuscan language, and a fine critical discourse on Giuseppe Parini, the satirical poet. In some of his compositions the elegiac rather than the satirical poet is seen. Many of his verses have been excellently translated into German by Paul Heyse. Good English translations were published in the *Athenaeum* by Mrs T. A. Trollope, and some by W. D. Howells are in his *Modern Italian Poets* (1887).

GIUSTINIANI, the name of a prominent Italian family which originally belonged to Venice, but established itself subsequently in Genoa also, and at various times had representatives in Naples, Corsica and several of the islands of the Archipelago.

In the Venetian line the following are most worthy of mention:—

1. **LORENZO** (1380-1465), the Laurentius Justinianus of the Roman calendar, at an early age entered the congregation of the canons of St George in Alga, and in 1433 became general of that order. About the same time he was made by Eugenius IV. bishop of Venice; and his episcopate was marked by considerable activity in church extension and reform. On the removal of the patriarchate from Grado to Venice by Nicholas V. in 1451, Giustiniani was promoted to that dignity, which he held for fourteen years. He died on January 8, 1465, was canonized by Pope Alexander VIII., his festival (semi-duplex)

being fixed by Innocent XII. for September 5th, the anniversary of his elevation to the bishopric. His works, consisting of sermons, letters and ascetic treatises, have been frequently reprinted,—the best edition being that of the Benedictine P. N. A. Giustiniani, published at Venice in 2 vols. folio, 1751. They are wholly devoid of literary merit. His life has been written by Bernard Giustiniani, by Maffei and also by the Bollandists.

2. LEONARDO (1388-1446), brother of the preceding, was for some years a senator of Venice, and in 1443 was chosen procurator of St Mark. He translated into Italian Plutarch's *Lives of Cincinnatus and Lucullus*, and was the author of some poetical pieces, amatory and religious—*strambotti* and *canzonetti*—as well as of rhetorical prose compositions. Some of the popular songs set to music by him became known as *Giustiniani*.

3. BERNARDO (1408-1489), son of Leonardo, was a pupil of Guarino and of George of Trebizond, and entered the Venetian senate at an early age. He served on several important diplomatic missions both to France and Rome, and about 1485 became one of the council of ten. His orations and letters were published in 1492; but his title to any measure of fame he possesses rests upon his history of Venice, *De origine urbis Venetiarum rebusque ab ipsa gestis historia* (1492), which was translated into Italian by Domenichi in 1545, and which at the time of its appearance was undoubtedly the best work upon the subject of which it treated. It is to be found in vol. i. of the *Thesaurus* of Graevius.

4. PIETRO, also a senator, lived in the 16th century, and wrote on *Historia rerum Venetarum* in continuation of that of Bernardo. He was also the author of chronicles *De gestis Petri Mocenigi* and *De bello Venetarum cum Carolo VIII.* The latter has been reprinted in the *Script. rer. Ital.* vol. xxi.

Of the Genoese branch of the family the most prominent members were the following:—

5. PAOLO, DI MONICIGLIA (1444-1502), a member of the order of Dominicans, was, from a comparatively early age, prior of their convent at Genoa. As a preacher he was very successful, and his talents were fully recognized by successive popes, by whom he was made master of the sacred palace, inquisitor-general for all the Genoese dominions, and ultimately bishop of Scio and Hungarian legate. He was the author of a number of Biblical commentaries (no longer extant), which are said to have been characterized by great erudition.

6. AGOSTINO (1470-1536) was born at Genoa, and spent some wild years in Valencia, Spain. Having in 1487 joined the Dominican order, he gave himself with great energy to the study of Greek, Hebrew, Chaldee and Arabic, and in 1514 began the preparation of a polyglot edition of the Bible. As bishop of Nebbio in Corsica, he took part in some of the earlier sittings of the Lateran council (1516-1517), but, in consequence of party complications, withdrew to his diocese, and ultimately to France, where he became a pensioner of Francis I., and was the first to occupy a chair of Hebrew and Arabic in the university of Paris. After an absence from Corsica for a period of five years, during which he visited England and the Low Countries, and became acquainted with Erasmus and More, he returned to Nebbio, about 1522, and there remained, with comparatively little intermission, till in 1536, when, while returning from a visit to Genoa, he perished in a storm at sea. He was the possessor of a very fine library, which he bequeathed to the republic of Genoa. Of his projected polyglot only the Psalter was published (*Psalterium Hebraicum, Graecum, Arabicum, et Chaldaicum*, Genoa, 1616). Besides the Hebrew text, the LXX. translation, the Chaldee paraphrase, and an Arabic version, it contains the Vulgate translation, a new Latin translation by the editor, a Latin translation of the Chaldee, and a collection of scholia. Giustiniani printed 2000 copies at his own expense, including fifty in vellum for presentation to the sovereigns of Europe and Asia; but the sale of the work did not encourage him to proceed with the New Testament, which he had also prepared for the press. Besides an edition of the book of Job, containing the original text, the Vulgate, and a new translation,

he published a Latin version of the *Moreh Nevochim* of Maimonides (*Director dubitantium aut perplexorum*, 1520), and also edited in Latin the *Aureus libellus* of Aeneas Platonicus, and the *Timaeus* of Chalcidius. His annals of Genoa (*Castigatissimi annali di Genova*) were published posthumously in 1537.

The following are also noteworthy:—

7. POMPEIO (1569-1616), a native of Corsica, who served under Alessandro Farnese and the marquis of Spinola in the Low Countries, where he lost an arm, and, from the artificial substitute which he wore, came to be known by the sobriquet *Bras de Fer*. He also defended Crete against the Turks; and subsequently was killed in a reconnaissance at Friuli. He left in Italian a personal narrative of the war in Flanders, which has been repeatedly published in a Latin translation (*Bellum Belgicum*, Antwerp, 1609).

8. GIOVANNI (1513-1556), born in Candia, translator of Terence's *Andria* and *Eunuchus*, of Cicero's *In Verrem*, and of Virgil's *Aeneid*, viii.

9. ORBATO (1538-1603), Venetian senator, translator of the *Oedipus Tyrannus* of Sophocles and author of a collection of *Rime*, in imitation of Petrarch. He is regarded as one of the latest representatives of the classic Italian school.

10. GERONIMO, a Genoese, flourished during the latter half of the 16th century. He translated the *Alkestis* of Euripides and three of the plays of Sophocles; and wrote two original tragedies, *Jephthé* and *Christo in Passione*.

11. VINCENTO, who in the beginning of the 17th century built the Roman palace and made the art collection which are still associated with his name (see *Galleria Giustiniana*, Rome, 1631). The collection was removed in 1807 to Paris, where it was to some extent broken up. In 1815 all that remained of it, about 170 pictures, was purchased by the king of Prussia and removed to Berlin, where it forms a portion of the royal museum.

GIUSTO DA GUANTO [JODOCUS, OR JUSTUS, OR GHEENT] (fl. 1465-1475), Flemish painter. The public records of the city of Ghent have been diligently searched, but in vain, for a clue to the history of Justus or Jodocus, whom Vasari and Guicciardini called Giusto da Guanto. Flemish annalists of the 16th century have enlarged upon the scanty statements of Vasari, and described Jodocus as a pupil of Hubert Van Eyck. But there is no source to which this fable can be traced. The registers of St Luke's gild at Ghent comprise six masters of the name of Joos or Jodocus who practised at Ghent in the 15th century. But none of the works of these masters has been preserved, and it is impossible to compare their style with that of Giusto. It was between 1465 and 1474 that this artist executed the "Communion of the Apostles" which Vasari has described, and modern critics now see to the best advantage in the museum of Urbino. It was painted for the brotherhood of Corpus Christi at the bidding of Frederick of Montefeltro, who was introduced into the picture as the companion of Caterino Zeno, a Persian envoy at that time on a mission to the court of Urbino. From this curious production it may be seen that Giusto, far from being a pupil of Hubert Van Eyck, was merely a disciple of a later and less gifted master, who took to Italy some of the peculiarities of his native schools, and forthwith commingled them with those of his adopted country. As a composer and draughtsman Giusto compares unfavourably with the better-known painters of Flanders; though his portraits are good, his ideal figures are not remarkable for elevation of type or for subtlety of character and expression. His work is technically on a level with that of Gerard of St John, whose pictures are preserved in the Belvedere at Vienna. Vespasiano, a Florentine bookseller who contributed much to form the antiquarian taste of Frederick of Montefeltro, states that this duke sent to the Netherlands for a capable artist to paint a series of "ancient worthies" for a library recently erected in the palace of Urbino. It has been conjectured that the author of these "worthies," which are still in existence at the Louvre and in the Barberini palace at Rome, was Giusto. Yet there are notable divergences between these pictures and the "Communion of the Apostles." Still, it is not beyond the range of probability that Giusto should have been able, after a certain

time, to temper his Flemish style by studying the masterpieces of Santi and Melozzo, and so to acquire the mixed manner of the Flemings and Italians which these portraits of worthies display. Such an assimilation, if it really took place, might justify the Flemings in the indulgence of a certain pride, considering that Raphael not only admired these worthies, but copied them in the sketch-book which is now the ornament of the Venetian Academy. There is no ground for presuming that Giusto ad Guanto is identical with Justus d'Allamagna who painted the "Annunciation" (1451) in the cloisters of Santa Maria di Castello at Genoa. The drawing and colouring of this wall painting shows that Justus d'Allamagna was as surely a native of south Germany as his homonym at Urbino was a born Netherlander.

GIVET, a town of northern France, in the department of Ardennes, 40 m. N. by E. of Mézières on the Eastern railway between the town and Namur. Pop. (1906) town, 5110; commune, 7468. Givet lies on the Meuse about 1 m. from the Belgian frontier, and was formerly a fortress of considerable importance. It is divided into three portions—the citadel called Charlemont and Grand Givet on the left bank of the river, and on the opposite bank Petit Givet, connected with Grand Givet by a stone bridge of five arches. The fortress of Charlemont, situated at the top of a precipitous rock 705 ft. high, was founded by the emperor Charles V. in the 16th century, and further fortified by Vauban at the end of the 17th century; it is the only survival of the fortifications of the town, the rest of which were destroyed in 1892. In Grand Givet there are a church and a town-hall built by Vauban, and a statue of the composer Étienne Méhul stands in the fine square named after him. Petit Givet, the industrial quarter, is traversed by a small tributary of the Meuse, the Houille, which is bordered by tanneries and glue factories. Pencils and tobacco-pipes are also manufactured. The town has considerable river traffic, consisting chiefly of coal, copper and stone. There is a chamber of arts and manufactures.

GIVORS, a manufacturing town of south-eastern France, in the department of Rhône, on the railway between Lyons and St Étienne, 14 m. S. of Lyon. Pop. (1906) 11,444. It is situated on the right bank of the Rhone, here crossed by a suspension bridge, at its confluence with the Gier and the canal of Givors, which starts at Grand Croix on the Gier, some 13 m. distant. The chief industries are metal-working, engineering-construction and glass-working. There are coal mines in the vicinity. On the hill overlooking the town are the ruins of the château of St Gerald and of the convent of St Ferréol, remains of the old town destroyed in 1594.

GJALLAR, in Scandinavian mythology, the horn of Heimdall, the guardian of the rainbow bridge by which the gods pass and repass between earth and heaven. This horn had to be blown whenever a stranger approached the bridge.

GLABRIO. 1. **MANTUS ACILIUS GLABRIO**, Roman statesman and general, member of a plebeian family. When consul in 191 B.C. he defeated Antiochus the Great of Syria at Thermopylae, and compelled him to leave Greece. He then turned his attention to the Aetolians, who had persuaded Antiochus to declare war against Rome, and was only prevented from crushing them by the intercession of T. Quinctius Flaminius. In 189 Glabrio was a candidate for the censorship, but was bitterly opposed by the nobles. He was accused by the tribunes of having concealed a portion of the Syrian spoils in his own house; his legate gave evidence against him, and he withdrew his candidature. It is probable that he was the author of the law which left it to the discretion of the pontiffs to insert or omit the intercalary month of the year.

Censorinus, *De die natali*, xx.; Macrobius, *Saturnalia*, i. 13; index to Livy; Appian, *Syr.* 17-21.

2. **MANTUS ACILIUS GLABRIO**, Roman statesman and general, grandson of the famous jurist P. Mucius Scaevola. When praetor urbanus (70 B.C.) he presided at the trial of Verres. According to Dio Cassius (xxxv. 38), in conjunction with L. Calpurnius Piso, his colleague in the consulship (67), he brought forward a severe law (*Lex Acilia Calpurnia*) against

illegal canvassing at elections. In the same year he was appointed to supersede L. Lucullus in the government of Cilicia and the command of the war against Mithradates, but as he did absolutely nothing and was unable to control the soldiery, he was in turn superseded by Pompey according to the provisions of the Manilian law. Little else is known of him except that he declared in favour of the death punishment for the Catilinarian conspirators.

Dio Cassius xxxvi. 14, 16, 24; Cicero, *Pro lege Manilia*, 2. 9; Appian, *Mithrid.* 90.

GLACE BAY, a city and port of entry of Cape Breton county, Nova Scotia, Canada, on the Atlantic Ocean, 14 m. E. of Sydney, with which it is connected both by steam and electric railway. It is the centre of the properties of the Dominion Coal Company (founded 1893), which produce most of the coal of Nova Scotia. Though it has a fair harbour, most of the shipping is done from Sydney in summer and from Louisburg in winter. Pop. (1892) 2000; (1901) 6945; (1906) 13,000.

GLACIAL PERIOD, in geology, the name usually given, by English and American writers, to that comparatively recent time when all parts of the world suffered a marked lowering of temperature, accompanied in northern Europe and North America by glacial conditions, not unlike those which now characterize the Polar regions. This period, which is also known as the "Great Ice Age" (German *Die Eiszeit*), is synchronous with the Pleistocene period, the earlier of the Post-Tertiary or Quaternary divisions of geological time. Although "Glacial period" and "Pleistocene" (*q.v.*) are often used synonymously it is convenient to consider them separately, inasmuch as not a few Pleistocene formations have no causal relationship with conditions of glaciation. Not until the beginning of the 19th century did the deposits now generally recognized as the result of ice action receive serious attention; the tendency was to regard such superficial and irregular material as mere rubbish. Early ideas upon the subject usually assigned floods as the formative agency, and this view is still not without its supporters (see Sir H. H. Howorth, *The Glacial Nightmare and the Flood*). Doubtless this attitude was in part due to the comparative rarity of glaciers and ice-fields where the work of ice could be directly observed. It was natural therefore that the first scientific references to glacial action should have been stimulated by the Alpine regions of Switzerland, which called forth the writings of J. J. Schuchzer, B. F. Kuha, H. B. de Saussure, F. G. Hugi, and particularly those of J. Venetz, J. G. von Charpentier and L. Agassiz. Canon Rendu, J. Forbes and others had studied the cause of motion of glaciers, while keen observers, notably Sir James Hall, A. Brongniart and J. Playfair, had noted the occurrence of travelled and scratched stones.

The result of these efforts was the conception of great ice-sheets flowing over the land, grinding the rock surfaces and transporting rock debris in the manner to be observed in the existing glaciers. However, before this view had become established Sir C. Lyell evolved the "drift theory" to explain the widely spread phenomenon of transported blocks, boulder clay and the allied deposits; in this he was supported by Sir H. de la Beche, Charles Darwin, Sir R. I. Murchison and many others. According to the drift theory, the transport and distribution of "erratic blocks," &c., had been effected by floating icebergs; this view naturally involved a considerable and widespread submergence of the land, an assumption which appeared to receive support from the occasional presence of marine shells at high levels in the "drift" deposits. So great was the influence of those who favoured the drift theory that even to-day it cannot be said to have lost complete hold; we still speak of "drift" deposits in England and America, and the belief in one or more great submergences during the Glacial period is still held more firmly by certain geologists than the evidence would seem to warrant. The case against the drift theory was most clearly expressed by Sir A. C. Ramsay for England and Scotland, and by the Swedish scientist Otto Torell. Since then the labours of Professor James Geikie, Sir Archibald Geikie, Professor P. Kendall and

others in England; von Verendt, H. Credner, de Geer, E. Geinitz, A. Helland, Jentsch, K. Keilhack, A. Penck, H. Schröder, F. Wahnschaffe in Scandinavia and Germany; T. C. Chamberlin, W. Upham, G. F. Wright in North America, have all tended to confirm the view that it is to the movement of glaciers and ice-sheets that we must look as the predominant agent of transport and abrasion in this period. The three stages through which our knowledge of glacial work has advanced may thus be summarized: (1) the diluvial hypothesis, deposits formed by floods; (2) the drift hypothesis, deposits formed mainly by icebergs and floating ice; (3) the ice-sheet hypothesis, deposits formed directly or indirectly through the agency of flowing ice.

Evidences.—The evidence relied upon by geologists for the former existence of the great ice-sheets which traversed the northern regions of Europe and America is mainly of two kinds: (1) the peculiar erosion of the older rocks by ice and ice-borne stones, and (2) the nature and disposition of ice-borne rock debris. After having established the criteria by which the work of moving ice is to be recognized in regions of active glaciation, the task of identifying the results of earlier glaciation elsewhere has been carried on with unabated energy.

1. *Ice Erosion.*—Although there are certain points of difference between the work of glaciers and broad ice-sheets, the former



being more or less restricted laterally by the valleys in which they flow, the general results of their passage over the rocky floor are essentially similar. Smooth rounded outlines are imparted to the rocks, markedly contrasting with the pinnaced and irregular surfaces produced by ordinary weathering; where these rounded surfaces have been formed on a minor scale the well-known features of *roches moutonnées* (German *Rundhöcker*) are created; on a larger scale we have the erosion-form known as "crag and tail," when the ice-sheet has overridden ground with more pronounced contours, the side of the hill facing the advancing ice being rounded and gently curved (German *Stosseite*), and the opposite side (*Leeseite*) steep, abrupt and much less smooth. Such features are never associated with the erosion of water. The rounding of rock surfaces is regularly accompanied by grooving and striation (German *Schrammen*, *Schliffe*) caused by the grinding action of stones and boulders embedded in the moving ice. These "glacial striae" are of great value in determining the latest path of the vanished ice-sheets (see map). Several other erosion-features are generally associated with ice action; such are the circular-headed valleys, "cirques" or "corries" (German *Zirkus*) of mountain districts; the pot-holes, giants' kettles (*Strudellöcher*, *Riesentöpfe*), familiarly exemplified in the Gletschergarten near Lucerne; the "rock-basins" (*Felsseebecken*) of mountainous regions are also believed to be assignable to this cause on account of their frequent association with other glacial phenomena, but it is more than probable that the action of running water (waterfalls, &c.)—

influenced no doubt by the disposition of the ice—has had much to do with these forms of erosion. As regards rock-basins, geologists are still divided in opinion: Sir A. C. Ramsay, J. Geikie, Tyndall, Helland, H. Hess, A. Penck, and others have expressed themselves in favour of a glacial origin; while A. Heim, F. Stapf, T. Kjerulf, L. Rüttimeyer and many others have strongly opposed this view.

2. Glacial deposits may be roughly classified in two groups: those that have been formed directly by the action of the ice, and those formed through the agency of water flowing under, upon, and from the ice-sheets, or in streams and lakes modified by the presence of the ice. To differentiate in practice between the results of these two agencies is a matter of some difficulty in the case of unstratified deposits; but the boulder clay may be taken as the typical formation of the glacier or ice-sheet, whether it has been left as a *terminal moraine* at the limit of glaciation or as a *ground moraine* beneath the ice. A stratified form of boulder clay, which not infrequently rests upon, and is therefore younger than, the more typical variety, is usually regarded as a deposit formed by water from the material (*englacial, innesmorän*) held in suspension within the ice, and set free during the process of melting. Besides the innumerable boulders, large and small, embedded in the boulder clay, isolated masses of rock, often of enormous size, have been borne by ice-sheets far from their original home and stranded when the ice melted. These "erratic blocks," "perched blocks" (German *Findlinge*) are familiar objects in the Alpine glacier districts, where they have frequently received individual names, but they are just as easily recognized in regions from which the glaciers that brought them there have long since been banished. Not only did the ice-transport blocks of hard rock, granite and the like, but huge masses of stratified rock were torn from their bed by the same agency; the masses of chalk in the cliffs near Cromer are well known; near Berlin, at Firkenwald, there is a transported mass of chalk estimated to be at least 2,000,000 cubic metres in bulk, which has travelled probably 15 kilometres from its original site; a block of Lincolnshire oolite is recorded by C. Fox-Strangways near Melton in Leicestershire, which is 300 yds. long and 100 yds. broad if no more; and instances of a similar kind might be multiplied.

When we turn to the "fluvio-glacial" deposits we find a bewildering variety of stratified and partially bedded deposits of gravel, sand and clay, occurring separately or in every conceivable condition of association. Some of these deposits have received distinctive names; such are the "Kames" of Scotland, which are represented in Ireland by "Eakers," and in Scandinavia by "Åsar." Another type of hillocky deposit is exemplified by the "drums" or "drumlins." Everywhere beyond the margin of the advancing or retreating ice-sheets these deposits were being formed; streams bore away coarse and fine materials and spread them out upon alluvial plains or upon the floors of innumerable lakes, many of which were directly caused by the damming of the ordinary water-courses by the ice. As the level of such lakes was changed new beach-lines were produced, such as are still evident in the great lake region of North America, in the parallel roads of Glen Roy, and the "Strandlinien" of many parts of northern Europe.

Viewed in relation to man's position on the earth, no geological changes have had a more profound importance than those of the Glacial period. The whole of the glaciated region bears evidence of remarkable modification of topographic features; in parts of Scotland or Norway or Canada the old rocks are bared of soil, rounded and smoothed as far as the eye can see. The old soil and subsoil, the product of ages of ordinary weathering, were removed from vast areas to be deposited and concentrated in others. Old valleys were filled—often to a great depth, 300-400 ft.; rivers were diverted from their old courses, never to return; lakes of vast size were caused by the damming of old outlets (Lake Lahontan, Lake Agassiz, &c., in North America), while an infinite number of shifting lakelets—with their deposits—played an important part along the ice-front at all stages of its career. The influence of this period upon the present

distribution of plant and animal life in northern latitudes can hardly be overestimated.

Much stress has been laid upon supposed great changes in the level of the land in northern regions during the Glacial period. The occurrence of marine shells at an elevation of 1350 ft. at Moel Tryfaen in north Wales, and at 1200 ft. near Macclesfield in Cheshire, has been cited as evidence of profound submergence by some geologists, though others see in these and similar occurrences only the transporting action of ice-sheets that have traversed the floor of the adjoining seas. Marine shells in stratified materials have been found on the coast of Scotland at 100 ft. and over, in S. Scandinavia at 600 to 800 ft., and in the "Champlain" deposits of North America at various heights. The dead shells of the "Yoldia clay" cover wide areas at the bottom of the North Atlantic at depths from 500 to 1300 fathoms, though the same mollusc is now found living in Arctic seas at the depth of 5 to 15 fathoms. This has been looked upon as a proof that in the N.W. European region the lithosphere stood about 2600 ft. higher than it does now (Brögger, Nansen, &c.), and it has been suggested that a union of the mainland of Europe with that of North America—forming a northern continental mass "Prosarctis"—may have been achieved by way of Iceland, Jan Mayen Land and Greenland. The pre-glacial valleys and fjords of Norway and Scotland, with their deeply submerged seaward ends, are regarded as proofs of former elevation. The great depth of alluvium in some places (236 metres at Bremen) points in the same direction. Evidences of changes of level occur in early, middle and late Pleistocene formations, and the nature of the evidence is such that it is on the whole safer to assume the existence only of the more moderate degree of change.

The Cause of the Glacial Period.—Many attempts have been made to formulate a satisfactory hypothesis that shall conform with the known facts and explain the great change in climatic conditions which set in towards the close of the Tertiary era, and culminated during the Glacial period. Some of the more prominent hypotheses may be mentioned, but space will not permit of a detailed analysis of theories, most of which rest upon somewhat unsubstantial ground. The principal facts to be taken into consideration are (1) the great lowering of temperature over the whole earth; (2) the localization of extreme glaciation in north-west Europe and north-east America; and (3) the local retrogression of the ice-sheets, once or more times repeated.

Some have suggested the simple solution of a change in the earth's axis, and have indicated that the pole may have travelled through some 15° to 20° of latitude; thus, the polar glaciation, as it now exists, might have been in this way transferred to include north-west Europe and North America; but modern views on the rigidity of the earth's body, together with the lack of any evidence of the correlative movement of climatic zones in other parts of the world, render this hypothesis quite untenable. On similar grounds a change in the earth's centre of gravity is unthinkable. Theories based upon the variations in the obliquity of the ecliptic or eccentricity of the earth's orbit, or on the passage of the solar system through cold regions of space, or upon the known variations in the heat emitted by the sun, are all insecure and unsatisfactory. The hypothesis elaborated by James Croll (*Phil. Mag.*, 1864, 28, p. 121; *Climate and Time*, 1875; and *Discussion on Climate and Cosmology*, 1889) was founded upon the assumption that with the earth's eccentricity at its maximum and winter in the north at aphelion, there would be a tendency in northern latitudes for the accumulation of snow and ice, which would be accentuated indirectly by the formation of fogs and a modification of the trade winds. The shifting of the thermal equator, and with it the direction of the trade winds, would divert some of the warm ocean currents from the cold regions, and this effect was greatly enhanced, he considered, by the configuration of the Atlantic Ocean. Croll's hypothesis was supported by Sir R. Ball (*The Cause of the Great Ice Age*, 1893), and it met with very general acceptance; but it has been destructively criticized by Professor S. Newcomb (*Phil.*

Mag., 1876, 1883, 1884) and by E. P. Culverwell (*Phil. Mag.*, 1894, p. 541, and *Geol. Mag.*, 1895, pp. 3 and 55). The difficulties in the way of Croll's theory are: (1) the fundamental assumption, that midwinter and midsummer temperatures are directly proportional to the sun's heat at those periods, is not in accordance with observed facts; (2) the glacial periods would be limited in duration to an appropriate fraction of the precessional period (21,000 years), which appears to be too short a time for the work that was actually done by ice agency; and (3) Croll's glacial periods would alternate between the northern and southern hemispheres, affecting first one then the other. Sir C. Lyell and others have advocated the view that great elevation of the land in polar regions would be conducive to glacial conditions; this is doubtless true, but the evidence that the Glacial period was primarily due to this cause is not well established. Other writers have endeavoured to support the elevation theory by combining with it various astronomical and meteorological agencies. More recently several hypotheses have been advanced to explain the glacial period as the result of changes in the atmosphere; F. W. Harmer ("The Influence of Winds upon the Climate during the Pleistocene Epoch," *Q.J.G.S.*, 1901, 57, p. 405) has shown the importance of the influence of winds in certain circumstances; Marsden Manson ("The Evolution of Climate," *American Geologist*, 1899, 24, p. 93) has laid stress upon the influence of clouds; but neither of these theories grapples successfully with the fundamental difficulties. Others again have requisitioned the variability in the amount of the carbon dioxide in the atmosphere—hypotheses which depend upon the efficiency of this gas as a thermal absorbent. The supply of carbon dioxide may be increased from time to time, as by the emanations from volcanoes (S. Arrhenius and A. G. Högbohm), or it may be decreased by absorption into sea-water, and by the carbonation of rocks. Professor T. C. Chamberlin based a theory of glaciation on the depletion of the carbon dioxide of the air ("An Attempt to frame a Working Hypothesis of the cause of Glacial Periods on an Atmospheric Basis," *Jl. Geol.*, 1899, vii. 752-771; see also Chamberlin and Salisbury, *Geology*, 1906, ii. 674 and iii. 432). The outline of this hypothesis is as follows: The general conditions for glaciation were (1) that the oceanic circulation was interrupted by the existence of land; (2) that vertical circulation of the atmosphere was accelerated by continental and other influences; (3) that the thermal blanketing of the earth was reduced by a depletion of the moisture and carbon dioxide in the atmosphere, and that hence the average temperature of the surface of the earth and of the body of the ocean was reduced, and diversity in the distribution of heat and moisture introduced. The localization of glaciation is assignable to the two great areas of permanent atmospheric depression that have their present centres near Greenland and the Aleutian Islands respectively. The periodicity of glacial advances and retreats, demanded by those who believe in the validity of so-called "interglacial" epochs, is explained by a series of complicated processes involving the alternate depletion and completion of the normal charge of carbon dioxide in the air.

Whatever may be the ultimate verdict upon this difficult subject, it is tolerably clear that no simple cause of glacial conditions is likely to be discovered, but rather it will appear that these conditions resulted from the interaction of a complicated series of factors; and further, until a greater degree of unanimity can be approached in the interpretation of observed facts, particularly as regards the substantiality of interglacial epochs, the very foundations of a sound working hypothesis are wanting.

Classification of Glacial Deposits—Interglacial Epochs.—Had the deposits of glaciated regions consisted solely of boulder clay little difficulty might have been experienced in dealing with their classification. But there are intercalated in the boulder clays those irregular stratified and partially stratified masses of sand, gravel and loam, frequently containing marine or freshwater shells and layers of peat with plant remains, which have given rise to the conception of "interglacial epochs"—

passes in the rigorous conditions of glaciation, when the ice-sheets dwindled almost entirely away; while plants and animals re-established themselves on the newly exposed soil. Glacialists may be ranged in two schools: those who believe that one or more phases of milder climatic conditions broke up the whole Glacial period into alternating epochs of glaciation and "deglaciation"; and those who believe that the intercalated deposits represent rather the *localized* recessional movements of the ice-sheets within one single period of glaciation. In addition to the stratified deposits and their contents, important evidence in favour of interglacial epochs occurs in the presence of weathered surfaces on the top of older boulder clays, which are themselves covered by younger glacial deposits.

The cause of the interglacial hypothesis has been most ardently championed in England by Professor James Geikie; who has endeavoured to show that there were in Europe six distinct glacial epochs within the Glacial period, separated by five epochs of more moderate temperature. These are enumerated below:

6th Glacial epoch, Upper Turbarian, indicated by the deposits of peat which underlie the lower raised beaches.

5th Interglacial epoch, *Upper Forestian*.

5th Glacial epoch, Lower Turbarian, indicated by peat deposits overlying the lower forest-bed, by the raised beaches and carse-clays of Scotland, and in part by the *Littorina*-clays of Scandinavia.

4th Interglacial epoch, *Lower Forestian*, the lower forests under peat beds, the *Ancylus*-beds of the great freshwater Baltic lake and the *Littorina*-clays of Scandinavia.

4th Glacial epoch, Mecklenburgian, represented by the moraines of the last great Baltic glacier, which reach their southern limit in Mecklenburg; the 100-ft. terrace of Scotland and the *Yoldia*-beds of Scandinavia.

3rd Interglacial epoch, *Neudeckian*, intercalations of marine and freshwater deposits in the boulder clay of the southern Baltic coasts.

3rd Glacial epoch, Polandian, glacial and fluvi-glacial formations of the minor Scandinavian ice-sheet; and the "upper boulder clay" of northern and western Europe.

2nd Interglacial epoch, *Helvetian*, interglacial beds of Britain and *Engines* of Switzerland.

2nd Glacial epoch, Saxonian, deposits of the period of maximum glaciation when the northern ice-sheet reached the low ground of Saxony, and the Alpine glaciers formed the outermost moraines.

1st Interglacial epoch, *Norfolkian*, the forest-bed series of Norfolk.

1st Glacial epoch, Scanian, represented only in the south of Sweden, which was overridden by a large Baltic glacier. The Chillesford clay and Weybourne crag of Norfolk and the oldest moraines and fluvi-glacial gravels of the Arctic lands may belong to this epoch.

In a similar manner Professor Chamberlin and other American geologists have recognized the following stages in the glaciation of North America:

The Champlain, marine substage.

The Glacio-lacustrine substage.

The later Wisconsin (6th glacial).

The fifth interglacial.

The earlier Wisconsin (5th glacial).

The Peorian (4th interglacial).

The Iowan (4th glacial).

The Sangamon (3rd interglacial).

The Illinoian (3rd glacial).

The Yarmouth or Buchanan (2nd interglacial).

The Kansan (2nd glacial).

The Aftonian (1st interglacial).

The sub-Aftonian or Jerseyan (1st glacial).

Although it is admitted that no strict correlation of the European and North American stages is possible, it has been suggested that the Aftonian may be the equivalent of the Helvetian; the Kansan may represent the Saxonian; the Iowan, the Polandian; the Jerseyan, the Scanian; the early Wisconsin, the Mecklenburgian. But considering how fragmentary is much of the evidence in favour of these stages both in Europe and America, the value of such attempts at correlation must be infinitesimal. This is the more evident when it is observed that there are other geologists of equal eminence who are unable to accept so large a number of epochs after a close study of the local circumstances; thus, in the subjoined scheme for north Germany, after H. W. Munthe, there are three glacial and two interglacial epochs.

- Post-Glacial epoch { The *Mys* time = beech-time.
- { The *Littorina* time = oak-time.
- { The *Ancylus* time = pine- and birch-time.
- 3rd Glacial " { Including the upper boulder clay,
- { "younger Baltic moraine" with the
- { *Yoldia* or *Dryas* phase in the retro-
- { gressive stage.
- 2nd Interglacial epoch including the *Cyprina*-clay.
- 2nd Glacial epoch, the maximum glaciation.
- 1st Interglacial epoch.
- 1st Glacial epoch, "older boulder clay."

Again, in the Alps four interglacial epochs have been recognized; while in England there are many who are willing to concede one such epoch, though even for this the evidence is not enough to satisfy all glacialists (G. W. Lamplugh, Address, Section C, *Brit. Assoc.*, York, 1906).

This great diversity of opinion is eloquent of the difficulties of the subject; it is impossible not to see that the discovery of interglacial epochs bears a close relationship to the origin of certain hypotheses of the cause of glaciation; while it is significant that those who have had to do the actual mapping of glacial deposits have usually greater difficulty in finding good evidence of such definite ameliorations of climate, than those who have founded their views upon the examination of numerous but isolated areas.

Extent of Glacial Deposits.—From evidence of the kind cited above, it appears that during the glacial period a series of great ice-sheets covered enormous areas in North America and north-west Europe. The area covered during the maximum extension of the ice *Mas* been reckoned at 20 million square kilometres (nearly 8 million sq. m.) in North America and 6½ million square kilometres (about 2½ million sq. m.) in Europe.

In Europe three great centres existed from which the ice-streams radiated; foremost in importance was the region of Fennoscandia (the name for Scandinavia with Finland as a single geological region); from this centre the ice spread out far into Germany and Russia and westward, across the North Sea, to the shores of Britain. The southern boundary of the ice extended from the estuary of the Rhine in an irregular series of lobes along the Schiefergebirge, Harz, Thüringerwald, Erzgebirge and Riesengebirge, and the northern flanks of the Carpathians towards Cracow. Down the valley of the Dnieper a lobe of the ice-sheet projected as far as 40° 50' N.; another lobe extended down the Don valley as far as 48° N.; thence the boundary runs north-easterly towards the Urals and the Kara Sea. The British Islands constituted the centre second in importance; Scotland, Ireland and all but the western part of England were covered by a moving ice-cap. On the west the ice-sheets reached out to sea; on the east they were continuous with those from Scandinavia. The third European centre was the Alpine region; it is abundantly clear from the masses of morainic detritus and perched blocks that here, in the time of maximum glaciation, the ice-covered area was enormously in excess of the shrivelled remnants, which still remain in the existing glaciers. All the valleys were filled with moving ice; thus the Rhone glacier at its maximum filled Lake Geneva and the plain between the Bernese Oberland and the Jura; it even overrode the latter and advanced towards Besançon. Extensive glaciation was not limited to the aforesaid regions, for all the areas of high ground had their independent glaciers strongly developed; the Pyrenees, the central highlands of France, the Vosges, Black Forest, Apennines and Caucasus were centres of minor but still important glaciation.

The greatest expansion of ice-sheets was located on the North American continent; here, too, there were three principal centres of outflow: the "Cordilleran" ice-sheet in the N.W., the "Keewatin" sheet, radiating from the central Canadian plains, and the eastern "Labrador" or "Laurentide" sheet. From each of these centres the ice poured outwards in every direction, but the principal flow in each case was towards the south-west. The southern boundary of the glaciated area runs as an irregular line along the 49° parallel in the western part of the continent, thence it follows the Mississippi valley down to its junction with the Ohio (southern limit 37° 30' N.), eastward it follows the direction of that river and turns north-eastward in the direction of New Jersey. As in Europe, the mountainous regions of North America produced their own local glaciers; in the Rockies, the Olympics and Sierras, the Bighorn Mountains of Wyoming, the Uinta Mountains of Utah, &c. Although it was in the northern hemisphere that the most extensive glaciation took place, the effects of a general lowering of temperature seem to have been felt in the mountainous regions of all parts; thus in South America, New Zealand, Australia and Tasmania glaciers reached down the valleys far below the existing limits, and even where none are now to be found. In Asia the evidences of a former extension of glaciation are traceable in the Himalayas, and northward in the high ranges of China and Eastern Siberia. The same is true of parts of Turkestan and Lebanon. In Africa also, in British East Africa moraines are discovered 5400 ft. below their modern limit. In Iceland and Greenland, and even in the Antarctic, there appears to be evidence of a former greater extension of the ice. It is of interest to note that Alaska seems to be free from excessive glaciation, and that a remarkable "driftless" area lies in Wisconsin. The maximum glaciation of the Glacial period was clearly centred around the North Atlantic.

Glacial Epochs in the Older Geological Periods.—Since Ramsay drew attention to the subject in 1855 ("On the occurrence of angular, subangular, polished and striated fragments and boulders in the Permian Breccia of Shropshire, Worcestershire, &c., and on the probable existence of glaciers and icebergs in the Permian epoch," *Q.J.G.S.*, 1855, pp. 185-205), a good deal of attention has been paid to such formations. It is now generally acknowledged that the Permo-carboniferous conglomerates with striated boulders and polished rock surfaces, such as are found in the Karoo formation of South Africa, the Talkir conglomerate of the Salt Range in India, and the corresponding formations in Australia, represent undeniable

glacial conditions at that period on the great Indo-Australian continent. A glacial origin has been suggested for numerous other conglomeratic formations, such as the Pre-Cambrian Torridonian of Scotland, and "Gleisschichten" of Norway; the basal Carboniferous conglomerate of parts of England; the Permian breccias of England and parts of Europe; the Trias of Devonshire; the coarse conglomerates in the Tertiary Flysch in central Europe; and the Miocene conglomerates of the Ligurian Apennines. In regard to the glacial nature of all these formations there is, however, great divergence of opinion (see A. Heim, "Zur Frage der exotischen Blöcke in Flysch," *Eologie geologica Helvetiae*, vol. ix. No. 3, 1907, pp. 413-424).

AUTHORITIES.—The literature dealing directly with the Glacial period has reached enormous dimensions; in addition to the works already mentioned the following may be taken as a guide to the general outline of the subject: J. Geikie, *The Great Ice Age* (3rd ed., London, 1904), also *Earth Sculpture* (1898); G. F. Wright, *The Ice Age in North America* (4th ed., New York, 1905) and *Man and the Glacial Period* (1892); F. E. Geinitz, *Die Eiszeit* (Braunschweig, 1906); A. Penck and E. Brückner, *Die Alpen im Eiszeitalter* (Leipzig, 1901-1906, uncompleted). Many references to the literature will be found in Sir A. Geikie's *Textbook of Geology*, vol. ii. (4th ed., 1903); Chamberlain and Salisbury, *Geology*, vol. iii. (1906). As an example of glacial theories carried beyond the usual limits, see M. Guggenhan, *Die Ergletscherung der Erde von Pol zu Pol* (Berlin, 1906). See also *Zeitschrift für Gleichzeitige* (Berlin, 1906 and onwards quarterly); Sir H. H. Howorth (opposing accepted glacial theories), *The Glacial Nightmare and the Flood*, i., ii. (London, 1893); *Ice and Water*, i., ii. (London, 1905); *The Mammoth and the Flood* (London, 1887). (J. A. H.)

GLACIER (adopted from the French; from *glace*, ice, Lat. *glacies*), a mass of compacted ice originating in a snow-field. Glaciers are formed on any portion of the earth's surface that is permanently above the snow-line. This line varies locally in the same latitudes, being in some places higher than in others, but in the main it may be described as an elliptical shell surrounding the earth with its longest diameter in the tropics and its shortest in the polar regions, where it touches sea-level. From the extreme regions of the Arctic and Antarctic circles this cold shell swells upwards into a broad dome, from 15,000 to 18,000 ft. high over the tropics, truncating, as it rises, a number of peaks and mountain ranges whose upper portions like all regions above this thermal shell receive all their moisture in the form of snow. Since the temperature above the snow-line is below freezing point evaporation is very slight, and as the snow is solid it tends to accumulate in snow-fields, where the snow of one year is covered by that of the next, and these are wrapped over many deeper layers that have fallen in previous years. If these piles of snow were rigid and immovable they would increase in height until the whole field rose above the zone of ordinary atmospheric precipitation, and the polar ice-caps would add a load to these regions that would produce far-reaching results. The mountain regions also would rise some miles in height, and all their features would be buried in domes of snow some miles in thickness. When, however, there is sufficient weight the mass yields to pressure and flows outwards and downwards. Thus a balance of weight and height is established, and the ice-field is disintegrated principally at the edges, the surplus in polar regions being carried off in the form of icebergs, and in mountain regions by streams that flow from the melting ends of the glaciers.

Formation.—The formation of glaciers is in all cases due to similar causes, namely, to periodical and intermittent falls of snow. After a snow-fall there is a period of rest during which the snow becomes compacted by pressure and assumes the well-known granular character seen in banks and patches of ordinary snow that lie longest upon the ground when the snow is melting. This is the *firn* or *névé*. The next fall of snow covers and conceals the *névé*, but the light fresh crystals of this new snow in turn become compacted to the coarsely crystalline granular form of the underlying layer and become *névé* in turn. The process goes on continually; the lower layers become subject to greater and greater pressure, and in consequence become gradually compacted into dense clear ice, which, however, retains its granular crystalline texture throughout. The upper layers of *névé* are usually stratified, owing to some individual peculiarity in the fall, or to the accumulation of dust or débris upon the surface before it is covered by fresh snow. This stratification

is often visible on the emerging glacier, though it is to be distinguished from the foliation planes caused by shearing movement in the body of the glacier ice.

Types.—The snow-field upon which a glacier depends is always formed when snow-fall is greater than snow-waste. This occurs under varying conditions with a differently resulting type of glacier. There are limited fields of snow in many mountain regions giving rise to long tongues of ice moving slowly down the valleys and therefore called "valley glaciers." The greater part of Greenland is covered by an ice-cap extending over nearly 400,000 sq. m., forming a kind of enormous continuous glacier on its lower slopes. The Antarctic ice region is believed to extend over more than 3,000,000 sq. m. Each of these continental fields, besides producing block as distinguished from tongue glaciers, sends into the sea a great number of icebergs during the summer season. These ice-caps covering great regions are by far the most important types. Between these "polar" or "continental glaciers" and the "alpine" type there are many grades. Smaller detached ice-caps may rest upon high plateaus as in Iceland, or several tongues of ice coming down neighbouring valleys may splay out into convergent lobes on lower ground and form a "piedmont glacier" such as the Malaspina Glacier in Alaska. When the snow-field lies in a small depression the glacier may remain suspended in the hollow and advance no farther than the edge of the snow-field. This is called a "cliff-glacier," and is not uncommon in mountain regions. The end of a larger glacier, or the edge of an ice-sheet, may reach a precipitous cliff, where the ice will break from the edge of the advancing mass and fall in blocks to the lower ground, where a "reconstructed glacier" will be formed from the fragments and advance farther down the slope.

When a glacier originates upon a dome-shaped or a level surface the ice will deploy radially in all directions. When a snow-field is formed above steep valleys separated by high ridges the ice will flow downwards in long streams. If the valleys under the snow-fields are wide and shallow the resultant glaciers will broaden out and partially fill them, and in all cases, since the conditions of glacier formation are similar, the resultant form and the direction of motion will depend upon the amount of ice and the form of the surface over which the glacier flows. A glacier flowing down a narrow gorge to an open valley, or on to a plain, will spread at its foot into a fan-shaped lobe as the ice spreads outwards while moving downwards. An ice-cap is in the main thickest at the centre, and thins out at the edges. A valley glacier is thickest at some point between its source and its end, but nearer to its source than to its termination, but its thickness at various portions will depend upon the contour of the valley floor over which the glacier rides, and may reach many hundreds of feet. At its centre the Greenland ice-cap is estimated to be over 5000 ft. thick. In all cases the glacier ends where the waste of ice is greater than the supply, and since the relationship varies in different years, or cycles of years, the end of a glacier may advance or retreat in harmony with greater or less snow-fall or with cooler or hotter summers. There seems to be a cycle of inclusive contraction and expansion of from 35 to 40 or 50 years. At present the ends of the Swiss glaciers are cradled in a mass of moraine-stuff due to former extension of the glaciers, and investigations in India show that in some parts of the Himalayas the glaciers are retreating as they are in North America and even in the southern hemisphere (*Nature*, January 2, 1908, p. 201).

Movement.—The fact that a glacier moves is easily demonstrated; the cause of the movement is pressure upon a yielding mass; the nature of the movement is still under discussion. Rows of stakes or stones placed in line across a glacier are found to change their position with respect to objects on the bank and also with regard to each other. The posts in the centre of the ice-stream gradually move away from those at the side, proving that the centre moves faster than the sides. It has also been proved that the surface portions move more rapidly than the deeper layers and that the motion is slowest at the sides and bottom where friction is greatest.

The rate of motion past the same spot is not uniform. Heat accelerates it, cold arrests it, and the pressure of a large amount of water stimulates the flow. The rate of flow under the same conditions varies at different parts of the glacier directly as the thickness of ice, the steepness of slope and the smoothness of rocky floor. Generally speaking, the rate of motion depends upon the amount of ice that forms the "head" pressure, the slope of the under surface and of the upper surface, the nature of the floor, the temperature and the amount of water present in the ice. The ordinary rate of motion is very slow. In Switzerland it is from 1 or 2 in. to 4 ft. per day, in Alaska 7 ft., in Greenland 50 to 60 ft., and occasionally 100 ft. per day in the height of summer under exceptional conditions of quantity of ice and of water and slope. Measurements of Swiss glaciers show that near the ice foot where wastage is great there is very little movement, and observations upon the inland border of Greenland ice show that it is almost stationary over long distances. In many aspects the motion of a body of ice resembles that of a body of water, and an alpine glacier is often called an ice-river, since like a river it moves faster in the centre than at the sides and at the top faster than at the bottom. A glacier follows a curve in the same way as a river, and there appear to be ice swirls and eddies as well as an upward creep on shelving curves recalling many features of stream action. The rate of motion of both ice-stream and river is accelerated by quantity and steepness of slope and retarded by roughness of bed, but here the comparison ends, for temperature does not affect the rate of water motion, nor will a liquid crack into crevasses as a glacier does, or move upwards over an adverse slope as a glacier always does when there is sufficient "head" of ice above it. So that although in many respects ice behaves as a viscous fluid the comparison with such a fluid is not perfect. The cause of glacier motion must be based upon some more or less complex considerations. The flakes of snow are gradually transformed into granules because the points and angles of the original flakes melt and evaporate more readily than the more solid central portions, which become aggregated round some master flake that continues to grow in the névé at the expense of its smaller neighbours, and increases in size until finally the glacier ice is composed of a mass of interlocked crystalline granules, some as large as a walnut, closely compacted under pressure with the principal crystalline axes in various directions. In the upper portions of the glacier movement due to pressure probably takes place by the gliding of one granule over another. In this connexion it must be noted that pressure lowers the melting point of ice while tension raises it, and at all points of pressure there is therefore a tendency to momentary melting, and also to some evaporation due to the heat caused by pressure, and at the intermediate tension spaces between the points of pressure this resultant liquid and vapour will be at once re-frozen and become solid. The granular movement is thus greatly facilitated, while the body of ice remains in a crystalline solid condition. In this connexion it is well to remember that the pressure of the glacier upon its floor will have the same result, but the effect here is a mass-effect and facilitates the gliding of the ice over obstacles, since the friction produces heat and the pressure lowers the melting point, so that the two causes tend to liquefy the portion where pressure is greatest and so to "lubricate" the prominences and enable the glacier to slide more easily over them, while the liquid thus produced is re-frozen when the pressure is removed.

In polar regions of very low temperature a very considerable amount of pressure must be necessary before the ice granules yield to momentary liquefaction at the points of pressure, and this probably accounts for the extreme thickness of the Arctic and Antarctic ice-caps where the slopes are moderate, for although equally low temperatures are found in high Alpine snow-fields the slopes there are exceedingly steep and motion is therefore more easily produced.

Observations made upon the Greenland glaciers indicate a considerable amount of "shearing" movement in the lower portions of a glacier. Where obstacles in the bed of the glaciers

arrest the movement of the ice immediately above it, or where the lower portion of the glacier is choked by débris, the upper ice glides over the lower in shearing planes that are sometimes strongly marked by débris caught and pushed forwards along these planes of foliation. It must be remembered that there is a solid push from behind upon the lower portion of a glacier, quite different from the pressure of a body of water upon any point, for the pressure of a fluid is equal in all directions, and also that this push will tend to set the crystalline granules in positions in which their crystalline axes are parallel along the gliding planes. The production of gliding planes is in some cases facilitated by the descent into the glacier of water melted during summer, where it expands in freezing and pushes the adjacent ice away from it, forming a surface along which movement is readily established.

If under all circumstances the glacier melted under pressure at the bottom, glacial abrasion would be nearly impossible, since every small stone and fragment of rock would rotate in a liquid shell as the ice moved forward, but since the pressure is not always sufficient to produce melting, the glacier sometimes remains dry at its base; rock fragments are held firmly; and a dry glacier may thus become a graving tool of enormous power. Whatever views may be adopted as to the causes of glacier motion, the peculiar character of glacier ice as distinct from homogeneous river or pond ice must be kept in view, as well as the characteristic tendency of water to expand in freezing, the lowering of the melting point of ice under pressure, the raising of the melting point under tension, the production of gliding or shearing planes under pressure from above, the presence in summer of a considerable quantity of water in the lower portions of the glacier which are thus loosened, the cracking of ice (as into crevasses), under sudden strain, and the regelation of ice in contact. A result of this last process is that fissures are not permanent, but having been produced by the passage of ice over an obstruction, they subsequently become healed when the ice proceeds over a flatter bed. Finally it must be remembered that although glacier ice behaves in some sense like a viscous fluid its condition is totally different, since "a glacier is a crystalline rock of the purest and simplest type, and it never has other than the crystalline state."

Characteristics.—The general appearance of a glacier varies according to its environment of position and temperature. The upper portion is hidden by névé and often by freshly fallen snow, and is smooth and unbroken. During the summer, when little snow falls, the body of the glacier moves away from the snow-field and a gaping crevasse of great depth is usually established called the *bergschrund*, which is sometimes taken as the upper limit of the glacier. The glacier as it moves down the valley may become "loaded" in various ways. Rock-falls send periodical showers of stones upon it from the heights, and these are spread out into long lines at the glacier sides as the ice moves downwards carrying the rock fragments with it. These are the "lateral moraines." When two or more glaciers descending adjacent valleys converge into one glacier one or more sides of the higher valleys disappear, and the ice that was contained in several valleys is now carried by one. In the simplest case where two valleys converge into one the two inner lateral moraines meet and continue to stream down the larger valley as one "median moraine." Where several valleys meet there are several such parallel median moraines, and so long as the ice remains unbroken these will be carried upon the surface of the glacier and finally tipped over the end. There is, however, differential heating of rock and ice, and if the stones carried are thin they tend to sink into the ice because they absorb heat readily and melt the ice under them. Dust has the same effect and produces "dust wells" that honeycomb the upper surface of the ice with holes into which the dust sinks. If the moraine rocks are thick they prevent the ice under them from melting in sunlight, and isolated blocks often remain supported upon ice-pillars in the form of ice tables, which finally collapse, so that such rocks may be scattered out of the line of the moraine. As the glacier descends into

the lower valleys it is more strongly heated, and surface streams are established in consequence that flow into channels caused by unequal melting of the ice and finally plunge into crevasses. These crevasses are formed by strains established as the central parts drag away from the sides of the glacier and the upper surface from the lower, and more markedly by the tension due to a sudden bend in the glacier caused by an inequality in its bed which must be over-ridden. These crevasses are developed at right angles to the strain and often produce intersecting fissures in several directions. The morainic material is gradually dispersed by the inequalities produced, and is further distributed by the action of superficial streams until the whole surface is strewn with stones and débris, and presents, as in the lower portions of the Mer de Glace, an exceedingly dirty appearance. Many blocks of stone fall into the gaping crevasses and much loose rock is carried down as "englacial material" in the body of the glacier. Some of it reaches the bottom and becomes part of the "ground moraine" which underlies the glacier, at least from the *bergschrand* to the "snout," where much of it is carried away by the issuing stream and spread finally on to the plains below. It appears that a very considerable amount of degradation is caused under the *bergschrand* by the mass of ice "plucking" and dragging great blocks of rock from the side of the mountain valley where the great head of ice rests in winter and whence it begins to move in summer. These blocks and many smaller fragments are carried downwards wedged in the ice and cause powerful abrasion upon the rocky floor, rasping and scoring the channel, producing conspicuous striae, polishing and rounding the rock surfaces, and grinding the contained fragments as well as the surface over which it passes into small fragments and fine powder, from which "boulder clay" or "till" is finally produced. Emerging, then, from the snow-field as pure granular ice the glacier gradually becomes strewn and filled with foreign material, not only from above but also, as is very evident in some Greenland glaciers, occasionally from below by masses of fragments that move upwards along gliding planes, or are forced upwards by slow swirls in the ice itself.

As a glacier is a very brittle body any abrupt change in gradient will produce a number of crevasses, and these, together with those produced by dragging strains, will frequently wedge the glacier into a mass of pinnacles or *séracs* that may be partially healed but are usually evident when the melting end of the glacier emerges suddenly from a steep valley. Here the streams widen the weaker portions and the moraine rocks fall from the end to produce the "terminal" moraine, which usually lies in a crescentic heap encircling the glacier snout, whence it can only be moved by a further advance of the glacier or by the ordinary slow process of atmospheric denudation.

In cases where no rock falls upon the surface there is a considerable amount of englacial material due to upturning either over accumulated ground débris or over structural inequalities in the rock floor. This is well seen at the steep sides and ends of Greenland glaciers, where material frequently comes to the surface of the melting ice and produces median and lateral moraines, besides appearing in enormous "eyes" surrounded in the glacial body by contorted and foliated ice and sometimes producing heaps and embankments as it is pushed out at the end of the melting ice.

The environment of temperature requires consideration. At the upper or dorsal portion of the glacier there is a zone of variable (winter and summer) temperature, beneath which, if the ice is thick enough, there is a zone of constant temperature which will be about the mean annual temperature of the region of the snow-field. Underlying this there is a more or less constant ventral or ground temperature, depending mainly upon the internal heat of the earth, which is conducted to the under surface of the glacier where it slowly melts the ice, the more readily because the pressure lowers the melting point considerably, so that streams of water run constantly from beneath many glaciers, adding their volume to the springs which issue from the rock. The middle zone of constant temperature is wedge-shaped

in "alpine" glaciers, the apex pointing downwards to the zone of waste. The upper zone of variable temperature is thinnest in the snow-field where the mean temperature is lowest, and entirely dominant in the snout end of the glacier where the zone of constant temperature disappears. Two temperature wedges are thus superposed base to point, the one being thickest where the other is thinnest, and both these lie upon the basal film of temperature where the escaping earth-heat is strengthened by that due to friction and pressure. The cold wave of winter may pass right through a thin glacier, or the constant temperature may be too low to permit of the ice melting at the base, in which cases the glacier is "dry" and has great eroding power. But in the lower warmer portions water running through crevasses will raise the temperature, and increase the strength of the downward heat wave, while the mean annual temperature being there higher, the combined result will be that the glacier will gradually become "wet" at the base and have little eroding power, and it will become more and more wet as it moves down the lower valley zone of ice-waste, until at last the balance is reached between waste and supply and the glacier finally disappears.

If the mean annual temperature be 20° F., and the mean winter temperature be -12° F., as in parts of Greenland, all the ice must be considerably below the melting point, since the pressure of ice a mile in depth lowers the melting point only to 30° F., and the earth-heat is only sufficient to melt $\frac{1}{2}$ in. of ice in a year. Therefore in these regions, and in snow-fields and high glaciers with an equal or lower mean temperature than 20° F., the glacier will be "dry" throughout, which may account for the great eroding power stated to exist near the *bergschrand* in glaciers of an alpine type, which usually have their origin on precipitous slopes.

A considerable amount of ice-waste takes place by water-drainage, though much is the result of constant evaporation from the ice surface. The lower end of a glacier is in summer flooded by streams of water that pour along cracks and plunge into crevasses, often forming "pot-holes" or *moulins* where stones are swirled round in a glacial "mill" and wear holes in the solid rock below. Some of these streams issue in a spout half way up the glacier's end wall, but the majority find their way through it and join the water running along the glacier floor and emerging where the glacier ends in a large glacial stream.

Results of Glacial Action.—A glacier is a degrading and an aggrading agent. Much difference of opinion exists as to the potency of a glacier to alter surface features, some maintaining that it is extraordinarily effective, and considering that a valley glacier forms a pronounced *cirque* at the region of its origin and that the *cirque* is gradually cut backward until a long and deep valley is formed (which becomes evident, as in the Rocky Mountains, in an upper valley with "reversed grade" when the glacier disappears), and also that the end of a glacier plunging into a valley or a fjord will gouge a deep basin at its region of impact. The Alaskan and Norwegian fjords and the rock basins of the Scottish lochs are adduced as examples. Other writers maintain that a glacier is only a modifying and not a dominant agent in its effects upon the land-surface, considering, for example, that a glacier coming down a lateral valley will preserve the valley from the atmospheric denudation which has produced the main valley over which the lateral valley "hangs," a result which the believers in strong glacial action hold to be due to the more powerful action of the main glacier as contrasted with the weaker action of that in the lateral valley. Both the advocates and the opponents of strenuous ice action agree that a V-shaped valley of stream erosion is converted to a U-shaped valley of glacial modification, and that rock surfaces are rounded into *roches moutonnées*, and are grooved and striated by the passage of ice shod with fragments of rock, while the subglacial material is ground into finer and finer fragments until it becomes mud and "rock-flour" as the glacier proceeds. In any case striking results are manifest in any formerly glaciated region. The high peaks rise into pinnacles, and ridges with "house-roof" structure,

above the former glacier, while below it the contours are all rounded and typically subdued. A landscape that was formerly completely covered by a moving ice-cap has none but these rounded features of dome-shaped hills and U-shaped valleys that at least bear evidence to the great modifying power that a glacier has upon a landscape.

There is no conflict of opinion with regard to glacial aggradation and the distribution of superglacial, englacial and subglacial material, which during the active existence of a glacier is finally distributed by glacial streams that produce very considerable alluviation. In many regions which were covered by the Pleistocene ice-sheet the work of the glacier was arrested by melting before it was half done. Great deposits of till and boulder clay that lay beneath the glaciers were abandoned *in situ*, and remain as an unsorted mixture of large boulders, pebbles and mingled fragments, embedded in clay or sand. The lateral, median and terminal moraines were stranded where they sank as the ice disappeared, and together with perched blocks (*roches perchées*) remain as a permanent record of former conditions which are now found to have existed temporarily in much earlier geological times. In glaciated North America lateral moraines are found that are 500 to 1000 ft. high and in northern Italy 1500 to 2000 ft. high. The surface of the ground in all these places is modified into the characteristic glaciated landscape, and many formerly deep valleys are choked with glacial débris either completely changing the local drainage systems, or compelling the reappearing streams to cut new channels in a superposed drainage system. Kames also and eskers (*q.v.*) are left under certain conditions, with many puzzling deposits that are clearly due to some features of ice-work not thoroughly understood.

See L. Agassiz, *Études sur les glaciers* (Neuchâtel, 1840) and *Nouvelles Études* . . . (Paris, 1847); N. S. Shaler and W. M. Davis, *Glaciers* (Boston, 1881); A. Penck, *Die Begletscherung der deutschen Alpen* (Leipzig, 1882); J. Tyndall, *The Glaciers of the Alps* (London, 1896); T. G. Bonney, *Ice-Work, Past and Present* (London, 1896); I. C. Russell, *Glaciers of North America* (Boston, 1897); E. Richter, *Neue Ergebnisse und Probleme der Gletscherforschung* (Vienna, 1899); F. Forel, *Essai sur les variations périodiques des glaciers* (Geneva, 1881 and 1900); H. Hesse, *Die Gletscher* (Brunswick, 1904). (E. C. SF.)

GLACIS, in military engineering (see FORTIFICATION AND SIEGE-CRAFT), an artificial slope of earth in the front of works, so constructed as to keep an assailant under the fire of the defenders to the last possible moment. On the natural ground-level, troops attacking any high work would be sheltered from its fire when close up to it; the ground therefore is raised to form a glacis, which is swept by the fire of the parapet. More generally, the term is used to denote any slope, natural or artificial, which fulfils the above requirements.

GLADBACH, the name of two towns in Germany distinguished as Bergisch-Gladbach and München-Gladbach.

1. **BERGISCH-GLADBACH** is in Rhenish Prussia, 8 m. N.E. of Cologne by rail. Pop. (1905) 13,410. It possesses four large paper mills and among its other industries are paste-board, powder, percussion caps, nets and machinery. Ironstone, peat and lime are found in the vicinity. The town has four Roman Catholic churches and one Protestant. The Stundenthalshöhe, a popular resort, is in the neighbourhood, and near Gladbach is Altenberg, with a remarkably fine church, built for the Cistercian abbey at this place.

2. **MÜNCHEN-GLADBACH**, also in Rhenish Prussia, 16 m. W.S.W. of Düsseldorf on the main line of railway to Aix-la-Chapelle. Pop. (1885) 44,250; (1905) 60,714. It is one of the chief manufacturing places in Rhenish Prussia, its principal industries being the spinning and weaving of cotton, the manufacture of silks, velvet, ribbon and damasks, and dyeing and bleaching. There are also tanneries, tobacco manufactories, machine works and foundries. The town possesses a fine park and has statues of the emperor William I. and of Prince Bismarck. There are ten Roman Catholic churches here, among them being the beautiful minster, with a Gothic choir dating from 1250, a nave dating from the beginning of the 13th century and a crypt of the 8th century. The town has two hospitals, several schools, and is the headquarters of important insurance societies.

Gladbach existed before the time of Charlemagne, and a Benedictine monastery was founded near it in 793. It was thus called München-Gladbach or Monks' Gladbach, to distinguish it from another town of the same name. The monastery was suppressed in 1802. It became a town in 1336; weaving was introduced here towards the end of the 18th century, and having belonged for a long time to the duchy of Juliers it came into the possession of Prussia in 1815.

See Strauss, *Geschichte der Stadt München-Gladbach* (1895); and G. Eckertz, *Das Verbrüderungs- und Totenbuch der Abtei Gladbach* (1881).

GLADEN, WASHINGTON (1836-), American Congregational divine, was born in Pottsgrove, Pennsylvania, on the 11th of February 1836. He graduated at Williams College in 1859, preached in churches in Brooklyn, Morrisania (New York City), North Adams, Massachusetts, and Springfield, Massachusetts, and in 1882 became pastor of the First Congregational Church of Columbus, Ohio. He was an editor of the *Independent* in 1871-1875, and a frequent contributor to it and other periodicals. He consistently and earnestly urged in pulpit and press the need of personal, civil and, particularly, social righteousness, and in 1900-1902 was a member of the city council of Columbus. Among his many publications, which include sermons, occasional addresses, &c., are: *Plain Thoughts on the Art of Living* (1868); *Workmen and their Employers* (1876); *The Christian Way* (1877); *Things New and Old* (1884); *Applied Christianity* (1887); *Tools and the Man—Property and Industry under the Christian Law* (1893); *The Church and the Kingdom* (1894), arguing against a confusion and misuse of these two terms; *Seven Puzzling Bible Books* (1897); *How much is Left of the Old Doctrines* (1899); *Social Salvation* (1901); *Witnesses of the Light* (1903); the William Belden Noble Lectures (Harvard), being addresses on Dante, Michelangelo, Fichte, Hugo, Wagner and Ruskin; *The New Idolatry* (1905); *Christianity and Socialism* (1906), and *The Church and Modern Life* (1908). In 1909 he published his *Recollections*.

GLADIATORS (from Lat. *gladius*, sword), professional combatants who fought to the death in Roman public shows. That this form of spectacle, which is almost peculiar to Rome and the Roman provinces, was originally borrowed from Etruria is shown by various indications. On an Etruscan tomb discovered at Tarquinii there is a representation of gladiatorial games; the slaves employed to carry off the dead bodies from the arena wore masks representing the Etruscan Charon; and we learn from Isidore of Seville (*Origines*, x.) that the name for a trainer of gladiators (*lanista*) is an Etruscan word meaning butcher or executioner. These gladiatorial games are evidently a survival of the practice of immolating slaves and prisoners on the tombs of illustrious chieftains, a practice recorded in Greek, Roman and Scandinavian legends, and traceable even as late as the 19th century as the Indian *sultes*. Even at Rome they were for a long time confined to funerals, and hence the older name for gladiators was *bustuarii*; but in the later days of the republic their original significance was forgotten, and they formed as indispensable a part of the public amusements as the theatre and the circus.

The first gladiators are said, on the authority of Valerius Maximus (ii. 4. 7), to have been exhibited at Rome in the Forum Boarium in 264 B.C. by Marcus and Decimus Brutus at the funeral of their father. On this occasion only three pairs fought, but the taste for these games spread rapidly, and the number of combatants grew apace. In 174 Titus Flamininus celebrated his father's obsequies by a three-days' fight, in which 74 gladiators took part. Julius Caesar engaged such extravagant numbers for his aedileship that his political opponents took fright and carried a decree of the senate imposing a certain limit of numbers, but notwithstanding this restriction he was able to exhibit no less than 300 pairs. During the later days of the republic the gladiators were a constant element of danger to the public peace. The more turbulent spirits among the nobility had each his band of gladiators to act as a bodyguard, and the armed troops of Clodius, Milo and Catiline played the same part

in Roman history as the armed retainers of the feudal barons or the condottieri of the Italian republics. Under the empire, notwithstanding sumptuary enactments, the passion for the arena steadily increased. Augustus, indeed, limited the shows to two a year, and forbade a praetor to exhibit more than 120 gladiators, yet allusions in Horace (*Sat.* ii. 3. 85) and Persius (vi. 48) show that 100 pairs was the fashionable number for private entertainments; and in the Marmor Ancyranum the emperor states that more than 10,000 men had fought during his reign. The imbecile Claudius was devoted to this pastime, and would sit from morning till night in his chair of state, descending now and then to the arena to coax or force the reluctant gladiators to resume their bloody work. Under Nero senators and even well-born women appeared as combatants; and Juvenal (viii. 199) has handed down to eternal infamy the descendant of the Gracchi who appeared without disguise as a *retiaris*, and begged his life from the *secutor*, who blushed to conquer one so noble and so vile.¹ Titus, whom his countrymen surnamed the Clement, ordered a show which lasted 100 days; and Trajan, in celebration of his triumph over Decebalus, exhibited 5000 pairs of gladiators. Domitian at the Saturnalia of A.D. 90 arranged a battle between dwarfs and women. Even women of high birth fought in the arena, and it was not till A.D. 200 that the practice was forbidden by edict. How widely the taste for these sanguinary spectacles extended throughout the Roman provinces is attested by monuments, inscriptions and the remains of vast amphitheatres. From Britain to Syria there was not a town of any size that could not boast its arena and annual games. After Italy, Gaul, North Africa and Spain were most famous for their amphitheatres; and Greece was the only Roman province where the institution never thoroughly took root.

Gladiators were commonly drawn either from prisoners of war, or slaves or criminals condemned to death. Thus in the first class we read of tattooed Britons in their war chariots, Thracians with their peculiar bucklers and scimitars, Moors from the villages round Atlas and negroes from central Africa, exhibited in the Colosseum. Down to the time of the empire only greater malefactors, such as brigands and incendiaries, were condemned to the arena; but by Caligula, Claudius and Nero this punishment was extended to minor offences, such as fraud and peculation, in order to supply the growing demand for victims. For the first century of the empire it was lawful for masters to sell their slaves as gladiators, but this was forbidden by Hadrian and Marcus Aurelius. Besides these three regular classes, the ranks were recruited by a considerable number of freedmen and Roman citizens who had squandered their estates and voluntarily took the *suctoramentum gladiatorum*, by which for a stated time they bound themselves to the *lanista*. Even men of birth and fortune not seldom entered the lists, either for the pure love of fighting or to gratify the whim of some dissolute emperor; and one emperor, Commodus, actually appeared in person in the arena.

Gladiators were trained in schools (*ludi*) owned either by the state or by private citizens, and though the trade of a *lanista* was considered disgraceful, to own gladiators and let them out for hire was reckoned a legitimate branch of commerce. Thus Cicero, in his letters to Atticus, congratulates his friend on the good bargain he had made in purchasing a band, and urges that he might easily recoup himself by consenting to let them out twice. Men recruited mainly from slaves and criminals, whose lives hung on a thread, must have been more dangerous characters than modern galley slaves or convicts; and, though highly fed and carefully tended, they were of necessity subject to an iron discipline. In the school of gladiators discovered at Pompeii, of the sixty-three skeletons buried in the cells many were in irons. But hard as was the gladiators' lot,—so hard that special precautions had to be taken to prevent suicide,—it had its consolations. A successful gladiator enjoyed far greater fame than any modern prize-fighter or athlete. He was

¹ See A. E. Housman on the passage in *Classical Review* (November 1904).

presented with broad pieces, chains and jewelled helmets, such as may be seen in the museum at Naples; poets like Martial sang his prowess; his portrait was multiplied on vases, lamps and gems; and high-born ladies contended for his favours. Mixed, too, with the lowest dregs of the city, there must have been many noble barbarians condemned to the vile trade by the hard fate of war. There are few finer characters in Roman history than the Thracian Spartacus, who, escaping with seventy of his comrades from the school of Lentulus at Capua, for three years defied the legions of Rome; and after Antony's defeat at Actium, the only part of his army that remained faithful to his cause were the gladiators whom he had enrolled at Cyzicus to grace his anticipated victory.

There were various classes of gladiators, distinguished by their arms or modes of fighting. The Samnites fought with the national weapons—a large oblong shield, a vizor, a plumed helmet and a short sword. The Thracians had a small round buckler and a dagger curved like a scythe; they were generally pitted against the Mirmillones, who were armed in Gallic fashion with helmet, sword and shield, and were so called from the fish (*μυρμίδος* or *μυρμύρος*) which served as the crest of their helmet. In like manner the Retiarius was matched with the Secutor; the former had nothing on but a short tunic or apron, and sought to entangle his pursuer, who was fully armed, with the cast-net (*jaculum*) that he carried in his right hand; and if successful, he despatched him with the trident (*tridens*, *fuscina*) that he carried in his left. We may also mention the Andabatae who are generally believed to have fought on horseback and wore helmets with closed vizors; the Dimachaeri of the later empire, who carried a short sword in each hand; the Essedarii, who fought from chariots like the ancient Britons; the Hoplomachi, who wore a complete suit of armour; and the Laquearii, who tried to lasso their antagonists.

Gladiators also received special names according to the time or circumstances in which they exercised their calling. The Bustuarii have already been mentioned; the Catervarii fought, not in pairs, but in bands; the Meridiani came forward in the middle of the day for the entertainment of those spectators who had not left their seats; the Ordinarii fought only in pairs, in the regular way; the Fisceles were trained and supported at the expense of the imperial treasury; the Paegniarii used harmless weapons, and their exhibition was a sham one; the Röstulaticii were those whose appearance was asked as a favour from the giver of the show, in addition to those already exhibited.

The shows were announced some days before they took place by bills affixed to the walls of houses and public buildings, copies of which were also sold in the streets. These bills gave the names of the chief pairs of competitors, the date of the show, the name of the giver and the different kinds of combats. The spectacle began with a procession of the gladiators through the arena, after which their swords were examined by the giver of the show. The proceedings opened with a sham fight (*proelutio*, *protusio*) with wooden swords and javelins. The signal for real fighting was given by the sound of the trumpet, those who showed fear being driven on to the arena with whips and red-hot irons. When a gladiator was wounded, the spectators shouted *Habet* (he is wounded); if he was at the mercy of his adversary, he lifted up his forefinger to implore the clemency of the people, with whom (in the later times of the republic) the giver left the decision as to his life or death. If the spectators were in favour of mercy, they waved their handkerchiefs; if they desired the death of the conquered gladiator, they turned their thumbs downwards.² The reward of victory consisted of branches of palm, sometimes of money. Gladiators who had exercised their calling for a long time, or such as displayed special skill and bravery, were presented with a wooden sword (*rudis*), and discharged from further service.

² A different account is given by Mayor on Juvenal iii. 36, who says: "Those who wished the death of the conquered gladiator turned their thumbs towards their breasts, as a signal to his opponents to stab him; those who wished him to be spared, turned their thumbs downwards, as a signal for dropping the sword."

Both the estimation in which gladiatorial games were held by Roman moralists, and the influence that they exercised upon the morals and genius of the nation, deserve notice. The Roman was essentially cruel, not so much from spite or vindictiveness as from callousness and defective sympathies. This element of inhumanity and brutality must have been deeply ingrained in the national character to have allowed the games to become popular, but there can be no doubt that it was fed and fostered by the savage form which their amusements took. That the sight of bloodshed provokes a love of bloodshed and cruelty is a commonplace of morals. To the horrors of the arena we may attribute in part, not only the brutal treatment of their slaves and prisoners, but the frequency of suicide among the Romans. On the other hand, we should be careful not to exaggerate the effects or draw too sweeping inferences from the prevalence of this degrading amusement. Human nature is happily illogical; and we know that many of the Roman statesmen who gave these games, and themselves enjoyed these sights of blood, were in every other department of life irreproachable—indulgent fathers, humane generals and mild rulers of provinces. In the present state of society it is difficult to conceive how a man of taste can have endured to gaze upon a scene of human butchery. Yet we should remember that it is not so long since bear-baiting was prohibited in England, and we are only now attaining that stage of morality in respect of cruelty to animals that was reached in the 5th century, by the help of Christianity, in respect of cruelty to men. We shall not then be greatly surprised if hardly one of the Roman moralists is found to raise his voice against this amusement, except on the score of extravagance. Cicero in a well-known passage commends the gladiatorial games as the best discipline against the fear of death and suffering that can be presented to the eye. The younger Pliny, who perhaps of all Romans approaches nearest to our ideal of a cultured gentleman, speaks approvingly of them. Marcus Aurelius, though he did much to mitigate their horrors, yet in his writings condemns the monotony rather than the cruelty. Seneca is indeed a splendid exception, and his letter to Lentulus is an eloquent protest against this inhuman sport. But it is without a parallel till we come to the writings of the Christian fathers, Tertullian, Lactantius, Cyprian and Augustine. In the *Confessions* of the last there occurs a narrative which is worth quoting as a proof of the strange fascination which the games exercised even on a religious man and a Christian. He tells us how his friend Alpius was dragged against his will to the amphitheatre, how he strove to quiet his conscience by closing his eyes, how at some exciting crisis the shouts of the whole assembly aroused his curiosity, how he looked and was lost, grew drunk with the sight of blood, and returned again and again, knowing his guilt yet unable to abstain. The first Christian emperor was persuaded to issue an edict abolishing gladiatorial games (325), yet in 404 we read of an exhibition of gladiators to celebrate the triumph of Honorius over the Goths, and it is said that they were not totally extinct in the West till the time of Theodoric.

Gladiators formed admirable models for the sculptor. One of the finest pieces of ancient sculpture that has come down to us is the "Wounded Gladiator" of the National Museum at Naples. The so-called "Fighting Gladiator" of the Borghese collection, now in the Museum of the Louvre, and the "Dying Gladiator" of the Capitoline Museum, which inspired the famous stanza of *Childe Harold*, have been pronounced by modern antiquaries to represent, not gladiators, but warriors. In this connexion we may mention the admirable picture of Gérôme which bears the title, "Ave, Caesar, morituri te salutant."

The attention of archaeologists has been recently directed to the tesserae of gladiators. These tesserae, of which about sixty exist in various museums, are small oblong tablets of ivory or bone, with an inscription on each of the four sides. The first line contains a name in the nominative case, presumably that of the gladiator; the second line a name in the genitive, that of the *patronus* or *dominus*; the third line begins with the letters SP (for *spatiatus*—approved), which shows that the gladiator had passed his preliminary trials; this is followed by a day of a Roman month; and in the fourth line are the names of the consuls of a particular year.

AUTHORITIES.—All needful information on the subject will be found in L. Friedländer's *Darstellungen aus der Sitten- und Lebensgeschichte Roms*, (part ii., 6th ed., 1889), and in the section by him on "The Games" in Marquardt's *Römische Staatsverwaltung*, iii. (1885) p. 554; see also article by G. Lafaye in Daremberg and Saglio, *Dictionnaire des antiquités*. See also F. W. Ritschl, *Tesserae gladiatoriae* (1864) and P. J. Meier, *De gladiatorum Romanae quaestiones selectae* (1881). The articles by Lipsius on the *Saturnalia* and *amphitheatrum* in Graevius, *Thesaurus antiquitatum Romanarum*, ix., may still be consulted with advantage.

GLADIOLUS, a genus of monocotyledonous plants, belonging to the natural order Iridaceae. They are herbaceous plants growing from a solid fibrous-coated bulb (or corm), with long narrow plaited leaves and a terminal one-sided spike of generally bright-coloured irregular flowers. The segments of the limb of the perianth are very unequal, the perianth tube is curved, funnel-

shaped and widening upwards, the segments equalling or exceeding the tube in length. There are about 150 known species, a large number of which are South African, but the genus extends into tropical Africa, forming a characteristic feature of the mountain vegetation, and as far north as central Europe and western Asia. One species *G. illyricus* (sometimes regarded as a variety of *G. communis*) is found wild in England, in the New Forest and the Isle of Wight. Some of the species have been cultivated for a long period in English flower-gardens, where both the introduced species and the modern varieties bred from them are very ornamental and popular. *G. segetum* has been cultivated since 1596, and *G. byzantinus* since 1629, while many additional species were introduced during the latter half of the 18th century. One of the earlier of the hybrids originated in gardens was the beautiful *G. Colvillei*, raised in the nursery of Mr Colville of Chelsea in 1823 from *G. tristis* fertilized by *G. cardinalis*. In the first decade of the 19th century, however, the Hon. and Rev. W. Herbert had successfully crossed the showy *G. cardinalis* with the smaller but more free-flowering *G. blandus*, and the result was the production of a race of great beauty and fertility. Other crosses were made with *G. tristis*, *G. oppositiflorus*, *G. hirsutus*, *G. alatus* and *G. psittacinus*; but it was not till after the production of *G. gandavensis* that the gladiolus really became a general favourite in gardens. This fine hybrid was raised in 1837 by M. Bedinghaus, gardener to the duc d'Artemberg, at Enghien, crossing *G. psittacinus* and *G. cardinalis*. There can, however, be little doubt that before the *gandavensis* type had become fairly fixed the services of other species were brought into force, and the most likely of these were *G. oppositiflorus* (which shows in the white forms), *G. blandus* and *G. ramosus*. Other species may also have been used, but in any case the *gandavensis* gladiolus, as we now know it, is the result of much crossing and inter-crossing between the best forms as they developed (J. Weathers, *Practical Guide to Garden Plants*). Since that time innumerable varieties have appeared only to sink into oblivion upon being replaced by still finer productions.

The modern varieties of gladioli have almost completely driven the natural species out of gardens, except in botanical collections. The most gorgeous groups—in addition to the *gandavensis* type—are those known under the names of *Lemoinei*, *Childsi*, *nanctianus* and *branchleyensis*. The last-named was raised by a Mr Hooker at Branchley in 1848, and although quite distinct in appearance from *gandavensis*, it undoubtedly had that variety as one of its parents. Owing to the brilliant scarlet colour of the flowers, this is always a great favourite for planting in beds. The *Lemoinei* forms originated at Nancy, in France, by fertilizing *G. purpureo-auratus* with pollen from *G. gandavensis*; the first flower appearing in 1877, and the plants being put into commerce in 1880. The *Childsi* gladioli first appeared in 1882, having been raised at Baden-Baden by Herr Max Leichtlin from the best forms of *G. gandavensis* and *G. Saundersi*. The flowers of the best varieties are of great size and substance, often measuring 7 to 9 in. across, while the range of colour is marvellous, with shades of grey, purple, scarlet, salmon, crimson, rose, white, pink, yellow, &c., often beautifully mottled and blotched in the throat. The plants are vigorous in growth, often reaching a height of 4 to 5 ft. *G. nanctianus* was raised at Nancy by M.M. Lemoine and were first put into commerce in 1880. Next to the *Childsi* group they are the most beautiful, and have the blood of the best forms of *G. Saundersi* and *G. Lemoinei* in their veins. The plants are quite as hardy as the *gandavensis* hybrids, and the colours of the flowers are almost as brilliant and varied in hue as those of the *Childsi* section.

A deep and rather stiff sandy loam is the best soil for the gladiolus, and this should be trenched up in October and enriched with well-decomposed manure, consisting partly of cow dung, the manure being disposed altogether below the corms, a layer at the bottom of the upper trench, say 9 in. from the surface, and another layer at double that depth. The corms should be planted in succession at intervals of two or three weeks through the months of March, April and May; about 3 to 5 in. deep and at least 1 ft. apart, a little pure soil or sand being laid over each before the earth is closed in about them, an

arrangement which may be advantageously followed with bulbous plants generally. In hot summer weather they should have a good mulching of well-decayed manure, and, as soon as the flower spikes are produced, liquid manure may occasionally be given them with advantage.

The gladiolus is easily raised from seeds, which should be sown in March or April in pots of rich soil placed in slight heat, the pots being kept near the glass after they begin to grow, and the plants being gradually hardened to permit their being placed out-of-doors in a sheltered spot for the summer. Modern growers often grow the seeds in the open in April on a nicely prepared bed in drills about 6 in. apart and 4 in. deep, covering them with finely sifted gritty mould. The seed bed is then pressed down evenly and firmly, watered occasionally and kept free from weeds during the summer. In October they will have ripened off, and must be taken out of the soil, and stored in paper bags in a dry room secure from frost. They will have made little bulbs from the size of a hazel nut downwards, according to their vigour. In the spring they should be planted like the old bulbs, and the larger ones will flower during the season, while the smaller ones must be again harvested and planted out as before. The time occupied from the sowing of the seed until the plant attains its full strength is from three to four years. The approved sorts, which are identified by name, are multiplied by means of bulbets or offsets or "spawn," which form around the principal bulb or corm; but in this they vary greatly, some kinds furnishing abundant increase and soon becoming plentiful, while others persistently refuse to yield offsets. The stately habit and rich glowing colours of the modern gladioli render them exceedingly valuable as decorative plants during the late summer months. They are, moreover, very desirable and useful flowers for cutting for the purpose of room decoration, for while the blossoms themselves last fresh for some days if cut either early in the morning or late in the evening, the undeveloped buds open in succession, if the stalks are kept in water, so that a cut spike will go on blooming for some time.

GLADSHHEIM (Old Norse *Gladshheimr*), in Scandinavian mythology, the region of joy and home of Odin. Valhalla, the paradise whither the heroes who fell in battle were escorted, was situated there.

GLADSTONE, JOHN HALL (1827-1902), English chemist, was born at Hackney, London, on the 7th of March 1827. From childhood he showed great aptitude for science; geology was his favourite subject, but since this in his father's opinion did not afford a career of promise, he devoted himself to chemistry, which he studied under Thomas Graham at University College, London, and Liebig at Giessen, where he graduated as Ph.D. in 1847. In 1850 he became chemical lecturer at St. Thomas's hospital, and three years later was elected a fellow of the Royal Society at the unusually early age of twenty-six. From 1858 to 1861 he served on the royal commission on lighthouses, and from 1864 to 1868 was a member of the war office committee on gun-cotton. From 1874 to 1877 he was Fullerian professor of chemistry at the Royal Institution, in 1874 he was chosen first president of the Physical Society, and in 1877-1879 he was president of the Chemical Society. In 1897 the Royal Society recognized his fifty years of scientific work by awarding him the Davy medal. Dr Gladstone's researches were large in number and wide in range, dealing to a great extent with problems that lie on the border-line between physics and chemistry. Thus a number of his inquiries, and those not the least important, were partly chemical, partly optical. He determined the optical constants of hundreds of substances, with the object of discovering whether any of the elements possesses more than one atomic refraction. Again, he investigated the connexion between the optical behaviour, density and chemical composition of ethereal oils, and the relation between molecular magnetic rotation and the refraction and dispersion of nitrogenous compounds. So early as 1856 he showed the importance of the spectroscope in chemical research, and he was one of the first to notice that the Fraunhofer spectrum at sunrise and sunset differs from that at midday, his conclusion being that the earth's atmosphere must be responsible for many of its absorption lines, which indeed were subsequently traced to the oxygen and water-vapour in the air. Another portion of his work was of an electro-chemical character. His studies, with Alfred Tribe (1840-1885) and W. Hibbert, in the chemistry of the storage battery, have added largely to our knowledge, while the "copper-zinc couple," with which his name is associated together with that of Tribe, among other things, afforded a simple means of preparing certain

organo-metallic compounds, and thus promoted research in branches of organic chemistry where those bodies are especially useful. Mention may also be made of his work on phosphorus, on explosive substances, such as iodide of nitrogen, gun-cotton and the fulminates, on the influence of mass in the process of chemical reactions, and on the effect of carbonic acid on the germination of plants. Dr Gladstone always took a great interest in educational questions, and from 1873 to 1894 he was a member of the London School Board. He was also a member of the Christian Evidence Society, and an early supporter of the Young Men's Christian Association. His death occurred suddenly in London on the 6th of October 1902.

GLADSTONE, WILLIAM EWART (1809-1898), British statesman, was born on the 29th of December 1809 at No. 62 Rodney Street, Liverpool. His forefathers were Gledstones of Gledstones, in the upper ward of Lanarkshire; or in Scottish phrase, Gledstones of that Ilk. As years went on their estates dwindled, and by the beginning of the 17th century Gledstones was sold. The adjacent property of Arthursbiel remained in the hands of the family for nearly a hundred years longer. Then the son of the last Gledstones of Arthursbiel removed to Biggar, where he opened the business of a maltster. His grandson, Thomas Gladstone (for so the name was modified), became a corn-merchant at Leith. He happened to send his eldest son, John, to Liverpool to sell a cargo of grain there, and the energy and aptitude of the young man attracted the favourable notice of a leading corn-merchant of Liverpool, who recommended him to settle in that city. Beginning his commercial career as a clerk in his patron's house, John Gladstone lived to become one of the merchant-princes of Liverpool, a baronet and a member of parliament. He died in 1851 at the age of eighty-seven. Sir John Gladstone was a pure Scotsman, a Lowlander by birth and descent. He married Anne, daughter of Andrew Robertson of Stornoway, sometime provost of Dingwall. Provost Robertson belonged to the Clan Donachie, and by this marriage the robust and business-like qualities of the Lowlander were blended with the poetic imagination, the sensibility and fire of the Gael.

John and Anne Gladstone had six children. The fourth son, William Ewart, was named after a merchant of Liverpool who was his father's friend. He seems to have been a remarkably good child, and much beloved at home. *Childhood and education.* In 1818 or 1819 Mrs Gladstone, who belonged to the Evangelical school, said in a letter to a friend, that she believed her son William had been "truly converted to God." After some tuition at the vicarage of Seaforth, a watering-place near Liverpool, the boy went to Eton in 1821. His tutor was the Rev. Henry Hartopp Knapp. His brothers, Thomas and Robertson Gladstone, were already at Eton. Thomas was in the fifth form, and William, who was placed in the middle remove of the fourth form, became his eldest brother's fag. He worked hard at his classical lessons, and supplemented the ordinary business of the school by studying mathematics in the holidays. Mr Hawtrey, afterwards headmaster, commended a copy of his Latin verses, and "sent him up for good"; and this experience first led the young student to associate intellectual work with the ideas of ambition and success. He was not a fine scholar, in that restricted sense of the term which implies a special aptitude for turning English into Greek and Latin, or for original versification in the classical languages. "His composition," we read, "was stiff," but he was imbued with the substance of his authors; and a contemporary who was in the sixth form with him recorded that "when there were thrilling passages of Virgil or Homer, or difficult passages in the *Scriptores Græci*, to translate, he or Lord Arthur Hervey was generally called up to edify the class with quotation or translation." By common consent he was pre-eminently God-fearing, orderly and conscientious. "At Eton," said Bishop Hamilton of Salisbury, "I was a thoroughly idle boy, but I was saved from some worse things by getting to know Gladstone." His most intimate friend was Arthur Hallam, by universal acknowledgment the most remarkable Etonian of his day; but he was not

generally popular or even widely known. He was seen to the greatest advantage, and was most thoroughly at home, in the debates of the Eton Society, learnedly called "The Literati," and vulgarly "Pop," and in the editorship of the *Eton Miscellany*. He left Eton at Christmas 1827. He read for six months with private tutors, and in October 1828 went up to Christ Church, where, in the following year, he was nominated to a studentship.

At Oxford Gladstone read steadily, but not laboriously, till he neared his final schools. During the latter part of his undergraduate career he took a brief but brilliant share in the proceedings of the Union, of which he was successively secretary and president. He made his first speech on the 11th of February 1830. Brought up in the nurture and admonition of Canning, he defended Roman Catholic emancipation, and thought the duke of Wellington's government unworthy of national confidence. He opposed the removal of Jewish disabilities, arguing, we are told by a contemporary, "on the part of the Evangelicals," and pleaded for the gradual extinction, in preference to the immediate abolition, of slavery. But his great achievement was a speech against the Whig Reform Bill. One who heard this famous discourse says: "Most of the speakers rose, more or less, above their usual level, but when Mr Gladstone sat down we all of us felt that an epoch in our lives had occurred. It certainly was the finest speech of his that I ever heard." Bishop Charles Wordsworth said that his experience of Gladstone at this time "made me (and I doubt not others also) feel no less sure than of my own existence that Gladstone, our then Christ Church undergraduate, would one day rise to be prime minister of England." In December 1831 Gladstone crowned his career by taking a double first-class. Lord Halifax (1800-1885) used to say, with reference to the increase in the amount of reading requisite for the highest honours: "My double-first must have been a better thing than Peel's; Gladstone's must have been better than mine."

Now came the choice of a profession. Deeply anxious to make the best use of his life, Gladstone turned his thoughts to holy orders. But his father had determined to make him a politician. Quitting Oxford in the spring of 1832, Gladstone spent six months in Italy, learning the language and studying art. In the following September he was suddenly recalled to England, to undertake his first parliamentary campaign. The fifth duke of Newcastle was one of the chief potentates of the High Tory party. His frank claim to "do what he liked with his own" in the representation of Newark has given him a place in political history. But that claim had been rudely disputed by the return of a Radical lawyer at the election of 1831. The Duke was anxious to obtain a capable candidate to aid him in regaining his ascendancy over the rebellious borough. His son, Lord Lincoln, had heard Gladstone's speech against the Reform Bill delivered in the Oxford Union, and had written home that "a man had arisen in Israel." At his suggestion the duke invited Gladstone to stand for Newark in the Tory interest against Mr Serjeant Wilde, afterwards Lord Chancellor Truro. The last of the Unreformed parliaments was dissolved on the 3rd of December 1832. Gladstone, addressing the electors of Newark, said that he was bound by the opinions of no man and no party, but felt it a duty to watch and resist that growing desire for change which threatened to produce "along with partial good a melancholy preponderance of mischief." The first principle to which he looked for national salvation was, that the "duties of governors are strictly and peculiarly religious, and that legislatures, like individuals, are bound to carry throughout their acts the spirit of the high truths they have acknowledged." The condition of the poor demanded special attention; labour should receive adequate remuneration; and he thought favourably of the "allotment of cottage grounds." He regarded slavery as sanctioned by Holy Scripture, but the slaves ought to be educated and gradually emancipated. The contest resulted in his return at the head of the poll.

The first Reformed parliament met on the 29th of January 1833, and the young member for Newark took his seat for the first

time in an assembly which he was destined to adorn, delight and astonish for more than half a century. His maiden speech was delivered on the 3rd of June in reply to what was almost a personal challenge. The colonial secretary, Mr Stanley, afterwards Lord Derby, brought forward a series of resolutions in favour of the extinction of slavery in the British colonies. On the first night of the debate Lord Howick, afterwards Lord Grey, who had been under-secretary for the Colonies, and who opposed the resolutions as proceeding too gradually towards abolition, cited certain occurrences on Sir John Gladstone's plantation in Demerara to illustrate his contention that the system of slave-labour in the West Indies was attended by great mortality among the slaves. Gladstone in his reply—his first speech in the House—avowed that he had a pecuniary interest in the question, "and, if he might say so much without exciting suspicion, a still deeper interest in it as a question of justice, of humanity and of religion." If there had recently been a high mortality on his father's plantation, it was due to the age of the slaves rather than to any peculiar hardship in their lot. It was true that the particular system of cultivation practised in Demerara was more trying than some others; but then it might be said that no two trades were equally conducive to health. Steel-grinding was notoriously unhealthy, and manufacturing processes generally were less favourable to life than agricultural. While strongly condemning cruelty, he declared himself an advocate of emancipation, but held that it should be effected gradually, and after due preparation. The slaves must be religiously educated, and stimulated to profitable industry. The owners of emancipated slaves were entitled to receive compensation from parliament, because it was parliament that had established this description of property. "I do not," said Gladstone, "view property as an abstract thing; it is the creature of civil society. By the legislature it is granted, and by the legislature it is destroyed." On the following day King William IV. wrote to Lord Althorp: "The king rejoices that a young member has come forward in so promising a manner as Viscount Althorp states Mr W. E. Gladstone to have done." In the same session Gladstone spoke on the question of bribery and corruption at Liverpool, and on the temporalities of the Irish Church. In the session of 1834 his most important performance was a speech in opposition to Hume's proposal to throw the universities open to Dissenters.

On the 10th of November 1834 Lord Althorp succeeded to his father's peerage, and thereby vacated the leadership of the House of Commons. The prime minister, Lord Melbourne, submitted to the king a choice of names for the chancellorship of the exchequer and leadership of the House of Commons; but his majesty announced that, having lost the services of Lord Althorp as leader of the House of Commons, he could feel no confidence in the stability of Lord Melbourne's government, and that it was his intention to send for the duke of Wellington. The duke took temporary charge of affairs, but Peel was felt to be indispensable. He had gone abroad after the session, and was now in Rome. As soon as he could be brought back he formed an administration, and appointed Gladstone to a junior lordship of the treasury. Parliament was dissolved on the 29th of December. Gladstone was returned unopposed, this time in conjunction with the Liberal lawyer whom he had beaten at the last election. The new parliament met on the 19th of February 1835. The elections had given the Liberals a considerable majority. Immediately after the meeting of parliament Gladstone was promoted to the under-secretaryship for the colonies, where his official chief was Lord Aberdeen. The administration was not long-lived. On the 30th of March Lord John Russell moved a resolution in favour of an inquiry into the temporalities of the Irish Church, with the intention of applying the surplus to general education without distinction of religious creed. This was carried against ministers by a majority of thirty-three. On the 8th of April Sir Robert Peel resigned, and the under-secretary for the colonies of course followed his chief into private life.

Released from the labours of office, Gladstone, living in chambers in the Albany, practically divided his time between his parliamentary duties and study. Then, as always, his constant companions were Homer and Dante, and it is recorded that he read the whole of St Augustine, in twenty-two octavo volumes. He used to frequent the services at St James's, Piccadilly, and Margaret chapel, since better known as All Saints', Margaret Street. On the 20th of June 1837 King William IV. died, and Parliament, having been prorogued by the young queen in person, was dissolved on the 17th of the following month. Simply on the strength of his parliamentary reputation Gladstone was nominated, without his consent, for Manchester, and was placed at the bottom of the poll; but, having been at the same time nominated at Newark, was again returned. The year 1838 claims special note in a record of Gladstone's life, because it witnessed the appearance of his famous work on *The State in its Relations with the Church*. He had left Oxford just before the beginning of that Catholic revival which has transfigured both the inner spirit and the outward aspect of the Church of England. But the revival was now in full strength. *The Tracts for the Times* were saturating England with new influences. The movement counted no more enthusiastic or more valuable disciple than Gladstone. Its influence had reached him through his friendships, notably with two Fellows of Merton—Mr James Hope, who became Mr Hope-Scott of Abbotsford, and the Rev. H. E. Manning, afterwards cardinal archbishop. *The State in its Relations with the Church* was his practical contribution to a controversy in which his deepest convictions were involved. He contended that the Church, as established by law, was to be "maintained for its truth," and that this principle, if good for England, was good also for Ireland.

On the 25th of July 1839 Gladstone was married at Hawarden to Miss Catherine Glynné, sister, and in her issue heir, of Sir Stephen Glynné, ninth and last baronet of that name. In 1840 he published *Church Principles considered in their Results*.

Parliament was dissolved in June 1841. Gladstone was again returned for Newark. The general election resulted in a Tory majority of eighty. Sir Robert Peel became prime minister, and made the member for Newark vice-president of the Board of Trade. An inevitable change is from this time to be traced in the topics of Gladstone's parliamentary speaking. Instead of discoursing on the corporate conscience of the state and the endowments of the Church, the importance of Christian education, and the theological unfitness of the Jews to sit in parliament, he is solving business-like problems about foreign tariffs and the exportation of machinery; waxing eloquent over the regulation of railways, and a graduated tax on corn; subtle on the monetary merits of half-farthings, and great in the mysterious lore of *quassia* and *cocculus indicus*. In 1842 he had a principal hand in the preparation of the revised tariff, by which duties were abolished or sensibly diminished in the case of 1200 duty-paying articles. In defending the new scheme he spoke incessantly, and amazed the House by his mastery of detail, his intimate acquaintance with the commercial needs of the country, and his inexhaustible power of exposition. In 1843 Gladstone, succeeding Lord Ripon as president of the Board of Trade, became a member of the cabinet at the age of thirty-three. He has recorded the fact that "the very first opinion which he ever was called upon to give in cabinet" was an opinion in favour of withdrawing the bill providing education for children in factories, to which vehement opposition was offered by the Dissenters, on the ground that it was too favourable to the Established Church.

At the opening of the session of 1845 the government, in pursuance of a promise made to Irish members that they would deal with the question of academical education in Ireland, proposed to establish non-sectarian colleges in that country and to make a large addition to the grant to the Roman Catholic College of Maynooth. Gladstone resigned office, in order, as he announced in the debate on the address, to form "not only an honest, but likewise an

independent and an unsuspected judgment," on the plan to be submitted by the government with respect to Maynooth. His subsequent defence of the proposed grant, on the ground that it would be improper and unjust to exclude the Roman Catholic Church in Ireland from a "more indiscriminating support" which the state might give to various religious beliefs, was regarded by men of less sensitive conscience as only proving that there had been no adequate cause for his resignation. Before he resigned he completed a second revised tariff, carrying considerably further the principles on which he had acted in the earlier revision of 1842.

In the autumn of 1845 the failure of the potato crop in Ireland threatened a famine, and convinced Sir Robert Peel that all restrictions on the importation of food must be at once suspended. He was supported by only three members of the cabinet, and resigned on the 5th of December. Lord John Russell, who had just announced his conversion to total and immediate repeal of the Corn Laws, declined the task of forming an administration, and on the 20th of December Sir Robert Peel resumed office. Lord Stanley refused to re-enter the government, and his place as secretary of state for the colonies was offered to and accepted by Gladstone. He did not offer himself for re-election at Newark, and remained outside the House of Commons during the great struggle of the coming year. It was a curious irony of fate which excluded him from parliament at this crisis, for it seems unquestionable that he was the most advanced Free Trader in Sir Robert Peel's Cabinet. The Corn Bill passed the House of Lords on the 28th of June 1846, and on the same day the government were beaten in the House of Commons on an Irish Coercion Bill. Lord John Russell became prime minister, and Gladstone retired for a season into private life. Early in 1847 it was announced that one of the two members for the university of Oxford intended to retire at the general election, and Gladstone was proposed for the vacant seat. The representation of the university had been pronounced by Canning to be the most coveted prize of public life, and Gladstone himself confessed that he "desired it with an almost passionate fondness." Parliament was dissolved on the 23rd of July 1847. The nomination at Oxford took place on the 29th of July, and at the close of the poll Sir Robert Inglis stood at the head, with Gladstone as his colleague.

The three years 1847, 1848, 1849 were for Gladstone a period of mental growth, of transition, of development. A change was silently proceeding, which was not completed for twenty years. "There have been," he wrote in later days to Bishop Wilberforce, "two great deaths, or transmigrations of spirit, in my political existence—one, very slow, the breaking of ties with my original party." This was now in progress. In the winter of 1850-1851 Gladstone spent between three and four months at Naples, where he learned that more than half the chamber of deputies, who had followed the party of Opposition, had been banished or imprisoned; that a large number, probably not less than 20,000, of the citizens had been imprisoned on charges of political disaffection, and that in prison they were subjected to the grossest cruelties. Having made careful investigations, Gladstone, on the 7th of April 1851, addressed an open letter to Lord Aberdeen, bringing an elaborate, detailed and horrible indictment against the rulers of Naples, especially as regards the arrangements of their prisons and the treatment of persons confined in them for political offences. The publication of this letter caused a wide sensation in England and abroad, and profoundly agitated the court of Naples. In reply to a question in the House of Commons, Lord Palmerston accepted and adopted Gladstone's statement, expressed keen sympathy with the cause which he had espoused, and sent a copy of his letter to the queen's representative at every court of Europe. A second letter and a third followed, and their effect, though for a while retarded, was unmistakably felt in the subsequent revolution which created a free and united Italy.

In February 1852 the Whig government was defeated on a Militia Bill, and Lord John Russell was succeeded by Lord Derby, formerly Lord Stanley, with Mr Disraeli, who now

Literary work.

Free trade.

Enters the cabinet.

Naples prisons.

Maynooth grant withdrawn.

entered office for the first time, as chancellor of the exchequer and leader of the House of Commons. Mr Disraeli introduced and carried a makeshift budget, and the government tided over the session, and dissolved parliament on the 1st of July 1852. There was some talk of inducing Gladstone to join the Tory government, and on the 29th of November Lord Malmesbury dubiously remarked, "I cannot make out Gladstone, who seems to me a dark horse." In the following month the chancellor of the exchequer produced his second budget. The government redeemed their pledge to do something for the relief of the agricultural interest by reducing the duty on malt. This created a deficit, which they repaired by doubling the duty on inhabited houses. The voices of criticism were heard simultaneously on every side. The debate waxed fast and furious. In defending his proposals Mr Disraeli gave full scope to his most characteristic gifts; he pelted his opponents right and left with sarcasms, taunts and epigrams. Gladstone delivered an unpremeditated reply, which has ever since been celebrated. Tradition says that he "foamed at the mouth." The speech of the chancellor of the exchequer, he said, must be answered "on the moment." It must be "tried by the laws of decency and propriety." He indignantly rebuked his rival's language and demeanour. He tore his financial scheme to ribbons. It was the beginning of a duel which lasted till death removed one of the combatants from the political arena. "Those who had thought it impossible that any impression could be made upon the House after the speech of Mr Disraeli had to acknowledge that a yet greater impression was produced by the unprepared reply of Mr Gladstone." The House divided, and the government were left in a minority of nineteen. Lord Derby resigned.

The new government was a coalition of Whigs and Peelites. Lord Aberdeen became prime minister, and Gladstone chancellor of the exchequer. Having been returned again for the university of Oxford, he entered on the active duties of a great office for which he was pre-eminently fitted by an unique combination of financial, administrative and rhetorical gifts. His first budget was introduced on the 18th of April 1853. It tended to make life easier and cheaper for large and numerous classes; it promised wholesale remissions of taxation; it lessened the charges on common processes of business, on locomotion, on postal communication, and on several articles of general consumption. The deficiency thus created was to be met by a "succession-duty," or application of the legacy-duty to real property; by an increase of the duty on spirits; and by the extension of the income-tax, at 5d. in the pound, to all incomes between £100 and £150. The speech in which these proposals were introduced held the House spell-bound. Here was an orator who could apply all the resources of a burnished rhetoric to the elucidation of figures; who could sweep the widest horizon of the financial future, and yet stoop to bestow the minutest attention on the microcosm of penny stamps and post-horses. Above all, the chancellor's mode of handling the income-tax attracted interest and admiration. It was a searching analysis of the financial and moral grounds on which the impost rested, and a historical justification and eulogy of it. Yet, great as had been the services of the tax at a time of national danger, Gladstone could not consent to retain it as a part of the permanent and ordinary finances of the country. It was objectionable on account of its unequal incidence, of the harassing investigation into private affairs which it entailed, and of the frauds to which it inevitably led. Therefore, having served its turn, it was to be extinguished in 1860. The scheme astonished, interested and attracted the country. The queen and Prince Albert wrote to congratulate the chancellor of the exchequer: Public authorities and private friends joined in the chorus of eulogy. The budget demonstrated at once its author's absolute mastery over figures and the persuasive force of his expository gift. It established the chancellor of the exchequer as the paramount financier of his day, and it was only the first of a long series of similar performances, different, of course, in detail, but alike in their bold outlines and brilliant

handling. Looking back on a long life of strenuous exertion, Gladstone declared that the work of preparing his proposals about the succession-duty and carrying them through Parliament was by far the most laborious task which he ever performed.

War between Great Britain and Russia was declared on the 27th of March 1854, and it thus fell to the lot of the most pacific of ministers, the devotee of retrenchment, and the anxious cultivator of all industrial arts, to prepare a war budget, and to meet as well as he might the exigencies of a conflict which had so cruelly dislocated all the ingenious devices of financial optimism. No amount of skill in the manipulation of figures, no ingenuity in shifting fiscal burdens, could prevent the addition of forty-one millions to the national debt, or could countervail the appalling mismanagement at the seat of war. Gladstone declared that the state of the army in the Crimea was a "matter for weeping all day and praying all night." As soon as parliament met in January 1855 J. A. Roebuck, the Radical member for Sheffield, gave notice that he would move for a select committee "to inquire into the condition of our army before Sevastopol, and into the conduct of those departments of the government whose duty it has been to minister to the wants of that army." On the same day Lord John Russell, without announcing his intention to his colleagues, resigned his office as president of the council sooner than attempt the defence of the government. Gladstone, in defending the government against Roebuck, rebuked in dignified and significant terms the conduct of men who, "hoping to escape from punishment, ran away from duty." On the division on Mr Roebuck's motion the government was beaten by the unexpected majority of 157.

Lord Palmerston became prime minister. The Peelites joined him, and Gladstone resumed office as chancellor of the exchequer. A shrewd observer at the time pronounced him indispensable. "Any other chancellor of the exchequer would be torn in bits by him." The government was formed on the understanding that Mr Roebuck's proposed committee was to be resisted. Lord Palmerston soon saw that further resistance was useless; his Peelite colleagues stuck to their text, and, within three weeks after resuming office, Gladstone, Sir James Graham and Mr Sidney Herbert resigned. Gladstone once said of himself and his Peelite colleagues, during the period of political isolation, that they were like roving icebergs on which men could not land with safety, but with which ships might come into perilous collision. He now applied himself specially to financial criticism, and was perpetually in conflict with the chancellor of the exchequer, Sir George Cornewall Lewis.

In 1858 Lord Palmerston was succeeded by Lord Derby at the head of a Conservative administration, and Gladstone accepted the temporary office of high commissioner extraordinary to the Ionian Islands. Returning to England for the session of 1859, he found himself involved in the controversy which arose over a mild Reform Bill introduced by the government. They were defeated on the second reading of the bill, Gladstone voting with them. A dissolution immediately followed, and Gladstone was again returned unopposed for the university of Oxford. As soon as the new parliament met a vote of want of confidence in the ministry was moved in the House of Commons. In the critical division which ensued Gladstone voted with the government, who were left in a minority. Lord Derby resigned. Lord Palmerston became prime minister, and asked Gladstone to join him as chancellor of the exchequer. To vote confidence in an imperilled ministry, and on its defeat to take office with the rivals who have defeated it, is a manoeuvre which invites the reproach of tergiversation. But Gladstone risked the reproach, accepted the office and had a sharp tussle for his seat. He emerged from the struggle victorious, and entered on his duties with characteristic zeal. The prince consort wrote: "Gladstone is now the real leader in the House of Commons, and works with an energy and vigour altogether incredible."

The budget of 1860 was marked by two distinctive features. It asked the sanction of parliament for the commercial treaty which Cobden had privately arranged with the emperor Napoleon, and it proposed to abolish the duty on paper. The French treaty

was carried, but the abolition of the paper-duty was defeated in the House of Lords. Gladstone justly regarded the refusal to remit a duty as being in effect an act of taxation, and therefore as an infringement of the rights of the House of Commons. The proposal to abolish the paper-duty was revived in the budget of 1861, the chief proposals of which, instead of being divided, as in previous years, into several bills, were included in one. By this device the Lords were obliged to acquiesce in the repeal of the paper-duty.

During Lord Palmerston's last administration, which lasted from 1859 to 1865, Gladstone was by far the most brilliant and most conspicuous figure in the cabinet. Except in finance, he was not able to accomplish much, for he was met and thwarted at every turn by his chief's invincible hostility to change; but the more advanced section of the Liberal party began to look upon him as their predestined leader. In 1864, in a debate on a private member's bill for extending the suffrage, he declared that the burden of proof lay on those "who would exclude forty-nine fiftieths of the working-classes from the franchise." In 1865, in a debate on the condition of the Irish Church Establishment, he declared that the Irish Church, as it then stood, was in a false position, inasmuch as it ministered only to one-eighth or one-ninth of the whole community. But just in proportion as Gladstone advanced in favour with the Radical party he lost the confidence of his own constituents. Parliament was dissolved in July 1865, and the university elected Mr Gathorne Hardy in his place.

Gladstone at once turned his steps towards South Lancashire, where he was returned with two Tories above him. The result of the general election was to retain Lord Palmerston's government in power, but on the 18th of October the old prime minister died. He was succeeded by Lord Russell, and Gladstone, retaining the chancellorship

Leader of House of Commons.

of the exchequer, became for the first time leader of the House of Commons. Lord Russell, backed by Gladstone, persuaded his colleagues to consent to a moderate Reform Bill, and the task of piloting this measure through the House of Commons fell to Gladstone. The speech in which he wound up the debate on the second reading was one of the finest, if not indeed the very finest, which he ever delivered. But it was of no practical avail: The government were defeated on an amendment in committee, and thereupon resigned. Lord Derby became prime minister, with Disraeli as chancellor of the exchequer and leader of the House of Commons. On the 18th of March 1867 the Tory Reform Bill, which ended in establishing Household Suffrage in the boroughs, was introduced, and was read a second time without a division. After undergoing extensive alterations in committee at the hands of the Liberals and Radicals, the bill became law in August.

At Christmas 1867 Lord Russell announced his final retirement from active politics, and Gladstone was recognized by acclamation as leader of the Liberal party. Nominally he was in Opposition; but his party formed the majority of the House of Commons, and could beat the government whenever they chose to mass their forces.

Leader of Liberal party.

Gladstone seized the opportunity to give effect to convictions which had long been forming in his mind. Early in the session he brought in a bill abolishing compulsory church-rates, and this passed into law. On the 16th of March, in a debate raised by an Irish member, he declared that in his judgment the Irish Church, as a State Church, must cease to exist. Immediately afterwards he embodied this opinion in a series of resolutions concerning the Irish Church Establishment, and carried them against the government. Encouraged by this triumph, he brought in a Bill to prevent any fresh appointments in the Irish Church, and this also passed the Commons, though it was defeated in the Lords. Parliament was dissolved on the 11th of November. A single issue was placed before the country—Was the Irish Church to be, or not to be, disestablished? The response was an overwhelming affirmative. Gladstone, who had been doubly nominated, was defeated in Lancashire, but was returned for Greenwich. He chose this moment for publishing

a *Chapter of Autobiography*, in which he explained and justified his change of opinion with regard to the Irish Church.

On the 2nd of December Disraeli, who had succeeded Lord Derby as premier in the preceding February, announced that he and his colleagues, recognizing their defeat, had resigned without waiting for a formal vote of the new parliament. On the following day Gladstone was summoned to Windsor, and commanded by the queen to form an administration. The great task to which the new prime minister immediately addressed himself was the disestablishment of the Irish Church.

Prime Minister: Irish Church disestablishment.

The queen wrote to Archbishop Tait that the subject of the Irish Church "made her very anxious," but that Mr Gladstone "showed the most conciliatory disposition." "The government can do nothing that would tend to raise a suspicion of their sincerity in proposing to disestablish the Irish Church, and to withdraw all state endowments from all religious communions in Ireland; but, were these conditions accepted, all other matters connected with the question might, the queen thinks, become the subject of discussion and negotiation." The bill was drawn and piloted on the lines thus indicated, and became law on the 26th of July. In the session of 1870 Gladstone's principal work was the Irish Land Act, of which the object was to protect the tenant against eviction as long as he paid his rent, and to secure to him the value of any improvements which his own industry had made. In the following session Religious Tests in the universities were abolished, and a bill to establish secret voting was carried through the House of Commons. This was thrown out by the Lords, but became law a year later. The House of Lords threw out a bill to abolish the purchase of commissions in the army. Gladstone found that purchase existed only by royal sanction, and advised the queen to issue a royal warrant cancelling, on and after the 1st of November following, all regulations authorizing the purchase of commissions.

In 1873 Gladstone set his hand to the third of three great Irish reforms to which he had pledged himself. His scheme for the establishment of a university which should satisfy both Roman Catholics and Protestants met with general disapproval. The bill was thrown out by three votes, and Gladstone resigned. The queen sent for Disraeli, who declined to take office in a minority of the House of Commons, so Gladstone was compelled to resume. But he and his colleagues were now, in Disraelitish phrase, "exhausted volcanoes." Election after election went wrong. The government had lost favour with the public, and was divided against itself. There were resignations and rumours of resignations. When the session of 1875 had come to an end Gladstone took the chancellorship of the exchequer, and, as high authorities contended, vacated his seat by doing so. The point was obviously one of vital importance; and we learn from Lord Selborne, who was lord chancellor at the time, that Gladstone "was sensible of the difficulty of either taking his seat in the usual manner at the opening of the session, or letting . . . the necessary arrangements for business in the House of Commons be made in the prime minister's absence. A dissolution was the only escape." On the 23rd of January 1874 Gladstone announced the dissolution in an address to his constituents, *Dissolution of 1874.* now "sunk below the point necessary for the due defence and prosecution of the public interest." He promised that, if he were returned to power, he would repeal the income-tax. This bid for popularity failed, the general election resulting in a Tory majority of forty-six. Gladstone kept his seat for Greenwich, but was only second on the poll. Following the example of Disraeli in 1868, he resigned without meeting parliament.

For some years he had alluded to his impending retirement from public life, saying that he was "strong against going on in politics to the end." He was now sixty-four, and his life had been a continuous experience of exhausting labour. On the 12th of March 1874 he informed Lord Granville that he could give only occasional attendance in the House of Commons during the current session, and that he must "reserve his entire freedom to divest himself of all the

Temporary retirement.

responsibilities of leadership at no distant date." His most important intervention in the debates of 1874 was when he opposed Archbishop Tait's Public Worship Bill. This was read a second time without a division, but in committee Gladstone enjoyed some signal triumphs over his late solicitor-general, Sir William Harcourt, who had warmly espoused the cause of the government and the bill. At the beginning of 1875 Gladstone carried into effect the resolution which he had announced a year before, and formally resigned the leadership of the Liberal party. He was succeeded by Lord Hartington, afterwards duke of Devonshire. The learned leisure which Gladstone had promised himself when released from official responsibility was not of long duration. In the autumn of 1875 an insurrection broke out in Bulgaria, and the suppression of it by the Turks was marked by massacres and outrages. Public indignation was aroused by what were known as the "Bulgarian atrocities," and Gladstone flung himself into the agitation against Turkey with characteristic zeal. At public meetings, in the press, and in parliament he denounced the Turkish government and its champion, Disraeli, who had now become Lord Beaconsfield. Lord Hartington soon found himself pushed aside from his position of titular leadership. For four years, from 1876 to 1880, Gladstone maintained the strife with a courage, a persistence and a versatility which raised the enthusiasm of his followers to the highest pitch. The county of Edinburgh, or Midlothian,

Midlothian campaign.

which he contested against the dominant influence of the duke of Buccleuch, was the scene of the most astonishing exertions. As the general election approached the only question submitted to the electors was—Do you approve or condemn Lord Beaconsfield's foreign policy? The answer was given at Easter 1880, when the Liberals were returned by an overwhelming majority over Tories and Home Rulers combined. Gladstone was now member for Midlothian, having retired from Greenwich at the dissolution.

When Lord Beaconsfield resigned, the queen sent for Lord Hartington, the titular leader of the Liberals, but he and Lord Granville assured her that no other chief than Gladstone would satisfy the party. Accordingly, on the 23rd of April he became prime minister for the second time. His second administration, of which the main achievement was the extension of the suffrage to the agricultural labourers, was harassed by two controversies, relating to Ireland and Egypt, which proved disastrous to the Liberal party. Gladstone alienated considerable masses of English opinion by his efforts to reform the tenure of Irish land, and provoked the Irish people by his attempts to establish social order and to repress crime. A bill to provide compensation for tenants who had been evicted by Irish landlords passed the Commons, but was shipwrecked in the Lords, and a ghastly record of outrage and murder stained the following winter. A Coercion Bill and a Land Bill passed in 1881 proved unsuccessful. On the 6th of May 1882 the newly appointed chief secretary for Ireland, Lord Frederick Cavendish, and his under-secretary, Mr Burke, were stabbed to death in the Phoenix Park at Dublin. A new Crimes Act, courageously administered by Lord Spencer and Sir George Trevelyan, abolished exceptional crime in Ireland, but completed the breach between the British government and the Irish party in parliament.

The bombardment of the forts at Alexandria and the occupation of Egypt in 1882 were viewed with great disfavour by the bulk of the Liberal party, and were but little congenial to Gladstone himself. The circumstances of General Gordon's untimely death awoke an outburst of indignation against those who were, or seemed to be, responsible for it. Frequent votes of censure were proposed by the Opposition, and on the 8th of June 1885 the government were beaten on the budget. Gladstone resigned. The queen offered him the dignity of an earldom, which he declined. He was succeeded by Lord Salisbury.

The general election took place in the following November. When it was over the Liberal party was just short of the numerical strength which was requisite to defeat the combination of Tories and Parnellites. A startling surprise was at hand. Gladstone had for some time been convinced of the expediency of conceding

Home Rule to Ireland in the event of the Irish constituencies giving unequivocal proof that they desired it. His intentions were made known only to a privileged few, and these, curiously, were not his colleagues. The general election of 1885 showed that Ireland, outside Ulster, was practically unanimous for Home Rule. On the 17th of December an anonymous paragraph was published, stating that if Mr Gladstone returned to office he was prepared to "deal in a liberal spirit with the demand for Home Rule." It was clear that if Gladstone meant what he appeared to mean, the Parnellites would support him, and the Tories must leave office. The government seemed to accept the situation. When parliament met they executed, for form's sake, some confused manoeuvres, and then they were beaten on an amendment to the address in favour of Municipal Allotments. On the 1st of February 1886 Gladstone became, for the third time, prime minister. Several of his former colleagues declined to join him, on the ground of their absolute hostility to the policy of Home Rule; others joined on the express understanding that they were only pledged to consider the policy, and did not fetter their further liberty of action. On the 8th of April Gladstone brought in his bill for establishing Home Rule, and eight days later the bill for buying out the Irish landlords. Meanwhile two members of his cabinet, feeling themselves unable to support these measures, resigned. Hostility to the bills grew apace. Gladstone was implored to withdraw them, or substitute a resolution in favour of Irish autonomy; but he resolved to press at least the Home Rule Bill to a second reading. In the early morning of the 8th of June the bill was thrown out by thirty. Gladstone immediately advised the queen to dissolve parliament. Her Majesty strongly demurred to a second general election within seven months; but Gladstone persisted, and she yielded. Parliament was dissolved on the 26th of June. In spite of Gladstone's skilful appeal to the constituencies to sanction the principle of Home Rule, as distinct from the practical provisions of his late bill, the general election resulted in a majority of considerably over 100 against his policy, and Lord Salisbury resumed office. Throughout the existence of the new parliament Gladstone never relaxed his extraordinary efforts, though now nearer eighty than seventy, on behalf of the cause of self-government for Ireland. The fertility of argumentative resource, the copiousness of rhetoric, and the physical energy which he threw into the enterprise, would have been remarkable at any stage of his public life; continued into his eighty-fifth year they were little less than miraculous. Two incidents of domestic interest, one happy and the other sad, belong to that period of political storm and stress. On the 25th of July 1889 Gladstone celebrated the fiftieth anniversary of his marriage, and on the 4th of July 1891 his eldest son, William Henry, a man of fine character and accomplishments, died, after a lingering illness, in his fifty-second year.

The crowning struggle of Gladstone's political career was now approaching its climax. Parliament was dissolved on the 28th of June 1892. The general election resulted in a majority of forty for Home Rule, heterogeneously composed of Liberals, Labour members and Irish. As soon as the new parliament met a vote of want of confidence in Lord Salisbury's government was moved and carried. Lord Salisbury resigned, and on the 15th of August 1892 Gladstone kissed hands as first lord of the treasury. He was the first English statesman that had been four times prime minister. Parliament reassembled in January 1893. Gladstone brought in his new Home Rule Bill on the 13th of February. It passed the House of Commons, but was thrown out by the House of Lords on the second reading on the 8th of September 1893. Gladstone's political work was now, in his own judgment, ended. He made his last speech in the House of Commons on the 1st of March 1894, acquiescing in some amendments introduced by the Lords into the Parish Councils Bill; and on the 3rd of March he placed his resignation in the queen's hands. He never set foot again in the House of Commons, though he remained a member of it till the dissolution of 1895. He paid

First Home Rule Bill.

Second Home Rule Bill.

occasional visits to friends in London, Scotland and the south of France; but the remainder of his life was spent for the most part at Hawarden. He occupied his leisure by writing a rhymed translation of the *Odes* of Horace, and preparing an elaborately annotated edition of Butler's *Analogy* and *Sermons*. He had also contemplated some addition to the Homeric studies which he had always loved, but this design was never carried into effect, for he was summoned once again from his quiet life of study and devotion to the field of public controversy. The Armenian massacres in 1894 and 1895 revived all his ancient hostility to "the governing Turk." He denounced the massacres and their perpetrators at public meetings held at Chester on the 6th of August 1895, and at Liverpool on the 24th of September 1896. In March 1897 he recapitulated the hideous history in an open letter to the duke of Westminster.

But the end, though not yet apprehended, was at hand. Since his retirement from office Gladstone's physical vigour, up to that time unequalled, had shown signs of impairment. Towards the end of the summer of 1897 he began to suffer from an acute pain, which was attributed to facial neuralgia, and in November he went to Cannes. In February 1898 he returned to England and went to Bournemouth. There he was informed that the pain had its origin in a disease which must soon prove fatal. He received the information with simple thankfulness, and only asked that he might die at home. On the 22nd of

Death. March he returned to Hawarden, and there he died on the 19th of May 1898. During the night of the 25th of May his body was conveyed from Hawarden to London and the coffin was placed on a bier in Westminster Hall. Throughout the 26th and 27th a vast train of people, officially estimated at 250,000, and drawn from every rank and class, moved in unbroken procession past the bier. On the 28th of May the coffin, preceded by the two Houses of Parliament and escorted by the chief magnates of the realm, was carried from Westminster Hall to Westminster Abbey. The heir-apparent and his son, the prime minister and the leader of the House of Commons, were among those who bore the pall. The body was buried in the north transept of the abbey, where, on the 19th of June 1900, Mrs Gladstone's body was laid beside it.

Mr and Mrs Gladstone had four sons and four daughters, of whom one died in infancy. The eldest son, W. H. Gladstone **Family.** (1840-1891), was a member of parliament for many years, and married the daughter of Lord Blantyre, his son William (b. 1885) inheriting the family estates. The fourth son, Herbert John (b. 1854), sat in parliament for Leeds from 1880 to 1910, and filled various offices, being home secretary 1905-1910; in 1910 he was created Viscount Gladstone, on being appointed governor-general of united South Africa. The eldest daughter, Agnes, married the Rev. E. C. Wickham, headmaster of Wellington, 1873-1893, and later Dean of Lincoln. Another daughter married the Rev. Harry Drew, rector of Hawarden. The youngest, Helen, was for some years vice-principal of Newnham College, Cambridge.

After a careful survey of Mr Gladstone's life, enlightened by personal observation, it is inevitable to attempt some analysis of his character. First among his moral attributes must be placed his religiousness. From those early days when a fond mother wrote of him as having been "truly converted to God," down to the verge of ninety years, he lived in the habitual contemplation of the unseen world, and regulated his private and public action by reference to a code higher than that of mere prudence or worldly wisdom. A second characteristic, scarcely less prominent than the first, was his love of power. His ambition had nothing in common with the vulgar eagerness for place and pay and social standing. Rather it was a resolute determination to possess that control over the machine of state which should enable him to fulfil without let or hindrance the political mission with which he believed that Providence had charged him. The love of power was supported by a splendid fearlessness. No dangers were too threatening for him to face, no obstacles too formidable, no tasks too laborious, no heights too steep. The love of power and the supporting

courage were allied with a marked imperiousness. Of this quality there was no trace in his manner, which was courteous, conciliatory and even deferential; nor in his speech, which breathed an almost exaggerated humility. But the imperiousness showed itself in the more effectual form of action; in his sudden resolves, his invincible insistence, his recklessness of consequences to himself and his friends, his habitual assumption that the civilized world and all its units must agree with him, his indignant astonishment at the bare thought of dissent or resistance, his incapacity to believe that an overruling Providence would permit him to be frustrated or defeated. He had by nature what he himself called a "vulnerable temper and impetuous moods." But so absolute was his lifelong self-mastery that he was hardly ever betrayed into saying that which, on cooler reflection, needed to be recalled. It was easy enough to see the "vulnerable temper" as it worked within, but it was never suffered to find audible expression. It may seem paradoxical, but it is true, to say that Mr Gladstone was by nature conservative. His natural bias was to respect things as they were. In his eyes, institutions, customs, systems, so long as they had not become actively mischievous, were good because they were old. It is true that he was sometimes forced by conviction or fate or political necessity to be a revolutionist on a large scale; to destroy an established Church; to add two millions of voters to the electorate; to attack the parliamentary union of the kingdoms. But these changes were, in their inception, distasteful to their author. His whole life was spent in unlearning the prejudices in which he was educated. His love of freedom steadily developed, and he applied its principles more and more courageously to the problems of government. But it makes some difference to the future of a democratic state whether its leading men are eagerly on the look-out for something to revolutionize, or approach a constitutional change by the gradual processes of conviction and conversion.

Great as were his eloquence, his knowledge and his financial skill, Gladstone was accustomed to say of himself that the only quality in which, so far as he knew, he was distinguished from his fellow-men was his faculty of concentration. Whatever were the matter in hand, he so concentrated himself on it, and absorbed himself in it, that nothing else seemed to exist for him.

A word must be said about physical characteristics. In his prime Gladstone was just six feet high, but his inches diminished as his years increased, and in old age the unusual size of his head and breadth of his shoulders gave him a slightly top-heavy appearance. His features were strongly marked; the nose trenchant and hawk-like, and the mouth severely lined. His flashing eyes were deep-set, and in colour resembled the onyx with its double band of brown and grey. His complexion was of an extreme pallor, and, combined with his jet-black hair, gave in earlier life something of an Italian aspect to his face. His dark eyebrows were singularly flexible, and they perpetually expanded and contracted in harmony with what he was saying. He held himself remarkably upright, and even from his school-days at Eton had been remarked for the rapid pace at which he habitually walked. His voice was a baritone, singularly clear and far-reaching. In the Waverley Market at Edinburgh, which is said to hold 20,000 people, he could be heard without difficulty; and as late as 1895 he said to the present writer: "What difference does it make to me whether I speak to 400 or 4000 people?" His physical vigour in old age earned him the popular nickname of the Grand Old Man.

Lord Morley of Blackburn's *Life of Gladstone* was published in 1903. (G. W. E. R.)

GLADSTONE, a seaport of Clinton county, Queensland, Australia, 328 m. by rail N.E. of Brisbane. Pop. (1901) 1566. It possesses a fine, well-sheltered harbour reputed one of the best in Queensland, at the mouth of the river Boyne. Gold, manganese, copper and coal are found in the neighbourhood. Gladstone, founded in 1847, became a municipality in 1863.

See J. F. Hogan, *The Gladstone Colony* (London, 1898).
GLAGOLITIC, an early Slavonic alphabet: also the liturgy written therein, and the people (Dalmatians and Roman Catholic

Montenegrim) among whom it has survived by special licence of the Pope (see SLAVS for table of letters).

GLAIR (from Fr. *glair*, probably from Lat. *clarus*, clear, bright), the white of an egg, and hence a term used for a preparation made of this and used, in bookbinding and in gilding, to retain the gold and as a varnish. The adjective "glairy" is used of substances having the viscous and transparent consistency of the white of an egg.

GLAISHER, JAMES (1809-1903), English meteorologist and aeronaut, was born in London on the 7th of April 1809. After serving for a few years on the Ordnance Survey of Ireland, he acted as an assistant at the Cambridge and Greenwich observatories successively, and when the department of meteorology and magnetism was formed at the latter, he was entrusted with its superintendence, which he continued to exercise for thirty-four years, until his retirement from the public service. In 1845 he published his well-known dew-point tables, which have gone through many editions. In 1850 he established the Meteorological Society, acting as its secretary for many years, and in 1866 he assisted in the foundation of the Aeronautical Society of Great Britain. He was appointed a member of the royal commission on the warming and ventilation of dwellings in 1875, and for twelve years from 1880 acted as chairman of the executive committee of the Palestine Exploration Fund. But his name is best known in connexion with the series of balloon ascents which he made between 1862 and 1866, mostly in company with Henry Tracey Corwell. Many of these ascents were arranged by a committee of the British Association, of which he was a member, and were strictly scientific in character, the object being to carry out observations on the temperature, humidity, &c., of the atmosphere at high elevations. In one of them, that which took place at Wolverhampton on the 5th of September 1862, Glaisher and his companion attained the greatest height that had been reached by a balloon carrying passengers. As no automatically recording instruments were available, and Glaisher was unable to read the barometer at the highest point owing to loss of consciousness, the precise altitude can never be known, but it is estimated at about 7 m. from the earth. He died on the 7th of February 1903 at Croydon.

GLAMIS, a village and parish of Forfarshire, Scotland, 5½ m. W. by S. of Forfar by the Caledonian railway. Pop. of parish (1901) 1351. The name is sometimes spelled Glamis and the *i* is mute: it is derived from the Gaelic, *glamhus*, "a wide gap," "a vale." The chief object in the village is the sculptured stone, traditionally supposed to be a memorial of Malcolm II., although Fordun's statement that the king was slain in the castle is now rejected. About a mile from the station stands Glamis Castle, the seat of the earl of Strathmore and Kinghorne, a fine example of the Scottish Baronial style, enriched with certain features of the French château. In its present form it dates mostly from the 17th century, but the original structure was as old as the 11th century, for Macbeth was Thane of Glamis. Several of the early Scots kings, especially Alexander III., used it occasionally as a residence. Robert II. bestowed the thanedom on John Lyon, who had married the king's second daughter by Elizabeth Mure and was thus the founder of the existing family. Patrick Lyon became hostage to England for James I. in 1424. When, in 1537, Janet Douglas, widow of the 6th Lord Glamis, was burned at Edinburgh as a witch, for conspiring to procure James V.'s death, Glamis was forfeited to the crown, but it was restored to her son six years later when her innocence had been established. The 3rd earl of Strathmore entertained the Old Chevalier and eighty of his immediate followers in 1715. After discharging the duties of hospitality the earl joined the Jacobites at Sheriffmuir and fell on the battlefield. Sir Walter Scott spent a night in the "hoary old pile" when he was about twenty years old, and gives a striking relation of his experiences in his *Demonology and Witchcraft*. The hall has an arched ceiling and several historical portraits, including those of Claverhouse, Charles II. and James II. of England. At Cosmans, in the parish of Glamis, there is a remarkable sculptured monolith,

and other examples occur at the Hunters' Hill and in the old kirkyard of Eassie.

GLAMORGANSHIRE (Welsh *Morgannwg*), a maritime county occupying the south-east corner of Wales, and bounded N.W. by Carmarthenshire, N. by Carmarthenshire and Breconshire, E. by Monmouthshire and S. and S.W. by the Bristol Channel and Carmarthen Bay. The contour of the county is largely determined by the fact that it lies between the mountains of Breconshire and the Bristol Channel. Its extreme breadth from the sea inland is 29 m., while its greatest length from east to west is 53 m. Its chief rivers, the Rhymney, Taff, Neath (or Nêdd) and Tawe or Tawy, have their sources in the Breconshire mountains, the two first trending towards the south-east, while the two last trend to the south-west, so that the main body of the county forms a sort of quarter-circle between the Taff and the Neath. Near the apex of the angle formed by these two rivers is the loftiest peak in the county, the great Pennant scarp of Craig y Llyn or Carn Moesyn, 1970 ft. high, which in the Glacial period diverted the ice-flow from the Beacons into the valley on either side of it. To the south and south-east of this peak extend the great coal-fields of mid-Glamorgan, their surface forming an irregular plateau with an average elevation of 600 to 1200 ft. above sea-level, but with numerous peaks about 1500 ft. high, or more; Mynydd y Caerau, the second highest being 1223 ft. Out of this plateau have been carved, to the depth of 500 to 800 ft. below its general level, three distinct series of narrow valleys, those in each series being more or less parallel. The rivers which give their names to these valleys include the Cynon, the Great and Lesser Rhondda (tributaries of the Taff) and the Ely flowing to the S.E., the Ogwr or Ogmere (with its tributaries the Garw and Llynfi) flowing south through Bridgend, and the Avon bringing the waters of the Corwg and Gwynfi to the south-west into Swansea Bay at Aberavon. To the south of this central hill country, which is wet, cold and sterile, and whose steep slopes form the southern edge of the coal-field, there stretches out to the sea a gently undulating plain, compendiously known as the "Vale of Glamorgan," but in fact consisting of a succession of small vales of such fertile land and with such a mild climate that it has been styled, not inaptly, the "Garden of Wales." To the east of the central area referred to and divided from it by a spur of the Brecknock mountains culminating in Carn Bugall, 1570 ft. high, is the Rhymney, which forms the county's eastern boundary. On the west other spurs of the Beacons divide the Neath from the Tawe (which enters the sea at Swansea), and the Tawe from the Loughor, which, with its tributary the Amman, separates the county on the N.W. from Carmarthenshire, in which it rises, and falling into Carmarthen Bay forms what is known as the Burry estuary, so called from a small stream of that name in the Gower peninsula. The rivers are all comparatively short, the Taff, in every respect the chief river, being only 33 m. long.

Down to the middle of the 19th century most of the Glamorgan valleys were famous for their beautiful scenery, but industrial operations have since destroyed most of this beauty, except in the so-called "Vale of Glamorgan," the Vale of Neath, the "combes" and limestone gorges of Gower and the upper reaches of the Taff and the Tawe. The Vale of Neath is *par excellence* the waterfall district of South Wales, the finest falls being the Cilhepste fall, the Sychnant and the three Clungwyns on the Melle and its tributaries near the Vale of Neath railway from Neath to Hirwaun, Scwd Eionon Gam and Scwd Gladys on the Pyrdin on the west side of the valley close by, with Melin Court and Abergarwed still nearer Neath. There are also several cascades on the Dulais, and in the same district, though in Breconshire, is Scwd Henrhyd on the Llech near Colbren Junction. Almost the only part of the county which is now well timbered is the Vale of Neath. There are three small lakes, Llyn Fawr and Llyn Fach near Craig y Llyn and Kenfig Pool amid the sand-dunes of Margam. The rainfall of the county varies from an average of about 25 in. at Porthcawl and other parts of the Vale of Glamorgan to about 37 in. at Cardiff, 40 in. at Swansea and to upwards of 70 in. in the northern part of the county.

the fall being still higher in the adjoining parts of Breconshire whence Cardiff, Swansea, Merthyr and a large area near Neath draw their main supplies of water.

The county has a coast-line of about 83 m. Its two chief bays are the Burry estuary and Swansea, one on either side of the Gower Peninsula, which has also a number of smaller inlets with magnificent cliff scenery. The rest of the coast is fairly regular, the chief openings being at the mouths of the Ogmore and the Taff respectively. The most conspicuous headlands are Whiteford Point, Worms Head and Mumbles Head in Gower, Nash Point and Lavernock Point on the eastern half of the coast.

Geology.—The Silurian rocks, the oldest in the county, form a small inlier about 2 sq. m. in area at Rumney and Pen-y-lan, north of Cardiff, and consist of mudstones and sandstones of Wenlock and Ludlow age; a feeble representative of the Wenlock Limestone also is present. They are conformably succeeded by the Old Red Sandstone which extends westwards as far as Cowbridge as a deeply-eroded anticline largely concealed by Trias and Lias. The Old Red Sandstone consists in the lower parts of red marls and sandstones, while the upper beds are quartzitic and pebbly, and form bold scarps which dominate the low ground formed by the softer beds below. Cefn-y-bryn, another anticline of Old Red Sandstone (including small exposures of Silurian rocks), forms the prominent backbone of the Gower peninsula. The next formation is the Carboniferous Limestone which encircles and underlies the great South Wales coal-field, on the south of which, west of Cardiff, it forms a bold escarpment of steeply-dipping beds surrounding the Old Red Sandstone anticline. It shows up through the Trias and Lias in extensive inliers near Bridgend, while in Gower it dips away from the Old Red Sandstone of Cefn-y-bryn. On the north of the coal-field it is just reached near Merthyr Tydfil. The Millstone Grit, which consists of grits, sandstones and shales, crops out above the limestone and serves to introduce the Coal Measures, which lie in the form of a great trough extending east and west across the county and occupying most of its surface. The coal seams are most numerous in the lower part of the series; the Pennant Sandstone succeeds and occupies the inner parts of the basin, forming an elevated moorland region deeply trenched by the teeming valleys (e.g. the Rhondda) which cross the coal-field from north to south. Above the Pennant Sandstone still higher coals come in. Taken generally, the coals are bituminous in the south-east and anthracitic in the north-west.

After the Coal Measures had been deposited, the southern part of the region was subjected to powerful folding; the resulting anticlines were worn down during a long period of detrition, and then submerged slowly beneath a Triassic lake in which accumulated the Keuper conglomerates and marls which spread over the district west of Cardiff and are traceable on the coast of Gower. The succeeding Rhaetic and Lias which form most of the coastal plain (the fertile Vale of Glamorgan) from Penarth to near Bridgend were laid down by the Jurassic seas. A well-marked raised beach is traceable in Gower. Sand-dunes are present locally around Swansea Bay. Moraines, chiefly formed of gravel and clay, occupy many of the Glamorgan valleys; and these, together with the striated surfaces which may be observed at higher levels, are clearly glacial in origin. In the Coal Measures and the newer Limestones and Triassic, Rhaetic and Liasic conglomerates, marls and shales, many interesting fossils have been disinterred: these include the remains of an air-breathing reptile (*Anthroscopon*). Bones of the cave-bear, lion, mammoth, reindeer, rhinoceros, along with flint weapons and tools, have been discovered in some caves of the Gower peninsula.

Agriculture.—The low-lying land on the south from Caerphilly to Margam is very fertile, the soil being a deep rich loam; and here the standard of agriculture is fairly high, and there prevails a well-defined tenant-right custom, supposed to be of ancient origin but probably dating only from the beginning of the 19th century. Everywhere by the Coal Measures the soil is poor, while vegetation is also injured by the smoke from the works, especially copper smelting. Leland (*c.* 1535) describes the lowlands as growing good corn and grass but little wood, while the mountains had "redde dere, kiddes plenty, oxen and sheep." The land even in the "Vale" seems to have been open and unenclosed till the end of the 15th or beginning of the 16th century, while enclosure spread to the uplands still later. About one-fifth of the total area is still common land, more than half of which is unsuitable for cultivation. The total area under cultivation in 1905 was 269,271 acres or about one-half of the total area of the county. The chief crops raised (giving them in the order of their respective acreages) are oats, barley, turnips and swedes, wheat, potatoes and mangolds. A steady decrease of the acreage under grain-crops, green-crops and clover has been accompanied by an increase in the area of pasture. Dairying has been largely abandoned for stock-raising, and very little "Caerphilly cheese" is now made in that district. In 1905 Glamorgan had the largest number of horses in agriculture of any Welsh county except those of Carmarthen and Cardigan. Good sheep and ponies are reared in the hill-country. Pig-keeping is much neglected, and despite the mild climate very little fruit is grown. The average size of holdings in

1905 was 47.3 acres, there being only 46 holdings above 300 acres, and 1719 between 50 and 500 acres.

Mining and Manufactures.—Down to the middle of the 18th century the county had no industry of any importance except agriculture. The coal which underlies practically the whole surface of the county except the Vale of Glamorgan and West Gower was little worked till about 1755, when it began to be used instead of charcoal for the smelting of iron. By 1811, when there were 25 blast furnaces in the county, the demand for coal for this purpose had much increased, but it was in the most active period of railway construction that it reached its maximum. Down to about 1850, if not later, the chief collieries were owned by the ironmasters and were worked for their own requirements, but when the suitability of the lower seams in the district north of Cardiff for steam purposes was realized, an export trade sprang up and soon assumed enormous proportions, so that "the port of Cardiff" (including Barry and Penarth), from which the bulk of the steam coal was shipped, became the first port in the world for the shipment of coal. The development of the anthracite coal-field lying to the north and west of Swansea (from which port it is mostly shipped) dates mainly from the closing years of the 19th century, when the demand for this coal grew rapidly. There are still large areas in the Rhymney Valley on the east, and in the districts of Neath and Swansea on the west, whose development has only recently been undertaken. In connexion with the coal industry, patent fuel (made from small coal and tar) is largely manufactured at Cardiff, Port Talbot and Swansea, the shipments from Swansea being the largest in the kingdom. Next in importance to coal are the iron, steel and tin-plate industries, and in the Swansea district the smelting of copper and a variety of other ores.

The manufacture of iron and steel is carried on at Dowlais, Merthyr Tydfil, Cardiff, Port Talbot, Briton Ferry, Pontardawe, Swansea, Gorseinon and Gowerton. During the last quarter of the 19th century the use of the native ironstone was almost wholly given up, and the necessary ore is now imported, mainly from Spain. As a result several of the older inland works, such as those of Aberdare, Ystalyfera and Brynaman have been abandoned, and new works have been established on or near the sea-board; e.g. the Dowlais company in 1891 opened large works at Cardiff. The tin-plate industry is mainly confined to the west of the county, Swansea being the chief port for the shipment of tin-plates, though there are works near Llantrisant and at Melin Griffith near Cardiff, the latter being the oldest in the county. Copper-smelting is carried on on a large scale in the west of the county, at Port Talbot, Cwmavon, Neath and Swansea, and on a small scale at Cardiff, the earliest works having been established at Neath in 1584 and at Swansea in 1717. There are nickel works at Clydach near Swansea, the nickel being imported in the form of "matte" from Canada. Swansea has almost a monopoly of the manufacture of spelter or zinc. Lead, silver and a number of other metals or their by-products are treated in or near Swansea, which is often styled the "metallurgical capital of Wales." Limestone and silica quarries are worked, while sandstone and clay are also raised. Swansea and Mynyddau were formerly famous for their china, coarse ware is still made chiefly at Ewenny and terracotta at Pencoed. Large numbers of people are employed in engineering works and in the manufacture of machines, chains, conveyances, tools, paper and chemicals. The textile factories are few and unimportant.

Fisheries.—Fisheries exist all along the coast; by lines, draught-nets, dredging, trawling, fixed nets and by hand. There is a fleet of trawlers at Swansea. The principal fish caught are cod, herring, pollock, whiting, flukes, brill, plaice, soles, turbot, oysters, mussels, limpets, cockles, shrimps, crabs and lobsters. There are good fish-markets at Swansea and Cardiff.

Communications.—The county has ample dock accommodation. The various docks of Cardiff amount to 210 acres, including timber ponds; Penarth has a dock and basin of 26 acres and a tidal harbour of 55 acres. Barry docks cover 114 acres; Swansea has 147 acres, including its new King's Dock; and Port Talbot 90 acres. There are also docks at Briton Ferry and Portcawall, but they are not capable of admitting deep-draft vessels.

Besides its ports, Glamorgan has abundant means of transit in many railways, of which the Great Western is the chief. Its trunk line traversing the country between the mountains and the sea passes through Cardiff, Bridgend and Landore (on the outskirts of Swansea), and throws off numerous branches to the north. The Taff Vale railway serves all the valley of the Taff and its tributaries, and has also extensions to Barry and (through Llantrisant and Cowbridge) to Abergavenny. The Rhymney railway likewise serves the Rhymney Valley, and has a joint service with the Great Western between Cardiff and Merthyr Tydfil—the latter town being also the terminus of the Brecon and Merthyr and a branch of the North-Western from Abergavenny. The Barry railway visits Cardiff and then travels in a north-westerly direction to Pontypridd and Porth, while it sends another branch along the coast through Llantwit Major to Bridgend. Swansea is connected with Merthyr by the Great Western, with Brecon by the Midland, with Craven Arms and Mid-Wales generally by the London & North-Western, with the Rhondda Valley by the Rhondda and Swansea Bay (now worked by the Great Western) and with Mumbles by the Mumbles railway. The Port Talbot

railway runs to Blaengarw, and the Neath and Brecon railway (starting from Neath) joins the Midland at Colbren Junction. The canals of the county are the Glamorgan canal from Cardiff to Merthyr Tydfil (25½ m.), with a branch (7 m.) to Aberdare, the Neath canal (13 m.) from Briton Ferry to Abernant, Glyn Neath (whence a tramway formerly connected it with Aberdare), the Tennant canal connecting the rivers Neath and Tawe, and the Swansea canal (164 m.), running up the Swansea Valley from Swansea to Abercraive in Breconshire. Comparatively little use is now made of these canals, excepting the lower portions of the Glamorgan canal.

Population and Administration.—The area of the ancient county with which the administrative county is coterminous is 518,863 acres, with a population in 1901 of 859,931 persons. In the three decades between 1831 and 1861 it increased 35%, 35% and 37 1/2% respectively, and in 1881-1891, 34%, its average increase in the other decennial periods subsequent to 1861 being about 25%. The county is divided into five parliamentary divisions (viz. Glamorganshire East, South and Middle, Gower and Rhondda); it also includes the Cardiff district of boroughs (consisting of Cardiff, Cowbridge and Llantrisant), which has one member; the greater part of the parliamentary borough of Merthyr Tydfil (which mainly consists of the county borough of Merthyr, the urban district of Aberdare and part of Mountain Ash), and returns two members; and the two divisions of Swansea District returning one member each, one division consisting of the major part of Swansea town, the other comprising the remainder of Swansea and the boroughs of Aberavon, Kenfig, Llŵchwr and Neath. There are six municipal boroughs: Aberavon (pop. in 1901, 7553), Cardiff (164,333), Cowbridge (1202), Merthyr Tydfil (69,228), Neath (13,720) and Swansea (94,537). Cardiff (which in 1905 was created a city), Merthyr Tydfil and Swansea are county boroughs. The following are urban districts: Aberdare (43,365), Barry (27,090), Bridgend (6662), Briton Ferry (6973), Caerphilly (15,835), Glyncothwyn (6452), Maesteg (15,012), Margam (9014), Mountain Ash (31,093), Ogmore and Garw (19,907), Oystermouth (4461), Penarth (14,228), Pontypridd (32,316), Portcawl (1872) and Rhondda, previously known as Ystrad-y-fodwg (113,735). Glamorgan is in the S. Wales circuit, and both assizes and quarter-sessions are held at Cardiff and Swansea alternately. All the municipal boroughs have separate commissions of the peace, and Cardiff and Swansea have also separate courts of quarter-sessions. The county has thirteen other petty sessional divisions, Cardiff, the Rhondda (with Pontypridd) and the Merthyr and Aberdare district have stipendiary magistrates. There are 165 civil parishes. Excepting the districts of Gower and Kilvey, which are in the diocese of St David's, the whole county is in the diocese of Llandaff. There are 199 ecclesiastical parishes or districts situated wholly or partly within the county.

History.—The earliest known traces of man within the area of the present county are the human remains found in the famous bone-caves of Gower, though they are scanty as compared with the huge deposits of still earlier animal remains. To a later stage, perhaps in the Neolithic period, belongs a number of complete skeletons discovered in 1903 in sand-blown tumuli at the mouth of the Ogmere, where many flint implements were also found. Considerably later, and probably belonging to the Bronze Age (though finds of bronze implements have been scanty), are the many cairns and tumuli, mainly on the hills, such as on Garth Mountain near Cardiff, Crug-yr-avan and a number east of the Tawe; the stone circles often found in association with the tumuli, that of Carn Llecharth near Pontardawe being one of the most complete in Wales; and the fine cromlechs of Cefn Bryn in Gower (known as Arthur's Stone), of St Nicholas and of St Lythan's near Cardiff.

In Roman times the country from the Neath to the Wye was occupied by the Silures, a pre-Celtic race, probably governed at that time by Brythonic Celts. West of the Neath and along the fringe of the Brecknock Mountains were probably remnants of the earlier Goidelic Celts, who have left traces in the place-names of the Swansea valley (e.g. *lloch*, "a lake") and in the illegible Ogham inscription at Loughor, the only other Ogham stone in the county being at Kenfig, a few miles to the east of the Neath estuary. The conquest of the Silures by the Romans was begun about A.D. 50 by Ostorius Scapula and completed some 25 years later by Julius Frontinus, who probably constructed the great military road, called *Via Julia Maritima*, from Gloucester to St David's, with stations at Cardiff, Bovium (variously identified with Boverton, Cowbridge and Ewenny), Nidum (identified with Neath) and Leucarum or Loughor. The important station of Gaer on the Usk near Brecon was connected by two branch roads, one running from Cardiff through Celligaer (where there was a strong hill fort) and Merthyr Tydfil, and another from Neath

through Capel Colbren. Welsh tradition credits Glamorgan with being the first home of Christianity, and Llandaff the earliest bishopric in Britain, the name of three reputed missionaries of the 2nd century being preserved in the names of parishes in south Glamorgan. What is certain, however, is that the first two bishops of Llandaff, St Dubricius and St Teilo, lived during the first half of the 6th century, to which period also belongs the establishment of the great monastic settlements of Llanancarvan by Cadoc, of Llandough by Oudoceus and of Llantwit Major by Illtudus, the last of which flourished as a seat of learning down to the 12th century. A few moated mounds such as at Cardiff indicate that, after the withdrawal of the Romans, the coasts were visited by sporadic bands of Saxons, but the Scandinavians who came in the 9th and succeeding centuries left more abundant traces both in the place-names of the coast and in such camps as that on Sully Island, the Bulwarks at Porthkerry and Hardings Down in Gower. Meanwhile the native tribes of the district had regained their independence under a line of Welsh chieftains, whose domain was consolidated into a principality known as Glywysing, till about the end of the 10th century when it acquired the name of Morganwg, that is the territory of Morgan, a prince who died in A.D. 980; it then comprised the whole country from the Neath to the Wye, practically corresponding to the present diocese of Llandaff. Gwlad Morgan, later softened into Glamorgan, never had much vogue and meant precisely the same as Morganwg, though the two terms became differentiated a few centuries later.

The Norman conquest of Morganwg was effected in the closing years of the 11th century by Robert Fitzhamon, lord of Gloucester. His followers settled in the low-lying lands of the "Vale," which became known as the "body" of the shire, while in the hill country, which consisted of ten "members," corresponding to its ancient territorial divisions, the Welsh retained their customary laws and much of their independence. Glamorgan, whose bounds were now contracted between the Neath and the Rhymney, then became a lordship marcher, its status and organization being that of a county palatine; its lord possessed *jura regalia*, and his chief official was from the first a *vice-comes*, or sheriff, who presided over a county court composed of his lord's principal tenants. The inhabitants of Cardiff in which, as the *caput baroniae*, this court was held (though sometimes ambulatory), were soon granted municipal privileges, and in time Cowbridge, Kenfig, Llantrisant, Aberavon and Neath also became chartered market-towns. The manorial system was introduced throughout the "Vale," the manor in many cases becoming the parish, and the owner building for its protection first a castle and then a church. The church itself became Normanized, and monasteries were established—the Cistercian abbey of Neath and Margam in 1129 and 1147 respectively, the Benedictine priory of Ewenny in 1141 and that of Cardiff in 1147. Dominican and Franciscan houses were also founded at Cardiff in the following century.

Gower (with Kilvey) or the country west of the morass between Neath and Swansea had a separate history. It was conquered about 1100 by Henry de Newburgh, 1st earl of Warwick, by whose descendants and the powerful family of De Breos it was successively held as a marcher lordship, organized to some extent on county lines, till 1469. Swansea (which was the *caput baroniae* of Gower) and Loughor received their earlier charters from the lords of Gower (see GOWER).

For the first two centuries after Fitzhamon's time the lordship of Glamorgan was held by the earls of Gloucester, a title conferred by Henry I. on his natural son Robert, who acquired Glamorgan by marrying Fitzhamon's daughter. To the 1st earl's patronage of Geoffrey of Monmouth and other men of letters, at Cardiff Castle of which he was the builder, is probably due the large place which Celtic romance, especially the Arthurian cycle, won for itself in medieval literature. The lordship passed by descent through the families of Clare (who held it from 1217 to 1317), Despenser, Beauchamp and Neville to Richard III., on whose fall it escheated to the crown. From time to time, the Welsh of the hills, often joined by their countrymen from other

parts, raided the Vale, and even Cardiff Castle was seized about 1153 by Ivor Bach, lord of Senghenydd, who for a time held its lord a prisoner. At last Caerphilly Castle was built to keep them in check, but this provoked an invasion in 1270 by Prince Llewelyn ap Griffith, who besieged the castle and refused to retire except on conditions. In 1316 Llewelyn Bren headed a revolt in the same district, but being defeated was put to death by Despenser, whose great unpopularity with the Welsh made Glamorgan less safe as a retreat for Edward II. a few years later. In 1404 Glendower swept through the county, burning castles and laying waste the possessions of the king's supporters. By the Act of Union of 1535 the county of Glamorgan was incorporated as it now exists, by the addition to the old county of the lordship of Gower and Kilvey, west of the Neath. By another act of 1542 the court of great sessions was established, and Glamorgan, with the counties of Brecon and Radnor, formed one of its four Welsh circuits from thence till 1830, when the English assize system was introduced into Wales. In the same year the county was given one parliamentary representative, increased to two in 1832 and to five in 1885. The boroughs were also given a member. In 1832 Cardiff (with Llantrisant and Cowbridge), the Swansea group of boroughs and the parliamentary borough of Merthyr Tydfil were given one member each, increased to two, in the case of Merthyr Tydfil in 1867. In 1885 the Swansea group was divided into two constituencies with a member each.

The lordship of Glamorgan, shorn of its quasi-regal status, was granted by Edward VI. to William Herbert, afterwards 1st earl of Pembroke, from whom it has descended to the present marquess of Bute.

The rule of the Tudors promoted the rapid assimilation of the inhabitants of the county, and by the reign of Elizabeth even the descendants of the Norman knights had largely become Welsh both in speech and sentiment. Welsh continued to be the prevalent speech almost throughout the county, except in the peninsular part of Gower and perhaps Cardiff, till the last quarter of the 19th century. Since then it has lost ground in the maritime towns and the south-east corner of the county generally, while fairly holding its own, despite much English migration, in the industrial districts to the north. In 1901 about 56% of the total population above three years of age was returned as speaking English only, 37% as speaking both English and Welsh, and about 64% as speaking Welsh only.

In common with the rest of Wales the county was mainly Royalist in the Civil War, and indeed stood foremost in its readiness to pay ship-money, but when Charles I. visited Cardiff in July 1645 he failed to recruit his army there, owing to the dissatisfaction of the county, which a few months later declared for the parliament. There was, however, a subsequent Royalist revolt in Glamorgan in 1648, but it was signally crushed by Colonel Horton at the battle of St Fagan's (8th of May).

The educational gap caused by final disappearance of the great university of Llantwit Major, founded in the 6th century, and by the dissolution of the monasteries was to some extent filled by the foundation, by the Stradling family, of a grammar school at Cowbridge which, refounded in 1685 by Sir Leoline Jenkins, is still carried on as an endowed school. The only other ancient grammar school is that of Swansea, founded by Bishop Gore in 1682, and now under the control of the borough council. Besides the University College of South Wales and Monmouthshire established at Cardiff in 1883, and a technical college at Swansea, there is a Church of England theological college (St Michael's) at Llandaff (previously at Aberdare), a training college for school-mistresses at Swansea, schools for the blind at Cardiff and Swansea and for the deaf at Cardiff, Swansea and Pontypridd.

Antiquities.—The antiquities of the county not already mentioned include an unusually large number of castles, all of which, except the castles of Morlais (near Merthyr Tydfil), Castell Coch and Llantrisant, are between the hill country and the sea. The finest specimen is that of Caerphilly, but there are also more or less imposing ruins at Oystermouth, Coity, Newcastle (at Bridgend), Llanblethian, Pennard and Swansea.

Among the restored castles, resided in by their present owners, are St Donat's, "the latest and most complete of the structures built for defence," Cardiff, the residence of the marquess of Bute, St Fagan's, Dunraven, Fommon and Penrice. Of the monastic buildings, that of Ewenny is best preserved, Neath and Margam are mere ruins, while all the others have disappeared. Almost all the older churches possess towers of a somewhat military character, and most of them, except in Gower, retain some Norman masonry. Coity, Coychurch and Ewenny (all near Bridgend) are fine examples of cross churches with embattled towers characteristic of the county. There are interesting monumental effigies at St Mary's, Swansea, Oxwich, Ewenny, Llantwit Major, Llantrisant, Coity and other churches in the Vale. There are from twenty-five to thirty sculptured stones, of which some sixteen are both ornamented and inscribed, five of the latter being at Margam and three at Llantwit Major, and dating from the 9th century if not earlier.

AUTHORITIES.—The records of the *Curia comitatus* or County Court of Glamorgan are supposed to have perished, so also have the records of Neath. With these exceptions, the records of the county have been well preserved. A collection edited by G. T. Clark under the title *Cartae et alia monumenta quae ad dominium de Glamorgan pertinent* was privately printed by him in four volumes (1885-1893). *A Descriptive Catalogue of the Penrice and Margam Abbey MSS. in the Possession of Miss Talbot of Margam* (6 vols.) was privately issued (1893-1905) under the editorship of Dr de Gray Birch, who has also published histories of the Abbeys of Neath and Margam. *The Book of Llan Ddŷ* (edited by Dr Gweno-gwyn Evans, 1903) contains documents illustrative of the early history of the diocese of Llandaff. Cardiff has published its *Records* in 5 vols., and there is a volume of Swansea charters. There is no complete history of the county, except a modest but useful one in Welsh—*Ianes Morgannwg*, by D. W. Jones (Dalydd Morgannwg) (1874); the chief contributions are Rice Merrick's *Booke of Glamorgan-shire's Antiquities*, written in 1578; *The Land of Morgannwg* (a history of the lordship of Glamorgan), by G. T. Clark, whose *Genealogies of Glamorgan* (1886) and *Medieval Military Architecture* (1884) are also indispensable; see also T. Nicholas, *Annals and Antiquities of the Counties and County Families of Wales* (2 vols., 1872). For Gower, see GOWER.

GLANDERS, or FARCY (*Equinia*), a specific infective and contagious disease, caused by a tissue parasite (*Bacillus mallei*), to which certain animals, chiefly the horse, ass and mule, are liable, and which is communicable from them to man. Glanders in the domesticated animals is dealt with under **VETERINARY SCIENCE**; it is happily a rare form of disease in man, there being evidently less affinity for its development in the human subject than in the equine species. For the pathology see the article **PARASITIC DISEASES**. It occurs chiefly among those who from their occupation are frequently in contact with horses, such as grooms, coachmen, cavalry soldiers, veterinary surgeons, &c.; the bacillus is communicated from a glandered animal either through a wound or scratch or through application to the mucous membrane of the nose or mouth. A period of incubation, lasting from three to five days, generally follows the introduction of the virus into the human system. This period, however, appears sometimes to be of much longer duration, especially where there has been no direct inoculation of the poison. The first symptoms are a general feeling of illness, accompanied with pains in the limbs and joints resembling those of acute rheumatism. If the disease has been introduced by means of an abraded surface, pain is felt at that point, and inflammatory swelling takes place there, and extends along the neighbouring lymphatics. An ulcer is formed at the point of inoculation which discharges an offensive ichor, and blebs appear in the inflamed skin, along with diffuse abscesses, as in phlegmonous erysipelas. Sometimes the disease stops short with these local manifestations, but more commonly goes on rapidly accompanied with symptoms of grave constitutional disturbance. Over the whole surface of the body there appear numerous red spots or pustules, which break and discharge a thick mucous or sanguineous fluid. Besides these there are larger swellings lying deeper in the subcutaneous tissue, which at first are extremely hard and painful, and to which the term farcy "buds" or "buttons" is applied. These ultimately open and become extensive sloughing ulcers.

The mucous membranes participate in the same lesions as

are present in the skin, and this is particularly the case with the interior of the nose, where indeed, in many instances, the disease first of all shows itself. This organ becomes greatly swollen and inflamed, while from one or both nostrils there exudes a copious discharge of highly offensive purulent or sanguineous matter. The lining membrane of the nostrils is covered with papules similar in character to those on the skin, which form ulcers, and may lead to the destruction of the cartilaginous and bony textures of the nose. The diseased action extends into the throat, mouth and eyes, while the whole face becomes swollen and erysipelatous, and the lymphatic glands under the jaws inflame and suppurate. Not unfrequently the bronchial tubes become affected, and cough attended with expectoration of matter similar to that discharged from the nose is the consequence. The general constitutional symptoms are exceedingly severe, and advance with great rapidity, the patient passing into a state of extreme prostration. In the acute form of the disease recovery rarely if ever occurs, and the case generally terminates fatally in a period varying from two or three days to as many weeks.

A chronic form of glanders and farcy is occasionally met with, in which the symptoms, although essentially the same as those above described, advance much more slowly, and are attended with relatively less urgent constitutional disturbance. Cases of recovery from this form are on record; but in general the disease ultimately proves fatal by exhaustion of the patient, or by a sudden supervention, which is apt to occur, of the acute form. On the other hand, acute glanders is never observed to become chronic.

In the treatment of this malady in human beings reliance is mainly placed on the maintenance of the patient's strength by strong nourishment and tonic remedies. Cauterization should be resorted to if the point of infection is early known. Abscesses may be opened and antiseptic lotions used. In all cases of the outbreak of glanders it is of the utmost consequence to prevent the spread of the disease by the destruction of affected animals and the cleansing and disinfection of infected localities.

GLANVILL (or GLANVIL), JOSEPH (1636-1680), English philosopher, was born at Plymouth in 1636, and was educated at Exeter and Lincoln colleges, Oxford, where he graduated as M.A. in 1658. After the Restoration he was successively rector of Wimbush, Essex, vicar of Frome Selwood, Somersetshire, rector of Streat and Walton. In 1666 he was appointed to the abbey church, Bath; in 1678 he became prebendary of Worcester Cathedral, and acted as chaplain in ordinary to Charles II. from 1672. He died at Bath in November 1680. Glanvill's first work (a passage in which suggested the theme of Matthew Arnold's *Scholar Gipsy*), *The Vanity of Dogmatizing, or Confidence in Opinions, manifested in a Discourse of the shortness and uncertainty of our Knowledge, and its Causes, with Reflexions on Peripateticism, and an Apology for Philosophy* (1661), is interesting as showing one special direction in which the new method of the Cartesian philosophy might be developed. Pascal had already shown how philosophical scepticism might be employed as a bulwark for faith, and Glanvill follows in the same track. The philosophic endeavour to cognize the whole system of things by referring all events to their causes appears to him to be from the outset doomed to failure. For if we inquire into this causal relation we find that though we know isolated facts, we cannot perceive any such connexion between them as that the one should give rise to the other. In the words of Hume, "they seem conjoined but never connected." All causes then are but secondary, *i.e.* merely the occasions on which the one first cause operates. It is singular enough that Glanvill who had not only shown, but even exaggerated, the infirmity of human reason, himself provided an example of its weakness; for, after having combated scientific dogmatism, he not only yielded to vulgar superstitions, but actually endeavoured to accredit them both in his revised edition of the *Vanity of Dogmatizing*, published as *Sceptis scientificis* (1665, ed. Rev. John Owen, 1885), and in his *Philosophical Considerations concerning the existence of Sorcerers and Sorcery* (1666).

The latter work appears to have been based on the story of the drum which was alleged to have been heard every night in a house in Wiltshire (Tedworth, belonging to a Mr Mompesson), a story which made much noise in the year 1663, and which is supposed to have furnished Addison with the idea of his comedy the *Drummer*. At his death Glanvill left a piece entitled *Sadducismus Triumphatus* (printed in 1681, reprinted with some additions in 1682, German trans. 1701). He had there collected twenty-six relations or stories of the same description as that of the drum, in order to establish, by a series of facts, the opinion which he had expressed in his *Philosophical Considerations*. Glanvill supported a much more honourable cause when he undertook the defence of the Royal Society of London, under the title of *Plus Ultra, or the Progress and Advancement of Science since the time of Aristotle* (1668), a work which shows how thoroughly he was imbued with the ideas of the empirical method.

Besides the works already noticed, Glanvill wrote *Lux orientalis* (1662); *Philosophia pia* (1671); *Essays on Several Important Subjects in Philosophy and Religion* (1676); *An Essay concerning Preaching*; and *Sermons*. See C. Rémusat, *Hist. de la phil. en Angleterre*, bk. iii. ch. xi.; W. E. H. Lecky, *Rationalism in Europe* (1865), i. 120-128; Hallam's *Literature of Europe*, iii. 358-360; Tulloch's *Rational Theology*, ii. 443-455.

GLANVILL, RANULF DE (sometimes written GLANVIL, GLANVILLE) (d. 1190), chief justiciar of England and reputed author of a book on English law, was born at Stratford in Suffolk, but in what year is unknown. There is but little information regarding his early life. He first comes to the front as sheriff of Yorkshire from 1163 to 1170. In 1173 he became sheriff of Lancashire and custodian of the honour of Richmond. In 1174 he was one of the English leaders at the battle of Alnwick, and it was to him that the king of the Scots, William the Lion, surrendered. In 1175 he was reappointed sheriff of Yorkshire, in 1176 he became justice of the king's court and a justice itinerant in the northern circuit, and in 1180 chief justiciar of England. It was with his assistance that Henry II. completed his judicial reforms, though the principal of them had been carried out before he came into office. He became the king's right-hand man, and during Henry's frequent absences was in effect viceroy of England. After the death of Henry in 1189, Glanvill was removed from his office by Richard I., and imprisoned till he had paid a ransom, according to one authority, of £15,000. Shortly after obtaining his freedom he took the cross, and he died at the siege of Acre in 1190. At the instance, it may be, of Henry II., Glanvill wrote or superintended the writing of the *Tractatus de legibus et consuetudinibus regni Angliæ*, which is a practical treatise on the forms of procedure in the king's court. As the source of our knowledge regarding the earliest form of the *curia regis*, and for the information it affords regarding ancient customs and laws, it is of great value to the student of English history. It is now generally agreed that the work of Glanvill is of earlier date than the Scottish law book known from its first words as *Regiam Majestatem*, a work which bears a close resemblance to his.

The treatise of Glanvill was first printed in 1554. An English translation, with notes and introduction by John Beames, was published at London in 1812. A French version is found in various MSS., but has not yet been printed. (See also ENGLISH LAW: *History of*.)

GLAPTHORNE, HENRY (fl. 1635-1642),—English poet and dramatist, wrote in the reign of Charles I. All that is known of him is gathered from his own work. He published *Poems* (1639), many of them in praise of an unidentified "Lucinda"; a poem in honour of his friend Thomas Beedome, whose *Poems Divine and Humane* he edited in 1641; and *Whitehall* (1642), dedicated to his "noble friend and gossip, Captain Richard Lovelace." The first volume contains a poem in honour of the duke of York, and *Whitehall* is a review of the past glories of the English court, containing abundant evidences of the writer's devotion to the royal cause. *Argalus and Parthenia* (1639) is a pastoral tragedy founded on an episode in Sidney's *Arcadia*; *Alburtus Wallenstein* (1639), his only attempt at historical tragedy, represents Wallenstein as a monster of pride and cruelty. His

other plays are *The Holländer* (written 1635; printed 1640), a romantic comedy of which the scene is laid in Genoa; *Wit in a Constable* (1640), which is probably a version of an earlier play, and owes something to Shakespeare's *Much Ado about Nothing*; and *The Ladies Privilege* (1640). *The Lady Mother* (1635) has been identified (Fleay, *Biog. Chron. of the Drama*) with *The Noble Trial*, one of the plays destroyed by Warburton's cook, and Mr A. H. Bullen prints it in vol. ii. of his *Old English Plays* as most probably Glapthorne's work. *The Parasite, or Revenge for Honour* (1654), entered at Stationers' Hall in 1653 as Glapthorne's, was printed in the next year with George Chapman's name on the title-page. It should probably be included among Glapthorne's plays, which, though they hardly rise above the level of contemporary productions, contain many felicitous isolated passages.

The *Plays and Poems of Henry Glapthorne* (1874) contains an unsigned memoir, which, however, gives no information about the dramatist's life. There is no reason for supposing that the George Glapthorne of whose trial details are given was a relative of the poet.

GLARUS (Fr. *Glaris*), one of the Swiss cantons, the name being taken from that of its chief town. Its area is 266.8 sq. m., of which 173.1 sq. m. are classed as "productive" (forests covering 41 sq. m.), but it also contains 13.9 sq. m. of glaciers, ranking as the fifth Swiss canton in this respect. It is thus a mountain canton, the loftiest point in it being the Tödi (11,887 ft.), the highest summit that rises to the north of the upper Aar and Vorder Rhine valleys. It is composed of the upper valley of the Linth, that is the portion which lies to the south of a line drawn from the Lake of Zürich to the Walensee. This river rises in the glaciers of the Tödi, and has carved out for itself a deep bed, so that the floor of the valley is comparatively level, and therefore is occupied by a number of considerable villages. Glacier passes only lead from its head to the Grisons, save the rough footpath over the Kisten Pass, while a fine new carriage road over the Klausen Pass gives access to the canton of Uri. The upper Linth valley is sometimes called the Grosstal (main valley) to distinguish it from its chief (or south-eastern) tributary, the Serf valley or Kleintal, which joins it at Schwanden, a little above Glarus itself. At the head of the Kleintal a mule track leads to the Grisons over the Panixer Pass, as also a footpath over the Segnes Pass. Just below Glarus town, another glen (coming from the south-west) joins the main valley, and is watered by the Klön, while from its head the Prugel Pass (a mule path, converted into a carriage road) leads over to the canton of Schwyz. The Klön glen (uninhabited save in summer) is separated from the main glen by the fine bold mass of the Glärnisch (9,580 ft.), while the Serf valley is similarly cut off from the Grosstal by the high ridge running northwards from the Hausstock (10,342 ft.) over the Käppstock (9,177 ft.). The principal lakes, the Klönthalensee and the Muttensee, are of a thoroughly Alpine character, while there are several fine waterfalls near the head of the main valley, such as those formed by the Sandbach, the Schreienbach and the Fätschbach. The Pantenbrücke, thrown over the narrow cleft formed by the Linth, is one of the grandest sights of the Alps below the snow-line. There is a sulphur spring at Stachelberg, near Linthal village, and an iron spring at Elm, while in the Serf valley there are the Plattenberg slate quarries, and just south of Elm those of the Tschingelberg, whence a terrific landslip descended to Elm (11th September 1881), destroying many houses and killing 115 persons. A railway runs through the whole canton from north to south past Glarus to Linthal village (16½ m.), while from Schwanden there is an electric line (opened in 1905) up to Elm (8½ m.).

In 1900 the population of the canton was 32,349 (a decrease on the 33,825 of 1888, this being the only Swiss canton which shows a decrease), of whom 31,797 were German-speaking, while there were 24,403 Protestants, 7918 Romanists (many in Näfels) and 3 Jews. After the capital, Glarus (*g. s.*), the largest villages are Näfels (2557 inhabitants), Ennenda (2494 inhabitants), opposite Glarus, of which it is practically a suburb), Netetal (2003 inhabitants), Mollis (1912 inhabitants) and Linthal

(1894 inhabitants). The slate industry is now the most important as the cotton manufacture has lately very greatly fallen off, this being the real reason of the diminution in the number of the population. There is little agriculture, for it is a pastoral region (owing to its height) and contains 87 mountain pastures (though the finest of all within the limits of the canton, the Urnerboden, or the Glarus side of the Klausen Pass, belongs to Uri), which can support 8054 cows, and are of an estimated capital value of about £246,000. One of the most characteristic products (though inferior qualities are manufactured elsewhere in Switzerland) is the cheese called *Schabzieger, Krüderkäse*, or green cheese, made of skim milk (*Zieger* or *strac*), whether of goats or cows, mixed with buttermilk and coloured with powdered *Steinblee* (*Melilotus officinalis*) or *blauer Honigklee* (*Melilotus caerulea*). The curds are brought down from the huts on the pastures, and, after being mixed with the dried powder, are ground in a mill, then put into shapes and pressed. The cheese thus produced is ripe in about a year, keeps a long time and is largely exported, even to America. The ice formed on the surface of the Klönthalensee in winter is stored up on its shore and exported. A certain number of visitors come to the canton in the summer, either to profit by one or other of the mineral springs mentioned above, or simply to enjoy the beauties of nature, especially at Obstallden, above the Walensee. The canton forms but a single administrative district and contains 28 communes. It sends to the Federal *Ständerath* 2 representatives (elected by the *Landsgemeinde*) and 2 also to the Federal *Nationalrath*. The canton still keeps its primitive democratic assembly or *Landsgemeinde* (meeting annually in the open air at Glarus on the first Sunday in May), composed of all male citizens of 20 years of age. It acts as the sovereign body, so that no "referendum" is required, while any citizen can submit a proposal. It names the executive of 6 members, besides the Landammann or president, all holding office for three years. The communes (forming 18 electoral circles) elect for three years the *Landrath*, a sort of standing committee composed of members in the proportion of 1 for every 500 inhabitants or fraction over 250. The present constitution dates from 1887. (W. A. B. C.)

GLARUS (Fr. *Glaris*), the capital of the Swiss canton of the same name. It is a clean, modern little town, built on the left bank of the Linth (opposite it is the industrial suburb of Ennenda on the right bank), at the north-eastern foot of the imposing rock peak of the Vorder Glärnisch (7648 ft.), while on the east rises the Schild (6400 ft.). It now contains but few houses built before 1861, for on the 10/11 May 1861 practically the whole town was destroyed by fire that was fanned by a violent *Föhn* or south wind, rushing down from the high mountains through the natural funnel formed by the Linth valley. The total loss is estimated at about half a million sterling, of which about £100,000 were made up by subscriptions that poured in from every side. It possesses the broad streets and usual buildings of a modern town, the parish church being by far the most stately and well-situated building; it is used in common by the Protestants and Romans. Zwingli, the reformer, was parish priest here from 1506 to 1516, before he became a Protestant. The town is 1578 ft. above the sea-level, and in 1900 had a population of 4877, almost all German-speaking, while 1248 were Romanists. For the Linth canals (1811 and 1816) see LINTH.

The DISTRICT OF GLARUS is said to have been converted to Christianity in the 6th century by the Irish monk, Fridolin, whose special protector was St Hilary of Poitiers; the former was the founder, and both were patrons, of the Benedictine nunnery of Säckingen, on the Rhine between Constance and Basel, that about the 9th century became the owner of the district which was then named after St Hilary. The Habsburgs, protectors of the nunnery, gradually drew to themselves the exercise of all the rights of the nuns, so that in 1352 Glarus joined the Swiss Confederation. But the men of Glarus did not gain their complete freedom till after they had driven back the Habsburgs in the glorious battle of Näfels (1388), the complement of Sempach, so that the Habsburgs gave up their rights

in 1398, while those of Säckingen were bought up in 1395, on condition of a small annual payment. Glarus early adopted Protestantism, but there were many struggles later on between the two parties, as the chief family, that of Tschudi, adhered to the old faith. At last it was arranged that, besides the common *Landsgemeinde*, each party should have its separate *Landsgemeinde* (1623) and tribunals (1683), while it was not till 1798 that the Protestants agreed to accept the Gregorian calendar. The slate-quarrying industry appeared early in the 17th century, while cotton-spinning was introduced about 1714, and calico-printing by 1750. In 1798, in consequence of the resistance of Glarus to the French invaders, the canton was united to other districts under the name of canton of the Linth, though in 1803 it was reduced to its former limits. In 1799 it was traversed by the Russian army, under Suworoff, coming over the Prager Pass, but blocked by the French at Näfels, and so driven over the Panixer to the Grisons. The old system of government was set up again in 1814. But in 1836 by the new Liberal constitution one single *Landsgemeinde* was restored, despite the resistance (1837) of the Romanist population at Näfels.

AUTHORITIES.—J. Bähler, *Die Alpwirtschaft im Kant. G.* (Soleure, 1898); J. J. Blumer, article on the early history of the canton in vol. iii. (Zürich, 1844) of the *Archiv f. schweiz. Geschichte*; E. Buss and A. Heim, *Der Bergsturz von Elm* (1387) (Zürich, 1881); W. A. B. Coolidge, *The Range of the Tödi* (London, 1894); J. G. Ebel, *Schuldensatz der Gebirgsstädte d. Schweiz*, vol. ii. (Leipzig, 1798); Gottfried Heer, *Geschichte d. Landes Glarus* (to 1830) (2 vols., Glarus, 1898-1899); *Glärnerische Reformationsgeschichte* (Glarus, 1900); *Zur 500 jährigen Gedächtnisfeier der Schlacht bei Näfels* (1388) (Glarus, 1888) and *Die Kirchen d. Kant. Glarus* (Glarus, 1890); Oswald Heer and J. J. Blumer-Heer, *Der Kant. Glarus* (St Gall, 1846); J. J. Hottinger, *Conrad Escher von der Linth* (Zürich, 1852); *Jahrbuch*, published annually since 1865 by the Cantonal Historical Society; A. Jenny-Trümpler, "Handel u. Industrie d. Kant. G." (article in vol. xxxiii., 1899, of the *Jahrbuch*); M. Schuler, *Geschichte d. Landes Glarus* (Zürich, 1836); E. Naf-Blumer, *Clubführer durch die Glärner-Alpen* (Schwanden, 1902); Aloys Schulte, article on the true and legendary early history of the Canton, published in vol. xviii., 1893, of the *Jahrbuch f. schweiz. Geschichte* (Zürich); J. J. Blumer, *Staats- und Rechtsgeschichte d. schweiz. Demokratien* (3 vols., St Gall, 1850-1859); H. Ryffel, *Die schweiz. Landsgemeinden* (Zürich, 1903); R. von Reding-Biberegg, *Der Zug Suworoffs durch die Schweiz im 1799* (Stans, 1895). (W. A. B. C.)

GLAS, GEORGE (1725-1765), Scottish seaman and merchant adventurer in West Africa, son of John Glas the divine, was born at Dundee in 1725, and is said to have been brought up as a surgeon. He obtained command of a ship which traded between Brazil, the N.W. coasts of Africa and the Canary Islands. During his voyages he discovered on the Saharan seaboard a river navigable for some distance inland, and here he proposed to found a trading station. The exact spot is not known with certainty, but it is plausibly identified with Gueder, a place in about 29° 10' N., possibly the haven where the Spaniards had in the 15th and 16th centuries a fort called Santa Cruz de Mar Pequena. Glas made an arrangement with the Lords of Trade whereby he was granted £15,000 if he obtained free cession of the port he had discovered to the British crown; the proposal was to be laid before parliament in the session of 1765. Having chartered a vessel, Glas, with his wife and daughter, sailed for Africa in 1764, reached his destination and made a treaty with the Moors of the district. He named his settlement Port Hillsborough, after Willis Hill, earl of Hillsborough (afterwards marquis of Downshire), president of the Board of Trade and Plantations, 1763-1765. In November 1764 Glas and some companions, leaving his ship behind, went in the longboat to Lanzarote, intending to buy a small barque suitable for the navigation of the river on which was his settlement. From Lanzarote he forwarded to London the treaty he had concluded for the acquisition of Port Hillsborough. A few days later he was seized by the Spaniards, taken to Teneriffe and imprisoned at Santa Cruz. In a letter to the Lords of Trade from Teneriffe, dated the 15th of December 1764, Glas said he believed the reason for his detention was the jealousy of the Spaniards at the settlement at Port Hillsborough, "because from thence in time of war the English might ruin their fishery and effectually stop the whole commerce of the Canary Islands."

The Spaniards further looked upon the settlement as a step towards the conquest of the islands. "They are therefore contriving how to make out a claim to the port and will forge old manuscripts to prove their assertion" (*Calendar of Home Office Papers, 1760-1765*). In March 1765 the ship's company at Port Hillsborough was attacked by the natives and several members of it killed. The survivors, including Mrs and Miss Glas, escaped to Teneriffe. In October following, through the representations of the British government, Glas was released from prison. With his wife and child he set sail for England on board the barque "Earl of Sandwich." On the 30th of November Spanish and Portuguese members of the crew, who had learned that the ship contained much treasure, mutinied, killing the captain and passengers. Glas was stabbed to death, and his wife and daughter thrown overboard. (The murderers were afterwards captured and hanged at Dublin.) After the death of Glas the British government appears to have taken no steps to carry out his project.

In 1764 Glas published in London *The History of the Discovery and Conquest of the Canary Islands*, which he had translated from the MS. of an Andalusian monk named Juan Abreu de Galindo, then recently discovered at Palma. To this Glas added a description of the islands, a continuation of the history and an account of the manners, customs, trade, &c., of the inhabitants, displaying considerable knowledge of the archipelago.

GLAS, JOHN (1695-1723), Scottish divine, was born at Auchtermuchty, Fife, where his father was parish minister, on the 5th of October 1695. He was educated at Kinclaven and the grammar school, Perth, graduated A.M. at the university of St Andrews in 1713, and completed his education for the ministry at Edinburgh. He was licensed as a preacher by the presbytery of Dunkeld, and soon afterwards ordained by that of Dundee as minister of the parish of Tealing (1719), where his effective preaching soon secured a large congregation. Early in his ministry he was "brought to a stand" while lecturing on the "Shorter Catechism" by the question "How doth Christ execute the office of a king?" This led to an examination of the New Testament foundation of the Christian Church, and in 1725, in a letter to Francis Archibald, minister of Guthrie, Forfarshire, he repudiated the obligation of national covenants. In the same year his views found expression in the formation of a society—"separate from the multitude" numbering nearly a hundred, and drawn from his own and neighbouring parishes. The members of this *ecclesia in ecclesia* pledged themselves "to join together in the Christian profession, to follow Christ the Lord as the righteousness of his people, to walk together in brotherly love, and in the duties of it, in subjection to Mr Glas as their overseer in the Lord, to observe the ordinance of the Lord's Supper once every month, to submit themselves to the Lord's law for removing offences," &c. (Matt. xviii. 15-20). From the scriptural doctrine of the essentially spiritual nature of the kingdom of Christ, Glas in his public teaching drew the conclusions: (1) that there is no warrant in the New Testament for a national church; (2) that the magistrate as such has no function in the church; (3) that national covenants are without scriptural grounds; (4) that the true Reformation cannot be carried out by political and secular weapons but by the word and spirit of Christ only.

This argument is most fully exhibited in a treatise entitled *The Testimony of the King of Martyrs* (1729). For the promulgation of these views, which were confessedly at variance with the doctrines of the standards of the national church of Scotland, he was summoned (1726) before his presbytery, where in the course of the investigations which followed he affirmed still more explicitly his belief that "every national church established by the laws of earthly kingdoms is antichristian in its constitution and persecuting in its spirit," and further declared opinions upon the subject of church government which amounted to a repudiation of Presbyterianism and an acceptance of the puritan type of Independency. For these opinions he was in 1728 suspended from the discharge of ministerial functions, and finally deposed in 1730. The members of the society already referred to, however, for the most part continued to adhere

to him, thus constituting the first "Glassite" or "Glasite" church. The seat of this congregation was shortly afterwards transferred to Dundee (whence Glas subsequently removed to Edinburgh), where he officiated for some time as an "elder." He next laboured in Perth for a few years, where he was joined by Robert Sandeman (see GLASITES), who became his son-in-law, and eventually was recognized as the leader and principal exponent of Glas's views; these he developed in a direction which laid them open to the charge of antinomianism. Ultimately in 1730 Glas returned to Dundee, where the remainder of his life was spent. He introduced in his church the primitive custom of the "osculum pacis" and the "agape" celebrated as a common meal with broth. From this custom his congregation was known as the "kail kirk." In 1739 the General Assembly, without any application from him, removed the sentence of deposition which had been passed against him, and restored him to the character and function of a minister of the gospel of Christ, but not that of a minister of the Established Church of Scotland, declaring that he was not eligible for a charge until he should have renounced principles inconsistent with the constitution of the church.

A collected edition of his works was published at Edinburgh in 1761 (4 vols., 8vo.), and again at Perth in 1782 (5 vols., 8vo.). He died in 1773.

Glas's published works bear witness to his vigorous mind and scholarly attainments. His reconstruction of the *True Discourse of Celsius* (1753), from Origen's reply to it, is a competent and learned piece of work. The *Testimony of the King of Martyrs concerning His Kingdom* (1729) is a classic repudiation of erastianism and defence of the spiritual autonomy of the church under Jesus Christ. His common sense appears in his rejection of Hutcheson's attempt to prove that the Bible supplies a complete system of physical science, and his shrewdness in his *Notes on Scripture Texts* (1747). He published a volume of Christian Songs (Perth, 1784). (D. M.N.)

GLASER, CHRISTOPHER, a pharmaceutical chemist of the 17th century, was a native of Basel, became demonstrator of chemistry at the Jardin du Roi in Paris and apothecary to Louis XIV. and to the duke of Orleans. He is best known by his *Traité de la chymie* (Paris, 1663), which went through some ten editions in about five-and-twenty years, and was translated into both German and English. It has been alleged that he was an accomplice in the notorious poisonings carried out by the marchioness de Brinvilliers, but the extent of his complicity is doubtful. He appears to have died some time before 1676. The *sal polychrestum Glaseri* is normal potassium sulphate which he prepared and used medicinally.

GLASGOW, a city, county of a city, royal burgh and port of Lanarkshire, Scotland, situated on both banks of the Clyde, 40½ m. N.W. of London by the West Coast railway route, and 47 m. W.S.W. of Edinburgh by the North British railway. The valley of the Clyde is closely confined by hills, and the city extends far over these, the irregularity of its site making for picturesqueness. The commercial centre of Glasgow, with the majority of important public buildings, lies on the north bank of the river, which traverses the city from W.S.W. to E.N.E., and is crossed by a number of bridges. The uppermost is Dalmarnock Bridge, dating from 1891, and next below it is Rutherglen Bridge, rebuilt in 1896, and superseding a structure of 1775. St Andrew's suspension bridge gives access to the Green to the inhabitants of Hutchesontown, a district which is approached also by Albert Bridge, a handsome erection, leading from the Saltmarket. Above this bridge is the tidal dam and weir. Victoria Bridge, of granite, was opened in 1856, taking the place of the venerable bridge erected by Bishop Rae in 1345, which was demolished in 1847. Then follows a suspension bridge (dating from 1853) by which foot-passengers from the south side obtain access to St Enoch Square and, finally, the most important bridge of all is reached, variously known as Glasgow, Jamaica Street, or Broomielaw Bridge, built of granite from Telford's designs and first used in 1835. Towards the close of the century it was reconstructed, and reopened in 1899. At the busier periods of the day it bears a very heavy traffic. The stream is spanned between Victoria and Albert Bridges by a bridge belonging to the Glasgow & South-Western railway and by two

bridges carrying the lines of the Caledonian railway, one below Dalmarnock Bridge and the other a massive work immediately west of Glasgow Bridge.

Buildings.—George Square, in the heart of the city, is an open space of which every possible advantage has been taken. On its eastern side stand the municipal buildings, a palatial pile in Venetian renaissance style, from the designs of William Young, a native of Paisley. They were opened in 1889 and cost nearly £600,000. They form a square block four storeys high and carry a domed turret at each end of the western façade, from the centre of which rises a massive tower. The entrance hall and grand staircase, the council chamber, banqueting hall and reception rooms are decorated in a grandiose style, not unbecoming to the commercial and industrial metropolis of Scotland. Several additional blocks have been built or rented for the accommodation of the municipal staff. Admirably equipped sanitary chambers were opened in 1897, including a bacteriological and chemical laboratory. Up till 1810 the town council met in a hall adjoining the old tolbooth. It then moved to the fine classical structure at the foot of the Saltmarket, which is now used as court-houses. This was vacated in 1842 for the county buildings in Wilson Street. Growth of business compelled another migration to Ingram Street in 1875, and, fourteen years later, it occupied its present quarters. On the southern side of George Square the chief structure is the massive General Post Office. On the western side stand two ornate Italian buildings, the Bank of Scotland and the Merchants' House, the head of which (the dean of gild), along with the head of the Trades' House (the deacon-convener of trades) has been *de facto* member of the town council since 1711, an arrangement devised with a view to adjusting the frequent disputes between the two gilds. The Royal Exchange, a Corinthian building with a fine portico of columns in two rows, is an admired example of the work of David Hamilton (1768-1843), a native of Glasgow, who designed several of the public buildings and churches, and gained the second prize for a design for the Houses of Parliament. The news-room of the exchange is a vast apartment, 130 ft. long, 60 ft. wide, 130 ft. high, with a richly-decorated roof supported by Corinthian pillars. Buchanan Street, the most important and handsome street in the city, contains the Stock Exchange, the Western Club House (by-David Hamilton) and the offices of the *Glasgow Herald*. In Sauchiehall Street are the Fine Art Institute and the former Corporation Art Gallery. Argyll Street, the busiest thoroughfare, mainly occupied with shops, leads to Trongate, where a few remains of the old town are now carefully preserved. On the south side of the street, spanning the pavement, stands the Tron Steeple, a stunted spire dating from 1037. It is all that is left of St Mary's church, which was burned down in 1793 during the revels of a notorious body known as the Hell Fire Club. On the opposite side, at the corner of High Street, stood the ancient tolbooth, or prison, a turreted building, five storeys high, with a fine Jacobean crown tower. The only remnant of the structure is the tower known as the Cross Steeple.

Although almost all the old public buildings of Glasgow have been swept away, the cathedral remains in excellent preservation. It stands in the north-eastern quarter of the city at a height of 104 ft. above the level of the Clyde. It is a ^{St Mungo's} beautiful example of Early English work, impressive ^{Cathedral} in its simplicity. Its form is that of a Latin cross, with imperfect transepts. Its length from east to west is 319 ft., and its width 63 ft.; the height of the choir is 93 ft., and of the nave 85 ft. At the centre rises a fine tower, with a short octagonal spire, 225 ft. high. The choir, locally known as the High Church, serves as one of the city churches, and the extreme east end of it forms the Lady chapel. The rich western doorway is French in design but English in details. The chapter-house projects from the north-eastern corner and somewhat mars the harmony of the effect. It was built in the 15th century and has a groined roof supported by a pillar 20 ft. high. Many citizens have contributed towards filling the windows with stained glass, executed at Munich, the government providing the eastern

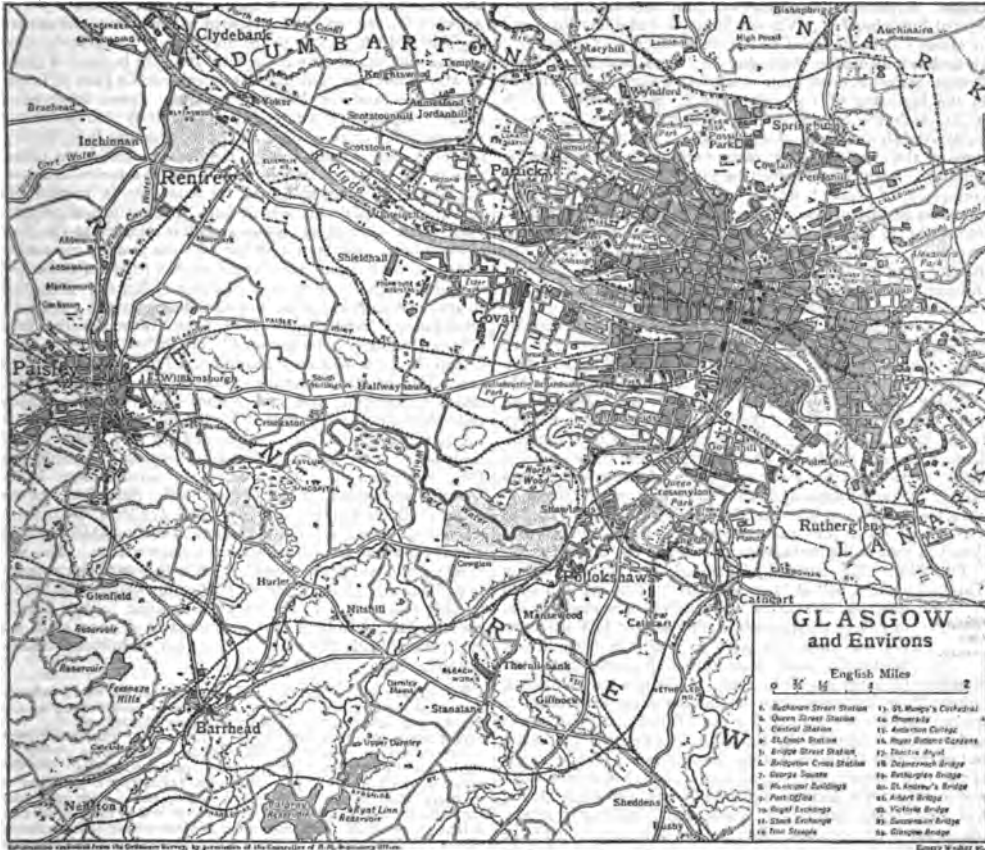

window in recognition of their enterprise. The crypt beneath the choir is not the least remarkable part of the edifice, being without equal in Scotland. It is borne on 65 pillars and lighted by 41 windows. The sculpture of the capitals of the columns and bosses of the groined vaulting is exquisite and the whole is in excellent preservation. Strictly speaking, it is not a crypt, but a lower church adapted to the sloping ground of the right bank of the Molendinar burn. The dripping aisle is so named from the constant dropping of water from the roof. St Mungo's Well in the south-eastern corner was considered to possess therapeutic virtues, and in the crypt a recumbent effigy, headless and handless, is faithfully accepted as the tomb of Kentigern. The cathedral contains few monuments of exceptional merit, but the surrounding graveyard is almost completely paved with tombstones. In 1115 an investigation was ordered by David, prince of Cumbria, into the lands and churches belonging to the bishopric, and from the deed then drawn up it is clear that at that date a cathedral had already been endowed. When David ascended the throne in 1124 he gave to the see of Glasgow the lands of Partick, besides restoring many possessions of which it had been deprived. Jocelin (d. 1199), made bishop in 1174, was the first great bishop, and is memorable for his efforts to replace the cathedral built in 1136 by Bishop John Achais, which had been destroyed by fire. The crypt is his work, and he began the choir, Lady chapel, and central tower. The new structure

was sufficiently advanced to be dedicated in 1197. Other famous bishops were Robert Wishart (d. 1316), appointed in 1272, who was among the first to join in the revolt of Wallace, and received Robert Bruce when he lay under the ban of the church for the murder of Comyn; John Cameron (d. 1446), appointed in 1428, under whom the building as it stands was completed; and William Turnbull (d. 1454), appointed in 1447, who founded the university in 1450. James Beaton or Bethune (1517-1603) was the last Roman Catholic archbishop. He fled to France at the reformation in 1560, and took with him the treasures and records of the see, including the Red Book of Glasgow dating from the reign of Robert III. The documents were deposited in the Scots College in Paris, were sent at the outbreak of the Revolution for safety to St Omer, and were never recovered. This loss explains the paucity of the earlier annals of the city. The zeal of the Reformers led them to threaten to mutilate the cathedral, but the building was saved by the prompt action of the craftsmen, who mustered in force and dispersed the fanatics. Excepting the cathedral, none of the Glasgow churches possesses historical interest; and, speaking generally, it is only the buildings that have been erected since the beginning of the 19th century that have pronounced architectural merit. This was due largely to the long survival of the severe sentiment of the Covenanters, who discouraged, if they did not actually forbid, the raising of temples of beautiful

design. Representative examples of later work are found in the United Free churches in Vincent Street, in Caledonia Road and at Queen's Park, designed by Alexander Thomson (1817-1875), an architect of distinct originality; St George's church, in West George Street, a remarkable work by William Stark, erected in the beginning of the 19th century, St Andrew's church in St Andrew's Square off the Saltmarket, modelled after St Martin's-in-the-Fields, London, with a fine Roman portico, some of the older parish churches, such as St Enoch's, dating from 1780, with a good spire (the saint's name is said to be a corruption of Tanew, mother of Kentigern); the episcopal church of St Mary (1870), in Great Western Road, by Sir G. G. Scott; the Roman Catholic cathedral of St Andrew, on the river-bank between Victoria and Broomielaw bridges; the Barony church, replacing the older kirk in which Norman Macleod ministered; and several admirable structures, well situated, on the eastern confines of Kelvingrove Park.

The principal burying-ground is the Necropolis, occupying Fir Park, a hill about 300 ft. high in the northern part of the city. It provides a not inappropriate background to the cathedral, from which it is approached by a bridge, known as the "Bride of Sighs," over the Molendinar ravine. The ground, which once formed portion of the estate of Wester Craigs, belongs to the Merchants' House, which purchased it in 1650 from Sir Ludovic Stewart of Minto. A Doric column to the memory of Knox, surmounted by a colossal statue of the reformer, was erected by public subscription on the crown of the height in 1824, and a few years later the idea arose of utilizing the land as a cemetery. The Jews have reserved for their own people a detached area in the north-western corner of the cemetery.

Education.—The university, founded in 1450 by Bishop Turnbull under a bull of Pope Nicholas V., survived in its old quarters till far in the 19th century. The *paedagogium*, or college of arts, was at first housed in Rottenrow, but was moved in 1460 to a site in High Street, where Sir James Hamilton of Cadzow, first Lord Hamilton (d. 1479), gave it four acres of land and some buildings. Queen Mary bestowed upon it thirteen acres of contiguous ground, and her son granted it a new charter and enlarged the endowments. Prior to the Revolution its fortunes fluctuated, but in the 18th century it became very famous. By the middle of the 19th century, however, its surroundings had deteriorated, and in 1860 it was decided to rebuild it elsewhere. The ground had enormously increased in value and a railway company purchased it for £100,000. In 1864 the university bought the Gilmore Hill estate for £65,000, the adjacent property of Down Hill for £16,000 and the property of Clayslaps for £17,400. Sir G. G. Scott was appointed architect and selected as the site of the university buildings the ridge of Gilmore Hill—the finest situation in Glasgow. The design is Early English with a suggestion in parts of the Scots-French style of a much later period. The main structure is 540 ft. long and 300 ft. broad. The principal front faces southwards and consists of a lofty central tower with spire and corner blocks with turrets, between which are buildings of lower height. Behind the tower lies the Bute hall, built on cloisters, binding together the various departments and smaller halls, and dividing the massive edifice into an eastern and western quadrangle, on two sides of which are ranged the class-rooms in two storeys. The northern façade comprises two corner blocks, besides the museum, the library and, in the centre, the students' reading-room on one floor and the Hunterian museum on the floor above. On the south the ground falls in terraces towards Kelvingrove Park and the Kelvin. On the west, but apart from the main structure, stand the houses of the principal and professors. The foundation stone was laid in 1868 and the opening ceremony was held in 1870. The total cost of the university buildings amounted to £500,000, towards which government contributed £120,000 and public subscription £250,000. The third marquis of Bute (1847-1900) gave £40,000 to provide the Bute or common hall, a room of fine proportions fitted in Gothic style and divided by a beautiful Gothic screen from the Randolph hall, named

after another benefactor, Charles Randolph (1809-1876), a native of Stirling, who had prospered as shipbuilder and marine engineer and left £60,000 to the university. The graceful spire surmounting the tower was provided from the bequest of £5000 by Mr A. Cunningham, deputy town-clerk, and Dr John M'Intyre erected the Students' Union at a cost of £5000, while other donors completed the equipment so generously that the senate was enabled to carry on its work, for the first time in its history, in almost ideal circumstances. The library includes the collection of Sir William Hamilton, and the Hunterian museum, bequeathed by William Hunter, the anatomist, is particularly rich in coins, medals, black-letter books and anatomical preparations. The observatory on Down Hill is attached to the chair of astronomy. An interesting link with the past are the exhibitions founded by John Snell (1629-1679), a native of Colmonell in Ayrshire, for the purpose of enabling students of distinction to continue their career at Balliol College, Oxford. Amongst distinguished exhibitors have been Adam Smith, John Gibson Lockhart, John Wilson ("Christopher North"), Archbishop Tait, Sir William Hamilton and Professor Shairp. The curriculum of the university embraces the faculties of arts, divinity, medicine, law and science. The governing body includes the chancellor, elected for life by the general council, the principal, also elected for life, and the lord rector elected triennially by the students voting in "nations" according to their birthplace (*Glottiana*, natives of Lanarkshire; *Transforthana*, of Scotland north of the Forth; *Rothsiana*, of the shires of Bute, Renfrew and Ayr; and *Loudonia*, all others). There are a large number of well-endowed chairs and lectureships and the normal number of students exceeds 2000. The universities of Glasgow and Aberdeen unite to return one member to parliament. Queen Margaret College for women, established in 1883, occupies a handsome building close to the botanic gardens, has an endowment of upwards of £25,000, and was incorporated with the university in 1893. Muirhead College is another institution for women.

Elementary instruction is supplied at numerous board schools. Higher, secondary and technical education is provided at several well-known institutions. There are two educational endowments boards which apply a revenue of about £10,000 a year mainly to the foundation of bursaries. Anderson College in George Street perpetuates the memory of its founder, John Anderson (1726-1796), professor of natural philosophy in the university, who opened a class in physics for working men, which he conducted to the end of his life. By his will he provided for an institution for the instruction of artisans and others unable to attend the university. The college which bears his name began in 1796 with lectures on natural philosophy and chemistry by Thomas Garnett (1766-1802). Two years later mathematics and geography were added. In 1799 Dr George Birkbeck (1776-1841) succeeded Garnett and began those lectures on mechanics and applied science which, continued elsewhere, ultimately led to the foundation of mechanics' institutes in many towns. In later years the college was further endowed and its curriculum enlarged by the inclusion of literature and languages, but ultimately it was determined to limit the scope of its work to medicine (comprising, however, physics, chemistry and botany also). The lectures of its medical school, incorporated in 1887 and situated near the Western Infirmary, are accepted by Glasgow and other universities. The Glasgow and West of Scotland Technical College, formed in 1886 out of a combination of the arts side of Anderson College, the College of Science and Arts, Allan Glen's Institution and the Atkinson Institution, is subsidized by the corporation and the endowments board, and is especially concerned with students desirous of following an industrial career. St Mungo's College, which has developed from an extra-mural school in connexion with the Royal Infirmary, was incorporated in 1889, with faculties of medicine and law. The United Free Church College, finely situated near Kelvingrove Park, the School of Art and Design, and the normal schools for the training of teachers, are institutions with distinctly specialized objects.

The High school in Elmbank is the successor of the grammar school (long housed in John Street) which was founded in the 14th century as an appanage of the cathedral. It was placed under the jurisdiction of the school board in 1873. Other secondary schools include Glasgow Academy, Kelvinside Academy and the girls' and boys' schools endowed by the Hutcheson trust. Several of the schools under the board are furnished with secondary departments or equipped as science schools, and the Roman Catholics maintain elementary schools and advanced academies.

Art Galleries, Libraries and Museums.—Glasgow merchants and

manufacturers alike have been constant patrons of art, and their liberality may have had some influence on the younger painters who, towards the close of the 19th century, broke away from tradition and, stimulated by training in the studios of Paris, became known as the "Glasgow school." The art gallery and museum in Kelvingrove Park, which was built at a cost of £250,000 (partly derived from the profits of the exhibitions held in the park in 1888 and 1901), is exceptionally well appointed. The collection originated in 1854 in the purchase of the works of art belonging to Archibald M'Lellan, and was supplemented from time to time by numerous bequests of important pictures. It was housed for many years in the Corporation galleries in Sauchiehall Street. The Institute of Fine Arts, in Sauchiehall Street, is mostly devoted to periodical exhibitions of modern art. There are also pictures on exhibition in the People's Palace on Glasgow Green, which was built by the corporation in 1898 and combines an art gallery and museum with a conservatory and winter garden, and in the museum at Camphill, situated within the bounds of Queen's Park. The library and Hunterian museum in the university are mostly reserved for the use of students. The faculty of procurators possess a valuable library which is housed in their hall, an Italian Renaissance building, in West George Street. In Bath Street there are the Mechanics and the Philosophical Society's libraries, and the Physicians' is in St Vincent Street. Miller Street contains the headquarters of the public libraries. The premises once occupied by the water commission have been converted to house the Mitchell library, which grew out of a bequest of £70,000 by Stephen Mitchell, largely reinforced by further gifts of libraries and funds, and now contains upwards of 100,000 volumes. It is governed by the city council and has been in use since 1877. Another building in this street accommodates both the Stirling and Baillie libraries. The Stirling, with some 40,000 volumes, is particularly rich in tracts of the 16th and 17th centuries, and the Baillie was endowed by George Baillie, a solicitor who, in 1863, gave £18,000 for educational objects. The Athenaeum in St George's Place, an institution largely concerned with evening classes in various subjects, contains an excellent library and reading-room.

Charities.—The old Royal Infirmary, designed by Robert Adam and opened in 1794, adjoining the cathedral, occupies the site of the archiepiscopal palace, the last portion of which was removed towards the close of the 18th century. The chief architectural feature of the infirmary is the central dome forming the roof of the operating theatre. On the northern side are the buildings of the medical school attached to the institution. The new infirmary commemorates the Diamond Jubilee of Queen Victoria. A little farther north, in Castle Street, is the blind asylum. The Western Infirmary is to some extent used for the purposes of clinical instruction in connexion with the university, to which it stands in immediate proximity. Near it is the Royal hospital for sick children. To the south of Queen's Park is Victoria Infirmary, and close to it the deaf and dumb institution. On the bank of the river, not far from the south-eastern boundary of the city, is the Belvedere hospital for infectious diseases, and at Ruchill, in the north, is another hospital of the same character opened in 1900. The Royal asylum at Gartnavel is situated near Jordanhill station, and the District asylum at Gartloch (with a branch at West Muckroft) lies in the parish of Cadder beyond the north-eastern boundary. There are numerous hospitals exclusively devoted to the treatment of special diseases, and several nursing institutions and homes. Hutcheson's Hospital, designed by David Hamilton and adorned with statues of the founders, is situated in Ingram Street, and by the increase in the value of its lands has become a very wealthy body. George Hutcheson (1580-1639), a lawyer in the Troogate near the tolbooth, who afterwards lived in the Bishop's castle, which stood close to the spot where the Kelvin enters the Clyde, founded the hospital for poor old men. His brother Thomas (1639-1641) established in connexion with it a school for the lodging and education of orphan boys, the sons of burghers. The trust, through the growth of its funds, has been enabled to extend its educational scope and to subsidize schools apart from the charity.

Monuments.—Most of the statues have been erected in George Square. They are grouped around a fluted pillar 80 ft. high, surmounted by a colossal statue of Sir Walter Scott by John Ritchie (1809-1850), erected in 1837, and include Queen Victoria and the Prince Consort (both equestrian) by Baron Marochetti; James Watt by Chantrey; Sir Robert Peel, Thomas Campbell the poet, who was born in Glasgow, and David Livingstone, all by John Moesman; Sir John Moore, a native of Glasgow, by Flaxman, erected in 1819; James Oswald, the first member returned to parliament for the city after the Reform Act of 1832; Lord Clyde (Sir Colin Campbell), also a native, by Foley, erected in 1868; Dr Thomas Graham, master of the mint, another native, by Brodie; Robert Burns by G. E. Ewing, erected in 1877, subscribed for in shillings by the working men of Scotland; and William Ewart Gladstone by Hans Thornycroft, unveiled by Lord Rosebery in 1902. In front of the Royal Exchange stands the equestrian monument of the duke of Wellington. In Cathedral Square are the statues of Norman Macleod, James White and James Arthur, and in front of the Royal Infirmary is that of Sir James Lumsden, lord provost and benefactor. Nelson is commemorated by an obelisk 143 ft. high on the Green, which was erected in 1806 and is said to be a copy of that in the Piazza del Popolo at Rome. One of the most familiar statues is the

equestrian figure of William III. in the Troogate, which was presented to the town in 1735 by James Macrae (1677-1744), a poor Ayrshire lad who had amassed a fortune in India, where he was governor of Madras from 1725 to 1730.

Recreations.—Of the theatres the chief are the King's in Bath Street, the Royal and the Grand in Cowcaddens, the Royalty and Gaiety in Sauchiehall Street, and the Princess's in Main Street. Variety theatres, headed by the Empire in Sauchiehall Street, are found in various parts of the town. There is a circus in Waterloo Street, a hippodrome in Sauchiehall Street and a zoological garden in New City Road. The principal concert halls are the great hall of the St Andrew's Halls, a group of rooms belonging to the corporation; the City Hall in Candleriggs, the People's Palace on the Green, and Queen's Rooms close to Kelvingrove Park. Throughout winter enormous crowds throng the football grounds of the Queen's Park, the leading amateur club, and the Celtic, the Rangers, the Third Lanark and other prominent professional clubs.

Parks and Open Spaces.—The oldest open space is the Green (140 acres), on the right bank of the river, adjoining a densely-populated district. It once extended farther west, but a portion was built over at a time when public rights were not vigilantly guarded. It is a favourite area for popular demonstrations, and sections have been reserved for recreation or laid out in flower-beds. Kelvingrove Park, in the west end, has exceptional advantages, for the Kelvin burn flows through it and the ground is naturally terraced, while the situation is beautified by the adjoining Gilmore Hill with the university on its summit. The park was laid out under the direction of Sir Joseph Paxton, and contains the Stewart fountain, erected to commemorate the labours of Lord Provost Stewart and his colleagues in the promotion of the Loch Katrine water-scheme. The other parks on the right bank are, in the north, Ruchill (53 acres), acquired in 1891, and Springburn (53½ acres), acquired in 1892, and, in the east, Alexandra Park (120 acres), in which is laid down a nine-hole golf-course, and Tollcross (82½ acres), beyond the municipal boundary, acquired in 1897. On the left bank Queen's Park (130 acres), occupying a commanding site, was laid out by Sir Joseph Paxton, and considerably enlarged in 1864 by the enclosure of the grounds of Camphill. The other southern parks are Richmond (44 acres), acquired in 1898, and named after Lord Provost Sir David Richmond, who opened it in 1899; Maxwell, which was taken over on the annexation of Pollokshields in 1891; Bellahouston (176 acres), acquired in 1895; and Cathkin Braes (50 acres), 3¼ m. beyond the south-eastern boundary, presented to the city in 1886 by James Dick, a manufacturer, containing "Queen Mary's stone," a point which commands a view of the lower valley of the Clyde. In the north-western district of the town 40 acres between Great Western Road and the Kelvin are devoted to the Royal Botanic Gardens, which became public property in 1841. They are beautifully laid out, and contain a great range of hothouses. The gardens owed much to Sir William Hooker, who was regius professor of botany in Glasgow University before his appointment to the directorship of Kew Gardens.

Communications.—The North British railway terminus is situated in Queen Street, and consists of a high-level station (main line) and a low-level station, used in connexion with the City & District line, largely underground, serving the northern side of the town, opened in 1886. The Great Northern and North-Eastern railways use the high-level line of the N.B.R., the three companies forming the East Coast Joint Service. The central terminus of the Caledonian railway in Gordon Street, served by the West Coast system (in which the London & North-Western railway shares), also comprises a high-level station for the main line traffic and a low-level station for the Caledonian District railway, completed in 1886 and made circular for the southern side and suburbs in 1894, and also for the connexion between Maryhill and Rutherglen, which is mostly underground. Both the underground lines communicate with certain branches of the main line, either directly or by change of carriage. The older terminus of the Caledonian railway in Buchanan Street now takes the northern and eastern traffic. The terminus of the Glasgow & South-Western railway company in St Enoch Square serves the country indicated in its title, and also gives the Midland railway of England access to the west coast and Glasgow. The Glasgow Subway—an underground cable passenger line, 6½ m. long, worked in two tunnels and passing below the Clyde twice—was opened in 1896. Since no more bridge-building will be sanctioned west of the railway bridge at the Broomielaw, there are at certain points steam ferry boats or floating bridges for conveying vehicles across the harbour, and at Stobcross there is a subway for foot and wheeled traffic. Steamers, carrying both goods and passengers, constantly leave the Broomielaw quay for the piers and ports on the river and frith, and the islands and sea lochs of Argyllshire. The city is admirably served by tramways which penetrate every populous district and cross the river by Glasgow and Albert bridges.

Trade.—Natural causes, such as proximity to the richest field of coal and ironstone in Scotland and the vicinity of hill streams of pure water, account for much of the great development of trade in Glasgow. It was in textiles that the city showed its earliest predominance, which, however, has not been maintained, owing, it is alleged, to the shortage of female labour. Several cotton mills are still worked, but the leading feature in the trade has always been the manufacture

of such light textures as plain, striped and figured muslins, gingham and fancy fabrics. Thread is made on a considerable scale, but jute and silk are of comparatively little importance. The principal varieties of carpets are woven. Some factories are exclusively devoted to the making of lace curtains. The allied industries of bleaching, printing and dyeing, on the other hand, have never declined. The use of chlorine in bleaching was first introduced in Great Britain at Glasgow in 1787, on the suggestion of James Watt, whose father-in-law was a bleacher; and it was a Glasgow bleacher, Charles Tennant, who first discovered and made bleaching powder (chloride of lime). Turkey-red dyeing was begun at Glasgow by David Dale and George M'Intosh, and the colour was long known locally as Dale's red. A large quantity of grey cloth continues to be sent from Lancashire and other mills to be bleached and printed in Scottish works. These industries gave a powerful impetus to the manufacture of chemicals, and the works at St Rollox developed rapidly. Among prominent chemical industries are to be reckoned the alkali trades—including soda, bleaching powder and soap-making—the preparation of alum and prussiates of potash, bichromate of potash, white lead and other pigments, dynamite and gunpowder. Glass-making and paper-making are also carried on, and there are several breweries and distilleries, besides factories for the making of aerated waters, starch, dextrine and matches. Many miscellaneous trades flourish, such as clothing, confectionery, cabinet-making, bread and biscuit making, boot and shoe making, flour mills and saw mills, pottery and indiarubber. Since the days of the brothers Robert Foulis (1705-1776) and Andrew Foulis (1712-1775), printing, both letterpress and colour, has been identified with Glasgow, though in a lesser degree than with Edinburgh. The tobacco trade still flourishes, though much lessened. But the great industry is iron-founding. The discovery of the value of blackband ironstone, till then regarded as useless "wild coal," by David Mushet (1772-1847), and Neilson's invention of the hot-air blast threw the control of the Scottish iron trade into the hands of Glasgow ironmasters, although the furnaces themselves were mostly erected in Lanarkshire and Ayrshire. The expansion of the industry was such that, in 1859, one-third of the total output in the United Kingdom was Scottish. During the following years, however, the trade seemed to have lost its elasticity, the annual production averaging about one million tons of pig-iron. Mild steel is manufactured extensively, and some crucible cast steel is made. In addition to brass foundries there are works for the extraction of copper and the smelting of lead and zinc. With such resources every branch of engineering is well represented. Locomotive engines are built for every country where railways are employed, and all kinds of builder's ironwork is forged in enormous quantities, and the sewing-machine factories in the neighbourhood are important. Boiler-making and marine engine works, in many cases in direct connexion with the shipbuilding yards, are numerous. Shipbuilding, indeed, is the greatest of the industries of Glasgow, and in some years more than half of the total tonnage in the United Kingdom has been launched on the Clyde, the yards of which extend from the harbour to Dumbarton on one side and Greenock on the other side of the river and firth. Excepting a trifling proportion of wooden ships, the Clyde-built vessels are of iron and steel, the trade having owed its immense expansion to the prompt adoption of this material. Every variety of craft is turned out, from battleships and great liners to dredging-plant and hopper barges.

The Port.—The harbour extends from Glasgow Bridge to the point where the Kelvin joins the Clyde, and occupies 206 acres. For the most part it is lined by quays and wharves, which have a total length of 8½ m., and from the harbour to the sea vessels drawing 26 ft. can go up or down on one tide. It is curious to remember that in the middle of the 18th century the river was fordable on foot at Dumbuck, 12 m. below Glasgow and 1½ m. S.E. of Dumbarton. Even within the limits of the present harbour Smeaton reported to the town council in 1740 that at Pointhouse ford, just east of the mouth of the Kelvin, the depth at low water was only 15 in. and at high water 39 in. The transformation effected within a century and a half is due to the energy and enterprise of the Clyde Navigation Trust. The earliest shipping-port of Glasgow was Irvine in Ayrshire, but lighterage was tedious and land carriage costly, and in 1658 the civic authorities endeavoured to purchase a site for a spacious harbour at Dumbarton. Being thwarted by the magistrates of that burgh, however, in 1662 they secured 13 acres on the southern bank at a spot some 2 m. above Greenock, which became known as Port Glasgow, where they built harbours and constructed the first graving dock in Scotland. Sixteen years later the Broomielaw quay was built, but it was not until the tobacco merchants appreciated the necessity of bringing their wares into the heart of the city that serious consideration was paid to schemes for deepening the waterway. Smeaton's suggestion of a lock and dam 4 m. below the Broomielaw was happily not accepted. In 1768 John Golborne advised the narrowing of the river and the increasing of the scour by the construction of rubble jetties and the dredging of sandbanks and shoals. After James Watt's report in 1769 on the ford at Dumbuck, Golborne succeeded in 1775 in deepening the ford to 6 ft. at low water with a width of 300 ft. By Rennie's advice in 1799, following up Golborne's recommendation, as many as 200 jetties were built between Glasgow and Bowling, some old ones were

shortened and low rubble walls carried from point to point of the jetties, and thus the channel was made more uniform and much land reclaimed. By 1836 there was a depth of 7 or 8 ft. at the Broomielaw at low water, and in 1840 the whole duty of improving the navigation was devolved upon the Navigation Trust. Steam dredgers were kept constantly at work, shoals were removed and rocks blasted away. Two million cubic yards of matter are lifted every year and dumped in Loch Long. By 1900 the channel had been deepened to a minimum of 22 ft., and, as already indicated, the largest vessels make the open sea in one tide, whereas in 1840 it took ships drawing only 15 ft. two and even three tides to reach the sea. The debt of the Trust amounts to £6,000,000, and the annual revenue to £450,000. Long before these great results had been achieved, however, the shipping trade had been revolutionized by the application of steam to navigation, and later by the use of iron for wood in shipbuilding, in both respects enormously enhancing the industry and commerce of Glasgow. From 1812 to 1820 Henry Bell's "Comet," 30 tons, driven by an engine of 3 horse-power, plied between Glasgow and Greenock, until she was wrecked, being the first steamer to run regularly on any river in the Old World. Thus since the appearance of that primitive vessel phenomenal changes had taken place on the Clyde. When the quays and wharves ceased to be able to accommodate the growing traffic, the construction of docks became imperative. In 1867 Kingston Dock on the south side, of 5½ acres, was opened, but soon proved inadequate, and in 1880 Queen's Dock (two basins) at Stobcross, on the north side, of 30 acres, was completed. Although this could accommodate one million tons of shipping, more dock space was speedily called for, and in 1897 Prince's Dock (three basins) on the opposite side, of 73 acres, was opened, fully equipped with hydraulic and steam cranes and all the other latest appliances. There are, besides, three graving docks, the longest of which (880 ft.) can be made at will into two docks of 417 ft. and 457 ft. in length. The Caledonian and Glasgow & South-Western railways have access to the harbour for goods and minerals at Terminus Quay to the west of Kingston Dock, and a mineral dock has been constructed by the Trust at Clydebank, about 3½ m. below the harbour. The shipping attains to colossal proportions. The imports consist chiefly of flour, fruit, timber, iron ore, live stock and wheat; and the exports principally of cotton manufactures, manufactured iron and steel, machinery, whisky, cotton yarn, linen fabrics, coal, jute, jam and foods, and woollen manufactures.

Government.—By the Local Government (Scotland) Act 1889 the city was placed entirely in the county of Lanark, the districts then transferred having previously belonged to the shires of Dumbarton and Renfrew. In 1891 the boundaries were enlarged to include six suburban burghs and a number of suburban districts, the area being increased from 6111 acres to 11,861 acres. The total area of the city and the contermineous burghs of Govan, Partick and Kinning Park—which, though they successfully resisted annexation in 1891, are practically part of the city—is 15,659 acres. The extreme length from north to south and from east to west is about 5 m. each way, and the circumference measures 27 m. In 1893 the municipal burgh was constituted a county of a city. Glasgow is governed by a corporation consisting of 77 members, including 14 bailies and the lord provost. In 1895 all the powers which the town council exercised as police commissioners and trustees for parks, markets, water and the like were consolidated and conferred upon the corporation. Three years later the two parish councils of the city and burgh, which administered the poor law over the greater part of the city north of the Clyde, were amalgamated as the parish council of Glasgow, with 31 members. As a county of a city Glasgow has a lieutenantcy (successive lords provost holding the office) and a court of quarter sessions, which is the appeal court from the magistrates sitting as licensing authority. Under the corporation municipal ownership has reached a remarkable development, the corporation owning the supplies of water, gas and electric power, tramways and municipal lodging-houses. The enterprise of the corporation has brought its work prominently into notice, not only in the United Kingdom, but in the United States of America and elsewhere. In 1859 water was conveyed by aqueducts and tunnels from Loch Katrine (364 ft. above sea-level, giving a pressure of 70 or 80 ft. above the highest point in the city) to the reservoir at Mugdock (with a capacity of 500,000,000 gallons), a distance of 27 m., whence after filtration it was distributed by pipes to Glasgow, a further distance of 7 m., or 34 m. in all. During the next quarter of a century it became evident that this supply would require to be augmented, and powers were accordingly obtained in 1895 to raise Loch Katrine 5 ft. and to connect with it by tunnel Loch Arkit (455 ft. above the sea), with storage for 2,050,000,000 gallons, the two lochs together possessing a capacity of twelve thousand million gallons. The entire works between the loch and the city were duplicated over a distance of 23½ m., and an additional reservoir, holding 694,000,000 gallons, was constructed, increasing the supply held in reserve from 12½ days' to 30½ days'. In 1909 the building of a dam was undertaken 1½ m. west of the lower end of Loch Arkit, designed to create a sheet of water 2½ m. long and to increase the water-supply of the city by ten million gallons a day. The water committee supplies hydraulic power to manufacturers and merchants. In 1869 the corporation acquired the gasworks, the productive capacity

of which exceeds 70 million cub. ft. a day. In 1893 the supply of electric light was also undertaken, and since that date the city has been partly lighted by electricity. The corporation also laid down the tramways, which were leased by a company for twenty-three years at a rental of £150 a mile per annum. When the lease expired in 1894 the town council took over the working of the cars, substituting overhead electric traction for horse-power. One of the most difficult problems that the corporation has had to deal with was the housing of the poor. By the lapse of time and the congestion of population, certain quarters of the city, in old Glasgow especially, had become slums and rookeries of the worst description. The condition of the town was rapidly growing into a byword, when the municipality obtained parliamentary powers in 1866 enabling it to condemn for purchase over-crowded districts, to borrow money and levy rates. The scheme of reform contemplated the demolition of 10,000 insanitary dwellings occupied by 50,000 persons, but the corporation was required to provide accommodation for the displaced whenever the numbers exceeded 500. In point of fact they never needed to build, as private enterprise more than kept pace with the operations of the improvement. The work was carried out promptly and effectually, and when the act expired in 1881 whole localities had been recreated and nearly 40,000 persons properly housed. Under the amending act of 1881 the corporation began in 1888 to build tenement houses in which the poor could rent one or more rooms at the most moderate rentals; lodging-houses for men and women followed, and in 1896 a home was erected for the accommodation of families in certain circumstances. The powers of the improvement trustees were practically exhausted in 1896, when it appeared that during twenty-nine years £1,955,550 had been spent in buying and improving land and buildings, and £231,500 in building tenements and lodging-houses; while, on the other side, ground had been sold for £1,072,000, and the trustees owned heritable property valued at £692,000, showing a deficiency of £423,050. Assessment of ratepayers for the purposes of the trust had yielded £593,000, and it was estimated that these operations, beneficial to the city in a variety of ways, had cost the citizens £24,000 a year. In 1897 an act was obtained for dealing in similar fashion with insanitary and congested areas in the centre of the city, and on the south side of the river, and for acquiring not more than 25 acres of land, within or without the city, for dwellings for the poorest classes. Along with these later improvements the drainage system was entirely remodelled, the area being divided into three sections, each distinct, with separate works for the disposal of its own sewage. One section (authorized in 1891 and doubled in 1901) comprises 11 sq. m.—one-half within the city north of the river, and the other in the district in Lanarkshire—with works at Dalmarnock; another section (authorized in 1896) includes the area on the north bank not provided for in 1891, as well as the burghs of Partick and Clydebank and intervening portions of the shires of Renfrew and Dumbarton, the total area consisting of 14 sq. m., with works at Dalnair, 7 m. below Glasgow; and the third section (authorized in 1898) embraces the whole municipal area on the south side of the river, the burghs of Rutherglen, Pollokshaws, Kinning Park and Govan, and certain districts in the counties of Renfrew and Lanark—14 sq. m. in all, which may be extended by the inclusion of the burghs of Renfrew and Paisley—with works at Braehead, 1 m. east of Renfrew. Among other works in which it has interests there may be mentioned its representation on the board of the Clyde Navigation Trust and the governing body of the West of Scotland Technical College. In respect of parliamentary representation the Reform Act of 1832 gave two members to Glasgow, a third was added in 1868 (though each elector had only two votes), and in 1885 the city was split up into seven divisions, each returning one member.

Population.—Throughout the 19th century the population grew prodigiously. Only 77,385 in 1801, it was nearly doubled in twenty years, being 147,043 in 1821, already outstripping Edinburgh. It had become 395,503 in 1861, and in 1881 it was 511,415. In 1891, prior to extension of the boundary, it was 565,839, and, after extension, 653,198, and in 1901 it stood at 761,709. The birth-rate averages 33, and the death-rate 21 per 1000, but the mortality before the city improvement scheme was carried out was as high as 33 per 1000. Owing to its being convenient of access from the Highlands, a very considerable number of Gaelic-speaking persons live in Glasgow, while the great industries attract an enormous number of persons from other parts of Scotland. The valuation of the city, which in 1878-1879 was £3,420,697, now exceeds £5,000,000.

History.—There are several theories as to the origin of the name of Glasgow. One holds that it comes from Gaelic words meaning "dark glen," descriptive of the narrow ravine through which the Molendinar flowed to the Clyde. But the more generally accepted version is that the word is the Celtic *Cleschu*, afterwards written *Glesco* or *Glasghu*, meaning "dear green spot" (*glas*, green; *cu* or *ghu*, dear), which is supposed to have been the name of the settlement that Kentigern found here when he came to convert the Britons of Strathclyde. Mungo became the patron-saint of Glasgow, and the motto and arms

of the city are wholly identified with him—"Let Glasgow Flourish by the Preaching of the Word," usually shortened to "Let Glasgow Flourish." It is not till the 12th century, however, that the history of the city becomes clear. About 1178 William the Lion made the town by charter a burgh of barony, and gave it a market with freedom and customs. Amongst more or less isolated episodes of which record has been preserved may be mentioned the battle of the Bell o' the Brae, on the site of High Street, in which Wallace routed the English under Percy in 1300; the betrayal of Wallace to the English in 1305 in a barn situated, according to tradition, in Robroyston, just beyond the north-eastern boundary of the city; the ravages of the plague in 1350 and thirty years later; the regent Arran's siege, in 1544, of the bishop's castle, garrisoned by the earl of Glencairn, and the subsequent fight at the Butts (now the Gallowgate) when the terms of surrender were dishonoured, in which the regent's men gained the day. Most of the inhabitants were opposed to Queen Mary and many actively supported Murray in the battle of Langside—the site of which is now occupied by the Queen's Park—on the 13th of May 1568, in which she lost crown and kingdom. A memorial of the conflict was erected on the site in 1887. Under James VI. the town became a royal burgh in 1636, with freedom of the river from the Broomielaw to the Cloch. But the efforts to establish episcopacy aroused the fervent anti-prelatical sentiment of the people, who made common cause with the Covenanters to the end of their long struggle. Montrose mulcted the citizens heavily after the battle of Kilsyth in 1645, and three years later the provost and bailies were deposed for contumacy to their sovereign lord. Plague and famine devastated the town in 1649, and in 1652 a conflagration laid a third of the burgh in ashes. Even after the restoration its sufferings were acute. It was the headquarters of the Whiggamores of the west and its prisons were constantly filled with rebels for conscience' sake. The government scourged the townsfolk with an army of Highlanders, whose brutality only served to strengthen the resistance at the battles of Drumclog and Bothwell Brig. With the Union, hotly resented as it was at the time, the dawn of almost unbroken prosperity arose. By the treaty of Union Scottish ports were placed, in respect of trade, on the same footing as English ports, and the situation of Glasgow enabled it to acquire a full share of the ever-increasing Atlantic trade. Its commerce was already considerable and in population it was now the second town in Scotland. It enjoyed a practical monopoly of the sale of raw and refined sugars, had the right to distil spirits from molasses free of duty, dealt largely in cured herring and salmon, sent hides to English tanners and manufactured soap and linen. It challenged the supremacy of Bristol in the tobacco trade—fetching cargoes from Virginia, Maryland and Carolina in its own fleet—so that by 1772 its importations of tobacco amounted to more than half of the whole quantity brought into the United Kingdom. The tobacco merchants built handsome mansions and the town rapidly extended westwards. With the surplus profits new industries were created, which helped the city through the period of the American War. Most, though not all, of the manufactures in which Glasgow has always held a foremost place date from this period. It was in 1764 that James Watt succeeded in repairing a hitherto unworkable model of Newcomen's fire (steam) engine in his small workshop within the college precincts. Shipbuilding on a colossal scale and the enormous developments in the iron industries and engineering were practically the growth of the 19th century. The failure of the Western bank in 1857, the Civil War in the United States, the collapse of the City of Glasgow bank in 1878, among other disasters, involved heavy losses and distress, but recovery was always rapid.

AUTHORITIES.—J. Cleland, *Annals of Glasgow* (Glasgow, 1816); Duncan, *Literary History of Glasgow* (Glasgow, 1886); *Registrum Episcopatus Glasgow* (Maitland Club, 1843); Pagan, *Sketch of the History of Glasgow* (Glasgow, 1847); Sir J. D. Marwick, *Extracts from the Burgh Records of Glasgow* (Burgh Records Society); *Charters relating to Glasgow* (Glasgow, 1891); *River Clyde and Harbour of Glasgow* (Glasgow, 1898); *Glasgow Past and Present* (Glasgow, 1884); *Munimenta Universitatis Glasgow* (Maitland Club, 1854); J. Strang,

Glasgow and its Clubs (Glasgow, 1864); Reid ("Senex"), *Old Glasgow* (Glasgow, 1864); A. Macgeorge, *Old Glasgow* (Glasgow, 1888); Deas, *The River Clyde* (Glasgow, 1881); Gale, *Loch Katrine Water-works* (Glasgow, 1883); Mason, *Public and Private Libraries of Glasgow* (Glasgow, 1885); J. Nicol, *Vital, Social and Economic Statistics of Glasgow* (1881); J. B. Russell, *Life in One Room* (Glasgow, 1888); *Ticketed Houses* (Glasgow, 1889); T. Somerville, *George Square* (Glasgow, 1891); J. A. Kilpatrick, *Literary Landmarks of Glasgow* (Glasgow, 1898); J. K. McDowall, *People's History of Glasgow* (Glasgow, 1899); Sir J. Bell and J. Paton, *Glasgow: Its Municipal Organization and Administration* (Glasgow, 1896); Sir D. Richmond, *Notes on Municipal Work* (Glasgow, 1899); J. M. Lang, *Glasgow and the Barony* (Glasgow, 1895); *Old Glasgow* (Glasgow, 1895); J. H. Muir, *Glasgow in 1901*.

GLASITES, or SANDEMANIANS,¹ a Christian sect, founded in Scotland by John Glas (q.v.). It spread into England and America, but is now practically extinct. Glas dissented from the Westminster Confession only in his views as to the spiritual nature of the church and the functions of the civil magistrate. But his son-in-law Robert Sandeman added a distinctive doctrine as to the nature of faith which is thus stated on his tombstone: "That the bare death of Jesus Christ without a thought or deed on the part of man, is sufficient to present the chief of sinners spotless before God." In a series of letters to James Hervey, the author of *Theon* and *Aspasia*, he maintained that justifying faith is a simple assent to the divine testimony concerning Jesus Christ, differing in no way in its character from belief in any ordinary testimony. In their practice the Glasite churches aimed at a strict conformity with the primitive type of Christianity as understood by them. Each congregation had a plurality of elders, pastors or bishops, who were chosen according to what were believed to be the instructions of Paul, without regard to previous education or present occupation, and who enjoy a perfect equality in office. To have been married a second time disqualified for ordination, or for continued tenure of the office of bishop. In all the action of the church unanimity was considered to be necessary; if any member differed in opinion from the rest, he must either surrender his judgment to that of the church, or be shut out from its communion. To join in prayer with any one not a member of the denomination was regarded as unlawful, and even to eat or drink with one who had been excommunicated was held to be wrong. The Lord's Supper was observed weekly; and between forenoon and afternoon service every Sunday a love feast was held at which every member was required to be present. Mutual exhortation was practised at all the meetings for divine service, when any member who had the gift of speech (*χάρισμα*) was allowed to speak. The practice of washing one another's feet was at one time observed; and it was for a long time customary for each brother and sister to receive new members, on admission, with a holy kiss. "Things strangled" and "blood" were rigorously abstained from; the lot was regarded as sacred; the accumulation of wealth they held to be unscriptural and improper, and each member considered his property as liable to be called upon at any time to meet the wants of the poor and the necessities of the church. Churches of this order were founded in Paisley, Glasgow, Edinburgh, Leith, Arbroath, Montrose, Aberdeen, Dunkeld, Cupar, Galashiels, Liverpool and London, where Michael Faraday was long an elder. Their exclusiveness in practice, neglect of education for the ministry, and the antinomian tendency of their doctrine contributed to their dissolution. Many Glasites joined the general body of Scottish Congregationalists, and the sect may now be considered extinct. The last of the Sandemanian churches in America ceased to exist in 1890.

See James Ross, *History of Congregational Independency in Scotland* (Glasgow, 1900). (D.M.N.)

GLASS (O.E. *glas*, cf. Ger. *Glas*, perhaps derived from an old Teutonic root *glo-*, a variant of *glo-*, having the general sense of shining, cf. "glare," "glow"), a hard substance, usually transparent or translucent, which from a fluid condition at a high temperature has passed to a solid condition with sufficient rapidity to prevent the formation of visible crystals. There

¹The name Glasites or Glassites was generally used in Scotland; in England and America the name Sandemanians was more common.

are many varieties of glass differing widely in chemical composition and in physical qualities. Most varieties, however, have certain qualities in common. They pass through a viscous stage in cooling from a state of fluidity; they develop effects of colour when the glass mixtures are fused with certain metallic oxides; they are, when cold, bad conductors both of electricity and heat, they are easily fractured by a blow or shock and show a conchoidal fracture; they are but slightly affected by ordinary solvents, but are readily attacked by hydrofluoric acid.

The structure of glass has been the subject of repeated investigations. The theory most widely accepted at present is that glass is a quickly solidified solution, in which silica, silicates, borates, phosphates and aluminates may be either solvents or solutes, and metallic oxides and metals may be held either in solution or in suspension. Long experience has fixed the mixtures, so far as ordinary furnace temperatures are concerned, which produce the varieties of glass in common use. The essential materials of which these mixtures are made are, for English flint glass, sand, carbonate of potash and red lead; for plate and sheet glass, sand, carbonate or sulphate of soda and carbonate of lime; and for Bohemian glass, sand, carbonate of potash and carbonate of lime. It is convenient to treat these glasses as "normal" glasses, but they are in reality mixtures of silicates, and cannot rightly be regarded as definite chemical compounds or represented by definite chemical formulæ.

The knowledge of the chemistry of glass-making has been considerably widened by Dr F. O. Schott's experiments at the Jena glass-works. The commercial success of these works has demonstrated the value of pure science to manufactures.

The recent large increase in the number of varieties of glass has been chiefly due to developments in the manufacture of optical glass. Glasses possessing special qualities have been required, and have been supplied by the introduction of new combinations of materials. The range of the specific gravity of glasses from 2.5 to 5.0 illustrates the effect of modified compositions. In the same way glass can be rendered more or less fusible, and its stability can be increased both in relation to extremes of temperature and to the chemical action of solvents.

The fluidity of glass at a high temperature renders possible the processes of ladelling, pouring, casting and stirring. A mass of glass in a viscous state can be rolled with an iron roller like dough; can be rendered hollow by the pressure of the human breath or by compressed air; can be forced by air pressure, or by a mechanically driven plunger, to take the shape and impression of a mould; and can be almost indefinitely extended as solid rod or as hollow tube. So extensible is viscous glass that it can be drawn out into a filament sufficiently fine and elastic to be woven into a fabric.

Glasses are generally transparent but may be translucent or opaque. Semi-opacity due to crystallization may be induced in many glasses by maintaining them for a long period at a temperature just insufficient to cause fusion. In this way is produced the crystalline, devitrified material, known as Réaumur's porcelain. Semi-opacity and opacity are usually produced by the addition to the glass-mixtures of materials which will remain in suspension in the glass, such as oxide of tin, oxide of arsenic, phosphate of lime, cryolite or a mixture of felspar and fluorspar.

Little is known about the actual cause of colour in glass beyond the fact that certain materials added to and melted with certain glass-mixtures will in favourable circumstances produce effects of colour. The colouring agents are generally metallic oxides. The same oxide may produce different colours with different glass-mixtures, and different oxides of the same metal may produce different colours. The purple-blue of cobalt, the chrome green or yellow of chromium, the dichroic canary-colour of uranium and the violet of manganese, are constant. Ferrous oxide produces an olive green or a pale blue according to the glass with which it is mixed. Ferric oxide gives a yellow colour, but requires the presence of an oxidizing agent to prevent

reduction to the ferrous state. Lead gives a pale yellow colour. Silver oxide, mixed as a paint and spread on the surface of a piece of glass and heated, gives a permanent yellow stain. Finely divided vegetable charcoal added to a soda-lime glass gives a yellow colour. It has been suggested that the colour is due to sulphur, but the effect can be produced with a glass mixture containing no sulphur, free or combined, and by increasing the proportion of charcoal the intensity of the colour can be increased until it reaches black opacity. Selenites and selenates

give a pale pink or pinkish yellow. Tellurium appears to give a pale pink tint. Nickel with a potash-lead glass gives a violet colour, and a brown colour with a soda-lime glass. Copper gives a peacock-blue which becomes green if the proportion of the copper oxide is increased. If oxide of copper is added to a glass mixture containing a strong reducing agent, a glass is produced which when first taken from the crucible is colourless but on being re-heated develops a deep crimson-ruby colour. A similar glass, if its cooling is greatly retarded, produces throughout its substance minute crystals of metallic copper, and closely resembles the mineral called *avanturine*. There is also an intermediate stage in which the glass has a rusty red colour by reflected light, and a purple-blue colour by transmitted light. Glass containing gold behaves in almost precisely the same way, but the ruby glass is less crimson than copper ruby glass. J. E. C. Maxwell Garnett, who has studied the optical properties of these glasses, has suggested that the changes in colour correspond with changes effected in the structure of the metals as they pass gradually from solution in the glass to a state of crystallization.

Owing to impurities contained in the materials from which glasses are made, accidental coloration or discoloration is often produced. For this reason chemical agents are added to glass mixtures to remove or neutralize accidental colour. Ferrous oxide is the usual cause of discoloration. By converting ferrous into ferric oxide the green tint is changed to yellow, which is less noticeable. Oxidation may be effected by the addition to the glass mixture of a substance which gives up oxygen at a high temperature, such as manganese dioxide or arsenic trioxide. With the same object, red lead and saltpetre are used in the mixture for potash-lead glass. Manganese dioxide not only acts as a source of oxygen, but develops a pink tint in the glass, which is complementary to and neutralizes the green colour due to ferrous oxide.

Glass is a bad conductor of heat. When boiling water is poured into a glass vessel, the vessel frequently breaks, on account of the unequal expansion of the inner and outer layers. If in the process of glass manufacture a glass vessel is suddenly cooled, the constituent particles are unable to arrange themselves and the vessel remains in a state of extreme tension. The surface of the vessel may be hard, but the vessel is liable to fracture on receiving a trifling shock. M. de la Bastie's process of "toughening" glass consisted in dipping glass, raised to a temperature slightly below the melting-point, into molten tallow. The surface of the glass was hardened, but the inner layers remained in unstable equilibrium. Directly the crust was pierced the whole mass was shattered into minute fragments. In all branches of glass manufacture the process of "annealing," *i.e.* cooling the manufactured objects sufficiently slowly to allow the constituent particles to settle into a condition of equilibrium, is of vital importance. The desired result is obtained either by moving the manufactured goods gradually away from a constant

source of heat, or by placing them in a heated kiln and allowing the heat gradually to die out.

The furnaces (fig. 15) employed for melting glass are usually heated with gas on the "Siemens," or some similar system of regenerative heating. In the United States natural gas is used wherever it is available. In some English works coal is still employed for direct heating with various forms of mechanical stokers. Crude petroleum and a thin tar, resulting from the process of enriching water-gas with petroleum, have been used

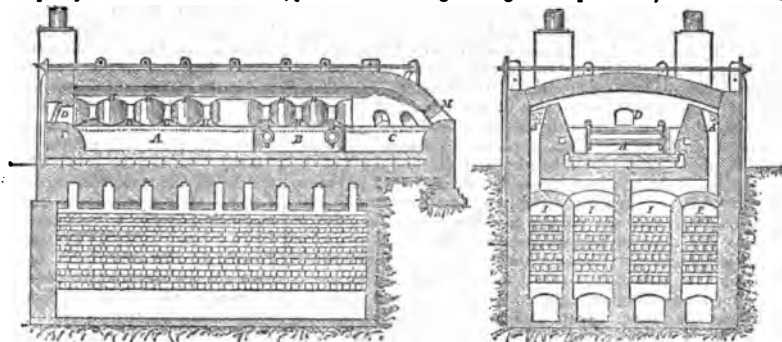
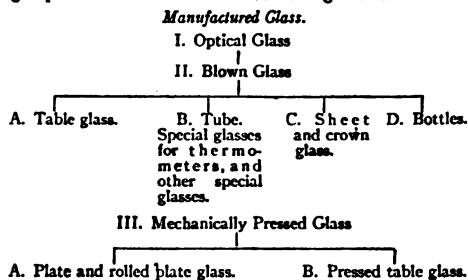

FIG. 15.—Siemens's Continuous Tank Furnace.

both with compressed air and with steam with considerable success. Electrical furnaces have not as yet been employed for ordinary glass-making on a commercial scale, but the electrical plants which have been erected for melting and moulding quartz suggest the possibility of electric heating being employed for the manufacture of glass. Many forms of apparatus have been tried for ascertaining the temperature of glass furnaces. It is usually essential that some parts of the apparatus shall be made to acquire a temperature identical with the temperature to be measured. Owing to the physical changes produced in the material exposed prolonged observations of temperature are impossible. In the Fery radiation pyrometer this difficulty is obviated, as the instrument may be placed at a considerable distance from the furnace. The radiation passing out from an opening in the furnace falls upon a concave mirror in a telescope and is focused upon a thermoelectric couple. The hotter the furnace the greater is the rise of temperature of the couple. The electromotive force thus generated is measured by a galvanometer, the scale of which is divided and figured so that the temperature may be directly read. (See THERMOMETRY.)

In dealing with the manufacture of glass it is convenient to group the various branches in the following manner:



I. OPTICAL GLASS.—As regards both mode of production and essential properties optical glass differs widely from all other varieties. These differences arise primarily from the fact that glass for optical uses is required in comparatively large and thick pieces, while for most other purposes glass is used in the form of comparatively thin sheets; when, therefore, as a consequence

of Dollond's invention of achromatic telescope objectives in 1757, a demand first arose for optical glass, the industry was unable to furnish suitable material. Flint glass particularly, which appeared quite satisfactory when viewed in small pieces, was found to be so far from homogeneous as to be useless for lens construction. The first step towards overcoming this vital defect in optical glass was taken by P. L. Guinand, towards the end of the 18th century, by introducing the process of stirring the molten glass by means of a cylinder of fireclay. Guinand was induced to migrate from his home in Switzerland to Bavaria, where he worked at the production of homogeneous flint glass, first with Joseph von Utzschneider and then with J. Fraunhofer; the latter ultimately attained considerable success and produced telescope disks up to 28 centimetres (11 in.) diameter. Fraunhofer further initiated the specification of refraction and dispersion in terms of certain lines of the spectrum, and even attempted an investigation of the effect of chemical composition on the relative dispersion produced by glasses in different parts of the spectrum. Guinand's process was further developed in France by Guinand's sons and subsequently by Bontemps and E. Feil. In 1848 Bontemps was obliged to leave France for political reasons and came to England, where he initiated the optical glass manufacture at Chance's glass works near Birmingham, and this firm ultimately attained a considerable reputation in the production of optical glass, especially of large disks for telescope objectives. Efforts at improving optical glass had, however, not been confined to the descendants and successors of Guinand and Fraunhofer. In 1824 the Royal Astronomical Society of London appointed a committee on the subject, the experimental work being carried out by Faraday. Faraday independently recognized the necessity for mechanical agitation of the molten glass in order to ensure homogeneity, and to facilitate his manipulations he worked with dense lead borate glasses which are very fusible, but have proved too unstable for ordinary optical purposes. Later Mécé of Clichy (France) exhibited some "zinc crown" glass in small plates of optical quality at the London Exhibition of 1851; and another French glass-maker, Lamy, produced a dense thallium glass in 1867. In 1834 W. V. Harcourt began experiments in glass-making, in which he was subsequently joined by G. G. Stokes. Their object was to pursue the inquiry begun by Fraunhofer as to the effect of chemical composition on the distribution of dispersion. The specific effect of boric acid in this respect was correctly ascertained by Stokes and Harcourt, but they mistook the effect of titanous acid. J. Hopkinson, working at Chance's glass works, subsequently made an attempt to produce a titanium silicate glass, but nothing further resulted.

The next and most important forward step in the progress of optical glass manufacture was initiated by Ernst Abbe and carried out jointly by him and O. Schott at Jena in Germany. Aided by grants from the Prussian government, these workers systematically investigated the effect of introducing a large number of different chemical substances (oxides) into vitreous fluxes. As a result a whole series of glasses of novel composition and optical properties were produced. A certain number of the most promising of these, from the purely optical point of view, had unfortunately to be abandoned for practical use owing to their chemical instability, and the problem of Fraunhofer, viz. the production of pairs of glasses of widely differing refraction and dispersion, but having a similar distribution of dispersion in the various regions of the spectrum, was not in the first instance solved. On the other hand, while in the older crown and flint glasses the relation between refraction and dispersion had been practically fixed, dispersion and refraction increasing regularly with the density of the glass, in some of the new glasses introduced by Abbe and Schott this relation is altered and a relatively low refractive index is accompanied by a relatively high dispersion, while in others a high refractive index is associated with low dispersive power.

The initiative of Abbe and Schott, which was greatly aided by the resources for scientific investigation available at the *Physikalische Reichsanstalt* (Imperial Physical Laboratory),

led to such important developments that similar work was undertaken in France by the firm of Mantois, the successors of Feil, and somewhat later by Chance in England. The manufacture of the new varieties of glass, originally known as "Jena" glasses, is now carried out extensively and with a considerable degree of commercial success in France, and also to a less extent in England, but none of the other makers of optical glass has as yet contributed to the progress of the industry to anything like the same extent as the Jena firm.

The older optical glasses, now generally known as the "ordinary" crown and flint glasses, are all of the nature of pure silicates, the basic constituents being, in the case of crown glasses, lime and soda or lime and potash, or a mixture of both, and in the case of flint glasses, lead and either (or both) soda and potash. With the exception of the heavier flint (lead) glasses, these can be produced so as to be free both from noticeable colour and from such defects as bubbles, opaque inclusions or "striae," but extreme care in the choice of all the raw materials and in all the manipulations is required to ensure this result. Further, these glasses, when made from properly proportioned materials, possess a very considerable degree of chemical stability, which is amply sufficient for most optical purposes. The newer glasses, on the other hand, contain a much wider variety of chemical constituents, the most important being the oxides of barium, magnesium, aluminium and zinc, used either with or without the addition of the bases already named in reference to the older glasses, and—among acid bodies—boric anhydride (B_2O_3) which replaces the silica of the older glasses to a varying extent. It must be admitted that, by the aid of certain of these new constituents, glasses can be produced which, as regards purity of colour, freedom from defects and chemical stability are equal or even superior to the best of the "ordinary" glasses, but it is a remarkable fact that when this is the case the optical properties of the new glass do not fall very widely outside the limits set by the older glasses. On the other hand, the more extreme the optical properties of these new glasses, i.e. the further they depart from the ratio of refractive index to dispersive power found in the older glasses, the greater the difficulty found in obtaining them of either sufficient purity or stability to be of practical use. It is, in fact, admitted that some of the glasses, most useful optically, the dense barium crown glasses, which are so widely used in modern photographic lenses, cannot be produced entirely free either from noticeable colour or from numerous small bubbles, while the chemical nature of these glasses is so sensitive that considerable care is required to protect the surfaces of lenses made from them if serious tarnishing is to be avoided. In practice, however, it is not found that the presence either of a decidedly greenish-yellow colour or of numerous small bubbles interferes at all seriously with the successful use of the lenses for the majority of purposes, so that it is preferable to sacrifice the perfection of the glass in order to secure valuable optical properties.

It is a further striking fact, not unconnected with those just enumerated, that the extreme range of optical properties covered even by the relatively large number of optical glasses now available is in reality very small. The refractive indices of all glasses at present available lie between 1.46 and 1.90, whereas transparent minerals are known having refractive indices lying considerably outside these limits; at least one of these, fluorite (calcium fluoride), is actually used by opticians in the construction of certain lenses, so that probably progress is to be looked for in a considerable widening of the limits of available optical materials; possibly such progress may lie in the direction of the artificial production of large mineral crystals.

The qualities required in optical glasses have already been partly referred to, but may now be summarized:—

1. *Transparency and Freedom from Colour.*—These qualities can be readily judged by inspection of the glass in pieces of considerable thickness, and they may be quantitatively measured by means of the *spectro-photometer*.

2. *Homogeneity.*—The optical desideratum is uniformity of refractive index and dispersive power throughout the mass of the glass. This is probably never completely attained, variations in the sixth

significant figure of the refractive index being observed in different parts of single large blocks of the most perfect glass. While such minute and gradual variations are harmless for most optical purposes, sudden variations which generally take the form of striae or veins are fatal defects in all optical glasses. In their coarsest forms such striae are readily visible to the unaided eye, but finer ones escape detection unless special means are taken for rendering them visible; such special means conveniently take the form of an apparatus for examining the glass in a beam of parallel light, when the striae scatter the light and appear as either dark or bright lines according to the position of the eye. Plate glass of the usual quality, which appears to be perfectly homogeneous when looked at in the ordinary way, is seen to be a mass of fine striae, when a considerable thickness is examined in parallel light. Plate glass is, nevertheless, considerably used for the cheaper forms of lenses, where the scattering of the light and loss of definition arising from these fine striae is not readily recognized.

Bubbles and enclosures of opaque matter, although more readily observed, do not constitute such serious defects; their presence in a lens, to a moderate extent, does not interfere with its performance (see above).

3. Hardness and Chemical Stability.—These properties contribute to the durability of lenses, and are specially desirable in the outer members of lens combinations which are likely to be subjected to frequent handling or are exposed to the weather. As a general rule to which, however, there are important exceptions, both these qualities are found to a greater degree, the lower the refractive index of the glass. The chemical stability, i.e. the power of resisting the disintegrating effects of atmospheric moisture and carbonic acid, depends largely upon the quantity of alkalis contained in the glass and their proportion to the lead, lime or barium present, the stability being generally less the higher the proportion of alkali. A high silica-content tends towards both hardness and chemical stability, and this can be further increased by the addition of small proportions of boric acid; in larger quantities, however, the latter constituent produces the opposite effect.

4. Absence of Internal Strain.—Internal strain in glass arises from the unequal contraction of the outer and inner portions of masses of glass during cooling. Processes of annealing, or very gradual cooling, are intended to relieve these strains, but such processes are only completely effective when the cooling, particularly through those ranges of temperature where the glass is just losing the last traces of plasticity, is extremely gradual, a rate measured in hours per degree Centigrade being required. The existence of internal strains in glass can be readily recognized by examination in polarized light, any signs of double refraction indicating the existence of strain. If the glass is very badly annealed, the lenses made from it may fly to pieces during or after manufacture, but apart from such extreme cases the optical effects of internal strain are not readily observed except in large optical apparatus. Very perfectly annealed optical glass is now, however, readily obtainable.

5. Refraction and Dispersion.—The purely optical properties of refraction and dispersion, although of the greatest importance, cannot be dealt with in any detail here; for an account of the optical properties required in glasses for various forms of lenses see the articles LENS and ABERRATION: II. In *Optical Systems*. As typical of the range of modern optical glasses Table I. is given, which constituted the list of optical glasses exhibited by Messrs Chance at the Optical Convention in London in 1905. In this table n is the

refractive index of the glass for sodium light (the D line of the solar spectrum), while the letters C, F and G' refer to lines in the hydrogen spectrum by which dispersion is now generally specified. The symbol ν represents the inverse of the dispersive power, its value being $(n_D - 1)/(C - F)$. The very much longer lists of German and French firms contain only a few types not represented in this table.

Manufacture of Optical Glass.—In its earlier stages, the process for the production of optical glass closely resembles that used in the production of any other glass of the highest quality. The raw materials are selected with great care to assure chemical purity, but whereas in most glasses the only impurities to be dreaded are those that are either infusible or produce a colouring effect upon the glass, for optical purposes the admixture of other glass-forming bodies than those which are intended to be present must be avoided on account of their effect in modifying the optical constants of the glass. Constancy of composition of the raw materials and their careful and thorough admixture in constant proportions are therefore essential to the production of the required glasses. The materials are generally used in the form either of oxides (lead, zinc, silica, &c.) or of salts readily decomposed by heat, such as the nitrates or carbonates. Fragments of glass of the same composition as that aimed at are generally incorporated to a limited extent with the mixed raw materials to facilitate their fusion. The crucibles or pots used for the production of optical glass very closely resemble those used in the manufacture of flint glass for other purposes; they are "covered" and the molten materials are thus protected from the action of the furnace gases by the interposition of a wall of fireclay, but as crucibles for optical glass are used for only one fusion and are then broken up, they are not made so thick and heavy as those used in flint-glass making, since the latter remain in the furnace for many weeks. On the other hand, the chemical and physical nature of the fireclays used in the manufacture of such crucibles requires careful attention in order to secure the best results. The furnace used for the production of optical glass is generally constructed to take one crucible only, so that the heat of the furnace may be accurately adjusted to the requirements of the particular glass under treatment. These small furnaces are frequently arranged for direct coal firing, but regenerative gas-fired furnaces are also employed. The empty crucible, having first been gradually dried and heated to a bright red heat in a subsidiary furnace, is taken up by means of massive iron tongs and introduced into the previously heated furnace, the temperature of which is then gradually raised. When a suitable temperature for the fusion of the particular glass in question has been attained, the mixture of raw materials is introduced in comparatively small quantities at a time. In this way the crucible is gradually filled with a mass of molten glass, which is, however,

TABLE I.—Optical Properties.

Factory Number.	Name.	n _D .	ν.	Medium Dispersion. C-F.	Partial and Relative Partial Dispersions.					
					C-D.	C-D/C-F.	D-F.	D-F/C-F.	F-G'.	F-G'/C-F.
C. 644	Extra Hard Crown	1.4959	64.4	-00770	.00228	.296	.00542	.704	.00431	.560
B. 646	Boro-silicate Crown	1.5096	63.3	-00803	.00236	.294	.00562	.700	.00446	.555
A. 605	Hard Crown	1.5175	60.5	-00856	.00252	.294	.00604	.706	.00484	.554
C. 577	Medium Barium Crown	1.5738	57.9	-00990	.00293	.296	.00697	.704	.00552	.557
C. 579	Densest Barium Crown	1.6065	57.9	-01046	.00308	.294	.00738	.705	.00589	.563
A. 569	Soft Crown	1.5152	56.9	-00906	.00264	.291	.00642	.708	.00517	.570
B. 563	Medium Barium Crown	1.5660	56.3	-01006	.00297	.295	.00709	.704	.00576	.572
B. 535	Barium Light Flint	1.5452	53.5	-01020	.00298	.292	.00722	.701	.00582	.570
A. 490	Extra Light Flint	1.5316	49.0	-01085	.00313	.288	.00777	.711	.00630	.580
A. 485	Extra Light Flint	1.5333	48.5	-01099	.00322	.285	.00777	.707	.00640	.582
C. 474	Boro-silicate Flint	1.5623	47.4	-01187	.00343	.285	.00844	.711	.00693	.584
B. 465	Barium Light Flint	1.5831	46.5	-01251	.00352	.288	.00889	.711	.00721	.576
B. 458	Soda Flint	1.5482	45.8	-01195	.00343	.287	.00852	.713	.00690	.577
A. 458	Light Flint	1.5472	45.8	-01196	.00348	.291	.00848	.709	.00707	.591
A. 432	Light Flint	1.5610	43.2	-01299	.00372	.287	.00927	.713	.00770	.593
A. 410	Light Flint	1.5760	41.0	-01404	.00402	.286	.01002	.713	.00840	.598
B. 407	Light Flint	1.5787	40.7	-01420	.00404	.284	.01016	.715	.00840	.591
A. 370	Dense Flint	1.6118	36.9	-01657	.00470	.284	.01187	.716	.01004	.606
A. 361	Dense Flint	1.6214	36.1	-01722	.00491	.285	.01231	.715	.01046	.608
A. 360	Dense Flint	1.6225	36.0	-01729	.00493	.286	.01236	.715	.01054	.609
A. 337	Extra Dense Flint	1.6469	33.7	-01917	.00541	.285	.01376	.720	.01170	.655
A. 299	Densest Flint	1.7129	29.9	-02384	.00670	.281	.01714	.789	.01601	.678

full of bubbles of all sizes. These bubbles arise partly from the air enclosed between the particles of raw materials and partly from the gaseous decomposition products of the materials themselves. In the next stage of the process, the glass is raised to a high temperature in order to render it sufficiently fluid to allow of the complete elimination of these bubbles; the actual temperature required varies with the chemical composition of the glass, a bright red heat sufficing for the most fusible glasses, while with others the utmost capacity of the best furnaces is required to attain the necessary temperature. With these latter glasses there is, of course, considerable risk that the partial fusion and consequent contraction of the fireclay of the crucible may result in its destruction and the entire loss of the glass. The stages of the process so far described generally occupy from 36 to 60 hours, and during this time the constant care and watchfulness of those attending the furnace is required. This is still more the case in the next stage. The examination of small test-pieces of the glass withdrawn from the crucible by means of an iron rod having shown that the molten mass is free from bubbles, the stirring process may be begun, the object of this manipulation being to render the glass as homogeneous as possible and to secure the absence of veins or striae in the product. For this purpose a cylinder of fireclay, provided with a square axial hole at the upper end, is heated in a small subsidiary furnace and is then introduced into the molten glass. Into the square axial hole fits the square end of a hooked iron bar which projects several yards beyond the mouth of the furnace; by means of this bar a workman moves the fireclay cylinder about in the glass with a steady circular sweep. Although the weight of the iron bar is carried by a support, such as an overhead chain or a swivel roller, this operation is very laborious and trying, more especially during the earlier stages when the heat radiated from the open mouth of the crucible is intense. The men who manipulate the stirring bars are therefore changed at short intervals, while the bars themselves have also to be changed at somewhat longer intervals, as they rapidly become oxidized, and accumulated scale would tend to fall off them, thus contaminating the glass below. The stirring process is begun when the glass is perfectly fluid at a temperature little short of the highest attained in its fusion, but as the stirring proceeds the glass is allowed to cool gradually and thus becomes more and more viscous until finally the stirring cylinder can scarcely be moved. When the glass has acquired this degree of consistency it is supposed that no fresh movements can occur within its mass, so that if homogeneity has been attained the glass will preserve it permanently. The stirring is therefore discontinued and the clay cylinder is either left embedded in the glass, or by the exercise of considerable force it may be gradually withdrawn. The crucible with the semi-solid glass which it contains is now allowed to cool considerably in the melting furnace, or it may be removed to another slightly heated furnace. When the glass has cooled so far as to become hard and solid, the furnace is hermetically sealed up and allowed to cool very gradually to the ordinary temperature. If the cooling is very gradual—occupying several weeks—it sometimes happens that the entire contents of a large crucible, weighing perhaps 1000 lb, are found intact as a single mass of glass, but more frequently the mass is found broken up into a number of fragments of various sizes. From the large masses great lenses and mirrors may be produced, while the smaller pieces are used for the production of the disks and slabs of moderate size, in which the optical glass of commerce is usually supplied. In order to allow of the removal of the glass, the cold crucible is broken up and the glass carefully separated from the fragments of fireclay. The pieces of glass are then examined for the detection of the grosser defects, and obviously defective pieces are rejected. As the fractured surfaces of the glass in this condition are unsuitable for delicate examination a good deal of glass that passes this inspection has yet ultimately to be rejected. The next stage in the preparation of the glass is the process of moulding and annealing. Lumps of glass of approximately the right weight

are chosen, and are heated to a temperature just sufficient to soften the glass, when the lumps are caused to assume the shape of moulds made of iron or fireclay either by the natural flow of the softened glass under gravity, or by pressure from suitable tools or presses. The glass, now in its approximate form, is placed in a heated chamber where it is allowed to cool very gradually—the minimum time of cooling from a dull red heat being six days, while for "fine annealing" a much longer period is required (see above). At the end of the annealing process the glass issues in the shape of disks or slabs slightly larger than required by the optician in each case. The glass is, however, by no means ready for delivery, since it has yet to be examined with scrupulous care, and all defective pieces must be rejected entirely or at least the defective part must be cut out and the slab remoulded or ground down to a smaller size. For the purpose of rendering this minute examination possible, opposite plane surfaces of the glass are ground approximately flat and polished, the faces to be polished being so chosen as to allow of a view through the greatest possible thickness of glass; thus in slabs the narrow edges are polished.

It will be readily understood from the above account of the process of production that optical glass, relatively to other kinds of glass, is very expensive, the actual price varying from 3s. to 30s. per lb in small slabs or disks. The price, however, rapidly increases with the total bulk of perfect glass required in one piece, so that large disks of glass suitable for telescope objectives of wide aperture, or blocks for large prisms, become exceedingly costly. The reason for this high cost is to be found partly in the fact that the yield of optically perfect glass even in large and successful meltings rarely exceeds 20% of the total weight of glass melted. Further, all the subsequent processes of cutting, moulding and annealing become increasingly difficult, owing to the greatly increased risk of breakage arising from either external injury or internal strain, as the dimensions of the individual piece of glass increase. Nevertheless, disks of optical glass, both crown and flint, have been produced up to 39 in. in diameter.

II. BLOWN GLASS. (A) *Table-ware and Vases*.—The varieties of glass used for the manufacture of table-ware and vases are the potash-lead glass, the soda-lime glass and the potash-lime glass. These glasses may be colourless or coloured. Venetian glass is a soda-lime glass; Bohemian glass is a potash-lime glass. The potash-lead glass, which was first used on a commercial scale in England for the manufacture of table-ware, and which is known as "flint" glass or "crystal," is also largely used in France, Germany and the United States. Table II. shows the typical composition of these glasses.

TABLE II.

	SiO ₂	K ₂ O	PbO	Na ₂ O	CaO	MgO	Fe ₂ O ₃ and Al ₂ O ₃
Potash-lead (flint) glass . . .	53.17	13.88	32.95
Soda-lime (Venetian) glass . . .	73.40	18.58	5.06	..	2.48
Potash-lime (Bohemian) glass . . .	71.70	12.70	..	2.50	10.30	..	0.90

For melting the leadless glasses, open, bowl-shaped crucibles are used, ranging from 12 to 40 in. in diameter. Glass mixtures containing lead are melted in covered, beehive-shaped crucibles holding from 12 to 18 cwt. of glass. They have a hooded opening on one side near the top. This opening serves for the introduction of the glass-mixture, for the removal of the melted glass and as a source of heat for the processes of manipulation.

The Venetian furnaces in the island of Murano are small low structures heated with wood. The heat passes from the melting furnace into the annealing kiln. In Germany, Austria and the United States, gas furnaces are generally used. In England directly-heated coal furnaces are still in common use, which in many cases are stoked by mechanical feeders. There are two systems of annealing. The manufactured goods are either removed gradually from a constant source of heat by means of a train of small iron trucks drawn along a tramway by an

endless chain, or are placed in a heated kiln in which the fire is allowed gradually to die out. The second system is especially used for annealing large and heavy objects. The manufacture of table-ware is carried on by small gangs of men and boys. In England each "gang" or "chair" consists of three men and one boy. In works, however, in which most of the goods are moulded, and where less skilled labour is required, the proportion of boy labour is increased. There are generally two shifts of workmen, each shift working six hours, and the work is carried on continuously from Monday morning until Friday morning. Directly work is suspended the glass remaining in the crucibles is ladled into water, drained and dried. It is then mixed with the glass mixture and broken glass ("cullet"), and replaced in the

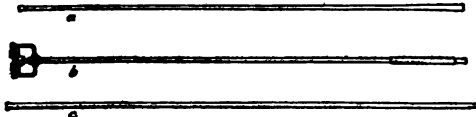

FIG. 16.—Pontils and Blowing Iron.
a, Puntee; b, spring puntee; c, blowing iron.

crucibles. The furnaces are driven to a white heat in order to fuse the mixture and expel bubbles of gas and air. Before work begins the temperature is lowered sufficiently to render the glass viscous. In the viscous state a mass of glass can be coiled upon the heated end of an iron rod, and if the rod is hollow can be blown into a hollow bulb. The tools used are extremely primitive—hollow iron blowing-rods, solid rods for holding vessels during manipulation, spring tools, resembling sugar-tongs in shape, with steel or wooden blades for fashioning the viscous glass, callipers, measure-sticks, and a variety of moulds of wood, carbon, cast iron, gun-metal and plaster of Paris (figs. 16 and 17). The most important tool, however, is the bench or "chair" on which the workman sits, which serves as his lathe. He sits

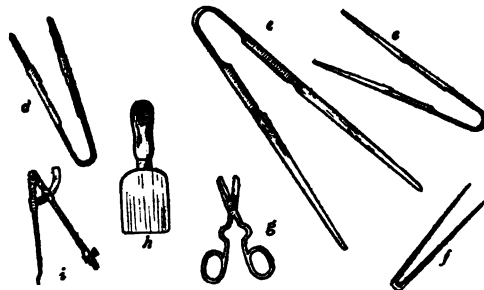

FIG. 17.—Shaping and Measuring Tools.
d, "Sugar-tongs" tool with wooden ends.
e, "Sugar-tongs" tools with cutting edges.
f, Pincers.
g, Scissors.
h, Battledore.
i, Marking compass.

between two rigid parallel arms, projecting forwards and backwards and sloping slightly from back to front. Across the arms he balances the iron rod to which the glass bulb adheres, and rolling it backwards and forwards with the fingers of his left hand fashions the glass between the blades of his sugar-tongs tool, grasped in his right hand. The hollow bulb is worked into the shape it is intended to assume, partly by blowing, partly by gravitation, and partly by the workman's tool. If the blowing iron is held vertically with the bulb uppermost the bulb becomes flattened and shallow, if the bulb is allowed to hang downwards it becomes elongated and reduced in diameter, and if the end of the bulb is pierced and the iron is held horizontally and sharply trundled, as a mop is trundled, the bulb opens out into a flattened disk.

During the process of manipulation, whether on the chair

or whilst the glass is being reheated, the rod must be constantly and gently trundled to prevent the collapse of the bulb or vessel. Every natural development of the spherical form can be obtained by blowing and fashioning by hand. A non-spherical form can only be produced by blowing the hollow bulb into a mould of the required shape. Moulds are used both for giving shape to vessels and also for impressing patterns on their surface. Although spherical forms can be obtained without the use of moulds, moulds are now largely used for even the simplest kinds of table-ware in order to economize time and skilled labour. In France, Germany and the United States it is rare to find a piece of table-ware which has not received its shape in a mould. The old and the new systems of making a wine-glass illustrate almost all the ordinary processes of glass working. Sufficient glass is first "gathered" on the end of a blowing iron to form the bowl of the wine-glass. The mere act of coiling an exact weight of molten glass round the end of a rod 4 ft. in length requires considerable skill. The mass of glass is rolled on a polished slab of iron, the "marvor," to solidify it, and it is then slightly hollowed by blowing. Under the old system the form of the bowl is gradually developed by blowing and by shaping the bulb with the sugar-tongs tool. The leg is either pulled out from the substance of the base of the bowl, or from a small lump of glass added to the base. The foot starts as a small independent bulb on a separate blowing iron. One extremity of this bulb is made to adhere to the end of the leg, and the other extremity is broken away from its blowing iron. The fractured end is heated, and by the combined action of heat and centrifugal force opens out into a flat foot. The bowl is now severed from its blowing iron and the unfinished wine-glass is supported by its foot, which is attached to the end of a working rod by a metal clip or by a seal of glass. The fractured edge of the bowl is heated, trimmed with scissors and melted so as to be perfectly smooth and even, and the bowl itself receives its final form from the sugar-tongs tool.

Under the new system the bowl is fashioned by blowing the slightly hollowed mass of glass into a mould. The leg is formed and a small lump of molten glass is attached to its extremity to form the foot. The blowing iron is constantly trundled, and the small lump of glass is squeezed and flattened into the shape of a foot, either between two slabs of wood hinged together, or by pressure against an upright board. The bowl is severed from the blowing iron, and the wine-glass is sent to the annealing oven with a bowl, longer than that of the finished glass, and with a rough fractured edge. When the glass is cold the surplus is removed either by grinding, or by applying heat to a line scratched with a diamond round the bowl. The fractured edge is smoothed by the impact of a gas flame.

In the manufacture of a wine-glass the ductility of glass is illustrated on a small scale by the process of pulling out the leg. It is more strikingly illustrated in the manufacture of glass cane and tube. Cane is produced from a solid mass of molten glass, tube from a mass hollowed by blowing. One workman holds the blowing iron with the mass of glass attached to it, and another fixes an iron rod by means of a seal of glass to the extremity of the mass. The two workmen face each other and walk backwards. The diameter of the cane or tube is regulated by the weight of glass carried, and by the distance covered by the two workmen. It is a curious property of viscous glass that whatever form is given to the mass of glass before it is drawn out is retained by the finished cane or tube, however small its section may be. Owing to this property, tubes or canes can be produced with a square, oblong, oval or triangular section. Exceedingly fine canes of milk-white glass play an important part in the masterpieces produced by the Venetian glass-makers of the 16th century. Vases and drinking cups were produced of extreme lightness, in the walls of which were embedded patterns rivalling lace-work in fineness and intricacy. The canes from which the patterns are formed are either simple or complex. The latter are made by dipping a small mass of molten colourless glass into an iron cup around the inner wall of which short lengths of white cane have been arranged at

regular intervals. The canes adhere to the molten glass, and the mass is first twisted and then drawn out into fine cane, which contains white threads arranged in endless spirals. The process can be almost indefinitely repeated and canes formed of extreme complexity. A vase decorated with these simple or complex canes is produced by embedding short lengths of the cane on the surface of a mass of molten glass and blowing and fashioning the mass into the required shape.

Table-ware and vases may be wholly coloured or merely decorated with colour. Touches of colour may be added to vessels in course of manufacture by means of seals of molten glass, applied like sealing-wax; or by causing vessels to wrap themselves round with threads or coils of coloured glass. By the application of a pointed iron hook, while the glass is still ductile, the parallel coils can be distorted into bends, loops or zigzags. The surface of vessels may be spangled with gold or platinum by rolling the hot glass on metallic leaf, or iridescent, by the deposition of metallic tin, or by the corrosion caused by the chemical action of acid fumes. Gilding and enamel decoration are applied to vessels when cold, and fixed by heat.

Cutting and engraving are mechanical processes for producing decorative effects by abrading the surface of the glass when cold. The abrasion is effected by pressing the glass against the edge of wheels, or disks, of hard material revolving on horizontal spindles. The spindles of cutting wheels are driven by steam or electric power. The wheels for making deep cuts are made of iron, and are fed with sand and water. The wheels range in diameter from 18 in. to 3 in. Wheels of carborundum are also used. Wheels of fine sandstone fed with water are used for making slighter cuts and for smoothing the rough surface left by the iron wheels. Polishing is effected by wooden wheels fed with wet pumice-powder and rottenstone and by brushes fed with moistened putty-powder. Patterns are produced by combining straight and curved cuts. Cutting brings out the brilliancy of glass, which is one of its intrinsic qualities. At the end of the 18th century English cut glass was unrivalled for design and beauty. Gradually, however, the process was applied without restraint and the products lost all artistic quality. At the present time cut glass is steadily regaining favour.

Engraving is a process of drawing on glass by means of small copper wheels. The wheels range from $\frac{1}{2}$ in. to 2 in. in diameter, and are fed with a mixture of fine emery and oil. The spindles to which the wheels are attached revolve in a lathe worked by a foot treadle. The true use of engraving is to add interest to vessels by means of coats of arms, crests, monograms, inscriptions and graceful outlines. The improper use of engraving is to hide defective material. There are two other processes of marking patterns on glass, but they possess no artistic value. In the "sandblast" process the surface of the glass is exposed to a stream of sharp sand driven by compressed air. The parts of the surface which are not to be blasted are covered by adhesive paper. In the "etching" process the surface of the glass is etched by the chemical action of hydrofluoric acid, the parts which are not to be attacked being covered with a resinous paint. The glass is first dipped in this protective liquid, and when the paint has set the pattern is scratched through it with a sharp point. The glass is then exposed to the acid.

Glass stoppers are fitted to bottles by grinding. The mouth of the bottle is ground by a revolving iron cone, or mandrel, fed with sand and water and driven by steam. The head of the stopper is fastened in a chuck and the peg is ground to the size of the mouth of the bottle by means of sand and water pressed against the glass by bent strips of thin sheet iron. The mouth of the bottle is then pressed by hand on the peg of the stopper, and the mouth and peg are ground together with a medium of very fine emery and water until an air-tight joint is secured.

The revival in recent years of the craft of glass-blowing in England must be attributed to William Morris and T. G. Jackson, R.A. (Pl. II. figs. 11 and 12). They, at any rate, seem to have been the first to grasp the idea that a wine-glass is not merely

a bowl, a stem and a foot, but that, whilst retaining simplicity of form, it may nevertheless possess decorative effect. They, moreover, suggested the introduction for the manufacture of table-glass of a material similar in texture to that used by the Venetians, both colourless and tinted.

The colours previously available for English table-glass were ruby, canary-yellow, emerald-green, dark peacock-green, light peacock-blue, dark purple-blue and a dark purple. About 1870 the "Jackson" table-glass was made in a light, dull green glass. The dull green was followed successively by amber, white opal, blue opal, straw opal, sea-green, horn colour and various pale tints of soda-lime glass, ranging from yellow to blue. Experiments were also tried with a violet-coloured glass, a violet opal, a transparent black and with glasses shading from red to blue, red to amber and blue to green.

In the Paris Exhibition of 1900 surface decoration was the prominent feature of all the exhibits of table-glass. The carved or "cameo" glass, introduced by Thomas Webb of Stourbridge in 1878, had been copied with varying success by glass-makers of all nations. In many specimens there were three or more layers of differently coloured glass, and curious effects of blended colour were obtained by cutting through, or partly through, the different layers. The surface of the glass had usually been treated with hydrofluoric acid so as to have a satin-like gloss. Some vases of this character, shown by Emile Gallé and Daum Frères of Nancy, possessed considerable beauty. The "Favrile" glass of Louis C. Tiffany of New York (Pl. II. fig. 13) owes its effect entirely to surface colour and lustre. The happiest specimens of this glass almost rival the wings of butterflies in the brilliancy of their iridescent colours. The vases of Karl Koepping of Berlin are so fantastic and so fragile that they appear to be creations of the lamp rather than of the furnace. An illustration is also given of some of Powell's "Whitefriars" glass, shown at the St. Louis Exhibition, 1904 (Pl. II. fig. 14). The specimens of "pâte de verre" exhibited by A. L. Damouze, of Sèvres, in the Musée des Arts décoratifs in Paris, and at the London Franco-British Exhibition in 1908, deserve attention. They have a semi-opaque body with an "egg-shell" surface and are delicately tinted with colour. The shapes are exceedingly simple, but some of the pieces possess great beauty. The material and technique suggest a close relationship to porcelain.

(B) *Tube*.—The process of making tube has already been described. Although the bore of the thermometer-tube is exceedingly small, it is made in the same way as ordinary tube. The white line of enamel, which is seen in some thermometers behind the bore, is introduced before the mass of glass is pulled out. A flattened cake of viscous glass-enamel is welded on to one side of the mass of glass after it has been hollowed by blowing. The mass, with the enamel attached, is dipped into the crucible and covered with a layer of transparent glass; the whole mass is then pulled out into tube. If the section of the finished tube is to be a triangle, with the enamel and bore at the base, the molten mass is pressed into a V-shaped mould before it is pulled out.

In modern thermometry instruments of extreme accuracy are required, and researches have been made, especially in Germany and France, to ascertain the causes of variability in mercurial thermometers, and how such variability is to be removed or reduced. In all mercurial thermometers there is a slight depression of the ice-point after exposure to high temperatures; it is also not uncommon to find that the readings of two thermometers between the ice- and boiling-points fail to agree at any intermediate temperature, although the ice- and boiling-points of both have been determined together with perfect accuracy, and the intervening spaces have been equally divided. It has been proved that these variations depend to a great extent on the chemical nature of the glass of which the thermometer is made. Special glasses have therefore been produced by Tonnelot in France and at the Jena glass-works in Germany expressly for the manufacture of thermometers for accurate physical measurements; the analyses of these are shown in Table III.

TABLE III.

	SiO ₂	Na ₂ O	K ₂ O	CaO	Al ₂ O ₃	MgO	B ₂ O ₃	ZnO	Depression of Ice-point.
Tonnellot's "Verre dur"	70.96	12.02	0.56	14.40	1.44	0.40	0.07
Jena glass—XVI.—III	67.5	14.0	..	7.0	2.5	..	2.0	7.0	0.05
59—III	72.0	11.0	..	5.0	5.0	..	12.0	..	0.02

Since the discovery of the Röntgen rays, experiments have been made to ascertain the effects of the different constituents of glass on the transparency of glass to X-rays. The oxides of lead, barium, zinc and antimony are found perceptibly to retard the rays. The glass tubes, therefore, from which the X-ray bulbs are to be fashioned, must not contain any of these oxides, whereas the glass used for making the funnel-shaped shields, which direct the rays upon the patient and at the same time protect the hands of the operator from the action of the rays, must contain a large proportion of lead.

Among the many developments of the Jena Works, not the least important are the glasses made in the form of a tube, from which gas-chimneys, gauge-glasses and chemical apparatus are fashioned, specially adapted to resist sudden changes of temperature. One method is to form the tube of two layers of glass, one being considerably more expansible than the other.

(C) *Sheet and Crown-glass.*—Sheet-glass is almost wholly a soda-lime-silicate glass, containing only small quantities of iron, alumina and other impurities. The raw materials used in this manufacture are chosen with considerable care, since the requirements as to the colour of the product are somewhat stringent. The materials ordinarily employed are the following: sand, of good quality, uniform in grain and free from any notable quantity of iron oxide; carbonate of lime, generally in the form of a pure variety of powdered limestone; and sulphate of soda. A certain proportion of soda ash (carbonate of soda) is also used in some works in sheet-glass mixtures, while "decolorizers" (substances intended to remove or reduce the colour of the glass) are also sometimes added, those most generally used being manganese dioxide and arsenic. Another essential ingredient of all glass mixtures containing sulphate of soda is some form of carbon, which is added either as coke, charcoal or anthracite coal; the carbon so introduced aids the reducing substances contained in the atmosphere of the furnace in bringing about the reduction of the sulphate of soda to a condition in which it combines more readily with the silicic acid of the sand. The proportions in which these ingredients are mixed vary according to the exact quality of glass required and with the form and temperature of the melting furnace employed. A good quality of sheet-glass should show, on analysis, a composition approximating to the following: silica (SiO₂), 72%; lime (CaO), 13%; soda (Na₂O), 14%; and iron and alumina (Fe₂O₃, Al₂O₃), 1%. The actual composition, however, of a mixture that will give a glass of this composition cannot be directly calculated from these figures and the known composition of the raw materials, owing to the fact that considerable losses, particularly of alkali, occur during melting.

The fusion of sheet-glass is now generally carried out in gas-fired regenerative tank furnaces. The glass in process of fusion is contained in a basin or tank built up of large blocks of fire-clay and is heated by one or more powerful gas flames which enter the upper part of the furnace chamber through suitable apertures or "ports." In Europe the gas burnt in these furnaces is derived from special gas-producers, while in some parts of America natural gas is utilized. With producer gas it is necessary to pre-heat both the gas and the air which is supplied for its combustion by passing both through heated regenerators (for an account of the principles of the regenerative furnace see article FURNACE). In many respects the glass-melting tank resembles the open-hearth steel furnace, but there are certain interesting differences. Thus the dimensions of the largest glass tanks greatly exceed those of the largest steel furnaces: glass furnaces containing up to 250 tons of molten

glass have been successfully operated, and owing to the relatively low density of glass this involves very large dimensions. The temperature required in the fusion of sheet-glass and of other glasses produced in tank furnaces is much lower than that attained in steel furnaces, and it is consequently possible to work glass-tanks continuously for many months together; on the other hand, glass is not readily freed from foreign bodies that may become admixed with it, so that the absence of detachable particles is much more essential in glass than in steel melting. Finally, fluid steel can be run or poured off, since it is perfectly fluid, while glass cannot be thus treated, but is withdrawn from the furnace by means of either a ladle or a gatherer's pipe, and the temperature required for this purpose is much lower than that at which the glass is melted. In a sheet-glass tank there is therefore a gradient of temperature and a continuous passage of material from the hotter end of the furnace where the raw materials are introduced to the cooler end where the glass, free from bubbles and raw material, is withdrawn by the gatherers. For the purpose of the removal of the glass, the cooler end of the furnace is provided with a number of suitable openings, provided with movable covers or shades. The "gatherer" approaches one of these openings, removes the shade and introduces his previously heated "pipe." This instrument is an iron tube, some 5 ft. long, provided at one end with an enlarged butt and at the other with a wooden covering acting as handle and mouthpiece. The gatherer dips the butt of the pipe into the molten "metal" and withdraws upon it a small ball of viscous glass, which he allows to cool in the air while constantly rotating it so as to keep the mass as nearly spherical in shape as he can. When the first ball or "gathering" has cooled sufficiently, the whole is again dipped into the molten glass and a further layer adheres to the pipe-end, thus forming a larger ball. This process is repeated, with slight modifications, until the gathering is of the proper size and weight to yield the sheet which is to be blown. When this is the case the gathering is carried to a block or half-open mould in which it is rolled and blown until it acquires, roughly, the shape of a hemisphere, the flat side being towards the pipe and the convexity away from it; the diameter of this hemisphere is so regulated as to be approximately that of the cylinder which is next to be formed of the viscous mass. From the hemispherical shape the mass of glass is now gradually blown into the form of a short cylinder, and then the pipe with the adherent mass of glass is handed over to the blower proper. This workman stands upon a platform in front of special furnaces which, from their shape and purpose, are called "blowing holes." The blower repeatedly heats the lower part of the mass of glass and keeps it distended by blowing while he swings it over a deep trench which is provided next to his working platform. In this way the glass is extended into the form of a long cylinder closed at the lower end. The size of cylinder which can be produced in this way depends chiefly upon the dimensions of the working platform and the weight which a man is able to handle freely. The lower end of the cylinder is opened, in the case of small and thin cylinders, by the blower holding his thumb over the mouthpiece of the pipe and simultaneously warming the end of the cylinder in the furnace, the expansion of the imprisoned air and the softening of the glass causing the end of the cylinder to burst open. The blower then heats the end of the cylinder again and rapidly spins the pipe about its axis; the centrifugal effect is sufficient to spread the soft glass at the end to a radius equal to that of the rest of the cylinder. In the case of large and thick cylinders, however, another process of opening the ends is generally employed: an assistant attaches a small lump of hot glass to the domed end, and the heat of this added glass softens the cylinder sufficiently to enable the assistant to cut the end open with a pair of shears; subsequently the open end is spun out to the diameter of the whole as described above. The finished cylinder

is next carried to a rack and the pipe detached from it by applying a cold iron to the neck of thick hot glass which connects pipe-butt and cylinder, the neck cracking at the touch. Next, the rest of the connecting neck is detached from the cylinder by the application of a heated iron to the chilled glass. This leaves a cylinder with roughly parallel ends; these ends are cut by the use of a diamond applied internally and then the cylinder is split longitudinally by the same means. The split cylinder is passed to the flattening furnace, where it is exposed to a red heat, sufficient to soften the glass; when soft the cylinder is laid upon a smooth flat slab and flattened down upon it by the careful application of pressure with some form of rubbing implement, which frequently takes the form of a block of charred wood. When flattened, the sheet is moved away from the working opening of the furnace, and pushed to a system of movable grids, by means of which it is slowly moved along a tunnel, away from a source of heat nearly equal in temperature to that of the flattening chamber. The glass thus cools gradually as it passes down the tunnel and is thereby adequately annealed.

The process of sheet-glass manufacture described above is typical of that in use in a large number of works, but many modifications are to be found, particularly in the furnaces in which the glass is melted. In some works, the older method of melting the glass in large pots or crucibles is still adhered to, although the old-fashioned coal-fired furnaces have nearly everywhere given place to the use of producer gas and regenerators. For the production of coloured sheet-glass, however, the employment of pot furnaces is still almost universal, probably because the quantities of glass required of any one tint are insufficient to employ even a small tank furnace continuously; the exact control of the colour is also more readily attained with the smaller bulk of glass which has to be dealt with in pots. The general nature of the colouring ingredients employed, and the colour effects produced by them, have already been mentioned. In coloured sheet-glass, two distinct kinds are to be recognized; in one kind the colouring matter is contained in the body of the glass itself, while in the other the coloured sheet consists of ordinary white glass covered upon one side with a thin coating of intensely coloured glass. The latter kind is known as "flashed," and is universally employed in the case of colouring matters whose effect is so intense that in any usual thickness of glass they would cause almost entire opacity. Flashed glass is produced by taking either the first or the last gathering in the production of a cylinder out of a crucible containing the coloured "metal," the other gatherings being taken out of ordinary white sheet-glass. It is important that the thermal expansion of the two materials which are thus incorporated should be nearly alike, as otherwise warping of the finished sheet is liable to result.

Mechanical Processes for the Production of Sheet-glass.—The complicated and indirect process of sheet-glass manufacture has led to numerous inventions aiming at a direct method of production by more or less mechanical means. All the earlier attempts in this direction failed on account of the difficulty of bringing the glass to the machines without introducing air-bells, which are always formed in molten glass when it is ladled or poured from one vessel into another. More modern inventors have therefore adopted the plan of drawing the glass direct from the furnace. In an American process the glass is drawn direct from the molten mass in the tank in a cylindrical form by means of an iron ring previously immersed in the glass, and is kept in shape by means of special devices for cooling it rapidly as it leaves the molten bath. In this process, however, the entire operations of splitting and flattening are retained, and although the mechanical process is said to be in successful commercial operation, it has not as yet made itself felt as a formidable rival to hand-made sheet-glass. An effort at a more direct mechanical process is embodied in the inventions of Foucault which are at present being developed in Germany and Belgium; in this process the glass is drawn from the molten bath in the shape of flat sheets, by the aid of a bar of iron, previously immersed in the glass, the glass receiving its form by being drawn through slots

in large fire-bricks, and being kept in shape by rapid chilling produced by the action of air-blasts. The mechanical operation is quite successful for thick sheets, but it is not as yet available for the thinner sheets required for the ordinary purposes of sheet-glass, since with these excessive breakage occurs, while the sheets generally show grooves or lines derived from small irregularities of the drawing orifice. For the production of thick sheets which are subsequently to be polished the process may thus claim considerable success, but it is not as yet possible to produce satisfactory sheet-glass by such means.

Crown-glass has at the present day almost disappeared from the market, and it has been superseded by sheet-glass, the more modern processes described above being capable of producing much larger sheets of glass, free from the knob or "bullion" which may still be seen in old crown-glass windows. For a few isolated purposes, however, it is desirable to use a glass which has not been touched upon either surface and thus preserves the lustre of its "fire polish" undiminished; this can be attained in crown-glass but not in sheet, since one side of the latter is always more or less marked by the rubber used in the process of flattening. One of the few uses of crown-glass of this kind is the glass slides upon which microscopic specimens are mounted, as well as the thin glass slips with which such preparations are covered. A full account of the process of blowing crown-glass will be found in all older books and articles on the subject, so that it need only be mentioned here that the glass, instead of being blown into a cylinder, is blown into a flattened sphere, which is caused to burst at the point opposite the pipe and is then, by the rapid spinning of the glass in front of a very hot furnace-opening, caused to expand into a flat disk of large diameter. This only requires to be annealed and is then ready for cutting up, but the lump of glass by which the original globe was attached to the pipe remains as the bullion in the centre of the disk of glass.

Coloured Glass for Mosaic Windows.—The production of coloured glass for "mosaic" windows has become a separate branch of glass-making. Charles Winston, after prolonged study of the coloured windows of the 13th, 14th and 15th centuries, convinced himself that no approach to the colour effect of these windows could be made with glass which is thin and even in section, homogeneous in texture, and made and coloured with highly refined materials. To obtain the effect it was necessary to reproduce as far as possible the conditions under which the early craftsmen worked, and to create scientifically glass which is impure in colour, irregular in section, and non-homogeneous in texture. The glass is made in cylinders and in "crowns" or circles. The cylinders measure about 14 in. in length by 8 in. in diameter, and vary in thickness from $\frac{1}{4}$ to $\frac{3}{8}$ in. The crowns are about 15 in. in diameter, and vary in thickness from $\frac{1}{4}$ to $\frac{3}{8}$ in., the centre being the thickest. These cylinders and crowns may be either solid colour or flashed. Great variety of colour may be obtained by flashing one colour upon another, such as blue on green, and ruby on blue, green or yellow.

E. J. Prior has introduced an ingenious method of making small oblong and square sheets of coloured glass, which are thick in the centre and taper towards the edges, and which have one surface slightly roughened and one brilliantly polished. Glass is blown into an oblong box-shaped iron mould, about 12 in. in depth and 6 in. across. A hollow rectangular bottle is formed, the base and sides of which are converted into sheets. The outer surface of these sheets is slightly roughened by contact with the iron mould.

(D) *Bottles and mechanically blown Glass.*—The manufacture of bottles has become an industry of vast proportions. The demand constantly increases, and, owing to constant improvements in material in the moulds and in the methods of working, the supply fully keeps pace with the demand. Except for making bottles of special colours, gas-heated tank furnaces are in general use. Melting and working are carried on continuously. The essential qualities of a bottle are strength and power to resist chemical corrosion. The materials are selected with a view to secure these qualities. For the highest quality of bottles, which

are practically colourless, sand, limestone and sulphate and carbonate of soda are used. The following is a typical analysis of high quality bottle-glass: SiO_2 , 69.15%; Na_2O , 13.00%; CaO , 15.00%; Al_2O_3 , 2.20%; and Fe_2O_3 , 0.65%. For the commoner grades of dark-coloured bottles the glass mixture is cheapened by substituting common salt for part of the sulphate of soda, and by the addition of felspar, granite, granulate, furnace slag and other substances fusible at a high temperature. Bottle moulds are made of cast iron, either in two pieces, hinged together at the base or at one side, or in three pieces, one forming the body and two pieces forming the neck.

A bottle gang or "shop" consists of five persons. The "gatherer" gathers the glass from the tank furnace on the end of the blowing-iron, rolls it on a slab of iron or stone, slightly expands the glass by blowing, and hands the blowing iron and glass to the "blower." The blower places the glass in the mould, closes the mould by pressing a lever with his foot, and either blows down the blowing iron or attaches it to a tube connected with a supply of compressed air. When the air has forced the



FIG. 18.—Tool for moulding the inside and outside of the neck of a bottle.

C. Bottle.
A. Conical piece of iron to form the inside of the neck.
B, B. Shaped pieces of iron, which can be pressed upon the outside of the neck by the spring-handle H.

glass to take the form of the mould, the mould is opened and the blower gives the blowing iron with the bottle attached to it to the "wetter off." The wetter off touches the top of the neck of the bottle with a moistened piece of iron and by tapping the blowing iron detaches the bottle and drops it into a wooden trough. He then grips the body of the bottle with a four-pronged clip, attached to an iron rod, and passes it to the "bottle maker." The bottle maker heats the fractured neck of the bottle, binds a band of molten glass round the end of it and simultaneously shapes the inside and the outside of the neck by using the tool shown in fig. 18. The finished bottle is taken by the "taker in" to the annealing furnace. The bottles are stacked in iron trucks, which, when full, are moved slowly away from a constant source of heat.

The processes of manipulation which have been described, although in practice they are very rapidly performed, are destined to be replaced by the automatic working of a machine. Bottle-making machines, based on Ashley's original patent, are already being largely used. They ensure absolute regularity in form and save both

time and labour. A bottle-making machine combines the process of pressing with a plunger with that of blowing by compressed air. The neck of the bottle is first formed by the plunger, and the body is subsequently blown by compressed air admitted through the plunger. A sufficient weight of molten glass to form a bottle is gathered and placed in a funnel-shaped vessel which serves as a measure, and gives access to the mould which shapes the outside of the neck. A plunger is forced upwards into the glass in the neck-mould and forms the neck. The funnel is removed, and the plunger, neck-mould and the mass of molten glass attached to the neck are inverted. A bottle mould rises and envelops the mass of molten glass. Compressed air admitted through the plunger forces the molten glass to take the form of the bottle mould and completes the bottle.

In the case of the machine patented by Michael Owens of Toledo, U.S.A., for making tumblers, lamp-chimneys, and other goods of similar character, the manual operations required are (1) gathering the molten glass at the end of a blowing iron; (2) placing the blowing iron with the glass attached to it in the machine; (3) removing the blowing iron with the blown vessel attached. Each machine (fig. 19) consists of a revolving table carrying five or six moulds. The moulds are opened and closed by cams actuated by compressed air. As soon as a blowing iron is in connexion with an air jet, the sections of the mould

close upon the molten glass, and the compressed air forces the glass to take the form of the mould. After removal from the machine, the tumbler is severed from the blowing iron, and its fractured edge is trimmed.

Compressed air or steam is also used for fashioning very large vessels, baths, dishes and reservoirs by the "Sievert" process. Molten glass is spread upon a large iron plate of the required shape and dimensions. The flattened mass of glass is held by a rim, connected to the edge of the plate. The plate with the glass attached to it is inverted, and compressed air or steam is introduced through openings in the plate. The mass of glass, yielding to its own weight and the pressure of air or steam, sinks downwards and adapts itself to any mould or receptacle beneath it.

The processes employed in the manufacture of the glass bulbs for incandescent electric lamps, are similar to the old-

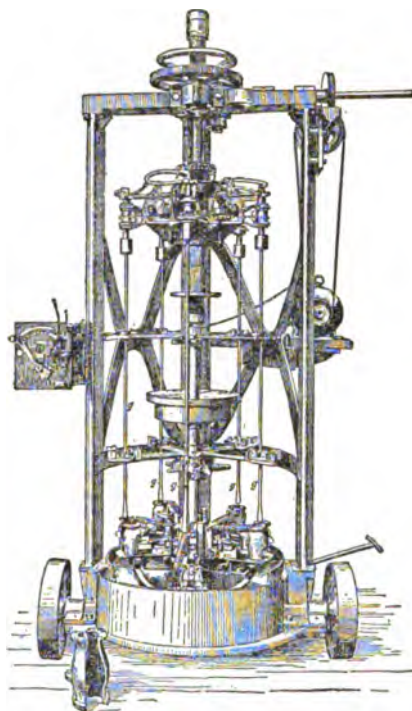

FIG. 19.—Owens's Glass-blowing Machine. g, g, Blowing-irons.

fashioned processes of bottle making. The mould is in two pieces hinged together; it is heated and the inner surface is rubbed over with finely powdered plumbago. When the glass is being blown in the mould the blowing iron is twisted round and round so that the finished bulb may not be marked by the joint of the mould.

III. MECHANICALLY PRESSED GLASS. (A) *Plate-glass*.—The glass popularly known as "plate-glass" is made by casting and rolling. The following are typical analyses:

	SiO_2	CaO	Na_2O	Al_2O_3	Fe_2O_3
French .	71.80	15.70	11.10	1.26	0.14 %
English .	70.64	16.27	11.47	0.70	0.49 %

The raw materials for the production of plate-glass are chosen with great care so as to secure a product as free from colour as possible, since the relatively great thickness of the sheets

would render even a faint tint conspicuous. The substances employed are the same as those used for the manufacture of sheet-glass, viz. pure sand, a pure form of carbonate of lime, and sulphate of soda, with the addition of a suitable proportion of carbon in the form of coke, charcoal or anthracite coal.

The glass to be used for the production of plate is universally melted in pots or crucibles and not in open tank furnaces. When the glass is completely melted and "fine," i.e. free from bubbles, it is allowed to cool down to a certain extent so as to become viscous or pasty. The whole pot, with its contents of viscous glass, is then removed bodily from the furnace by means of huge tongs and is transported to a crane, which grips the pot, raises it, and ultimately tips it over so as to pour the glass upon the slab of the rolling-table. In most modern works the greater part of these operations, as well as the actual rolling of the glass, is carried out by mechanical means, steam power and subsequently electrical power having been successfully applied to this purpose; the handling of the great weights of glass required for the largest sheets of plate-glass which are produced at the present time would, indeed, be impossible without the aid of machinery. The casting-table usually consists of a perfectly smooth cast-iron slab, frequently built up of a number of pieces carefully fitted together, mounted upon a low, massive truck running upon rails, so that it can be readily moved to any desired position in the casting-room. The viscous mass having been thrown on the casting-table, a large and heavy roller passes over it and spreads it out into a sheet. Rollers up to 5 tons in weight are employed and are now generally driven by power. The width of the sheet or plate is regulated by moving guides which are placed in front of the roller and are pushed along by it, while its thickness is regulated by raising or lowering the roller relatively to the surface of the table. Since the surfaces produced by rolling have subsequently to be ground and polished, it is essential that the glass should leave the rolling-table with as smooth a surface as possible, so that great care is required in this part of the process. It is, however, equally important that the glass as a whole should be flat and remains flat during the process of gradual cooling (annealing), otherwise great thicknesses of glass would have to be ground away at the projecting parts of the sheet. The annealing process is therefore carried out in a manner differing essentially from that in use for any other variety of flat glass and nearly resembling that used for optical glass. The rolled sheet is left on the casting-table until it has set sufficiently to be pushed over a flat iron plate without risk of distortion; meanwhile the table has been placed in front of the opening of one of the large annealing kilns and the slab of glass is carefully pushed into the kiln. The annealing kilns are large fire-brick chambers of small height but with sufficient floor area to accommodate four or six large slabs, and the slabs are placed directly upon the floor of the kiln, which is built up of carefully dressed blocks of burnt fire-clay resting upon a bed of sand; in order to avoid any risk of working or buckling in this floor these blocks are set slightly apart and thus have room to expand freely when heated. Before the glass is introduced, the annealing kiln is heated to dull red by means of coal fires in grates which are provided at the ends or sides of the kiln for that purpose. When the floor of the kiln has been covered with slabs of glass the opening is carefully built up and luted with fire-bricks and fire-clay, and the whole is then allowed to cool. In the walls and floor of the kiln special cooling channels or air passages are provided and by gradually opening these to atmospheric circulation the cooling is considerably accelerated while a very even distribution of temperature is obtained; by these means even the largest slabs can now be cooled in three or four days and are nevertheless sufficiently well annealed to be free from any serious internal stress. From the annealing kiln the slabs of glass are transported to the cutting room, where they are cut square, defective slabs being rejected or cut down to smaller sizes. The glass at this stage has a comparatively dull surface and this must now be replaced by that brilliant and perfectly polished surface which is the chief

beauty of this variety of glass. The first step in this process is that of grinding the surface down until all projections are removed and a close approximation to a perfect plane is obtained. This operation, like all the subsequent steps in the polishing of the glass, is carried out by powerful machinery. By means of a rotating table either two surfaces of glass, or one surface of glass and one of cast iron, are rubbed together with the interposition of a powerful abrasive such as sand, emery or carborundum. The machinery by which this is done has undergone numerous modifications and improvements, all tending to produce more perfectly plane glass, to reduce the risk of breakage, and to lessen the expenditure of time and power required per sq. yd. of glass to be worked. It is impossible to describe this machinery within the limits of this article, but it is notable that the principal difficulties to be overcome arise from the necessity of providing the glass with a perfectly continuous and unyielding support to which it can be firmly attached but from which it can be detached without undue difficulty.

When the surface of the glass has been ground down to a plane, the surface itself is still "grey," i.e. deeply pitted with the marks of the abrasive used in grinding it down; these marks are removed by the process of smoothing, in which the surface is successively ground with abrasives of gradually increasing fineness, leaving ultimately a very smooth and very minutely pitted "grey" surface. This smooth surface is then brilliantly polished by the aid of friction with a rubbing tool covered with a soft substance like leather or felt and fed with a polishing material, such as rouge. A few strokes of such a rubber are sufficient to produce a decidedly "polished" appearance, but prolonged rubbing under considerable pressure and the use of a polishing paste of a proper consistency are required in order to remove the last trace of pitting from the surface. This entire process must, obviously, be applied in turn to each of the two surfaces of the slab of glass. Plate-glass is manufactured in this manner in thicknesses varying from $\frac{1}{8}$ in. to 1 in. or even more, while single sheets are produced measuring more than 27 ft. by 13 ft.

"Rolled Plate" and figured "Rolled Plate."—Glass for this purpose, with perhaps the exception of the best white and tinted varieties, is now universally produced in tank-furnaces, similar in a general way to those used for sheet-glass, except that the furnaces used for "rolled plate" glass of the roughest kinds do not need such minutely careful attention and do not work at so high a temperature. The composition of these glasses is very similar to that of sheet-glass, but for the ordinary kinds of rolled plate much less scrupulous selection need be made in the choice of raw materials, especially of the sand.

The glass is taken from the furnace in large iron ladles, which are carried upon slings running on overhead rails; from the ladle the glass is thrown upon the cast-iron bed of a rolling-table, and is rolled into sheet by an iron roller, the process being similar to that employed in making plate-glass, but on a smaller scale. The sheet thus rolled is roughly trimmed while hot and soft, so as to remove those portions of glass which have been spoiled by immediate contact with the ladle, and the sheet, still soft, is pushed into the open mouth of an annealing tunnel or "leat," down which it is carried by a system of moving grids.

The surface of the glass produced in this way may be modified by altering the surface of the rolling-table; if the table has a smooth surface, the glass will also be more or less smooth, but much dented and buckled on the surface and far from having the smooth face of blown sheet. If the table has a pattern engraved upon it the glass will show the same pattern in relief, the most frequent pattern of the kind being either small parallel ridges or larger ribs crossing to form a lozenge pattern.

The more elaborate patterns found on what is known as "figure rolled plate" are produced in a somewhat different manner; the glass used for this purpose is considerably whiter in colour and much softer than ordinary rolled plate, and instead of being rolled out on a table it is produced by rolling between two moving rollers from which the sheet issues. The pattern is impressed upon the soft sheet by a printing roller which is brought down upon the glass as it leaves the main rolls. This

GLASS

PLATE I.



Fig. 1.



Fig. 2.



Fig. 6.



Fig. 3.

Fig. 4.



Fig. 8.



Fig. 5.



Fig. 10.



Fig. 7.



Fig. 9.



Fig. 11.—Table Glass.
Designed by T. G. Jackson in 1870.

Fig. 12.—Table Glass.
Designed for Wm. Morris about 1872 by Philip Webb.



Fig. 13.—Tiffany Glass.



Fig. 14.—Whitefriars Glass, 1906.

glass shows a pattern in high relief and gives a very brilliant effect.

The various varieties of rolled plate-glass are now produced for some purposes with a reinforcement of wire netting which is embedded in the mass of the glass. The wire gives the glass great advantages in the event of fracture from a blow or from fire, but owing to the difference in thermal expansion between wire and glass, there is a strong tendency for such "wired glass" to crack spontaneously.

Patent Plate-glass.—This term is applied to blown sheet-glass, whose surface has been rendered plane and brilliant by a process of grinding and polishing. The name "patent plate" arose from the fact that certain patented devices originated by James Chance of Birmingham first made it possible to polish comparatively thin glass in this way.

(B) **Pressed Glass.**—The technical difference between pressed and moulded glass is that moulded glass-ware has taken its form from a mould under the pressure of a workman's breath, or of compressed air, whereas pressed glass-ware has taken its form from a mould under the pressure of a plunger. Moulded glass receives the form of the mould on its interior as well as on its exterior surface. In pressed glass the exterior surface is modelled by the mould, whilst the interior surface is modelled by the plunger (fig. 20).

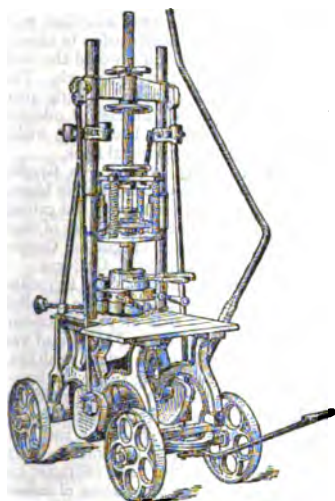

FIG. 20.—Modern American Glass-Press.

The process of pressing glass was introduced to meet the demand for cheap table-ware. Pressed glass, which is necessarily thick and serviceable, has well met this legitimate demand, but it also caters for the less legitimate taste for cheap imitations of hand-cut glass. An American writer has expressed his satisfaction that the day-labourer can now have on his table at a nominal price glass dishes of elaborate design, which only an expert can distinguish from hand-cut crystal. The deceptive effect is in some cases heightened by cutting over and polishing by hand the pressed surface.

The glass for pressed ware must be colourless, and, when molten, must be sufficiently fluid to adapt itself readily to the intricacies of the moulds, which are often exceedingly complex. The materials employed are sand, sulphate of soda, nitrate of soda, calc spar and in some works carbonate of barium. The following is an analysis of a specimen of English pressed glass: SiO_2 , 70.68%; Na_2O , 18.38%; CaO , 5.45%; BaO , 4.17%; Al_2O_3 , 0.33%; and Fe_2O_3 , 0.20%. Tanks and pots are both used for melting the glass. The moulds are made of cast iron. They are usually in two main pieces, a base and an upper part or collar of hinged sections. The plunger is generally worked by a hand lever. The operator knows by touch when the plunger has pressed the glass far enough to exactly fill the mould. Although the moulds are heated, the surface of the glass is always slightly ruffled by contact with the mould. For this reason every piece of pressed glass-ware, as soon as it is liberated from the mould, is exposed to a sharp heat in a small subsidiary furnace in order that the ruffled surface may be removed by melting. These

small furnaces are usually heated by an oil spray under the pressure of steam or compressed air.

See Antonio Neri, *Ars vitraria, cum Merriti observationibus* (Amsterdam, 1668) (Neri's work was translated into English by C. Merritt in 1662, and the translation, *The Art of making Glass*, was privately reprinted by Sir T. Phillipps, Bart., in 1826); Johann Kunkel, *Vollständige Glasmacher-Kunst* (Nuremberg, 1785); Apuley Pellatt, *Curiousities of Glass-making* (London, 1849); A. Saussy, *Martels of Glass-making* (from the French) (London, 1869); C. Bontemps, *Guide du verrier* (Paris, 1868); E. Peligot, *Le Verre, son histoire, sa fabrication* (Paris, 1878); W. Stein, "Die Glasfabrikation," in Bolley's *Technologie*, vol. iii. (Brunswick, 1862); H. E. Benrath, *Die Glasfabrikation* (Brunswick, 1875); J. Falck and L. Lobmeyr, *Die Glasindustrie* (Vienna, 1875); D. H. Hovestadt, *Jenaer Glas* (Jena, 1900; Eng. trans. by J. D. and A. Everett, Macmillan, 1907); J. Henrivaux, *Le Verre et le cristal* (Paris, 1887), and *La Verrierie au XX^e siècle* (1903); Chance, Harris and Powell, *Principles of Glass-making* (London, 1883); Moritz V. Rohr, *Theorie und Geschichte der photographischen Optik* (Berlin, 1899); C. E. Guillaume, *Traité pratique de la thermométrie de précision* (Paris, 1899); Louis Coffignal, *Verres et émaux* (Paris, 1900); R. Gerner, *Die Glasfabrikation* (Vienna, 1897); C. Wetzel, *Herstellung grosser Glaskörper* (Vienna, 1900); C. Wetzel, *Bearbeitung von Glaskörpern* (Vienna, 1901); E. Techeusner, *Handbuch der Glasfabrikation* (Weimar, 1885); R. Dralle, *Anlage und Betrieb der Glasfabriken* (Leipzig, 1886); G. Tammann, *Kristallisieren und Schmelzen* (Leipzig, 1903); W. Rosenhain, "Some Properties of Glass," *Trans. Optical Society* (London, 1903); "Possible Directions of Progress in Optical Glass," *Proc. Optical Convention* (London, 1905) and *Glass Manufacture* (London, 1908); Introduction to section 1, *Catalogue of the Optical Convention* (London, 1905). (H. J. P.; W. RN.)

History of Glass Manufacture.

The great similarity in form, technique and decoration of the earliest known specimens of glass-ware suggests that the craft of glass-making originated from a single centre. It has been generally assumed that Egypt was the birthplace of the glass industry. It is true that many conditions existed in Egypt favourable to the development of the craft. The Nile supplied a waterway for the conveyance of fuel and for the distribution of the finished wares. Materials were available providing the essential ingredients of glass. The Egyptian potteries afforded experience in dealing with vitreous glazes and vitreous colours, and from Egyptian alabaster-quarries veined vessels were wrought, which may well have suggested the decorative arrangement of zigzag lines (see Plate I. figs. 1, 2, 4 d) so frequently found on early specimens of glass-ware. In Egypt, however, no traces have at present been found of the industry in a rudimentary condition, and the vases which have been classified as "primitive" bear witness to an elaboration of technique far in advance of the experimental period. The earliest specimens of glass-ware which can be definitely claimed as Egyptian productions, and the glass manufactory discovered by Dr Flinders Petrie at Tell el Amarna, belong to the period of the XVIIIth dynasty. The comparative lateness of this period makes it difficult to account for the wall painting at Beni Hasan, which accurately represents the process of glass-blowing, and which is attributed to the period of the XIIth dynasty. Dr Petrie surmounts the difficulty by saying that the process depicted is not glass-blowing, but some metallurgical process in which reeds were used tipped with lumps of clay. It is possible that the picture does not represent Egyptian glass-blowers, but is a traveller's record of the process of glass-blowing seen in some foreign or subject country. The scarcity of specimens of early glass-ware actually found in Egypt, and the advanced technique of those which have been found, lead to the supposition that glass-making was exotic and not a native industry. The tradition, recorded by Pliny (*Nat. Hist.* xxxvi. 65), assigns the discovery of glass to Syria, and the geographical position of that country, its forests as a source of fuel, and its deposits of sand add probability to the tradition. The story that Phœnician merchants found a glass-like substance under their cooking pots, which had been supported on blocks of natron, need not be discarded as pure fiction. The fire may well have caused the natron, an impure form of carbonate of soda, to combine with the surrounding sand to form silicate of soda, which, although not a permanent glass, is sufficiently glass-like to suggest the

possibility of creating a permanent transparent material. Moreover, Pliny (xxxvi. 66) actually records the discovery which effected the conversion of deliquescent silicate of soda into permanent glass. The words are "Coeptus addi magnes lapis." There have been many conjectures as to the meaning of the words "magnes lapis." The material has been considered by some to be magnetic iron ore and by others oxide of manganese. Oxides of iron and manganese can only be used in glass manufacture in comparatively small quantities for the purpose of colouring or neutralizing colour in glass, and their introduction would not be a matter of sufficient importance to be specially recorded. In chapter 25 of the same book Pliny describes five varieties of "magnes lapis." One of these he says is found in magnesia, is white in colour, does not attract iron and is like pumice stone. This variety must certainly be magnesian limestone. Magnesian limestone mixed and fused with sand and an alkaline carbonate produces a permanent glass. The scene of the discovery of glass is placed by Pliny on the banks of the little river Belus, under the heights of Mount Carmel, where sand suitable for glass-making exists and wood for fuel is abundant. In this neighbourhood fragments and lumps of glass are still constantly being dug up, and analysis proves that the glass contains a considerable proportion of magnesia. The district was a glass-making centre in Roman times, and it is probable that the Romans inherited and perfected an indigenous industry of remote antiquity. Pliny has so accurately recorded the stages by which a permanent glass was developed that it may be assumed that he had good reason for claiming for Syria the discovery of glass. Between Egypt and Syria there was frequent intercourse both of conquest and commerce. It was customary for the victor after a successful raid to carry off skilled artisans as captives. It is recorded that Tahutmes III. sent Syrian artisans to Egypt. Glass-blowers may have been amongst their captive craftsmen, and may have started the industry in Egypt. The claims of Syria and Egypt are at the present time so equally balanced that it is advisable to regard the question of the birthplace of the glass industry as one that has still to be settled.

The "primitive" vessels which have been found in Egypt are small in size and consist of columnar stibium jars, flattened bottles and amphorae, all decorated with zigzag lines, tiny wide-mouthed vases on feet and minute jugs. The vessels of later date which have been found in considerable quantities, principally in the coast towns and islands of the Mediterranean, are amphorae and alabastra, also decorated with zigzag lines. The amphorae (Plate I. figs. 1 and 2) terminate with a point, or with an unfinished extension from the terminal point, or with a knob. The alabastra have short necks, are slightly wider at the base than at the shoulder and have rounded bases. Dr Petrie has called attention to two technical peculiarities to be found in almost every specimen of early glass-ware. The inner surface is roughened (Plate I. fig. 4 c), and has particles of sand adhering to it, as if the vessel had been filled with sand and subjected to heat, and the inside of the neck has the impression of a metal rod (Plate I. fig. 4 a), which appears to have been extracted from the neck with difficulty. From this evidence Dr Petrie has assumed that the vessels were not blown, but formed upon a core of sandy paste, modelled upon a copper rod, the rod being the core of the neck (see EGYPT: *Art and Archaeology*). The evidence, however, hardly warrants the abandonment of the simple process of blowing in favour of a process which is so difficult that it may almost be said to be impossible, and of which there is no record or tradition except in connexion with the manufacture of small beads. The technical difficulties to which Dr Petrie has called attention seem to admit of a somewhat less heroic explanation. A modern glass-blower, when making an amphora-shaped vase, finishes the base first, fixes an iron rod to the finished base with a seal of glass, severs the vase from the blowing iron, and finishes the mouth, whilst he holds the vase by the iron attached to its base. The "primitive" glass-worker reversed this process. Having blown the body of the vase, he finished the mouth and neck part, and

fixed a small, probably hollow, copper rod inside the finished neck by pressing the neck upon the rod (Plate I. fig. 4 b). Having severed the body of the vase from the blowing iron, he heated and closed the fractured base, whilst holding the vase by means of the rod fixed in the neck. Nearly every specimen shows traces of the pressure of a tool on the outside of the neck, as well as signs of the base having been closed by melting. Occasionally a knob or excrescence, formed by the residue of the glass beyond the point at which the base has been pinched together, remains as a silent witness of the process.

If glass-blowing had been a perfectly new invention of Graeco-Egyptian or Roman times, some specimens illustrating the transition from core-moulding to blowing must have been discovered. The absence of traces of the transition strengthens the supposition that the revolution in technique merely consisted in the discovery that it was more convenient to finish the base of a vessel before its mouth, and such a revolution would leave no trace behind. The roughened inner surface and the adhering particles of sand may also be accounted for. The vessels, especially those in which many differently coloured glasses were incorporated, required prolonged annealing. It is probable that when the metal rod was withdrawn the vessel was filled with sand, to prevent collapse, and buried in heated ashes to anneal. The greater the heat of the ashes the more would the sand adhere to and impress the inner surface of the vessels. The decoration of zigzag lines was probably applied directly after the body of the vase had been blown. Threads of coloured molten glass were spirally coiled round the body, and, whilst still viscid, were dragged into zigzags with a metal hook.

Egypt.—The glass industry flourished in Egypt in Graeco-Egyptian and Roman times. All kinds of vessels were blown, both with and without moulds, and both moulding and cutting were used as methods of decoration. The great variety of these vessels is well shown in the illustrated catalogue of Graeco-Egyptian glass in the Cairo museum, edited by C. C. Edgar.

Another species of glass manufacture in which the Egyptians would appear to have been peculiarly skilled is the so-called mosaic glass, formed by the union of rods of various colours in such a manner as to form a pattern; the rod so formed was then reheated and drawn out until reduced to a very small size, 1 sq in or less, and divided into tablets by being cut transversely, each of these tablets presenting the pattern traversing its substance and visible on each face. This process was no doubt first practised in Egypt, and is never seen in such perfection as in objects of a decidedly Egyptian character. Very beautiful pieces of ornament of an architectural character are met with, which probably once served as decorations of caskets or other small pieces of furniture or of trinkets; also tragic masks, human faces and birds. Some of the last-named are represented with such truth of colouring and delicacy of detail that even the separate feathers of the wings and tail are well distinguished, although, as in an example in the British Museum, a human-headed hawk, the piece which contains the figure may not exceed $\frac{1}{2}$ in. in its largest dimension. Works of this description probably belong to the period when Egypt passed under Roman domination, as similar objects, though of inferior delicacy, appear to have been made in Rome.

Assyria.—Early Assyrian glass is represented in the British Museum by a vase of transparent greenish glass found in the north-west palace of Nineveh. On one side of this a lion is engraved, and also a line of cuneiform characters, in which is the name of Sargon, king of Assyria, 722 B.C. Fragments of coloured glasses were also found there, but our materials are too scanty to enable us to form any decided opinion as to the degree of perfection to which the art was carried in Assyria. Many of the specimens discovered by Layard at Nineveh have all the appearance of being Roman, and were no doubt derived from the Roman colony, Niniva Claudiopolis, which occupied the same site.

Roman Glass.—In the first centuries of our era the art of glass-making was developed at Rome and other cities under Roman rule in a most remarkable manner, and it reached a point of

excellence which in some respects has never been excelled or even perhaps equalled. It may appear a somewhat exaggerated assertion that glass was used for more purposes, and in one sense more extensively, by the Romans of the imperial period than by ourselves in the present day; but it is one which can be borne out by evidence. It is true that the use of glass for windows was only gradually extending itself at the time when Roman civilization sank under the torrent of German and Hunnish barbarism, and that its employment for optical instruments was only known in a rudimentary stage; but for domestic purposes, for architectural decoration and for personal ornaments glass was unquestionably much more used than at the present day. It must be remembered that the Romans possessed no fine porcelain decorated with lively colours and a beautiful glaze; Samian ware was the most decorative kind of pottery which was then made. Coloured and ornamental glass held among them much the same place for table services, vessels for toilet use and the like, as that held among us by porcelain. Pliny (*Nat. Hist.* xxxvi. 26, 67) tells us that for drinking vessels it was even preferred to gold and silver.

Glass was largely used in pavements, and in thin plates as a coating for walls. It was used in windows, though by no means exclusively, mica, alabaster and shells having been also employed. Glass, in flat pieces, such as might be employed for windows, has been found in the ruins of Roman houses, both in England and in Italy, and in the house of the faun at Pompeii a small pane in a bronze frame remains. Most of the pieces have evidently been made by casting, but the discovery of fragments of sheet-glass at Silchester proves that the process of making sheet-glass was known to the Romans. When the window openings were large, as was the case in basilicas and other public buildings, and even in houses, the pieces of glass were, doubtless, fixed in pierced slabs of marble or in frames of wood or bronze. The Roman glass-blowers were masters of all the ordinary methods of manipulation and decoration. Their craftsmanship is proved by the large cinerary urns, by the jugs with wide, deeply ribbed, scientifically fixed handles, and by vessels and vases as elegant in form and light in weight as any that have been since produced at Murano. Their moulds, both for blowing hollow vessels and for pressing ornaments, were as perfect for the purposes for which they were intended as those of the present time. Their decorative cutting (Plate I. figs. 5 and 6), which took the form of simple, incised lines, or bands of shallow oval or hexagonal hollows, was more suited to the material than the deep prismatic cutting of comparatively recent times.

The Romans had at their command, of transparent colours, blue, green, purple or amethystine, amber, brown and rose; of opaque colours, white, black, red, blue, yellow, green and orange. There are many shades of transparent blue and of opaque blue, yellow and green. In any large collection of fragments it would be easy to find eight or ten varieties of opaque blue, ranging from lapis lazuli to turquoise or to lavender and six or seven of opaque green. Of red the varieties are fewer; the finest is a crimson red of very beautiful tint, and there are various gradations from this to a dull brick red. One variety forms the ground of a very good imitation of porphyry; and there is a dull semi-transparent red which, when light is passed through it, appears to be of a dull green hue. With these colours the Roman *vitrarius* worked, either using them singly or blending them in almost every conceivable combination, sometimes, it must be owned, with a rather gaudy and inharmonious effect.

The glasses to which the Venetians gave the name "mille fori" were formed by arranging side by side sections of glass cane, the canes themselves being built up of differently coloured rods of glass, and binding them together by heat. A vast quantity of small cups and paterae were made by this means in patterns which bear considerable resemblance to the surfaces of madreporae. In these every colour and every shade of colour seem to have been tried in great variety of combination with effects more or less pleasing, but transparent violet or purple

appears to have been the most common ground colour. Although most of the vessels of this mille fori glass were small, some were made as large as 20 in. in diameter. Imitations of natural stones were made by stirring together in a crucible glasses of different colours, or by incorporating fragments of differently coloured glasses into a mass of molten glass by rolling. One variety is that in which transparent brown glass is so mixed with opaque white and blue as to resemble onyx. This was sometimes done with great success, and very perfect imitations of the natural stone were produced. Sometimes purple glass is used in place of brown, probably with the design of imitating the precious murrhine. Imitations of porphyry, of serpentine, and of granite are also met with, but these were used chiefly in pavements, and for the decoration of walls, for which purposes the onyx-glass was likewise employed.

The famous cameo glass was formed by covering a mass of molten glass with one or more coatings of a differently coloured glass. The usual process was to gather, first, a small quantity of opaque white glass; to coat this with a thick layer of translucent blue glass; and, finally, to cover the blue glass with a coating of the white glass. The outer coat was then removed from that portion which was to constitute the ground, leaving the white for the figures, foliage or other ornamentation; these were then sculptured by means of the gem-engraver's tools. Pliny no doubt means to refer to this when he says (*Nat. Hist.* xxxvi. 26. 66), "aliud argenti modo caelatur," contrasting it with the process of cutting glass by the help of a wheel, to which he refers in the words immediately preceding, "aliud torno teritur."

The Portland or Barberini vase in the British Museum is the finest example of this kind of work which has come down to us, and was entire until it was broken into some hundred pieces by a madman. The pieces, however, were joined together by Mr Doubleday with extraordinary skill, and the beauty of design and execution may still be appreciated. The two other most remarkable examples of this cameo glass are an amphora at Naples and the Auldjo vase. The amphora measures 1 ft. $\frac{1}{2}$ in. in height, 1 ft. $\frac{7}{8}$ in. in circumference; it is shaped like the earthen amphoras with a foot far too small to support it, and must no doubt have had a stand, probably of gold; the greater part is covered with a most exquisite design of garlands and vines, and two groups of boys gathering and treading grapes and playing on various instruments of music; below these is a line of sheep and goats in varied attitudes. The ground is blue and the figures white. It was found in a house in the Street of Tombs at Pompeii in the year 1839, and is now in the Royal Museum at Naples. It is well engraved in Richardson's *Studies of Ornamental Design*. The Auldjo vase, in the British Museum, is an oenochoe about 9 in. high; the ornament consists mainly of a most beautiful band of foliage, chiefly of the vine, with bunches of grapes; the ground is blue and the ornaments white; it was found at Pompeii in the house of the faun. It also has been engraved by Richardson. The same process was used in producing large tablets, employed, no doubt, for various decorative purposes. In the South Kensington Museum is a fragment of such a tablet or slab; the figure, a portion of which remains, could not have been less than about 14 in. high. The ground of these cameo glasses is most commonly transparent blue, but sometimes opaque blue, purple or dark brown. The superimposed layer, which is sculptured, is generally opaque white. A very few specimens have been met with in which several colours are employed.

At a long interval after these beautiful objects come those vessels which were ornamented either by means of coarse threads trailed over their surfaces and forming rude patterns, or by coloured enamels merely placed on them in lumps; and these, doubtless, were cheap and common wares. But a modification of the first-named process was in use in the 4th and succeeding centuries, showing great ingenuity and manual dexterity,—that, namely, in which the added portions of glass are united to the body of the cup, not throughout, but only at points, and then shaped either by the wheel or by the hand (Plate I. fig. 3). The

attached portions form in some instances inscriptions, as on a cup found at Strassburg, which bears the name of the emperor Maximian (A.D. 286-310), on another in the Vereingte Sammlungen at Munich, and on a third in the Trivulzi collection at Milan, where the cup is white, the inscription green and the network blue. Probably, however, the finest example is a situla, 10½ in. high by 8 in. wide at the top and 4 in. at the bottom, preserved in the treasury of St Mark at Venice. This is of glass of a greenish hue; on the upper part is represented, in relief, the chase of a lion by two men on horseback accompanied by dogs; the costume appears to be Byzantine rather than Roman, and the style is very bad. The figures are very much undercut. The lower part has four rows of circles united to the vessel at those points alone where the circles touch each other. All the other examples have the lower portion covered in like manner by a network of circles standing nearly a quarter of an inch from the body of the cup. An example connected with the specimens just described is the cup belonging to Baron Lionel de Rothschild; though externally of an opaque greenish colour, it is by transmitted light of a deep red. On the outside, in very high relief, are figures of Bacchus with vines and panthers, some portions being hollow from within, others fixed on the exterior. The changeability of colour may remind us of the "calices versicolores" which Hadrian sent to Servianus.

So few examples of glass vessels of this period which have been painted in enamel have come down to us that it has been questioned whether that art was then practised; but several specimens have been described which can leave no doubt on the point; decisive examples are afforded by two cups found at Vaspelev, in Denmark, engravings of which are published in the *Annaler for Nordisk Oldkyndighed* for 1861, p. 305. These are small cups, 3 in. and 2½ in. high, 3½ in. and 3 in. wide, with feet and straight sides; on the larger are a lion and a bull, on the smaller two birds with grapes, and on each some smaller ornaments. On the latter are the letters DVB. R. The colours are vitrified and slightly in relief; green, blue and brown may be distinguished. They are found with Roman bronze vessels and other articles.

The art of glass-making no doubt, like all other art, deteriorated during the decline of the Roman empire, but it is probable that it continued to be practised, though with constantly decreasing skill, not only in Rome but in the provinces. Roman technique was to be found in Byzantium and Alexandria, in Syria, in Spain, in Germany, France and Britain.

Early Christian and Byzantine Glass.—The process of embedding gold and silver leaf between two layers of glass originated as early as the 1st century, probably in Alexandria. The process consisted in spreading the leaf on a thin film of blown glass and pressing molten glass on to the leaf so that the molten glass cohered with the film of glass through the pores of the metallic leaf. If before this application of the molten glass the metallic leaf, whilst resting on the thin film of blown glass, was etched with a sharp point, patterns, emblems, inscriptions and pictures could be embedded and rendered permanent by the double coating of glass. The plaques thus formed could be reheated and fashioned into the bases of bowls and drinking vessels. In this way the so-called "fondi d'oro" of the catacombs in Rome were made. They are the broken bases of drinking vessels containing inscriptions, emblems, domestic scenes and portraits etched in gold leaf. Very few have any reference to Christianity, but they served as indestructible marks for indicating the position of interments in the catacombs. The fondi d'oro suggested the manufacture of plaques of gold which could be broken up into tesserae for use in mosaics.

Some of the Roman artificers in glass no doubt migrated to Constantinople, and it is certain that the art was practised there to a very great extent during the middle ages. One of the gates near the port took its name from the adjacent glass houses. St Sofia when erected by Justinian had vaults covered with mosaics and immense windows filled with plates of glass fitted into pierced marble frames; some of the plates, 7 to 8 in. wide and 9 to 10 in. high, not blown but cast, which

are in the windows may possibly date from the building of the church. It is also recorded that pierced silver disks were suspended by chains and supported glass lamps "wrought by fire." Glass for mosaics was also largely made and exported. In the 8th century, when peace was made between the caliph Walid and the emperor Justinian II., the former stipulated for a quantity of mosaic for the decoration of the new mosque at Damascus, and in the 10th century the materials for the decoration of the niche of the kibra at Cordova were furnished by Romanus II. In the 11th century Desiderius, abbot of Monte Casino, sent to Constantinople for workers in mosaic.

We have in the work of the monk Theophilus, *Diversarum artium schedula*, and in the probably earlier work of Eraclius, about the 11th century, instructions as to the art of glass-making in general, and also as to the production of coloured and enamelled vessels, which these writers speak of as being practised by the Greeks. The only entire enamelled vessel which we can confidently attribute to Byzantine art is a small vase preserved in the treasury of St Mark's at Venice. This is decorated with circles of rosettes of blue, green and red enamel, each surrounded by lines of gold; within the circles are little figures evidently suggested by antique originals, and precisely like similar figures found on carved ivory boxes of Byzantine origin dating from the 11th or 12th century. Two inscriptions in Cufic characters surround the vase, but they, it would seem, are merely ornamental and destitute of meaning. The presence of these inscriptions may perhaps lead to the inference that the vase was made in Sicily, but by Byzantine workmen. The double-handled blue-glass vase in the British Museum, dating from the 5th century, is probably a chalice, as it closely resembles the chalices represented on early Christian monuments.

Of uncoloured glass brought from Constantinople several examples exist in the treasury of St Mark's at Venice, part of the plunder of the imperial city when taken by the crusaders in 1204. The glass in all is greenish, very thick, with many bubbles, and has been cut with the wheel; in some instances circles and cones, and in one the outlines of the figure of a leopard, have been left standing up, the rest of the surface having been laboriously cut away. The intention would seem to have been to imitate vessels of rock crystal. The so-called "Hedwig" glasses may also have originated in Constantinople. These are small cups deeply and rudely cut with conventional representations of eagles, lions and griffins. Only nine specimens are known. The specimen in the Rijks Museum at Amsterdam has an eagle and two lions. The specimen in the Germanic Museum at Nuremberg has two lions and a griffin.

Saracenic Glass.—The Saracenic invasion of Syria and Egypt did not destroy the industry of glass-making. The craft survived and flourished under the Saracenic régime in Alexandria, Cairo, Tripoli, Tyre, Aleppo and Damascus. In inventories of the 14th century both in England and in France mention may frequently be found of glass vessels of the manufacture of Damascus. A writer in the early part of the 15th century states that "glass-making is an important industry at Halab (Aleppo)." Edward Dillon (*Glass*, 1902) has very properly laid stress on the importance of the enamelled Saracenic glass of the 13th, 14th and 15th centuries, pointing out that, whereas the Romans and Byzantine Greeks made some crude and ineffectual experiments in enamelling, it was under Saracenic influence that the processes of enamelling and gilding on glass vessels were perfected. An analysis of the glass of a Cairene mosque lamp shows that it is a soda-lime glass and contains as much as 4% of magnesia. This large proportion of magnesia undoubtedly supplied the stability required to withstand the process of enamelling. The enamelled Saracenic glasses take the form of flasks, vases, goblets, beakers and mosque lamps. The enamelled decoration on the lamps is restricted to lettering, scrolls and conventional foliage; on other objects figure-subjects of all descriptions are freely used. C. H. Read has pointed out a curious feature in the construction of the enamelled beakers. The base is double but the inner lining has an opening in the centre. Dillon has suggested that this central recess may have served to support a wick. It is possible, however,

that it served no useful purpose, but that the construction is a survival from the manufacture of vessels with fondi d'oro. The bases containing the embedded gold leaf must have been welded to the vessels to which they belonged, in the same way as the bases are welded to the Saracenic beakers. The enamelling process was probably introduced in the early part of the 13th century; most of the enamelled mosque lamps belong to the 14th century.

Venetian Glass.—Whether refugees from Padua, Aquileia or other Italian cities carried the art to the lagoons of Venice in the 5th century, or whether it was learnt from the Greeks of Constantinople at a much later date, has been a disputed question. It would appear not improbable that the former was the case, for it must be remembered that articles formed of glass were in the later days of Roman civilization in constant daily use, and that the making of glass was carried on, not as now in large establishments, but by artisans working on a small scale. It seems certain that some knowledge of the art was preserved in France, in Germany and in Spain, and it seems improbable that it should have been lost in that archipelago, where the traditions of ancient civilization must have been better preserved than in almost any other place. In 523 Cassiodorus writes of the "innumerosa navigia" belonging to Venice, and where trade is active there is always a probability that manufactures will flourish. However this may be, the earliest positive evidence of the existence at Venice of a worker in glass would seem to be the mention of Petrus Flavianus, phiolarius, in the ducale of Vitale Falier in the year 1090. In 1224 twenty-nine persons are mentioned as friolari (i.e. phiolari), and in the same century "maricgole," or codes of trade regulations, were drawn up (*Monografia della vetraria Venetiana e Muranese*, p. 219). The manufacture had then no doubt attained considerable proportions: in 1268 the glass-workers became an incorporated body; in their processions they exhibited decanters, scent-bottles and the like; in 1279 they made, among other things, weights and measures. In the latter part of this century the glass-houses were almost entirely transferred to Murano. Thenceforward the manufacture continued to grow in importance; glass vessels were made in large quantities, as well as glass for windows. The earliest example which has as yet been described—a cup of blue glass, enamelled and gilt—is, however, not earlier than about 1440. A good many other examples have been preserved which may be assigned to the same century: the earlier of these bear a resemblance in form to the vessels of silver made in the west of Europe; in the later an imitation of classical forms becomes apparent. Enamel and gilding were freely used, in imitation no doubt of the much-admired vessels brought from Damascus. Dillon has pointed out that the process of enamelling had probably been derived from Syria, with which country Venice had considerable commercial intercourse. Many of the ornamental processes which we admire in Venetian glass were already in use in this century, as that of mille fiori, and the beautiful kind of glass known as "vitro di trina" or lace glass. An elaborate account of the processes of making the vitro di trina and the vasi a reticelli (Plate I., fig. 7) is given in Bontemps's *Guide du verrier*, pp. 602-612. Many of the examples of these processes exhibit surprising skill and taste, and are among the most beautiful objects produced at the Venetian furnaces. That peculiar kind of glass usually called schmelz, an imperfect imitation of calcedony, was also made at Venice in the 15th century. Aventurine glass, that in which numerous small particles of copper are diffused through a transparent yellowish or brownish mass, was not invented until about 1600.

The peculiar merits of the Venetian manufacture are the elegance of form and the surprising lightness and thinness of the substance of the vessels produced. The highest perfection with regard both to form and decoration was reached in the 16th century; subsequently the Venetian workmen somewhat abused their skill by giving extravagant forms to vessels, making drinking glasses in the forms of ships, lions, birds, whales and the like.

Besides the making of vessels of all kinds the factories of Murano had for a long period almost an entire monopoly of two other branches of the art—the making of mirrors and of beads. Attempts to make mirrors of glass were made as early as A.D. 1317, but even in the 16th century mirrors of steel were still in use. To make a really good mirror of glass two things are required—a plate free from bubbles and striae, and a method of applying a film of metal with a uniform bright surface free from defects. The principle of applying metallic films to glass seems to have been known to the Romans and even to the Egyptians, and is mentioned by Alexander Neckam in the 12th century, but it would appear that it was not until the 16th century that the process of "silvering" mirrors by the use of an amalgam of tin and mercury had been perfected. During the 16th and 17th centuries Venice exported a prodigious quantity of mirrors, but France and England gradually acquired knowledge and skill in the art, and in 1772 only one glass-house at Murano continued to make mirrors.

The making of beads was probably practised at Venice from a very early period, but the earliest documentary evidence bearing on the subject does not appear to be of earlier date than the 14th century, when prohibitions were directed against those who made of glass such objects as were usually made of crystal or other hard stones. In the 16th century it had become a trade of great importance, and about 1764 twenty-two furnaces were employed in the production of beads. Towards the end of the same century from 600 to 1000 workmen were, it is stated, employed on one branch of the art, that of ornamenting beads by the help of the blow-pipe. A very great variety of patterns was produced; a tariff of the year 1800 contains an enumeration of 562 species and a vast number of sub-species.

The efforts made in France, Germany and England, in the 17th and 18th centuries, to improve the manufacture of glass in those countries had a very injurious effect on the industry of Murano. The invention of colourless Bohemian glass brought in its train the practice of cutting glass, a method of ornamentation for which Venetian glass, from its thinness, was ill adapted. One remarkable man, Giuseppe Briati, exerted himself, with much success, both in working in the old Venetian method and also in imitating the new fashions invented in Bohemia. He was especially successful in making vases and circular dishes of vitro di trina; one of the latter in the Correr collection at Venice, believed to have been made in his glass-house, measures 55 centimetres (nearly 23 in.) in diameter. The vases made by him are as elegant in form as the best of the Cinquecento period, but may perhaps be distinguished by the superior purity and brilliancy of the glass. He also made with great taste and skill large lustres and mirrors with frames of glass ornamented either in intaglio or with foliage of various colours. He obtained a knowledge of the methods of working practised in Bohemia by disguising himself as a porter, and thus worked for three years in a Bohemian glass-house. In 1736 he obtained a patent at Venice to manufacture glass in the Bohemian manner. He died in 1772.

The fall of the republic was accompanied by interruption of trade and decay of manufacture, and in the last years of the 18th and beginning of the 19th century the glass-making of Murano was at a very low ebb. In the year 1838 Signor Bussolin revived several of the ancient processes of glass-working, and this revival was carried on by C. Pietro Biguglia in 1845, and by others, and later by Salvati, to whose successful efforts the modern renaissance of Venetian art glass is principally due.

The fame of Venice in glass-making so completely eclipsed that of other Italian cities that it is difficult to learn much respecting their progress in the art. Hartshorne and Dillon have drawn attention to the important part played by the little Ligurian town, Altare, as a centre from which glass-workers migrated to all parts of Europe. It is said that the glass industry was established at Altare, in the 11th century, by French craftsmen. In the 14th century Muranese glass-workers settled there and developed the industry. It appears that as early as 1295 furnaces had been established at Treviso, Vicenza,

Padua, Mantua, Ferrara, Ravenna and Bologna. In 1614 there were two glass-houses in Rome and one in Florence; but whether any of these produced ornamented vessels, or only articles of common use and window glass, would not appear to have as yet been ascertained.

Germany—Glass-making in Germany during the Roman period seems to have been carried on extensively in the neighbourhood of Cologne. The Cologne museum contains many specimens of Roman glass, some of which are remarkable for their cut decoration. The craft survived the downfall of the Roman power, and a native industry was developed. This industry must have won some reputation, for in 758 the abbot of Jarrow appealed to the bishop of Mainz to send him a worker in glass. There are few records of glass manufacture in Germany before the beginning of the 16th century. The positions of the factories were determined by the supply of wood for fuel, and subsequently, when the craft of glass-cutting was introduced, by the accessibility of water-power. The vessels produced by the 16th-century glass-workers in Germany, Holland and the Low Countries are closely allied in form and decoration. The glass is coloured (generally green) and the decoration consists of glass threads and glass studs, or prunts ("Nuppen"). The use of threads and prunts is illustrated by the development of the "Roemer," so popular as a drinking-glass, and as a feature in Dutch studies of still life. The "Igel," a squat tumbler covered with prunts, gave rise to the "Kraustrunk," which is like the "Igel," but longer and narrow-waisted. The "Roemer" itself consists of a cup, a short waist studded with prunts and a foot. The foot at first was formed by coiling a thread of glass round the base of the waist; but, subsequently, an open glass cone was joined to the base of the waist, and a glass thread was coiled upon the surface of the cone. The "Passglas," another popular drinking-glass, is cylindrical in form and marked with horizontal rings of glass, placed at regular intervals, to indicate the quantity of liquor to be taken at a draught.

In the edition of 1581 of the *De re metallica* by Georg Agricola, there is a woodcut showing the interior of a German glass factory, and glass vessels both finished and unfinished.

In 1428 a Muranese glass-worker set up a furnace in Vienna, and another furnace was built in the same town by an Italian in 1486. In 1531 the town council of Nuremberg granted a subsidy to attract teachers of Venetian technique. Many specimens exist of German winged and enamelled glasses of Venetian character. The Venetian influence, however, was indirect rather than direct. The native glass-workers adopted the process of enamelling, but applied it to a form of decoration characteristically German. On tall, roomy, cylindrical glasses they painted portraits of the emperor and electors of Germany, or the imperial eagle bearing on its wings the arms of the states composing the empire. The earliest-known example of these enamelled glasses bears the date 1553. They were immensely popular and the fashion for them lasted into the 18th century. Some of the later specimens have views of cities, battle scenes and processions painted in grisaille.

A more important outcome, however, of Italian influence was the production, in emulation of Venetian glass, of a glass made of refined potash, lime and sand, which was more colourless than the material it was intended to imitate. This colourless potash-lime glass has always been known as Bohemian glass. It was well adapted for receiving cut and engraved decoration, and in these processes the German craftsmen proved themselves to be exceptionally skilful. At the end of the 16th century Rudolph II. brought Italian rock-crystal cutters from Milan to take control of the crystal and glass-cutting works he had established at Prague. It was at Prague that Caspar Lehmann and Zachary Belzer learnt the craft of cutting glass. George Schwanhart, a pupil of Caspar Lehmann, started glass-cutting at Ratisbon; and about 1690 Stephen Schmidt and Hermann Schwinger introduced the crafts of cutting and engraving glass in Nuremberg. To the Germans must be credited the discovery, or development, of colourless potash-lime glass, the reintroduction of the crafts of cutting and engraving on

glass, the invention by H. Schwanhart of the process of etching on glass by means of hydrofluoric acid, and the rediscovery by J. Kunkel, who was director of the glass-houses at Potsdam in 1679, of the method of making copper-ruby glass.

Low Countries and the United Provinces.—The glass industry of the Low Countries was chiefly influenced by Italy and Spain, whereas German influence and technique predominated in the United Provinces. The history of glass-making in the provinces is almost identical with that of Germany. In the 17th and 18th centuries the processes of scratching, engraving and etching were brought to great perfection.

The earliest record of glass-making in the Low Countries consists in an account of payments made in 1453-1454 on behalf of Philip the Good of Burgundy to "Gossion de Vieuglise, Maître Vorrier de Lille" for a glass fountain and four glass plateaus. Schuermans has traced Italian glass-workers to Antwerp, Liège, Brussels and Namur. Antwerp appears to have been the headquarters of the Muranese, and Liège the headquarters of the Altarists. Guicciardini in his description of the Netherlands, in 1563, mentions glass as among the chief articles of export to England.

In 1599 the privilege of making "Voires de cristal à la faschon Venise," was granted to Philippe de Gridolph of Antwerp. In 1623 Anthony Miotti, a Muranese, addressed a petition to Philip IV. of Spain for permission to make glasses, vases and cups of fine crystal, equal to those of Venice, but to be sold at one-third less than Venetian glasses. In 1642 Jean Savonetti "gentilhomme Verrier de Murano" obtained a patent for making glass in Brussels. The Low Country glasses are closely copied from Venetian models, but generally are heavier and less elegant. Owing to the fashion of Dutch and Flemish painters introducing glass vases and drinking-glasses into their paintings of still life, interiors and scenes of conviviality, Holland and Belgium at the present day possess more accurate records of the products of their ancient glass factories than any other countries.

Spain.—During the Roman occupation Pliny states that glass was made "per Hispanias" (*Nat. Hist.* xxxvi. 26. 66). Traces of Roman glass manufactories have been found in Valencia and Murcia, in the valleys which run down to the coast of Catalonia, and near the mouth of the Ebro. Little is known about the condition of glass-making in Spain between the Roman period and the 13th century. In the 13th century the craft of glass-making was practised by the Moors in Almeria, and was probably a survival from Roman times. The system of decorating vases and vessels by means of strands of glass trailed upon the surface in knots, zigzags and trellis work, was adopted by the Moors and is characteristic of Roman craftsmanship. Glass-making was continued at Pinar de la Vidriera and at Al Castril de la Pena into the 17th century. The objects produced show no sign of Venetian influence, but are distinctly Oriental in form. Many of the vessels have four or as many as eight handles, and are decorated with serrated ornamentation, and with the trailed strands of glass already referred to. The glass is generally of a dark-green colour.

Barcelona has a long record as a centre of the glass industry. In 1324 a municipal edict was issued forbidding the erection of glass-furnaces within the city. In 1455 the glass-makers of Barcelona were permitted to form a gild. Jeronimo Paulo, writing in 1491, says that glass vessels of various sorts were sent thence to many places, and even to Rome. Marinus Siculus, writing early in the 16th century, says that the best glass was made at Barcelona; and Gaspar Baneiros, in his *Chronographia*, published in 1562, states that the glass made at Barcelona was almost equal to that of Venice and that large quantities were exported.

The author of the *Atlante español*, writing at the end of the 18th century, says that excellent glass was still made at Barcelona on Venetian models. The Italian influence was strongly felt in Spain, but Spanish writers have given no precise information as to when it was introduced or whence it came. Schuermans has, however, discovered the names of more than twenty Italians who found their way into Spain, in some cases by way of Flanders,

either from Altare or from Venice. The Spanish glass-makers were very successful in imitating the Venetian style, and many specimens supposed to have originated from Murano are really Spanish. In addition to the works at Barcelona, the works which chiefly affected Venetian methods were those of Cadalso in the province of Toledo, founded in the 16th century, and the works established in 1680 at San Martin de Valdeiglesias in Avila. There were also works at Valdeaqueda and at Villafraanca. In 1680 the works in Barcelona, Valdeaqueda and Villafraanca are named in a royal schedule giving the prices at which glass was to be sold in Madrid. In 1772 important glass works were established at Recuenco in the province of Cuenca, mainly to supply Madrid. The royal glass manufactory of La Granja de San Ildefonso was founded about 1725; in the first instance for the manufacture of mirror plates, but subsequently for the production of vases and table-ware in the French style. The objects produced are mostly of white clear glass, cut, engraved and gilded. Engraved flowers, views and devices are often combined with decorative cutting. Don Sigismundo Brun is credited with the invention of permanent gilding fixed by heat. Spanish glass is well represented in the Victoria and Albert Museum.

France.—Pliny states that glass was made in Gaul, and there is reason to believe that it was made in many parts of the country and on a considerable scale. There were glass-making districts both in Normandy and in Poitou.

Little information can be gathered concerning the glass industry between the Roman period and the 14th century. It is recorded that in the 7th century the abbot of Wearmouth in England obtained artificers in glass from France; and there is a tradition that in the 11th century glass-workers migrated from Normandy and Brittany and set up works at Altare near Genoa.

In 1302 window glass, probably crown-glass, was made at Beza le Forêt in the department of the Eure. In 1416 these works were in the hands of Robin and Leban Guichard, but passed subsequently to the Le Vaillants.

In 1338 Humbert, the dauphin, granted a part of the forest of Chamborant to a glass-worker named Guionet on the condition that Guionet should supply him with vessels of glass.

In 1466 the abbess of St Croix of Poitiers received a gross of glasses from the glass-works of La Ferrière, for the privilege of gathering fern for the manufacture of potash.

In France, as in other countries, efforts were made to introduce Italian methods of glass-working. Schuermans in his researches discovered that during the 15th and 16th centuries many glass-workers left Altare and settled in France,—the Saroldi migrated to Poitou, the Ferri to Provence, the Massari to Lorraine and the Bormioli to Normandy. In 1551 Henry II. of France established at St Germain en Laye an Italian named Mutio; he was a native of Bologna, but of Altare origin. In 1598 Henry IV. permitted two "gentil hommes verriers" from Mantua to settle at Rouen in order to make "verres de cristal, verres dorée email et autres ouvrages qui se font en Venise."

France assimilated the craft of glass-making, and her craftsmen acquired a wide reputation. Lorraine and Normandy appear to have been the most important centres. To Lorraine belong the well-known names Hennezel, de Thierry, du Thisac, de Houx; and to Normandy the names de Bongar, de Cacqueray le Vaillant and de Brossard.

In the 17th century the manufacture of mirror glass became an important branch of the industry. In 1665 a manufactory was established in the Faubourg St Antoine in Paris, and another at Tour-la-Ville near Cherbouurg.

Louis Lucas de Nehou, who succeeded de Cacqueray at the works at Tour-la-Ville, moved in 1675 to the works in Paris. Here, in 1688, in conjunction with A. Thevart, he succeeded in perfecting the process of casting plate-glass. Mirror plates previous to the invention had been made from blown "sheet" glass, and were consequently very limited in size. De Nehou's process of rolling molten-glass poured on an iron table rendered the manufacture of very large plates possible.

The Manufactoire Royale des Glaces was removed in 1693 to the Châteaux de St Gobain.

In the 18th century the manufacture of *vases de verre* had become so neglected that the Academy of Sciences in 1759 offered a prize for an essay on the means by which the industry might be revived (Labarte, *Histoire des arts industriels*).

The famous Baccarat works, for making crystal glass, were founded in 1818 by d'Arctignac.

English Glass.—The records of glass-making in England are exceedingly meagre. There is reason to believe that during the Roman occupation the craft was carried on in several parts of the country. Remains of a Roman glass manufactory of considerable extent were discovered near the Manchester Ship Canal at Warrington. Wherever the Romans settled glass vessels and fragments of glass have been found. There is no evidence to prove that the industry survived the withdrawal of the Roman garrison.

It is probable that the glass drinking-vessels, which have been found in pre-Christian Anglo-Saxon tombs, were introduced from Germany. Some are elaborate in design and bear witness to advanced technique of Roman character. In 675 Benedict Biscop, abbot of Wearmouth, was obliged to obtain glass-workers from France, and in 758 Cuthbert, abbot of Jarrow, appealed to the bishop of Mainz to send him artisans to manufacture "windows and vessels of glass, because the English were ignorant and helpless." Except for the statement in Bede that the French artisans, sent by Benedict Biscop, taught their craft to the English, there is at present no evidence of glass having been made in England between the Roman period and the 13th century. In some deeds relating to the parish of Chiddingfold, in Surrey, of a date not later than 1230, a grant is recorded of twenty acres of land to Lawrence "vitrearius," and in another deed, of about 1280, the "ovenhusveld" is mentioned as a boundary. This field has been identified, and pieces of crucible and fragments of glass have been dug up. There is another deed, dated 1300, which mentions one William "le verrier" of Chiddingfold.

About 1350 considerable quantities of colourless flat glass were supplied by John Alemayn of Chiddingfold for glazing the windows in St George's chapel, Windsor, and in the chapel of St Stephen, Westminster. The name Alemayn (Aleman) suggests a foreign origin. In 1380 John Glasewryth, a Staffordshire glass-worker, came to work at Shuerewode, Kirdford, and there made brode-glass and vessels for Joan, widow of John Shertere.

There were two kinds of flat glass, known respectively as "brode-glass" and "Normandy" glass. The former was made, as described by Theophilus, from cylinders, which were split, reheated and flattened into square sheets. It was known as Lorraine glass, and subsequently as "German sheet" or sheet-glass. Normandy glass was made from glass circles or disks. When, in after years, the process was perfected, the glass was known as "crown" glass. In 1447 English flat glass is mentioned in the contract for the windows of the Beauchamp chapel at Warwick, but disparagingly, as the contractor binds himself not to use it. In 1486, however, it is referred to in such a way as to suggest that it was superior to "Dutch, Venice or Normandy glass." The industry does not seem to have prospered, for when in 1567 an inquiry was made as to its condition, it was ascertained that only small rough goods were being made.

In the 16th century the fashion for using glass vessels of ornamental character spread from Italy into France and England. Henry VIII. had a large collection of glass drinking-vessels chiefly of Venetian manufacture. The increasing demand for Venetian drinking-glasses suggested the possibility of making similar glass in England, and various attempts were made to introduce Venetian workmen and Venetian methods of manufacture. In 1550 eight Muranese glass-blowers were working in or near the Tower of London. They had left Murano owing to slackness of trade, but had been recalled, and appealed to the Council of Ten in Venice to be allowed to complete their contract in London. Seven of these glass-workers left London in the following year, but one, Josepho Casselari, remained and joined

Thomas Cavato, a Dutchman. In 1574 Jacob Verzellini, a fugitive Venetian, residing in Antwerp, obtained a patent for making drinking-glasses in London "such as are made in Murano." He established works in Crutched Friars, and to him is probably due the introduction of the use of soda-ash, made from seaweed and seaside plants, in place of the crude potash made from fern and wood ashes. His manufactory was burnt down in 1575, but was rebuilt. He afterwards moved his works to Winchester House, Broad Street. There is a small goblet (Pl. I., fig. 8) in the British Museum which is attributed to Verzellini. It is Venetian in character, of a brownish tint, with two white enamel rings round the body. It is decorated with diamond or steel-point etching, and bears on one side the date 1586, and on the opposite side the words "In God is al mi trust." Verzellini died in 1606 and was buried at Down in Kent. In 1592 the Broad Street works had been taken over by Jerome Bowes. They afterwards passed into the hands of Sir R. Mansel, and in 1618 James Howell, author of *Epistolae Ho-eliae*, was acting as steward. The works continued in operation until 1641. During excavations in Broad Street in 1874 many fragments of glass were found; amongst them were part of a wine-glass, a square scent-bottle and a wine-glass stem containing a spiral thread of white enamel.

A greater and more lasting influence on English glass-making came from France and the Low Countries. In 1567 James Carré of Antwerp stated that he had erected two glass-houses at "Fernefol" (Fernfold Wood in Sussex) for Normandy and Lorraine glass for windows, and had brought over workmen. From this period began the records in England of the great glass-making families of Hennezel, de Thietry, du Thisac and du Houx from Lorraine, and of de Bongar and de Cacqueray from Normandy. About this time glass-works were established at Ewhurst and Alford in Surrey, Loxwood, Kirdford, Wisborough and Petworth in Sussex, and Sevenoaks and Penshurst in Kent. Beginning in Sussex, Surrey and Kent, where wood for fuel was plentiful, the foreign glass-workers and their descendants migrated from place to place, always driven by the fuel-hunger of their furnaces. They gradually made their way into Hampshire, Wiltshire, Gloucestershire, Staffordshire, Northumberland, Scotland and Ireland. They can be traced by cullet heaps and broken-down furnaces, and by their names, often mutilated, recorded in parish registers.

In 1610 a patent was granted to Sir W. Slingsby for burning coal in furnaces, and coal appears to have been used in the Broad Street works. In 1615 all patents for glass-making were revoked and a new patent issued for making glass with coal as fuel, in the names of Mansel, Zouch, Thelwall, Kellaway and Percival. To the last is credited the first introduction of covered crucibles to protect the molten glass from the products of burning coal.

Simultaneously with the issue of this patent the use of wood for melting glass was prohibited, and it was made illegal to import glass from abroad. About 1617 Sir R. Mansel, vice-admiral and treasurer of the navy, acquired the sole rights of making glass in England. These rights he retained for over thirty years.

During the protectorate all patent rights virtually lapsed, and mirrors and drinking-glasses were once more imported from Venice. In 1663 the duke of Buckingham, although unable to obtain a renewal of the monopoly of glass-making, secured the prohibition of the importation of glass for mirrors, coach plates, spectacles, tubes and lenses, and contributed to the revival of the glass industry in all its branches. Evelyn notes in his *Diary* a visit in 1675 to the Italian glass-house at Greenwich, "where glass was blown of finer metal than that of Murano," and a visit in 1677 to the duke of Buckingham's glass-works, where they made huge "vases of metal as cleare, ponderous and thick as chrysal; also looking-glasses far larger and better than any that came from Venice."

Some light is thrown on the condition of the industry at the end of the 17th century by the Houghton letters on the improvement of trade and commerce, which appeared in 1696. A few of these letters deal with the glass trade, and in one a list is

given of the glass-works then in operation. There were 88 glass factories in England which are thus classified:

Bottles	39
Looking-glass plates	2
Crown and plate-glass	5
Window glass	15
Flint and ordinary glass	27
	—
	88

It is probable that the flint-glass of that date was very different from the flint-glass of to-day. The term flint-glass is now understood to mean a glass composed of the silicates of potash and lead. It is the most brilliant and the most colourless of all glasses, and was undoubtedly first perfected in England. Hartsborne has attributed its discovery to a London merchant named Tilson, who in 1663 obtained a patent for making "crystal glass." E. W. Hulme, however, who has carefully investigated the subject, is of opinion that flint-glass in its present form was introduced about 1730. The use of oxide of lead in glass-making was no new thing; it had been used, mainly as a flux, both by Romans and Venetians. The invention, if it may be regarded as one, consisted in eliminating lime from the glass mixture, substituting refined potash for soda, and using a very large proportion of lead oxide. It is probable that flint-glass was not invented, but gradually evolved, that potash-lead glasses were in use during the latter part of the 17th century, but that the mixture was not perfected until the middle of the following century.

The 18th century saw a great development in all branches of glass-making. Collectors of glass are chiefly concerned with the drinking-glasses which were produced in great profusion and adapted for every description of beverage. The most noted are the glasses with stout cylindrical legs (Plate I. fig. 9), containing spiral threads of air, or of white or coloured enamel. To this type of glass belong many of the Jacobite glasses which commemorate the old or the young Pretender.

In 1746 the industry was in a sufficiently prosperous condition to tempt the government to impose an excise duty. The report of the commission of excise, dealing with glass, published in 1835 is curious and interesting reading. So burdensome was the duty and so vexatious were the restrictions that it is a matter for wonder that the industry survived. In this respect England was more fortunate than Ireland. Before 1825, when the excise duty was introduced into Ireland, there were flourishing glass-works in Belfast, Cork, Dublin and Waterford. By 1850 the Irish glass industry had been practically destroyed. Injurious as the excise duty undoubtedly was to the glass trade generally, and especially to the flint-glass industry, it is possible that it may have helped to develop the art of decorative glass-cutting. The duty on flint-glass was imposed on the molten glass in the crucibles and on the unfinished goods. The manufacturer had, therefore, a strong inducement to enhance by every means in his power the selling value of his glass after it had escaped the exciseman's clutches. He therefore employed the best available art and skill in improving the craft of glass-cutting. It is the development of this craft in connexion with the perfecting of flint-glass that makes the 18th century the most important period in the history of English glass-making. Glass-cutting was a craft imported from Germany, but the English material so greatly surpassed Bohemian glass in brilliance that the Bohemian cut-glass was eclipsed. Glass-cutting was carried on at works in Birmingham, Bristol, Belfast, Cork, Dublin, Glasgow, London, Newcastle, Stourbridge, Whittington and Waterford. The most important centres of the craft were London, Bristol, Birmingham and Waterford (see Plate I., fig. 10, for oval cut-glass Waterford bowl). The finest specimens of cut-glass belong to the period between 1780 and 1810. Owing to the sacrifice of form to prismatic brilliance, cut-glass gradually lost its artistic value. Towards the middle of the 19th century it became the fashion to regard all cut-glass as barbarous, and services of even the best period were neglected and dispersed. At the present time scarcely anything is known about the origin of the few specimens of 18th-century English cut-glass

which have been preserved in public collections. It is strange that so little interest has been taken in a craft in which for some thirty years England surpassed all competitors, creating a wave of fashion which influenced the glass industry throughout the whole of Europe.

In the report of the Excise Commission a list is given of the glass manufactories which paid the excise duty in 1833. There were 105 factories in England, 10 in Scotland and 10 in Ireland. In England the chief centres of the industry were Bristol, Birmingham, London, Manchester, Newcastle, Stourbridge and York. Plate-glass was made by Messrs Cookson of Newcastle, and by the British Plate Glass Company of Ravenhead. Crown and German sheet-glass were made by Messrs Chance & Hartley of Birmingham. The London glass-works were those of Apsley Pellatt of Blackfriars, Christie of Stangate, and William Holmes of Whitefriars. In Scotland there were works in Glasgow, Leith and Portobello. In Ireland there were works in Belfast, Cork, Dublin and Waterford. The famous Waterford works were in the hands of Gatchell & Co.

India.—Pliny states (*Nat. Hist.* xxxvi. 26. 66) that no glass was to be compared to the Indian, and gives as a reason that it was made from broken crystal; and in another passage (xii. 19. 42) he says that the Troglodytes brought to Ocelis (Ghella near Bab-el-Mandeb) objects of glass. We have, however, very little knowledge of Indian glass of any considerable antiquity. A few small vessels have been found in the "topes," as in that at Manikiala in the Punjab, which probably dates from about the Christian era; but they exhibit no remarkable character, and fragments found at Brahmanabad are hardly distinguishable from Roman glass of the imperial period. The chronicle of the Sinhalese kings, the *Mahavamsa*, however, asserts that mirrors of glittering glass were carried in procession in 306 B.C., and beads like gems, and windows with ornaments like jewels, are also mentioned at about the same date. If there really was an important manufacture of glass in Ceylon at this early time, that island perhaps furnished the Indian glass of Pliny. In the later part of the 17th century some glass decorated with enamel was made at Delhi. A specimen is in the Indian section of the South Kensington Museum. Glass is made in several parts of India—as Patna and Mysore—by very simple and primitive methods, and the results are correspondingly defective. Black, green, red, blue and yellow glasses are made, which contain a large proportion of alkali and are readily fusible. The greater part is worked into bangles, but some small bottles are blown (Buchanan, *Journey through Mysore*, i. 147, iii. 369).

Persia.—No very remarkable specimens of Persian glass are known in Europe, with the exception of some vessels of blue glass richly decorated with gold. These probably date from the 17th century, for Chardin tells us that the windows of the tomb of Shah Abbas II. (*ob.* 1666), at Kum, were "de cristal peint d'or et d'azur." At the present day bottles and drinking-vessels are made in Persia which in texture and quality differ little from ordinary Venetian glass of the 16th or 17th centuries, while in form they exactly resemble those which may be seen in the engravings in Chardin's *Travels*.

China.—The history of the manufacture of glass in China is obscure, but the common opinion that it was learnt from the Europeans in the 17th century seems to be erroneous. A writer in the *Mémoires concernant les Chinois* (ii. 46) states on the authority of the annals of the Han dynasty that the emperor Wu-ti (140 B.C.) had a manufactory of the kind of glass called "lieou-li" (probably a form of opaque glass), that in the beginning of the 3rd century of our era the emperor Tsou-tsaou received from the West a considerable present of glasses of all colours, and that soon after a glass-maker came into the country who taught the art to the natives.

The Wei dynasty, to which Tsou-tsaou belonged, reigned in northern China, and at this day a considerable manufacture of glass is carried on at Po-shan-hien in Shantung, which it would seem has existed for a long period. The Rev. A. Williamson (*Journeys in North China*, i. 131) says that the glass is extremely pure, and is made from the rocks in the neighbourhood:

The rocks are probably of quartz, *i.e.* rock crystal, a correspondence with Pliny's statement respecting Indian glass which seems deserving of attention.

Whether the making of glass in China was an original discovery of that ingenious people, or was derived via Ceylon from Egypt, cannot perhaps be now ascertained; the manufacture has, however, never greatly extended itself in China. The case has been the converse of that of the Romans; the latter had no fine pottery, and therefore employed glass as the material for vessels of an ornamental kind, for table services and the like. The Chinese, on the contrary, having from an early period had excellent porcelain, have been careless about the manufacture of glass. A Chinese writer, however, mentions the manufacture of a huge vase in A.D. 627, and in 1154 Edrissi (first climate, tenth section) mentions Chinese glass. A glass vase about a foot high is preserved at Nara in Japan, and is alleged to have been placed there in the 8th century. It seems probable that this is of Chinese manufacture. A writer in the *Mémoires concernant les Chinois* (ii. 463 and 477), writing about 1770, says that there was then a glass-house at Peking, where every year a good number of vases were made, some requiring great labour because nothing was blown (*rien n'est soufflé*), meaning no doubt that the ornamentation was produced not by blowing and moulding, but by cutting. This factory was, however, merely an appendage to the imperial magnificence. The earliest articles of Chinese glass the date of which has been ascertained, which have been noticed, are some bearing the name of the emperor Kienlung (1735-1795), one of which is in the Victoria and Albert Museum.

In the manufacture of ornamental glass the leading idea in China seems to be the imitation of natural stones. The coloured glass is usually not of one bright colour throughout, but semi-transparent and marbled; the colours in many instances are singularly fine and harmonious. As in 1770, carving or cutting is the chief method by which ornament is produced, the vessels being blown very solid.

BIBLIOGRAPHY.—Georg Agricola, *De re metallica* (Basel, 1556); Percy Bate, *English Table Glass* (n.d.); G. Bontemps, *Guide du verrier* (Paris, 1868); Edward Dillon, *Glass* (London, 1907); C. C. Edgar, "Græco-Egyptian Glass," *Catalogue du Musée du Caire* (1905); Sir A. W. Franks, *Guide to Glass Room in British Museum* (1888); Rev. A. Hallen, "Glass-making in Sussex," *Scottish Antiquary*, No. 28 (1893); Albert Hartshorne, *Old English Glasses* (London); E. W. Hulme, "English Glass-making in XVI. and XVII. Centuries," *The Antiquary*, Nos. 59, 60, 63, 64, 65; Alexander Nesbitt, "Glass," *Art Handbook*, Victoria and Albert Museum; E. Peligot, *Le Verre, son histoire, sa fabrication* (Paris, 1878); Apsley Pellatt, *Curiosities of Glass-making* (London, 1849); F. Petrie, *Tell-el-Amarna, Egypt Exploration Fund* (1894); "Egypt," *sect. Art*; H. J. Powell, "Cut Glass," *Journal Society of Arts*, No. 2795; C. H. Read, "Sarcenic Glass," *Archæologia*, vol. 58, part 1.; Juan F. Riano, "Spanish Arts," *Art Handbook*, Victoria and Albert Museum; H. Schuermans, "Muranese and Altarist Glass Workers," eleven letters: *Bulletins des commissions royales* (Brussels, 1883, 1891). For the United States, see vol. x. of *Reports of the 12th Census*, pp. 949-1000, and *Special Report of Census of Manufactures* (1905), Part III., pp. 937-935. (A. N.S.; H. J. P.)

GLASS, STAINED. All coloured glass is, strictly speaking, "stained" by some metallic oxide added to it in the process of manufacture. But the term "stained glass" is popularly, as well as technically, used in a more limited sense, and is understood to refer to stained glass windows. Still the words "stained glass" do not fully describe what is meant; for the glass in coloured windows is for the most part not only stained but painted. Such painting was, however, until comparatively modern times, used only to give details of drawing and to define form. The colour in a stained glass window was not painted on the glass but incorporated in it, mixed with it in the making—whence the term "pot-metal" by which self-coloured glass is known, *i.e.* glass coloured in the melting pot.

A mediæval window was consequently a patchwork of variously coloured pieces. And the earlier its date the more surely was it a mosaic, not in the form of tesserae, but in the manner known as "opus sectile." Shaped pieces of coloured glass were, that is to say, put together like the parts of a puzzle. The

nearest approach to an exception to this rule is a fragment at the Victoria and Albert Museum, in which actual tesserae are fused together into a solid slab of many-coloured glass, in effect a window panel, through which the light shines with all the brilliancy of an Early Gothic window. But apart from the fact that the design proves in this case to be even more effective with the light upon it, the use of gold leaf in the tesserae confirms the presumption that this work, which (supposing it to be genuine) would be Byzantine, centuries earlier than any coloured windows that we know of, and entirely different from them in technique, is rather a specimen of fused mosaic that happens to be translucent than part of a window designedly executed in tesserae.

The Eastern (and possibly the earlier) practice was to set chips of coloured glass in a heavy fretwork of stone or to imbed them in plaster. In a mediæval window they were held together by strips of lead, in section something like the letter H, the upright strokes of which represent the "tapes" extending on either side well over the edges of the glass, and the crossbar the connecting "core" between them. The leading was soldered together at the points of junction, cement or putty was rubbed into the crevices between glass and lead, and the window was attached (by means of copper wires soldered on to the leads) to iron saddle-bars let into the masonry.

Stained glass was primarily the art of the glazier; but the painter, called in to help, asserted himself more and more, and eventually took it almost entirely into his own hands. Between the period when it was glazier's work eked out by painting and when it was painter's work with the aid of the glazier lies the entire development of stained and painted window-making. With the eventual endeavour of the glass painter to do without the glazier, and to get the colour by painting in translucent enamel upon colourless glass, we have the beginning of a form of art no longer monumental and comparatively trivial.

This evolution of the painted window from a patchwork of little pieces of coloured glass explains itself when it is remembered that coloured glass was originally not made in the big sheets produced nowadays, but at first in jewels to look as much as possible like rubies, sapphires, emeralds and other precious stones, and afterwards in rounds and sheets of small dimensions. Though some of the earliest windows were in the form of pure glazing ("leaded-lights"), the addition of painting seems to have been customary from the very first. It was a means of rendering detail not to be got in lead. Glazing affords by itself scope for beautiful pattern work; but the old glaziers never carried their art as far as they might have done in the direction of ornament; their aim was always in the direction of picture; the idea was to make windows serve the purpose of coloured story books. That was beyond the art of the glazier. It was easy enough to represent the drapery of a saint by red glass, the ground on which he stood by green, the sky above by blue, his crown by yellow, the scroll in his hand by white, and his flesh by brownish pink; but when it came to showing the folds of red drapery, blades of green grass, details of goldsmith's work, lettering on the scroll, the features of the face—the only possible way of doing it was by painting. The use of paint was confined at first to an opaque brown, used, not as colour, but only as a means of stopping out light, and in that way defining comparatively delicate details within the lead lines. These themselves outlined and defined the main forms of the design. The pigment used by the glass painter was of course vitreous: it consisted of powdered glass and sundry metallic oxides (copper, iron, manganese, &c.), so that, when the pieces of painted glass were made red hot in the kiln, the powdered glass became fused to the surface, and with it the dense colouring matter also. When the pieces of painted glass were afterwards glazed together and seen against the light, the design appeared in the brilliant colour of the glass, its forms drawn in the uniform black into which, at a little distance, leadwork and painting lines became merged.

It needed solid painting to stop out the light entirely: thin paint only obscured it. And, even in early glass, thin paint was used, whether to subdue crude colour or to indicate what little

shading a 13th-century draughtsman might desire. In the present state of old glass, the surface often quite disintegrated, it is difficult to determine to what extent thin paint was used for either purpose. There must always have been the temptation to make tint do instead of solid lines; but the more workmanlike practice, and the usual one, was to get difference of tint, as a pen-draughtsman does, by lines of solid opaque colour. In comparatively colourless glass (*grisaille*) the pattern was often made to stand out by cross-hatching the background, and another common practice was to coat the glass with paint all over, and scrape the design out of it. The effect of either proceeding was to lower the tone of the glass without dirtying the colour, as a smear of thin paint would do.

Towards the 14th century, when Gothic design took a more naturalistic direction, the desire to get something like modelling made it necessary to carry painting farther, and they got rid to some extent of the ill effect of shading-colour smeared on the glass by stippling it. This not only softened the tint and allowed of gradation according to the amount of stippling, but let some light through, where the bristles of the stippling-tool took up the pigment. Shading of this kind enforced by touches of strong brushwork, cross-hatching and some scratching out of high lights was the method of glass painting adopted in the 14th century.

Glass was never at the best a pleasant surface to paint on; and glass painting, following the line of least resistance, developed in the later Gothic and early Renaissance periods into something unlike any other form of painting. The outlines continued to be traced upon the glass and fixed in the fire; but, after that, the process of painting consisted mainly in the removal of paint. The entire surface of the glass was coated with an even "matt" of pale brown; this was allowed to dry; and then the high lights were rubbed off, and the modelling was got by scrubbing away the paint with a dry hog-hair brush, more or less, according to the gradations required. Perfect modelling was got by repeating the operation—how often depended upon the dexterity of the painter. A painter's method is partly the outcome of his individuality. One man would float on his colour and manipulate it to some extent in the moist state; another would work entirely upon the dry matt. Great use was made of the pointed stick with which sharp lines of light were easily scraped out; and in the 16th century Swiss glass painters, working upon a relatively small scale, got their modelling entirely with a needle-point, scraping away the paint just as an etcher scratches away the varnish from his etching plate. The practice of the two craftsmen is, indeed, identical, though the one scratches out what are to be black lines and the other lines of light. In the end, then, though a painter would always use touches of the brush to get crisp lines of dark, the manipulation of glass painting consisted more in erasing lights than in painting shadows, more in rubbing out or scraping off paint than in putting it on in brush strokes.

So far there was no thought of getting colour by means of paint. The colour was in the glass itself, permeating the mass ("pot-metal"). There was only one exception to this—ruby glass, the colour of which was so dense that red glass thick enough for its purpose would have been practically obscure; and so they made a colourless pot-metal coated on one side only with red glass. This led to a practice which forms an exception to the rule that in "pot-metal" glass every change of colour, or from colour to white, is got by the use of a separate piece of glass. It was possible in the case of this "flushed" ruby to grind away portions of the surface and thus obtain white on red or red on white. Eventually they made coated glass of blue and other colours, with a view to producing similar effects by abrasion. (The same result is arrived at nowadays by means of etching. The skin of coloured glass, in old days laboriously ground or cut away, is now easily eaten off by fluoric acid.) One other exceptional expedient in colouring had very considerable effect upon the development of glass design from about the beginning of the 14th century. The discovery that a solution of silver applied to glass would under the action of the

fire stain it yellow enabled the glass painter to get yellow upon colourless glass, green upon grey-blue, and (by staining only the abraded portions) yellow upon blue or ruby. This yellow was neither enamel nor pot-metal colour, but stain—the only staining actually done by the glass painter as distinct from the glass maker. It varied in colour from pale lemon to deep orange, and was singularly pure in quality. As what is called "white" glass became purer and was employed in greater quantities it was lavishly used; so much so that a brilliant effect of silvery white and golden yellow is characteristic of later Gothic windows.

The last stage of glass painting was the employment of enamel not for stopping out light but to get colour. It began to be used in the early part of the 16th century—at first only in the form of a flesh tint; but it was not long before other colours were introduced. This use of colour no longer is the glass but upon it marks quite a new departure in technique. Enamel colour was finely powdered coloured glass mixed with gum or some such substance into a pigment which could be applied with a brush. When the glass painted with it was brought to a red heat in the oven, the powdered glass melted and was fused to it, just like the opaque brown employed from the very beginning of glass-painting.

This process of enamelling was hardly called for in the interests of art. Even the red flesh-colour (borrowed from the Limoges enamellers upon copper) did not in the least give the quality of flesh, though it enabled the painter to suggest by contrast the whiteness of a man's beard. As for the brighter enamel colours, they had nothing like the depth or richness of "stained" glass. What enamel really did was to make easy much that had been impossible in mosaic, as, for example, to represent upon the very smallest shield of arms any number of "charges" all in the correct tinctures. It encouraged the minute workmanship characteristic of Swiss glass painting; and, though this was not altogether inappropriate to domestic window panes, the painter was tempted by it to depart from the simplicity and breadth of design inseparable from the earlier mosaic practice. In the end he introduced coloured glass only where he could hardly help it, and glazed the great part of his window in rectangular panes of clear glass, upon which he preferred to paint his picture in opaque brown and translucent enamel colours.

Enamel upon glass has not stood the test of time. Its presence is usually to be detected in old windows by specks of light shining through the colour. This is where the enamel has crumbled off. There is a very good reason for that. Enamel must melt at a temperature at which the glass it is painted on keeps its shape. The lower the melting point of the powdered glass the more easily it is fused. The painter is consequently inclined to use enamel of which the contraction and expansion is much greater than that of his glass—with the result that, under the action of the weather, the colour is apt to work itself free and expose the bare white glass beneath. The only enamel which has held its own is that of the Swiss glass-painters of the 16th and 17th centuries. The domestic window panes they painted may not in all cases have been tried by the sudden changes of atmosphere to which church windows are subject; but credit must be given them for exceptionally skilful and conscientious workmanship.

The story of stained glass is bound up with the history of architecture, to which it was subsidiary, and of the church, which was its patron. Its only possible course of development was in the wake of church building. From its very inception it was Gothic and ecclesiastical. And, though it survived the upheaval of the Renaissance and was turned to civil and domestic use, it is to church windows that we must go to see what stained glass really was—or is; for time has been kind to it. The charm of mediæval glass lies to a great extent in the material, and especially in the inequality of it. Chemically impure and mechanically imperfect, it was rarely crude in tint or even in texture. It shaded off from light to dark according to its thickness; it was speckled with air bubbles; it was streaked and clouded; and all these imperfections of manufacture went to perfection of colour. And age has improved it: the want of homogeneity in the material has led to the disintegration of its surface; soft particles

in it have been dissolved away by the action of the weather, and the surface, pitted like an oyster-shell, refracts the light in a way which adds greatly to the effect; at the same time there is foothold for the lichen which (like the curtains of black cobwebs) veils and gives mystery to the colour. An appreciable part of the beauty of old glass is the result of age and accident. In that respect no new glass can compare with it. There is, however, no such thing as "the lost secret" of glass-making. It is no secret that age mellows.

Stained and painted glass is commonly apportioned to its "period," Gothic or Renaissance, and further to the particular phase of the style to which it belongs. C. Winston, who was the first to inquire thoroughly into English glass, adopting T. Rickman's classification, divided Gothic windows into Early English (to c. 1280), Decorated (to c. 1380) and Perpendicular (to c. 1530). These dates will do. But the transition from one phase of design to another is never so sudden, nor so easily defined, as any table of dates would lead us to suppose. The old style lingered in one district long after the new fashion was flourishing in another. Besides, the English periods do not quite coincide with those of other countries. France, Germany and the Low Countries count for much in the history of stained glass; and in no two places was the pace of progress quite the same. There was, for example, scarcely any 13th-century Gothic in Germany, where the "geometric" style, equivalent to our Decorated, was preceded by the Romanesque period; in France, the Flamboyant took the place of our Perpendicular; and in Italy Gothic never properly took root at all. All these considered, a rather rough and ready division presents the least difficulty to the student of old glass; and it will be found convenient to think of Gothic glass as (1) Early, (2) Middle and (3) Late, and of the subsequent windows as (1) Renaissance and (2) Late Renaissance. The three periods of Gothic correspond approximately to the 13th, 14th and 15th centuries. The limits of the two periods of the Renaissance are not so easily defined. In the first part of the 16th century (in Italy long before that) the Renaissance and Gothic periods overlapped; in the latter part of it, glass painting was already on the decline; and in the 17th and 18th centuries it sank to deeper depths of degradation.

The likeness of early windows to translucent enamel (which is also glass) is obvious. The lines of lead glazing correspond absolutely to the "cloisons" of Byzantine goldsmith's work. Moreover, the extreme minuteness of the leading (not always either mechanically necessary or architecturally desirable) suggests that the starting point of all this gorgeous illumination was the idea of reproducing on a grandiose scale the jewelled effect produced in small by cloisonné enamellers. In other respects the earliest glass shows the influence of Byzantine tradition. It is mainly according to the more or less Byzantine character of its design and draughtsmanship that archaeologists ascribe certain remains of old glass to the 12th or the 11th century. Apart from documentary or direct historic evidence, it is not possible to determine the precise date of any particular fragment. In the "restored" windows at St Denis there are remnants of glass belonging to the year 1108. Elsewhere in France (Reims, Anger, Le Mans, Chartres, &c.) there is to be found very early glass, some of it probably not much later than the end of the 10th century, which is the date confidently ascribed to certain windows at St Remi (Reims) and at Tegernsee. The rarer the specimen the greater may be its technical and antiquarian interest. But, even if we could be quite sure of its date, there is not enough of this very early work, and it does not sufficiently distinguish itself from what followed, to count artistically for much. The glory of early glass belongs to the 13th century.

The design of windows was influenced, of course, by the conditions of the workshop, by the nature of glass, the difficulty of shaping it, the way it could be painted, and the necessity of lead glazing. The place of glass in the scheme of church decoration led to a certain severity in the treatment of it. The growing desire to get more and more light into the churches, and the consequent manufacture of purer and more transparent

glass, affected the glazier's colour scheme. For all that, the fashion of a window was, *mutatis mutandis*, that of the painting, carving, embroidery, goldsmith's work, enamel and other craftsmanship of the period. The design of an ivory triptych is very much that of a three-light window. There is a little enamelled shrine of German workmanship in the Victoria and Albert Museum which might almost have been designed for glass; and the famous painted ceiling at Hildesheim is planned precisely on the lines of a medallion window of the 13th century. By that time glass had fallen into ways of its own, and there were already various types of design which we now recognize as characteristic of the first great period, in some respects the greatest of all.

Pre-eminently typical of the first period is the "medallion window." Glaziers began by naively accepting the iron bars across the light as the basis of their composition, and planned a window as a series of panels, one above the other, between the horizontal crossbars and the upright lines of the border round it. The next step was to mitigate the extreme severity of this composition by the introduction of a circular or other medallion within the square boundary lines. Eventually these were abandoned altogether, the iron bars were shaped according to the pattern, and there was evolved the "medallion window," in which the main divisions of the design are emphasized by the strong bands of iron round them. Medallions were invariably devoted to picturing scenes from Bible history or from the lives of the saints, set forth in the simplest and most straightforward manner, the figures all on one plane, and as far as possible clear-cut against a sapphire-blue or ruby-red ground. Scenery was not so much depicted as suggested. An arch or two did duty for architecture, any scrap of foliated ornament for landscape. Simplicity of silhouette was absolutely essential to the readableness of pictures on the small scale allowed by the medallion. As it is, they are so difficult to decipher, so confused and broken in effect, as to give rise (the radiating shape of "rose windows" aiding) to the misconception that the design of early glass is kaleidoscopic—which it is not. The intervals between subject medallions were filled in England (Canterbury) with scrollwork, in France (Chartres) more often with geometric diaper, in which last sometimes the red and blue merge into an unpleasant purple. Design on this small scale was obviously unsuited to distant windows. Clerestory lights were occupied by figures, sometimes on a gigantic scale, entirely occupying the window, except for the border and perhaps the slightest pretence of a niche. This arrangement lent itself to broad effects of colour. The drawing may be rude; at times the figures are grotesque; but the general impression is one of mysterious grandeur and solemnity.

The depth and intensity of colour in the windows so far described comes chiefly from the quality of the glass, but partly also from the fact that very little white or pale-coloured glass was used. It was not the custom at this period to dilute the colour of a rich window with white. If light was wanted they worked in white, enlivened, it might be, by colour. Strictly speaking, 13th-century glass was never colourless, but of a greenish tint, due to impurities in the sand, potash or other ingredients; it was of a horny consistency, too; but it is convenient to speak of all would-be-clear glass as "white." The greyish windows in which it prevails are technically described as "in grisaille." There are examples (Salisbury, Châlons, Bonlieu, Angers) of "plain glazing" in grisaille, in which the lead lines make very ingenious and beautiful pattern. In the more usual case of *painted* grisaille the lead lines still formed the groundwork of the design, though supplemented by foliated or other detail, boldly outlined in strong brown and emphasized by a background of cross-hatching. French grisaille was frequently all in white (Reims, St Jean-aux-Bois, Sens), English work was usually enlivened by bands and bosses of colour (Salisbury); but the general effect of the window was still grey and silvery, even though there might be distributed about it (the "five sisters," York minster) a fair amount of coloured glass. The use of grisaille is sufficiently accounted for by considerations of economy and the desire to get light; but it was also in some sort a protest (witness the Cistercian interdict of 1134) against undue indulgence

in the luxury of colour. At this stage of its development it was confined strictly to patternwork; figure subjects were always in colour. For all that, some of the most restful and entirely satisfying work of the 13th century was in grisaille (Salisbury, Chartres, Reims, &c.).

The second or Middle period of Gothic glass marks a stage between the work of the Early Gothic artist who thought out his design as glazing, and that of the later draughtsman who conceived it as something to be painted. It represents to many the period of greatest interest—probably because of its departure from the severity of Early work. It was the period of more naturalistic design; and a touch of nature is more easily appreciated than architectural fitness. Middle Gothic glass, halting as it does between the relatively rude mosaic of early times and the painter-like accomplishment of fully-developed glass painting, has not the salient merits of either. In the matter of tone also it is intermediate between the deep, rich, sober harmonies of Early windows and the lighter, brighter, gayer colouring of later glass. Now for the first time grisaille ornament and coloured figurework were introduced into the same window. And this was done in a very judicious way, in alternate bands of white and deep rich colour, binding together the long lights into which windows were by this time divided (chapter-house, York minster). A similar horizontal tendency of design is noticeable in windows in which the figures are enshrined under canopies, henceforth a feature in glass design. The pinnaclework falls into pronounced bands of brassy yellow between the tiers of figures (nave, York minster) and serves to correct the vertical lines of the masonry. Canopywork grew sometimes to such dimensions as quite to overpower the figure it was supposed to frame; but, then, the sense of scale was never a directing factor in Decorated design. A more interesting form of ornament is to be found in Germany, where it was a pleasing custom (Regensburg) to fill windows with conventional foliage without figurework. There is abundance of Middle Gothic glass in England (York, Wells, Ely, Oxford), but the best of it, such as the great East window at Gloucester cathedral, has features more characteristic of the 15th than of the 14th century.

The keynote of Late Gothic glass is brilliancy. It had a silvery quality. The 15th century was the period of white glass, which approached at last to colourlessness, and was employed in great profusion. Canopywork, more universal than ever, was represented almost entirely in white touched with yellow stain, but not in sufficient quantities to impair its silveriness. Whatever the banality of the idea of imitation stonework in glass, the effect of thus framing coloured pictures in delicate white is admirable: at last we have white and colour in perfect combination. Fifteenth-century figurework contains usually a large proportion of white glass; flesh tint is represented by white; there is white in the drapery; in short, there is always white enough in the figures to connect them with the canopywork and make the whole effect one. The preponderance of white will be better appreciated when it is stated that very often not a fifth or sixth part of the glass is coloured. It is no uncommon thing to find figures draped entirely in white with only a little colour in the background; and figurework all in grisaille upon a ground of white latticework is quite characteristic of Perpendicular glass.

One of the most typical forms of Late English Gothic canopy is where (York minster) its slender pinnacles fill the upper part of the window, and its solid base frames a picture in small of some episode in the history of the personage depicted as large as life above. A much less satisfactory continental practice was to enrich only the lower half of the window with stained glass and to make shift above (Munich) with "roundels" of plain white glass, the German equivalent for diamond latticework.

A sign of later times is the way pictures spread beyond the confines of a single light. This happened by degrees. At first the connexion between the figures in separate window openings was only in idea, as when a central figure of the crucified Christ was flanked by the Virgin and St John in the side lights. Then the arms of the cross would be carried through, or as it were

behind, the mullions. The expansion to a picture right across the window was only a question of time. Not that the artist ventured as yet to disregard the architectural setting of his picture—that happened later on—but that he often composed it with such cunning reference to intervening stonework that it did not interfere with it. It has been argued that each separate light of a window ought to be complete in itself. On the other hand it has proved possible to make due acknowledgment of architectural conditions without cramping design in that way. There can be no doubt as to the variety and breadth of treatment gained by accepting the whole window as field for a design. And, when a number of lights go to make a window, it is the window, and no separate part of it, which is the main consideration.

By the end of the Gothic period, glass painters proceeded on an entirely different method from that of the 13th century. The designer of early days began with glazing; he thought in mosaic and leadwork; the lines he first drew were the lines of glazing; painting was only a supplementary process, enabling him to get what lead lines would not give. The Late Gothic draughtsman began with the idea of painting; glazing was to him of secondary importance; he reached a stage (Creation window, Great Malvern) where it is clear that he first sketched out his design, and then bethought him how to glaze it in such wise that the leadwork (which once boldly outlined everything) should not interfere with the picture. The artful way in which he would introduce little bits of colour into a window almost entirely white, makes it certain that he had always at the back of his mind the consideration of the glazing to come. So long as he thought of that, and did not resent it, all was fairly well with glass painting, but there came a point where he found it difficult, if not impossible, to reconcile the extreme delicacy of his painting upon white glass with the comparatively brutal strength of his lead lines. It is here that the conditions of painting and glazing clash at last.

It must not be supposed that Late Gothic windows were never by any chance rich in colour. Local conservatism and personal predilection prevented anything like monotonous progress in a single direction. There is (St Sebald, Nuremberg) Middle Gothic glass as dense in colour as any 13th-century work, and Late Gothic (Troyes cathedral) which, from its colour, one might take at first to be a century earlier than it is. In Italy (Florence) and to some extent in Spain (Seville) it was the custom to make canopywork so rich in colour that it was more like part of the picture than a frame to it. But that was by exception. The tendency was towards lighter windows. Glass itself was less deeply stained when painters depended more upon their power of deepening it by paint. It was the seeking after delicate effects of painting, quite as much as the desire to let light into the church, which determined the tone of later windows. The clearer the glass the more scope it gave for painting.

It is convenient to draw a line between Gothic art and Renaissance. Nothing is easier than to say that windows in which crocketed canopywork occurs are Gothic, and that those with arabesque are Renaissance. But that is an arbitrary distinction, which does not really distinguish. Some of the most beautiful work in glass, such for example as that at Auch, is so plainly intermediate between two styles that it is impossible to describe it as anything but "transitional." And, apart from particular instances, we have only to look at the best Late Gothic work to see that it is informed by the new spirit, and at fine Renaissance glass to observe how it conforms to Gothic traditions of workmanship. The new idea gave a spurt to Gothic art; and it was Gothic impetus which carried Renaissance glass painting to the summit of accomplishment reached in the first half of the 16th century. When that subsided, and the pictorial spirit of the age at last prevailed, the bright days of glass were at an end. If we have to refer to the early Renaissance as the culminating period of glass painting, it is because the technique of an earlier period found in it freer and fuller expression. With the Renaissance, design broke free from the restraints of tradition.

An interesting development of Renaissance design was the framing of pictures in golden-yellow arabesque ornament,

scarcely architectural enough to be called canopywork, and reminiscent rather of beaten goldsmith's work than of stone carving. This did for the glass picture what a gilt frame does for a painting in oil. Very often framework of any kind was dispensed with. The primitive idea of accepting bars and mullions as boundaries of design, and filling the compartments formed by them with a medley of little subjects, lingered on. The result was delightfully broken colour, but inevitable confusion; for iron and masonry do not effectively separate glass pictures. There was no longer in late glass any pretence of preserving the plane of the window. It was commonly designed to suggest that one saw out of it. Throughout the period of the Renaissance, architectural and landscape backgrounds play an important part in design. An extremely beautiful feature in early 16th-century French glass pictures (Rouen, &c.) is the little peep of distant country delicately painted upon the pale-blue glass which represents the sky. In larger work landscape and architecture were commonly painted upon white (King's College, Cambridge). The landscape effect was always happiest when one or other of these conventions was adopted. Canopywork never went quite out of fashion. For a long while the plan was still to frame coloured pictures in white. Theoretically this is no less effectually to be done by Italian than by Gothic shrine-work. Practically the architectural setting assumed in the 16th century more and more the aspect of background to the figures, and, in order that it should take its place in the picture, they painted it so heavily that it no longer told as white. Already in van Orley's magnificent transept windows at St Gudule, Brussels, the great triumphal arch behind the kneeling donors and their patron saints (in late glass donors take more and more the place of holy personages) tells dark against the clear ground. There came a time, towards the end of the century, when, as in the wonderful windows at Gouda, the very quality of white glass is lost in heavily painted shadow.

The pictorial ambition of the glass painter, active from the first, was kept for centuries within the bounds of decoration. Medallion subjects were framed in ornament, standing figures in canopywork, and pictures were conceived with regard to the window and its place in architecture. Severity of treatment in design may have been due more to the limitations of technique than to restraint on the part of the painter. The point is that it led to unsurpassed results. It was by absolute reliance upon the depth and brilliancy of self-coloured glass that all the beautiful effects of early glass were obtained. We need not compare early mosaic with later painted glass; each was in its way admirable; but the early manner is the more peculiar to glass, if not the more proper to it. The ruder and more archaic design gives in fullest measure the glory of glass—for the loss of which no quality of painting ever got in glass quite makes amends. The pictorial effects compatible with glass design are those which go with pure, brilliant and translucent colour. The ideal of a "primitive" Italian painter was more or less to be realized in glass: that of a Dutch realist was not. It is astonishing what glass painters did in the way of light and shade. But the fact remains that heavy painting obscured the glass, that shadows rendered in opaque surface-colour lacked translucency, and that in seeking before all things the effects of shadow and relief, glass painters of the 17th century fell short of the qualities on the one hand of glass and on the other of painting.

The course of glass painting was not so even as this general survey of its progress might seem to imply. It was quickened here, impeded there, by historic events. The art made a splendid start in France; but its development was stayed by the disasters of war, just when in England it was thriving under the Plantagenets. It revived again under Francis I. In Germany it was with the prosperity of the free cities of the Empire that glass painting prospered. In the Netherlands it blossomed out under the favour of Charles V. In the Swiss Confederacy its direction was determined by civil and domestic instead of church patronage. In most countries there were in different districts local schools of glass painting, each with some character of its own. To what extent design was affected by national temperament it is not easy to say. The marked divergence of the Flemish from the

French treatment of glass in the 16th century is not entirely due to a preference on the one part for colour and on the other for light and shade, but is partly owing to the circumstance that, whilst in France design remained in the hands of craftsmen, whose trade was glass painting, in the Netherlands it was entrusted by the emperor to his court painter, who concerned himself as little as possible with a technique of which he knew nothing. If in France we come also upon the names of well-known artists, they seem, like Jean Cousin, to have been closely connected with glass painting: they designed so like glass painters that they might have begun their artistic career in the workshop.

The attribution of fine windows to famous artists should not be too readily accepted; for, though it is a foible of modern times to father whatever is noteworthy upon some great name, the masterpieces of mediæval art are due to unknown craftsmen. In Italy, where glass painting was not much practised, and it seems to have been the custom either to import glass painters as they were wanted or to get work done abroad, it may well be that designs were supplied by artists more or less distinguished. Ghiberti and Donatello may have had a hand in the cartoons for the windows of the Duomo at Florence; but it is not to any sculptor that we can give the entire credit of design so absolutely in the spirit of colour decoration. The employment of artists not connected with glass design would go far to explain the great difference of Italian glass from that of other countries. The 14th-century work at Assisi is more correctly described as "Trecento" than as Gothic, and the "Quattrocento" windows at Florence are as different as could be from Perpendicular work. One compares them instinctively with Italian paintings, not with glass elsewhere. And so with the 15th-century Italian glass. The superb 16th-century windows of William of Marseilles at Arezzo, in which painting is carried to the furthest point possible short of sacrificing the pure quality of glass, are more according to contemporary French technique. Both French and Italian influence may be traced in Spanish glass (Avila, Barcelona, Burgos, Granada, Leon, Seville, Toledo). Some of it is said to have been executed in France. If so it must have been done to Spanish order. The coarse effectiveness of the design, the strength of the colour, the general robustness of the art, are characteristically Spanish; and nowhere this side of the Pyrenees do we find detail on a scale so enormous.

We have passed by, in following the progressive course of craftsmanship, some forms of design, peculiar to no one period but very characteristic of glass. The "quarry window," barely referred to, its diamond-shaped or oblong panes painted, richly bordered, relieved by bosses of coloured ornament often heraldic, is of constant occurrence. Entire windows, too, were from first to last given up to heraldry. The "Jesse window" occurs in every style. According to the fashion of the time the "Stem of Jesse" burst out into conventional foliage, vine branches or arbitrary scrollwork. It appealed to the designer by the scope it gave for freedom of design. He found vent, again, for fantastic imagination in the representation of the "Last Judgment," to which the west window was commonly devoted. And there are other schemes in which he delighted; but this is not the place to dwell upon them.

The glass of the 17th century does not count for much. Some of the best in England is the work of the Dutch van Linge family (Wadham and Balliol Colleges, Oxford). What glass painting came to in the 18th century is nowhere better to be seen than in the great west window of the ante-chapel at New College, Oxford. That is all Sir Joshua Reynolds and the best china painter of his day could do between them. The very idea of employing a china painter shows how entirely the art of the glass painter had died out.

It re-awoke in England with the Gothic revival of the 19th century; and the Gothic revival determined the direction modern glass should take. Early Victorian doings are interesting only as marking the steps of recovery (cf. the work of T. Willement in the choir of the Temple church; of Ward and Nixon, lately removed from the south transept of Westminster Abbey; of

Wailles). Better things begin with the windows at Westminster inspired by A. C. Pugin, who exercised considerable influence over his contemporaries. John Powell (Hardman & Co.) was an able artist content to walk, even after that master's death, reverently in his footsteps. Charles Winstan, whose *Hints on Glass Painting* was the first real contribution towards the understanding of Gothic glass, and who, by the aid of the Powells (of Whitefriars) succeeded in getting something very like the texture and colour of old glass, was more learned in ancient ways of workmanship than appreciative of the art resulting from them. (He is responsible for the Munich glass in Glasgow cathedral.) So it was that, except for here and there a window entrusted by exception to W. Dyce, E. Poynter, D. G. Rossetti, Ford Madox Brown or E. Burne-Jones, glass, from the beginning of its recovery, fell into the hands of men with a strong bias towards archaeology. The architects foremost in the Gothic revival (W. Butterfield, Sir G. Scott, G. E. Street, &c.) were all inclined that way; and, as they had the placing of commissions for windows, they controlled the policy of glass painters. Designers were constrained to work in the pedantically archaeological manner prescribed by architectural fashion. Unwillingly as it may have been, they made mock-mediæval windows, the interest in which died with the popular illusion about a Gothic revival. But they knew their trade; and when an artist like John Clayton (master of a whole school of later glass painters) took a window in hand (St Augustine's, Kilburn; Truro cathedral; King's College Chapel, Cambridge) the result was a work of art from which, tradework as it may in a sense be, we may gather what such men might have done had they been left free to follow their own artistic impulse. It is necessary to refer to this because it is generally supposed that whatever is best in recent glass is due to the romantic movement. The charms of Burne-Jones's design and of William Morris's colour, place the windows done by them among the triumphs of modern decorative art; but Morris was neither foremost in the reaction, nor quite such a master of the material he was working in as he showed himself in less exacting crafts. Other artists to be mentioned in connexion with glass design are: Clement Heaton, Bayne, N. H. J. Westlake and Henry Holiday, not to speak of a younger generation of able men.

Foreign work shows, as compared with English, a less just appreciation of glass, though the foremost draughtsmen of their day were enlisted for its design. In Germany, King Louis of Bavaria employed P. von Cornelius and W. von Kaulbach (Aix-la-Chapelle, Cologne, Glasgow); in France the Bourbons employed J. A. D. Ingres, F. V. E. Delacroix, Vernet and J. H. Flandrin (Dreux); and the execution of their designs was entrusted to the most expert painters to be procured at Munich and Sévres; but all to little effect. They either used potmetal glass of poor quality, or relied upon enamel—with the result that their colour lacks the qualities of glass. Where it is not heavy with paint it is thin and crude. In Belgium happier results were obtained. In the chapel of the Holy Sacrament at Brussels there is one window by J. B. Capronnier not unworthy of the fine series by B. van Orley which it supplements. At the best, however, foreign artists failed to appreciate the quality of glass; they put better draughtsmanship into their windows than English designers of the mid-Victorian era, and painted them better; but they missed the glory of translucent colour.

Modern facilities of manufacture make possible many things which were hitherto out of the question. Enamel colours are richer; their range is extended; and it may be possible, with the improved kilns and greater chemical knowledge we possess, to make them hold permanently fast. It was years ago demonstrated at Sévres how a picture may be painted in colours upon a sheet of plate-glass measuring 4 ft. by 2½ ft. We are now no doubt in a position to produce windows painted on much larger sheets. But the results achieved, technically wonderful as they are, hardly warrant the waste of time and labour upon work so costly, so fragile, so lacking in the qualities of a picture on the one hand and of glass on the other.

In America, John la Farge, finding European material not

dense enough, produced potmetal more heavily charged with colour. This was wilfully streaked, mottled and quasi-accidentally varied; some of it was opalescent; much of it was more like agate or onyx than jewels. Other forms of American enterprise were: the making of glass in lumps, to be chipped into flakes; the ruckling it; the shaping it in a molten state, or the pulling it out of shape. It takes an artist of some reserve to make judicious use of glass like this. La Farge and L. C. Tiffany have turned it to beautiful account; but even they have put it to purposes more pictorial than it can properly fulfil. The design it calls for is a severely abstract form of ornament verging upon the barbaric.

Of late years each country has been learning so much from the others that the newest effort is very much in one direction. It seems to be agreed that the art of the window-maker begins with glazing, that the all-needful thing is beautiful glass, that painting may be reduced to a minimum, and on occasion (thanks to new developments in the making of glass) dispensed with altogether. A tendency has developed itself in the direction not merely of mosaic, but of carrying the glazier's art farther than has been done before and rendering landscapes and even figure subjects in unpainted glass. When, however, it comes to the representation of the human face, the limitations of simple lead-glazing are at once apparent. A possible way out of the difficulty was shown at the Paris Exhibition of 1900 by M. Tournel, who, by fusing together coloured tesserae on to larger pieces of colourless glass, anticipated the discovery of the already mentioned fragment of Byzantine mosaic now in the Victoria and Albert Museum. He may have seen or heard of something of the sort. There would be no advantage in building up whole windows in this way; but for the rendering of the flesh and sundry minute details in a window for the most part heavily leaded, this fusing together of tesserae, and even of little pieces of glass cut carefully to shape, seems to supply the want of something more in keeping with severe mosaic glazing than painted flesh proves to be.

Glass painters are allowed to-day a freer hand than formerly. They are no longer exclusively engaged upon ecclesiastical work; domestic glass is an important industry; and a workman once comparatively exempt from pedantic control is not so easily

restrained from self-expression. Moreover, the recognition of the artistic position of craftsmen in general makes it possible for a man to devote himself to glass without sinking to the rank of a mechanic; and artists begin to realize the scope glass offers them. What they lack as yet is experience in their craft, and

Examples of Important Historical Stained Glass.

There are remains of the earliest known glass: in France—at Le Mans, Chartres, Châlons-sur-Marne, Angers and Poitiers cathedrals, the abbey church of St Denis and at St Remi, Reims: in England—at York minster (fragments): in Germany—at Augsburg and Straasburg cathedrals: in Austria—in the cloisters of Heiligen Kreuz.

The following is a classified list of some of the most characteristic and important windows, omitting for the most part isolated examples, and giving by preference the names of churches where there is a fair amount of glass remaining; the country in which at each period the art thrived best is put first.

<i>France.</i>		<i>England.</i>		<i>Germany.</i>		
Chartres	} cathedrals.	Canterbury	} cathedrals.	Church of St Kunibert, Cologne	(Romanesque).	
Le Mans		Salsbury		Cologne cathedral.		
Bourges		Lincoln				
Reims		York minster.				
Auxerre						
Ste Chapelle, Paris.						
Church of St Jean-aux-Bois.						
<i>England.</i>		<i>MIDDLE GOTHC</i>		<i>France.</i>		
York minster.		<i>Germany.</i>		<i>France.</i>		
Ely cathedral.		Church of St Sebald, Nuremberg.	} cathedrals.		Évreux cathedral.	
Wells cathedral.		Straasburg			Church of St Pierre, Chartres.	
Tewkesbury abbey.		Regensburg			Cathedral and church of St	
		Augsburg			Urbain, Troyes.	
		Erfurt			Church of Ste Kadegonde, Poitiers.	
		Freiburg	Cathedral and church of St Ouen,			
		Church of Nieder Haslach.	Rouen.			
<i>Italy.</i>		<i>LATE GOTHC</i>		<i>Spain.</i>		
Church of St Francis, Assisi.		<i>France.</i>		} cathedrals.		
Church of Or San Michele,		Bourges	Cologne			
Florence.		Troyes	Ulm			
Church of S. Petronio, Bologna.		Church of Notre Dame, Alençon.	Munich			
			Church of St Lorenz, Nuremberg.			
<i>England.</i>		<i>Italy.</i>		<i>Spain.</i>		
New College, Oxford.		The Duomo, Florence.	} cathedrals.		Toledo cathedral.	
Gloucester cathedral.						
York, minster and other churches.						
Great Malvern abbey.						
Church of St Mary, Shrewsbury.						
Fairford church.						
<i>France.</i>		<i>RENAISSANCE</i>		<i>Switzerland.</i>		
St Vincent	} Rouen.	<i>Netherlands.</i>		} principal museums.		
St Patrice		Brussels cathedral.	} Liège.			
St Godard		Church of St Jacques				
Church of St Foy, Conches.		Church of St Martin				
Church of St Gervais, Paris.		Cathedral				
Church of St Etienne-du-Mont,		<i>Italy.</i>		} cathedrals.		
Paris.		Arezzo	} cathedrals.			
Church of St Martin, Mont-		Milan				
morency.		Certosa di Pavia.	} cathedrals.			
Church of Ecouen.		Church of S. Petronio, Bologna.				
Church of St Etienne, Beauvais.		Church of Sta Maria Novella,	} colleges, Oxford.			
Church of St Nizier, Troyes.		Florence.				
Church of Brou, Bourg-en-		<i>Germany.</i>		} cathedrals.		
Bresse.		Freiburg cathedral.				
The Château de Chantilly.						
<i>Netherlands.</i>		<i>LATE RENAISSANCE</i>		<i>England.</i>		
Groote Kirk, Gouda.		<i>France.</i>		} colleges, Oxford.		
Choir of Brussels cathedral.		Church of St Martin-ès-Vignes,	} colleges, Oxford.			
Antwerp cathedral.		Troyes.				
		Nave and transepts of Auch	} cathedrals.			
		cathedral.				
		<i>Switzerland.</i>		} cathedrals.		
		<i>Most museums.</i>				

perhaps due workmanlike respect for traditional ways of workmanship. When the old methods come to be superseded it will be only by new ones evolved out of them. At present the conditions of glass painting remain very much what they were. The supreme beauty of glass is still in the purity, the brilliancy, the translucency of its colour. To make the most of this the designer must be master of his trade. The test of window design

is, now as ever, that it should have nothing to lose and everything to gain by execution in stained glass.

BIBLIOGRAPHY.—Theophilus, *Arts of the Middle Ages* (London, 1847); Charles Winston, *An Inquiry into the Difference of Style observable in Ancient Glass Painting, especially in England* (Oxford, 1847), and *Memoirs illustrative of the Art of Glass Painting* (London, 1865); N. H. J. Westlake, *A History of Design in Painted Glass* (4 vols., London, 1881-1894); L. F. Day, *Windows, A Book about Stained and Painted Glass* (London, 1908), and *Stained Glass* (London, 1909); A. W. Franks, *A Book of Ornamental Glazing Quarries* (London, 1849); *A Booke of Sundry Draughtes, principally serving for Glaziers* (London, 1615, reproduced 1900); F. G. Joyce, *The Fairford Windows* (coloured plates) (London, 1870); *Diwers Works of Early Masters in Ecclesiastical Decoration*, edited by John Weale (2 vols., London, 1846); Ferdinand de Lasteyrie, *Histoire de la peinture sur verre d'après ses monuments en France* (2 vols., Paris, 1852), and *Quelques mots sur la théorie de la peinture sur verre* (Paris, 1853); L. Magne, *Cœuvres des peintres verriers français* (2 vols., Paris, 1885); Viollet le Duc, "Vitrail," vol. ix. of the *Dictionnaire raisonné de l'architecture* (Paris, 1868); O. Merson, "Les Vitraux," *Bibliothèque de l'enseignement des beaux-arts* (Paris, 1895); E. Levy and J. B. Capronnier, *Histoire de la peinture sur verre* (coloured plates) (Brussels, 1860); Ottin, *Le Vitrail, son histoire à travers les âges* (Paris, 1774); C. Cahier and A. Martin, *Vitraux peints de Bourges du XIII^e siècle* (2 vols., Paris, 1841-1844); S. Clement and A. Guillard, *Vitraux du XIII^e siècle de la cathédrale de Bourges* (Bourges, 1900); M. A. Gessert, *Geschichte der Glasmalerei in Deutschland und den Niederlanden, Frankreich, England, etc., von ihrem Ursprung bis auf die neueste Zeit* (Tübingen and Stuttgart, 1839; also an English translation, London, 1851); F. Geiges, *Der alle Fenster-schmuck des Freiburger Münsters*, 5 parts (Freiburg im Breisgau, 1902, &c.); A. Hafner, *Chefs-d'œuvre de la peinture suisse sur verre* (Berlin).

GLASSBRENNER, ADOLF (1810-1876), German humorist and satirist, was born at Berlin on the 27th of March 1810. After being for a short time in a merchant's office, he took to journalism, and in 1831 edited *Don Quixote*, a periodical which was suppressed in 1833 owing to its revolutionary tendencies. He next, under the pseudonym *Adolf Brennglas*, published a series of pictures of Berlin life, under the titles *Berlin wie es ist und-trinkt!* (30 parts, with illustrations, 1833-1849), and *Buntes Berlin* (14 parts, with illustrations, Berlin, 1837-1858), and thus became the founder of a popular satirical literature associated with modern Berlin. In 1840 he married the actress Adele Peroni (1813-1895), and removed in the following year to Neustrelitz, where his wife had obtained an engagement at the Grand ducal theatre. In 1848 Glassbrenner entered the political arena and became the leader of the democratic party in Mecklenburg-Strelitz. Expelled from that country in 1850, he settled in Hamburg, where he remained until 1858; and then he became editor of the *Montagszeitung* in Berlin, where he died on the 25th of September 1876.

Among Glassbrenner's other humorous and satirical writings may be mentioned: *Leben und Treiben der feinen Welt* (1834); *Bilder und Traume aus Wien* (2 vols., 1836); *Gedichte* (1851, 5th ed. 1870); the comic epics, *Neuer Reineke Fuchs* (1846, 4th ed. 1870) and *Die verkehrte Welt* (1857, 6th ed. 1873); also *Berliner Volksleben* (3 vols., illustrated; Leipzig, 1847-1851). Glassbrenner has published some charming books for children, notably *Lachende Kinder* (14th ed., 1884), and *Sprechende Tiere* (20th ed., Hamburg, 1899).

See R. Schmidt-Cabanis, "Adolf Glassbrenner," in *Unsere Zeit* (1881).

GLASS CLOTH, a textile material, the name of which indicates the use for which it was originally intended. The cloths are in general woven with the plain weave, and the fabric may be all white, striped or checked with red, blue or other coloured threads; the checked cloths are the most common. The real article should be all linen, but a large quantity is made with cotton warp and tow weft, and in some cases they are composed entirely of cotton. The short fibres of the cheaper kind are easily detached from the cloth, and hence they are not so satisfactory for the purpose for which they are intended.

GLASSIUS, SALOMO (1593-1656), theologian and biblical critic, was born at Sondershausen, in the principality of Schwarzburg-Sondershausen, on the 20th of May 1593. In 1612 he entered the university of Jena. In 1615, with the idea of studying law, he moved to Wittenberg. In consequence of an illness, however, he returned to Jena after a year. Here, as a student of theology under Johann Gerhard, he directed his attention

especially to Hebrew and the cognate dialects; in 1619 he was made an "adjunctus" of the philosophical faculty, and some time afterwards he received an appointment to the chair of Hebrew. From 1625 to 1638 he was superintendent in Sondershausen; but shortly after the death of Gerhard (1637) he was, in accordance with Gerhard's last wish, appointed to succeed him at Jena. In 1640, however, at the earnest invitation of Duke Ernest the Pious, he removed to Gotha as court preacher and general superintendent in the execution of important reforms which had been initiated in the ecclesiastical and educational establishments of the duchy. The delicate duties attached to this office he discharged with tact and energy; and in the "syncretistic" controversy, by which Protestant Germany was so long vexed, he showed an unusual combination of firmness with liberality, of loyalty to the past with a just regard to the demands of the present and the future. He died on the 27th of July 1656.

His principal work, *Philologia sacra* (1623), marks the transition from the earlier views on questions of biblical criticism to those of the school of Spener. It was more than once reprinted during his lifetime, and appeared in a new and revised form, edited by J. A. Dathé (1731-1791) and G. L. Bauer at Leipzig. Glassius succeeded Gerhard as editor of the *Weimar Bibelwerk*, and wrote the commentary on the poetical books of the Old Testament for that publication. A volume of his *Opuscula* was printed at Leiden in 1700.

See the article in Herzog-Hauck, *Realencyclopädie*.

GLASSWORT, a name given to *Salicornia herbacea* (also known as marsh samphire), a salt-marsh herb with succulent, jointed, leafless stems, in reference to its former use in glass-making, when it was burnt for barilla. *Salsola Kali*, an allied plant with rigid, fleshy, spinous-pointed leaves, which was used for the same purpose, was known as prickly glasswort. Both plants are members of the natural order Chenopodiaceae.

GLASTONBURY, a market town and municipal borough in the Eastern parliamentary division of Somersetshire, England, on the main road from London to Exeter, 37 m. S.W. of Bath by the Somerset & Dorset railway. Pop. (1901) 4016. The town lies in the midst of orchards and water-meadows, reclaimed from the fens which encircled Glastonbury Tor, a conical height once an island, but now, with the surrounding flats, a peninsula washed on three sides by the river Brue.

The town is famous for its abbey, the ruins of which are fragmentary, and as the work of destruction has in many places descended to the very foundations it is impossible to make out the details of the plan. Of the vast range of buildings for the accommodation of the monks hardly any part remains except the abbot's kitchen, noteworthy for its octagonal interior (the exterior plan being square, with the four corners filled in with fire-places and chimneys), the porter's lodge and the abbey barn. Considerable portions are standing of the so-called chapel of St Joseph at the west end, which has been identified with the Lady chapel, occupying the site of the earliest church. This chapel, which is the finest part of the ruins, is Transitional work of the 12th century. It measures about 66 ft. from east to west and about 36 from north to south. Below the chapel is a crypt of the 15th century inserted beneath a building which had no previous crypt. Between the chapel and the great church is an Early English building which appears to have served as a Galilee porch. The church itself was a cruciform structure with a choir, nave and transepts, and a tower surmounting the centre of intersection. From east to west the length was 410 ft. and the breadth of the nave was about 80 ft. The nave had ten bays and the choir six. Of the nave three bays of the south side are still standing, and the windows have pointed arches externally and semicircular arches internally. Two of the tower piers and a part of one arch give some indication of the grandeur of the building. The foundations of the Edgar chapel, discovered in 1908, make the whole church the longest of cathedral or monastic churches in the country. The old clock, presented to the abbey by Adam de Sodbury (1322-1335), and noteworthy as an early example of a clock striking the hours automatically with a count-wheel, was once in Wells cathedral, but is now preserved in the Victoria and Albert Museum.

GLASS, STAINED

PLATE I.

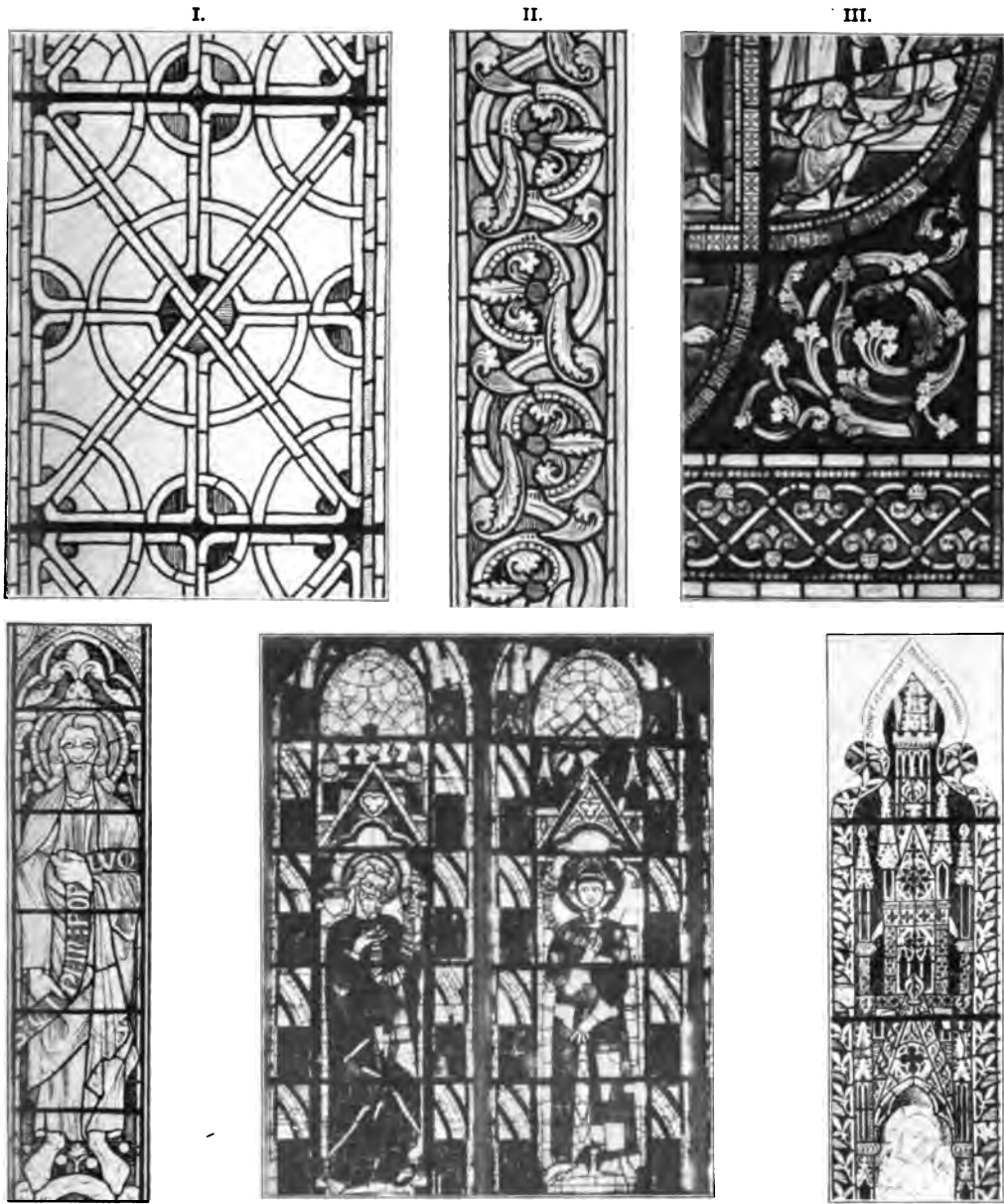

- I. Early Glazing. From S. Serge, Angers, Grisaille, with colour introduced in the small circles.
- II. An Early Border. From S. Kunibert, Cologne.
- III. Portion of an Early Medallion Window. From Canterbury, showing the plan of the design and the ornamental details.
- IV. An Early Figure from Lyons. Showing the leading of the eyes, hair, nimbus, and drapery.
- V. Decorated Lights. From S. Urbain, Troyes, showing both the influence of the early period in the figures, and the beginning of the architectural canopy.
- VI. Typical Decorated Canopy. From Exeter.

Nos. I., II., III., IV., VI. are taken from illustrations in Lewis F. Day, *Windows*, by permission of E. T. Batsford.

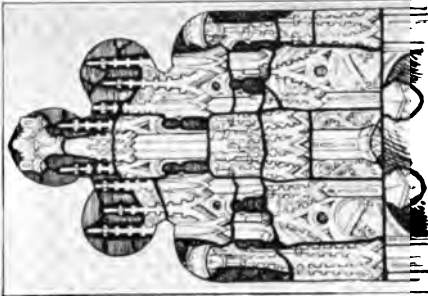

I.



IV.



III.



II.

- I. A Typical Perpendicular Canopy (from Lewis F. Day, *Windows*, by permission of B. T. Batsford).
 II. A Window from Auch. Illustrating the transition from Perpendicular to Renaissance.
 III. A Sixteenth-Century Jesse Window. From Beauvais (source as in Fig. I.).
 IV. Portion of a Renaissance Window. From Montmorency, showing the perfection of glass painting.

From Lucien Magne, *Oeuvre des Peintres Verriers Français*, by permission of Firmin-Didot et Cie.

The Glastonbury thorn, planted, according to the legend, by Joseph of Arimathea, has been the object of considerable comment. It is said to be a distinct variety, flowering twice a year. The actual thorn visited by the pilgrims was destroyed about the Reformation time, but specimens of the same variety are still extant in various parts of the country.

The chief buildings, apart from the abbey, are the church of St John Baptist, Perpendicular in style, with a fine tower and some 15th-century monuments; St Benedict's, dating from 1493-1524; St John's hospital, founded 1246; and the George Inn, built in the time of Henry VII. or VIII. The present stone cross replaced a far finer one of great age, which had fallen into decay. The Antiquarian Museum contains an excellent collection, including remains from a prehistoric village of the marshes, discovered in 1892, and consisting of sixty mounds within a space of five acres. There is a Roman Catholic missionaries' college. In the 16th century the woollen industry was introduced by the duke of Somerset; and silk manufacture was carried on in the 18th century. Tanning and tile-making, and the manufacture of boots and sheep-skin rugs are practised. The town is governed by a mayor, 4 aldermen and 12 councillors. Area, 5000 acres.

The lake-village discovered in 1892 proves that there was a Celtic settlement about 300-200 B.C. on an island in the midst of swamps, and therefore easily defensible. British earthworks and Roman roads and relics prove later occupation. The name of Glastonbury, however, is of much later origin, being a corruption of the Saxon *Glastyn-gabyrig*. By the Britons the spot seems to have been called *Ynys yr Afalon* (Latinized as *Avallonia*) or *Ynyavitrin* (see *AVALON*), and it became the local habitation of various fragments of Celtic romance. According to the legends which grew up under the care of the monks, the first church of Glastonbury was a little wattle building erected by Joseph of Arimathea as the leader of the twelve apostles sent over to Britain from Gaul by St Philip. About a hundred years later, according to the same authorities, the two missionaries, Phaganus and Deruvianus, who came to king Lucius from Pope Eleutherius, established a fraternity of anchorites on the spot, and after three hundred years more St Patrick introduced among them a regular monastic life. The British monastery founded about 601 was succeeded by a Saxon abbey built by Ine in 708. From the decadent state into which Glastonbury was brought by the Danish invasions it was recovered by Dunstan, who had been educated within its walls and was appointed its abbot about 946. The church and other buildings of his erection remained till the installation, in 1082, of the first Norman abbot, who inaugurated the new epoch by commencing a new church. His successor Herlewin (1101-1120), however, pulled it down to make way for a finer structure. Henry of Blois (1126-1172) added greatly to the extent of the monastery. In 1184 (on 25th May) the whole of the buildings were laid in ruins by fire; but Henry II. of England, in whose hands the monastery then was, entrusted his chamberlain Rudolphus with the work of restoration, and caused it to be carried out with much magnificence. The great church of which the ruins still remain was then erected. In the end of the 12th century, and on into the following, Glastonbury was distracted by a strange dispute, caused by the attempt of Savaric, the ambitious bishop of Bath, to make himself master of the abbey. The conflict was closed by the decision of Innocent III., that the abbacy should be merged in the new see of Bath and Glastonbury, and that Savaric should have a fourth of the property. On Savaric's death his successor gave up the joint bishopric and allowed the monks to elect their own abbot. From this date to the Reformation the monastery, one of the chief Benedictine abbeys in England, continued to flourish, the chief events in its history being connected with the maintenance of its claims to the possession of the bodies or tombs of King Arthur and St Dunstan: From early times through the middle ages it was a place of pilgrimage. As early at least as the beginning of the 11th century the tradition that Arthur was buried at Glastonbury appears to have taken shape; and in the reign of Henry II., according to Giraldus Cambrensis and others, the abbot Henry de Blois, causing search to be made, discovered at the depth of 16

ft. a massive oak trunk with an inscription "Hic jacet sepultus inclitus rex Arthurus in insula Avalonia." After the fire of 1184 the monks asserted that they were in possession of the remains of St Dunstan, which had been abstracted from Canterbury after the Danish sack of 1011 and kept in concealment ever since. The Canterbury monks naturally denied the assertion, and the contest continued for centuries. In 1508 Warham and Goldston having examined the Canterbury shrine reported that it contained all the principal bones of the saint, but the abbot of Glastonbury in reply as stoutly maintained that this was impossible. The day of such disputes was, however, drawing to a close. In 1539 the last and 60th abbot of Glastonbury, Robert Whyting, was lodged in the Tower on account of "divers and sundry treasons." "The 'account' or 'book' of his treasons . . . seems to be lost, and the nature of the charges . . . can only be a matter of speculation" (Gairdner, *Cal. Pap.* on Hen. VIII., xiv. ii. *pref.* xxxii). He was removed to Wells, where he was "arraigned and next day put to execution for robbing of Glastonbury church." The execution took place on Glastonbury Tor. His body was quartered and his head fixed on the abbey gate. A darker passage does not occur in the annals of the English Reformation than this murder of an able and high-spirited man, whose worst offence was that he defended as best he could from the hand of the spoiler the property in his charge.

In 1907, the site of the abbey with the remains of the buildings, which had been in private hands since the granting of the estate to Sir Peter Carew by Elizabeth in 1559, was bought by Mr Ernest Jardine for the purpose of transferring it to the Church of England. Bishop Kennion of Bath and Wells entered into an agreement to raise a sum of £31,000, the cost of the purchase; this was completed, and the site and buildings were formally transferred at a dedicatory service in 1909 to the Diocesan Trustees of Bath and Wells, who are to hold and manage the property according to a deed of trust. This deed provided for the appointment of an advisory council, consisting of the archbishop of Canterbury, the bishop of Bath and Wells and four other bishops, each with power to nominate one clerical and one lay member. The council has the duty of deciding the purpose for which the property is to be used "in connexion with and for the benefit of the Church of England." To give time for further collection of funds and deliberation, the property was re-let for five years to the original purchaser.

In the 8th century Glastonbury was already a borough owned by the abbey, which continued to be overlord till the Dissolution. The abbey obtained charters in the 7th century, but the town received its first charter from Henry II., who exempted the men of Glastonbury from the jurisdiction of royal officials and freed them from certain tolls. This was confirmed by Henry III. in 1227, by Edward I. in 1278, by Edward II. in 1313 and by Henry VI. in 1447. The borough was incorporated by Anne in 1706, and the corporation was reformed by the act of 1835. In 1319 Glastonbury received a writ of summons to parliament, but made no return, and has not since been represented. A fair on the 8th of September was granted in 1127; another on the 29th of May was held under a charter of 1282. Fairs known as Torr fair and Michaelmas fair are now held on the second Mondays in September and October and are chiefly important for the sale of horses and cattle. The market day every other Monday is noted for the sale of cheese. Glastonbury owed its medieval importance to its connexion with the abbey. At the Dissolution the introduction of woollen manufacture checked the decay of the town. The cloth trade flourished for a century and was replaced by silk-weaving, stocking-knitting and glove-making, all of which have died out.

See *Abbot Gasquet, Henry VIII. and the English Monasteries* (1906), and *The Last Abbot of Glastonbury* (1895 and 1908); William of Malmesbury, "De antiq. Glastoniensis ecclesie," in *Rerum Anglicarum script. vet. tom. i.* (1684) (also printed by Hearne and Migne); John of Glastonbury, *Chronica sive de hist. de rebus Glast.*, ed. by Hearne (2 vols., Oxford, 1726); Adam of Domerham, *De rebus gestis Glast.*, ed. by Hearne (2 vols., Oxford, 1727); *Hist. and Antiq. of Glast.* (London, 1807); *Aeolianian Guide to the Town of Glastonbury* (8th ed., 1839); Warner, *Hist. of the Abbey and Town of Bath*, (1826); Rev. F. Warre, "Glastonbury Abbey," in *Proc. of Somersetshire*

Archaeol. and Nat. Hist. Soc., 1849; Rev. F. Warre, "Notice of Ruins of Glastonbury Abbey," *ib.*, 1859; Rev. W. A. Jones, "On the Reputed Discovery of King Arthur's Remains at Glastonbury," *ib.*, 1859; Rev. J. R. Green, "Dunstan at Glastonbury," and "Giso and Savaric," *ib.*, 1863; Rev. Canon Jackson, "Savaric, Bishop of Bath and Glastonbury," *ib.*, 1862, 1863; E. A. Freeman, "King Ine," *ib.*, 1872 and 1874; Dr W. Beattie, in *Journ. of Brit. Archaeol. Ass.* vol. xii., 1856; Rev. R. Willis, *Architectural History of Glastonbury Abbey* (1866); W. H. P. Greswell, *Chapters on the Early History of Glastonbury Abbey* (1909). Views and plans of the abbey building will be found in Dugdale's *Monasticon* (1635); Stevens's *Monasticon* (1720); Stukeley, *Itinerarium curiosum* (1724); Grose, *Antiquities* (1754); Carter, *Ancient Architecture* (1800); Storer, *Antiq. and Topogr. Cabinet*, II., iv., v. (1807), &c.; Britton's *Architectural Antiquities*, iv. (1813); *Vestigia monumenta*, iv. (1815); and *New Monasticon*, I. (1817).

GLATIGNY, JOSEPH ALBERT ALEXANDRE (1839-1873), French poet, was born at Lillebonne (Seine Inférieure) on the 21st of May 1839. His father, who was a carpenter and afterwards a gendarme, removed in 1844 to Bernay, where Albert received an elementary education. Soon after leaving school he was apprenticed to a printer at Pont Audemer, where he produced a three-act play at the local theatre. He then joined a travelling company of actors to whom he acted as prompter. Inspired primarily by the study of Théodore de Banville, he published his *Vignes folles* in 1857; his best collection of lyrics, *Les Fliches d'or*, appeared in 1864; and a third volume, *Gilles et pasquins*, in 1872. After Glatigny settled in Paris he improvised at café concerts and wrote several one-act plays. On an expedition to Corsica with a travelling company he was on one occasion arrested and put in irons for a week through being mistaken by the police for a notorious criminal. His marriage with Emma Dennie brought him great happiness, but the hardships of his life weakened his health and he died at Sèvres on the 16th of April 1873.

See Catulle Mendès, *Légende du Parnasse contemporain* (1884), and *Glatigny, drame funambulesque* (1906).

GLATZ (Slav. *Kladsko*), a fortified town of Germany, in the Prussian province of Silesia, in a narrow valley on the left bank of the Neisse, not far from the Austrian frontier, 58 m. S.W. from Breslau by rail. Pop. (1905) 16,051. The town with its narrow streets winds up the fortified hill which is crowned by the old citadel. Across the river, on the Schäferberg, lies a more modern fortress built by the Prussians about 1750. Before the town on both banks of the river there is a fortified camp by which bombardment from the neighbouring heights can be hindered and which affords accommodation for 10,000 men. The inner ceinture of walls was razed in 1891 and their site is now occupied by new streets. There are a Lutheran and two Roman Catholic churches, one of which, the parish church, contains the monuments of seven Silesian dukes. Among the other buildings the principal are the Royal Catholic gymnasium and the military hospital. The industries include machine shops, breweries, and the manufacture of spirits, linen, damask, cloth, hosiery, beads and leather.

Glatz existed as early as the 10th century, and received German settlers about 1250. It was besieged several times during the Thirty Years' War and during the Seven Years' War and came into the possession of Prussia in 1742. In 1821 and 1883 great devastation was caused here by floods. The county of Glatz was long contended for by the kingdoms of Poland and of Bohemia. Eventually it became part of the latter country, and in 1534 was sold to the house of Habsburg, from whom it was taken by Frederick the Great during his attack on Silesia.

See Ludwig, *Die Grafschaft Glatz in Wort und Bild* (Breslau, 1897); Kutzen, *Die Grafschaft Glatz* (Glogau, 1873); and *Geschichtsquellen der Grafschaft Glatz*, edited by F. Volkmer and Hohaus (1883-1891).

GLAUBER, JOHANN RUDOLF (1604-1668), German chemist, was born at Karlstadt, Bavaria, in 1604 and died at Amsterdam in 1668. Little more is known of his life than that he resided successively in Vienna, Salzburg, Frankfurt and Cologne before settling in Holland, where he made his living chiefly by the sale of secret chemical and medicinal preparations. Though his writings abound in universal solvents and other devices of the alchemists, he made some real contributions to chemical knowledge. Thus he clearly described the preparation of hydrochloric

acid by the action of oil of vitriol on common salt, the manifold virtues of sodium sulphate—*sal mirabile*, Glauber's salt—formed in the process being one of the chief themes of his *Miraculum mundi*; and he noticed that nitric acid was formed when nitre was substituted for the common salt. Further he prepared a large number of substances, including the chlorides and other salts of lead, tin, iron, zinc, copper, antimony and arsenic, and he even noted some of the phenomena of double decomposition. He was always anxious to turn his knowledge to practical account, whether in preparing medicines, or in furthering industrial arts such as dyeing, or in increasing the fertility of the soil by artificial manures. One of his most notable works was his *Teutschlands Wohlfarth* in which he urged that the natural resources of Germany should be developed for the profit of the country and gave various instances of how this might be done.

His treatises, about 30 in number, were collected and published at Frankfurt in 1658-1659, at Amsterdam in 1661, and, in an English translation by Packe, at London in 1689.

GLAUBER'S SALT, decahydrated sodium sulphate, $\text{Na}_2\text{SO}_4 \cdot 10\text{H}_2\text{O}$. It is said by J. Kunkel to have been known as an *arcanum* or secret medicine to the electoral house of Saxony in the middle of the 16th century, but it was first described by J. R. Glauber (*De natura salium*, 1658), who prepared it by the action of oil of vitriol or sulphuric acid on common salt, and, ascribing to it many medicinal virtues, termed it *sal mirabile Glauberi*. As the mineral thenardite or mirabilite, which crystallizes in the rhombic system, it occurs in many parts of the world, as in Spain, the western states of North America and the Russian Caucasus; in the last-named region, about 25 m. E. of Tiflis, there is a thick bed of the pure salt about 5 ft. below the surface, and at Balalashinsk there are lakes or ponds the waters of which are an almost pure solution. The substance is the active principle of many mineral waters, e.g. Fredericks-hall; it occurs in sea-water and it is a constant constituent of the blood. In combination with calcium sulphate, it constitutes the mineral glauberite or brongniartite, $\text{Na}_2\text{SO}_4 \cdot \text{CaSO}_4$, which assumes forms belonging to the monoclinic system and occurs in Spain and Austria. It has a bitter, saline, but not acrid taste. At ordinary temperatures it crystallizes from aqueous solutions in large colourless monoclinic prisms, which effloresce in dry air, and at 35° C. melt in their water of crystallization. At 100° they lose all their water, and on further heating fuse at 843°. Its maximum solubility in water is at 34°; above that temperature it ceases to exist in the solution as a decahydrate, but changes to the anhydrous salt, the solubility of which decreases with rise of temperature. Glauber's salt readily forms supersaturated solutions, in which crystallization takes place suddenly when a crystal of the salt is thrown in; the same effect is obtained by exposure to the air or by touching the solution with a glass rod. In medicine it is employed as an aperient, and is one of the safest and most innocuous known. For children it may be mixed with common salt and the two be used with the food without the child being conscious of any difference. Its stimulation of the taste of common salt also renders it suitable for administration to insane patients and others who refuse to take any drug. If, however, its presence is recognized sodium phosphate may be substituted.

GLAUCHAU, a town of Germany, in the kingdom of Saxony, on the right bank of the Mulde, 7 m. N. of Zwickau and 17 W. of Chemnitz by rail. Pop. (1875) 21,743; (1905) 24,556. It has important manufactures of woollen and half-woollen goods, in regard to which it occupies a high position in Germany. There are also dye-works, print-works, and manufactories of paper, linen, thread and machinery. Glauchau possesses a high grade school, elementary schools, a weaving school, an orphanage and an infirmary. Some portions of the extensive old castle date from the 12th century, and the Gottesacker church contains interesting antiquarian relics. Glauchau was founded by a colony of Sorbs and Wends, and belonged to the lords of Schönburg as early as the 12th century.

See R. Hofmann, *Rückblick über die Geschichte der Stadt Glauchau* (1897).

GLAUCONITE, a mineral, green in colour, and chemically a hydrous silicate of iron and potassium. It especially occurs in the green sands and muds which are gathering at the present time on the sea bottom at many different places. The wide extension of these sands and muds was first made known by the naturalists of the "Challenger," and it is now found that they occur in the Mediterranean as well as in the open ocean, but they have not been found in the Black Sea or in any fresh-water lakes. These deposits are not in a true sense abyssal, but are of terrigenous origin, the mud and sand being derived from the wear of the continents, transported by marine currents. The greater part of the mass consists in all cases of minerals such as quartz, feldspar (often labradorite), mica, chlorite, with more or less calcite which is probably always derived from shells or other organic sources. Many accessory minerals such as tourmaline and zircon have been identified also, while augite, hornblende and other volcanic minerals occur in varying proportion as in all the sediments of the open sea. The depth in which they accumulate varies a good deal, viz. from 200 up to 2000 fathoms, but as a rule is less than 1000 fathoms, and it is believed that the most common situations are where the continental shores slope rather steeply into moderate depths of water. Many of the blue muds, which owe their colour to fine particles of sulphide of iron, contain also a small quantity of glauconite; in Globigerina oozes this substance has also been found, and in fact there exists every gradation between the glauconitic deposits and the other types of sands and muds which are found at similar depths.

The colouring matter is believed in every case to be glauconite. Other ingredients, such as lime, alumina and magnesia are usually shown to be present by the analyses, but may perhaps be regarded as non-essential: it is impossible to isolate this substance in a pure state as it occurs only in fine aggregates, mixed with other minerals. The glauconite, though crystalline, never occurs well crystallized but only as dense clusters of very minute particles which react feebly on polarized light. They have one well-marked characteristic inasmuch as they often form rounded lumps. In many cases it is certain that these are casts, which fill up the interior of empty shells of Foraminifera. They may be seen occupying these shells, and when the shell is dissolved away perfect casts of glauconite are set free. Apparently in some manner not understood, the decaying organic matter in the shell of the dead organism initiated or favoured the chemical reactions by which the glauconite was formed. That the mineral originated on the sea bottom among the sand and mud is quite certainly established by these facts; moreover, since it is so soft and friable that it is easily powdered up by pressure with the fingers, it cannot have been transported from any great distance by currents. Small rounded glauconite lumps, which are common on the sands but show no trace of having filled the chambers of Foraminifera, may have arisen by a re-deposit of broken-down casts such as have been described; probably slight movement of the deposits, occasioned by currents, may have broken up the glauconite casts and scattered the soft material through the water. Films or stains of glauconite on shells, sand grains and phosphate nodules are explained by a similar deposit of fragmental glauconite.

In a small number of Tertiary and older rocks glauconite occurs as an essential component. It is found in the Pliocene sands of Holland, the Eocene sands of Paris and the "Molasse" of Switzerland, but is much more abundant in the Lower Cretaceous rocks of N. Europe, especially in the subdivision known as the Greensand. Rounded lumps and casts like those of the green sands of the present day are plentiful in these rocks, and it is obvious that the mode of formation was in all respects the same. The green sand when weathered is brown or rusty coloured, the glauconite being oxidized to limonite. Calcareous sands or impure limestones with glauconite are also by no means rare, an example being the well-known Kentish Rag. In the Chalk-rock and Chalk-marl of some parts of England glauconite is rather frequent, and glauconitic chalk is known also in the north of France. Among the oldest rocks which contain this mineral are the Lower Silurian of the St Petersburg district,

but it is very rare in the Palaeozoic formations, possibly because it undergoes crystalline change and is also liable to be oxidized and converted into other ferruginous minerals. It has been suggested that certain deposits of iron ores may owe their origin to deposits of glauconite, as for example those of the Mesabi range, Minnesota, U.S.A. (J. S. F.)

GLAUCOUS (Gr. γλαυός, bright, gleaming), a word meaning of a sea-green colour, in botany covered with bloom, like a plum or a cabbage-leaf.

GLAUCUS ("bright"), the name of several figures in Greek mythology, the most important of which are the following:

1. **GLAUCUS**, surnamed *Pontius*, a sea divinity. Originally a fisherman and diver of Anhedon in Bœotia, having eaten of a certain magical herb sown by Cronus, he leapt into the sea, where he was changed into a god, and endowed with the gift of unerring prophecy. According to others he sprang into the sea for love of the sea-god Melicertes, with whom he was often identified (Athenæus vii. 296). He was worshipped not only at Anhedon, but on the coasts of Greece, Sicily and Spain, where fishermen and sailors at certain seasons watched for his arrival during the night in order to consult him (Pausanias ix. 22). In art he is depicted as a vigorous old man with long hair and beard, his body terminating in a scaly tail, his breast covered with shells and seaweed. He was said to have been the builder and pilot of the Argo, and to have been changed into a god after the fight between the Argonauts and Tyrrhenians. He assisted the expedition in various ways (Athenæus, *loc. cit.*; see also Ovid, *Metam.* xiii. 904). Glaucus was the subject of a satyric drama by Aeschylus. He was famous for his amours, especially those with Scylla and Circe.

See the exhaustive monograph by R. Gaedechens, *Glaucus der Meerergott* (1860), and article by the same in Roscher's *Lexikon der Mythologie*; and for Glaucus and Scylla, E. Vinet in *Annali dell' Instituto di Correspondenza archeologica*, xv. (1843).

2. **GLAUCUS**, usually surnamed *Potnieus*, from Potniae near Thebes, son of Sisyphus by Merope and father of Bellerophon. According to the legend he was torn to pieces by his own mares (Virgil, *Georgics*, iii. 267; Hyginus, *Fab.* 250, 273). On the isthmus of Corinth, and also at Olympia and Nemea, he was worshipped as Taraxippus ("terrifier of horses"), his ghost being said to appear and frighten the horses at the games (Pausanias vi. 20). He is closely akin to Glaucus Pontius, the frantic horses of the one probably representing the stormy waves, the other the sea in its calmer mood. He also was the subject of a lost drama of Aeschylus.

3. **GLAUCUS**, the son of Minos and Pasiphaë. When a child, while playing at ball or pursuing a mouse, he fell into a jar of honey and was smothered. His father, after a vain search for him, consulted the oracle, and was referred to the person who should suggest the aptest comparison for one of the cows of Minos which had the power of assuming three different colours. Polyidus of Argos, who had likened it to a mulberry (or bramble), which changes from white to red and then to black, soon afterwards discovered the child; but on his confessing his inability to restore him to life, he was shut up in a vault with the corpse. Here he killed a serpent which was revived by a companion, which laid a certain herb upon it. With the same herb Polyidus brought the dead Glaucus back to life. According to others, he owed his recovery to Aesculapius. The story was the subject of plays by the three great Greek tragedians, and was often represented in mimic dances.

See Hyginus, *Fab.* 136; Apollodorus iii. 3. 10; C. Höck, *Kreta*, iii. 1829; C. Eckermann, *Metamorph.* 1840.

4. **GLAUCUS**, son of Hippolochus, and grandson of Bellerophon, mythical progenitor of the kings of Ionia. He was a Lycian prince who, along with his cousin Sarpedon, assisted Priam in the Trojan War. When he found himself opposed to Diomedes, with whom he was connected by ties of hospitality, they ceased fighting and exchanged armour. Since the equipment of Glaucus was golden and that of Diomedes brazen, the expression "golden for brazen" (*Iliad*, vi. 236) came to be used proverbially for a bad exchange. Glaucus was afterwards slain by Ajax.

All the above are exhaustively treated by R. Gaedechens in Ersch and Gruber's *Allgemeine Encyclopädie*.

GLAZING.—The business of the glazier may be confined to the mere fitting and setting of glass (*q.v.*), even the cutting up of the plates into squares being generally an independent art, requiring a degree of tact and judgment not necessarily possessed by the building artificer. The tools generally used by the glazier are the diamond for cutting, laths or straight edges, tee square, measuring rule, glazing knife, hacking knife and hammer, duster, sash tool, two-foot rule and a glazier's cradle for carrying the glass. Glaziers' materials are glass, putty, priming or paint, springs, wash-leather or india-rubber for door panels, size, black. The glass is supplied by the manufacturer and cut to the sizes required for the particular work to be executed. Putty is made of whitening and linseed oil, and is generally bought in iron kegs of $\frac{1}{2}$ or 1 cwt.; the putty should always be kept covered over, and when found to be getting hard in the keg a little oil should be put on it to keep it moist. Priming is a thin coat of paint with a small amount of red lead in it. In the majority of cases after the sashes for the windows are fitted they are sent to the glazier's and primed and glazed, and then returned to the job and hung in their proper positions. When priming sashes it is important that the rebates be thoroughly primed, else the putty will not adhere. All wood that is to be painted requires before being primed to have the knots coated with knotting. When the priming is dry, the glass is cut and fitted into its place; each pane should fit easily with about $\frac{1}{16}$ in. play all round. The glazier runs the putty round the rebates with his hands, and then beds the glass in it, pushing it down tight, and then further secures it by knocking in small nails, called glaziers' sprigs, on the rebate side. He then trims up the edges of the protruding putty and bevels off the putty on the rebate or outside of the sash with a putty knife. The sash is then ready for painting. Large squares and plate glass are usually inserted when the sashes are hung to avoid risks of breakage. For inside work the panes of glass are generally secured with beads (not with putty), and in the best work these beads are fixed with brass screws and caps to allow of easy removal without breaking the beads and damaging the paint, &c. In the case of glass in door panels where there is much vibration and slamming, the glass is bedded in wash-leather or india-rubber and secured with beads as before mentioned.

The most common glass and that generally used is clear sheet in varying thicknesses, ranging in weight from 15 to 30 oz. per sq. ft. This can be had in several qualities of English or foreign manufacture. But there are many other varieties—obscured, fluted, enamelled, coloured and ornamental, rolled and rough plate, British polished plate, patent plate, fluted rolled, quarry rolled, chequered rough, and a variety of figured rolled, and stained glass, and crown-glass with bulls'-eyes in the centre.

Lead light glazing is the glazing of frames with small squares of glass, which are held together by reticulations of lead; these are secured by means of copper wire to iron saddle bars, which are let into mortices in the wood frames or stone jambs. This is formed with strips of lead, soldered at the angles; the glass is placed between the strips and the lead flattened over the edges of glass to secure it. This is much used in public buildings and private residences. In Weldon's method the saddle bars are bedded in the centre of the strips of lead, thus strengthening the frame of lead strips and giving a better appearance.

Wired rolled plate or wired cast plate, usually $\frac{1}{2}$ in. thick, has wire netting embedded in it to prevent the glass from falling in the case of fire; its use is obligatory in London for all lantern and skylights, screens and doors on the staircases of public and warehouse buildings, in accordance with the London Building Act. It is also used for the decks of ships and for port and cabin lights, as it is much stronger than plain glass, and if fractured is held together by the wire.

Patent prismatic rolled glass, or "refrax" (fig. 1), consists of an effectual application of the well-known properties of the prism; it absorbs all the light that strikes the window opening, and diffuses it in the most efficient manner possible in the darkest

portions of the apartment. It can be fixed in the ordinary way or placed over the existing glass.

Pavement lights (fig. 2) and stallboard lights are constructed with iron frames in small squares and glazed with thick prismatic glass, and are used to light basements. They are placed on the pavement and under shop fronts in the portion called the stallboard, and are also inserted in iron coal plates.

Great skill has of late years been displayed in the ornamentation of glass such as is seen in public saloons, restaurants, &c., as, for instance, in bevelling the edges, silvering, brilliant cutting, embossing, bending, cutting shelving to fancy shapes and polishing, and in glass ventilators.

There are several patent methods of roof glazing, such as are applied to railway stations, studios and printing and other factories requiring light. Some of the first patents of this kind were erected with wood glazing bars; these were unsightly, since they required to be of large sectional area when spanning a distance of 7 or 8 ft., and also required to be constantly painted. This was a source of trouble; the roof was constantly leaking and, moreover, it was not fire-resisting.

Of subsequent patents one includes the use of steel T-bars, in which the glass is bedded and covered with a capping of copper or zinc secured with bolts and nuts. Another employs steel bars covered with lead; and this is a very good method, as the bars are of small section, require no painting, and are also fire-resisting. There is one reason for preferring wood to steel, namely, that wood does not expand and contract like steel does. After the sun has been on steel bars, especially those in long lengths, they tend to buckle and then when cold contract, thus getting out of shape; there is also the possibility that when expanding they may break the glass. This is more noticeable in the case of iron ventilating frames in this glazing, which after having weathered for a year or two will begin to get out of shape and so give trouble in opening and closing. Care should be taken not to fit the glass in iron bars tightly, but

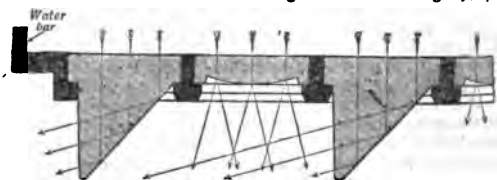

FIG. 2.—Section through Prism Pavement Light, the direction of light rays being indicated by arrows.

a good $\frac{1}{16}$ in. play all round should be allowed. A few of the systems of patent roof glazing will be described in the following pages, together with illustrations.

The system of glazing known as the "British Challenge" (fig. 3), with steel bars encased with a sheeting of 4-lb lead, is very simple and durable, needs no painting, and can be fixed at as much as 8 ft. clear bearings, with the bars spaced 2 ft. apart. The ends of the bars rest on the wood or steel purlins or plates, and are either notched and screwed down, or simply fitted with a bracket which is screwed. The bar is of T section with condensation grooves, and the lead wings on top are turned down on to the glass after fitting. This lead-covered steel bar is a great improvement on the plain steel bar as it is entirely unaffected by smoke, acids or exhaust fumes from steam engines; this is important in the case of a railway station, where the fumes would otherwise eat the steel away and so weaken the bars that in time they would snap. Another somewhat similar system is known as "Mellowes' Eclipse Roof Glazing" (fig. 4). It consists of steel T-bars having lead wings on top to turn on to the glass in a similar manner to the last, the top wings being double and the underside of the bar having an additional wing to catch the condensation. The Heywood combination system (fig. 5) is composed of galvanized steel T-bars, sometimes encased in lead and sometimes partly encased. It has a capping and condensation gutters of lead.



FIG. 3.—"British Challenge" Glazing.



FIG. 4.—Mellowes' Glazing.

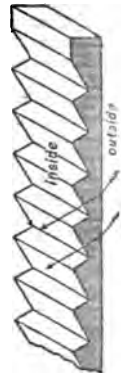

FIG. 1.—Prism covered with a capping of copper or zinc secured with bolts and nuts.

and the glass is bedded on asbestos packing to get a better bearing edge, so as to be held more securely. Hope's glazing is very similar, but the bars are either T or cross according to the span. The "Perfection" glazing used by Messrs Helliwell & Co. (fig. 6) is composed of steel shaped T bars with copper capping, secured with bolts and nuts and having asbestos packing on top of the glass under the edges of the capping. Pennycook's glazing is composed of steel shaped T bars encased with lead and lead wings. Rendle's "Invincible" glazing (fig. 7) is composed of steel T bars with specially shaped copper water and condensation channels, all formed in the one piece and resting on top of the T steel; the glass rests on the zinc channel, and a copper capping is fixed over the edges of the glass and secured with bolts and nuts. Deard's glazing is very similar, and is composed of T steel encased with lead; it claims to save all drilling for fixing to iron roofs. There are also other systems composed of wood bars with condensation gutter and capping of copper secured with bolts and nuts, and asbestos packing with slight differences in some minor matters, but these systems are but little used.



FIG. 5.—Heywood's Glazing.



FIG. 6.—Helliwell's "Perfection" Glazing.



FIG. 7.—Rendle's "Invincible" Glazing.

to keep them firmly together.

Glass is now used for decorative purposes, such as wall tiling and ceilings; it is coloured and decorated in almost any shade and presents a very effective appearance. An invention has been patented for building houses entirely of glass; the walls are constructed of blocks or bricks of opaque glass, the several walls being varied in thickness according to the constructional requirements.

It is certainly true that daylight has much to do with the sanitary condition of all buildings, and this being so the proper distribution of daylight to a building is of the greatest possible importance, and must be effected by an ample provision of windows judiciously arranged. The heads of all windows should be kept as near the ceiling as possible, as well to obtain easy ventilation as to ensure good lighting. As far as is practicable a building should be planned so that each room receives the sun's rays for some part of the day. This is rarely an easy matter, especially in towns where the aspect of the building is out of the architect's hands. The best sites for light are found in streets running north and south and east and west, and lighting areas or courts in buildings should always if possible be arranged on these lines. The task of adequately lighting lofty city buildings has been greatly minimized by the introduction of many forms of reflecting and intensifying contrivances, which are used to deflect light into those apartments into which daylight does not directly penetrate, and which would otherwise require the use of artificial light to render them of any use; the most useful of these inventions are the various forms of prism glass already referred to and illustrated in this article.

See L. F. Day, *Stained and Painted Glass*; and W. Eckstein, *Interior Lighting*. (J. Br.)

GLAZUNOV, ALEXANDER CONSTANTINOVICH (1865-), Russian musical composer, was born in St Petersburg on the 10th of August 1865, his father being a publisher and bookseller. He showed an early talent for music, and studied for a year or so with Rimsky-Korsakov. At the age of sixteen he composed a symphony (afterwards elaborated and published as *op. 5*), but his *opus 1* was a quartet in D, followed by a pianoforte suite on *S-a-c-h-a*, the diminutive of his name Alexander. In 1884 he was taken up by Liszt, and soon became known as a composer. His first symphony was played that year at Weimar, and he appeared as a conductor at the Paris exhibition in 1889. In 1897 his fourth and fifth symphonies were performed in London

under his own conducting. In 1900 he became professor at the St Petersburg conservatoire. His separate works, including orchestral symphonies, dance music and songs, make a long list. Glazunov is a leading representative of the modern Russian school, and a master of orchestration; his tendency as compared with contemporary Russian composers is towards classical form, and he was much influenced by Brahms, though in "programme music" he is represented by such works as his symphonic poems *The Forest*, *Stenka Razin*, *The Kremlin* and his suite *Aus dem Mittelalter*. His ballet music, as in *Raymonda*, achieved much popularity.

GLEBE (Lat. *glebo*, *glebo*, clod or lump of earth, hence soil, land), in ecclesiastical law the land devoted to the maintenance of the incumbent of a church. Burn (*Ecclesiastical Law*, s.v. "Glebe Lands") says: "Every church of common right is entitled to house and glebe, and the assigning of them at the first was of such absolute necessity that without them no church could be regularly consecrated. The house and glebe are both comprehended under the word *manse*, of which the rule of the canon law is, *sanctum est ut unicuique ecclesie unus mansus integer absque ullo servitio tribuatur*." In the technical language of English law the fee-simple of the glebe is said to be in *abeyance*, that is, it exists "only in the remembrance, expectation and intentment of the law." But the freehold is in the parson, although at common law he could alienate the same only with proper consent,—that is, in his case, with the consent of the bishop. The disabling statutes of Elizabeth (Alienation by Bishops, 1559, and Dilapidations, &c., 1571) made void all alienations by ecclesiastical persons, except leases for the term of twenty-one years or three lives. By an act of 1842 (5 & 6 Vict. c. 27, Ecclesiastical Leases) glebe land and buildings may be let on lease for farming purposes for fourteen years or on an improving lease for twenty years. But the parsonage house and ten acres of glebe situate most conveniently for occupation must not be leased. By the Ecclesiastical Leasing Acts of 1842 (5 & 6 Vict. c. 108) and 1858 glebe lands may be let on building leases for not more than ninety-nine years and on mining leases for not more than sixty years. The Tithe Act 1842, the Glebe Lands Act 1888 and various other acts make provision for the sale, purchase, exchange and gift of glebe lands. In Scots ecclesiastical law, the *manse* now signifies the minister's dwelling-house, the glebe being the land to which he is entitled in addition to his stipend. All parish ministers appear to be entitled to a glebe, except the ministers in royal burghs proper, who cannot claim a glebe unless there be a landowner's district annexed; and even in that case, when there are two ministers, it is only the first who has a claim.

See Phillimore, *Ecclesiastical Law* (2nd ed.); Cripps, *Law of Church and Clergy*; Leach, *Tithes Acts* (6th ed.); Dart, *Vendors and Purchasers* (7th ed.).

GLEE, a musical term for a part-song of a particular kind. The word, as well as the thing, is essentially confined to England. The technical meaning has been explained in different ways; but there is little doubt of its derivation through the ordinary sense of the word (*i.e.* merriment, entertainment) from the A.S. *gleow*, *gleo*, corresponding to Lat. *gaudium*, *delectamentum*, hence *ludus musicus*; on the other hand, a musical "glee" is by no means necessarily a merry composition. Gleeman (A.S. "gleo-man") is translated simply as "musicus" or "cantor," to which the less distinguished titles of "mimus, jocista, scurra," are frequently added in old dictionaries. The accomplishments and social position of the gleeman seem to have been as varied as those of the Provençal "joglar." There are early examples of the word "glee" being used as synonymous with harmony or concerted music. The former explanation, for instance, is given in the *Promptorium parvulorum*, a work of the 15th century. Glee in its present meaning signifies, broadly speaking, a piece of concerted vocal music, generally unaccompanied, and for male voices, though exceptions are found to the last two restrictions. The number of voices ought not to be less than three. As regards musical form, the glee is little distinguished from the catch,—the two terms being often used indiscriminately for the

same song; but there is a distinct difference between it and the madrigal—one of the earliest forms of concerted music known in England. While the madrigal does not show a distinction of contrasted movements, this feature is absolutely necessary in the glee. In the madrigal the movement of the voices is strictly contrapuntal, while the more modern form allows of freer treatment and more compact harmonies. Differences of tonality are fully explained by the development of the art, for while the madrigal reached its acme in Queen Elizabeth's time, the glee proper was little known before the Commonwealth; and its most famous representatives belong to the 18th century and the first quarter of the 19th. Among the numerous collections of the innumerable pieces of this kind, only one of the earliest and most famous may be mentioned, *Catch that Catch can, a Choice Collection of Catches, Rounds and Canons, for three and four voices*, published by John Hilton in 1652. The name "glee," however, appears for the first time in John Playford's *Musical Companion*, published twenty-one years afterwards, and reprinted again and again, with additions by later composers—Henry Purcell, William Croft and John Blow among the number. The originator of the glee in its modern form was Dr Arne, born in 1710. Among later English musicians famous for their glees, catches and part-songs, the following may be mentioned:—Attwood, Boyce, Bishop, Crotch, Callcott, Shield, Stevens, Horsley, Webb and Knyvett. The convivial character of the glee led, in the 18th century, to the formation of various societies, which offered prizes and medals for the best compositions of the kind and assembled for social and artistic purposes. The most famous amongst these—The Glee Club—was founded in 1787, and at first used to meet at the house of Mr Robert Smith, in St Paul's churchyard. This club was dissolved in 1857. A similar society—The Catch Club—was formed in 1761 and is still in existence.

GLEICHEN, two groups of castles in Germany, thus named from their resemblance to each other (Ger. *gleich*—like, or resembling). The first is a group of three, each situated on a hill in Thuringia between Gotha and Erfurt. One of these called Gleich, the Wandersleben Gleich (1221 ft. above the sea), was besieged unsuccessfully by the emperor Henry IV. in 1088. It was the seat of a line of counts, one of whom, Ernest III., a crusader, is the subject of a romantic legend. Having been captured, he was released from his imprisonment by a Turkish woman, who returned with him to Germany and became his wife, a papal dispensation allowing him to live with two wives at the same time (see Reineck, *Die Sage von der Doppelhe eines Grafen von Gleich*, 1891). After belonging to the elector of Mainz the castle became the property of Prussia in 1803. The second castle is called Mühlburg (1309 ft. above the sea). This existed as early as 704 and was besieged by Henry IV. in 1087. It came into the hands of Prussia in 1803. The third castle, Wachsenburg (1358 ft.), is still inhabited and contains a collection of weapons and pictures belonging to its owner, the duke of Saxe-Coburg-Gotha, whose family obtained possession of it in 1368. It was built about 935 (see Beyer, *Die drei Gleichen*, Erfurt, 1898). The other group consists of two castles, Neuen-Gleichen and Alten-Gleichen. Both are in ruins and crown two hills about 2 m. S.E. from Göttingen.

The name of Gleichen is taken by the family descended from Prince Victor of Hohenlobe-Langenburg through his marriage with Miss Laura Seymour, daughter of Admiral Sir George Francis Seymour, a branch of the Hohenlobe family having at one time owned part of the county of Gleichen.

GLEIG, GEORGE (1753–1840), Scottish divine, was born at Bognhall, Kincardineshire, on the 12th of May 1753, the son of a farmer. At the age of thirteen he entered King's College, Aberdeen, where the first prize in mathematics and physical and moral sciences fell to him. In his twenty-first year he took orders in the Scottish Episcopal Church, and was ordained to the pastoral charge of a congregation at Pittenweem, Fife, whence he removed in 1790 to Stirling. He became a frequent contributor to the *Monthly Review*, the *Gentleman's Magazine*, the *Anti-Jacobin Review* and the *British Critic*. He also wrote several

articles for the third edition of the *Encyclopædia Britannica*, and on the death of the editor, Colin Macfarquhar, in 1793, was engaged to edit the remaining volumes. Among his principal contributions to this work were articles on "Instinct," "Theology" and "Metaphysics." The two supplementary volumes were mainly his own work. He was twice chosen bishop of Dunkeld, but the opposition of Bishop Skinner, afterwards primate, rendered the election on both occasions ineffectual. In 1808 he was consecrated assistant and successor to the bishop of Brechin, in 1810 was preferred to the sole charge, and in 1816 was elected primate of the Episcopal Church of Scotland, in which capacity he greatly aided in the introduction of many useful reforms, in fostering a more catholic and tolerant spirit, and in cementing a firm alliance with the sister church of England. He died at Stirling on the 9th of March 1840.

Besides various sermons, Gleig was the author of *Directions for the Study of Theology*, in a series of letters from a bishop to his son on his admission to holy orders (1827); an edition of *Slackhouse's History of the Bible* (1817); and a life of Robertson the historian, prefixed to an edition of his works. See *Life of Bishop Gleig*, by the Rev. W. Walker (1879). Letters to Henderson of Edinburgh and John Douglas, bishop of Salisbury, are in the *British Museum*.

His third and only surviving son, **GEORGE ROBERT GLEIG** (1796–1888), was educated at Glasgow University, whence he passed with a Snell exhibition to Balliol College, Oxford. He abandoned his scholastic studies to enter the army, and served with distinction in the Peninsular War (1813–14), and in the American War, in which he was thrice wounded. Resuming his work at Oxford, he proceeded B.A. in 1818, M.A. in 1821, and, having been ordained in 1820, held successively curacies at Westwell in Kent and Ash (to the latter the rectory of Ivy Church was added in 1822). He was subsequently appointed chaplain of Chelsea hospital (1824), chaplain-general of the forces (1844–1875) and inspector-general of military schools (1846–1857). From 1848 till his death on the 9th of July 1888 he was prebend of Willesden in St Paul's cathedral. During the last sixty years of his life he was a prolific, if not very scientific, writer; he wrote for *Blackwood's Magazine* and *Fraser's Magazine*, and produced a large number of historical works.

Among the latter were (besides histories of the campaigns in which he served), *Life of Sir Thomas Munro* (3 vols., 1830); *History of India* (4 vols., 1830–1835); *The Leipzig Campaign and Lives of Military Commanders* (1831); *Story of the Battle of Waterloo* (1847); *Sketch of the Military History of Great Britain* (1845); *Sale's Brigade in Afghanistan* (1847); biographies of Lord Clive (1848), the duke of Wellington (1862), and Warren Hastings (1848); the subject of Macaulay's essay, in which it is described as "three big bad volumes full of undigested correspondence and undiscerning panegyric."

GLEIM, JOHANN WILHELM LUDWIG (1719–1803), German poet, was born on the 2nd of April 1719 in Ermsleben, near Halberstadt. Having studied law at the university of Halle he became secretary to Prince William of Brandenburg-Schwedt at Berlin, where he made the acquaintance of Ewald von Kleist, whose devoted friend he became. When the prince fell at the battle of Prague, Gleim became secretary to Prince Leopold of Dessau; but he soon gave up his position, not being able to bear the roughness of the "Old Dessauer." After residing a few years in Berlin he was appointed, in 1747, secretary of the cathedral chapter at Halberstadt. "Father Gleim" was the title accorded to him throughout all literary Germany on account of his kind-hearted though inconsiderate and indiscriminating patronage alike of the poets and poetasters of the period. He wrote a large number of feeble imitations of Anacreon, Horace and the minnesingers, a dull didactic poem entitled *Halloldat oder das rote Buch* (1774), and collections of fables and romances. Of higher merit are his *Preussische Kriegslieder von einem Grenadier* (1758). These, which were inspired by the campaigns of Frederick II., are often distinguished by genuine feeling and vigorous force of expression. They are also noteworthy as being the first of that long series of noble political songs in which later German literature is so rich. With this exception, Gleim's writings are for the most part tamely commonplace in thought and expression. He died at Halberstadt on the 18th of February 1803.

Gleim's *Sämmtliche Werke* appeared in 7 vols. in the years 1811–1813; a reprint of the *Lieder eines Grenadiers* was published by

A. Sauer in 1882. A good selection of Gleim's poetry will be found in F. Mucker, *Andenken und preussisch-patriotische Lyriker* (1894). See W. Körte, *Gleims Leben aus seinen Briefen und Schriften* (1811). His correspondence with Heinse was published in 2 vols. (1894-1896), with Uz (1889), in both cases edited by C. Schüddekopf.

GLEIWITZ, a town of Germany, in the Prussian province of Silesia, on the Kłodnitz, and the railway between Oppeln and Cracow, 40 m. S.E. of the former town. Pop. (1875) 14,156; (1905) 61,324. It possesses two Protestant and four Roman Catholic churches, a synagogue, a mining school, a convent, a hospital, two orphanages, and barracks. Gleiwitz is the centre of the mining industry of Upper Silesia. Besides the royal foundry, with which are connected machine manufactories and boiler-works, there are other foundries, meal mills and manufactories of wire, gas pipes, cement and paper.

See B. Nietsche, *Geschichte der Stadt Gleiwitz* (1886); and Seidel, *Die königliche Eisengießerei zu Gleiwitz* (Berlin, 1896).

GLENALMOND, a glen of Perthshire, Scotland, situated to the S.E. of Loch Tay. It comprises the upper two-thirds of the course of the Almond, or a distance of 30 m. For the greater part it follows a direction east by south, but at Newton Bridge it inclines sharply to the south-east for 3 m., and narrows to such a degree that this portion is known as the Small (or Sma') Glen. At the end of this pass the glen expands and runs eastwards as far as the well-known public school of Trinity College, where it may be considered to terminate. The most interesting spot in the glen is that traditionally known as the grave of Ossian. The district east of Buchanty, near which are the remains of a Roman camp, is said to be the Drumtochty of Ian Maclaren's stories. The mountainous region at the head of the glen is dominated by Ben y Hone or Ben Chonzie (3048 ft. high).

GLENCAIRN, EARLS OF. The 1st earl of Glencairn in the Scottish peerage was ALEXANDER CUNNINGHAM (d. 1488), a son of Sir Robert Cunningham of Kilmaurs in Ayrshire. Made a lord of the Scottish parliament as Lord Kilmaurs not later than 1469, Cunningham was created earl of Glencairn in 1488; and a few weeks later he was killed at the battle of Sauchieburn whilst fighting for King James III. against his rebellious son, afterwards James IV. His son and successor, ROBERT (d. c. 1490), was deprived of his earldom by James IV., but before 1505 this had been revived in favour of Robert's son, CUTHERBERT (d. c. 1540), who became 3rd earl of Glencairn, and whose son WILLIAM (c. 1490-1547) was the 4th earl. This noble, an early adherent of the Reformation, was during his public life frequently in the pay and service of England, although he fought on the Scottish side at the battle of Solway Moss (1542), where he was taken prisoner. Upon his release early in 1543 he promised to adhere to Henry VIII., who was anxious to bring Scotland under his rule, and in 1544 he entered into other engagements with Henry, undertaking *inter alia* to deliver Mary queen of Scots to the English king. However, he was defeated by James Hamilton, earl of Arran, and the project failed; Glencairn then deserted his fellow-conspirator, Matthew Stewart, earl of Lennox, and came to terms with the queen-mother, Mary of Guise, and her party.

William's son, ALEXANDER, the 5th earl (d. 1574), was a more pronounced reformer than his father, whose English sympathies he shared, and was among the intimate friends of John Knox. In March 1557 he signed the letter asking Knox to return to Scotland; in the following December he subscribed the first "band" of the Scottish reformers; and he anticipated Lord James Stewart, afterwards the regent Murray, in taking up arms against the regent, Mary of Guise, in 1558. Then, joined by Stewart and the lords of the congregation, he fought against the regent, and took part in the attendant negotiations with Elizabeth of England, whom he visited in London in December 1560. When in August 1561 Mary queen of Scots returned to Scotland, Glencairn was made a member of her council; he remained loyal to her after she had been deserted by Murray, but in a few weeks rejoined Murray and the other Protestant lords, returning to Mary's side in 1566. After the queen had married the earl of Bothwell she was again forsaken by Glencairn, who fought against her at Carberry Hill and at Langside.

The earl, who was always to the fore in destroying churches, abbeys and other "monuments of idolatry," died on the 23rd of November 1574. His short satirical poem against the Grey Friars is printed by Knox in his *History of the Reformation*.

JAMES, the 7th earl (d. c. 1622), took part in the seizure of James VI., called the raid of Ruthven in 1582. WILLIAM, the 9th earl (c. 1610-1664), a somewhat lukewarm Royalist during the Civil War, was a party to the "engagement" between the king and the Scots in 1647; for this proceeding the Scottish parliament deprived him of his office as lord justice-general, and nominally of his earldom. In March 1653 Charles II. commissioned the earl to command the Royalist forces in Scotland, pending the arrival of General John Middleton, and the insurrection of this year is generally known as Glencairn's rising. After its failure he was betrayed and imprisoned, but although excepted from pardon he was not executed; and when Charles II. was restored he became lord chancellor of Scotland. After a dispute with his former friend, James Sharp, archbishop of St Andrews, he died at Belton in Haddingtonshire on the 30th of May 1664. This earl's son JOHN (d. 1703), who followed his brother Alexander as 11th earl in 1670, was a supporter of the Revolution of 1688. His descendant, JAMES, the 14th earl (1749-1791), is known as the friend and patron of Robert Burns. He performed several useful services for the poet; and when he died on the 30th of January 1791 Burns wrote a *Lament* beginning, "The wind blew hollow frae the hills," and ending with the lines, "But I'll remember thee, Glencairn, and a' that thou hast done for me." The 14th earl was never married, and when his brother and successor, John, died childless in September 1796 the earldom became extinct, although it was claimed by Sir Adam Fergusson, Bart., a descendant of the 10th earl.

GLENCOE, a glen in Scotland, situated in the north of Argyllshire. Beginning at the north-eastern base of Buchaille Etive, it takes a gentle north-westerly trend for 10 m. to its mouth on Loch Leven, a salt-water arm of Loch Linnhe. On both sides it is shut in by wild and precipitous mountains and its bed is swept by the Coe-Ossian's "dark Cona,"—which rises in the hills at its eastern end. About half-way down the glen the stream forms the tiny Loch Tricochan. Towards Invercoe the landscape acquires a softer beauty. Here Lord Strathcona, who, in 1894, purchased the heritage of the Macdonalds of Glencoe, built his stately mansion of Mount Royal. The principal mountains on the south side are the various peaks of Buachaille Etive, Stob Dearg (3345 ft.), Bidean nam Bian (3756 ft.) and Meall Mor (2215 ft.), and on the northern side the Pap of Glencoe (2430 ft.), Sgor nam Fianaidh (3168 ft.) and Meall Dearg (3118 ft.). Points of interest are the Devil's Staircase, a steep, boulder-strewn "cut" (1754 ft. high) across the hills to Fort William; the Study; the cave of Ossian, where tradition says that he was born, and the Iona cross erected in 1883 by a Macdonald in memory of his clansmen who perished in the massacre of 1692. About 1 m. beyond the head of the glen is Kingshouse, a relic of the old coaching days, when it was customary for tourists to drive from Ballachulish via Tyndrum to Loch Lomond. Now the Glencoe excursion is usually made from Oban—by rail to Achnacloch, steamer up Loch Etive, coach up Glen Etive and down Glencoe and steamer at Ballachulish to Oban. One mile to the west of the Glen lies the village of BALLACHULISH (pop. 1143). It is celebrated for its slate quarries, which have been worked since 1760. The industry provides employment for 600 men and the annual output averages 30,000 tons. The slate is of excellent quality and is used throughout the United Kingdom. Ballachulish is a station on the Callander and Oban extension line to Fort William (Caledonian railway). The pier and ferry are some 2 m. W. of the village.

GLENCORSE, JOHN INGLIS, LORD (1810-1891), Scottish judge, son of a minister, was born at Edinburgh on the 21st of August 1810. From Glasgow University he went to Balliol College, Oxford. He was admitted a member of the Faculty of Advocates, and soon became known as an eloquent and successful pleader. In 1832 he was made solicitor-general for

Scotland in Lord Derby's first ministry, three months later becoming Lord Advocate. In 1858 he resumed this office in Lord Derby's second administration, being returned to the House of Commons as member for Stamford. He was responsible for the Universities of Scotland Act of 1858, and in the same year he was elevated to the bench as lord justice clerk. In 1867 he was made lord justice general of Scotland and lord president of the court of session, taking the title of Lord Glencorse. Outside his judicial duties he was responsible for much useful public work, particularly in the department of higher education. In 1869 he was elected chancellor of Edinburgh University, having already been rector of the university of Glasgow. He died on the 20th August 1891.

GLEN DALOUGH, VALE OF, a mountain glen of Co. Wicklow, Ireland, celebrated and frequently visited both on account of its scenic beauty and, more especially, because of the collection of ecclesiastical remains situated in it. Fortunately for its appearance, it is not approached by any railway, but services of cars are maintained to several points, of which Rathdrum, 8½ m. S.E., is the nearest railway station, on the Dublin & South-Eastern. The glen is traversed by the stream of Glenealo, a tributary of the Avonmore, expanding into small loughs, the Upper and the Lower. The former of these is walled by the abrupt heights of Camaderry (2206 ft.) and Lugduff (2176 ft.), and here the extreme narrowness of the valley adds to its grandeur; while lower down, where it widens, the romantic character of the scenery is enhanced by the scattered ruins of the former monastic settlement. These ruins have the collective name of the "Seven Churches." The settlement owed its foundation to the hermit St Kevin, who is reputed to have died on the 3rd of June 618; and it rapidly became a seat of learning of wide fame, but suffered much at the hands of the Danes and the Anglo-Normans. In close proximity to an hotel, and to one another, in an enclosure, are a round tower, one of the finest in Ireland, 110 ft. high and 52 in circumference; St Kevin's kitchen or church (closely resembling the house of St Columba at Kells), which measures 25 ft. by 15, with a high-pitched roof and round belfry—supposed to be the earliest example of its type; and the cathedral, about 73 ft. in total length by 51 in width. This possesses a good square-headed doorway, and an east window of ornate character (the chancel being of later date than the nave), and there are also some early tombs, but the whole is in a decayed condition. In the enclosure are also a Lady chapel, chiefly remarkable for its doorway of wrought granite, in a style of architecture resembling Greek, a priest's house (restored), and slight remains of St Chiaran's church. Here is also St Kevin's cross, a granite monolith never completed, and the enclosure is entered by a fine though dilapidated gateway. Other neighbouring remains are Trinity or the Ivy Church, towards Laragh, with beautiful detailed work; St Saviour's monastery, carefully restored under the direction of the Board of Works, with a chancel arch of three orders (re-erected), while on the shores of the upper lough are Reefert Church, the burial-place of the O'Toole family, and Teampull-na-skellig, the church of the rock. St Kevin's bed is a cave approachable with difficulty, above the lough, probably a natural cavity artificially enlarged, to which attaches the legend of St Kevin's hermitage. Along the valley there are a number of monuments and stone crosses of various sizes and styles. The whole collection forms, with the possible exception of Clonmacnoise in King's county, the most striking monument of monasticism in Ireland.

GLEN DOWER, OWEN (c. 1350-1415), the last to claim the title of an independent prince of Wales, more correctly described as Owain ab Gruffydd, lord of Glyndyrdwy in Merioneth, was a man of good family, with two great houses, Sycharth and Glyndyrdwy in the north, besides smaller estates in south Wales. His father was called Gruffydd Vychan, and his mother Helen; on both sides he had pretensions to be descended from the old Welsh princes. Owen was probably born about 1350, studied law at Westminster, was squire to the earl of Arundel, and a witness for Grosvenor in the famous Scrope and Grosvenor lawsuit in 1386. Afterwards he was in the service of Henry of

Bolingbroke, the future king, though by an error it has been commonly stated that he was squire to Richard II. Welsh sympathies were, however, on Richard's side, and combined with a personal quarrel to make Owen the leader of a national revolt.

The lords of Glyndyrdwy had an ancient feud with their English neighbours, the Greys of Ruthin. Reginald Grey neglected to summon Owen, as was his duty, for the Scottish expedition of 1400, and then charged him with treason for failing to appear. Owen thereupon took up arms, and when Henry IV. returned from Scotland in September he found north Wales ablaze. A hurried campaign under the king's personal command was ineffectual. Owen's estates were declared forfeit and vigorous measures threatened by the English government. Still the revolt gathered strength. In the spring of 1401 Owen was raiding in south Wales, and credited with the intention of invading England. A second campaign by the king in the autumn was defeated, like that of the previous year, through bad weather and the Fabian tactics of the Welsh. Owen had already been intriguing with Henry Percy (Hotspur), who during 1401 held command in north Wales, and with Percy's brother-in-law, Sir Edmund Mortimer. During the winter of 1401-1402 his plans were further extended to negotiations with the rebel Irish, the Scots and the French. In the spring he had grown so strong that he attacked Ruthin, and took Grey prisoner. In the summer he defeated the men of Hereford under Edmund Mortimer at Pilleth, near Brynglas, in Radnorshire. Mortimer was taken prisoner and treated with such friendliness as to make the English doubt his loyalty; within a few months he married Owen's daughter. In the autumn the English king was for the third time driven "bootless home and weather-beaten back." The few English strongholds left in Wales were now hard pressed, and Owen boasted that he would meet his enemy in the field. Nevertheless, in May 1403 Henry of Monmouth was allowed to sack Sycharth and Glyndyrdwy unopposed. Owen had a greater plot in hand. The Percies were to rise in arms, and meeting Owen at Shrewsbury, overwhelm the prince before help could arrive. But Owen's share in the undertaking miscarried through his own defeat near Carmarthen on the 12th of July, and Percy was crushed at Shrewsbury ten days later. Still the Welsh revolt was never so formidable. Owen styled himself openly prince of Wales, established a regular government, and called a parliament at Machynlleth. As a result of a formal alliance the French sent troops to his aid, and in the course of 1404 the great castles of Harlech and Aberystwith fell into his hands.

In the spring of 1405 Owen was at the height of his power; but the tide turned suddenly. Prince Henry defeated the Welsh at Grosmont in March, and twice again in May, when Owen's son Griffith and his chancellor were made prisoners. Scrope's rebellion in the North prevented the English from following up their success. The earl of Northumberland took refuge in Wales, and the tripartite alliance of Owen with Percy and Mortimer (transferred by Shakespeare to an earlier occasion) threatened a renewal of danger. But Northumberland's plots and the active help of the French proved ineffective. The English under Prince Henry gained ground steadily, and the recovery of Aberystwith, after a long siege, in the autumn of 1408 marked the end of serious warfare. In February 1409 Harlech was also recaptured, and Owen's wife, daughter and grandchildren were taken prisoners. Owen himself still held out and even continued to intrigue with the French. In July 1415 Gilbert Talbot had power to treat with Owen and his supporters and admit them to pardon. Owen's name does not occur in the document renewing Talbot's powers in February 1416; according to Adam of Usk he died in 1415. Later English writers allege that he died of starvation in the mountains; but Welsh legend represents him as spending a peaceful old age with his sons-in-law at Ewys and Monington in Herefordshire, till his death and burial at the latter place. The dream of an independent and united Wales was never nearer realization than under Owen's leadership. The disturbed state of England

helped him, but he was indeed a remarkable personality, and has not undeservedly become a national hero. Sentiment and tradition have magnified his achievements, and confused his career with tales of portents and magical powers. Owen left many bastard children; his legitimate representative in 1433 was his daughter Alice, wife of Sir John Scudamore of Ewyas.

The facts of Owen's life must be pieced together from scattered references in contemporary chronicles and documents; perhaps the most important are Adam of Usk's *Chronicle* and Ellis's *Original Letters*. On the Welsh side something is given by the bards Iolo Goch and Lewis Glyn Cothi. For modern accounts consult J. H. Wylie's *History of England under Henry IV.* (4 vols., 1884-1898); A. C. Bradley's popular biography; and Professor Tout's article in the *Dictionary of National Biography*. (C. L. K.)

GLENELG, CHARLES GRANT, BARON (1778-1866), eldest son of Charles Grant (q.v.), chairman of the directors of the East India Company, was born in India on the 26th of October 1778, and was educated at Magdalene College, Cambridge, of which he became a fellow in 1802. Called to the bar in 1807, he was elected member of parliament for the Laverne burghs in 1807, and having gained some reputation as a speaker in the House of Commons, he was made a lord of the treasury in December 1813, an office which he held until August 1819, when he became secretary to the lord-lieutenant of Ireland and a privy councillor. In 1823 he was appointed vice-president of the board of trade; from September 1827 to June 1828 he was president of the board and treasurer of the navy; then joining the Whigs, he was president of the board of control under Earl Grey and Lord Melbourne from November 1830 to November 1834. At the board of control Grant was primarily responsible for the act of 1833, which altered the constitution of the government of India. In April 1835 he became secretary for war and the colonies, and was created Baron Glenelg. His term of office was a stormy one. His differences with Sir Benjamin d'Urban (q.v.), governor of Cape Colony, were serious; but more so were those with King William IV. and others over the administration of Canada. He was still secretary when the Canadian rebellion broke out in 1837; his wavering and feeble policy was fiercely attacked in parliament; he became involved in disputes with the earl of Durham, and the movement for his supersession found supporters even among his colleagues in the cabinet. In February 1839 he resigned, receiving consolation in the shape of a pension of £2000 a year. From 1818 until he was made a peer Grant represented the county of Inverness in parliament, and he has been called "the last of the Canningsites." Living mainly abroad during the concluding years of his life, he died unmarried at Cannes on the 23rd of April 1866 when his title became extinct.

Glenelg's brother, **SIR ROBERT GRANT** (1779-1838), who was third wrangler in 1801, was, like his brother, a fellow of Magdalene College, Cambridge, and a barrister. From 1818 to 1834 he represented various constituencies in parliament, where he was chiefly prominent for his persistent efforts to relieve the disabilities of the Jews.¹ In June 1834 he was appointed governor of Bombay, and he died in India on the 9th of July 1838. Grant wrote a *Sketch of the History of the East India Co.* (1813), and is also known as a writer of hymns.

GLENELG, a municipal town and watering place of Adelaide county, South Australia, on Holdfast Bay, 6½ m. by rail S.S.W. of the city of Adelaide. Pop. (1901) 3949. It is a popular summer resort, connected with Adelaide by two lines of railway. In the vicinity is the "Old Gum Tree" under which South Australia was proclaimed British territory by Governor Hindmarsh in 1836.

GLENGARRIFF, or GLENGARRIFF ("Rough Glen"), a celebrated resort of tourists in summer and invalids in winter, in the west riding of county Cork, Ireland, on Glengarriff Harbour, an inlet on the northern side of Bantry Bay, 11 m. by coach road from Bantry on the Cork, Bandon & South Coast railway. Beyond its hotels, Glengarriff is only a small village, but the island-studded harbour, the narrow glen at its head and the surrounding

¹ Sir S. Walpole (*History of England*, vol. v.) is wrong in stating that Charles Grant introduced bills to remove Jewish disabilities in 1833 and 1834. They were introduced by his brother Robert.

of mountains, afford most attractive views, and its situation on the "Prince of Wales'" route travelled by King Edward VII. in 1848, and on a fine mountain coach road from Macroom, brings it into the knowledge of many travellers to Killarney. Thackeray wrote enthusiastically of the harbour. The glaciated rocks of the glen are clothed with vegetation of peculiar luxuriance, flourishing in the mild climate which has given Glengarriff its high reputation as a health resort for those suffering from pulmonary complaints.

GLEN GREY, a division of the Cape province south of the Stormberg, adjoining on the east the Transkeian Territories. Pop. (1904) 55,107. Chief town Lady Frere, 32 m. N.E. of Queenstown. The district is well watered and fertile, and large quantities of cereals are grown. Over 96% of the inhabitants are of the Zulu-Xosa (Kafir) race, and a considerable part of the district was settled during the Kafir wars of Cape Colony by Tembu (Tambookies) who were granted a location by the colonial government in recognition of their loyalty to the British. Act No. 25 of 1894 of the Cape parliament, passed at the instance of Cecil Rhodes, which laid down the basis upon which is effected the change of land tenure by natives from communal to individual holdings, and also dealt with native local self-government and the labour question, applied in the first instance to this division, and is known as the Glen Grey Act (see *CAPE COLONY: History*). The provisions of the act respecting individual land tenure and local self-government were in 1898 applied, with certain modifications, to the Transkeian Territories. The division is named after Sir George Grey, governor of Cape Colony 1854-1861.

GLENS FALLS, a village of Warren county, New York, U.S.A., 55 m. N. of Troy, on the Hudson river. Pop. (1890) 9500; (1900) 12,613, of whom 1762 were foreign-born; (1910 census) 15,243. Glens Falls is served by the Delaware & Hudson and the Hudson Valley (electric) railways. The village contains a state armoury, the Crandall free public library, a Y.M.C.A. building, the Park hospital, an old ladies' home, and St Mary's (Roman Catholic) and Glens Falls (non-sectarian) academies. There are two private parks, open to the public, and a water-works system is maintained by the village. An iron bridge crosses the river just below the falls, connecting Glens Falls and South Glens Falls (pop. in 1910, 2247). The falls of the Hudson here furnish a fine water-power, which is utilized, in connexion with steam and electricity, in the manufacture of lumber, paper and wood pulp, women's clothing, shirts, collars and cuffs, &c. In 1905 the village's factory products were valued at \$4,780,331. About 12 m. above Glens Falls, on the Hudson, a massive stone dam has been erected; here electric power, distributed to a large area, is generated. In the neighbourhood of Glens Falls are valuable quarries of black marble and limestone, and lime, plaster and Portland cement works. Glens Falls was settled about the close of the French and Indian War (1763), and was incorporated as a village in 1839.

GLENTILT, a glen in the extreme north of Perthshire, Scotland. Beginning at the confines of Aberdeenshire, it follows a north-westerly direction excepting for the last 4 m., when it runs due S. to Blair Atholl. It is watered throughout by the Tilt, which enters the Garry after a course of 14 m., and receives on its right the Tarff, which forms some beautiful falls just above the confluence, and on the left the Fender, which has some fine falls also. The attempt of the 6th duke of Atholl (1814-1864) to close the glen to the public was successfully contested by the Scottish Rights of Way Society. The group of mountains—Carn nan Gabhar (3505 ft.), Ben y Gloe (3671) and Carn Liath (3193)—on its left side dominate the lower half of the glen. Marble of good quality is occasionally quarried in the glen, and the rock formation has attracted the attention of geologists from the time of James Hutton.

GLEYRE, MARC CHARLES GABRIEL (1806-1874), French painter, of Swiss origin, was born at Chevilly in the canton of Vaud on the 2nd of May 1806. His father and mother died while he was yet a boy of some eight or nine years of age; and he was brought up by an uncle at Lyons, who sent him to the industrial school of that city. Going up to Paris a lad of

seventeen or nineteen, he spent four years in close artistic study—in Hersent's studio, in Suisse's academy, in the galleries of the Louvre. To this period of laborious application succeeded four years of mediative inactivity in Italy, where he became acquainted with Horace Vernet and Léopold Robert; and six years more were consumed in adventurous wanderings in Greece, Egypt, Nubia and Syria. At Cairo he was attacked with ophthalmia, and in the Lebanon he was struck down by fever; and he returned to Lyons in shattered health. On his recovery he proceeded to Paris, and, fixing his modest studio in the rue de Université, began carefully to work out the conceptions which had been slowly shaping themselves in his mind. Mention is made of two decorative panels—"Diana leaving the Bath," and a "Young Nubian"—as almost the first fruits of his genius; but these did not attract public attention till long after, and the painting by which he practically opened his artistic career was the "Apocalyptic Vision of St. John," sent to the Salon of 1840. This was followed in 1843 by "Evening," which at the time received a medal of the second class, and afterwards became widely popular under the title of the Lost Illusions. It represents a poet seated on the bank of a river, with drooping head and wearied frame, letting his lyre slip from a careless hand, and gazing sadly at a bright company of maidens whose song is slowly dying from his ear as their boat is borne slowly from his sight.

In spite of the success which attended these first ventures, Gleyre retired from public competition, and spent the rest of his life in quiet devotion to his own artistic ideals, neither seeking the easy applause of the crowd, nor turning his art into a means of aggrandizement and wealth. After 1845, when he exhibited the "Separation of the Apostles," he contributed nothing to the Salon except the "Dance of the Bacchantes" in 1849. Yet he laboured steadily and was abundantly productive. He had an "infinite capacity of taking pains," and when asked by what method he attained to such marvellous perfection of workmanship, he would reply, "En y pensant toujours." A long series of years often intervened between the first conception of a piece and its embodiment, and years not unfrequently between the first and the final stage of the embodiment itself. A landscape was apparently finished; even his fellow artists would consider it done; Gleyre alone was conscious that he had not "found his sky." Happily for French art this high-toned laboriousness became influential on a large number of Gleyre's younger contemporaries; for when Delaroché gave up his studio of instruction he recommended his pupils to apply to Gleyre, who at once agreed to give them lessons twice a week, and characteristically refused to take any fee or reward. By instinct and principle he was a confirmed celibate: "Fortune, talent, health,—he had everything; but he was married," was his lamentation over a friend. Though he lived in almost complete retirement from public life, he took a keen interest in politics, and was a voracious reader of political journals. For a time, indeed, under Louis Philippe, his studio had been the rendezvous of a sort of liberal club. To the last—amid all the disasters that befell his country—he was hopeful of the future, "la raison finira bien par avoir raison." It was while on a visit to the Retrospective Exhibition, opened on behalf of the exiles from Alsace and Lorraine, that he died suddenly on the 5th of May 1874. He left unfinished the "Earthly Paradise," a noble picture, which Taine has described as "a dream of innocence, of happiness and of beauty—Adam and Eve standing in the sublime and joyous landscape of a paradise enclosed in mountains,"—a worthy counterpart to the "Evening." Among the other productions of his genius are the "Deluge," which represents two angels speeding above the desolate earth, from which the destroying waters have just begun to retire, leaving visible behind them the ruin they have wrought; the "Battle of the Lemanus," a piece of elaborate design, crowded but not cumbered with figures, and giving fine expression to the movements of the various bands of combatants and fugitives; the "Prodigal Son," in which the artist has ventured to add to the parable the new element of mother's love, greeting the repentant youth

with a welcome that shows that the mother's heart thinks less of the repentance than of the return, "Ruth and Boaz"; "Ulysses and Nausicaa"; "Hercules at the feet of Omphale"; the "Young Athenian," or, as it is popularly called, "Sappho"; "Minerva and the Nymphs"; "Venus *παρθένος*"; "Daphnia and Chloë"; and "Love and the Parcae." Nor must it be omitted that he left a considerable number of drawings and water-colours, and that we are indebted to him for a number of portraits, among which is the sad face of Heine, engraved in the *Revue des deux mondes* for April 1852. In Clément's catalogue of his works there are 683 entries, including sketches and studies.

See Fritz Berthoud in *Bibliothèque universelle de Genève* (1874); Albert de Montet, *Dict. biographique des Genevois et des Vaudois* (1877); and *Vie de Charles Gleyre* (1877), written by his friend, Charles Clément, and illustrated by 30 plates from his works.

GLIDDON, GEORGE ROBINS (1809-1857), British Egyptologist, was born in Devonshire in 1809. His father, a merchant, was United States consul at Alexandria, and there Gliddon was taken at an early age. He became United States vice-consul, and took a great interest in Egyptian antiquities. Subsequently he lectured in the United States and succeeded in rousing considerable attention to the subject of Egyptology generally. He died at Panama in 1857. His chief work was *Ancient Egypt* (1850, ed. 1853). He wrote also *Memoir on the Cotton of Egypt* (1841); *Appeal to the Antiquaries of Europe on the Destruction of the Monuments of Egypt* (1841); *Discourses on Egyptian Archaeology* (1841); *Types of Mankind* (1854), in conjunction with J. C. Nott and others; *Indigenous Races of the Earth* (1857), also in conjunction with Nott and others.

GLINKA, FEDOR NIKOLAEVICH (1788-1849), Russian poet and author, was born at Smolensk in 1788, and was specially educated for the army. In 1803 he obtained a commission as an officer, and two years later took part in the Austrian campaign. His tastes for literary pursuits, however, soon induced him to leave the service, whereupon he withdrew to his estates in the government of Smolensk, and subsequently devoted most of his time to study or travelling about Russia. Upon the invasion of the French in 1812, he re-entered the Russian army, and remained in active service until the end of the campaign in 1814. Upon the elevation of Count Milorodovich to the military governorship of St Petersburg, Glinka was appointed colonel under his command. On account of his suspected revolutionary tendencies he was, in 1826, banished to Petrozavodsk, but he nevertheless retained his honorary post of president of the Society of the Friends of Russian Literature, and was after a time allowed to return to St Petersburg. Soon afterwards he retired completely from public life, and died on his estates in 1849.

Glinka's martial songs have special reference to the Russian military campaigns of his time. He is known also as the author of the descriptive poem *Kareliya*, &c. (*Carelia, or the Captivity of Martha Joanaena*) (1830), and of a metrical paraphrase of the book of Job. His fame as a military author is chiefly due to his *Pisma Russkago Ofitsera (Letters of a Russian Officer)* (8 vols., 1815-1816).

GLINKA, MICHAEL IVANOVICH (1803-1857), Russian musical composer, was born at Novospassky, a village in the Smolensk government, on the 2nd of June 1803. His early life he spent at home, but at the age of thirteen we find him at the Blagorodrey Pension, St Petersburg, where he studied music under Carl Maier and John Field, the Irish composer and pianist, who had settled in Russia. We are told that in his seventeenth year he had already begun to compose romances and other minor vocal pieces; but of these nothing now is known. His thorough musical training did not begin till the year 1830, when he went abroad and stayed for three years in Italy, to study the works of old and modern Italian masters. His thorough knowledge of the requirements of the voice may be connected with this course of study. His training as a composer was finished under the contrapuntist Dehn, with whom Glinka stayed for several months at Berlin. In 1833 he returned to Russia, and devoted himself to operatic composition. On the 27th of September (9th of October) 1836, took place the first representation of his opera *Life for the Tsar* (the libretto by Baron

de Rosen). This was the turning-point in Glinka's life,—for the work was not only a great success, but in a manner became the origin and basis of a Russian school of national music. The story is taken from the invasion of Russia by the Poles early in the 17th century, and the hero is a peasant who sacrifices his life for the tsar. Glinka has wedded this patriotic theme to inspiring music. His melodies, moreover, show distinct affinity to the popular songs of the Russians, so that the term "national" may justly be applied to them. His appointment as imperial chaplain and conductor of the opera of St Petersburg was the reward of his dramatic successes. His second opera *Ruslan and Lyudmila*, founded on Pushkin's poem, did not appear till 1842; it was an advance upon *Life for the Tsar* in its musical aspect, but made no impression upon the public. In the meantime Glinka wrote an overture and four entre-actes to Kukolnik's drama *Prince Kholmisky*. In 1844 he went to Paris, and his *Jota Aragonesa* (1847), and the symphonic work on Spanish themes, *Une Nuit à Madrid*, reflect the musical results of two years' sojourn in Spain. On his return to St Petersburg he wrote and arranged several pieces for the orchestra, amongst which the so-called *Kamarinskaya* achieved popularity beyond the limits of Russia. He also composed numerous songs and romances. In 1857 he went abroad for the third time; he now wrote his autobiography, orchestrated Weber's *Invitation à la soirée*, and began to consider a plan for a musical version of Gogol's *Tarass-Boulba*. Abandoning the idea and becoming absorbed in a passion for ecclesiastical music he went to Berlin to study the ancient church modes. Here he died suddenly on the 2nd of February 1857.

GLINKA, SERGY NIKOLAEVICH (1774–1847), Russian author, the elder brother of Fedor N. Glinka, was born at Smolensk in 1774. In 1796 he entered the Russian army, but after three years' service retired with the rank of major. He afterwards employed himself in the education of youth and in literary pursuits, first in the Ukraine, and subsequently at Moscow, where he died in 1847. His poems are spirited and patriotic; he wrote also several dramatic pieces, and translated Young's *Night Thoughts*.

Among his numerous prose works the most important from an historical point of view are: *Russkos Chlenia* (*Russian Reading: Historical Memorials of Russia in the 18th and 19th Centuries*) (2 vols., 1845); *Istoriya Rossii, &c.* (*History of Russia for the use of Youth*) (10 vols., 1817–1819, 2nd ed. 1822, 3rd ed. 1824); *Istoriya Armii, &c.* (*History of the Migration of the Armenians of Azerbaijan from Turkey to Russia*) (1831); and his contributions to the *Russky Vestnik* (*Russian Messenger*), a monthly periodical, edited by him from 1808 to 1820.

GLOBE-FISH, or SEA-HEDGEHOG, the names by which some sea-fishes are known, which have the remarkable faculty of inflating their stomachs with air. They belong to the families Diodontidae and Tetrodontidae. Their jaws resemble the sharp beak of a parrot, the bones and teeth being coalesced into one mass with a sharp edge. In the Diodonts there is no mesial division of the jaws, whilst in the Tetrodons such a division exists, so that they appear to have two teeth above and two



FIG. 1.—*Diodon maculatus*.

below. By means of these jaws they are able to break off branches of corals, and to masticate other hard substances on which they feed. Usually they are of a short, thick, cylindrical shape, with powerful fins (fig. 1). Their body is covered with thick skin, without scales, but provided with variously formed spines, the size and extent of which vary in the different species. When they inflate their capacious stomachs with air, they assume a globular form, and the spines protrude, forming a more or less formidable defensive armour (fig. 2). A fish thus blown out

turns over and floats belly upwards, driving before the wind and waves. Many of these fishes are highly poisonous when eaten, and fatal accidents have occurred from this cause. It appears that they acquire poisonous qualities from their food, which frequently consists of decomposing or poisonous animal matter, such as would impart, and often does impart, similar

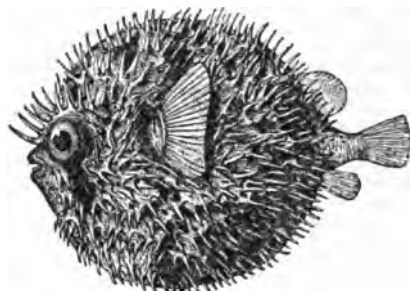

FIG. 2.—*Diodon maculatus* (inflated).

deleterious qualities to other fish. They are most numerous between the tropics and in the seas contiguous to them, but a few species live in large rivers, as, for instance, the *Tetrodon fahaka*, a fish well known to all travellers on the Nile. Nearly 100 different species are known.

GLOBIGERINA, A. d'Orbigny, a genus of Perforate Foraminifera (q.v.) of pelagic habit, and formed of a conical spiral aggregate of spheroidal chambers with a crescentic mouth. The shells accumulate at the bottom of moderately deep seas to form "Globigerina ooze" and are preserved thus in the chalk. *Hastigerina* only differs in the "flat" or nautiloid spiral.

GLOCKENSPIEL, or ORCHESTRAL BELLS (Fr. *carillon*; Ger. *Glockenspiel*, *Stahlharmonika*; Ital. *campanelli*; Med. Lat. *littinnabulum*, *cymbalum*, *bombulum*), an instrument of percussion of definite musical pitch, used in the orchestra, and made in two or three different styles. The oldest form of glockenspiel, seen in illuminated MSS. of the middle ages, consists of a set of bells mounted on a frame and played by one performer by means of steel hammers. The name "bell" is now generally a misnomer, other forms of metal or wood having been found more convenient. The pyramid-shaped glockenspiel, formerly used in the orchestra for simple rhythmical effects, consists of an octave of semitone, hemispherical bells, placed one above the other and fastened to an iron rod which passes through the centre of each, the bells being of graduated sizes and diminishing in diameter as the pitch rises. The lyre-shaped glockenspiel, or steel harmonica (*Stahlharmonika*), is a newer model, which has instead of bells twelve or more bars of steel, graduating in size according to their pitch. These bars are fastened horizontally across two bars of steel set perpendicularly in a steel frame in the shape of a lyre. The bars are struck by little steel hammers attached to whalebone sticks.

Wagner has used the glockenspiel with exquisite judgment in the fire scene of the last act of *Die Walküre* and in the peasants' walk in the last scene of *Die Meistersinger*. When chords are written for the glockenspiel, as in Mozart's *Magic Flute*, the keyed harmonica¹ is used. It consists of a keyboard having a little hammer attached to each key, which strikes a bar of glass or steel when the key is depressed. The performer, being able to use both hands, can play a melody with full harmonies, scale and arpeggio passages in single and double notes. A peal of hemispherical bells was specially constructed for Sir Arthur Sullivan's *Golden Legend*. It consists of four bells constructed of bell-metal about 1 in. thick, the largest measuring 27 in. in diameter, the smallest 23. They are fixed on a stand one above the other, with a clearance of about ½ in. between them; the rim of the lowest and largest bell is 15 in. from the foot of the stand. The bells are struck by mallets, which are of two kinds—a pair of hard wood for forte passages, and a pair covered

¹ See "The Keyed Harmonica improved by H. Klein of Pressburg," article in the *Allg. musik. Ztg.*, Bd. i. pp. 675-699 (Leipzig, 1798); also Becker, p. 254, *Bartel*.

with wash-leather for piano effects. The peal was unique at the time it was made for the *Golden Legend*, but a smaller bell of the same shape, $\frac{3}{4}$ in. thick, with a diameter measuring about 16 in., specially made for the performance of Lian's *St Elizabeth*, when conducted by the composer in London, evidently suggested the idea for the peal.

GLOGAU, a fortified town of Germany, in the Prussian province of Silesia, 50 m. N.W. from Breslau, on the railway to Frankfort-on-Oder. Pop. (1905) 23,461. It is built partly on an island and partly on the left bank of the Oder; and owing to the fortified enceinte having been pushed farther afield, new quarters have been opened up. Among its most important buildings are the cathedral, in the Gothic, and a castle (now used as a courthouse), in the Renaissance style, two other Roman Catholic and three Protestant churches, a new town-hall, a synagogue, a military hospital, two classical schools (*Gymnasien*) and several libraries. Owing to its situation on a navigable river and at the junction of several lines of railway, Glogau carries on an extensive trade, which is fostered by a variety of local industries, embracing machinery-building, tobacco, beer, oil, sugar and vinegar. It has also extensive lithographic works, and its wool market is celebrated.

In the beginning of the 11th century Glogau, even then a populous and fortified town, was able to withstand a regular siege by the emperor Henry V.; but in 1157 the duke of Silesia, finding he could not hold out against Frederick Barbarossa, set it on fire. In 1252 the town, which had been raised from its ashes by Henry I., the Bearded, became the capital of a principality of Glogau, and in 1482 town and district were united to the Bohemian crown. In the course of the Thirty Years' War Glogau suffered greatly. The inhabitants, who had become Protestants soon after the Reformation, were dragged into conformity by Wallenstein's soldiery; and the Jesuits received permission to build themselves a church and a college. Captured by the Protestants in 1632, and recovered by the Imperialists in 1633, the town was again captured by the Swedes in 1642, and continued in Protestant hands till the peace of Westphalia in 1648, when the emperor recovered it. In 1741 the Prussians took the place by storm, and during the Seven Years' War it formed an important centre of operations for the Prussian forces. After the battle of Jena (1806) it fell into the hands of the French; and was gallantly held by Laplane, against the Russian and Prussian besiegers, after the battle of Katzbach in August 1813 until the 17th of the following April.

See Minsberg, *Geschichte der Stadt und Festung Glogau's* (2 vols. Glogau, 1853); and H. von Below, *Zur Geschichte des Jahres 1806. Glogau's Belagerung und Verteidigung* (Berlin, 1893).

GLORIOSA, in botany, a small genus of plants belonging to the natural order Liliaceae, native of tropical Asia and Africa. They are bulbous plants, the slender stems of which support themselves by tendril-like prolongations of the tips of some of the narrow generally lanceolate leaves. The flowers, which are borne in the leaf-axils at the ends of the stem, are very handsome, the six, generally narrow, petals are bent back and stand erect, and are a rich orange yellow or red in colour; the six stamens project more or less horizontally from the place of insertion of the petals. They are generally grown in cultivation as stove-plants.

GLORY (through the O. Fr. *glorie*, modern *gloire*, from Lat. *gloria*, cognate with Gr. *κλέος*, *κλέω*), a synonym for fame, renown, honour, and thus used of anything which reflects honour and renown on its possessor. In the phrase "glory of God" the word implies both the honour due to the Creator, and His majesty and effulgence. In liturgies of the Christian Church are the *Gloria Patri*, the doxology beginning "Glory be to the Father," the response *Gloria tibi, Domine*, "Glory be to Thee, O Lord," sung or said after the giving out of the Gospel for the day, and the *Gloria in excelsis*, "Glory be to God on high," sung during the Mass and Communion service. A "glory" is the term often used as synonymous with halo, nimbus or aureola (*q.v.*) for the ring of light encircling the head or figure in a pictorial or other representation of sacred persons.

GLOSS, GLOSSARY, &c. The Greek word *γλῶσσα* (whence our "gloss"), meaning originally a tongue, then a language or dialect, gradually came to denote any obsolete, foreign, provincial, technical or otherwise peculiar word or use of a word (see Arist. *Rhet.* iii. 3. 2). The making of collections and explanations of such *γλῶσσαι* was at a comparatively early date a well-recognized form of literary activity. Even in the 5th century B.C., among the many writings of Abdera was included a treatise entitled *Περὶ Ὀμήρου ἢ ὁρθοεπίης καὶ γλῶσσίων*. It was not, however, until the Alexandrian period that the *γλωσσογράφοι*, glossographers (writers of glosses), or glossators, became numerous. Of many of these perhaps even the names have perished; but Athenaeus the grammarian alone (c. A.D. 250) alludes to no fewer than thirty-five. Among the earliest was Philetas of Cos (d. c. 200 B.C.), the elegiac poet, to whom Aristarchus dedicated the treatise *Πρὸς Φιλαρῶν*; he was the compiler of a lexicographical work, arranged probably according to subjects, and entitled *Ἀτακτα* or *Γλῶσσαι* (sometimes *Ἀτακτα γλῶσσαι*). Next came his disciple Zenodotus of Ephesus (c. 280 B.C.), one of the earliest of the Homeric critics and the compiler of *Γλῶσσαι Ὀμηρικαί*; Zenodotus in turn was succeeded by his greater pupil Aristophanes of Byzantium (c. 200 B.C.), whose great compilation *Περὶ λέξεων* (still partially preserved in that of Pollux), is known to have included *Ἀττικαὶ λέξεις*, *Λακωνικαὶ γλῶσσαι*, and the like. From the school of Aristophanes issued more than one glossographer of name,—Diodorus, Artemidorus (*Γλῶσσαι*, and a collection of *λέξεις ὀφαρτυτικαί*), Nicander of Colophon (*Γλῶσσαι*, of which some twenty-six fragments still survive), and Aristarchus (c. 210 B.C.), the famous critic, whose numerous labours included an arrangement of the Homeric vocabulary (*λέξεις*) in the order of the books. Contemporary with the last named was Crates of Mallus, who, besides making some new contributions to Greek lexicography and dialectology, was the first to create at Rome a taste for similar investigations in connexion with the Latin idioms. From his school proceeded Zenodotus of Mallus, the compiler of *Ἑθνικαὶ λέξεις* or *γλῶσσαι*, a work said to have been designed chiefly to support the views of the school of Pergamum as to the allegorical interpretation of Homer.² Of later date were Didymus (Chalcenterus, c. 50 B.C.), who made collections of *λέξεις τραγωδομένηαι κομικαί*, &c.; Apollonius Sophista (c. 20 B.C.), whose Homeric *Lexicon* has come down to modern times; and Neoptolemus, known distinctively as ὁ *γλωσσογράφος*. In the beginning of the 1st century of the Christian era Apion, a grammarian and rhetorician at Rome during the reigns of Tiberius and Claudius, followed up the labours of Aristarchus and other predecessors with *Γλῶσσαι Ὀμηρικαί*, and a treatise *Περὶ τῆς Ῥωμαϊκῆς διαλέκτου*; Heliodorus or Herodorus was another almost contemporary glossographer; Erotian also, during the reign of Nero, prepared a special glossary for the writings of Hippocrates, still preserved. To this period also Pamphilus, the author of the *Λεμίων*, from which Diogenian and Julius Vestinus afterwards drew so largely, most probably belonged. In the following century one of the most prominent workers in this department of literature was Aelius Herodianus, whose treatise *Περὶ μνημῶν λέξεων* has been edited in modern times, and whose *Ἐπιμετρήμωι* we still possess in an abridgment; also Pollux, Diogenian (*Λέξεις παντοδμή*), Julius Vestinus (*Ἐπιτομή τῶν Παιμφίλου γλωσσῶν*) and especially Phrynichus, who flourished towards the close of the 2nd century, and whose *Eclogae nominum et verborum Atticorum* has frequently been edited. To the 4th century belongs Ammonius of Alexandria (c. 380), who wrote *Περὶ ὁμοίων καὶ διαφορῶν λέξεων*, a dictionary of words used in senses different from those in which they had

² The history of the literary gloss in its proper sense has given rise to the common English use of the word to mean an interpretation, especially in a disingenuous, sinister or false way, the form "gloss," more particularly associated with explaining away, palliating or talking speciously, is simply an alternative spelling. The word has thus to some extent influenced, or been influenced by, the meaning of the etymologically different "gloss" = lustrous surface (from the same root as "glass"; cf. "glow"), in its extended sense of "outward fair seeming."

³ See Matthiae, *Glossaria Graeca* (Moscow, 1774/5).

been employed by older and approved writers. Of somewhat later date is the well-known Hesychius, whose often-edited *Λεξικόν* superseded all previous works of the kind; Cyril, the celebrated patriarch of Alexandria, also contributed somewhat to the advancement of glossography by his *Συναγωγή τῶν πρὸς διάφορον σημασίαν διαφόρων ὀνομασίων Μίξων*; while Orus, Orion, Philoxenus and the two Philemons also belong to this period. The works of Photius, Suidas and Zonaras, as also the *Etymologicum magnum*, to which might be added the *Lexica Sangermanica* and the *Lexica Segueriana*, are referred to in the article **DICTIONARY**.

To a special category of technical glossaries belongs a large and important class of works relating to the law-compilations of Justinian. Although the emperor forbade under severe penalties all commentaries (*ὄνομαζματα*) on his legislation (*Const. Deo Auctore*, sec. 12; *Const. Tanta*, sec. 21), yet indices (*ἰνδίκαι*) and references (*παράτετρα*), as well as translations (*ἐμμεταίαι κατά ὅσθα*) and paraphrases (*ἐμμεταίαι εἰς πλάτος*), were expressly permitted, and lavishly produced. Among the numerous compilers of alphabetically arranged *Μίξεις Ῥωμαϊκαὶ* or *Λεξικαὶ*, and *γλῶσσαι νομικαὶ* (*glossae nomicae*), Cyril and Philoxenus are particularly noted, but the authors of *παράγραφοι*, or *σημειώσεις*, whether *ἔξωθεν* or *ἑσῶθεν* *ἄνωται*, are too numerous to mention. A collection of these *παράγραφοι τῶν παλαιῶν*, combined with *ἄλλαι παράγραφοι* on the revised code called *τὰ βασιλικὰ*, was made about the middle of the 12th century by a disciple of Michael Hagiotheodorita. This work is known as the *Glossa ordinaria τῶν βασιλικῶν*¹.

In Italy also, during the period of the Byzantine ascendancy, various *glossae* (*glossae*) and scholia on the Justinian code were produced²; particularly the Turin gloss (reprinted by Savigny), to which, apart from later additions, a date prior to 1000 is usually assigned. After the total extinction of the Byzantine authority in the West the study of law became one of the free arts, and numerous schools for its cultivation were instituted. Among the earliest of these was that of Bologna, where Pepo (1075) and Imerius (1100-1118) began to give their expositions. They had a numerous following, who, besides delivering exegetical lectures ("ordinariae" on the *Digest* and *Code*, "extraordinariae" on the rest of the *Corpus juris civilis*), also wrote *glossae*, first interlinear, afterwards marginal.³ The series of these glossators was closed by Accursius (q.v.) with the compilation known as the *Glossa ordinaria* or *magistralis*, the authority of which soon became very great, so that ultimately it came to be a recognized maxim, "Quod non agnoscit glossa, non agnoscit curia."⁴ For some account of the glossators on the canon law, see **CANON LAW**.

In late classical and medieval Latin, *glossa* was the vulgar and romanized (e.g. in the early 8th century *Corpus Glossary*, and the late 8th century *Leiden Glossary*), *glossa* the learned form (Varro, *De ling. Lat.* vii. 10; Auson. *Epigr.* 127. 2 (86. 2)), written in Greek, Quint. i. 1. 34). The diminutive *glossula* occurs in Diom. 426. 26 and elsewhere. The same meaning has *glossarium* (Gell. xviii. 7. 3 *glossaria* = *γλωσσάρια*), which also occurs in the modern sense of "glossary" (Papias, "unde *glossarium* dictum quod omnium fere partium *glossas* continet"), as do the words *glossa*, *glossae*, *glossulae*, *glossenata* (Steinmeyer, *Alth. Gloss.* iv. 408, 410), expressed in later times by *dictionarium*, *dictionarius*, *vocabularium*, *vocabularius* (see **DICTIONARY**). *Glossa* and

glossema (Varro vii. 34. 107; Asinius Gallus, ap. Suet. *De gramm.* 22; Fest. 166^b. 8, 181^a. 18; Quint. i. 8. 15, &c.) are synonyms, signifying (a) the word which requires explanation; or (b) such a word (called *lemma*) together with the interpretation (*interpretamentum*); or (c) the interpretation alone (so first in the *Anecd. Helv.*).

Latin, like Greek glossography, had its origin chiefly in the practical wants of students and teachers, of whose names we only know a few. No doubt even in classical times collections of glosses ("glossaries") were compiled, to which allusion seems to be made by Varro (*De ling. Lat.* vii. 10, "tesca, aiunt sancta esse qui *glossas* scripserunt") and Verrius-Festus (166^b. 6, "naucum . . . *glossematorum* . . . scriptores fabae grani quod haec in fabulo"), but it is not known to what extent Varro, for instance, used them, or retained their original forms. The *scriptores glossematorum* were distinguished from the learned glossographers like Aurelius Opilius (cf. his *Musae*, ap. Suet. *De gramm.* 6; Gell. i. 25. 17; Varro vii. 50, 65, 67, 70, 79, 106), Servius Clodius (Varro vii. 70. 106), Aelius Philol., L. Ateius Philol., whose *liber glossematorum* Festus mentions (181^a. 18).

Verrius Flaccus and his epitomists, Festus and Paulus, have preserved many treasures of early glossographers who are now lost to us. He copied Aelius Stilo (Reitzenstein, "Verr. Forsch." in vol. i. of *Breslauer philol. Abhandl.*, p. 88; Kriegshammer, *Comm. phil. Jen.* vii. 1. 74 sqq.). Aurelius Opilius, Ateius Philol., the treatise *De obscuris Calonis* (Reitzenstein, *ib.* 56. 92). He often made use of Varro (Willers, *De Verrio Flacco*, Halle, 1898), though not of his *ling. lat.* (Kriegshammer, 74 sqq.); and was also acquainted with later glossographers. Perhaps we owe to him the *glossae aetioles* (Goetz, *Corpus*, iv. 1. *id.*, *Rhein. Mus.* xl. 328). Festus was used by Pa.-Philoxenus (Dammann, *De Festo Pa.-Philoxeni auctore*, *Comm. Jen.* v. 26 sqq.), as appears from the *glossae ab absens* (Goetz, "De Astrabae Pl. fragmentis," *Ind. Jen.*, 1893, iii. sqq.). The distinct connexions with Nonius need not be ascribed to borrowing, as Plinius and Caper may have been used (P. Schmidt, *De Non. Marc. auct. gramm.* 145; Nettleship, *Lect. and Ess.* 229; Fröhde, *De Non. Marc. et Verrio Flacco*, 2; W. M. Lindsay, "Non. Marc.," *Dict. of Repub. Latin*, 100, &c.).

The bilingual (Gr.-Lat., Lat.-Gr.) glossaries also point to an early period, and were used by the grammarians (1) to explain the peculiarities (*idiomata*) of the Latin language by comparison with the Greek, and (2) for instruction in the two languages (Charia 254. 9, 291. 7, 292. 16 sqq.; Marshall, *De Q. Remmii P. libri gramm.* 22; Goetz, *Corp. gloss. lat.* ii. 6).

For the purposes of grammatical instruction (Greek for the Romans, Latin for the Hellenistic world), we have systematic works, a translation of Dositheus and the so-called *Hermeneutica*, parts of which may be dated as early as the 3rd century A.D. and lexica (cf. Schoenemann, *De lexicis ant.* 122; Knaack, in *Phil. Rundsch.*, 1884, 372. Traube, in *Byzant. Ztschr.* iii. 605; David, *Comment. Jen.* v. 197 sqq.).

The most important remains of bilingual glossaries are two well-known lexica; one (Latin-Greek), formerly attributed (but wrongly, see Rudorff, in *Abh. Akad. Berl.*, 1865, 220 sq.; Loewe, *Prodr.* 183, 190; Mommsen, *C.I.L.* v. 8120; A. Dammann, *De Festo Pseudo-philoxeni auctore*, 12 sqq.; Goetz, *Corp. ii.* 1-212) to Philoxenus (consul A.D. 525), clearly consists of two closely allied glossaries (containing glosses to Latin authors, as Horace, Cicero, Juvenal, Virgil, the jurists, and excerpts from Festus), worked into one by some Greek grammarian, or a person who worked under Greek influence (his alphabet runs A, B, C, D, E, &c.); the other (Greek-Latin) is ascribed to Cyril (Stephanus) and is said to be found at the end of some of his writings, and is considered to be a compilation of not later than the 6th century (Macrobium is used, and the *Cod. Harl.*, which is the source of all the other MSS., belongs to the 7th century); cf. Goetz, *Corp. ii.* 215-483, 487-506, praef. *ibid.* p. xx. sqq. Furthermore, the bilingual medico-botanic glossaries had their origin in old lists of plants, as Pa.-Apuleius in the treatise *De herbarum virtutibus*, and Pa.-Dioscorides (cf. M. Wellmann, *Hermes*, xxxiii. 360 sqq., who thinks that the latter work is based on Pamphilus, q.v.; Goetz, *Corp. iii.*); the glossary, entitled *Hermeneuma*, printed from the *Cod. Vatic.* reg. Christ. 1260, contains names of diseases.

Just as grammar developed, so we see the original form of the glosses extend. If *massacium edacem* in Placidus indicates the original form, the allied gloss of Festus (*massacium edacem a mandando scilicet*) shows an etymological addition. Another extension consists in adding special references to the original source, as e.g. in the gloss *Orum* (Fest. 181^a. 17), which is taken from Ateius Philol. In this way collections arose like the *pristorum verborum cum exemplis*, a title given by Fest. (218^b. 10) to a particular work. Further the *glossae veterum* (Charia. 242. 10); the *glossae antiquitatum* (*id.* 229. 30); the *idomei vocum antiquarum enarratores* (Gell. xviii. 6. 8); the *libri rerum verborumque veterum* (*id.* xiii. 24. 25). L.

¹ See Labbé, *Veteres glossae verborum juris quae passim in Basilicis reperuntur* (1606); Otto, *Thesaurus juris Romani*, iii. (1697); Stephens, *Thesaurus linguae Graecae*, viii. (1825).

² See Blicher, *Geschichte der Novellen*, p. 229 sqq.

³ Imerius himself is with some probability believed to have been the author of the *Brachylogus* (q.v.).

⁴ Thus Fil. Villani (*De origine civitatis Florentiae*, ed. 1847, p. 23), speaking of the Glossator Accursius, says of the Glossae that "tantae auctoritatis gratiaque fuerit, ut omnium consensu publice approbarentur, et reiecta aliis, quibuscumque penitus abolita, solae juxta textum legum adpositae sunt et ubique terrarum sine controversia pro legibus celebrantur, ita ut nefas sit, non secus quam textui, Glossis Accursii contraire." For similar testimonies see Bayle's *Dictionnaire*, s.v. "Accursius," and Rudorff, *Röm. Rechts-geschichte*, i. 338 (1857).

Cicinius, according to Festus (308. 2), wrote *De verbis prisicis*; Santra, *De antiquitate verborum* (Festus 217. 2).

Of Latin glossaries of the first four centuries of the Roman emperors few traces are left, if we except Verrius-Festus. Charis, 229. 30, speaks of *glossae antiquitatum* and 242. 10 of *glossae veterum*, but it is not known whether these glosses are identical, or in what relation they stand to the *glossatae per litteras Latinas ordine composita*, which were incorporated with the works of this grammarian according to the index in Keil, p. 6. Latin glosses occur in Pa.-Philoxenus, and Nonius must have used Latin glossaries; there exists a *glossarium Plautinum* (Ritschl, *Op.* ii. 234 sqq.), and the bilingual glossaries have been used by the later grammarian Martirius; but of this early period we know by name only Fulgentius and Placidius, who is sometimes called Lucatius Placidius, by confusion with the Statius scholiast, with whom the *glossae Placidii* have no connection. All that we know of him tends to show that he lived in North Africa (like Fulgentius and Nonius and perhaps Charisius) in the 6th century, from whence his glosses came to Spain, and were used by Isidore and the compiler of the *Liber glossarum* (see below). These glosses we know from (1) *Codices Romani* (15th and 16th century); (2) the *Liber glossarum*; (3) the *Cod. Paris. nov. acquia*, 1298 (saec. xi.), a collection of glossaries, in which the Placidius-glosses are kept separate from the others, and still retain traces of their original order (cf. the editions published by A. Mai, *Class. auct.* iii. 427-503, and Deuringer, 1875; Goetz, *Corp.* v.; P. Karl, "De Placidii glossis," *Comm. Ien.* vii. 2. 99, 103 sqq.; Loewe, *Gloss. Nom.* 86; F. Böheler, in *Thesaur. gloss. emend.*). His collection includes glosses from Plautus and Lucilius.

(Fabius Planciades) Fulgentius (c. A. D. 468-533) wrote *Expositio sermonum antiquorum* (ed. Rud. Helm, Lips. 1898; cf. Wessner, *Comment. Ien.* vi. 2. 135 sqq.) in sixty-two paragraphs, each containing a lemma (sometimes two or three) with an explanation giving quotations and names of authors. Next to him come the *glossae Nonianae*, which arose from the contents of the various paragraphs in Nonius Marcellus' work being written in the margin without the words of the text: these epitomized glosses were alphabetized and afterwards copied for other collections (see Goetz, *Corp.* v. 637 sqq., *id.* v. Praef. xxv.; Onions and Lindsay, *Harvard Stud.* ix. 67 sqq.; Lindsay, *Notis praef.* xxi.). In a similar way arose the *glossae Eucherii* or *glossae spiritalis secundum Eucherium episcopum* found in many MSS. (cf. K. Wotke, *Sitz. Ber. Akad. Wien*, cxv. 425 sqq.; = the *Corpus Glossary*, first part), which are an alphabetical extract from the *formulae spiritalis intelligentiae* of St Eucherius, bishop of Lyons, c. 434-450.¹

Other sources were the *Differentiae*, already known to Placidius and much used in the medieval glossaries; and the *Synonyma Ciceronis*; cf. Goetz, "Der Liber glossarum," in *Abhandl. der philol.-hist. Cl. der südd. Gesellsch. d. Wiss.*, 1893, p. 215; *id.* in *Beri. philol. Wochenschr.*, 1890, p. 195 sqq.; Beck, in *Wochenschr.*, p. 297 sqq., and Sittl, *ibid.* p. 267; *Archiv f. lat. Lex.* vi. 594; W. L. Mahne, (Leid. 1850, 1851); also various collections of *scholia*. By the side of the *scholia* come the grammarians, as Charisius, or an *ars* similar to that ascribed to him; further, treatises *de dubiis generibus*, the *scriptores orthographici* (especially Capser and Beda), and Priscianus, the chief grammarian of the middle ages (cf. Goetz in *Mitlanges Boissier*, 224).

During the 6th, 7th and 8th centuries glossography developed in various ways; old glossaries were worked up into new forms, or amalgamated with more recent ones. It ceased, moreover, to be exclusively Latin-Latin, and interpretations in Germanic (Old High German, Anglo-Saxon) and Romanic dialects took the place of or were used side by side with earlier Latin ones. The origin and development of the late classic and medieval glossaries preserved

¹ The so-called *Malberg glosses*, found in various texts of the *Lex Salica*, are not glosses in the ordinary sense of the word, but precious remains of the parent of the present literary Dutch, namely, the Low German dialect spoken by the Salian Franks who conquered Gaul from the Romans at the end of the 5th century. It is supposed that the conquerors brought their Frankish law with them, either written down, or by oral tradition; that they translated it into Latin for the sake of the Romans settled in the country, and that the translators, not always knowing a proper Latin equivalent for certain things or actions, retained in their translations the Frankish technical names or phrases which they had attempted to translate into Latin. S. J. in chapter ii., by the side of "porcellus lactans" (a sucking-pig), we find the Frankish "chwammekallio," lit. a sty-porker. The person who stole such a pig (still kept in an enclosed place, in a sty) was fined three times as much as one who stole a "porcellus de campo qui sine matre vivere possit," as the Latin text has it, for which the Malberg technical expression appears to have been *ingemus*, that is, a one year (winter) old animal, i.e. a yearling. Nearly all these glosses are preceded by "mal" or "malb," which is thought to be a contraction for "malberg," the Frankish for "forum." The antiquity and importance of these glosses for philology may be realized from the fact that the Latin translation of the *Lex Salica* probably dates from the latter end of the 5th century. For further information cf. Jac. Grimm's preface to Job. Merkel's ed. (1850), and H. Kern's notes to J. H. Hessels's ed. (London, 1880) of the *Lex Salica*.

to us can be traced with certainty. While reading the manuscript texts of classical authors, the Bible or early Christian and profane writers, students and teachers, on meeting with any obscure or out-of-the-way words which they considered difficult to remember or to require elucidation, wrote above them, or in the margins, interpretations or explanations in more easy or better-known words. The interpretations written above the line are called "interlinear," those written in the margins of the MSS. "marginal glosses." Again, MSS. of the Bible or portions of the Bible were often provided with literal translations in the vernacular written above the lines of the Latin version (interlinear versions).

Of such glossed MSS. or translated texts, photographs may be seen in the various palaeographical works published in recent years; cf. *The Palaeogr. Society*, 1st ser. vol. ii. pls. 9 (Terentius MS. of 4th or 5th century, interlinear glosses) and 24 (Augustine's epistles, 6th or 7th century, marginal glosses); see further, plates 10, 12, 33, 40, 50-54, 57, 58, 63, 73, 75, 80; vol. iii. plates 10, 24, 31, 39, 44, 54, 80.

From these glossed or annotated MSS. and interlinear versions glossaries were compiled; that is, the obscure and difficult Latin words, together with the interpretations, were excerpted and collected in separate lists, in the order in which they appeared, one after the other, in the MSS., without any alphabetical arrangement, but with the names of the authors or the titles of the books whence they were taken, placed at the head of each separate collection or chapter. In this arrangement each article by itself is called a *gloss*; when reference is made only to the word explained it is called the *lemma*, while the explanation is termed the *interpretamentum*. In most cases the form of the lemma was retained just as it stood in its source, and explained by a single word (*lesca*: *sancio*, Varro vii. 10; *clucudius*: *suavis*, *id.* vii. 107; cf. *Isid. Etym.* 1. 30. 1, "quid enim illud sit in uno verbo positum declarat [*sic glossa*] ut conticescere est tacere"), so that we meet with lemmata in the accusative, dative and genitive, likewise explained by words in the same cases; the forms of verbs being treated in the same way. Of this first stage in the making of glossaries, many traces are preserved, for instance, in the late 8th century Leiden Glossary (Voss, 69, ed. J. H. Hessels), where chapter iii. contains words or glosses excerpted from the *Life of St Martin* by Sulpicius Severus; chs. iv., v. and xxv. glosses from Rufinus; chs. vi. and xl. from Gildas; chs. vii. to xxv. from books of the Bible (Paralipomenon; Proverbs, &c., &c.); chs. xxvi. to xlvi. from Isidore, the *Vita S. Anthonii*, Cassiodorus, St Jerome, Cassianus, Orosius, St Augustine, St Clement, Eucherius, St Gregory, the grammarians Donatus, Phocas, &c. (See also Goetz, *Corp.* v. 546, 23-547. 6, and i. 5-40 from Ovid's *Metam.*; v. 657 from Apuleius, *De deo Socratis*; cf. Landgraf, in *Arch.* ix. 174).

By a second operation the glosses came to be arranged in alphabetical order according to the first letter of the lemma, but still retained in separate chapters under the names of authors or the titles of books. Of this second stage the Leiden Glossary contains traces also: ch. i. (*Verba de Canonibus*) and ii. (*Sermones de Regibus*); see Goetz, *Corp.* v. 529 sqq. (from Terentius), iv. 427 sqq. (Virgil).

The third operation collected all the accessible glosses in alphabetical order, in the first instance according to the first letters of the lemmata. In this arrangement the names of the authors or the titles of the books could no longer be preserved, and consequently the sources whence the glosses were excerpted became uncertain, especially if the grammatical forms of the lemmata had been normalized.

A fourth arrangement collected the glosses according to the first two letters of the lemmata, as in the *Corpus Glossary* and in the still earlier *Cod. Vat.* 3321 (Goetz, *Corp.* iv. 1 sqq.), where even many attempts were made to arrange them according to the first three letters of the alphabet. A peculiar arrangement is seen in the *Glossae affinium* (Goetz, *Corp.* iv. 471 sqq.), where all words are alphabetized, first according to the initial letter of the word (a, b, c, &c.), and then further according to the first *sonus* in the word (a, e, i, o, u).

No date or period can be assigned to any of the above stages or arrangements. For instance, the first and second are both found in the Leiden Glossary, which dates from the end of the 8th century, whereas the *Corpus Glossary*, written in the beginning of the same century, represents already the fourth stage.

For the purpose of identification titles have of late years been given to the various nameless collections of glosses, derived partly from their first lemma, partly from other characteristics, as *glossae abstrusae*; *glossae abbas major* and *minor*; *g. affinium*; *g. ab abens*; *g. abactor*; *g. Abbas Pater*; *g. a, a, g.*; *g. Vergilianae*; *g. nominum* (Goetz, *Corp.* ii. 593, iv.); *g. Songalenses* (Warren, *Transact. Amer. Philol. Assoc.* xv. 1883, p. 141 sqq.).

A chief landmark in glossography is represented by the *Origines* (*Etymologiae*) of Isidore (d. 646), an encyclopaedia in which he, like Cassiodorus, mixed human and divine subjects together. In many places we can trace his sources, but he also used glossaries. His work became a great mine for later glossographers. In the tenth book he deals with the etymology of many substantives and adjectives arranged alphabetically according to the first letter of the words, perhaps by himself from various sources. His principal source is Servius, then the fathers of the Church (Augustine, Jerome,

Lactantius) and Donatus the grammarian. This tenth book was also copied and used separately, and mixed up with other works (cf. Loewe, *Prodr.* 167. 21). Isidore's *Differentias* have also had a great reputation.

Next comes the *Liber glossarum*, chiefly compiled from Isidore, but all articles arranged alphabetically; its author lived in Spain c. A.D. 690-750; he has been called Anselmeus, but not in any of the MSS., some of which belong to the 8th century; hence this name is suspected to be merely that of some owner of a copy of the book (cf. Goetz, "Der Liber Glossarum," in *Abhandl. der philol.-hist. Class. der kôn. sächs. Ges.* xiii., 1893; *id.*, *Corp.* v., praef. xx. 161).

Here come, in regard to time, some Latin glossaries already largely mixed with Germanic, more especially Anglo-Saxon interpretations: (1) the Corpus Glossary (ed. J. H. Heesels), written in the beginning of the 8th century, preserved in the library of Corpus Christi College, Cambridge; (2) the Leiden Glossary (end of 8th century, ed. Heesels; another edition by Plac. Glogger), preserved in the Leiden MS. Voss. Qⁿ. 69; (3) the Epinal Glossary, written in the beginning of the 9th century and published in facsimile by the London Philol. Society from a MS. in the town library at Epinal; (4) the *Glossae Amphimoniae*, i.e. three glossaries preserved in the Anopolian library at Erfurt, known as Erfurt¹, Erfurt² and Erfurt³. The first, published by Goetz (*Corp.* v., 337-401; cf. also Loewe, *Prodr.* 114 sqq.) with the various readings of the kindred Epinal, consists, like the latter, of different collections of glosses (also some from Althelm), some arranged alphabetically according to the first letter of the lemma, others according to the first two letters. The title of Erfurt¹ (*incipit II. conscriptio glossarum in unam*) shows that it is also a combination of various glossaries; it is arranged alphabetically according to the first two letters of the lemmata, and contains the *affatus* and *obovus unius glossae*, also a collection from Althelm, Erfurt³ are the *Glossae nemisium*, mixed also with Anglo-Saxon interpretations (Goetz, *Corp.* ii. 563). The form in which the three Erfurt glossaries have come down to us points back to the 8th century.

The first great glossary or collection of various glosses and glossaries is that of Salomon, bishop of Constance, formerly abbot of St. Gall, who died A.D. 919. An edition of it in two parts was printed c. 1475 at Augsburg, with the headline *Salomonis ecclesie Constantiensis episcopi glossae ex illustrissimis collectae auctoribus*. The oldest MSS. of this work date from the 11th century. Its sources are the *Liber glossarum* (Loewe, *Prodr.* 234 sqq.), the glossary preserved in the 9th-century MS. *Lat. Monac.* 14429 (Goetz, "Lib. Gloss." 35 sqq.), and the great Athavus Gloss (*id.*, *ibid.* p. 37, *id.*, *Corp.* iv. praef. xxvii.).

The *Lib. glossarum* has also been the chief source for the important (but not original) glossary of Papias, of A.D. 1033 (cf. Goetz in *Sitzb. Ber. Akad. Münch.*, 1903, p. 267 sqq., who enumerates eighty-seven MSS. of the 12th to the 15th centuries), of whom we only know that he lived among clerics and dedicated his work to his two sons. An edition of it was published at Milan "per Dominicum de Vespolate" on the 12th of December 1476; other editions followed in 1485, 1491, 1496 (at Venice). He also wrote a grammar, chiefly compiled from Priscianus (Hagen, *Anekd. Hebr.* clxxx. sqq.).

The same *Lib. gloss.* is the source (1) for the *Abba Pater Glossary* (cf. Goetz, *ibid.* p. 39), published by G. M. Thomas (*Sitzb. Ber. Akad. Münch.*, 1868, li. 369 sqq.); (2) the Greek glossary *Abrida Isida* (Goetz, *ib.* p. 41); and (3) the Lat.-Arab. glossary in the *Cod. Leid. Scal. Orient.* No. 231 (published by Seybold in *Semit. Studien*, Heft xv.-xviii., Berlin, 1900).

The Paulus-Glossary (cf. Goetz, "Der Liber Glossarum," p. 215) is compiled from the second Salomon-Glossary (*abacti magistratus*), the *Abvavus major* and the *Liber glossarum*, with a mixture of Hebraica. Many of his glosses appear again in other compilations, as in the *Cod. Vatic.* 1466 (cf. Goetz, *Corp.* v. 520 sqq.), mixed up with glosses from Beda, Placidus, &c. (cf. a glossary published by Ellis in *Amer. Journ. of Philol.* vi., p. vii. 3, containing besides Paulus glosses, also excerpts from Isidore; Cambridge *Journ. of Philol.* viii. 71 sqq., xiv. 81 sqq.).

Osbern of Gloucester (c. 1123-1200) compiled the glossary entitled *Panormia* (published by Angelo Mai as *Thesaurus novus Latinitatis*, from *Cod. Vatic. reg. Christ.* 1392; cf. *Weyher, Rhein. Mus.* xix., 1873; Goetz in *Sitzungsber. sächs. Ges. d. Wiss.*, 1903, p. 133 sqq.; *Berichte üb. die Verhandl. der kôn. sächs. Gesellsch. der Wiss.*, Leipzig, 1902); giving derivations, etymologies, testimonia collected from Paulus, Priscianus, Plautus, Horace, Virgil, Ovid, Mart. Capella, Macrobius, Ambrose, Sidoianus, Prudentius, Josephus, Jerome, &c., &c. Osbern's material was also used by Hugucio, whose compendium was still more extensively used (cf. Goetz, *l.c.*, p. 121 sqq., who enumerates one hundred and three MSS. of his treatise), and contains many biblical glosses, especially Hebraica, some treatises on Latin numerals, &c. (cf. Hamann, *Weitere Mittheil. aus dem Breivogelns Benkenhansens*, Hamburg, 1882; A. Thomas, "Glosses provençales inféd." in *Romania*, xxxiv. p. 177 sqq.; P. Toynbee, *ibid.* xxv. p. 337 sqq.).

The great work of Johannes de Janua, entitled *Summa quas vocatur catholicon*, dates from the year 1286, and treats of (1) accent, (2) etymology, (3) syntax, and (4) so-called prosody, i.e. a lexicon,

which also deals with quantity. It mostly uses Hugucio and Papias; its classical quotations are limited, except from Horace; it quotes the Vulgate by preference, frequently independently from Hugucio; it excerpts Priscianus, Donatus, Isidore, the fathers of the Church, especially Jerome, Gregory, Augustine, Ambrose; it borrows many Hebrew glosses, mostly from Jerome and the other collections then in use; it mentions the *Græcismos* of Eberhardus Bethuniensis, the works of Hrabanus Maurus, the *Doctrinale* of Alexander de Villa Dei, and the *Arvera* of Petrus de Riga. Many quotations from the *Catholicon* in Du Cange are really from Hugucio, and may be traced to Osbern. There exist many MSS. of this work, and the Mainz edition of 1460 is well known (cf. Goetz in *Berichte üb. die Verhandl. der kôn. sächs. Gesellsch. der Wiss.*, Leipzig, 1902).

The gloss MSS. of the 9th and 10th centuries are numerous, but a diminution becomes visible towards the 11th. We then find grammatical treatises arise, for which also glossaries were used. The chief material was (1) the *Liber glossarum*; (2) the Paulus glosses; (3) the *Abvavus major*; (4) excerpts from Priscian and glosses to Priscian; (5) Hebrew-biblical collections of proper names (chiefly from Jerome). After these comes medieval material, as the *derivaciones* which are found in many MSS. (cf. Goetz in *Sitzungsber. sächs. Ges. d. Wiss.*, 1903, p. 136 sqq.; Traube in *Archiv f. lat. Lex.* vi. 264), containing quotations from Plautus, Ovid, Juvenal, Persius, Terence, occasionally from Priscian, Eutycheus, and other grammarians, with etymological explanations. These *derivaciones* were the basis for the grammatical works of Osbern, Hugucio and Joannes de Janua.

A peculiar feature of the late middle ages are the medico-botanic glossaries based on the earlier ones (see Goetz, *Corp.* iii.). The additions consisted in Arabic words with Latin explanations, while Greek, Latin, Hebrew and Arabic, interchange with English, French, Italian and German forms. Of glossaries of this kind we have (1) the *Glossae alpinae* (published by S. de Renzi in the 2d vol. of the *Collect. Salernitana*, Naples, 1844, from two Paris MSS. of the 14th and 15th centuries, but some of the glosses occur already in earlier MSS.); (2) *Sinomoms Bartholomei*, collected by John Mirfield, towards the end of the 14th century, ed. J. L. G. Mowat (*Anekd. Oxon.* i. 1, 1882, cf. Loewe, *Gloss. Nov.* 116 sqq.); it seems to have used the same or some similar source as No. 1; (3) the compilations of Simon de Janua (*Clavis sanatorum*, end of 13th century), and of Matthaeus Silvaticus (*Pandectae medicinae*, 14th century; cf. H. Stadler, "Diacor. Longob." in *Roman. Forsch.* x. 3-371; Steinmeyer, *Althedd. Gloss.* iii.).

Of biblical glossaries we have a large number, mostly mixed with glosses on other, even profane, subjects, as Hebrew and other biblical proper names, and explanations of the text of the Vulgate in general, and the prologues of Hieronymus. So we have the *Glossae veteris ac novi testamenti* (beginning "Prologus graece latine praelectio sine praefatio") in numerous MSS. of the 9th to 14th centuries, mostly retaining the various books under separate headings (cf. Arevalo, *ibid.* vii. 407 sqq.; Loewe, *Prodr.* 141; Steinmeyer iv. 459; S. Berger, *De compendiosis exegeticis quibusdam mediis aevi*, Paris, 1879). Special mention should be made of Guil. Brito, who lived about 1250, and compiled a *Summa* (beginning "difficiles studeo partes quas Biblia gestat Fandere"), contained in many MSS. especially in French libraries. This *Summa* gave rise to the *Mammothtractus* of Joh. Marchesinus, about 1300, of which we have editions printed in 1470, 1476, 1479, &c.

Finally we may mention such compilations as the *Summa Heinrici*; the work of Johannes de Garlandia, which he himself calls *dictionarius* (cf. Scheler in *Jahrb. f. rom. u. engl. Philol.* vi., 1865, p. 142 sqq.); and that of Alexander Neckam (ib. vii. p. 60 sqq.), cf. R. Ellis, in *Amer. Journ. of Phil.* x. 2; which are, strictly speaking, not glossographic. The *Brevilogus* drew its chief material from Papias, Hugucio, Brito, &c. (K. Hamann, *Mittheil. aus dem Brevilogus Benkenhansens*, Hamburg, 1879; *id.*, *Weitere Mittheil.*, &c., Hamburg, 1882); so also the *Vocabularium Ex quo*; the various *Gemmas*; *Vocabularia rerum* (cf. Dieffenbach, *Glossar. Latino-Germanicum*).

After the revival of learning, J. Scaliger (1540-1609) was the first to impart to glossaries that importance which they deserve (cf. Goetz, in *Sitzungsber. sächs. Ges. d. Wiss.*, 1888, p. 219 sqq.), and in his edition of Festus made great use of Pa-Philoxenus, which enabled O. Müller, the later editor of Festus, to follow in his footsteps. Scaliger also planned the publication of a *Corpus glossarum*, and left behind a collection of glosses known as *glossae Isidori* (Goetz, *Corp.* v. p. 589 sqq.; *id.* in *Sitzungsber. sächs. Ges.*, 1888, p. 224 sqq.; Loewe, *Prodr.* 23 sqq.), which occurs also in old glossaries, clearly in reference to the tenth book of the *Etymologiae*.

The study of glosses spread through the publication, in 1573, of the bilingual glossaries by H. Stephanus (Estienne), containing, besides the two great glossaries, also the *Hermeneumata Stephani*, which is a recension of the *Pz-Dositheana* (republished Goetz, *Corp.* iii. 438-474), and the *glossae Stephani*, excerpted from a collection of the *Hermeneumata* (*ib.* iii. 438-474).

In 1600 Bonav. Vulcanius republished the same glossaries, adding (1) the glossae *Isidori*, which now appeared for the first time; (2) the *Onomasticum*; (3) *notae* and *castigationes*, derived from Scaliger (Loewe, *Prodr.* 183).

In 1606 Carolus and Petrus Labbaeus published, with the effective help of Scaliger, another collection of glossaries, republished, in 1679, by Du Cange, after which the 17th and 18th centuries produced no

¹ Anglo-Saxon scholars ascribe an earlier date to the text of the MS. on account of certain archaisms in its Anglo-Saxon words.

further glossaries (Erasm. Nyerap published extracts from the Leiden Glossary, Voss. 69, in 1787, *Symbolae ad Literat. Test.*), though glosses were constantly used or referred to by Salmasius, Meursius, Heraldus, Barth, Fabricius and Burman at Leiden, where a rich collection of glossaries had been obtained by the acquisition of the Vossius library (cf. Loewe, *Prodr.* 168). In the 19th century came Osann's *Glossarii Latini specimen* (1826); the glossographic publications of Angelo Mai (*Classici auctores*, vols. iii., vi., vii., viii., Rome, 1831-1836, containing Osborn's *Panormia*, Placidus and various glosses from Vatican MSS.); Fr. Oehler's treatise (1847) on the *Cod. Amptonianus* of Osborn, and his edition of the three Erfurt glossaries, so important for Anglo-Saxon philology; in 1854 G. F. Hildebrand's *Glossarium Latinum* (an extract from *Abovian minor*), preserved in a Cod. Paris. lat. 7690; 1857, Thomas Wright's vol. of Anglo-Saxon glosses, which were republished with others in 1884 by R. Paul Wülcker under the title *Anglo-Saxon and Old English Vocabularies* (London, 2 vols., 1857); L. Diefenbach's supplement to Du Cange, entitled *Glossarium Latino-Germanicum mediae et infimae aetatis*, containing mostly glosses collected from glossaries, vocabularies, &c., enumerated in the preface; Ritachl's treatise (1870) on Placidus, which called forth an edition (1875) of Placidus by Dueringling; G. Loewe's *Prodromus* (1876), and other treatises by him, published after his death by G. Goetz (Leipzig, 1884); 1888, the second volume of Goetz's own great *Corpus glossariorum Latinorum*, of which seven volumes (except the first) had seen the light by 1907, the last two being separately entitled *Thesaurus glossariorum emendatarum*, containing many emendations and corrections of earlier glossaries by the author and other scholars; 1900, Arthur S. Napier, *Old English Glosses* (Oxford), collected chiefly from Althelm MSS., but also from Augustine, Avianus, Bede, Boethius, Gregory, Isidore, Juvenius, Phocas, Prudentius, &c.

There are a very great number of glossaries still in MS. scattered in various libraries of Europe, especially in the Vatican, at Monte Cassino, Paris, Munich, Bern, the British Museum, Leiden, Oxford, Cambridge, &c. Much has already been done to make the material contained in these MSS. accessible in print, and much may yet be done with what is still unpublished, though we may find that the differences between the glossaries which often present themselves at first sight are mere differences in form introduced by successive more or less qualified copyists.

Some Celtic (Breton, Cornish, Welsh, Irish) glossaries have been preserved to us, the particulars of which may be learnt from the publications of Whitley Stokes, Sir John Rhys, Kuno Meyer, L. C. Stern, G. I. Ascoli, Heinrich Zimmer, Ernst Windisch, Nigra, and many others; these are published separately as books or in *Zeitschrift für Celtische Philologie*, *Archiv für Celtische Linguistik*, *Zeitschrift für Celtische Philologie*, *Archiv für Celtische Linguistik*, *Zeitschrift für Celtische Philologie*, *Archiv für Celtische Linguistik*, &c.

The first Hebrew author known to have used glosses was R. Gershom of Metz (1000) in his commentaries on the Talmud. But he and other Hebrew writers after him mostly used the Old French language (though sometimes also Italian, Slavonic, German) of which an example has been published by Lambert and Brandin, in their *Glossaire hébreu-français du XIII^e siècle: recueil de mots hébreux bibliques avec traduction française* (Paris, 1905). See further *The Jewish Encyclopedia* (New York and London, 1903), article "Gloss."

AUTHORITIES.—For a great part of what has been said above, the writer is indebted to G. Goetz's article on "Latein. Glossographie" in Pauly's *Realencyclopädie*. By the side of Goetz's *Corpus* stands the great collection of Steinmeyer and Sievers, *Die althochdeutschen Glossen* (in 4 vols., 1879-1898), containing a vast number of (also Anglo-Saxon) glosses culled from Bible MSS. and MSS. of classical Christian authors, enumerated and described in the 4th vol. Besides the works of the editors of, or writers on, glosses, already mentioned, we refer here to a few others, whose writings may be consulted: Hugo Blümner; *Catholicum Anglicum* (ed. Hertage); De-Vit (at end of Forcellini's *Lexicon*); F. Deycks; Du Cange; Funck; J. H. Gallée (*Altsächs. Sprachdenkm.*, 1894); Gröber; K. Gruber (*Hauptquellen des Corpus. Bdin. u. Erfurt Gloss.*, Erlangen, 1904); Hattemer, W. Heraeus (*Die Sprache des Petronius und die Glossen*, Leipzig, 1899); Kettner; Kluge; Krumbacher; Lagarde; Landgraf; Marx; W. Meyer-Lubke ("Zu den latein. Glossen" in *Wiener Stud.* xxv. 90 sqq.); Henry Nettleship; Niedermann, *Notes d'étymol. lat.* (Macon, 1902), *Contribut. à la critique des glosses latines* (Neuchâtel, 1905); Pokrowskij; Quicherat; Otto B. Schlutter (many important articles in *Anglia, Englische Studien, Archiv f. lat. Lexicographie*, &c.); Schöll; Schuchardt; Leo Sommer; Stadler; Stowasser; Strachan; H. Sweet; Usener (*Rhein. Mus.* xxiii. 496, xxiv. 382); A. Way, *Promptorium parvulorum sive clericorum* (3 vols., London, 1843-1865); Weyman, Wilmanns (in *Rhein. Mus.* xxiv. 363); Wölfflin in *Arch. für lat. Lexicogr.*; Zupitza. Cf. further, the various volumes of the following periodicals: *Romania; Zeitschr. für deutsches Alterthum; Anglia; Englische Studien; Journal of English and German Philology* (ed. Cook and Karsten); *Archiv für lat. Lexicogr.*, and others treating of philology, lexicography, grammar, &c. (J. H. H.)

GLOSSOP, a market town and municipal borough, in the High Peak parliamentary division of Derbyshire, England, on the extreme northern border of the county; 13 m. E. by S. of

Manchester by the Great Central railway. Pop. (1901) 21,526. It is the chief seat of the cotton manufacture in Derbyshire, and it has also woollen and paper mills, dye and print works, and bleaching greens. The town consists of three main divisions, the Old Town (or Glossop proper), Howard Town (or Glossop Dale) and Mill Town. An older parish church was replaced by that of All Saints in 1830; there is also a very fine Roman Catholic church. In the immediate neighbourhood is Glossop Hall, the seat of Lord Howard, lord of the manor, a picturesque old building with extensive terraced gardens. On a hill near the town is Melandra Castle, the site of a Roman fort guarding Longendale and the way into the hills of the Peak District. In the neighbourhood also a great railway viaduct spans the Dinting valley with sixteen arches. To the north, in Longendale, there are five lakes belonging to the water-supply system of Manchester, formed by damming the Etherow, a stream which descends from the high moors north-east of Glossop. The town is governed by a mayor, 6 aldermen and 18 councillors. Area, 3052 acres.

Glossop was granted by Henry I. to William Peverel, on the attainder of whose son it reverted to the crown. In 1157 it was gifted by Henry II. to the abbey of Basingwerk. Henry VIII. bestowed it on the earl of Shrewsbury. It was made a municipal borough in 1866.

GLOUCESTER, EARLS AND DUKES OF. The English earldom of Gloucester was held by several members of the royal family, including Robert, a natural son of Henry I., and John, afterwards king, and others, until 1218, when Gilbert de Clare was recognized as earl of Gloucester. It remained in the family of Clare (q.v.) until 1314, when another Earl Gilbert was killed at Bannockburn; and after this date it was claimed by various relatives of the Clares, among them by the younger Hugh le Despenser (d. 1326) and by Hugh Audley (d. 1347), both of whom had married sisters of Earl Gilbert. In 1307 Thomas le Despenser (1373-1400), a descendant of the Clares, was created earl of Gloucester; but in 1399 he was degraded from his earldom and in January 1400 was beheaded.

The dukedom dates from 1385, when Thomas of Woodstock, a younger son of Edward III., was created duke of Gloucester, but his honours were forfeited when he was found guilty of treason in 1397. The next holder of the title was Humphrey, a son of Henry IV., who was created duke of Gloucester in 1414. He died without sons in 1447, and in 1461 the title was revived in favour of Richard, brother of Edward IV., who became king as Richard III. in 1483.

In 1659 Henry (1639-1660), a brother of Charles II., was formally created duke of Gloucester, a title which he had borne since infancy. This prince, sharing the exile of the Stuarts, had incensed his mother, Queen Henrietta Maria, by his firm adherence to the Protestant religion, and had fought among the Spaniards at Dunkirk in 1658. Having returned to England with Charles II., he died unmarried in London on the 13th of September 1660. The next duke was William (1689-1700), son of the princess Anne, who was, after his mother, the heir to the English throne, and who was declared duke of Gloucester by his uncle, William III., in 1689, but no patent for this creation was ever passed. William died on the 30th of July 1700, and again the title became extinct.

Frederick Louis, the eldest son of George II., was known for some time as duke of Gloucester, but when he was raised to the peerage in 1726 it was as duke of Edinburgh only. In 1764 Frederick's third son, William Henry (1743-1805), was created duke of Gloucester and Edinburgh by his brother, George III. This duke's secret marriage with Maria (d. 1807), an illegitimate daughter of Sir Edward Walpole and widow of James, 2nd Earl Waldegrave, in 1766, greatly incensed his royal relatives and led to his banishment from court. Gloucester died on the 25th of August 1805, leaving an only son, William Frederick (1776-1834), who now became duke of Gloucester and Edinburgh. The duke, who served with the British army in Flanders, married his cousin Mary (1776-1857), a daughter of George III. He died on the 30th of November 1834, leaving no children, and his

widow, the last survivor of the family of George III., died on the 30th of April 1857.

GLOUCESTER, GILBERT DE CLARE, EARL OF (1243-1295), was a son of Richard de Clare, 7th earl of Gloucester and 8th earl of Clare, and was born at Christchurch, Hampshire, on the 2nd of September 1243. Having married Alice of Angoulême, half-sister of king Henry III., he became earl of Gloucester and Clare on his father's death in July 1262, and almost at once joined the baronial party led by Simon de Montfort, earl of Leicester. With Simon Gloucester was at the battle of Lewes in May 1264, when the king himself surrendered to him, and after this victory he was one of the three persons selected to nominate a council. Soon, however, he quarrelled with Leicester. Leaving London for his lands on the Welsh border he met Prince Edward, afterwards king Edward I., at Ludlow, just after his escape from captivity, and by his skill contributed largely to the prince's victory at Evesham in August 1265. But this alliance was as transitory as the one with Leicester. Gloucester took up the cudgels on behalf of the barons who had surrendered at Kenilworth in November and December 1266, and after putting his demands before the king, secured possession of London. This happened in April 1267, but the earl quickly made his peace with Henry III. and with Prince Edward; and, having evaded an obligation to go on the Crusade, he helped to secure the peaceful accession of Edward I. to the throne in 1272. Gloucester then passed several years in fighting in Wales, or on the Welsh border; in 1289 when the barons were asked for a subsidy he replied on their behalf that they would grant nothing until they saw the king in person (*visi prius personaliter videtur in Anglia faciem regis*), and in 1291 he was fined and imprisoned on account of his violent quarrel with Humphrey de Bohun, earl of Hereford. Having divorced his wife Alice, he married in 1290 Edward's daughter Joan, or Johanna (d. 1307). Earl Gilbert, who is sometimes called the "Red," died at Monmouth on the 7th of December 1295, leaving in addition to three daughters a son, Gilbert, earl of Gloucester and Clare, who was killed at Bannockburn.

See C. Bémont, *Simon de Montfort, comte de Leicester* (1884), and G. W. Prothero, *Simon de Montfort* (1877).

GLOUCESTER, HUMPHREY, DUKE OF (1301-1447), fourth son of Henry IV. by Mary de Bohun, was born in 1301. He was knighted at his father's coronation on the 11th of October 1309, and created duke of Gloucester by Henry V at Leicester on the 16th of May 1414. He served in the war next year, and was wounded at Agincourt, where he owed his life to his brother's valour. In April 1416 Humphrey received the emperor Sigismund at Dover and, according to a 16th-century story, did not let him land till he had disclaimed all title to imperial authority in England. In the second invasion of France Humphrey commanded the force which during 1418 reduced the Cotentin and captured Cherbourg. Afterwards he joined the main army before Rouen, and took part in subsequent campaigns till January 1420. He then went home to replace Bedford as regent in England, and held office till Henry's own return in February 1421. He was again regent for his brother from May to September 1422.

Henry V. measured Humphrey's capacity, and by his will named him merely deputy for Bedford in England. Humphrey at once claimed the full position of regent, but the parliament and council allowed him only the title of protector during Bedford's absence, with limited powers. His lack of discretion soon justified this caution. In the autumn of 1422 he married Jacqueline of Bavaria, heiress of Holland, to whose lands Philip of Burgundy had claims. Bedford, in the interest of so important an ally, endeavoured vainly to restrain his brother. Finally in October 1424 Humphrey took up arms in his wife's behalf, but after a short campaign in Hainault went home, and left Jacqueline to be overwhelmed by Burgundy. Returning to England in April 1425 he soon entangled himself in a quarrel with the council and his uncle Henry Beaufort, and stirred up a tumult in London. Open war was averted only by Beaufort's prudence, and Bedford's hurried return. Humphrey

had charged his uncle with disloyalty to the late and present kings. With some difficulty Bedford effected a formal reconciliation at Leicester in March 1426, and forced Humphrey to accept Beaufort's disavowal. When Bedford left England next year Humphrey renewed his intrigues. But one complication was removed by the annulling in 1428 of his marriage with Jacqueline. His open adultery with his mistress, Eleanor Cobham, also made him unpopular. To check his indiscretion the council, in November 1429, had the king crowned, and so put an end to Humphrey's protectorate. However, when Henry VI. was soon afterwards taken to be crowned in France, Humphrey was made lieutenant and warden of the kingdom, and thus ruled England for nearly two years. His jealousy of Bedford and Beaufort still continued, and when the former died in 1435 there was no one to whom he would defer. The defection of Burgundy roused English feeling, and Humphrey won popularity as leader of the war party. In 1436 he commanded in a short invasion of Flanders. But he had no real power, and his political importance lay in his persistent opposition to Beaufort and the councillors of his party. In 1439 he renewed his charges against his uncle without effect. His position was further damaged by his connexion with Eleanor Cobham, whom he had now married. In 1441 Eleanor was charged with practising sorcery against the king, and Humphrey had to submit to see her condemned, and her accomplices executed. Nevertheless, he continued his political opposition, and endeavoured to thwart Suffolk, who was now taking Beaufort's place in the council, by opposing the king's marriage to Margaret of Anjou. Under Suffolk's influence Henry VI. grew to distrust his uncle altogether. The crisis came in the parliament of Bury St Edmunds in February 1447. Immediately on his arrival there Humphrey was arrested, and four days later, on the 23rd of February, he died. Rumour attributed his death to foul play. But his health had been long undermined by excesses, and his end was probably only hastened by the shock of his arrest.

Humphrey was buried at St Albans Abbey, in a fine tomb, which still exists. He was ambitious and self-seeking, but unstable and unprincipled, and, lacking the fine qualities of his brothers, excelled neither in war nor in peace. Still he was a cultured and courtly prince, who could win popularity. He was long remembered as the good Duke Humphrey, and in his lifetime was a liberal patron of letters. He had been a great collector of books, many of which he presented to the university of Oxford. He contributed also to the building of the Divinity School, and of the room still called Duke Humphrey's library. His books were dispersed at the Reformation and only three volumes of his donation now remain in the Bodleian library. Titus Livius, an Italian in Humphrey's service, wrote a life of Henry V. at his patron's bidding. Other Italian scholars, as Leonardo Aretino, benefited by his patronage. Amongst English men of letters he befriended Reginald Pecock, Whet- hamstead of St Albans, Caggrave the historian, Lydgate, and Gilbert Kymer, who was his physician and chancellor of Oxford university. A popular error found Humphrey a fictitious tomb in St Paul's Cathedral. The adjoining aisle, called Duke Humphrey's Walk, was frequented by beggars and needy adventurers. Hence the 16th-century proverb "to dine with Duke Humphrey," used of those who loitered there dinnerless.

The most important contemporary sources are Stevenson's *Wars of the English in France*, Whet- hamstead's *Register*, and Beckington's *Letters* (all in Rolls Ser.), with the various *London Chronicles*, and the works of Waurin and Monstrelet. For his relations with Jacqueline see F. von Löhner's *Jacoba von Bayern und ihre Zeit* (2 vols., Nördlingen, 1869). For other modern authorities consult W. Stubbs's *Constitutional History*; J. H. Ramsay's *Lancaster and York: Political History of England*, vol. iv.; R. Fauli, *Pictures of Old England*, pp. 373-401 (1861); and K. H. Vickers, *Humphrey, Duke of Gloucester* (1907). For Humphrey's correspondence with Piero Candido Decembrio see the *English Historical Review*, vols. x., xix., xx. (C. L. K.).

GLOUCESTER, RICHARD DE CLARE, EARL OF (1222-1262), was a son of Gilbert de Clare, 6th earl of Gloucester and 7th earl of Clare, and was born on the 4th of August 1222, succeeding

to his father's earldoms on the death of the latter in October 1230. His first wife was Margaret, daughter of Hubert de Burgh, and after her death in 1237 he married Maud, daughter of John de Lacy, earl of Lincoln, and passed his early years in tournaments and pilgrimages, taking for a time a secondary and undecided part in politics. He refused to help Henry III. on the French expedition of 1250, but was afterwards with the king at Paris, then he went on a diplomatic errand to Scotland, and was sent to Germany to work among the princes for the election of his stepfather, Richard, earl of Cornwall, as king of the Romans. About 1258 Gloucester took up his position as a leader of the barons in their resistance to the king, and he was prominent during the proceedings which followed the Mad Parliament at Oxford in 1258. In 1259, however, he quarrelled with Simon de Montfort, earl of Leicester; the dispute, begun in England, was renewed in France and he was again in the confidence and company of the king. This attitude, too, was only temporary, and in 1261 Gloucester and Leicester were again working in concord. The earl died at his residence near Canterbury on the 15th of July 1262. A large landholder like his son and successor, Gilbert, Gloucester was the most powerful English baron of his time; he was avaricious and extravagant, but educated and able. He left several children in addition to Earl Gilbert.

GLOUCESTER, ROBERT, EARL OF (d. 1147), was a natural son of Henry I. of England. He was born, before his father's accession, at Caen in Normandy; but the exact date of his birth, and his mother's name are unknown. He received from his father the hand of a wealthy heiress, Mabel of Gloucester, daughter of Robert Fitz Hamon, and with her the lordships of Gloucester and Glamorgan. About 1121 the earldom of Gloucester was created for his benefit. His rank and territorial influence made him the natural leader of the western baronage. Hence, at his father's death, he was sedulously courted by the rival parties of his half-sister the empress Matilda and of Stephen. After some hesitation he declared for the latter, but tendered his homage upon strict conditions, the breach of which should be held to invalidate the contract. Robert afterwards alleged that he had merely feigned submission to Stephen with the object of secretly furthering his half-sister's cause among the English barons. The truth appears to be that he was mortified at finding himself excluded from the inner councils of the king, and so resolved to sell his services elsewhere. Robert left England for Normandy in 1137, renewed his relations with the Angevin party, and in 1138 sent a formal defiance to the king. Returning to England in the following year, he raised the standard of rebellion in his own earldom with such success that the greater part of western England and the south Welsh marches were soon in the possession of the empress. By the battle of Lincoln (Feb. 2, 1141), in which Stephen was taken prisoner, the earl made good Matilda's claim to the whole kingdom. He accompanied her triumphal progress to Winchester and London, but was unable to moderate the arrogance of her behaviour. Consequently she was soon expelled from London and deserted by the bishop Henry of Winchester who, as legate, controlled the policy of the English church. With Matilda the earl besieged the legate at Winchester, but was forced by the royalists to beat a hasty retreat, and in covering Matilda's flight fell into the hands of the pursuers. So great was his importance that his party purchased his freedom by the release of Stephen. The earl renewed the struggle for the crown and continued it until his death (Oct. 31, 1147); but the personal unpopularity of Matilda, and the estrangement of the Church from her cause, made his efforts unavailing. His loyalty to a lost cause must be allowed to weigh in the scale against his earlier double-dealing. But he hardly deserves the extravagant praise which is lavished upon him by William of Malmesbury. The sympathies of the chronicler are too obviously influenced by the earl's munificence towards literary men.

See the *Historia novella* by William of Malmesbury (Rolls edition); the *Historia Anglorum* by Henry of Huntingdon (Rolls edition); J. H. Round's *Geoffrey de Mandeville* (1892); and O. Reuber's *Kaiserin Mathilde* (Berlin, 1897). (H. W. C. D.)

GLOUCESTER, THOMAS OF WOODSTOCK, DUKE OF (1355-1397), seventh and youngest son of the English king Edward III., was born at Woodstock on the 7th of January 1355. Having married Eleanor (d. 1399), daughter and co-heiress of Humphrey de Bohun, earl of Hereford, Essex and Northampton (d. 1373), Thomas obtained the office of constable of England, a position previously held by the Bohuns, and was made earl of Buckingham by his nephew, Richard II., at the coronation in July 1377. He took part in defending the English coasts against the attacks of the French and Castilians, after which he led an army through northern and central France, and besieged Nantes, which town, however, he failed to take.

Returning to England early in 1381, Buckingham found that his brother, John of Gaunt, duke of Lancaster, had married his wife's sister, Mary Bohun, to his own son, Henry, afterwards King Henry IV. The relations between the brothers, hitherto somewhat strained, were not improved by this proceeding, as Thomas, doubtless, was hoping to retain possession of Mary's estates. Having taken some part in crushing the rising of the peasants in 1381, Buckingham became more friendly with Lancaster; and while marching with the king into Scotland in 1385 was created duke of Gloucester, a mark of favour, however, which did not prevent him from taking up an attitude of hostility to Richard. Lancaster having left the country, Gloucester placed himself at the head of the party which disliked the royal advisers, Michael de la Pole, earl of Suffolk and Robert de Vere, earl of Oxford, whose recent elevation to the dignity of duke of Ireland had aroused profound discontent. The moment was propitious for interference, and supported by those who were indignant at the extravagance and incompetence, real or alleged, of the king, Gloucester was soon in a position of authority. He forced on the dismissal and impeachment of Suffolk; was a member of the commission appointed in 1386 to reform the kingdom and the royal household; and took up arms when Richard began proceedings against the commissioners. Having defeated Vere at Radcot in December 1387 the duke and his associates entered London to find the king powerless in their hands. Gloucester, who had previously threatened his uncle with deposition, was only restrained from taking this extreme step by the influence of his colleagues; but, as the leader of the "lords appellants" in the "Merciless Parliament," which met in February 1388 and was packed with his supporters, he took a savage revenge upon his enemies, while not neglecting to add to his own possessions.

He was not seriously punished when Richard regained his power in May 1389, but he remained in the background, although employed occasionally on public business, and accompanying the king to Ireland in 1394. In 1396, however, uncle and nephew were again at variance. Gloucester disliked the peace with France and Richard's second marriage with Isabella, daughter of King Charles VI.; other causes of difference were not wanting, and it has been asserted that the duke was plotting to seize the king. At all events Richard decided to arrest him. By refusing an invitation to dinner the duke frustrated the first attempt, but on the 11th of July 1397 he was arrested by the king himself at his residence, Pleshey castle in Essex. He was taken at once to Calais, and it is probable that he was murdered by order of the king on the 9th of September following. The facts seem to be as follows. At the beginning of September it was reported that he was dead. The rumour, probably a deliberate one, was false, and about the same time a justice, Sir William Rickhill (d. 1407), was sent to Calais with instructions dated the 17th of August to obtain a confession from Gloucester. On the 8th of September the duke confessed that he had been guilty of treason, and his death immediately followed this avowal. Unwilling to meet his parliament so soon after his uncle's death, Richard's purpose was doubtless to antedate this occurrence, and to foster the impression that the duke had died from natural causes in August. When parliament met in September he was declared guilty of treason and his estates forfeited. Gloucester had one son, Humphrey (c. 1381-1390), who died unmarried, and four daughters, the most notable of whom was Anne (c. 1380-1438), who was

successively the wife of Thomas, 3rd earl of Stafford, Edmund, 5th earl of Stafford, and William Bouchier, count of Eu. Gloucester is supposed to have written *l'Ordonnance d'Angleterre pour le camp & l'outrance, ou gage de bataille*.

BIBLIOGRAPHY.—See T. Walsingham, *Historia Anglicana*, edited by H. T. Riley (London, 1863-1864); The Monk of Evesham, *Historia vitas et regni Ricardi II.*, edited by T. Hearne (Oxford, 1729); *Chronique de la traison et mort de Ricard II.*, edited by B. Williams (London, 1846); J. Froissart, *Chroniques*, edited by S. Luce and G. Raynaud (Paris, 1869-1897); W. Stubbs, *Constitutional History*, vol. ii. (Oxford, 1896); J. Tait in *Owens College Historical Essays* and S. Armitage-Smith, *John of Gausni* (London, 1904).

GLOUCESTER (abbreviated as pronounced *Glo'ster*), a city, county of a city, municipal and parliamentary borough and port, and the county town of Gloucestershire, England, on the left (east) bank of the river Severn, 114 m W.N.W. of London. Pop. (1901) 47,955. It is served by the Great Western railway and the west-and-north branch of the Midland railway, while the Berkeley Ship Canal runs S.W. to Sharpness Docks in the Severn estuary (16½ m). Gloucester is situated on a gentle eminence overlooking the Severn and sheltered by the Cotswolds on the east, while the Malverns and the hills of the Forest of Dean rise prominently to the west and north-west.

The cathedral, in the north of the city near the river, originates in the foundation of an abbey of St Peter in 681, the foundations of the present church having been laid by Abbot Serlo (1072-1104); and Walter Frouceter (d. 1412) its historian, became its first mitred abbot in 1381. Until 1541, Gloucester lay in the see of Worcester, but the separate see was then constituted, with John Wakeman, last abbot of Tewkesbury, for its first bishop. The diocese covers the greater part of Gloucestershire, with small parts of Herefordshire and Wiltshire. The cathedral may be succinctly described as consisting of a Norman nucleus, with additions in every style of Gothic architecture. It is 420 ft. long and 144 ft. broad, with a beautiful central tower of the 15th century rising to the height of 225 ft. and topped by four graceful pinnacles. The nave is massive Norman with Early English roof; the crypt also, under the choir, aisles and chapels, is Norman, as is the chapter-house. The crypt is one of the four apsidal cathedral crypts in England, the others being at Worcester, Winchester and Canterbury. The south porch is Perpendicular, with fan-tracery roof, as also is the north transept, the south being transitional Decorated. The choir has Perpendicular tracery over Norman work, with an apsidal chapel on each side. The choir-vaulting is particularly rich, and the modern scheme of colouring is judicious. The splendid late Decorated east window is partly filled with ancient glass. Between the apsidal chapels is a cross Lady chapel, and north of the nave are the cloisters, with very early example of fan-tracery, the carols or stalls for the monks' study and writing lying to the south. The finest monument is the canopied shrine of Edward II. who was brought hither from Berkeley. By the visits of pilgrims to this the building and sanctuary were enriched. In a side-chapel, too, is a monument in coloured bog oak of Robert Curthose, a great benefactor to the abbey, the eldest son of the Conqueror, who was interred there; and those of Bishop Warburton and Dr Edward Jenner are also worthy of special mention. A musical festival, (the Festival of the Three Choirs) is held annually in this cathedral and those of Worcester and Hereford in turn. Between 1873 and 1890 and in 1897 the cathedral was extensively restored, principally by Sir Gilbert Scott. Attached to the deanery is the Norman prior's chapel. In St Mary's Square outside the Abbey gate, Bishop Hooper suffered martyrdom under Queen Mary in 1555.

Quaint gabled and timbered houses preserve the ancient aspect of the city. At the point of intersection of the four principal streets stood the Tolsey or town hall, replaced by a modern building in 1894. None of the old public buildings, in fact, is left, but the New Inn in Northgate Street is a beautiful timbered house, strong and massive, with external galleries and courtyards, built in 1450 for the pilgrims to Edward II.'s shrine, by Abbot Sebroke, a traditional subterranean passage leading thence to the cathedral. The timber is principally chestnut. There are a large

number of churches and dissenting chapels, and it may have been the old proverb, "as sure as God's in Gloucester," which provoked Oliver Cromwell to declare that the city had "more churches than godliness." Of the churches four are of special interest: St Mary de Lode, with a Norman tower and chancel, and a monument of Bishop Hooper, on the site of a Roman temple which became the first Christian church in Britain, St Mary de Crypt, a cruciform structure of the 12th century, with later additions and a beautiful and lofty tower; the church of St Michael, said to have been connected with the ancient abbey of St Peter; and St Nicholas church, originally of Norman erection, and possessing a tower and other portions of later date. In the neighbourhood of St Mary de Crypt are slight remains of Greyfriars and Blackfriars monasteries, and also of the city wall. Early vaulted cellars remain under the Fleece and Saracen's Head inns.

There are three endowed schools: the College school, refounded by Henry VIII. as part of the cathedral establishment, the school of St Mary de Crypt, founded by Dame Joan Cooke in the same reign; and Sir Thomas Rich's Blue Coat hospital for 34 boys (1666). At the Crypt school the famous preacher George Whitefield (1714-1770) was educated, and he preached his first sermon in the church. The first Sunday school was held in Gloucester, being originated by Robert Raikes, in 1780.

The noteworthy modern buildings include the museum and school of art and science, the county gaol (on the site of a Saxon and Norman castle), the Shire Hall and the Whitefield memorial church. A park in the south of the city contains a spa, a chalybeate spring having been discovered in 1814. West of this, across the canal, are the remains (a gateway and some walls) of Llanthony Priory, a cell of the mother abbey in the vale of Ewyas, Monmouthshire, which in the reign of Edward IV. became the secondary establishment.

Gloucester possesses match works, foundries, flour-mills and slate works, saw-mills, chemical works, rope works, marble and manufactories of railway wagons, engines and agricultural implements, and boat and ship-building yards. Gloucester was declared a port in 1882. The Berkeley canal was opened in 1827. The Gloucester canal-harbour and that at Sharpness on the Severn are managed by a board. Principal imports are timber and grain; and exports, coal, salt, iron and bricks. The salmon and lamprey fisheries in the Severn are valuable. The tidal bore in the river attains its extreme height just below the city, and sometimes surmounts the weir in the western branch of the river, affecting the stream up to Tewkesbury lock. The parliamentary borough returns one member. The city is governed by a mayor, 10 aldermen and 30 councillors. Area, 2315 acres.

History.—The traditional existence of a British settlement at Gloucester (Cær Glow, Gleawecastre, Gloucestre) is not confirmed by any direct evidence, but Gloucester was the Roman municipality or *colonia of Glevum*, founded by Nerva (A.D. 96-98). Parts of the walls can be traced, and many remains and coins have been found, though inscriptions (as is frequently the case in Britain) are somewhat scarce. Its situation on a navigable river, and the foundation in 681 of the abbey of St Peter by Æthelred favoured the growth of the town; and before the Conquest Gloucester was a borough governed by a portreeve, with a castle which was frequently a royal residence, and a mint. The first overlord, Earl Godwine, was succeeded nearly a century later by Robert, earl of Gloucester. Henry II. granted the first charter in 1155 which gave the burgesses the same liberties as the citizens of London and Winchester, and a second charter of Henry II. gave them freedom of passage on the Severn. The first charter was confirmed in 1194 by Richard I. The privileges of the borough were greatly extended by the charter of John (1200) which gave freedom from toll throughout the kingdom and from pleading outside the borough. Subsequent charters were numerous. Gloucester was incorporated by Richard III. in 1483, the town being made a county in itself. This charter was confirmed in 1489 and 1510, and other charters of incorporation were received by Gloucester from Elizabeth in 1560, James I.

in 1604, Charles I. in 1626 and Charles II. in 1672. The chartered port of Gloucester dates from 1580. Gloucester returned two members to parliament from 1275 to 1885, since when it has been represented by one member. A seven days' fair from the 24th of June was granted by Edward I. in 1302, and James I. licensed fairs on the 25th of March and the 17th of November, and fairs under these grants are still held on the first Saturday in April and July and the last Saturday in November. The fair now held on the 28th of September was granted to the abbey of St Peter in 1227. A market on Wednesday existed in the reign of John, was confirmed by charter in 1227 and is still held. The iron trade of Gloucester dates from before the Conquest; tanning was carried on before the reign of Richard III., pin-making and bell-founding were introduced in the 16th, and the long-existing coal trade became important in the 18th century. The cloth trade flourished from the 12th to the 16th century. The sea-borne trade in corn and wine existed before the reign of Richard I.

See W. H. Stevenson, *Records of the Corporation of Gloucester* (Gloucester, 1893); *Victoria County History, Gloucestershire*.

GLOUCESTER, a city and port of entry of Essex county, Massachusetts, U.S.A., beautifully situated on Cape Ann. Pop. (1890) 24,651; (1900) 26,121, of whom 8768 were foreign-born, including 4388 English Canadians, 800 French Canadians, 665 Irish, 653 Finns and 594 Portuguese; (1910 census) 24,398. Area, 53.6 sq. m. It is served by the Boston & Maine railway and by a steamboat line to Boston. The surface is sterile, naked and rugged, with bold, rocky ledges, and a most picturesque shore, the beauties of which have made it a favourite summer resort, much frequented by artists. Included within the city borders are several villages, of which the principal one—also known as Gloucester, has a deep and commodious harbour. Among the other villages, all summer resorts, are Annisquam, Bay View and Magnolia (so called from the *Magnolia glauca*, which grows wild there, this being probably its most northerly habitat); near Magnolia are Rafe's Chasm (60 ft. deep and 6-10 ft. wide) and Norman's Woe, the scene of the wreck of the "Hesperus" (which has only tradition as a basis), celebrated in Longfellow's poem. There is some slight general commerce—in 1909 the imports were valued at \$130,008; the exports at \$7853—but the principal business is fishing, and has been since early colonial days. The pursuit of cod, mackerel, herring and halibut fills up, with a winter coasting trade, the round of the year. In this industry Gloucester is the most important place in the United States; and is, indeed, one of the greatest fishing ports of the world. Most of the adult males are engaged in it. The "catch" was valued in 1895 at \$3,212,985 and in 1905 at \$3,377,330. The organization of the industry has undergone many transformations, but a notable feature is the general practice—especially since modern methods have necessitated larger vessels and more costly gear, and correspondingly greater capital—of profit-sharing; all the crew entering on that basis and not independently. There are some manufactures, chiefly connected with the fisheries. The total factory product in 1905 was valued at \$6,920,984, of which the canning and preserving of fish represented \$4,068,571, and glue represented \$752,003. An industry of considerable importance is the quarrying of the beautiful, dark Cape Ann granite that underlies the city and all the environs.

Gloucester harbour was probably noted by Champlain (as La Beauport), and a temporary settlement was made by English fishermen sent out by the Dorchester Company of "merchant adventurers" in 1623-1625; some of these settlers returned to England in 1625, and others, with Roger Conant, the governor, removed to what is now Salem.¹ Permanent settlement antedated 1639 at least, and in 1642 the township was incorporated. From Gosnold's voyages onward the extraordinary abundance of cod about Cape Ann was well known, and though the first

settlers characteristically enough tried to live by farming, they speedily became perforce a sea-faring folk. The active pursuit of fishing as an industry may be dated as beginning about 1700, for then began voyages beyond Cape Sable. Voyages to the Grand Banks began about 1741. Mackerel was a relatively unimportant catch until about 1821, and since then has been an important but unstable return; halibut fishing has been vigorously pursued since about 1836 and herring since about 1856. At the opening of the War of Independence Gloucester, whose fisheries then employed about 600 men, was second to Marblehead as a fishing-port. The war destroyed the fisheries, which steadily declined, reaching their lowest ebb from 1820 to 1840. Meanwhile foreign commerce had greatly expanded. The cod take had supported in the 18th century an extensive trade with Bilbao, Lisbon and the West Indies, and though changed in nature with the decline of the Bank fisheries after the War of Independence, it continued large through the first quarter of the 19th century. Throughout more than half of the same century also Gloucester carried on a varied and valuable trade with Surinam, hake being the chief article of export and molasses and sugar the principal imports. "India Square" remains, a memento of a bygone day. About 1850 the fisheries revived, especially after 1860, under the influence of better prices, improved methods and the discovery of new grounds, becoming again the chief economic interest; and since that time the village of Gloucester has changed from a picturesque hamlet to a fairly modern, though still quaint and somewhat foreign, settlement. Gasoline boats were introduced in 1900. Ship-building is another industry of the past. The first "schooner" was launched at Gloucester in 1713. From 1830 to 1907, 776 vessels and 5242 lives were lost in the fisheries, but the loss of life has been greatly reduced by the use of better vessels and by improved methods of fishing. Gloucester became a city in 1874.

Gloucester life has been celebrated in many books; among others in Elizabeth Stuart Phelps-Ward's *Singular Life and Old Maid's Paradise*, in Rudyard Kipling's *Captains Courageous*, and in James B. Connolly's *Out of Gloucester* (1902), *The Deep Sea's Toll* (1905), and *The Crested Seas* (1907).

See J. J. Babson, *History of the Town of Gloucester* (Gloucester, 1860; with *Notes and Additions*, on genealogy, 1876, 1891); and J. R. Pringle, *History of the Town and City of Gloucester* (Gloucester, 1892).

GLOUCESTER CITY, a city of Camden county, New Jersey, U.S.A., on the Delaware river, opposite Philadelphia. Pop. (1890) 6564; (1900) 6840, of whom 1094 were foreign-born; (1905) 8055; (1910) 9462. The city is served by the West Jersey & Seashore and the Atlantic City railways, and by ferry to Philadelphia, of which it is a residential suburb. Among its manufactures are incandescent gas-burners, rugs, cotton yarns, boats and drills. The municipality owns and operates the water works. It was near the site of Gloucester City that the Dutch in 1623 planted the short-lived colony of Fort Nassau, the first European settlement on the Delaware river, but it was not until after the arrival of English Quakers on the Delaware, in 1677, that a permanent settlement, at first called Axwamus, was established on the site of the present city. This was surveyed and laid out as a town in 1689. During the War of Independence the place was frequently occupied by troops, and a number of skirmishes were fought in its vicinity. The most noted of these was a successful attack upon a detachment of Hessians on the 25th of November 1777 by American troops under the command of General Lafayette. In 1868 Gloucester City was chartered as a city. In Camden county there is a township named GLOUCESTER (pop. in 1905, 2300), incorporated in 1798, and originally including the present township of Clementon and parts of the present townships of Waterford, Union and Winslow.

GLOUCESTERSHIRE, a county of the west midlands of England, bounded N. by Worcestershire, N.E. by Warwickshire, E. by Oxfordshire, S.E. by Berkshire and Wiltshire, S. by Somerset, and W. by Monmouth and Herefordshire. Its area is 1243.3 sq. m. The outline is very irregular, but three physical divisions are well marked—the hills, the vale and the forest. (1) The first (the eastern part of the county) lies among the

¹ According to some authorities (e.g. Pringle) a few settlers remained on the site of Gloucester, the permanent settlement thus dating from 1623 to 1625; of this, however, there is no proof, and the contrary opinion is the one generally held.

uplands of the Cotteswold Hills (*q.v.*), whose westward face is a line of heights of an average elevation of 700 ft., but exceeding 1000 ft. at some points. This line bisects the county from S.W. to N.E. The watershed between the Thames and Severn valleys lies close to it, so that Gloucestershire includes Thames Head itself, in the south-east near Cirencester, and most of the upper feeders of the Thames which join the main stream, from narrow and picturesque valleys on the north. (2) The western Cotteswold line overlooks a rich valley, that of the lower Severn, usually spoken of as "The Vale," or, in two divisions, as the vale of Gloucester and the vale of Berkeley. This great river receives three famous tributaries during its course through Gloucestershire. Near Tewkesbury, on the northern border, the Avon joins it on the left and forms the county boundary for 4 m. This is the river known variously as the Upper, Worcestershire, Warwickshire, Stratford or Shakespeare's Avon, which descends a lovely pastoral valley through the counties named. It is to be distinguished from the Bristol Avon, which rises as an eastward flowing stream of the Cotteswolds, in the south-east of Gloucestershire, sweeps southward and westward through Wiltshire, pierces the hills through a narrow valley which becomes a wooded gorge where the Clifton suspension bridge crosses it below Bristol, and enters the Severn estuary at Avonmouth. For 17 m. from its mouth it forms the boundary between Gloucestershire and Somersetshire, and for 8 m. it is one of the most important commercial waterways in the kingdom, connecting the port of Bristol with the sea. The third great tributary of the Severn is the Wye. From its mouth in the estuary, 8 m. N. of that of the Bristol Avon, it forms the county boundary for 16 m. northward, and above this, over two short reaches of its beautiful winding course, it is again the boundary (3) Between the Wye and the Severn lies a beautiful and historic tract, the forest of Dean, which, unlike the majority of English forests, maintains its ancient character. Gloucestershire has thus a share in the courses of five of the most famous of English rivers, and covers two of the most interesting physical districts in the country. The minor rivers of the county are never long. The vale is at no point within the county wider than 24 m., and so does not permit the formation of any considerable tributary to the Severn from the Dean Hills on the one hand or the Cotteswolds on the other. The Leadon rises east of Hereford, forms part of the north-western boundary, and joins the Severn near Gloucester, watering the vale of Gloucester, the northern part of the vale. In the southern part, the vale of Berkeley, the Stroudwater traverses a narrow, picturesque and populous valley, and the Little Avon flows past the town of Berkeley, joining the Severn estuary on the left. The Frome runs southward to the Bristol Avon at Bristol. The principal northern feeders of the Thames are the Churn (regarded by some as properly the headwater of the main river) rising in the Seven Springs, in the hills above Cheltenham, and forming the southern county boundary near its junction with the Thames at Cricklade; the Coln, a noteworthy trout-stream, joining above Lechlade, and the Lech (forming part of the eastern county boundary) joining below the same town; while from the east of the county there pass into Oxfordshire the Windrush and the Evenlode, much larger streams, rising among the bare uplands of the northern Cotteswolds.

Geology.—No county in England has a greater variety of geological formations. The pre-Cambrian is represented by the gneissic rocks at the south end of the Malvern Hills and by grits at Huntley. At Damory, Charfield and Woodford is a patch of greenstone, the cause of the upheaval of the Upper Silurian basin of Tortworth, in which are the oldest stratified rocks of the county. Of these the Upper Llandoverly is the dominant stratum, exposed near Damory mill, Micklewood chase and Purton passage, wrapping round the base of May and Huntley hills, and reappearing in the vale of Woolhope. The Wenlock limestone is exposed at Falfield mill and Whitfield, and quarried for burning at May hill. The Lower Ludlow shales or mudstones are seen at Berkeley and Purton, where the upper part is probably Aymestry limestone. The series of sandy shales and sandstones which, as Downton sandstones and Ledbury shales, form a transition to the Old Red Sandstone are quarried at Dymock. The "Old Red" itself occurs at Berkeley, Tortworth Green, Thornbury, and several places in the Bristol coal-field, in anticlinal folds

forming hills. It forms also the great basin extending from Ross to Monmouth and from Dymock to Mitcheldean, Abenhall, Blakeney, &c., within which is the Carboniferous basin of the forest. It is cut through by the Wye from Monmouth to Woolston. This formation is over 8000 ft. thick in the forest of Dean. The Bristol and Forest Carboniferous basins lie within the synclinal folds of the Old Red Sandstone; and though the seams of coal have not yet been correlated, they must have been once continuous, as further appears from the existence of an intermediate basin, recently pierced, under the Severn. The lower limestone shales are 500 ft. thick in the Bristol area and only 165 in the forest, richly fossiliferous and famous for their bone bed. The great marine series known as the Mountain Limestone, forming the walls of the grand gorges of the Wye and Avon, is over 2000 ft. thick in the latter district, but only 480 in the former, where it yields the brown hematite in pockets so largely worked for iron even from Roman times. It is much used too for lime and road metal. Above this comes the Millstone Grit, well seen at Brandon hill, where it is 1000 ft. in thickness, though but 455 in the forest. On this rest the Coal Measures, consisting in the Bristol field of two great series, the lower 2000 ft. thick with 36 seams, the upper 3000 ft. with 22 seams, 9 of which reach 2 ft. in thickness. These two series are separated by over 1700 ft. of hard sandstone (Pennant Grit), containing only 5 coal-seams. In the Forest coal-field the whole series is not 3000 ft. thick, with but 15 seams. At Durdham Down a dolomitic conglomerate, of the age known as Keuper or Upper Trias, rests unconformably on the edges of the Palaeozoic rocks, and is evidently a shore deposit, yielding dinosaurian remains. Above the Keuper lays come the Penarth beds, of which classical sections occur at Westbury, Aust, &c. The series consists of grey marls, black paper shales containing much pyrites and a celebrated bone bed, the Cotham landscape marble, and the White Lias limestone, yielding *Ostrea Liassica* and *Cardium Rhaeticum*. The district of Over Severn is mainly of Keuper marls. The whole vale of Gloucester is occupied by the next formation, the Lias, a warm sea deposit of clays and clayey limestones, characterized by ammonites, belemnites and gigantic saurians. At its base is the insect-bearing limestone bed. The pastures producing Gloucester cheese are on the clays of the Lower Lias. The more calcareous Middle Lias or marlstone forms hillocks flanking the Oolite escarpment of the Cotteswolds, as at Wotton-under-Edge and Churchdown. The Cotteswolds consist of the great limestone series of the Lower Oolite. At the base is a transition series of sands, 30 to 40 ft. thick, well developed at Nailsworth and Frocester. Leckhampton hill is a typical section of the Lower Oolite, where the sands are capped by 40 ft. of a remarkable pea grit. Above this are 147 ft. of freestone, 7 ft. of oolite marl, 34 ft. of upper freestone and 38 ft. of ragstone. The Painswick stone belongs to lower freestone. Resting on the Inferior Oolite, and dipping with it to S.E., is the "fuller's earth," a rubbly limestone about 100 ft. thick, throwing out many of the springs which form the head waters of the Thames. Next comes the Great or Bath Oolite, at the base of which are the Stonesfield "slate" beds, quarried for roofing, paling, &c., at Sevenhampton and elsewhere. From the Great Oolite Minchinhampton stone is obtained, and at its top is about 40 ft. of flaggy Oolite with bands of clay known as the Forest Marble. Ripple marks are abundant on the flags; in fact all the Oolites seem to have been near shore or in shallow water, much of the limestone being merely comminuted coral. The highest bed of the Lower Oolite is the Cornbrash, about 40 ft. of rubble, productive in corn, forming a narrow belt from Siddington to Fairford. Near the latter town and Lechlade is a small tract of blue Oxford Clay of the Middle Oolite. The county has no higher Secondary or Tertiary rocks; but the Quaternary series is represented by much northern drift gravel in the vale and Over Severn, by accumulations of Oolitic detritus, including post-Glacial extinct mammalian remains on the flanks of the Cotteswolds, and by submerged forests extending from Sharpness to Gloucester.

Agriculture.—The climate is mild. Between three-quarters and seven-eighths of the total area is under cultivation, and of this some four-sevenths is in permanent pasture. Wheat is the chief grain crop. In the vale the deep rich black and red loamy soil is well adapted for pasturage, and a moist mild climate favours the growth of grasses and root crops. The cattle, save on the frontier of Herefordshire, are mostly shorthorns, of which many are fed for distant markets, and many reared and kept for dairy purposes. The rich grazing tract of the vale of Berkeley produces the famous "double Gloucester" cheese, and the vale in general has long been celebrated for cheese and butter. The vale of Gloucester is the chief grain-growing district. Turnips, &c., occupy about three-fourths of the green crop acreage, potatoes occupying only about a twelfth. A feature of the county is its apple and pear orchards, chiefly for the manufacture of cider and perry, which are attached to nearly every farm. The Cotteswold district is comparatively barren except in the valleys, but it has been famous since the 15th century for the breed of sheep named after it. Oats and barley are here the chief crops.

Other Industries.—The manufacture of woollen cloth followed upon the early success in sheep-farming among the Cotteswolds. This industry is not confined to the hill country or even to Gloucestershire itself in the west of England. The description of cloth principally manufactured is broadcloth, dressed with teasles to produce a short,

close nap on the face, and made of all shades of colour, but chiefly black, blue and scarlet. The principal centre of the industry lies in and at the foot of the south-western Cotswolds. Stroud is the centre for a number of manufacturing villages, and south-west of this are Wotton-under-Edge, North Nibley and others. Machinery and tools, paper, furniture, pottery and glass are also produced. Ironstone, clay, limestone and sandstone are worked, and the coal-fields in the forest of Dean are important. Of less extent is the field in the south of the county, N.E. of Bristol. Strontium sulphate is dug from shallow pits in the red marl of Gloucestershire and Somersetshire.

Communications.—Railway communications are provided principally by the Great Western and Midland companies. Of the Great Western lines, the main line serves Bristol from London. It divides at Bristol, one section serving the south-western counties, another South Wales, crossing beneath the Severn by the Severn Tunnel, 4½ m. in length, a remarkable engineering work. A more direct route, by this tunnel, between London and South Wales, is provided by a line from Wootton Bassett on the main line, running north of Bristol by Badminton and Chipping Sodbury. Other Great Western lines are that from Swindon on the main line, by the Stroud valley to Gloucester, crossing the Severn there, and continuing by the right bank of the river into Wales, with branches north-west into Herefordshire; the Oxford and Worcester trunk line, crossing the north-east of the county, connected with Cheltenham and Gloucester by a branch through the Cotswolds from Chipping Norton junction; and the line from Cheltenham by Broadway to Honeybourne. The west-and-north line of the Midland railway follows the vale from Bristol by Gloucester and Cheltenham with a branch into the forest of Dean by Berkeley, crossing the Severn at Sharpness by a great bridge 1387 yds. in length, with 22 arches. The coal-fields of the forest of Dean are served by several branch lines. In the north, Tewkesbury is served by a Midland branch from Ashchurch to Malvern. The Midland and South-western Junction railway runs east and south from Cheltenham by Cirencester, affording communication with the south of England. The East Gloucester line of the Great Western from Oxford terminates at Fairford. The Thames and Severn canal, rising to a summit level in the tunnel through the Cotswolds at Sapperton, is continued from Wallbridge (Stroud) by the Stroudwater canal, and gives communication between the two great rivers. The Berkeley Ship Canal (16½ m.) connects the port of Gloucester with its outpost of Sharpness on Severn.

Population and Administration.—The area of the ancient county is 795,709 acres, with a population in 1891 of 599,947 and in 1901 of 634,729. The area of the administrative county is 805,482 acres. The county contains 28 hundreds. The municipal boroughs are—Bristol, a city and county borough (pop. 328,945); Cheltenham (49,439); Gloucester, a city and county borough (47,955); Tewkesbury (5419). The other urban districts are—Awre (1096), Charlton Kings (3806), Cirencester (7536), Coleford (2541), Kingswood, on the eastern outskirts of Bristol (11,961), Nailsworth (3028), Newnham (1184), Stow-on-the-Wold (1386), Stroud (9153), Tetbury (1989), Westbury-on-Severn (1866). The number of small ancient market towns is large, especially in the southern part of the vale, on the outskirts of the forest, and among the forest hills of the wolds. Those in the forest district are mostly connected with the coal trade, such as Lydney (3559), besides Awre and Coleford; and, to the north, besides Newnham, Cinderford and Mitcheldean. South from Stroud there are Minchinhampton (3737) and Nailsworth; near the south-eastern boundary Tetbury and Marshfield; Stonehouse (2183), Dursley (2372), Wotton-under-Edge (2992) and Chipping Sodbury along the western line of the hills; and between them and the Severn, Berkeley and Thornbury (2594). Among the uplands of the Cotswolds there are no towns, and villages are few, but in the east of the county, in the upper Thames basin, there are, besides Cirencester, Fairford on the Coln and Lechlade, close to the head of the navigation on the Thames itself. Far up in the Lech valley, remote from railway communication, is Northleach, once a great posting station on the Oxford and Cheltenham road. In the north-east are Stow-on-the-Wold, standing high, and Moreton-in-the-Marsh near the headwaters of the Evenlode. In a northern prolongation of the county, almost detached, is Chipping Campden. Winchcomb (2699) lies 6 m. N.E. of Cheltenham. In the north-west, Newent (2485) is the only considerable town. Gloucestershire is in the Oxford circuit, and assizes are held at Gloucester. It has one court of quarter sessions, and is divided into 24 petty sessional divisions. The boroughs of Bristol, Gloucester and Tewkesbury have separate commissions of the peace and courts of quarter sessions. There are 359 civil parishes. Gloucestershire is principally in the diocese of Gloucester, but part is in that of Bristol, and small parts in those of Worcester and Oxford. There are 408 ecclesiastical parishes or districts wholly or in part within the county. There are five parliamentary divisions, namely, Tewkesbury or northern, Cirencester or eastern, Stroud or mid, Thornbury or southern, and Forest of Dean, each returning one member. The county also includes the boroughs of Gloucester and Cheltenham, each returning one member; and the greater part of the borough of Bristol, which returns four members.

History.—The English conquest of the Severn valley began in 577 with the victory of Ceawlin at Deorham, followed by the

capture of Cirencester, Gloucester and Bath. The Hwiccas who occupied the district were a West Saxon tribe, but their territory had become a dependency of Mercia in the 7th century, and was not brought under West Saxon dominion until the 9th century. No important settlements were made by the Danes in the district. Gloucestershire probably originated as a shire in the 10th century, and is mentioned by name in the Anglo-Saxon Chronicle in 1016. Towards the close of the 11th century the boundaries were readjusted to include Winchcomb, hitherto a county by itself, and at the same time the forest district between the Wye and the Severn was added to Gloucestershire. The divisions of the county for a long time remained very unsettled, and the thirty-nine hundreds mentioned in the Domesday Survey and the thirty-one hundreds of the Hundred Rolls of 1274 differ very widely in name and extent both from each other and from the twenty-eight hundreds of the present day.

Gloucestershire formed part of Harold's earldom at the time of the Norman invasion, but it offered slight resistance to the Conqueror. In the wars of Stephen's reign the cause of the empress Maud was supported by Robert of Gloucester who had rebuilt the castle at Bristol, and the castles at Gloucester and Cirencester were also garrisoned on her behalf. In the barons' war of the reign of Henry III. Gloucester was garrisoned for Simon de Montfort, but was captured by Prince Edward in 1265, in which year de Montfort was slain at Evesham. Bristol and Gloucester actively supported the Yorkist cause during the Wars of the Roses. In the religious struggles of the 16th century Gloucester showed strong Protestant sympathy, and in the reign of Mary Bishop Hooper was sent to Gloucester to be burnt as a warning to the county, while the same Puritan leanings induced the county to support the Parliamentary cause in the civil war of the 17th century. In 1643 Bristol and Cirencester were captured by the Royalists, but the latter was recovered in the same year and Bristol in 1645. Gloucester was garrisoned for the parliament throughout the struggle.

On the subdivision of the Merican diocese in 680 the greater part of modern Gloucestershire was included in the diocese of Worcester, and shortly after the Conquest constituted the archdeaconry of Gloucester, which in 1200 comprised the deaneries of Campden, Stow, Cirencester, Fairford, Winchcombe, Stonehouse, Hawkesbury, Bitton, Bristol, Dursley and Gloucester. The district west of the Severn, with the exception of a few parishes in the deaneries of Ross and Staunton, constituted the deanery of the forest within the archdeaconry and diocese of Hereford. In 1535 the deanery of Bitton had been absorbed in that of Hawkesbury. In 1541 the diocese of Gloucester was created, its boundaries being identical with those of the county. On the erection of Bristol to a see in 1542 the deanery of Bristol was transferred from Gloucester to that diocese. In 1836 the sees of Gloucester and Bristol were united; the archdeaconry of Bristol was created out of the deaneries of Bristol, Cirencester, Fairford and Hawkesbury; and the deanery of the forest was transferred to the archdeaconry of Gloucester. In 1882 the archdeaconry of Cirencester was constituted to include the deaneries of Campden, Stow, Northleach north and south, Fairford and Cirencester. In 1897 the diocese of Bristol was recreated, and included the deaneries of Bristol, Stapleton and Bitton.

After the Conquest very extensive lands and privileges in the county were acquired by the church, the abbey of Cirencester alone holding seven hundreds at fee-farm, and the estates of the principal lay-tenants were for the most part outlying parcels of baronies having their "caput" in other counties. The large estates held by William Fitz Osbern, earl of Hereford, escheated to the crown on the rebellion of his son Earl Roger in 1074-1075. The Berkeleys have held lands in Gloucestershire from the time of the Domesday Survey, and the families of Bassett, Tracy, Clifton, Dennis and Poyntz have figured prominently in the annals of the county. Gilbert de Clare, earl of Gloucester, and Richard of Cornwall claimed extensive lands and privileges in the shire in the 13th century, and Simon de Montfort owned Minsterworth and Rodley.

Bristol was made a county in 1285, and in 1283 Richard III. created Gloucester an independent county, adding to it the hundreds of Dudston and King's Barton. The latter were reunited to Gloucestershire in 1673, but the cities of Bristol and Gloucester continued to rank as independent counties, with separate jurisdiction, county rate and assizes. The chief officer of the forest of Dean was the warden, who was generally also constable of St Briavel Castle. The first justice-seat for the forest was held at Gloucester Castle in 1282, the last in 1635. The hundred of the duchy of Lancaster is within the jurisdiction of the duchy of Lancaster for certain purposes.

The physical characteristics of the three natural divisions of Gloucestershire have given rise in each to a special industry, as already indicated. The forest district, until the development of the Sussex mines in the 16th century, was the chief iron-producing area of the kingdom, the mines having been worked in Roman times, while the abundance of timber gave rise to numerous tanneries and to an important ship-building trade. The hill district, besides fostering agricultural pursuits, gradually absorbed the woollen trade from the big towns, which now devoted themselves almost entirely to foreign commerce. Silk-weaving was introduced in the 17th century, and was especially prosperous in the Stroud valley. The abundance of clay and building-stone in the county gave rise to considerable manufactures of brick, tiles and pottery. Numerous minor industries sprang up in the 17th and 18th centuries, such as flax-growing and the manufacture of pins, buttons, lace, stockings, rope and sailcloth.

Gloucestershire was first represented in parliament in 1290, when it returned two members. Bristol and Gloucester acquired representation in 1295, Cirencester in 1572 and Tewkesbury in 1620. Under the Reform Act of 1832 the county returned four members in two divisions; Bristol, Gloucester, Cirencester, Stroud and Tewkesbury returned two members each, and Cheltenham returned one member. The act of 1868 reduced the representation of Cirencester and Tewkesbury to one member each.

Antiquities.—The cathedrals of Gloucester and Bristol, the magnificent abbey church of Tewkesbury, and the church of Cirencester with its great Perpendicular porch, are described under their separate headings. Of the abbey of Hayles near Winchcomb, founded by Richard, earl of Cornwall, in 1246, little more than the foundations are left, but these have been excavated with great care, and interesting fragments have been brought to light. Most of the old market towns have fine parish churches. At Deerhurst near Tewkesbury, and Cleve near Cheltenham, there are churches of special interest on account of the pre-Norman work they retain. The Perpendicular church at Lechlade is unusually perfect; and that at Fairford was built (c. 1500), according to tradition, to contain the remarkable series of stained-glass windows which are said to have been brought from the Netherlands. These are, however, adjudged to be of English workmanship, and are one of the finest series in the country. The great Decorated Calcot Barn is an interesting relic of the monastery of Kingswood near Tetbury. The castle at Berkeley is a splendid example of a feudal stronghold. Thornbury Castle, in the same district, is a fine Tudor ruin, the pretensions of which evoked the jealousy of Cardinal Wolsey against its builder, Edward Stafford, duke of Buckingham, who was beheaded in 1521. Near Cheltenham is the fine 15th-century mansion of Southam de la Bere, of timber and stone. Memorials of the de la Bere family appear in the church at Cleve. The mansion contains a tiled floor from Hayles Abbey. Near Winchcomb is Sudeley Castle, dating from the 15th century, but the inhabited portion is chiefly Elizabethan. The chapel is the burial place of Queen Catherine Parr. At Great Badminton is the mansion and vast domain of the Beauforts (formerly of the Botelers and others), on the south-eastern boundary of the county.

See *Victoria County History, Gloucestershire*; Sir R. Atkyns, *The Ancient and Present State of Gloucestershire* (London, 1712; 2nd ed. London, 1768); Samuel Rudder, *A New History of Gloucestershire* (Cirencester, 1779); Ralph Bigland, *Historical, Monumental and*

Genealogical Collections relative to the County of Gloucester (2 vols., London, 1791); Thomas Rudge, *The History of the County of Gloucester* (2 vols., Gloucester, 1803); F. D. Fosbrooke *Abstract of Records and Manuscripts respecting the County of Gloucestershire formed into a History* (2 vols., Gloucester, 1807); *Legends, Tales and Songs in the Dialect of the Peasantry of Gloucestershire* (London, 1876); J. D. Robertson, *Glossary of Dialect and Archaic Words of Gloucester* (London, 1890); W. Bazeley and F. A. Hyett, *Bibliographers' Manual of Gloucestershire* (3 vols., London, 1895-1897); W. H. Hutton, *By Thames and Cotswold* (London, 1905). See also *Transactions of the Bristol and Gloucestershire Archaeological Society*.

GLOVE (O. Eng. *glof*, perhaps connected with Gothic *lofa*, the palm of the hand), a covering for the hand, commonly with a separate sheath for each finger.

The use of gloves is of high antiquity, and apparently was known even to the pre-historic cave dwellers. In Homer *Laktes* is described as wearing gloves (*χαρῖδας ἐπὶ χερσὶ*) while walking in his garden (*Od.* xxiv. 230). Herodotus (vi. 72) tells how Leotychides filled a glove (*χρύψις*) with the money he received as a bribe, and Xenophon (*Cyrop.* viii. 8. 17) records that the Persians wore fur gloves having separate sheaths for the fingers (*χαρῖδας σακῶτα καὶ σαρκυλῖθρατα*). Among the Romans also there are occasional references to the use of gloves. According to the younger Pliny (*Ep.* iii. 5. 15) the secretary whom his uncle had with him when ascending Vesuvius wore gloves (*manicæ*) so that he might not be impeded in his work by the cold, and Varro (*R.R.* i. 55.1) remarks that olives gathered with the bare fingers are better than those gathered with gloves (*digitabula* or *digitalia*). In the northern countries the general use of gloves would be more natural than in the south, and it is not without significance that the most common medieval Latin word for glove (*guantus* or *wantus*, Mod. Fr. *gant*) is of Teutonic origin (O. H. Ger. *want*). Thus in the life of Columbanus by Jonas, abbot of Bobbio (d. c. 665), gloves for protecting the hands in doing manual labour are spoken of as *legumenta manuum quas Galli wantos vocant*. Among the Germans and Scandinavians, in the 8th and 9th centuries, the use of gloves, fingerless at first, would seem to have been all but universal, and in the case of kings, prelates and nobles they were often elaborately embroidered and bejewelled. This was more particularly the case with the gloves which formed part of the pontifical vestments (see below). In war and in the chase gloves of leather, or with the backs armoured with articulated iron plates, were early worn; yet in the Bayeux tapestry the warriors on either side fight ungloved. The fact that gloves are not represented by contemporary artists does not prove their non-existence, since this might easily be an omission due to lack of observation or of skill, but so far as the records go, there is no evidence to prove that gloves were in general use in England until the 13th century. It was in this century that ladies began to wear gloves as ornaments; they were of linen and sometimes reached to the elbow. It was, however, not till the 16th century that they reached their greatest elaboration, when Queen Elizabeth set the fashion for wearing them richly embroidered and jewelled.

The symbolic sense of the middle ages early gave to the use of gloves a special significance. Their liturgical use by the Church is dealt with below (*Pontifical gloves*); this was imitated from the usage of civil life. Embroidered and jewelled gloves formed part of the *insignia* of the emperors, and also, and that quite early, of the kings of England. Thus Matthew of Paris, in recording the burial of Henry II. in 1189, mentions that he was buried in his coronation robes, with a golden crown on his head and gloves on his hands. Gloves were also found on the hands of King John when his tomb was opened in 1707, and on those of King Edward I. when his tomb was opened in 1774.

See W. B. Redfern, *Royal and Historic Gloves and Shoes*, with numerous examples.

Gages.—Of the symbolical uses of the glove one of the most widespread and important during the middle ages was the practice of tendering a folded glove as a gage for waging one's law. The origin of this custom is probably not far to seek. The promise to fulfil a judgment of a court of law, a promise secured by the delivery of a *wed* or gage, is one of the oldest, if not the very oldest, of all enforceable contracts. This gage was originally

a chattel of value, which had to be deposited at once by the defendant as security into his adversary's hand, and that the glove became the formal symbol of such deposit is doubtless due to its being the most convenient loose object for the purpose. The custom survived after the contract with the *vadum, wed* or gage had been superseded by the contract with pledges (personal sureties). In the rules of procedure of a baronial court of the 14th century we find: "He shall wage his law with his folded glove (*de son gaunt plyee*) and shall deliver it into the hand of the other, and then take his glove back and find pledges for his law." The delivery of the glove had, in fact, become a mere ceremony, because the defendant had his sureties close at hand.¹

Associated with this custom was the use of the glove in the wager of battle (*vadum in duello*). The glove here was thrown down by the defendant in open court as security that he would defend his cause in arms; the accuser by picking it up accepted the challenge (see WAGER). This form is still prescribed for the challenge of the king's champion at the coronation of English sovereigns, and was actually followed at that of George IV. (see CHAMPION). The phrase "to throw down the gauntlet" is still in common use of any challenge.

Pledges of Service.—The use of the glove as a pledge of fulfilment is exemplified also by the not infrequent practice of enfeoffing vassals by investing them with the glove; similarly the emperors symbolized by the bestowal of a glove the concession of the right to found a town or to establish markets, mints and the like; the "hands" in the armorial bearings of certain German towns are really gloves, reminiscent of this investiture. Conversely, fiefs were held by the render of presenting gloves to the sovereign. Thus the manor of Little Holland in Essex was held in Queen Elizabeth's time by the service of one knight's fee and the rent of a pair of gloves turned up with hare's skin (Blount's *Tenures*, ed. Beckwith, p. 130). The most notable instance in England, however, is the grand serjeanty of finding for the king a glove for his right hand on coronation day, and supporting his right arm as long as he holds the sceptre. The right to perform this "honourable service" was originally granted by William the Conqueror to Bertram de Verdun, together with the manor of Farnham (Farnham Royal) in Buckinghamshire. The male descendants of Bertram performed this serjeanty at the coronations until the death of Theobald de Verdun in 1316, when the right passed, with the manor of Farnham, to Thomas Lord Furnival by his marriage with the heiress Joan. His son William Lord Furnival performed the ceremony at the coronation of Richard II. He died in 1383, and his daughter and heiress Jean de Furnival having married Sir Thomas Nevill, Lord Furnival in her right, the latter performed the ceremony at the coronation of Henry IV. His heiress Maud married Sir John Talbot (1st earl of Shrewsbury) who, as Lord Furnival, presented the glove embroidered with the arms of Verdun at the coronation of Henry V. When in 1541 Francis earl of Shrewsbury exchanged the manor of Farnham with King Henry VIII. for the site and precincts of the priory of Worksop in Nottinghamshire he stipulated that the right to perform this serjeanty should be reserved to him, and the king accordingly transferred the obligation from Farnham to Worksop. On the 3rd of April 1838 the manor of Worksop was sold to the duke of Newcastle and with it the right to perform the service, which had hitherto always been carried out by a descendant of Bertram de Verdun. At the coronation of King Edward VII. the earl of Shrewsbury disputed the duke of Newcastle's right, on the ground that the serjeanty was attached not to the manor but to the priory lands at Worksop, and that the latter had been subdivided by sale so that no single person was entitled to perform the ceremony and the right had therefore lapsed. His petition for a regrant to himself as lineal heir of Bertram de Verdun, however, was

¹ F. W. Maitland and W. P. Baildon, *The Court Baron* (Selden Society, London, 1891), p. 17. Maitland wrongly translates *gaunt plyee* as "twisted" glove, adding "why it should be twisted I cannot say." An earlier instance of the delivery of a folded glove as gage is quoted from the 13th-century Anglo-Norman poem known as *The Song of Dermot and the Earl* (ed. G. H. Orpen, Oxford, 1892) in J. H. Round's *Commune of London*, p. 153.

disallowed by the court of claims, and the serjeanty was declared to be attached to the manor of Worksop (G. Woods Wollaston, *Coronation Claims*, London, 1903, p. 133).

Presentations.—From the ceremonial and symbolic use of gloves the transition was easy to the custom which grew up of presenting them to persons of distinction on special occasions. When Queen Elizabeth visited Cambridge in 1578 the vice-chancellor offered her a "paire of gloves, perfumed and garnished with embroidery and goldsmith's wourke, price 60s.," and at the visit of James I. there in 1615 the mayor and corporation of the town "delivered His Majesty a fair pair of perfumed gloves with gold laces." It was formerly the custom in England for bishops at their consecrations to make presents of gloves to those who came to their consecration dinners and others, but this gift became such a burden to them that by an order in council in 1678 it was commuted for the payment of a sum of £50 towards the rebuilding of St Paul's. Serjeants at law, on their appointment, were given a pair of gloves containing a sum of money which was termed "regards"; this custom is recorded as early as 1495, when according to the *Black Book of Lincoln's Inn* each of the new serjeants received £6, 13s. 4d. and a pair of gloves costing 4d., and it persisted to a late period. At one time it was the practice for a prisoner who pleaded the king's pardon on his discharge to present the judges with gloves by way of a fee. Glove-silver, according to Jacob's *Law Dictionary*, was a name used of extraordinary rewards formerly given to officers of courts, &c., or of money given by the sheriff of a county in which no offenders were left for execution to the clerk of assize and judge's officers; the explanation of the term is that the glove given as a perquisite or fee was in some cases lined with money to increase its value, and thus came to stand for money ostensibly given in lieu of gloves. It is still the custom in the United Kingdom to present a pair of white gloves to a judge or magistrate who when he takes his seat for criminal business at the appointed time finds no cases for trial. By ancient custom judges are not allowed to wear gloves while actually sitting on the bench, and a witness taking the oath must remove the glove from the hand that holds the book. (See J. W. Norton-Kyshe, *The Law and Customs relating to Gloves*, London, 1901.)

Pontifical gloves (Lat. *chirothecae*) are liturgical ornaments peculiar to the Western Church and proper only to the pope, the cardinals and bishops, though the right to wear them is often granted by the Holy See to abbots, cathedral dignitaries and other prelates, as in the case of the other episcopal insignia. According to the present use the gloves are of silk and of the liturgical colour of the day, the edge of the opening ornamented with a narrow band of embroidery or the like, and the middle of the back with a cross. They may be worn only at the celebration of mass (except masses for the dead). In vesting, the gloves are put on the bishop immediately after the dalmatic, the right hand one by the deacon, the other by the subdeacon. They are worn only until the ablution before the canon of the mass, after which they may not again be put on.

At the consecration of a bishop the consecrating prelate puts the gloves on the new bishop immediately after the mitre, with a prayer that his hands may be kept pure, so that the sacrifice he offers may be as acceptable as the gift of venison which Jacob, his hands wrapped in the skin of kids, brought to Isaac. This symbolism (as in the case of the other vestments) is, however, of late growth. The liturgical use of gloves itself cannot, according to Father Braun, be traced beyond the beginning of the 10th century, and their introduction was due, perhaps to the simple desire to keep the hands clean for the holy mysteries, but more probably merely as part of the increasing pomp with which the Carolingian bishops were surrounding themselves. From the Frankish kingdom the custom spread to Rome, where liturgical gloves are first heard of in the earlier half of the 11th century. The earliest authentic instance of the right to wear them being granted to a non-bishop is a bull of Alexander IV. in 1070, conceding this to the abbot of S. Pietro in Cielo d' Oro.

During the middle ages the occasions on which pontifical gloves (often *wanti, guanti*, and sometimes *manice* in the inventories)

were worn were not so carefully defined as now, the use varying in different churches. Nor were the liturgical colours prescribed. The most characteristic feature of the medieval pontifical glove was the ornament (*axellus, fibula, monile, paratura*) set in the middle of the back of the glove. This was usually a small plaque of metal, enamelled or jewelled, generally round, but sometimes square or irregular in shape. Sometimes embroidery was substituted; still more rarely the whole glove was covered, even to the fingers, with elaborate needlework designs.

Liturgical gloves have not been worn by Anglican bishops since the Reformation, though they are occasionally represented as wearing them on their effigies.

See J. Braun, S. J., *Die liturgische Gewandung* (Freiburg im Breisgau, 1907), pp. 359-382, where many beautiful examples are illustrated.

Manufacture of Gloves.—Three countries, according to an old proverb, contribute to the making of a good glove—Spain dressing the leather, France cutting it and England sewing it. But the manufacture of gloves was not introduced into Great Britain till the 10th or 11th century. The incorporation of glovers of Perth was chartered in 1165, and in 1190 a glove-makers' guild was formed in France, with the object of regulating the trade and ensuring good workmanship. The glovers of London in 1349 framed their ordinances and had them approved by the corporation, the city regulations at that time fixing the price of a pair of common sheepskin gloves at 1d. In 1464, when the guild received armorial bearings, they do not seem to have been very strong, but apparently their position improved subsequently and in 1638 they were incorporated as a new company. In 1580 it is recorded that both French and Spanish gloves were on sale in London shops, and in 1661 a company of glovers was incorporated at Worcester, which still remains an important seat of the English glove industry. In America the manufacture of gloves dates from about 1760, when Sir William Johnson brought over several families of glove makers from Perth; these settled in Fulton county, New York, which is now the largest seat of the glove trade in the United States.

Gloves may be divided into two distinct categories, according as these are made of leather or are woven or knitted from fibres such as silk, wool or cotton. The manufacture of the latter kinds is a branch of the hosiery industry. For leather gloves skins of various animals are employed—deer, calves, sheep and lambs, goats and kids, &c.—but kids have had nothing to do with the production of many of the "kid gloves" of commerce. The skins are prepared and dressed by special processes (see LEATHER) before going to the glove-maker to be cut. Owing to the elastic character of the material the cutting is a delicate operation, and long practice is required before a man becomes expert at it. Formerly it was done by shears, the workmen following an outline marked on the leather, but now steel dies are universally employed not only for the bodies of the gloves but also for the thumb-pieces and fourchettes or sides of the fingers. When hand sewing is employed the pieces to be sewn together are placed between a pair of jaws, the holding edges of which are serrated with fine saw-teeth, and the sewer by passing the needle forwards and backwards between each of these teeth secures neat uniform stitching. But sewing machines are now widely employed on the work. The labour of making a glove is much subdivided, different operators sewing different pieces, and others again embroidering the back, forming the button-holes, attaching the buttons, &c. After the gloves are completed, they undergo the process of "laying off," in which they are drawn over metal forms, shaped like a hand and heated internally by steam; in this way they are finally smoothed and shaped before being wrapped in paper and packed in boxes.

Gloves made of thin indiarubber or of white cotton are worn by some surgeons while performing operations, on account of the ease with which they can be thoroughly sterilized.

GLOVER, SIR JOHN HAWLEY (1829-1885), captain in the British navy, entered the service in 1841 and passed his examination as lieutenant in 1849, but did not receive a commission till May 1851. He served on various stations, and was wounded severely in an action with the Burmese at Douabew (4th February 1853). But his reputation was not gained at sea and as a naval officer, but on shore and as an administrative official in the colonies. During his years of service as lieutenant in the navy he had had considerable experience of the coast of Africa, and had taken part in the expedition of Dr W. B. Baikie (1824-1864) up the Niger. On the 21st of April 1863 he was appointed administrator of the government of Lagos, and in that capacity, or as colonial secretary, he remained there till 1872. During this

period he had been much employed in repelling the marauding incursions of the Ashantis. When the Ashanti war broke out in 1873, Captain Glover undertook the hazardous and doubtful task of organizing the native tribes, whom hatred of the Ashantis might be expected to make favourable to the British authorities—to the extent at least to which their fears would allow them to act. His services were accepted, and in September of 1873 he landed at Cape Coast, and, after forming a small trustworthy force of Hausa, marched to Accra. His influence sufficed to gather a numerous native force, but neither he nor anybody else could overcome their abject terror of the ferocious Ashantis to the extent of making them fight. In January 1874 Captain Glover was able to render some assistance in the taking of Kumasi, but it was at the head of a Hausa force. His services were acknowledged by the thanks of parliament and by his creation as G.C.M.G. In 1875 he was appointed governor of Newfoundland and held the post till 1881, when he was transferred to the Leeward Islands. He returned to Newfoundland in 1883, and died in London on the 30th September 1885.

Lady Glover's life of her husband appeared in 1897.

GLOVER, RICHARD (1712-1785), English poet, son of Richard Glover, a Hamburg merchant, was born in London in 1712. He was educated at Cheam in Surrey. While there he wrote in his sixteenth year a poem to the memory of Sir Isaac Newton, which was prefixed by Dr Pemberton to his *View of Newton's Philosophy*, published in 1728. In 1737 he published an epic poem in praise of liberty, *Leonidas*, which was thought to have a special reference to the politics of the time; and being warmly commended by the prince of Wales and his court, it soon passed through several editions. In 1739 Glover published a poem entitled *London, or the Progress of Commerce*; and in the same year, with a view to exciting the nation against the Spaniards, he wrote a spirited ballad, *Hooper's Ghost*, very popular in its day. He was also the author of two tragedies, *Boudicca* (1753) and *Medea* (1761), written in close imitation of Greek models. The success of Glover's *Leonidas* led him to take considerable interest in politics, and in 1761 he entered parliament as member for Weymouth. He died on the 25th of November 1785. The *Athenaid*, an epic in thirty books, was published in 1787, and his diary, entitled *Memoirs of a distinguished literary and political Character from 1742 to 1757*, appeared in 1813. Glover was one of the reputed authors of *Junius*; but his claims—which were advocated in an *Inquiry concerning the author of the Letters of Junius* (1815), by R. Duppa—rest on very slight grounds.

GLOVERSVILLE, a city of Fulton county, New York, U.S.A., at the foot-hills of the Adirondacks, about 55 m. N.W. of Albany. Pop. (1890) 13,864; (1900) 18,349, of whom 2542 were foreign-born; (1910 census) 20,642. It is served by the Fonda, Johnstown & Gloversville railway (connecting at Fonda, about 9 m. distant, with the New York Central), and by electric lines connecting with Johnstown, Amsterdam and Schenectady. The city has a public library (26,000 volumes in 1908), the Nathan Littauer memorial hospital, a state armoury and a fine government building. Gloversville is the principal glove-manufacturing centre in the United States. In 1900 Fulton county produced more than 57%, and Gloversville 38.8%, of all the leather gloves and mittens made in the United States; in 1905 Gloversville produced 29.9% of the leather gloves and mittens made in the United States, its products being valued at \$5,302,196. Gloversville has more than a score of tanneries and leather-finishing factories, and manufactures fur goods. In 1905 the city's total factory product was valued at \$9,340,763. The extraordinary localization of the glove-making industry in Gloversville, Johnstown and other parts of Fulton county, is an incident of much interest in the economic history of the United States. The industry seems to have had its origin among a colony of Perthshire families, including many glove-makers, who were settled in this region by Sir William Johnson about 1760. For many years the entire product seems to have been disposed of in the neighbourhood, but about 1809 the goods began to find more distant markets, and by 1825 the industry was firmly established on a prosperous

basis, the trade being handed down from father to son. An interesting phase of the development is that, in addition to the factory work, a large amount of the industry is in the hands of "home workers" both in the town and country districts. Gloversville, settled originally about 1770, was known for some time as Stump City, its present name being adopted in 1832. It was incorporated as a village in 1851 and was chartered as a city in 1890.

GLOW-WORM, the popular name of the wingless female of the beetle *Lampyrus noctiluca*, whose power of emitting light has been familiar for many centuries. The luminous organs of the glow-worm consist of cells similar to those of the fat-body, grouped into paired masses in the ventral region of the hinder abdominal segments. The light given out by the wingless female insect is believed to serve as an attraction to the flying male, whose luminous organs remain in a rudimentary condition. The common glow-worm is a widespread European and Siberian insect, generally distributed in England and ranging in Scotland northwards to the Tay, but unknown in Ireland. Exotic species of *Lampyrus* are similarly luminous, and light-giving organs are present in many genera of the family *Lampyridae* from various parts of the world. Frequently—as in the south European *Luciola italica*—both sexes of the beetle are provided with wings, and both male and female emit light. These luminous, winged Lampyrids are generally known as "fire-flies." In correspondence with their power of emitting light, the insects are nocturnal in habit.

Elongate centipedes of the family *Geophilidae*, certain species of which are luminous, are sometimes mistaken for the true glow-worm.

GLOXINIA, a charming decorative plant, botanically a species of *Sinningia* (*S. speciosa*), a member of the natural order Gesneraceae and a native of Brazil. The species has given rise under cultivation to numerous forms showing a wonderful variety of colour, and hybrid forms have also been obtained between these and other species of *Sinningia*. A good strain of seed will produce many superb and charmingly coloured varieties, and if sown early in spring, in a temperature of 65° at night, they may be shifted on into 6-in. pots, and in these may be flowered during the summer. The bulbs are kept at rest through the winter in dry sand, in a temperature of 50°, and to yield a succession should be started at intervals, say at the end of February and the beginning of April. To prolong the blooming season, use weak manure water when the flower-buds show themselves.

GLUCINUM, an alternative name for Beryllium (*q.v.*). When L. N. Vauquelin in 1798 published in the *Annales de chimie* an account of a new earth obtained by him from beryl he refrained from giving the substance a name, but in a note to his paper the editors suggested glucine, from *γλυκύς*, sweet, in reference to the taste of its salts, whence the name Glucinum or Glucinium (symbol Gl. or sometimes G). The name beryllium was given to the metal by German chemists and was generally used until recently, when the earlier name was adopted.

GLUCK,¹ **CHRISTOPH WILLIBALD** (1714–1787), operatic composer, German by his nationality, French by his place in art, was born at Weidenwang, near Neumarkt, in the upper Palatinate, on the 2nd of July 1714. He belonged to the lower middle class, his father being gamekeeper to Prince Lobkowitz; but the boy's education was not neglected on that account. From his twelfth to his eighteenth year he frequented the Jesuit school of Kommtau in the neighbourhood of Prince Lobkowitz's estate in Bohemia, where he not only received a good general education, but also had lessons in music. At the age of eighteen Gluck went to Prague, where he continued his musical studies under Cernoborsky, and maintained himself by the exercise of his art, sometimes in the very humble capacity of fiddler at village fairs and dances. Through the introductions of Prince Lobkowitz, however, he soon gained access to the best families of the Austrian nobility; and when in 1736 he proceeded to Vienna he was hospitably received at his protector's palace. Here he met Prince Melzi, an ardent lover of music, whom he accompanied to Milan, continuing his education under Giovanni

¹ Not, as frequently spelt, Glück.

Battista San Martini, a great musical historian and contrapuntist, who was also famous in his own day as a composer of church and chamber music. We soon find Gluck producing operas at the rapid rate necessitated by the omnivorous taste of the Italian public in those days. Nine of these works were produced at various Italian theatres between 1741 and 1745. Although their artistic value was small, they were so favourably received that in 1745 Gluck was invited to London to compose for the Haymarket. The first opera produced there was called *La Caduta dei giganti*; it was followed by a revised version of one of his earlier operas. Gluck also appeared in London as a performer on the musical glasses (see HARMONICA).

The success of his two operas, as well as that of a *pasticcio* (*i.e.* a collection of favourite arias set to a new libretto) entitled *Piramo e Tisbe*, was anything but brilliant, and he accordingly left London. But his stay in England was not without important consequences for his subsequent career. Gluck at this time was rather less than an ordinary producer of Italian opera. Handel's well-known saying that Gluck—"knew no more counterpoint than his cook" must be taken in connexion with the less well-known fact that that cook was an excellent bass singer who performed in many of Handel's own operas. But it indicates the musical reason of Gluck's failure, while Gluck himself learnt the dramatic reason through his surprise at finding that arias which in their original setting had been much applauded lost all effect when adapted to new words in the *pasticcio*. Irrelevant as Handel's criticism appears, it was not without bearing on Gluck's difficulties. The use of counterpoint has very little necessary connexion with contrapuntal display; its real and final cause is a certain depth of harmonic expression which Gluck attained only in his most dramatic moments, and for want of which he, even in his finest works, sometimes moved very lamely. And in later years his own mature view of the importance of harmony, which he upheld in long arguments with Grétry, who believed only in melody, shows that he knew that the dramatic expression of music must strike below the surface. At this early period he was simply producing Handelian opera in an amateurish style, suggesting an unsuccessful imitation of Hasse; but the failure of his *pasticcio* is as significant to us as it was to him, since it shows that already the effect of his music depended upon its characteristic treatment of dramatic situations. This characterizing power was as yet not directly evident, and it needed all the influence of the new instrumental resources of the rising sonata-forms before music could pass out of what we may call its architectural and decorative period and enter into dramatic regions at all.

It is highly probable that the chamber music of his master, San Martini, had already indicated to Gluck a new direction which was more or less incompatible with the older art; and there is nothing discreditable either to Gluck or to his contemporaries in the failure of his earlier works. Had the young composer been successful in the ordinary *opera seria*, there is reason to fear that the great dramatic reform, initiated by him, might not have taken place. The critical temper of the London public fortunately averted this calamity. It may also be assumed that the musical atmosphere of the English capital, and especially the great works of Handel, were not without beneficial influence upon the young composer. But of still greater importance in this respect was a short trip to Paris, where Gluck became for the first time acquainted with the classic traditions and the declamatory style of the French opera—a sphere of music in which his own greatest triumphs were to be achieved. Of these great issues little trace, however, is to be found in the works produced by Gluck during the fifteen years after his return from England. In this period Gluck, in a long course of works by no means free from the futile old traditions, gained technical experience and important patronage, though his success was not uniform. His first opera written for Vienna, *La Semiramide ricominciata*, is again an ordinary *opera seria*, and little more can be said of *Telemacco*, although thirty years later Gluck was able to use most of its overture and an energetic duet in one of his greatest works, *Armide*.

Gluck settled permanently at Vienna in 1756, having two years previously been appointed court chapel-master, with a salary of 2000 florins, by the empress Maria Theresa. He had already received the order of knighthood from the pope in consequence of the successful production of two of his works in Rome. During the long interval from 1756 to 1762 Gluck seems to have matured his plans for the reform of the opera; and, barring a ballet named *Don Giovanni*, and some *airs nouveaux* to French words with pianoforte accompaniment, no compositions of any importance have to be recorded. Several later *pièces d'occasion*, such as *Il Trionfo di Clelia* (1763), are still written in the old manner, though already in 1762 *Orfeo ed Euridice* shows that the composer had entered upon a new career. Gluck had for the first time deserted Metastasio for Raniero Calzabigi, who, as Vernon Lee suggests, was in all probability the immediate cause of the formation of Gluck's new ideas, as he was a hot-headed dramatic theorist with a violent dislike for Metastasio, who had hitherto dominated the whole sphere of operatic libretto.

Quite apart from its significance in the history of dramatic music, *Orpheus* is a work which, by its intrinsic beauty, commands the highest admiration. Orpheus's air, *Che fare*, is known to every one; but still finer is the great *scena* in which the poet's song softens even the *ombre sègneuse* of Tartarus. The ascending passion of the entries of the solo (*Deh! placatevi; Mille pene; Men tiranne*), interrupted by the harsh but gradually softening exclamations of the Furies, is of the highest dramatic effect. These melodies, moreover, as well as every declamatory passage assigned to Orpheus, are made subservient to the purposes of dramatic characterisation; that is, they could not possibly be assigned to any other person in the drama, any more than Hamlet's monologue could be spoken by Polonius. It is in this power of musically realizing a character—a power all but unknown in the serious opera of his day—that Gluck's genius as a dramatic composer is chiefly shown. After a short relapse into his earlier manner, Gluck followed up his *Orpheus* by a second classical music-drama (1767) named *Alceste*. In his dedication of the score to the grand-duke of Tuscany, he fully expressed his aims, as well as the reasons for his total breach with the old traditions. "I shall try," he wrote, "to reduce music to its real function, that of seconding poetry by intensifying the expression of sentiments and the interest of situations without interrupting the action by needless ornament. I have accordingly taken care not to interrupt the singer in the heat of the dialogue, to wait for a tedious *ritornel*, nor do I allow him to stop on a sonorous vowel, in the middle of a phrase, in order to show the nimbleness of a beautiful voice in a long *cadenza*." Such theories, and the stern consistency with which they were carried out, were little to the taste of the pleasure-loving Viennese; and the success of *Alceste*, as well as that of *Paris and Helena*, which followed two years later, was not such as Gluck had desired and expected. He therefore eagerly accepted the chance of finding a home for his art in the centre of intellectual and more especially dramatic life, Paris. Such a chance was opened to him through the *bailli* Le Blanc du Roulet, attaché of the French embassy at Vienna, and a musical amateur who entered into Gluck's ideas with enthusiasm. A classic opera for the Paris stage was accordingly projected, and the friends fixed upon Racine's *Iphigénie en Aulide*. After some difficulties, overcome chiefly by the intervention of Gluck's former pupil, the dauphiness Marie Antoinette, the opera was at last accepted and performed at the Académie de Musique, on the 19th of April 1774.

The great importance of the new work was at once perceived by the musical amateurs of the French capital, and a hot controversy on the merits of *Iphigénie* ensued, in which some of the leading literary men of France took part. Amongst the opponents of Gluck were not only the admirers of Italian vocalization and sweetness, but also the adherents of the earlier French school, who refused to see in the new composer the legitimate successor of Lulli and Rameau. Marmontel, Laharpe and D'Alembert were his opponents, the Abbé Arnaud and others his enthusiastic friends. Rousseau took a peculiar position in the struggle.

In his early writings he is a violent partisan of Italian music, but when Gluck himself appeared as the French champion Rousseau acknowledged the great composer's genius; although he did not always understand it, as for example when he suggested that in *Alceste*, "Divinités du Styx," perhaps the most majestic of all Gluck's arias, ought to have been set as a rondo. Nevertheless in a letter to Dr Burney, written shortly before his death, Rousseau gives a close and appreciative analysis of *Alceste*, the first Italian version of which Gluck had submitted to him for suggestions; and when, on the first performance of the piece not being received favourably by the Parisian audience, the composer exclaimed, "*Alceste est tombée*," Rousseau is said to have comforted him with the flattering *bonmot*, "*Oui, mais elle est tombée du ciel*." The contest received a still more personal character when Piccinni, a celebrated and by no means incapable composer, came to Paris as the champion of the Italian party at the invitation of Madame du Barry, who held a rival court to that of the young princes (see *OPERA*). As a dramatic controversy it suggests a parallel with the Wagnerian and anti-Wagnerian warfare of a later age; but there is no such radical difference between Gluck's and Piccinni's musical methods as the comparison would suggest. Gluck was by far the better musician, but his deficiencies in musical technique were of a kind which contemporaries could perceive as easily as they could perceive Piccinni's. Both composers were remarkable inventors of melody, and both had the gift of making incorrect music sound agreeable. Gluck's indisputable dramatic power might be plausibly dismissed as irrelevant by upholders of music for music's sake, even if Piccinni himself had not chosen, as he did, to assimilate every feature in Gluck's style that he could understand. The rivalry between the two composers was soon developed into a quarrel by the skillful engineering of Gluck's enemies. In 1777 Piccinni was given a libretto by Marmontel on the subject of *Roland*, to Gluck's intense disgust, as he had already begun an opera on that subject himself. This, and the failure of an attempt to show his command of a lighter style by refurbishing up some earlier works at the instigation of Marie Antoinette, inspired Gluck to produce his *Armide*, which appeared four months before Piccinni's *Roland* was ready, and raised a storm of controversy, admiration and abuse. Gluck did not anticipate Wagner more clearly in his dramatic reforms than in his caustic temper; and, as in Gluck's own estimation the difference between *Armide* and *Alceste* is that "*J'en (Alceste) doit faire pleurer et l'autre faire éprouver une voluptueuse sensation*," it was extremely annoying for him to be told by Laharpe that he had made *Armide* a sorceress instead of an enchantress, and that her part was "*une criailerie monotone et fatigante*." He replied to Laharpe in a long public letter worthy of Wagner in its venomous sarcasm and its tremendous value as an advertisement for its recipient.

Gluck's next work was *Iphigénie en Tauride*, the success of which finally disposed of Piccinni, who produced a work on the same subject at the same time and who is said to have acknowledged Gluck's superiority. Gluck's next work was *Echo et Narcisse*, the comparative failure of which greatly disappointed him; and during the composition of another opera, *Les Danaïdes*, an attack of apoplexy compelled him to give up work. He left Paris for Vienna, where he lived for several years in dignified leisure, disturbed only by his declining health. He died on the 15th of November 1787. (F. H.; D. F. T.)

The great interest of the dramatic aspect of Gluck's reforms is apt to overshadow his merit as a musician, and yet in some ways to idealize it. One is tempted to regard him as condoning for technical musical deficiencies by sheer dramatic power, whereas unprejudiced study of his work shows that where his dramatic power asserts itself there is no lack of musical technique. Indeed only a great musician could so reform opera as to give it scope for dramatic power at all. Where Gluck differs from the greatest musicians is in his absolute dependence on literature for his inspiration. Where his librettist failed him (as in his last complete work, *Echo et Narcisse*), he could hardly write tolerably good music; and, even in the finest works of his French

period, the less emotional situations are sometimes set to music which has little interest except as a document in the history of the art. This must not be taken to mean merely that Gluck could not, like Mozart and nearly all the great song-writers, set good music to a bad text. Such inability would prove Gluck's superior literary taste without casting a slur on his musicianship. But it points to a certain weakness as a musician that Gluck could not be inspired except by the more thrilling portions of his libretti. When he was inspired there was no question that he was the first and greatest writer of dramatic music before Mozart. To begin with, he could invent sublime melodies; and his power of producing great musical effects by the simplest means was nothing short of Handelian. Moreover, in his peculiar sphere he deserves the title generally accorded to Haydn of "father of modern orchestration." It is misleading to say that he was the first to use the timbre of instruments with a sense of emotional effect, for Bach and Handel well knew how to give a whole aria or whole chorus peculiar tone by means of a definite scheme of instrumentation. But Gluck did not treat instruments as part of a decorative design, any more than he so treated musical forms. Just as his sense of musical form is that of Philipp Emmanuel Bach and of Mozart, so is his treatment of instrumental tone-colour a thing that changes with every shade of feeling in the dramatic situation, and not in accordance with any purely decorative scheme. To accompany an aria with strings, oboes and flutes, was, for example, a perfectly ordinary procedure; nor was there anything unusual in making the wind instruments play in unison with the strings for the first part of the aria, and writing a passage for one or more of them in the middle section. But it was an unheard-of thing to make this passage consist of long *appoggiaturas* once every two bars in rising sequence on the first oboe, answered by deep *pizzicato* bass notes, while Agamemnon in despair cries: "J'entends retentir dans mon sein le cri plaintif de la nature." Some of Gluck's most forcible effects are of great subtlety, as, for instance, in *Iphigénie en Tauride*, where Orestes tries to reassure himself by saying: "Le calme rentre dans mon cœur," while the intensely agitated accompaniment of the strings belies him. Again, the sense of orchestral climax shown in the oracle scene in *Alceste* was a thing inconceivable in older music, and unsurpassed in artistic and dramatic spirit by any modern composer. Its influence in Mozart's *Idomeneo* is obvious at a first glance.

The capacity for broad melody always implies a true sense of form, whether that be developed by skill or not; and thus Gluck, in rejecting the convenient formalities of older styles of opera, was not, like some reformers, without something better to substitute for them. Moreover he, in consultation with his librettist, achieved great skill in holding together entire scenes, or even entire acts, by dramatically apposite repetitions of short arias and choruses. And thus in large portions of his finest works the music, in spite of frequent full closes, seems to move *pari passu* with the drama in a manner which for naturalness and continuity is surpassed only by the finales of Mozart and the entire operas of Wagner. This is perhaps most noticeable in the second act of *Orfeo*. In its original Italian version both scenes, that in Hades and that in Elysium, are indivisible wholes, and the division into single movements, though technically obvious, is aesthetically only a natural means of articulating the structure. The unity of the scene in Hades extends, in the original version, even to the key-system. This was damaged when Gluck had to transpose the part of Orpheus from an alto to a tenor in the French version. And here we have one of many instances in which the improvements his French experience enabled him to make in his great Italian works were not altogether unmixed. Little harm, however, was done to *Orfeo* which has not been easily remedied by transposing Orpheus's part back again; and in a suitable compromise between the two versions *Orfeo* remains Gluck's most perfect and inspired work. The emotional power of the music is such that the inevitable spoiling of the story by a happy ending has not the aspect of mere conventionality which it had in cases where the

music produced no more than the normal effect upon 18th-century audiences. Moreover Gluck's genius was of too high an order for him to be less successful in portraying a sufficiently intense happiness than in portraying grief. He failed only in what may be called the business capacities of artistic technique; and there is less "business" in *Orfeo* than in almost any other music-drama. It was Gluck's first great inspiration, and his theories had not had time to take action in paper warfare. *Alceste* contains his grandest music and is also very free from weak pages; but in its original Italian version the third act did not give Gluck scope for an adequate climax. This difficulty so accentuated itself in the French version that after continual retouchings a part for Hercules was, in Gluck's absence, added by Gossec; and three pages of Gluck's music, dealing with the supreme crisis where Alceste is rescued from Hades (either by Apollo or by Hercules) were no longer required in performance and have been lost. The Italian version is so different from the French that it cannot help us to restore this passage, in which Gluck's music now stops short just at the point where we realize the full height of his power. The comparison between the Italian and French *Alceste* is one of the most interesting that can be made in the study of a musician's development. It would have been far easier for Gluck to write a new opera if he had not been so justly attached to his second Italian masterpiece. So radical are the differences that in retranslating the French libretto into Italian for performance with the French music not one line of Calzabigi's original text can be retained.

In *Iphigénie en Aulide* and *Iphigénie en Tauride*, Gluck shows signs that the controversies aroused by his methods began to interfere with his musical spontaneity. He had not, in *Orfeo*, gone out of his way to avoid rondos, or we should have had no "Che farò senza Euridice." We read with a respectful smile Gluck's assurance to the bailli Le Blanc du Roulet that "you would not believe *Armide* to be by the same composer" as *Alceste*. But there is no question that *Armide* is a very great work, full of melody, colour and dramatic point; and that Gluck has availed himself of every suggestion that his libretto afforded for orchestral and emotional effects of an entirely different type from any that he had attempted before. And it is hardly relevant to blame him for his inability to write erotic music. In the first place, the libretto is not erotic, though the subject would no doubt become so if treated by a modern poet. In the second place a conflict of passions (as, for instance, where *Armide* summons the demons of Hate to exorcise love from her heart, and her courage fails her as soon as they begin) has never, even in *Alceste*, been treated with more dramatic musical force. The work as a whole is unequal, partly because there is a little too much action in it to suit Gluck's methods; but it shows, as does no other opera until Mozart's *Don Giovanni*, a sense of the development of characters, as distinguished from the mere presentation of them as already fixed.

In *Iphigénie en Aulide* and *Iphigénie en Tauride*, the very subtlety of the finest features indicates a certain self-consciousness which, when inspiration is lacking, becomes mannerism. Moreover, in both cases the libretti, though skilfully managed, tell a rather more complicated story than those which Gluck had hitherto so successfully treated; and, where inspiration fails, the musical technique becomes curiously amateurish without any corresponding naïveté. Still these works are immortal, and their finest passages are equal to anything in *Alceste* and *Orfeo*. *Echo et Narcisse* we must, like Gluck's contemporaries, regard as a failure. As in *Orfeo*, the pathetic story is ruined by a violent happy ending, but here this artistic disaster takes place before the pathos has had time to assert itself. Gluck had no opportunities in this work for any higher qualities, musical or dramatic, than prettiness; and with him beauty, without visible emotion, was indeed skin-deep. It is a pity that the plan of the great Pelletan-Damcke critical *édition de luxe* of Gluck's French operas forbids the inclusion of his Italian *Paride e Elena*, his third opera to Calzabigi's libretto, which was never given in a French version; for there can be no question that, whatever he owed to France, the

period of his greatness began with his collaboration with Calzabigi. (D. F. T.)

GLÜCKSBURG, a town of Germany, in the Prussian province of Schleswig-Holstein, romantically situated among pine woods on the Flensburg Fjord off the Baltic, 6 m. N.E. from Flensburg by rail. Pop. (1905) 1551. It has a Protestant church and some small manufactures and is a favourite sea-bathing resort. The castle, which occupies the site of a former Cistercian monastery, was, from 1622 to 1770, the residence of the dukes of Holstein-Sonderburg-Glücksburg, passing then to the king of Denmark and in 1866 to Prussia. King Frederick VII. of Denmark died here on the 15th of November 1863.

* **GLÜCKSTADT**, a town of Germany, in the Prussian province of Schleswig-Holstein, on the right bank of the Elbe, at the confluence of the small river Rhin, and 28 m. N.W. of Altona, on the railway from Itzehoe to Elmshorn. Pop. (1905) 6586. It has a Protestant and a Roman Catholic church, a handsome town-hall (restored in 1873-1874), a gymnasium, a provincial prison and a penitentiary. The inhabitants are chiefly engaged in commerce and fishing; but the frequent losses from inundations have greatly retarded the prosperity of the town. Glückstadt was founded by Christian IV. of Denmark in 1617, and fortified in 1620. It soon became an important trading centre. In 1627-28 it was besieged for fifteen weeks by the imperialists under Tilly, without success. In 1814 it was blockaded by the allies and capitulated, whereupon its fortifications were demolished. In 1830 it was made a free port. It came into the possession of Prussia together with the rest of Schleswig-Holstein in 1866.

See Lucht, *Glückstadt. Beiträge zur Geschichte dieser Stadt* (Kiel, 1854).

GLUCOSE (from Gr. *γλυκός*, sweet), a carbohydrate of the formula $C_6H_{12}O_6$; it may be regarded as the aldehyde of sorbite. The name is applied in commerce to a complex mixture of carbohydrates obtained by boiling starch with dilute mineral acids; in chemistry, it denotes, with the prefixes *d*, *l* and *d*-*l* (or *l*), the dextro-rotatory, laevo-rotatory and inactive forms of the definite chemical compound defined above. The *d* modification is of the commonest occurrence, the other forms being only known as synthetic products; for this reason it is usually termed glucose, simply; alternative names are dextrose, grape sugar and diabetic sugar, in allusion to its right-handed optical rotation, its occurrence in large quantity in grapes, and in the urine of diabetic patients respectively. In the vegetable kingdom glucose occurs, always in admixture with fructose, in many fruits, especially grapes, cherries, bananas, &c.; and in combination, generally with phenols and aldehydes belonging to the aromatic series, it forms an extensive class of compounds termed glucosides. It appears to be synthesized in the plant tissues from carbon dioxide and water, formaldehyde being an intermediate product; or it may be a hydrolytic product of a glucoside or of a polysaccharose, such as cane sugar, starch, cellulose, &c. In the plant it is freely converted into more complex sugars, poly-saccharoses and also proteids. In the animal kingdom, also, it is very widely distributed, being sometimes a normal and sometimes a pathological constituent of the fluids and tissues; in particular, it is present in large amount in the urine of those suffering from diabetes, and may be present in nearly all the body fluids. It also occurs in honey, the white appearance of candied honey being due to its separation.

Pure *d*-glucose, which may be obtained synthetically (see SUGAR) or by adding crystallized cane sugar to a mixture of 80% alcohol and $\frac{1}{2}$ volume of fuming hydrochloric acid so long as it dissolves on shaking, crystallizes from water or alcohol at ordinary temperatures in nodular masses, composed of minute six-sided plates, and containing one molecule of water of crystallization. This product melts at 86° C., and becomes anhydrous when heated to 110° C. The anhydrous compound can also be prepared, as hard crusts melting at 146°, by crystallizing concentrated aqueous solutions at 30° to 35°. It is very soluble in water, but only slightly soluble in strong alcohol. Its taste

is somewhat sweet, its sweetening power being estimated at from $\frac{1}{3}$ to $\frac{1}{2}$ that of cane sugar. When heated to above 200° it turns brown and produces caramel, a substance possessing a bitter taste, and used, in its aqueous solution or otherwise, under various trade names, for colouring confectionery, spirits, &c. The specific rotation of the plane of polarized light by glucose solutions is characteristic. The specific rotation of a freshly prepared solution is 105°, but this value gradually diminishes to 52.5°, 24 hours sufficing for the transition in the cold, and a few minutes when the solution is boiled. This phenomenon has been called mutarotation by T. M. Lowry. The specific rotation also varies with the concentration; this is due to the dissociation of complex molecules into simpler ones, a view confirmed by cryoscopic measurements.

Glucose may be estimated by means of the polarimeter, *i.e.* by determining the rotation of the plane of polarization of a solution, or, chemically, by taking advantage of its property of reducing alkaline copper solutions. If a glucose solution be added to copper sulphate and much alkali added, a yellowish-red precipitate of cuprous hydrate separates, slowly in the cold, but immediately when the liquid is heated; this precipitate rapidly turns red owing to the formation of cuprous oxide. In 1846 L. C. A. Barreswil found that a strongly alkaline solution of copper sulphate and potassium sodium tartrate (Rochelle salt) remained unchanged on boiling, but yielded an immediate precipitate of red cuprous oxide when a solution of glucose was added. He suggested that the method was applicable for quantitatively estimating glucose, but its acceptance only followed after H. von Fehling's investigation. "Fehling's solution" is prepared by dissolving separately 34.639 grammes of copper sulphate, 173 grammes of Rochelle salt, and 71 grammes of caustic soda in water, mixing and making up to 1000 ccs.; 10 ccs. of this solution is completely reduced by 0.05 grammes of hexose. Volumetric methods are used, but the uncertainty of the end of the reaction has led to the suggestion of special indicators, or of determining the amount of cuprous oxide gravimetrically.

Chemistry.—In its chemical properties glucose is a typical oxyaldehyde or aldose. The aldehyde group reacts with hydrocyanic acid to produce two stereo-isomeric cyanhydrins; this isomerism is due to the conversion of an originally non-asymmetric carbon atom into an asymmetric one. The cyanhydrin is hydrolysable to an acid, the lactone of which may be reduced by sodium amalgam to a glucoheptose, a non-fermentable sugar containing seven carbon atoms. By repeating the process a non-fermentable gluco-octose and a fermentable glucononose may be prepared. The aldehyde group also reacts with phenyl hydrazine to form two phenylhydrazones; under certain conditions a hydroxyl group adjacent to the aldehyde group is oxidized and glucoosazone is produced; this glucoosazone is decomposed by hydrochloric acid into phenyl hydrazine and the keto-aldehyde glucoosone. These transformations are fully discussed in the article SUGAR. On reduction glucose appears to yield the hexahydric alcohol *d*-sorbitol, and on oxidation *d*-gluconic and *d*-saccharic acids. Alkalis partially convert it into *d*-mannose and *d*-fructose. Baryta and lime yield saccharates, *e.g.* $C_6H_{12}O_6 \cdot BaO$, precipitable by alcohol.

The constitution of glucose was established by H. Kiliani in 1885-1887, who showed it to be $CH_2OH \cdot (CH-OH)_4 \cdot CHO$. The subject was taken up by Emil Fischer, who succeeded in synthesizing glucose, and also several of its stereo-isomers, there being 16 according to the Le Bel-van't Hoff theory (see STEREO-ISOMERISM and SUGAR). This open chain structure is challenged in the views put forward by T. M. Lowry and E. F. Armstrong. In 1895 C. Tanret showed that glucose existed in more than one form, and he isolated α , β and γ varieties with specific rotations of 105°, 52.5° and 22°. It is now agreed that the β variety is a mixture of the α and γ . This discovery explained the mutarotation of glucose. In a fresh solution α -glucose only exists, but on standing it is slowly transformed into γ -glucose, equilibrium being reached when the α and γ forms are present in the ratio 0.368:0.632 (Tanret, *Zeit. physikal. Chem.*, 1905, 53, p. 692). It is convenient to refer to these two forms as α and β . Lowry and Armstrong represent these compounds by the following spatial formulae

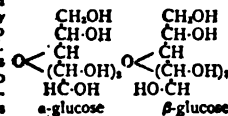

which postulate a γ -oxidic structure, and 5 asymmetric carbon atoms, *i.e.* one more than in the Fischer formulae. These formulae are supported by many considerations, especially by the selective

glue from such heterogeneous materials; one blending may be a success and another a failure. The raw material has been divided into three great divisions: (1) sheep pieces and fleshings (ears, &c.); (2) ox fleshings and trimmings; (3) ox hides and pieces; the best glue is obtained from a mixture of the hide, ear and face clippings of the ox and calf. The raw material or "stock" is first steeped for from two to ten weeks, according to its nature, in wooden vats or pits with lime water, and afterwards carefully dried and stored. The object of the lime steeping is to remove any blood and flesh which may be attached to the skin, and to form a lime soap with the fatty matter present. The "scrows" or glue pieces, which may be kept a long time without undergoing change, are washed with a dilute hydrochloric acid to remove all lime, and then very thoroughly with water; they are now allowed to drain and dry. The skins are then placed in hemp nets and introduced into an open boiler which has a false bottom, and a tap by which liquid may be run off. As the boiling proceeds test quantities of liquid are from time to time examined, and when a sample is found on cooling to form a stiff jelly, which happens when it contains about 32% dry glue, it is ready to draw off. The solution is then run to a clarifier, in which a temperature sufficient to keep it fluid is maintained, and in this way any impurity is permitted to subside. The glue solution is then run into wooden troughs or coolers in which it sets to a firm jelly. The cakes are removed as in the case of bone glue (see above), and, having been placed on nets, are, in the Scottish practice, dried by exposure to open air. This primitive method has many disadvantages: on a hot day the cake may become unshapely, or melt and slip through the net, or dry so rapidly as to crack; a frost may produce fissures, while a fog or mist may precipitate moisture on the surface and occasion a mouldy appearance. The surface of the cake, which is generally dull after drying, is polished by washing with water. The practice of boiling, clarification, cooling and drying, which has been already described in the case of bone glue, has been also applied to the separation of skin glue.

Fish Glue.—Whereas isinglass, a very pure gelatin, is yielded by the sounds of a limited number of fish, it is found that all fish offals yield a glue possessing considerable adhesive properties. The manufacture consists in thoroughly washing the offal with water, and then discharging it into extractors with live steam. After digestion, the liquid is run off, allowed to stand, the upper oily layer removed, and the lower gluey solution clarified with alum. The liquid is then filtered, concentrated in open vats, and bleached with sulphur dioxide.¹ Fish glue is a light-brown viscous liquid which has a distinctly disagreeable odour and an acrid taste; these disadvantages to its use are avoided if it be boiled with a little water and 1% of sodium phosphate, and 0.025% of saccharine added.

Properties of Glue.—A good quality of glue should be free from all specks and grit, have a uniform, light brownish-yellow, transparent appearance, and should break with a glassy fracture. Steeped for some time in cold water it softens and swells up without dissolving, and when again dried it ought to resume its original properties. Under the influence of heat it entirely dissolves in water, forming a thin syrupy fluid with a not disagreeable smell. The adhesiveness of different qualities of glue varies considerably; the best adhesive is formed by steeping the glue, broken in small pieces, in water until they are quite soft, and then placing them with just sufficient water to effect solution in the glue-pot. The hotter the glue, the better the joint; remelted glue is not so strong as the freshly prepared; and newly manufactured glue is inferior to that which has been long in stock. It is therefore seen that many factors enter into the determination of the cohesive power of glue; a well-prepared joint may, under favourable conditions, withstand a pull of about 700 lb per sq. in. The following table, after Kilmarsch, shows the holding power of glued joints with various kinds of woods.

¹ The residue in the extractors is usually dried in steam-heated vessels, and mixed with potassium and magnesium salts; the product is then put on the market as fish-potash guano.

Wood.	lb per sq. in.	
	With grain.	Across grain.
Beech	852	434.5
Maple	484	346
Oak	704	302
Fir	605	132

Special Kinds of Glues, Cements, &c.—By virtue of the fact that the word "glue" is frequently used to denote many adhesives, which may or may not contain gelatin, there will now be given an account of some special preparations. These may be conveniently divided into: (1) liquid glues, mixtures containing gelatin which do not jelly at ordinary temperatures but still possess adhesive properties; (2) water-proof glues, including mixtures containing gelatin, and also the "marine glues," which contain no glue; (3) glues or cements for special purposes, e.g. for cementing glass, pottery, leather, &c., for cementing dissimilar materials, such as paper or leather to iron.

Liquid Glues.—The demand for liquid glues is mainly due to the disadvantages—the necessity of dissolving and using while hot—of ordinary glue. They are generally prepared by adding to a warm glue solution some reagent which destroys the property of gelatinising. The reagents in common use are acetic acid; magnesium chloride, used for a glue employed by printers; hydrochloric acid and zinc sulphate; nitric acid and lead sulphate; and phosphoric acid and ammonium carbonate.

Water-proof Glues.—Numerous recipes for water-proof glues have been published; glue, having been swollen by soaking in water, dissolved in four-fifths its weight of linseed oil, furnishes a good water-proof adhesive; linseed oil varnish and litharge, added to a glue solution, is also used; resin added to a hot glue solution in water, and afterwards diluted with turpentine, is another recipe; the best glue is said to be obtained by dissolving one part of glue in one and a half parts of water, and then adding one-fiftieth part of potassium bichromate. Alcoholic solutions of various gums, and also tannic acid, confer the same property on glue solutions. The "marine glues" are solutions of india-rubber, shellac or asphaltum, or mixtures of these substances, in benzene or naphtha. Jeffrey's marine glue is formed by dissolving india-rubber in four parts of benzene and adding two parts of shellac; it is extensively used, being easily applied and drying rapidly and hard. Another water-proof glue which contains no gelatin is obtained by heating linseed oil with five parts of quicklime; when cold it forms a hard mass, which melts on heating like ordinary glue.

Special Glues.—There are innumerable recipes for adhesives specially applicable to certain substances and under certain conditions. For repairing glass, ivory, &c. isinglass (g.v.), which may be replaced by fine glue, yields valuable cements; bookbinders employ an elastic glue obtained from an ordinary glue solution and glycerin, the water being expelled by heating; an efficient cement for mounting photographs is obtained by dissolving glue in ten parts of alcohol and adding one part of glycerin; portable or mouth glue—so named because it melts in the mouth—is prepared by dissolving one part of sugar in a solution of four parts of glue. An india-rubber substitute is obtained by adding sodium tungstate and hydrochloric acid to a strong glue solution; this preparation may be rolled out when heated to 60°.

For further details see Thomas Lambert, *Glue, Gelatine and their Allied Products* (London, 1905); R. L. Fernbach, *Glues and Gelatins* (1907); H. C. Standage, *Agglutinants of all Kinds for all Purposes* (1907).

GLUTARIC ACID, or **NORMAL PYROTARTARIC ACID**, $\text{HO}_2\text{C}\cdot\text{CH}_2\cdot\text{CH}_2\cdot\text{CH}_2\cdot\text{CO}_2\text{H}$, an organic acid prepared by the reduction of α -oxylglutaric acid with hydriodic acid, by reducing glutaconic acid, $\text{HO}_2\text{C}\cdot\text{CH}_2\cdot\text{CH}=\text{CH}\cdot\text{CO}_2\text{H}$, with sodium amalgam, by conversion of trimethylene bromide into the cyanide and hydrolysis of this compound, or from acetoacetic ester, which, in the form of its sodium derivative, condenses with β -iodopropionic ester to form acetoglutamic ester, $\text{CH}_3\cdot\text{CO}\cdot\text{CH}(\text{CO}_2\text{C}_2\text{H}_5)\cdot\text{CH}_2\cdot\text{CH}_2\cdot\text{CO}_2\text{C}_2\text{H}_5$, from which glutaric acid is obtained by hydrolysis. It is also obtained when sebacic, stearic and oleic acids are oxidized with nitric acid. It crystallizes in large monoclinic prisms which melt at 97.5° C., and distils between 302° and 304° C., practically without decomposition. It is soluble in water, alcohol and ether. By long heating the acid is converted into its anhydride, which, however, is obtained more readily by heating the silver salt of the acid with acetyl chloride. By distillation of the ammonium salt glutarimide, $\text{CH}_2(\text{CH}_2\cdot\text{CP})_2\text{NH}$, is obtained; it forms small crystals melting at 151° to 152° C. and sublimes unchanged.

On the alkyl glutaric acids, see C. Hell (*Ber.*, 1889, 22, pp. 48, 60), C. A. Bischoff (*Ber.*, 1891, 24, p. 1041), K. Anwers (*Ber.*, 1891, 24, p. 1923) and W. H. Perkin, junr. (*Journ. Chem. Soc.*, 1896, 69, p. 268).

GLUTEN, a tough, tenacious, ductile, somewhat elastic, nearly tasteless and greyish-yellow albuminous substance, obtained from the flour of wheat by washing in water, in which it is insoluble. Gluten, when dried, loses about two-thirds of its weight, becoming brittle and semi-transparent; when strongly heated it crackles and swells, and burns like feather or horn. It is soluble in strong acetic acid, and in caustic alkalis, which latter may be used for the purification of starch in which it is present. When treated with 1 to 2% solution of hydrochloric acid it swells up, and at length forms a liquid resembling a solution of albumin, and laevorotatory as regards polarized light. Moistened with water and exposed to the air gluten putrefies, and evolves carbon dioxide, hydrogen and sulphuretted hydrogen, and in the end is almost entirely resolved into a liquid, which contains leucin and ammonium phosphate and acetate. On analysis gluten shows a composition of about 53% of carbon, 7% of hydrogen, and nitrogen 15 to 18%, besides oxygen, and about 1% of sulphur, and a small quantity of inorganic matter. According to H. Ritthausen it is a mixture of *glutenascin* (Liebig's vegetable fibrin), *glutenfibrin*, *gliadin* (Pflanzenleim), *gliasin* or vegetable gelatin, and *amascasin*, which are all closely allied to one another in chemical composition. It is the gliadin which confers upon gluten its capacity of cohering to form elastic masses, and of separating readily from associated starch. In the so-called gluten of the flour of barley, rye and maize, this body is absent (H. Ritthausen and U. Kreuzler). The gluten yielded by wheat which has undergone fermentation or has begun to sprout is devoid of toughness and elasticity. These qualities can be restored to it by kneading with salt, lime-water or alum. Gluten is employed in the manufacture of gluten bread and biscuits for the diabetic, and of chocolate, and also in the adulteration of tea and coffee. For making bread it must be used fresh, as otherwise it decomposes, and does not knead well. Granulated gluten is a kind of vermicelli, made in some starch manufactories by mixing fresh gluten with twice its weight of flour, and granulating by means of a cylinder and contained stirrer, each armed with spikes, and revolving in opposite directions. The process is completed by the drying and sifting of the granules.

GLUTTON, or **WOLVERINE** (*Gulo luscus*), a carnivorous mammal belonging to the *Mustelidae*, or weasel family, and the sole representative of its genus. The legs are short and stout, with large feet, the toes of which terminate in strong, sharp claws considerably curved. The mode of progression is semi-plantigrade. In size and form the glutton is something like the badger, measuring from 2 to 3 ft. in length, exclusive of the thick bushy tail, which is about 8 in. long. The head is broad, the eyes are small and the back arched. The fur consists of an undergrowth of short woolly hair, mixed with long straight hairs, to the abundance and length of which on the sides and tail the creature owes its shaggy appearance. The colour of the fur is blackish-brown, with a broad band of chestnut stretching from the shoulders along each side of the body, the two meeting near the root of the tail. Unlike the majority of arctic animals, the fur of the glutton in winter grows darker. Like other *Mustelidae*, the glutton is provided with anal glands, which secrete a yellowish fluid possessing a highly foetid odour. It is a boreal animal, inhabiting the northern regions of both hemispheres, but most abundant in the circumpolar area of the New World, where it occurs throughout the British provinces and Alaska, being specially numerous in the neighbourhood of the Mackenzie river, and extending southwards as far as New York and the Rocky Mountains. The wolverine is a voracious animal, and also one with an inquisitive disposition. It feeds on grouse, the smaller rodents and foxes, which it digs from their burrows during the breeding-season; but want of activity renders it dependent for most of its food on dead carcasses, which it frequently obtains by methods that have made it peculiarly obnoxious to the hunter and trapper. Should the hunter, after succeeding in killing his game, leave the carcass insufficiently protected for more than a single night, the glutton, whose fear of snares is sufficient to prevent him from touching it during the first night, will, if possible, get at and devour what he can

on the second, hiding the remainder beneath the snow. It annoys the trapper by following up his lines of marten-traps, often extending to a length of 40 to 50 m., each of which it enters from behind, extracting the bait, pulling up the traps, and devouring or concealing the entrapped martens. So persistent is the glutton in this practice, when once it discovers a line of traps, that its extermination along the trapper's route is a necessary preliminary to the success of his business. This is no easy task, as the glutton is too cunning to be caught by the methods successfully employed on the other members of the weasel family. The trap generally used for this purpose is made to resemble a cache, or hidden store of food, such as the Indians and hunters are in the habit of forming, the discovery and rifling of which is one of the glutton's most congenial occupations—the bait, instead of being paraded as in most traps, being carefully concealed, to lull the knowing beast's suspicions. One of the most prominent characteristics of the wolverine is its propensity to steal and hide things, not merely food which it might afterwards need, or traps which it regards as enemies, but articles which cannot possibly have any interest except that of curiosity. The following instance of this is quoted by Dr E. Coues in his work on the *Fur-bearing Animals of North America*: "A hunter and his family having left their lodge unguarded during



The Glutton, or Wolverine (*Gulo luscus*).

their absence, on their return found it completely gutted—the walls were there, but nothing else. Blankets, guns, kettles, axes, cans, knives and all the other paraphernalia of a trapper's tent had vanished, and the tracks left by the beast showed who had been the thief. The family set to work, and, by carefully following up all his paths, recovered, with some trifling exceptions, the whole of the lost property." The cunning displayed by the glutton in unravelling the snares set for it forms at once the admiration and despair of every trapper, while its great strength and ferocity render it a dangerous antagonist to animals larger than itself, occasionally including man. The rutting-season occurs in March, and the female, secure in her burrow, produces her young—four or five at a birth—in June or July. In defence of these she is exceedingly bold, and the Indians, according to Dr Coues, "have been heard to say that they would sooner encounter a she-bear with her cubs than a carcajou (the Indian name of the glutton) under the same circumstances." On catching sight of its enemy, man, the wolverine before finally determining on flight, is said to sit on its haunches, and, in order to get a clearer view of the danger, shade its eyes with one of its fore-paws. When pressed for food it becomes fearless, and has been known to come on board an ice-bound vessel, and in presence of the crew seize a can of meat. The glutton is valuable for its fur, which, when several skins are sewn together, forms elegant hearth and carriage rugs. (R. L.)

GLYCAS, MICHAEL, Byzantine historian (according to some a Sicilian, according to others a Corfiote), flourished during the 12th century A.D. His chief work is his *Chronicle* of events

from the creation of the world to the death of Alexius I. Comnenus (1118). It is extremely brief and written in a popular style, but too much space is devoted to theological and scientific matters. Glycas was also the author of a theological treatise and a number of letters on theological questions. A poem of some 600 "political" verses, written during his imprisonment on a charge of slandering a neighbour and containing an appeal to the emperor Manuel, is still extant. The exact nature of his offence is not known, but the answer to his appeal was that he was deprived of his eyesight by the emperor's orders.

Editions: "Chronicle and Letters," in J. P. Migne, *Patrologia Graeca*, clviii.; poem in E. Legrand, *Bibliothèque grecque vulgaire*, i.; see also F. Hirsch, *Byzantinische Studien* (1876); C. Krumbacher in *Sitzungsberichte bayer. Acad.*, 1894; C. F. Bähr in Erch and Gruber's *Allgemeine Encyclopädie*.

GLYCERIN, GLYCERINE or GLYCEROL (in pharmacy *Glycerinum*) (from Gr. *γλυκός*, sweet), a trihydric alcohol, trihydroxypropane, $C_3H_8(OH)_3$. It is obtainable from most natural fatty bodies by the action of alkalis and similar reagents, whereby the fats are decomposed, water being taken up, and glycerin being formed together with the alkaline salt of some particular acid (varying with the nature of the fat). Owing to their possession of this common property, these natural fatty bodies and various artificial derivatives of glycerin, which behave in the same way when treated with alkalis, are known as glycerides. In the ordinary process of soap-making the glycerin remains dissolved in the aqueous liquors from which the soap is separated.

Glycerin was discovered in 1779 by K. W. Scheele and named *Ölszus* (*principe doux des huiles*—sweet principle of oils), and more fully investigated subsequently by M. E. Chevreul, who named it glycerin, M. P. E. Berthelot, and many other chemists, from whose researches it results that glycerin is a trihydric alcohol indicated by the formula $C_3H_8(OH)_3$, the natural fats and oils, and the glycerides generally, being substances of the nature of compound esters formed from glycerin by the replacement of the hydrogen of the OH groups by the radicals of certain acids, called for that reason "fatty acids." The relationship of these glycerides to glycerin is shown by the series of bodies formed from glycerin by replacement of hydrogen by "stearyl" ($C_{17}H_{33}O$), the radical of stearic acid ($C_{17}H_{33}O-OH$):—

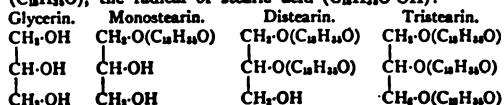

The process of saponification may be viewed as the gradual progressive transformation of tristearin, or some analogously constituted substance, into distearin, monostearin and glycerin, or as the similar transformation of a substance analogous to distearin or to monostearin into glycerin. If the reaction is brought about in presence of an alkali, the acid set free becomes transformed into the corresponding alkaline salt; but if the decomposition is effected without the presence of an alkali (*i.e.* by means of water alone or by an acid), the acid set free and the glycerin are obtained together in a form which usually admits of their ready separation. It is noticeable that with few exceptions the fatty and oily matters occurring in nature are substances analogous to tristearin, *i.e.* they are trebly replaced glycerins. Amongst these glycerides may be mentioned the following:

Tristearin— $C_{57}H_{110}(O-C_{17}H_{33}O)_3$. The chief constituent of hard animal fats, such as beef and mutton tallow, &c.; also contained in many vegetable fats in smaller quantity.

Triolein— $C_{57}H_{110}(O-C_{18}H_{35}O)_3$. Largely present in olive oil and other saponifiable vegetable oils and soft fats; also present in animal fats, especially hog's lard.

Tripalmitin— $C_{55}H_{110}(O-C_{15}H_{31}O)_3$. The chief constituent of palm oil; also contained in greater or less quantities in human fat, olive oil, and other animal and vegetable fats.

Tricinolein— $C_{57}H_{110}(O-C_{18}H_{35}O)_2$. The main constituent of castor oil.

Other analogous glycerides are apparently contained in greater or smaller quantity in certain other oils. Thus in cows'

butter, *tributyris*, $C_3H_7(O-C_4H_7O)_3$, and the analogous glycerides of other readily volatile acids closely resembling butyric acid, are present in small quantity; the production of these acids on saponification and distillation with dilute sulphuric acid is utilized as a test of a purity of butter as sold. **Triacelin**, $C_3H_7(O-C_6H_5O)_3$, is apparently contained in cod-liver oil. Some other glycerides isolated from natural sources are analogous in composition to tristearin, but with this difference, that the three radicals which replace hydrogen in glycerin are not all identical; thus kephalin, myelin and lecithin are glycerides in which two hydrogens are replaced by fatty acid radicals, and the third by a complex phosphoric acid derivative.

Glycerin is also a product of certain kinds of fermentation, especially of the alcoholic fermentation of sugar; consequently it is a constituent of many wines and other fermented liquors. According to Louis Pasteur, about $\frac{1}{10}$ th of the sugar transformed under ordinary conditions in the fermentation of grape juice and similar saccharine liquids into alcohol and other products becomes converted into glycerin. In certain natural fatty substances, *e.g.* palm oil, it exists in the free state, so that it can be separated by washing with boiling water, which dissolves the glycerin but not the fatty glycerides.

Properties.—Glycerin is a viscid, colourless liquid of sp. gr. 1.265 at 15° C., possessing a somewhat sweet taste; below 0° C. it solidifies to a white crystalline mass, which melts at 17° C. When heated alone it partially volatilizes, but the greater part decomposes; under a pressure of 12 mm. of mercury it boils at 170° C. In an atmosphere of steam it distils without decomposition under ordinary barometric pressure. It dissolves readily in water and alcohol in all proportions, but is insoluble in ether. It possesses considerable solvent powers, whence it is employed for numerous purposes in pharmacy and the arts. Its viscid character, and its non-liability to dry and harden by exposure to air, also fit it for various other uses, such as lubrication, &c., whilst its peculiar physical characters, enabling it to blend with either aqueous or oily matters under certain circumstances, render it a useful ingredient in a large number of products of varied kinds.

Manufacture.—The simplest modes of preparing pure glycerin are based on the saponification of fats, either by alkalis or by superheated steam, and on the circumstance that, although glycerin cannot be distilled by itself under the ordinary pressure without decomposition, it can be readily volatilized in a current of superheated steam. Commercial glycerin is mostly obtained from the "spent lyes" of the soap-maker. In the van Ruynebeke process the spent lyes are allowed to settle, and then treated with "per sulphate of iron," the exact composition of which is a trade secret, but it is possibly a mixture of ferric and ferrous sulphates. Ferric hydrate, iron soaps and all insoluble impurities are precipitated. The liquid is filtered, and any excess of iron in the filtrate is precipitated by the careful addition of caustic soda and then removed. The liquid is then evaporated under a vacuum of 27 to 28 in. of mercury, and, when of specific gravity 1.295 (corresponding to about 80% of glycerin), it is distilled under a vacuum of 28 to 29 in. In the Glatz process the lye is treated with a little milk of lime, the liquid then neutralized with hydrochloric acid, and the liquid filtered. Evaporation and subsequent distillation under a high vacuum gives crude glycerin. The impure glycerin obtained as above is purified by redistillation in steam and evaporation in vacuum pans.

Technical Uses.—Besides its use as a starting-point in the production of "nitroglycerin" (*g.u.*) and other chemical products, glycerin is largely employed for a number of purposes in the arts, its application thereto being due to its peculiar physical properties. Thus its non-liability to freeze (when not absolutely anhydrous, which it practically never is when freely exposed to the air) and its non-volatility at ordinary temperatures, combined with its power of always keeping fluid and not drying up and hardening, render it valuable as a lubricating agent for clockwork, watches, &c., as a substitute for water in wet gas-meters, and as an ingredient in cataplasms, plasters, modelling clay, pasty colouring matters, dyeing materials, moist colours for artists, and numerous other analogous substances which are required to be kept in a permanently soft condition. Glycerin acts as a preservative against decomposition, owing to its antiseptic qualities, which also led to its being employed to preserve untanned leather (especially during transit when exported, the hides being, moreover, kept soft and supple); to make solutions of gelatin, albumen, gum, paste, cements, &c. which will keep without decomposition; to preserve meat and other edibles; to mount anatomical preparations; to preserve vaccine lymph unchanged; and for many similar purposes. Its solvent power is also

utilized in the production of various colouring fluids, where the colouring matter would not dissolve in water alone; thus aniline violet, the tinctorial constituents of madder, and various allied colouring matters dissolve in glycerin, forming liquids which remain coloured even when diluted with water, the colouring matters being either retained in suspension or dissolved by the glycerin present in the diluted fluid. Glycerin is also employed in the manufacture of formic acid (*q.v.*). Certain kinds of copying inks are greatly improved by the substitution of glycerin, in part or entirely, for the sugar or honey usually added.

In its medicinal use glycerin is an excellent solvent for such substances as iodine, alkaloids, alkalis, &c., and is therefore used for applying them to diseased surfaces, especially as it aids in their absorption. It does not evaporate or turn rancid, whilst its marked hygroscopic action ensures the moistness and softness of any surface that it covers. Given by the mouth glycerin produces purging if large doses are administered, and has the same action if only a small quantity be introduced into the rectum. For this purpose it is very largely used either as a suppository or in the fluid form (one or two drachms). The result is prompt, safe and painless. Glycerin is useless as a food and is not in any sense a substitute for cod-liver oil. Very large doses in animals cause lethargy, collapse and death.

GLYCOLS, in organic chemistry, the generic name given to the aliphatic dihydric alcohols. These compounds may be obtained by heating the alkylen iodides or bromides (*e.g.* ethylene dibromide) with silver acetate or with potassium acetate and alcohol, the esters so produced being then hydrolysed with caustic alkalis, thus:

$$C_2H_5Br + 2C_2H_5O_2Ag \rightarrow C_2H_4(O-C_2H_5O)_2 + 2K-C_2H_5O;$$

by the direct union of water with the alkylen oxides; by oxidation of the olefines with cold potassium permanganate solution (G. Wagner, *Ber.*, 1888, 21, p. 1231), or by the action of nitrous acid on the diamines.

Glycols may be classified as *primary*, containing two $-CH_2OH$ groups; *primary-secondary*, containing the grouping $-CH(OH)-CH_2OH$; *secondary*, with the grouping $-CH(OH)-CH(OH)-$; and *tertiary*, with the grouping $>C(OH)-(OH)C<$. The secondary glycols are prepared by the action of alcoholic potash on aldehydes, thus:

$$3(CH_3)_2CH-CHO + KHO = (CH_3)_2CHCOK + (CH_3)_2CH-CH(OH)-CH(OH)-CH(CH_3)_2.$$

The tertiary glycols are known as *pinacones* and are formed on the reduction of ketones with sodium amalgam.

The glycols are somewhat thick liquids, of high boiling point, the pinacones only being crystalline solids; they are readily soluble in water and alcohol, but are insoluble in ether. By the action of dehydrating agents they are converted into aldehydes or ketones. In their general behaviour towards oxidizing agents the primary glycols behave very similarly to the ordinary primary alcohols (*q.v.*), but the secondary and tertiary glycols break down, yielding compounds with a smaller carbon content.

Ethylene glycol, $C_2H_4(OH)_2$, was first prepared by A. Wurtz (*Ann. chim.*, 1859 [3], 55, p. 400) from ethylene dibromide and silver acetate. It is a somewhat pleasant smelling liquid, boiling at 197° to 197.5° C. and having a specific gravity of 1.125 (0°). On fusion with solid potash at 250° C. it completely decomposes, giving potassium oxalate and hydrogen,

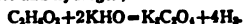

Two propylene glycols, $C_3H_8O_2$, are known, viz. *n*-propylene glycol, $CH_3-CH(OH)-CH_2OH$, a liquid boiling at 188° to 189° , and obtained by heating glycerin with sodium hydroxide and distilling the mixture; and trimethylene glycol, $CH_2OH-CH_2-CH_2OH$, a liquid boiling at 214° C. and prepared by boiling trimethylene bromide with potash solution (A. Zander, *Ann.*, 1882, 214, p. 178).

GLYCONIC (from Glycon, a Greek lyric poet), a form of verse, best known in Catullus and Horace (usually in the catalectic variety — — — — — x), with three feet—a spondee and two dactyls; or four—three trochees and a dactyl, or a dactyl and three chorées. Sir R. Jebb pointed out that the last form might be varied by placing the dactyl second or third, and according to its place this verse was called a First, Second or Third Glyconic.

Cf. J. W. White, in *Classical Quarterly* (Oct. 1909).

GLYPH (from Gr. γλύφω, to carve), in architecture, a vertical channel in a frieze (see TRIGLYPH).

GLYPTODON (Greek for "fluted-tooth"), a name applied by Sir R. Owen to the typical representative of a group of gigantic, armadillo-like, South American, extinct Edentata,

characterized by having the carapace composed of a solid piece (formed by the union of a multitude of bony dermal plates) without any movable rings. The facial portion of the skull is very short; a long process of the maxillary bone descends from the anterior part of the zygomatic arch; and the ascending ramus of the mandible is remarkably high. The teeth, $\frac{1}{2}$ in the later species, are much alike, having two deep grooves or flutings on each side, so as to divide them into three distinct lobes (*fig.*). They are very tall and grew throughout life. The vertebral column is almost entirely welded into a solid tube, but there is a complex joint at the base of the neck, to allow the head being retracted within the carapace. The limbs are very strong, and the feet short and broad, resembling externally those of an elephant or tortoise.

Glyptodonts constitute a family, the *Glyptodontidae*, whose position is next to the armadillos (*Dasyopidae*); the group being represented by a number of generic types. The Pleistocene forms, whose remains occur abundantly in the silt of the Buenos Aires pampas, are by far the largest, the skull and tail-sheath in some instances having a length of from 12 to 16 ft. In *Glyptodon* (with which *Schistopleurum* is identical) the tail-sheath consists of a series of coronet-like rings, gradually diminishing in diameter from base to tip. *Dasilestes*, in which the tail-sheath is in the form of a huge solid club, is the largest member of the family; in *Panochthus* and *Scleracalyptus* (*Hopliphorus*) the tail-sheath consists basally of a small number of smooth rings, and terminally of a tube. In some specimens of these genera the horny shields covering the bony scutes of the carapace have been preserved, and since the foramina, which often pierce the latter, stop tooth of a *Glyptodon*; short of the former, it is evident that these the upper figure show were for the passage of blood-vessels and ing one side, and the not receptacles for bristles. In the early lower the crown.

Pleistocene epoch, when South America became connected with North America, some of the glyptodonts found their way into the latter continent. Among these northern forms some from Texas and Florida have been referred to *Glyptodon*. One large species from Texas has, however, been made the type of a separate genus, under the name of *Glyptotherium texanum*. In some respects it shows affinity with *Panochthus*, although in the simple structure of the tail-sheath it recalls the undermentioned *Propalaeohopliphorus*. All the above are of Pleistocene and perhaps Pliocene age, but in the Santa Cruz beds of Patagonia there occur the two curious genera *Propalaeohopliphorus* and *Palesthis*, the former of which is a primitive and generalized type of glyptodont, while the latter seems to come nearer to the armadillos. Both are represented by species of comparatively small size. In *Propalaeohopliphorus* the scutes of the carapace, which are deep sculptured than in the larger glyptodonts, are arranged in distinct transverse rows, in three of which they partially overlap near the border of the carapace after the fashion of the armadillos. The skull and limb-bones exhibit several features met with in the latter, and the vertebrae of the back are not welded into a continuous tube. There are eight pairs of teeth, the first four of which are simpler than the rest, and may perhaps therefore be regarded as premolars. More remarkable is *Palesthis*, on account of the fact that the teeth, which are simple, with a chevron-shaped section, form a continuous series from the front of the jaw backwards, the number of pairs being seven. Accordingly, a modification of the character, even of the true Edentata, as given in the earlier article, is rendered necessary. The head bears a pair of horn-like scutes, and the scutes of the carapace and tail, which are loosely opposed or slightly overlapping, form a number of transverse rows.

LITERATURE.—R. Lydekker, "The Extinct Edentates of Argentina." *Ann. Mus. La Plata—Pal. Argent.* vol. iii. p. 2 (1904); H. F. Osborn, "Glyptotherium texanum," a Glyptodont from the Lower Pleistocene of Texas." *Bull. Amer. Mus.* vol. xvii. p. 491 (1903); W. B. Scott, "Mammalia of the Santa Cruz Beds—Edentata," *Rep. Princeton Exped. to Patagonia*, vol. v. (1903-1904). (R. L. *)

GLYPTOTHEK (from Gr. γλύπτω, carved, and θέκη, a place of storage), an architectural term given to a gallery for the exhibition of sculpture, and first employed at Munich, where it was built to exhibit the sculptures from the temple of Aegina.



Two views of the tail-sheath of a *Glyptodon*; short of the former, it is evident that these the upper figure show were for the passage of blood-vessels and ing one side, and the not receptacles for bristles. In the early lower the crown.

GMELIN, the name of several distinguished German scientists, of a Tübingen family. Johann Georg Gmelin (1674-1728), an apothecary in Tübingen, and an accomplished chemist for the times in which he lived, had three sons. The first, Johann Conrad (1702-1750), was an apothecary and surgeon in Tübingen. The second, Johann Georg (1709-1755), was appointed professor of chemistry and natural history in St Petersburg in 1731, and from 1733 to 1743 was engaged in travelling through Siberia. The fruits of his journey were *Flora Sibirica* (4 vols., 1749-1750) and *Reisen durch Sibirien* (4 vols., 1753). He ended his days as professor of medicine at Tübingen, a post to which he was appointed in 1749. The third son, Philipp Friedrich (1721-1768), was extraordinary professor of medicine at Tübingen in 1750, and in 1755 became ordinary professor of botany and chemistry. In the second generation Samuel Gottlieb (1743-1774), the son of Johann Conrad, was appointed professor of natural history at St Petersburg in 1766, and in the following year started on a journey through south Russia and the regions round the Caspian Sea. On his way back he was captured by Usmei Khan, of the Kaitak tribe, and died from the ill-treatment he suffered, on the 27th of July 1774. One of his nephews, Ferdinand Gottlob von Gmelin (1782-1848), became professor of medicine and natural history at Tübingen in 1805, and another, Christian Gottlob (1792-1860), who in 1828 was one of the first to devise a process for the artificial manufacture of ultramarine, was professor of chemistry and pharmacy in the same university. In the youngest branch of the family, Philipp Friedrich had a son, Johann Friedrich (1748-1804), who was appointed professor of medicine in Tübingen in 1772, and in 1775 accepted the chair of medicine and chemistry at Göttingen. In 1788 he published the 13th edition of Linnaeus' *Systema Naturae* with many additions and alterations. His son Leopold (1788-1853), was the best-known member of the family. He studied medicine and chemistry at Göttingen, Tübingen and Vienna, and in 1813 began to lecture on chemistry at Heidelberg, where in 1814 he was appointed extraordinary, and in 1817 ordinary, professor of chemistry and medicine. He was the discoverer of potassium ferricyanide (1822), and wrote the *Handbuch der Chemie* (1st ed. 1817-1819, 4th ed. 1843-1855), an important work in its day, which was translated into English for the Cavendish Society by H. Watts (1815-1884) in 1848-1850. He resigned his chair in 1852, and died on the 13th of April in the following year at Heidelberg.

GMÜND, a town of Germany, in the kingdom of Württemberg,¹ in a charming and fruitful valley on the Rems, here spanned by a beautiful bridge, 31 m. E.N.E. of Stuttgart on the railway to Nördlingen. Pop. (1905) 18,699. It is surrounded by old walls, flanked with towers, and has a considerable number of ancient buildings, among which are the fine church of the Holy Cross; St John's church, which dates from the time of the Hohenstaufen; and, situated on a height near the town, partly built out of the rock, the pilgrimage church of the Saviour. Among the modern buildings are the gymnasium, the drawing and trade schools, the Roman Catholic seminary, the town hall and the industrial art museum. Clocks and watches are manufactured here and also other articles of silver, while the town has a considerable trade in corn, hops and fruit. The scenery in the neighbourhood is very beautiful, near the town being the district called Little Switzerland.

Gmünd was surrounded by walls in the beginning of the 12th century by Duke Frederick of Swabia. It received town rights from Frederick Barbarossa, and after the extinction of the Hohenstaufen became a free imperial town. It retained its independence till 1803, when it came into the possession of Württemberg. Gmünd is the birth-place of the painter Hans Baldung (1475-1545) and of the architect Heinrich Arler or Parler (fl. 1350). In the middle ages the population was about 10,000. See Kaiser, *Gmünd und seine Umgebung* (1888).

¹ There are two places of this name in Austria, (1) Gmünd, a town in Lower Austria, containing a palace belonging to the imperial family, (2) a town in Carinthia, with a beautiful Gothic church and some interesting ruins.

GMUNDEN, a town and summer resort of Austria, in Upper Austria, 40 m. S.S.W. of Linz by rail. Pop. (1900) 7126. It is situated at the efflux of the Traun river from the lake of the same name and is surrounded by high mountains, as the Traunstein (5446 ft.), the Erlakogel (5150 ft.), the Wilde Kogel (6860 ft.) and the Höllen Gebirge. It is much frequented as a health and summer resort, and has a variety of lake, brine, vegetable and pine-cone baths, a hydropathic establishment, inhalation chambers, whey cure, &c. There are a great number of excursions and points of interest round Gmunden, specially worth mentioning being the Traun Fall, 10 m. N. of Gmunden. It is also an important centre of the salt industry in Salzkammergut. Gmunden was a town encircled with walls already in 1186. On the 14th of November 1626, Pappenheim completely defeated here the army of the rebellious peasants.

See F. Krackowizer, *Geschichte der Stadt Gmunden in Oberösterreich* (Gmunden, 1898-1901, 3 vols.).

GNAT (O. Eng. *gnat*), the common English name for the smaller dipterous flies (see DIPTERA) of the family *Culicidae*, which are now included among "mosquitoes" (see MOSQUITO). The distinctive term has no zoological significance, but in England the "mosquito" has commonly been distinguished from the "gnat" as a variety of larger size and more poisonous bite.

GNATHOPODA, a term in zoological classification, suggested as an alternative name for the group Arthropoda (*g.n.*). The word, which means "jaw-footed," refers to the fact that in the members of the group, some of the lateral appendages or "feet" in the region of the mouth act as jaws.

GNATIA (also EGNATIA or IGNATIA, mod. *Amesso*, near Fasano), an ancient city of the Peucetii, and their frontier town towards the Salentini (*i.e.* of Apulia towards Calabria), in Roman times of importance for its trade, lying as it did on the sea, at the point where the Via Traiana joined the coast road, 38 m. S.E. of Bari. The ancient city walls have been almost entirely destroyed in recent times to provide building material,² and the place is famous for the discoveries made in its tombs. A considerable collection of antiquities from Gnatia is preserved at Fasano, though the best are in the museum at Bari. Gnatia was the scene of the prodigy at which Horace mocks (*Sat.* i. 5. 97). Near Fasano are two small subterranean chapels with paintings of the 11th century A.D. (E. Bertaux, *L'Art dans l'Italie méridionale*, Paris, 1904, 135). (T. As.)

GNEISENAU, AUGUST WILHELM ANTON, COUNT NEITHARDT VON (1760-1831), Prussian field marshal, was the son of a Saxon officer named Neithardt. Born in 1760 at Schildau, near Torgau, he was brought up in great poverty there, and subsequently at Würzburg and Erfurt. In 1777 he entered Erfurt university; but two years later joined an Austrian regiment there quartered. In 1782 taking the additional name of Gneisenau from some lost estates of his family in Austria, he entered as an officer the service of the margrave of Baireuth-Anspach. With one of that prince's mercenary regiments in English pay he saw active service and gained valuable experience in the War of American Independence, and returning in 1786, applied for Prussian service. Frederick the Great gave him a commission as first lieutenant in the infantry. Made *Stabskapitän* in 1790, Gneisenau served in Poland, 1793-1794, and, subsequently to this, ten years of quiet garrison life in Jauer enabled him to undertake a wide range of military studies. In 1796 he married Caroline von Kottwitz. In 1806 he was one of Hohenlohe's staff-officers, fought at Jena, and a little later commanded a provisional infantry brigade which fought under Lestocq in the Lithuanian campaign. Early in 1807 Major von Gneisenau was sent as commandant to Colberg, which, small and ill-protected as it was, succeeded in holding out until the peace of Tilsit. The commandant received the much-prized order "pour le mérite," and was promoted lieutenant-colonel.

A wider sphere of work was now opened to him. As chief of

² There is no authority for calling the latter Via Egnatia.

³ H. Swinburne, *Travels in the Two Sicilies* (London, 1790), ii. 13, mentions the walls as being 8 yds. thick and 16 courses high.

engineers, and a member of the reorganizing committee, he played a great part, along with Scharnhorst, in the work of re-constructing the Prussian army. A colonel in 1809, he soon drew upon himself, by his energy, the suspicion of the dominant French, and Stein's fall was soon followed by Gneisenau's retirement. But, after visiting Russia, Sweden and England, he returned to Berlin and resumed his place as a leader of the patriotic party. In open military work and secret machinations his energy and patriotism were equally tested, and with the outbreak of the War of Liberation, Major-General Gneisenau became Blücher's quartermaster-general. Thus began the connexion between these two soldiers which has furnished military history with its best example of the harmonious co-operation between the general and his chief-of-staff. With Blücher, Gneisenau served to the capture of Paris; his military character was the exact complement of Blücher's, and under this happy guidance the young troops of Prussia, often defeated but never discouraged, fought their way into the heart of France. The plan of the march on Paris, which led directly to the fall of Napoleon, was specifically the work of the chief-of-staff. In reward for his distinguished service he was in 1814, along with York, Kleist and Bülow, made count at the same time as Blücher became prince of Wahlstatt; an annuity was also assigned to him.

In 1815, once more chief of Blücher's staff, Gneisenau played a very conspicuous part in the Waterloo campaign (q.v.). Senior generals, such as York and Kleist, had been set aside in order that the chief-of-staff should have the command in case of need, and when on the field of Ligny the old field marshal was disabled, Gneisenau at once assumed the control of the Prussian army. Even in the light of the evidence that many years' research has collected, the precise part taken by Gneisenau in the events which followed is much debated. It is known that Gneisenau had the deepest distrust of the British commander, who, he considered, had left the Prussians in the lurch at Ligny, and that to the hour of victory he had grave doubts as to whether he ought not to fall back on the Rhine. Blücher, however, soon recovered from his injuries, and, with Grolmann, the quartermaster-general, he managed to convince Gneisenau. The relations of the two may be illustrated by Brigadier-General Hardinge's report. Blücher burst into Hardinge's room at Wavre, saying "Gneisenau has given way, and we are to march at once to your chief."

On the field of Waterloo, however, Gneisenau was quick to realize the magnitude of the victory, and he carried out the pursuit with a relentless vigour which has few parallels in history. His reward was further promotion and the insignia of the "Black Eagle" which had been taken in Napoleon's coach. In 1816 he was appointed to command the VIIIth Prussian Corps, but soon retired from the service, both because of ill-health and for political reasons. For two years he lived in retirement on his estate, Erdmannsdorf in Silesia, but in 1818 he was made governor of Berlin in succession to Kalkreuth, and member of the *Staatsrath*. In 1825 he became general field marshal. In 1831 he was appointed to the command of the Army of Observation on the Polish frontier, with Clausewitz as his chief-of-staff. At Posen he was struck down by cholera and died on the 24th of August 1831, soon followed by his chief-of-staff, who fell a victim to the same disease in November.

As a soldier, Gneisenau was the greatest Prussian general since Frederick; as a man, his noble character and virtuous life secured him the affection and reverence, not only of his superiors and subordinates in the service, but of the whole Prussian nation. A statue by Rauch was erected in Berlin in 1855, and in memory of the siege of 1807 the Colberg grenadiers received his name in 1889. One of his sons led a brigade of the VIIIth Army Corps in the war of 1870.

See G. H. Pertz, *Das Leben des Feldmarschalls Grafen Neithardt von Gneisenau*, vols. 1-3 (Berlin, 1864-1869); vols. 4 and 5. C. Delbrück (ib. 1879, 1880), with numerous documents and letters; H. Delbrück, *Das Leben des G. F. M. Grafen von Gneisenau* (2 vols., 2nd ed., Berlin, 1894), based on Pertz's work, but containing much

new material; Frau von Beguelin, *Denkwürdigkeiten* (Berlin, 1892); Hormayr, *Lebensbilder aus den Befreiungskriegen* (Jena, 1841); Pick, *Aus dem brieflichen Nachlass Gneisenaus*; also the histories of the campaigns of 1807 and 1813-15.

GNEISS, a term long used by the miners of the Harz Mountains to designate the country rock in which the mineral veins occur; it is believed to be a word of Slavonic origin meaning "rotted" or "decomposed." It has gradually passed into acceptance as a generic term signifying a large and varied series of metamorphic rocks, which mostly consist of quartz and feldspar (orthoclase and plagioclase) with muscovite and biotite, hornblende or augite, iron oxides, zircon and apatite. There is also a long list of accessory minerals which are present in gneisses with more or less frequency, but not invariably, as garnet, sillimanite, cordierite, graphite and graphitoid, epidote, calcite, orthite, tourmaline and andalusite. The gneisses all possess a more or less marked parallel structure or foliation, which is the main feature by which many of them are separated from the granites, a group of rocks having nearly the same mineralogical composition and closely allied to many gneisses.

The feldspars of the gneisses are predominantly orthoclase (often perthitic), but microcline is common in the more acid types and oligoclase occurs also very frequently, especially in certain sedimentary gneisses, while more basic varieties of plagioclase are rare. Quartz is very seldom absent and may be blue or milky and opalescent. Muscovite and biotite may both occur in the same rock; in other cases only one of them is present. The commonest and most important types of gneiss are the mica-gneisses. Hornblende is green, rarely brownish; augite pale green or nearly colourless; enstatite appears in some granulite-gneisses. Epidote, often with enclosures of orthite, is by no means rare in gneisses from many different parts of the world. Sillimanite and andalusite are not infrequent ingredients of gneiss, and their presence has been accounted for in more than one way. Cordierite-gneisses are a special group of great interest and possessing many peculiarities; they are partly, if not entirely, foliated contact-altered sedimentary rocks. Kyanite and staurolite may also be mentioned as occasionally occurring.

Many varieties of gneiss have received specific names according to the minerals they consist of and the structural peculiarities they exhibit. Muscovite-gneiss, biotite-gneiss and muscovite-biotite-gneiss, more common perhaps than all the others taken together, are grey or pinkish rocks according to the colour of their prevalent feldspar, not unlike granites, but on the whole more often fine-grained (though coarse-grained types occur) and possessing a gneissose or foliated structure. The latter consists in the arrangement of the flakes of mica in such a way that their faces are parallel, and hence the rock has the property of splitting more readily in the direction in which the mica plates are disposed. This fissility, though usually marked, is not so great as in the schists or slates, and the split faces are not so smooth as in these latter rocks. The films of mica may be continuous and are usually not flat, but irregularly curved. In some gneisses the parallel flakes of mica are scattered through the quartz and feldspar; in others these minerals form discrete bands, the quartz and feldspar being grouped into lentilles separated by thin films of mica. When large feldspars, of rounded or elliptical form, are visible in the gneiss, it is said to have augen structure (Ger. *Augen* = eyes). It should also be remarked that the essential component minerals of the rocks of this family are practically always determinable by naked eye inspection or with the aid of a simple lens. If the rock is too fine grained for this it is generally relegated to the schists. When the bands of folia are very fine and tortuous the structure is called helicitic.

In mica-gneisses sillimanite, kyanite, andalusite and garnet may occur. The significance of these minerals is variously interpreted; they may indicate that the gneiss consists wholly or in part of sedimentary material which has been contact-altered, but they have also been regarded as having been developed by metamorphic action out of biotite or other primary ingredients of the rock.

Hornblende-gneisses are usually darker in colour and less fissile than mica-gneisses; they contain more plagioclase, less orthoclase and microcline, and more sphene and epidote. Many of them are rich in hornblende and thus form transitions to amphibolites. Pyroxene-gneisses are less frequent but occur in many parts of both hemispheres. The "charnockite" series are very closely allied to the pyroxene-gneisses. Hypersthene and scapolite both may occur in these rocks and they are sometimes garnetiferous.

In every country where the lowest and oldest rocks have come to the surface and been exposed by the long continued action of denudation in stripping away the overlying formations, gneisses are found in great abundance and of many different kinds. They are in fact the typical rocks of the Archean (Lewisian, Laurentian, &c.) series. In the Alps, Harz, Scotland, Norway and Sweden, Canada, South America, Peninsular India, Himalayas (to mention only a few localities) they occupy wide areas and exhibit a rich diversity of types. From this it has been inferred that they are of great geological age, and in fact this can be definitely proved in many cases, for the oldest known fossiliferous formations may be seen to rest unconformably on these gneisses and are made up of their débris. It was for a long time believed that they represented the primitive crust of the earth, and while this is no longer generally taught there are still geologists who hold that these gneisses are necessarily of pre-Cambrian age. Others, while admitting the general truth of this hypothesis, consider that there are localities in which typical gneisses can be shown to penetrate into rocks which may be as recent as the Tertiary period, or to pass into these rocks so gradually and in such a way as to make it certain that the gneisses are merely altered states of comparatively recent sedimentary or igneous rocks. Much controversy has arisen on these points; but this is certain, that gneisses are far the most common among Archean rocks, and where their age is not known the presumption is strong that they are at least pre-Cambrian.

Many gneisses are undoubtedly sedimentary rocks that have been brought to their present state by such agents of metamorphism as heat, movement, crushing, and recrystallization. This may be demonstrated partly by their mode of occurrence: they accompany limestones, graphitic schists, quartzites and other rocks of sedimentary type; some of them where least altered may even show remains of bedding or of original pebbly character (conglomerate gneisses). More conclusive, however, is the chemical composition of these rocks, which often is such as no igneous masses possess, but resembles that of many impure argillaceous sediments. These sedimentary gneisses (or paragneisses, as they are often called) are often rich in biotite and garnet and may contain kyanite and sillimanite, or less frequently calcite. Some of them, however, are rich in feldspar and quartz, with muscovite and biotite; others may even contain hornblende and augite, and all these may bear so close a resemblance to gneisses of igneous origin that by no single character, chemical or mineralogical, can their original nature be definitely established. In these cases, however, a careful study of the relations of the rock in the field and of the different types which occur together will generally lead to some positive conclusion.

Other gneisses are igneous (orthogneisses). These have very much the same composition as acid igneous rocks such as granite, aplite, hornblende granite, or intermediate rocks such as syenite and quartz diorite. Many of these orthogneisses are not equally well foliated throughout, but are massive or granitoid in places. They are sometimes subdivided into granite gneiss, diorite gneiss, syenite gneiss and so on. The sedimentary schists into which these rocks have been intruded may show contact alteration by the development of such minerals as cordierite, andalusite and sillimanite. In many of these orthogneisses the foliation is primitive, being an original character of the rock which was produced either by fluxion movements in a highly viscous, semi-solid mass injected at great pressure into the surrounding strata, or by folding stresses acting immediately after consolidation. That the foliation in other orthogneisses is subsequent or superinduced, having been occasioned by pressure and deformation of the solid mass long after it had consolidated and cooled, admits of no doubt, but it is very difficult to establish criteria by which these types may be differentiated. Those gneisses in which the minerals have been crushed and broken by fluxion or injection movements have been called protoclasic, while those which have attained their gneissose state by crushing long after consolidation are distinguished as cataclastic. There are also many examples of gneisses of mixed or synthetic origin. They may be metamorphosed sediments (granulites and schists) into which tongues and thin veins of granitic character have been intruded, following the more or less parallel foliation planes already present in the country rock. These veins produce that alternation in mineral composition and banded structure which are essential in gneisses. This intermixture of igneous and sedimentary material may take place on the finest scale and in the most intricate manner. Often there has been resorption of the older rocks, whether sedimentary or igneous, by those which have invaded them, and movement has gone on both during injection and at a later period, so that the whole complex becomes amalgamated

and its elements are so completely confused that the geologist can no longer disentangle them.

When we remember that in the earlier stages of the earth's history, to which most gneisses belong, and in the relatively deep parts of the earth's crust, where they usually occur, there has been most igneous injection and greatest frequency of earth movements, it is not difficult to understand the geological distribution of gneissose rocks. All the factors which are required for their production, heat, movement, plutonic intrusions, contact alteration, interstitial moisture at high temperatures, are found at great depths and have acted most frequently and with greatest power on the older rock masses. But locally, where the conditions were favourable, the same processes may have gone on in comparatively recent times. Hence, though most gneisses are Archean, all gneisses are not necessarily so. (J. S. F.)

GNEIST, HEINRICH RUDOLF HERMANN FRIEDRICH VON (1816-1895), German jurist and politician, was born at Berlin on the 13th of August 1816, the son of a judge attached to the "Kammergericht" (court of appeal) in that city. After receiving his school education at the gymnasium at Eisleben in Prussian Saxony, he entered the university of Berlin in 1833 as a student of jurisprudence, and became a pupil of the famous Roman law teacher von Savigny. Proceeding to the degree of *doctor juris* in 1838, young Gneist immediately established himself as a *Privatdozent* in the faculty of law. He had, however, already chosen the judicial branch of the legal profession as a career, and having while yet a student acted as *Ausscultator*, was admitted *Assessor* in 1841. He soon found leisure and opportunity to fulfil a much-cherished wish, and spent the next few years on a lengthened tour in Italy, France and England. He utilized his *Wanderjahre* for the purposes of comparative study, and on his return in 1844 was appointed extraordinary professor of Roman law in Berlin university, and thus began a professorial connexion which ended only with his death. The first-fruits of his activity as a teacher were seen in his brilliant work, *Die formellen Verträge des heutigen römischen Obligationen-Rechtes* (Berlin, 1845). *Pari passu* with his academic labours he continued his judicial career, and became in due course successively assistant judge of the superior court and of the supreme tribunal. But to a mind constituted such as his, the want of elasticity in the procedure of the courts was galling. "Brought up," he tells, in the preface to his *Englische Verfassungsgeschichte*, "in the laborious and rigid school of Prussian judges, at a time when the duty of formulating the matter in litigation was entailed upon the judge who personally conducted the pleadings, I became acquainted both with the advantages possessed by the Prussian bureau system as also with its weak points." Feeling the necessity for fundamental reforms in legal procedure, he published, in 1849, his *Trial by Jury*, in which, after pointing out that the origin of that institution was common to both Germany and England, and showing in a masterly way the benefits which had accrued to the latter country through its more extended application, he pleaded for its freer admission in the tribunals of his own country.

The period of "storm and stress" in 1848 afforded Gneist an opportunity for which he had yearned, and he threw himself with ardour into the constitutional struggles of Prussia. Although his candidature for election to the National Assembly of that year was unsuccessful, he felt that "the die was cast," and deciding for a political career, retired in 1850 from his judicial position. Entering the ranks of the National Liberal party, he began both in writing and speeches actively to champion their cause, now busying himself pre-eminently with the study of constitutional law and history. In 1853 appeared his *Adel und Ritterschaft in England*, and in 1857 the *Geschichte und heutige Gestalt der Ämter in England*, a pamphlet primarily written to combat the Prussian abuses of administration, but for which the author also claimed that it had not been without its effect in modifying certain views that had until then ruled in England itself. In 1858 Gneist was appointed ordinary professor of Roman law, and in the same year commenced his parliamentary career by his election for Stettin to the Abgeordnetenhaus (House of Deputies) of the Prussian Landtag, in which assembly he sat thenceforward uninterruptedly until 1893.

Joining the Left, he at once became one of its leading spokesmen. His chief oratorical triumphs are associated with the early period of his membership of the House; two noteworthy occasions being his violent attack (September 1862) upon the government budget in connexion with the reorganisation of the Prussian army, and his defence (1864) of the Polish chiefs of the (then) grand-duchy of Posen, who were accused of high treason. In 1857-1863 was published *Das heutige englische Verfassungs- und Verwaltungsrecht*, a work which, contrasting English and German constitutional law and administration, aimed at exercising political pressure upon the government of the day. In 1868 Gneist became a member of the North German parliament, and acted as a member of the commission for organizing the federal army, and also of that for the settlement of ecclesiastical controversial questions. On the establishment of German unity his mandate was renewed for the Reichstag, and in this he sat, an active and prominent member of the National Liberal party, until 1884. In the Kulturkampf he sided with the government against the attacks of the Clericals, whom he bitterly denounced, and whose implacable enemy he ever showed himself. In 1879, together with his colleague, von Hänel, he violently attacked the motion for the prosecution of certain Socialist members, which as a result of the vigour of his opposition was almost unanimously rejected. He was parliamentary reporter for the committees on all great financial and administrative questions, and his profound acquaintance with constitutional law caused his advice to be frequently sought, not only in his own but also in other countries. In Prussia he largely influenced legislation, the reform of the judicial and penal systems and the new constitution of the Evangelical Church being largely his work. He was also consulted by the Japanese government when a constitution was being introduced into that country. In 1875 he was appointed a member of the supreme administrative court (*Oberverwaltungsgericht*) of Prussia, but only held office for two years. In 1882 was published his *Englische Verfassungsgeschichte* (trans. *History of the English Constitution*, London, 1886), which may perhaps be described as his *magnum opus*. It placed the author at once on the level of such writers on English constitutional history as Hallam and Stubbs, and supplied English literature with a text-book almost unrivalled in point of historical research. In 1888 one of the first acts of the ill-fated emperor Frederick III., who had always, as crown prince, shown great admiration for him, was to ennoble Gneist, and attach him as instructor in constitutional law to his son, the emperor William II., a charge of which he worthily acquitted himself. The last years of his life were full of energy, and, in the possession of all his faculties, he continued his wonted academic labours until a short time before his death, which occurred at Berlin on the 22nd of July 1895.

As a politician, Gneist's career cannot perhaps be said to have been entirely successful. In a country where parliamentary institutions are the living exponents of the popular will he might have risen to a foremost position in the state; as it was, the party to which he allied himself could never hope to become more than what it remained, a parliamentary faction, and the influence it for a time wielded in the counsels of the state waned as soon as the Social-Democratic party grew to be a force to be reckoned with. It is as a writer and a teacher that Gneist is best known to fame. He was a jurist of a special type. To him law was not mere theory, but living force; and this conception of its power animates all his schemes of practical reform. As a teacher he exercised a magnetic influence, not only by reason of the clearness and cogency of his exposition, but also because of the success with which he developed the talents and guided the aspirations of his pupils. He was a man of noble bearing, religious, and imbued with a stern sense of duty. He was proud of being a "Preussischer Junker" (a member of the Prussian squirearchy), and throughout his writings, despite their liberal tendencies, may be perceived the loyalty and affection with which he clung to monarchical institutions. A great admirer and a true friend of England, to which country he was attached by many personal ties, he surpassed all other Germans in his efforts to

make her free institutions, in which he found his ideal, the common heritage of the two great nations of the Teutonic race.

Gneist was a prolific writer, especially on the subject he had made peculiarly his own, that of constitutional law and history, and among his works, other than those above named, may be mentioned the following: *Budget und Gesetz nach dem constitutionellen Staatsrecht Englands* (Berlin, 1867); *Freie Advocatur* (ib., 1867); *Der Rechtsstaat* (ib., 1872, and 2nd edition, 1879); *Zur Verwaltungsreform in Preussen* (Leipzig, 1880); *Das englische Parlament* (Berlin, 1886); in English translation, *The English Parliament* (London, 1886; 3rd edition, 1889); *Die Militär-Vorlage von 1862 und der preussische Verfassungskonflikt von 1862 bis 1866* (Berlin, 1893); *Die nationale Verfassung von den Ständen und das preussische Dreiklassenwahl-system* (ib., 1895); *Die verfassungsmässige Stellung des preussischen Gesamtministeriums* (ib., 1895). See O. Gierke, *Rudolph von Gneist, Gedächtnisrede* (Berlin, 1895), an In Memoriam address delivered in Berlin. (P. A. A.)

GNESEN (Polish, *Gniezno*), a town of Germany, in the Prussian province of Posen, in an undulating and fertile country, on the Wrzesnia, 30 m. E.N.E. of Posen by the railway to Thorn. Pop. (1905) 23,727. Besides the cathedral, a handsome Gothic edifice with twin towers, which contains the remains of St Adalbert, there are eight Roman Catholic churches, a Protestant church, a synagogue, a clerical seminary and a convent of the Franciscan nuns. Among the industries are cloth and linen weaving, brewing and distilling. A great horse and cattle market is held here annually. Gnesen is one of the oldest towns in the former kingdom of Poland. Its name, *Gniezno*, signifies "nest," and points to early Polish traditions. The cathedral is believed to have been founded towards the close of the 9th century, and, having received the bones of St Adalbert, it was visited in 1000 by the emperor Otto III., who made it the seat of an archbishop. Here, until 1320, the kings of Poland were crowned; and the archbishop, since 1416 primate of Poland, acted as protector pending the appointment of a new king. In 1821 the see of Posen was founded and the archbishop removed his residence thither, though its cathedral chapter still remains at Gnesen. After a long period of decay the town revived after 1815, when it came under the rule of Prussia.

See S. Karwowski, *Gniezno* (Posen, 1892).

GNOME, AND GNOMIC POETRY. Sententious maxims, put into verse for the better aid of the memory, were known by the Greeks as *gnomes*, γνῶμαι, from γνῶμαι, an opinion. A *gnome* is defined by the Elizabethan critic Henry Peacham (1576-1643?) as "a saying pertaining to the manners and common practices of men, which declareth, with an apt brevity, what in this our life ought to be done, or not done." The Gnostic Poets of Greece, who flourished in the 6th century B.C., were those who arranged series of sententious maxims in verse. These were collected in the 4th century, by Lobon of Argos, an orator, but his collection has disappeared. The chief gnostic poets were Theognis, Solon, Phocylides, Simonides of Amorgos, Demodocus, Xenophanes and Euenus. With the exception of Theognis, whose *gnomes* were fortunately preserved by some schoolmaster about 300 B.C., only fragments of the Gnostic Poets have come down to us. The moral poem attributed to Phocylides, long supposed to be a masterpiece of the school, is now known to have been written by a Jew in Alexandria. Of the gnostic movement typified by the moral works of the poets named above, Prof. Gilbert Murray has remarked that it receives its special expression in the conception of the Seven Wise Men, to whom such proverbs as "Know thyself" and "Nothing too much" were popularly attributed, and whose names differed in different lists. These *gnomes* or *maxims* were extended and put into literary shape by the poets. Fragments of Solon, Euenus and Mimnermus have been preserved, in a very confused state, from having been written, for purposes of comparison, on the margins of the MSS. of Theognis, whence they have often slipped into the text of that poet. Theognis enshrines his moral precepts in his elegies, and this was probably the custom of the rest; it is improbable that there ever existed a species of poetry made up entirely of successive *gnomes*. But the title "gnomic" came to be given to all poetry which dealt in a sententious way with questions

of ethics. It was, unquestionably, the source from which moral philosophy was directly developed, and theorists upon life and infinity, such as Pythagoras and Xenophanes, seem to have begun their career as gnomic poets. By the very nature of things, gnomes, in their literary sense, belong exclusively to the dawn of literature; their naïveté and their simplicity in moralizing betray it. But it has been observed that many of the ethical reflections of the great dramatists, and in particular of Sophocles and Euripides, are gnomic distiches expanded. It would be an error to suppose that the ancient Greek gnomes are all of a solemn character; some are voluptuous and some chivalrous; those of Demodocus of Leros had the reputation of being droll. In modern times, the gnomic spirit has occasionally been displayed by poets of a homely philosophy, such as Francis Quarles (1592-1644) in England and Gui de Pibrac (1529-1584) in France. The once-celebrated *Quatrains* of the latter, published in 1574, enjoyed an immense success throughout Europe; they were composed in deliberate imitation of the Greek gnomic writers of the 6th century B.C. These modern effusions are rarely literature and perhaps never poetry. With the gnomic writings of Pibrac it was long customary to bind up those of Antoine Favre (or Faber) (1557-1624) and of Pierre Mathieu (1563-1621). Gnomes are frequently to be found in the ancient literatures of Arabia, Persia and India, and in the Icelandic staves. The *primæ*, a brief, sententious kind of poem, which was in favour in Germany from the 12th to the 16th century, belonged to the true gnomic class, and was cultivated with particular success by Hans Rosenblut, the lyrical goldsmith of Nuremberg, in the 15th century. (E. G.)

GNOMES (Fr. *gnomes*, Ger. *Gnomen*), in folk-lore, the name now commonly given to the earth and mountain spirits who are supposed to watch over veins of precious metals and other hidden treasures. They are usually pictured as bearded dwarfs clad in brown close-fitting garments with hoods. The word "gnome" as applied to these is of comparatively modern and somewhat uncertain origin. By some it is said to have been coined by Paracelsus (so Hatzfeld and Darmesteter, *Dictionnaire*), who uses *Gnomi* as a synonym of *Pygmaei*, from the Greek γνῶμη, intelligence. The *New English Dictionary*, however, suggests a derivation from *gnomus*, i.e. a Greek type γηρύμιος, "earth-dweller," on the analogy of θαλασσοβόμιος, "dwelling in the sea," adding, however, that though there is no evidence that the term was not used before Paracelsus, it is possibly "a mere arbitrary invention, like so many others found in Paracelsus" (*N.E.D.* s.v.).

GNOMON, the Greek word for the style of a sundial, or any object, commonly a vertical column, the shadow of which was observed in former times in order to learn the altitude of the sun, especially when on the meridian. The art of constructing a sundial is sometimes termed *gnomonics*. In geometry, a gnomon is a plane figure formed by removing a parallelogram from a corner of a larger parallelogram; in the figure ABCDEFA is a gnomon. Gnomonic projection is a projection of a sphere in which the centre of sight is the centre of the sphere.

GNOSTICISM (Gr. γνῶσις, knowledge), the name generally applied to that spiritual movement existing side by side with genuine Christianity, as it gradually crystallized into the old Catholic Church, which may roughly be defined as a distinct religious syncretism bearing the strong impress of Christian influences.

I. The term "Gnosis" first appears in a technical sense in 1 Tim. vi. 20 (ἢ ψευδῶν γνῶσις). It seems to have at first been applied exclusively, or at any rate principally, to a particular tendency within the movement as a whole, i.e. to those sections of (the Syrian) Gnostics otherwise generally known as Ophites or Naaseni (see Hippolytus, *Philosophumena*, v. 2: Ναασσηνοὶ οὐ ταυτοῦ Γνωστικῶν ἀποκαλοῦντες; Irenæus i. 11. 1; Epiphanius, *Haeres.* xxvi. Cf. also the self-assumed name of the Carpocratians, Iren. i. 25. 6). But in Irenæus the term has already come to designate the whole movement. This first came

into prominence in the opening decades of the 2nd century A.D., but is certainly older; it reached its height in the second third of the same century, and began to wane about the 3rd century, and from the second half of the 3rd century onwards was replaced by the closely-related and more powerful Manichaean movement. Offshoots of it, however, continued on into the 4th and 5th centuries. Epiphanius still had the opportunity of making personal acquaintance with Gnostic sects.

II. Of the actual writings of the Gnostics, which were extraordinarily numerous,¹ very little has survived; they were sacrificed to the destructive zeal of their ecclesiastical opponents. Numerous fragments and extracts from Gnostic writings are to be found in the works of the Fathers who attacked Gnosticism. Most valuable of all are the long extracts in the 5th and 6th books of the *Philosophumena* of Hippolytus. The most accessible and best critical edition of the fragments which have been preserved word for word is to be found in Hilgenfeld's *Ketzergeschichte des Urchristentums*. One of the most important of these fragments is the letter of Ptolemaeus to Flora, preserved in Epiphanius, *Haeres.* xxxiii. 3-7 (see on this point Harnack in the *Sitzungsberichte der Berliner Akademie*, 1902, pp. 507-545). Gnostic fragments are certainly also preserved for us in the *Acts of Thomas*. Here we should especially mention the beautiful and much-discussed *Song of the Pearl*, or *Song of the Soul*, which is generally, though without absolute clear proof, attributed to the Gnostic Bardesanes (till lately it was known only in the Syrian text; edited and translated by Bevan, *Texts and Studies*,² v. 3, 1897; Hofmann, *Zeitschrift für neuestamentliche Wissenschaft*, iv.; for the newly-found Greek text see *Acta apostolorum*, ed. Bonnet, ii. 2, c. 108, p. 219). Generally also much Gnostic matter is contained in the apocryphal histories of the Apostles. To the school of Bardesanes belongs the "Book of the Laws of the Lands," which does not, however, contribute much to our knowledge of Gnosticism. Finally, we should mention in this connexion the text on which are based the pseudo-Clementine *Homilies* and *Recognitions* (beginning of the 3rd century). It is, of course, already permeated with the Catholic spirit, but has drawn so largely upon sources of a Judæo-Christian Gnostic character that it comes to a great extent within the category of sources for Gnosticism. Complete original Gnostic works have unfortunately survived to us only from the period of the decadence of Gnosticism. Of these we should mention the comprehensive work called the *Pistis-Sophia*, probably belonging to the second half of the 3rd century.³ Further, the Coptic-Gnostic texts of the *Codes Brucianus*; both the books of Ieu, and an anonymous third work (edited and translated by C. Schmidt, *Texte und Untersuchungen*, vol. viii., 1892; and a new translation by the same in *Koptische-gnostische Schriften*, i.) which, contrary to the opinion of their editor and translator, the present writer believes to represent, in their existing form, a still later period and a still more advanced stage in the decadence of Gnosticism. For other and older Coptic-Gnostic texts, in one of which is contained the source of Irenæus's treatises on the Barbelognostics, but which have unfortunately not yet been made completely accessible, see C. Schmidt in *Sitzungsberichte der Berl. Akad.* (1896), p. 839 seq., and "Philotesia," dedicated to Paul Kleinert (1907), p. 315 seq.

On the whole, then, for an exposition of Gnosticism we are thrown back upon the polemical writings of the Fathers in their controversy with heresy. The most ancient of these is Justin, who according to his *Apol.* i. 26 wrote a *Synlogma* against all heresies (c. A.D. 150), and also, probably, a special polemic against

¹ See the list of their titles in A. Harnack, *Geschichte der altchristlichen Literatur*, Teil I. v. 171; ib. Teil II. *Chronologie der altchristl. Literatur*, i. 533 seq.; also Liechtenhahn, *Die Offenbarung im Gnosticismus* (1901).

² For the text see A. Merz, *Bardesanes von Edessa* (1863), and A. Hilgenfeld, *Bardesanes der letzte Gnostiker* (1864).

³ Ed. Petermann-Schwartz; newly translated by C. Schmidt, *Koptisch-gnostische Schriften*, i. (1905), in the series *Die griechischen christlichen Schriftsteller der ersten drei Jahrhunderte*; see also A. Harnack, *Texte und Untersuchungen*, Bd. vii. Heft 2 (1891), and *Chronologie der altchristlichen Literatur*, ii. 193-195.

Marcion (fragment in Irenaeus iv. 6. 2). Both these writings are lost. He was followed by Irenaeus, who, especially in the first book of his treatise *Adversus haereses* (ἁγίου καὶ ἀναρτοῦ τῆς ψευδοκωμίου γράμματα βιβλία πέντε, c. A. D. 180), gives a detailed account of the Gnostic heresies. He finds his work upon that of his master Justin, but adds from his own knowledge among many other things, notably the detailed account of Valentinianism at the beginning of the book. On Irenaeus, and probably also on Justin, Hippolytus drew for his *Synagoga* (beginning of the 3rd century), a work which is also lost, but can, with great certainty, be reconstructed from three recensions of it: in the *Panarion* of Epiphanius (after 374), in Philaster of Brescia, *Adversus haereses*, and the Pseudo-Tertullian, *Liber adversus omnes haereses*. A second work of Hippolytus (Κατὰ πρῶτον αἰθιῶν ἁγίου Δερχος) is preserved in the so-called *Philosophumena* which survives under the name of Origen. Here Hippolytus gave a second exposition supplemented by fresh Gnostic original sources with which he had become acquainted in the meanwhile. These sources quoted in Hippolytus have lately met with very unfavourable criticisms. The opinion has been advanced that Hippolytus has here fallen a victim to the mystification of a forger. The truth of the matter must be that Hippolytus probably made use of a collection of Gnostic texts, put together by a Gnostic, in which were already represented various secondary developments of the genuine Gnostic schools. It is also possible that the compiler has himself attempted here and there to harmonize to a certain extent the various Gnostic doctrines, yet in no case is this collection of sources given by Hippolytus to be passed over; it should rather be considered as important evidence for the beginnings of the decay of Gnosticism. Very noteworthy references to Gnosticism are also to be found scattered up and down the *Stromateis* of Clement of Alexandria. Especially important are the *Excerpta ex Theodoto*, the author of which is certainly Clement, which are verbally extracted from Gnostic writings, and have almost the value of original sources. The writings of Origen also contain a wealth of material. In the first place should be mentioned the treatise *Contra Celsum*, in which the expositions of Gnosticism by both Origen and Celsus are of interest (see especially v. 61 seq. and vi. 25 seq.). Of Tertullian's works should be mentioned: *De praescriptione haereticorum*, especially *Adversus Marcionem*, *Adversus Hermogenem*, and finally *Adversus Valentinianum* (entirely founded on Irenaeus). Here must also be mentioned the dialogue of Adamantius with the Gnostics, *De recta in deum fide* (beginning of 4th century). Among the followers of Hippolytus, Epiphanius in his *Panarion* gives much independent and valuable information from his own knowledge of contemporary Gnosticism. But Theodoret of Cyrus (d. 455) is already entirely dependent on previous works and has nothing new to add. With the 4th century both Gnosticism and the polemical literature directed against it die out.¹

III. If we wish to grasp the peculiar character of the great Gnostic movement, we must take care not to be led astray by the catchword "Gnosis." It is a mistake to regard the Gnostics as pre-eminently the representatives of intellect among Christians, and Gnosticism as an intellectual tendency chiefly concerned with philosophical speculation, the reconciliation of religion with philosophy and theology. It is true that when Gnosticism was at its height it numbered amongst its followers both theologians and men of science, but that is not its main characteristic. Among the majority of the followers of the movement "Gnosis" was understood not as meaning "knowledge" or "understanding," in our sense of the word, but "revelation." These little Gnostic sects and groups all lived in the conviction that they

possessed a secret and mysterious knowledge, in no way accessible to those outside, which was not to be proved or propagated, but believed in by the initiated, and anxiously guarded as a secret. This knowledge of theirs was not based on reflection, on scientific inquiry and proof, but on revelation. It was derived directly from the times of primitive Christianity; from the Saviour himself and his disciples and friends, with whom they claimed to be connected by a secret tradition, or else from later prophets, of whom many sects boasted. It was laid down in wonderful mystic writings, which were in the possession of the various circles (Lichtenhahn, *Die Offenbarung im Gnosticismus*, 1901).

In short, Gnosticism, in all its various sections, its form and its character, falls under the great category of mystic religions, which were so characteristic of the religious life of decadent antiquity. In Gnosticism as in the other mystic religions we find the same contrast of the initiated and the uninitiated, the same loose organization, the same kind of petty sectarianism and mystery-mongering. All alike boast a mystic revelation and a deeply-veiled wisdom. As in many mystical religions, so in Gnosticism, the ultimate object is individual salvation, the assurance of a fortunate destiny for the soul after death. As in the others, so in this the central object of worship is a redeemer-deity who has already trodden the difficult way which the faithful have to follow. And finally, as in all mystical religions, so here too, holy rites and formulas, acts of initiation and consecration, all those things which we call sacraments, play a very prominent part. The Gnostic religion is full of such sacraments. In the accounts of the Fathers we find less about them; yet here Irenaeus' account of the Marcosians is of the highest significance (i. 21 seq.). Much more material is to be found in the original Gnostic writings, especially in the *Pistis-Sophis* and the two books of Ieu, and again in the *Excerpta ex Theodoto*, the *Acts of Thomas*, and here and there also in the pseudo-Clementine writings. Above all we can see from the original sources of the Mandaean religion, which also represents a branch of Gnosticism, how great a part the sacraments played in the Gnostic sects (Brandt, *Mandäische Religion*, p. 96 seq.). Everywhere we are met with the most varied forms of holy rites—the various baptisms, by water, by fire, by the spirit, the baptism for protection against demons, anointing with oil, sealing and stigmatizing, piercing the ears, leading into the bridal chamber, partaking of holy food and drink. Finally, sacred formulas, names and symbols are of the highest importance among the Gnostic sects. We constantly meet with the idea that the soul, on leaving the body, finds its path to the highest heaven opposed by the deities and demons of the lower realms of heaven, and only when it is in possession of the names of these demons, and can repeat the proper holy formula, or is prepared with the right symbol, or has been anointed with the holy oil, finds its way unhindered to the heavenly home. Hence the Gnostic must above all things learn the names of the demons, and equip himself with the sacred formulas and symbols, in order to be certain of a good destiny after death. The exposition of the system of the Ophites given by Celsus (in Origen vi. 25 seq.), and, in connexion with Celsus, by Origen, is particularly instructive on this point. The two "Coptic Ieu" books unfold an immense system of names and symbols. This system again was simplified, and as the supreme secret was taught in a single name or a single formula, by means of which the happy possessor was able to penetrate through all the spaces of heaven (cf. the name "Caulacau" among the Basilidians; Irenaeus, *Adv. haer.* i. 24. 5, and among other sects). It was taught that even the redeemer-god, when he once descended on to this earth, to rise from it again, availed himself of these names and formulas on his descent and ascent through the world of demons. Traces of ideas of this kind are to be met with almost everywhere. They have been most carefully collected by Anz (*Ursprung des Gnosticismus, Texte und Untersuchungen xv. 4 passim*) who would see in them the central doctrine of Gnosticism.

IV. All these investigations point clearly to the fact that Gnosticism belongs to the group of mystical religions. We must

¹ See R. A. Lipsius, *Die Quellen der ältesten Ketzergeschichte* (1875); A. Harnack, *Zur Quellenkritik der Geschichte des Gnosticismus* (1873); A. Hilgenfeld, *Ketzergeschichte*, pp. 1-83; Harnack, *Geschichte der altchristlichen Literatur*, i. 171 seq., ii. 533 seq., 712 seq.; J. Kunze, *De historiae Gnostice fontibus* (1894). On the *Philosophumena* of Hippolytus see G. Salmon, the cross-references in the *Philosophumena*, *Hermathena*, vol. xi. (1885) p. 538o seq.; H. Staehelin, *Die gnostischen Quellen Hippolyts, Texte und Unters.* Bd. vi. Hft. 3 (1890).

now proceed to define more exactly the peculiar and distinctive character of the Gnostic system. The basis of the Gnostic religion and world-philosophy lies in a decided Oriental dualism. In sharp contrast are opposed the two worlds of the good and of the evil, the divine world and the material world (ὁλν), the worlds of light and of darkness. In many systems there seems to be no attempt to derive the one world from the other. The true Basilides (*q.v.*), perhaps also Satornil, Marcion and a part of his disciples, Bardesanes and others, were frankly dualists. In the case of other systems, owing to the inexactness of our information, we are unable to decide; the later systems of Mandaeism and Manichaeism, so closely related to Gnosticism, are also based upon a decided dualism. And even when there is an attempt at reconciliation, it is still quite clear how strong was the original dualism which has to be overcome. Thus the Gnostic systems make great use of the idea of a fall of the Deity himself; by the fall of the Godhead into the world of matter, this matter, previously insensible, is animated into life and activity, and then arise the powers, both partly and wholly hostile, who hold sway over this world. Such figures of fallen divinities, sinking down into the world of matter are those of Sophia (*s.e.* Ahamoth) among the Gnostics (Ophites) in the narrower sense of the word, the Simoniani (the figure of Helena), the Barbelognostics, and in the system of the *Pistis-Sophia* or the Primal Man, among the Naasseni and the sect, related to them, as described by Hippolytus.¹ A further weakening of the dualism is indicated when, in the systems of the Valentinian school, the fall of Sophia takes place within the godhead, and Sophia, inflamed with love, plunges into the Bythos, the highest divinity, and when the attempt is thus made genetically to derive the lower world from the sufferings and passions of fallen divinity. Another attempt at reconciliation is set forth in the so-called "system of emanations" in which it is assumed that from the supreme divinity emanated a somewhat lesser world, from this world a second, and so on, until the divine element (of life) became so far weakened and attenuated, that the genesis of a partly, or even wholly, evil world appears both possible and comprehensible. A system of emanations of this kind, in its purest form, is set forth in the expositions coming from the school of Basilides, which are handed down by Irenaeus, while the propositions which are set forth in the *Philosophumena* of Hippolytus as being doctrines of Basilides represent a still closer approach to a monistic philosophy. Occasionally, too, there is an attempt to establish at any rate a threefold division of the world, and to assume between the worlds of light and darkness a middle world connecting the two; this is clearest among the Sethiani mentioned by Hippolytus (and *cf.* the Gnostics in Irenaeus i. 30. 1). Quite peculiar in this connexion are the accounts in Books xix. and xx. of the Clementine *Homilies*. After a preliminary examination of all possible different attempts at a solution of the problem of evil, the attempt is here made to represent the devil as an instrument of God. Christ and the devil are the two hands of God, Christ the right hand, and the devil the left, the devil having power over this world-epoch and Christ over the next. The devil here assumes very much the characteristics of the punishing and just God of the Old Testament, and the prospect is even held out of his ultimate pardon. All these efforts at reconciliation show how clearly the problem of evil was realized in these Gnostic and half-Gnostic sects, and how deeply they meditated on the subject; it was not altogether without reason that in the ranks of its opponents Gnosticism was judged to have arisen out of the question, *πότεν τὸ κακόν;*

This dualism had not its origin in Hellenic soil, neither is it related to that dualism which to a certain extent existed also in late Greek religion. For the lower and imperfect world, which in that system too is conceived and assumed, is the nebulous world of the non-existent and the formless, which is the

necessary accompaniment of that which exists, as shadow is of light.

In Gnosticism, on the contrary, the world of evil is full of active energy and hostile powers. It is an Oriental (Iranian) dualism which here finds expression, though in one point, it is true, the mark of Greek influence is quite clear. When Gnosticism recognizes in this corporeal and material world the true seat of evil, consistently treating the bodily existence of mankind as essentially evil and the separation of the spiritual from the corporeal being as the object of salvation, this is an outcome of the contrast in Greek dualism between spirit and matter, soul and body. For in Oriental (Persian) dualism it is within this material world that the good and evil-powers are at war, and this world beneath the stars is by no means conceived as entirely subject to the influence of evil. Gnosticism has combined the two, the Greek opposition between spirit and matter, and the sharp Zoroastrian dualism, which, where the Greek mind conceived of a higher and a lower world, saw instead two hostile worlds, standing in contrast to each other like light and darkness. And out of the combination of these two dualisms arose the teaching of Gnosticism, with its thoroughgoing pessimism and fundamental asceticism.

Another characteristic feature of the Gnostic conception of the universe is the rôle played in almost all Gnostic systems by the seven world-creating powers. There are indeed certain exceptions; for instance, in the systems of the Valentinian schools there is the figure of the one Demiurge who takes the place of the Seven. But how widespread was the idea of seven powers, who created this lower material world and rule over it, has been clearly proved, especially by the systematic examination of the subject by Anz (*Ursprung des Gnosticismus*). These Seven, then, are in most systems half-evil, half-hostile powers; they are frequently characterized as "angels," and are reckoned as the last and lowest emanations of the Godhead; below them—and frequently considered as derived from them—comes the world of the actually devilish powers. On the other hand, among the speculations of the Mandaeans, we find a different and perhaps more primitive conception of the Seven, according to which they, together with their mother Namrus (Rûha) and their father (Ur), belong entirely to the world of darkness. They and their family are looked upon as captives of the god of light (Mandâ-d'hayyê, Hibil-Zivâ), who pardons them, sets them on chariots of light, and appoints them as rulers of the world (*cf.* chiefly Genza, in *Tractat* 6 and 8; W. Brandt, *Mandäische Schriften*, 125 seq. and 137 seq.; *Mandäische Religion*, 34 seq. &c.). In the Manichaean system it is related how the helper of the Primal Man, the spirit of life, captured the evil *archontes*, and fastened them to the firmament, or according to another account, flayed them, and formed the firmament from their skin (F. C. Baur, *Das manichäische Religionsystem*, v. 65), and this conception is closely related to the other, though in this tradition the number (seven) of the *archontes* is lost. Similarly, the last book of the *Pistis-Sophia* contains the myth of the capture of the rebellious *archontes*, whose leaders here appear as five in number (Schmidt, *Koptisch-gnostische Schriften*, p. 234 seq.).² There can scarcely be any doubt as to the origin of these seven (five) powers; they are the seven planetary divinities, the sun, moon and five planets.

In the Mandaean speculations the Seven are introduced with the Babylonian names of the planets. The connexion of the Seven with the planets is also clearly established by the expositions of Celsus and Origen (*Contra Celsum*, vi. 22 seq.) and similarly by the above-quoted passage in the *Pistis-Sophia*, where the *archontes*, who are here mentioned as five, are identified with the five planets (excluding the sun and moon). This collective grouping of the seven (five) planetary divinities is derived from the late Babylonian religion, which can definitely be indicated as the home of these ideas (Zimmern, *Keilinschriften in dem alten Testament*, ii. p. 620 seq.; *cf.* particularly Diodorus ii. 30). And if in the old sources it is only the first beginnings of this development that can be traced, we must assume that at a later

¹ These ideas may possibly be traced still further back, and perhaps even underlie St Paul's exposition in Col. ii. 15.

¹ *Cf.* the same idea of the fall of mankind in the pagan Gnosticism of "Poimandres"; see Reitzenstein, *Poimandres* (1904); and the position of the Primal Man (*Urmensch*) among the Manichaeans is similar.

period the Babylonian religion centred in the adoration of the seven planetary deities. Very instructive in this connexion is the later (Arabian) account of the religion of the Mesopotamian Sabaeans. The religion of the Sabaeans, evidently a later offshoot from the stock of the old Babylonian religion, actually consists in the cult of the seven planets (cf. the great work of Daniel Chwolson, *Die Ssabier u. der Ssabismus*). But this reference to Babylonian religion does not solve the problem which is here in question. For in the Babylonian religion the planetary constellations are reckoned as the supreme deities. And here the question arises, how it came about that in the Gnostic systems the Seven appear as subordinate, half-daemonic powers, or even completely as powers of darkness. This can only be explained on the assumption that some religion hostile to, and stronger than the Babylonian, has superimposed itself upon this, and has degraded its principal deities into daemons. Which religion can this have been? We are at first inclined to think of Christianity itself, but it is certainly most improbable that at the time of the rise of Christianity the Babylonian teaching about the seven planet-deities governing the world should have played so great a part throughout all Syria, Asia Minor and Egypt, that the most varying sections of syncretic Christianity should over and over again adopt this doctrine and work it up into their system. It is far more probable that the combination which we meet with in Gnosticism is older than Christianity, and was found already in existence by Christianity and its sects. We must also reject the theory that this degradation of the planetary deities into daemons is due to the influence of Hebrew monotheism, for almost all the Gnostic sects take up a definitely hostile attitude towards the Jewish religion, and almost always the highest divinity among the Seven is actually the creator-God of the Old Testament. There remains, then, only one religion which can be used as an explanation, namely the Persian, which in fact fulfils all the necessary conditions. The Persian religion was at an early period brought into contact with the Babylonian, through the triumphant progress of Persian culture towards the West; at the time of Alexander the Great it was already the prevailing religion in the Babylonian plain (cf. F. Cumont, *Textes et monuments relat. aux mystères de Mithra*, I, 5, 8-10, 14, 223 seq., 233). It was characterized by a main belief, tending towards monotheism, in the Light-deity Aburamazda and his satellites, who appeared in contrast with him as powers of the nature of angels.

A combination of the Babylonian with the Persian religion could only be effected by the degradation of the Babylonian deities into half-divine, half-daemonic beings, infinitely remote from the supreme God of light and of heaven, or even into powers of darkness. Even the characteristic dualism of Gnosticism has already proved to be in part of Iranian origin; and now it becomes clear how from that mingling of late Greek and Persian dualism the idea could arise that these seven half-daemonic powers are the creators or rulers of this material world, which is separated infinitely from the light-world of the good God. Definite confirmation of this conjecture is afforded us by later sources of the Iranian religion, in which we likewise meet with the characteristic fundamental doctrine of Gnosticism. Thus the *Bundahish* (iii. 25, v. 1) is able to inform us that in the primeval strife of Satan against the light-world, seven hostile powers were captured and set as constellations in the heavens, where they are guarded by good star-powers and prevented from doing harm. Five of the evil powers are the planets, while here the sun and moon are of course not reckoned among the evil powers—for the obvious reason that in the Persian official religion they invariably appear as good divinities (cf. similar ideas in the Arabic treatise on Persian religion *Ulema-i-Islam*, Vullers, *Fragmente über die Religion Zoroasters*, p. 49, and in other later sources for Persian religion, put together in Spiegel, *Iranische Altertumskunde*, Bd. ii. p. 180). These Persian fancies can hardly be borrowed from the Christian Gnostic systems, their definiteness and much more strongly dualistic character recalling the exposition of the Mandaean (and Manichaean) system, are proofs to the contrary. They are

derived from the same period in which the underlying idea of the Gnostic systems also originated, namely, the time at which the ideas of the Persian and Babylonian religions came into contact, the remarkable results of which have thus partly found their way into the official documents of Parsism.

With this fundamental doctrine of Gnosticism is connected, as Anz has shown in his book which we have so often quoted, a side of their religious practices to which we have already alluded. Gnosticism is to a great extent dominated by the idea that it is above all and in the highest degree important for the Gnostic's soul to be enabled to find its way back through the lower worlds and spheres of heaven ruled by the Seven to the kingdom of light of the supreme deity of heaven. Hence, a principal item in their religious practice consisted in communications about the being, nature and names of the Seven (or of any other hostile daemons barring the way to heaven), the formulas with which they must be addressed, and the symbols which must be shown to them. But names, symbols and formulas are not efficacious by themselves: the Gnostic must lead a life having no part in the lower world ruled by these spirits, and by his knowledge he must raise himself above them to the God of the world of light. Throughout this mystic religious world it was above all the influence of the late Greek religion, derived from Plato, that also continued to operate; it is filled with the echo of the song, the first note of which was sounded by the Platonists, about the heavenly home of the soul and the homeward journey of the wise to the higher world of light.

But the form in which the whole is set forth is Oriental, and it must be carefully noted that the Mithras mysteries, so closely connected with the Persian religion, are acquainted with this doctrine of the ascent of the soul through the planetary spheres (Origen, *Contra Celsum*, vi. 22).

V. We cannot here undertake to set forth and explain in detail all the complex varieties of the Gnostic systems; but it will be useful to take a nearer view of certain principal figures which have had an influence upon at least one series of Gnostic systems, and to examine their origins in the history of religion. In almost all systems an important part is played by the Great Mother (*μήτηρ*) who appears under the most varied forms (cf. GREAT MOTHER OF THE GODS). At an early period, and notably in the older systems of the Ophites (a fairly exact account of which has been preserved for us by Epiphanius and Hippolytus), among the Gnostics in the narrower sense of the word, the Archontic, the Sethites (there are also traces among the Naasseni, cf. the *Philosophumena* of Hippolytus), the *μήτηρ* is the most prominent figure in the light-world, elevated above the *ἑβουάς*, and the great mother of the faithful. The sect of the Barbelognostics takes its name from the female figure of the Barbelo (perhaps a corruption of *Παρθέρος*; cf. the form *Βαρβέρως* for "virgin" in Epiphanius, *Haer.* xxvi. 1). But Gnostic speculation gives various accounts of the descent or fall of this goddess of heaven. Thus the "Helena" of the Simonian descends to this world in order by means of her beauty to provoke to sensual passion and mutual strife the angels who rule the world, and thus again to deprive them of the powers of light, stolen from heaven, by means of which they rule over the world. She is then held captive by them in extreme degradation. Similar ideas are to be found among the "Gnostics" of Epiphanius. The kindred idea of the light-maiden, who, by exciting the sensual passions of the rulers (*ἄρχοντες*), takes from them those powers of light which still remain to them, has also a central place in the Manichaean scheme of salvation (F. C. Baur, *Das manichäische Religionsystem*, pp. 210, 315, 321). The light-maiden also plays a prominent part in the *Pistis-Sophia* (cf. the index to the translation by C. Schmidt). With this figure of the mother-goddess who descends into the lower world seems to be closely connected the idea of the fallen Sophia, which is so widespread among the Gnostic systems. This Sophia then is certainly no longer the dominating figure of the light-world, she is a lower aeon at the extreme limit of the world of light, who sinks down into matter (Barbelognostics, the anonymous Gnostic of Irenaeus,

Bardesanes, *Pistis-Sophia*), or turns in presumptuous love towards the supreme God (*Bythos*), and thus brings the Fall into the world of the *aeons* (Valentinians). This Sophia then appears as the mother of the "seven" gods (see above).

The origin of this figure is not far to seek. It is certainly not derived from the Persian religious system, to the spirit of which it is entirely opposed. Neither would it be correct to identify her entirely with the great goddess Ishtar of the old Babylonian religion. But there can hardly be any doubt that the figure of the great mother-goddess or goddess of heaven, who was worshipped throughout Asia under various forms and names (Astarte, Beltis, Atargatis, Cybele, the Syrian Aphrodite), was the prototype of the *μήτηρ* of the Gnostics (cf. GREAT MOTHER OF THE GODS). The character of the great goddess of heaven is still in many places fairly exactly preserved in the Gnostic speculations. Hence we are able to understand how the Gnostic *μήτηρ*, the Sophia, appears as the mother of the Hebdomads (*ἑβδομάδες*). The great goddess of heaven is the mother of the stars. Particularly instructive in this connexion is the fact that in those very sects, in the systems of which the figure of the *μήτηρ* plays a special part, unbridled prostitution appears as a distinct and essential part of the cult (cf. the accounts of particular branches of the Gnostics, Nicolaitans, Philionites, Borborites, &c. in Epiphanius, *Haer.* xxv., xxvi.). The meaning of this cult is, of course, reinterpreted in the Gnostic sense: by this unbridled prostitution the Gnostic sects desired to prevent the sexual propagation of mankind, the origin of all evil. But the connexion is clear, and hence it also explained the curious Gnostic myth mentioned above, namely that the *μήτηρ* (the light-maiden) by appearing to the archontes (*ἀρχόντες*), the lower powers of this world, inflames them to sexual lusts, in order to take from them that share of light which they have stolen from the upper world. This is a Gnostic interpretation of the various myths of the great mother-goddess's many loves and love-adventures with other gods and heroes. And when the pagan legend of the Syrian Astarte tells how she lived for ten years in Tyre as a prostitute, this directly recalls the Gnostic myth of how Simon found Helena in a brothel in Tyre (Epiphanius, *Ancoratus*, c. 104). From the same group of myths must be derived the idea of the goddess who descends to the under-world, and is there taken prisoner against her will by the lower powers; the direct prototype of this myth is to be found, e.g. in Ishtar's journey to hell. And finally, just as the mother-goddess of south-western Asia stands in particularly intimate connexion with the youthful god of spring (Tammuz, Adonis, Attis), so we ought perhaps to compare here as a parallel the relation of Sophia with the Soter in certain Gnostic systems (see below).

Another characteristic figure of Gnosticism is that of the Primal Man (*πρώτος ἄνθρωπος*). In many systems, certainly, it has already been forced quite into the background. But on closer examination we can clearly see that it has a wide influence on Gnosticism. Thus in the system of the Naasseni (see Hippolytus, *Philosophumena*), and in certain related sects there enumerated, the Primal Man has a central and predominant position. Again, in the text on which are based the pseudo-Clementine writings (*Recognitions*, i. 26, 32, 45-47, 52, ii. 47; and *Homilies*, iii. 17 seq. xviii. 14), as in the closely related system of the Ebionites in Epiphanius (*Haer.* xxx. 3-16; cf. liii. 1), we meet with the man who existed before the world, the prophet who goes through the world in various forms, and finally reveals himself in Christ. Among the Barbelognostics (Irenaeus i. 29. 3), the Primal Man (Adamas, *homo perfectus et verus*) and Gnosis appear as a pair of *aeons*, occupying a prominent place in the whole series. In the Valentinian systems the pair of *aeons*, Anthropos and Ekklisia, occupy the third or fourth place within the *Oydoas*, but incidentally we learn that with some representatives of this school the Anthropos took a still more prominent place (first or second; Hilgenfeld, *Ketzergeschichte*, p. 294 seq.). And even in the *Pistis-Sophia* the Primal Man "Ieu" is frequently alluded to as the King of the Luminaries (cf. index to C. Schmidt's translation). We also meet with speculations of this kind about man in the circles

of non-Christian Gnosis. Thus in the *Poimandres* of Hermes man is the most prominent figure in the speculation; numerous pagan and half-pagan parallels (the "Gnostics" of Plotinus, Zosimus, Bitys) have been collected by Reitzenstein in his work *Poimandres* (pp. 81-116). Reitzenstein has shown (p. 81 seq.) that very probably the system of the Naasseni described by Hippolytus was originally derived from purely pagan circles, which are probably connected in some way with the mysteries of the Attis cult. The figure in the Mandaeen system most closely corresponding to the Primal Man, though this figure also actually occurs in another part of the system (cf. the figure of Adakas Mana; Brandt, *Mandäische Religion*, p. 36 seq.) is that of Mandā d'hayyē (*γνώσις τῆς ζωῆς*; cf. the pair of *aeons*, Adamas and Gnosis, among the Barbelognostics, in Irenaeus i. 29. 3). Finally, in the Manichean system, as is well known, the Primal Man again assumes the predominant place (Baur, *Manich. Religionssystem*, 49 seq.).

This figure of the Primal Man can particularly be compared with that of the Gnostic Sophia. Wherever this figure has not become quite obscure, it represents that divine power which, whether simply owing to a fall, or as the hero who makes war on, and is partly vanquished by darkness, descends into the darkness of the material world, and with whose descent begins the great drama of the world's development. From this power are derived those portions of light existing and held prisoner in this lower world. And as he has raised himself again out of the material world, or has been set free by higher powers, so shall also the members of the Primal Man, the portions of light still imprisoned in matter, be set free.

The question of the derivation of the myth of the Primal Man is still one of the unsolved problems of religious history. It is worthy of notice that according to the old Persian myth also, the development of the world begins with the slaying of the primal man Gayomart by Angra-Mainyu (Ahriman); further, that the Primal Man ("son of man"—man) also plays a part in Jewish apocalyptic literature (Daniel, Enoch, iv. Ezra), whence this figure passes into the Gospels; and again, that the dogma of Christ's descent into hell is directly connected with this myth. But these parallels do not carry us much further. Even the Persian myth is entirely obscure, and has hitherto defied interpretation. It is certainly true that in some way an essential part in the formation of the myth has been played by the sun-god, who daily descends into darkness, to rise from it again victoriously. But how to explain the combination of the figure of the sun-god with that of the Primal Man is an unsolved riddle. The meaning of this figure in the Gnostic speculations is, however, clear. It answers the question: how did the portions of light to be found in this lower world, among which certainly belong the souls of the Gnostics, enter into it?

A parallel myth to that of the Primal Man are the accounts to be found in most of the Gnostic systems of the creation of the first man. In all these accounts the idea is expressed that so far as his body is concerned man is the work of the angels who created the world. So e.g. Satonil relates (Irenaeus i. 24. 1) that a brilliant vision appeared from above to the world-creating angels; they were unable to hold it fast, but formed man after its image. And as the man thus formed was unable to move, but could only crawl like a worm, the supreme Power put into him a spark of life, and man came into existence. Imaginations of the same sort are also to be found, e.g. in the genuine fragments of Valentinus (Hilgenfeld, *Ketzergeschichte*, p. 293), the Gnostics of Irenaeus i. 30. 6, the Mandaeans (Brandt, *Religion der Mandäer*, p. 36), and the Manicheans (Baur, *Religionssystem*, p. 118 seq.). The Naasseni (Hippolytus, *Philosophumena*, v. 7) expressly characterize the myth as Chaldean (cf. the passage from Zosimus, in Reitzenstein's *Poimandres*, p. 104). Clearly then the question which the myth of the Primal Man is intended to answer in relation to the whole universe is answered in relation to the nature of man by this account of the coming into being of the first man, which may, moreover, have been influenced by the account in the Old Testament. That question is: how does it happen that in this

inferior body of man, fallen a prey to corruption, there dwells a higher spark of the divine Being, or in other words, how are we to explain the double nature of man?

VI. Of all the fundamental ideas of Gnosticism of which we have so far treated, it can with some certainty be assumed that they were in existence before the rise of Christianity and the influence of Christian ideas on the development of Gnosticism. The main question with which we have now to deal is that of whether the dominant figure of the Saviour (*Σωτήρ*) in Gnosticism is of specifically Christian derivation, or whether this can also be explained apart from the assumption of Christian influence. And here it must be premised that, intimately as the conception of salvation is bound up with the Gnostic religion, the idea of salvation accomplished in a definite historical moment to a certain extent remained foreign to it. Indeed, nearly all the Christian Gnostic systems clearly exhibit the great difficulty with which they had to contend in order to reconcile the idea of an historical redeemer, actually occurring in the form of a definite person, with their conceptions of salvation. In Gnosticism salvation always lies at the root of all existence and all history. The fundamental conception varies greatly. At one time the Primal Man, who sank down into matter, has freed himself and risen out of it again, and like him his members will rise out of darkness into the light (*Poimandres*); at another time the Primal Man who was conquered by the powers of darkness has been saved by the powers of light, and thus too all his race will be saved (Manichaeism); at another time the fallen Sophia is purified by her passions and sorrows and has found her *Syzygos*, the *Soter*, and wedded him, and thus all the souls of the Gnostics who still languish in matter will become the brides of the angels of the *Soter* (Valentinus). In fact salvation, as conceived in Gnosticism, is always a myth, a history of bygone events, an allegory or figure, but not an historical event. And this decision is not affected by the fact that in certain Gnostic sects figured historical personages such as Simon Magus and Menander. The Gnostic ideas of salvation were in the later schools and sects transferred to these persons whom we must consider as rather obscure charlatans and miracle-mongers, just as in other cases they were transferred to the person of Christ. The "Helena" of the Simonian system was certainly not an historical but a mythical figure. This explains the laborious and artificial way in which the person of Jesus is connected in many Gnostic systems with the original Gnostic conception of redemption. In this patchwork the joins are everywhere still clearly to be recognized. Thus, e.g. in the Valentinian system, the myth of the fallen Sophia and the *Soter*, of their ultimate union, their marriage and their 70 sons (Irenaeus i. 4. 5; Hippolytus, *Philos.* vi. 34), has absolutely nothing to do with the Christian conceptions of salvation. The subject is here that of a high goddess of heaven (she has 70 sons) whose friend and lover finds her in the misery of deepest degradation, frees her, and bears her home as his bride. To this myth the idea of salvation through the earthly Christ can only be attached with difficulty. And it was openly maintained that the *Soter* only existed for the Gnostic, the Saviour Jesus who appeared on earth only for the "Psychicus" (Irenaeus i. 6. 1).

VII. Thus the essential part of most of the conceptions of what we call Gnosticism was already in existence and fully developed before the rise of Christianity. But the fundamental ideas of Gnosticism and of early Christianity had a kind of magnetic attraction for each other. What drew these two forces together was the energy exerted by the universal idea of salvation in both systems. Christian Gnosticism actually introduced only one new figure into the already existing Gnostic theories, namely that of the historical Saviour Jesus Christ. This figure afforded, as it were, a new point of crystallization for the existing Gnostic ideas, which now grouped themselves round this point in all their manifold diversity. Thus there came into the fluctuating mass a strong movement and formative impulse, and the individual systems and sects sprang up like mushrooms from this soil.

It must now be our task to make plain the position of Gnosti-

cism within the Christian religion, and its significance for the development of the latter. Above all the Gnostics represented and developed the distinctly anti-Jewish tendency in Christianity. Paul was the apostle whom they revered, and his spiritual influence on them is quite unmistakable. The Gnostic Marcion has been rightly characterized as a direct disciple of Paul. Paul's battle against the law and the narrow national conception of Christianity found a willing following in a movement, the syncretic origin of which directed it towards a universal religion. St Paul's ideas were here developed to their extremest consequences, and in an entirely one-sided fashion such as was far from being in his intention. In nearly all the Gnostic systems the doctrine of the seven world-creating spirits is given an anti-Jewish tendency, the god of the Jews and of the Old Testament appearing as the highest of the seven. The demiurge of the Valentinians always clearly bears the features of the Old Testament creator-God.

The Old Testament was absolutely rejected by most of the Gnostics. Even the so-called Judæo-Christian Gnostics (Cerinthus), the Ebionite (Essenian) sect of the Pseudo-Clementine writings (the Elkesaites), take up an inconsistent attitude towards Jewish antiquity and the Old Testament. In this respect the opposition to Gnosticism led to a reactionary movement. If the growing Christian Church, in quite a different fashion from Paul, laid stress on the literal authority of the Old Testament, interpreted, it is true, allegorically; if it took up a much more friendly and definite attitude towards the Old Testament, and gave wider scope to the legal conception of religion, this must be in part ascribed to the involuntary reaction upon it of Gnosticism.

The attitude of Gnosticism to the Old Testament and to the creator-god proclaimed in it had its deeper roots, as we have already seen, in the dualism by which it was dominated. With this dualism and the recognition of the worthlessness and absolutely vicious nature of the material world is combined a decided spiritualism. The conception of a resurrection of the body, of a further existence for the body after death, was unattainable by almost all of the Gnostics, with the possible exception of a few Gnostic sects dominated by Judæo-Christian tendencies. With the dualistic philosophy is further connected an attitude of absolute indifference towards this lower and material world, and the practice of asceticism. Marriage and sexual propagation are considered either as absolute Evil or as altogether worthless, and carnal pleasure is frequently looked upon as forbidden. Then again asceticism sometimes changes into wild libertinism. Here again Gnosticism has exercised an influence on the development of the Church by way of contrast and opposition. If here a return was made to the old material view of the resurrection (the apostolic *ἀνάστασις τῆς σαρκός*), entirely abandoning the more spiritual conception which had been arrived at as a compromise by Paul, this is probably the result of a reaction from the views of Gnosticism. It was just at this point, too, that Gnosticism started a development which was followed later by the Catholic Church. In spite of the rejection of the ascetic attitude of the Gnostics, as a blasphemy against the Creator, a part of this ascetic principle became at a later date dominant throughout all Christendom. And it is interesting to observe how, e.g., St Augustine, though desperately combating the dualism of the Manichaeans, yet afterwards introduced a number of dualistic ideas into Christianity, which are distinguishable from those of Manichaeism only by a very keen eye, and even then with difficulty.

The Gnostic religion also anticipated other tendencies. As we have seen, it is above all things a religion of sacraments and mysteries. Through its syncretic origin Gnosticism introduced for the first time into Christianity a whole mass of sacramental, mystical ideas, which had hitherto existed in it only in its earliest phases. But in the long run even genuine Christianity has been unable to free itself from the magic of the sacraments; and the Eastern Church especially has taken the same direction as Gnosticism. Gnosticism was also the pioneer of the Christian Church in the strong emphasis laid on the idea of salvation in

religion. And since the Gnostics were compelled to draw the figure of the Saviour into a world of quite alien myths, their Christology became so complicated in character that it frequently recalls the Christology of the later dogmatic of the Greek Fathers.

Finally, it was Gnosticism which gave the most decided impulse to the consolidation of the Christian Church as a church. Gnosticism itself is a free, naturally-growing religion, the religion of isolated minds, of separate little circles and minute sects. The homogeneity of wide circles, the sense of responsibility engendered by it, and continuity with the past are almost entirely lacking in it. It is based upon revelation, which even at the present time is imparted to the individual, upon the more or less convincing force of the religious imagination and speculations of a few leaders, upon the voluntary and unstable groupings of the schools round the master. Its adherents feel themselves to be the isolated, the few, the free and the enlightened, as opposed to the sluggish and inert masses of mankind degraded into matter, or the initiated as opposed to the uninitiated, the Gnostics as opposed to the "Hylici" (ὕλιχοι); at most in the later and more moderate schools a middle place was given to the adherents of the Church as Psychici (ψυχικοί).

This freely-growing Gnostic religiosity aroused in the Church an increasingly strong movement towards unity and a firm and inelastic organization, towards authority and tradition. An organized hierarchy, a definitive canon of the Holy Scriptures, a confession of faith and rule of faith, and unbending doctrinal discipline, these were the means employed. A part was also played in this movement by a free theology which arose within the Church, itself a kind of Gnosticism which aimed at holding fast whatever was good in the Gnostic movement, and obtaining its recognition within the limits of the Church (Clement of Alexandria, Origen). But the mightiest forces, to which in the end this theology too had absolutely to give way, were outward organization and tradition.

It must be considered as an unqualified advantage for the further development of Christianity, as a universal religion, that at its very outset it prevailed against the great movement of Gnosticism. In spite of the fact that in a few of its later representatives Gnosticism assumed a more refined and spiritual aspect, and even produced blossoms of a true and beautiful piety, it is fundamentally and essentially an unstable religious syncretism, a religion in which the determining forces were a fantastic oriental imagination and a sacramentalism which degenerated into the wildest superstitions, a weak dualism fluctuating unsteadily between asceticism and libertinism. Indirectly, however, Gnosticism was certainly one of the most powerful factors in the development of Christianity in the 1st century.

VIII. This sketch may be completed by a short review of the various separate sects and their probable connexion with each other. As a point of departure for the history of the development of Gnosticism may be taken the numerous little sects which were apparently first included under the name of "Gnostics" in the narrower sense. Among these probably belong the Ophites of Celsus (in Origen), the many little sects included by Epiphanius under the name of Nicolaitans and Gnostics (*Haer.* 25, 26); the Archontici (Epiphanius, *Haer.* xl.), Sethites (Cainites) should also here be mentioned, and finally the Carpocratians. Common to all these is the dominant position assumed by the "Seven" (headed by Ialdabaoth); the heavenly world lying above the spheres of the Seven is occupied by comparatively few figures, among which the most important part is played by the *ἄνθρωπος*, who is sometimes enthroned as the supreme goddess in heaven, but in a few systems has already descended from there into matter, been taken prisoner, &c. Numerous little groups are distinguished from the mass, sometimes by one peculiarity, sometimes by another. On the one hand we have sects with a strongly ascetic tendency, on the other we find some characterized by unbridled libertinism; in some the most abandoned prostitution has come to be the most sacred mystery; in others again appears the worship of serpents, which here appears to be connected in various and often very loose ways with the other ideas of these Gnostics—hence the names of the

"Ophites," "Naasseni." To this class also fundamentally belong the Simonians, who have included the probably historical figure of Simon Magus in a system which seems to be closely connected with those we have mentioned, especially if we look upon the "Helena" of this system as a mythical figure. A particular branch of the "Gnostic" sects is represented by those systems in which the figure of Sophia sinking down into matter already appears. To these belong the Barbelognostics (in the description given by Irenaeus the figure of the Spirit takes the place of that of Sophia), and the Gnostics whom Irenaeus (i. 30) describes (cf. Epiphanius, *Haer.* xxvi.). And here may best be included Bardesanes, a famous leader of a Gnostic school of the end of the 2nd century. Most scholars, it is true, following an old tradition, reckon Bardesanes among the Valentinians. But from the little we know of Bardesanes, his system bears no trace of relationship with the complicated Valentinian system, but is rather completely derived from the ordinary Gnosticism, and is distinguished from it apparently only by its more strongly dualistic character. The systems of Valentinus and his disciples must be considered as a further development of what we have just characterized as the popular Gnosticism, and especially of that branch of it to which the figure of Sophia is already known. In them above all the world of the higher aeons is further extended and filled with a throng of varied figures. They also exhibit a variation from the characteristic dualism of Gnosticism into monism, in their conception of the fall of Sophia and their derivation of matter from the passions of the fallen Sophia. The figures of the Seven have here entirely disappeared, the remembrance of them being merely preserved in the name of the *Δημιουργός* (*ἑβδόμος*). In general, Valentinianism displays a particular resemblance to the dominant ideas of the Church, both in its complicated Christology, its triple division of mankind into *πνευματικοί*, *ψυχικοί* and *ὕλικοι*, and its far-fetched interpretation of texts.¹ A quite different position from those mentioned above is taken by Basilides (q.v.). From what little we know of him he was an uncompromising dualist. Both the systems which are handed down under his name by Irenaeus and Hippolytus, that of emanations and the monistic-evolutionary system, represent further developments of his ideas with a tendency away from dualism towards monism. Characteristically, in these Basilidian systems the figure of the "Mother" or of Sophia does not appear. This peculiarity the Basilidian system shares with that of Satornil of Antioch, which has only come down to us in a very fragmentary state, and in other respects recalls in many ways the popular Gnosticism. By itself, on the other hand, stands the system preserved for us by Hippolytus in the *Philosophumena* under the name of the Naasseni, with its central figure of "the Man," which, as we have seen, is very closely related with certain specifically pagan Gnostic speculations which have come down to us (in the *Poimandres*, in Zosimus and Plotinus, *Ennead* ii. 9). With the Naasseni, moreover, are related also the other sects of which Hippolytus alone gives us a notice in his *Philosophumena* (Docetae, Perates, Sethians, the adherents of Justin, the Gnostic of Monoimos). Finally, apart from all other Gnostics stands Marcion. With him, as far as we are able to conclude from the scanty notices of him, the manifold Gnostic speculations are reduced essentially to the one problem of the good and the just God, the God of the Christians and the God of the Old Testament. Between these two powers Marcion affirms a sharp and, as it appears, originally irreconcilable dualism which with him rests moreover on a speculative basis. Thanks to the noble simplicity and specifically religious character of his ideas, Marcion was able to found not only schools, but a community, a church of his own, which gave trouble to the Church longer than any other Gnostic sect. Among his disciples the speculative and fantastic element of Gnosticism again became more apparent. As we have already intimated, Gnosticism had such a power

¹ For the disciples of Valentinus, especially Marcus, after whom was named a separate sect, the Marcosians, with their Pythagorean theories of numbers and their strong tincture of the mystical, magic, and sacramental, see VALENTINUS AND VALENTINIANS.

of attraction that it now drew within its limits even Judæo-Christian sects. Among these we must mention the Judæo-Christian Gnostic Cerinthus, also the Gnostic Ebionites, of whom Epiphanius (*Hær.*) gives us an account, and whose writings are to be found in a recension in the collected works of the Pseudo-Clementine *Recognitions* and *Homilies*; to the same class belong the Elkesaites with their mystical scripture, the *Elzai*, extracts of which are given by Hippolytus in the *Philos.* (ix. 13). Later evidence of the decadence of Gnosticism occurs in the *Pistis-Sophia* and the Coptic Gnostic writings discovered and edited by Schmidt. In these confused records of human imagination gone mad, we possess a veritable barbarium of all possible Gnostic ideas, which were once active and now rest peacefully side by side. None the less, the stream of the Gnostic religion is not yet dried up, but continues on its way; and it is beyond a doubt that the later Mandæanism and the great religious movement of Mani are most closely connected with Gnosticism. These manifestations are all the more characteristic since in them we meet with a Gnosticism which remained essentially more untouched by Christian influences than the Gnostic systems of the 2nd century A.D. Thus these systems throw an important light on the past, and a true perception of the nature and purpose of Gnosticism is not to be obtained without taking them into consideration.

BIBLIOGRAPHY.—A. Neander, *Genetische Entwicklung d. vornehmsten gnostischen Systeme* (Berlin, 1818); F. Chr. Baur, *Die christl. Gnosis in ihrer geschichtl. Entwicklung* (Tübingen, 1835); E. W. Moller, *Gesch. der Kosmologie in der griechischen Kirche bis Origenes* (Halle, 1860); R. A. Lipsius, *Der Gnosticismus* (Leipzig, 1860; originally in Erich and Gruber's *Encyclopædie*); H. L. Mansel, *The Gnostic Heresies of the 1st and 2nd Centuries* (London, 1875); K. Kepler, *Über Gnosis und altpaläontische Religion*, a lecture delivered at the Congress of Orientalists (Berlin, 1881); A. Hilgenfeld, *Ketzergeschichte des Urchristentums* (Leipzig, 1884); and in *Zschr. für wissenschaftl. Theol.* 1890, l. "Der Gnosticismus"; A. Harnack, *Dogmengeschichte*, i. 271 seq. (cf. the corresponding sections of the *Dogmengeschichten* of Lohs and Seeberg); W. Anz, "Zur Frage nach dem Ursprung des Gnosticismus," *Texte u. Untersuchungen*, xv. 4 (Leipzig, 1897); R. Liechtenhahn, *Die Offenbarung im Gnosticismus* (Göttingen, 1901); C. Schmidt, "Plotin's Stellung zum Gnosticismus u. kirchl. Christentum," *Texte u. Untersuch.* xx. 4 (1902); E. de Faye, *Introduction à l'étude du Gnosticisme* (Paris, 1903); R. Reitzenstein, *Poimandres* (Leipzig, 1904); G. Krüger, article "Gnosticismus," in Herzog-Hauck's *Realencyclopædie* (3rd ed.) vi. 728 ff.; Bousset, "Hauptprobleme der Gnosis," *Forschungen z. Relig. u. Lit. d. alten u. neuen Testaments*, 10 (1907); T. Wendland, *Hellenistisch-römische Kultur in ihren Beziehungen zu Judentum und Christentum* (1907), p. 161 seq. See further among important monographs on the individual Gnostic systems, R. A. Lipsius, "Die ophitischen Systeme," *Zschr. f. wissenschaftl. Theologie* (1863); G. Heinrich, *Die valentinianische Gnosis u. d. Heilige Schrift* (Berlin, 1871); A. Nierx, *Bardesanes von Edessa* (Halle, 1863); A. Hilgenfeld, *Bardesanes, der letzte Gnostiker* (Leipzig, 1864); A. Harnack, "Über das gnostische Buch Pistis-Sophia," *Texte u. Untersuch.* vii. 2; C. Schmidt, "Gnostische Schriften," *Texte u. Untersuch.* viii. 1, 2; and also the works mentioned under § II. of this article. (W. Bo.)



White-tailed Gnu, or Black Wildebeest (*Connochaetes gnu*).

GNU, the Hottentot name for the large white-tailed South African antelope (*g.v.*), now nearly extinct, known to the Boers as the black wildebeest, and to naturalists as *Connochaetes* (or *Catoblepas*) *gnu*. A second and larger species is the brindled gnu or blue wildebeest (*C. taurinus* or *Catoblepas gorgon*), also known by the Bechuana name *kokon* or *kokoan*; and there are several East African forms more or less closely related to the latter which have received distinct names.

GO, or **GO-BANG** (Jap. *Go-ban*, board for playing Go), a popular table game. It is of great antiquity, having been invented in Japan, according to tradition, by the emperor Yao, 2350 B.C., but it is probably of Chinese origin. According to Falkener the first historical mention of it was made about the year 300 B.C., but there is abundant evidence that it was a popular game long before that period. The original Japanese *Go* is played on a board divided into squares by 19 horizontal and 19 vertical lines, making 361 intersections, upon which the flat round men, 181 white and 181 black, are placed one by one as the game proceeds. The men are placed by the two players on any intersections (*me*) that may seem advantageous, the object being to surround with one's men as many unoccupied intersections as possible, the player enclosing the greater number of vacant points being the winner. Completely surrounded men are captured and removed from the board. This game is played in England upon a board divided into 361 squares, the men being placed upon these instead of upon the intersections.

A much simpler variety of *Go*, mostly played by foreigners, has for its object to get five men into line. This may have been the earliest form of the game, as the word *go* means five. Except in Japan it is often played on an ordinary draughts-board, and the winner is he who first gets five men into line, either vertically, horizontally or diagonally.

See *Go-Bang*, by A. Howard Cady, in Spalding's Home Library (New York, 1896); *Games Ancient and Oriental*, by Edward Falkener (London, 1892); *Das japan-chinesische Spiel Go*, by O. Korschelt (Yokohama, 1881); *Das Nationalspiel der Japanesen*, by G. Schurig (Leipzig, 1888).

GOA, the name of the past and present capitals of Portuguese India, and of the surrounding territory more exactly described as Goa settlement, which is situated on the western coast of India, between 15° 44' and 14° 53' N., and between 73° 45' and 74° 26' E. Pop. (1900) 475,513, area 1301 sq. m.

Goa Settlement.—With Damaun (*g.v.*) and Diu (*g.v.*) Goa settlement forms a single administrative province ruled by a governor-general, and a single ecclesiastical province subject to the archbishop of Goa; for judicial purposes the province includes Macao in China, and Timor in the Malay Archipelago. It is bounded on the N. by the river Terakul or Araundem, which divides it from the Sawantwari state, E. by the Western Ghats, S. by Kanara district, and W. by the Arabian Sea. It comprises the three districts of Ilhas, Bardez and Salsette, conquered early in the 16th century and therefore known as the Velhas Conquistas (Old Conquests), seven districts acquired later and known as the Novas Conquistas, and the island of Anjidiv or Anjadiva. The settlement, which has a coast-line of 62 m., is a hilly region, especially the Novas Conquistas; its distinguishing features are the Western Ghats, though the highest summits nowhere reach an altitude of 4000 ft., and the island of Goa. Numerous short but navigable rivers water the lowlands skirting the coast. The two largest rivers are the Mandavi and the Juari, which together encircle the island of Goa (Ilhas), being connected on the landward side by a creek. The island (native name Tisvadi, Tissavaddy, Tissuary) is a triangular territory, the apex of which, called the *cabo* or cape, is a rocky headland separating the harbour of Goa into two anchorages—Agoada or Aguada at the mouth of the Mandavi, on the north, and Mormugão or Marmagão at the mouth of the Juari, on the south. The northern haven is exposed to the full force of the south-west monsoon, and is liable to silt up during the rains. The southern, sheltered by the promontory of Salsette, is always open, but is less used, owing to its greater distance from the city of Goa, which is built on the island. A railway connects Mormugão, south of the Juari estuary, with Castle Rock on the

Western Ghats. Goa imports textiles and foodstuffs, and exports coco-nuts, areca-nuts, spices, fish, poultry and timber. Its trade is carried on almost entirely with Bombay, Madras, Kathiawar and Portugal. Manganese is mined in large quantities, some iron is obtained, and other products are salt, palm-spirit, betel and bananas.

Cities of Goa.—1. The ancient Hindu city of Goa, of which hardly a fragment survives, was built at the southernmost point of the island, and was famous in early Hindu legend and history for its learning, wealth and beauty. In the Puranas and certain inscriptions its name appears as Gove, Govāpurī, Gomant, &c.; the medieval Arabian geographers knew it as Sindābur or Sandābur, and the Portuguese as Goa Velha. It was ruled by the Kadamba dynasty from the 2nd century A.D. to 1312, and by Mahomedan invaders of the Deccan from 1312 until about 1370, during which period it was visited and described by Ibn Batuta. It was then annexed to the Hindu kingdom of Vijayanagar, of which, according to Ferishta, it still formed part in 1469, when it was conquered by the Bahmani sultan of the Deccan; but two of the best Portuguese chroniclers state that it became independent in 1440, when the second city (Old Goa) was founded.

2. Old Goa is, for the most part, a city of ruins without inhabitants other than ecclesiastics and their dependents. The chief surviving buildings are the cathedral, founded by Albuquerque in 1511 to commemorate his entry into Goa on St Catherine's day 1510, and rebuilt in 1623, and still used for public worship; the convent of St Francis (1517), a converted mosque rebuilt in 1661, with a portal of carved black stone, which is the only relic of Portuguese architecture in India dating from the first quarter of the 16th century; the chapel of St Catherine (1551); the church of Bom Jesus (1504-1603), a superb example of Renaissance architecture as developed by the Jesuits, containing the magnificent shrine and tomb of St Francis Xavier (see XAVIER, FRANCISCO DE); and the 17th-century convents of St Monica and St Cajetan. The college of St Paul (see below) is in ruins.

3. Panjim, Pangim or New Goa originally a suburb of Old Goa, is, like the parent city, built on the left bank of the Mandavi estuary, in 15° 30' N. and 73° 33' E. Pop. (1901) 9500. It is a modern port with few pretensions to architectural beauty. Ships of the largest size can anchor in the river, but only small vessels can load or discharge at the quay. Panjim became the residence of the viceroy in 1759 and the capital of Portuguese India in 1843. It possesses a lyceum, a school for teachers, a seminary, a technical school and an experimental agricultural station.

Political History.—With the subdivision of the Bahmani kingdom, after 1482, Goa passed into the power of Yusuf Adil Shah, king of Bijapur, who was its ruler when the Portuguese first reached India. At this time Goa was important as the starting-point of pilgrims from India to Mecca, as a mart with no rival except Calicut on the west coast, and especially as the centre of the import trade in horses (Gulf Arabs) from Hormuz, the control of which was a vital matter to the kingdoms warring in the Deccan. It was easily defensible by any power with command of the sea, as the encircling rivers could only be forded at one spot, and had been deliberately stocked with crocodiles. It was attacked on the 10th of February 1510 by the Portuguese under Albuquerque. As a Hindu ascetic had foretold its downfall and the garrison of Ottoman mercenaries was outnumbered, the city surrendered without a struggle, and Albuquerque entered it in triumph, while the Hindu townsfolk strewed flagree flowers of gold and silver before his feet. Three months later Yusuf Adil Shah returned with 60,000 troops, forced the passage of the ford, and blockaded the Portuguese in their ships from May to August, when the cessation of the monsoon enabled them to put to sea. In November Albuquerque returned with a larger force, and after overcoming a desperate resistance, recaptured the city, permitted his soldiers to plunder it for three days, and massacred the entire Mahomedan population.

Goa was the first territorial possession of the Portuguese in

Asia. Albuquerque intended it to be a colony and a naval base, as distinct from the fortified factories which had been established in certain Indian seaports. He encouraged his men to marry native women, and to settle in Goa as farmers, retail traders or artisans. These married men soon became a privileged caste, and Goa acquired a large Eurasian population. Albuquerque and his successors left almost untouched the customs and constitutions of the 30 village communities on the island, only abolishing the rite of suttee. A register of these customs (*Foal de usos e costumes*) was published in 1526, and is an historical document of much value; an abstract of it is given in R. S. Whiteway's *Rise of the Portuguese Empire in India* (London, 1898).

Goa became the capital of the whole Portuguese empire in the East. It was granted the same civic privileges as Lisbon. Its senate or municipal chamber maintained direct communications with the king and paid a special representative to attend to its interests at court. In 1503 the governor even proposed to make Goa the seat of a parliament, in which all parts of the Portuguese east were to be represented; this was vetoed by the king.

In 1542 St Francis Xavier mentions the architectural splendour of the city; but it reached the climax of its prosperity between 1575 and 1625. *Goa Dowada*, or Golden Goa, was then the wonder of all travellers, and there was a Portuguese proverb, "He who has seen Goa need not see Lisbon." Merchandise from all parts of the East was displayed in his bazaar, and separate streets were set aside for the sale of different classes of goods—Bahrain pearls and coral, Chinese porcelain and silk, Portuguese velvet and piece-goods, drugs and spices from the Malay Archipelago. In the main street slaves were sold by auction. The houses of the rich were surrounded by gardens and palm groves; they were built of stone and painted red or white. Instead of glass, their balconied windows had thin polished oyster-shells set in lattice-work.

The social life of Goa was brilliant, as befitted the headquarters of the viceregal court, the army and navy, and the church; but the luxury and ostentation of all classes had become a byword before the end of the 16th century. Almost all manual labour was done by slaves; common soldiers assumed high-sounding titles, and it was even customary for the poor noblemen who congregated together in boarding-houses to subscribe for a few silken cloaks, a silken umbrella and a common man-servant, so that each could take his turn to promenade the streets, fashionably attired and with a proper escort. There were huge gambling saloons, licensed by the municipality, where determined players lodged for weeks together; and every form of vice, except drunkenness, was practised by both sexes, although European women were forced to lead a kind of zenana life, and never ventured unveiled into the streets; they even attended at church in their palanquins, so as to avoid observation.

The appearance of the Dutch in Indian waters was followed by the gradual ruin of Goa. In 1603 and 1639 the city was blockaded by Dutch fleets, though never captured, and in 1635 it was ravaged by an epidemic. Its trade was gradually monopolized by the Jesuits. Thevenot in 1666, Baldacus in 1672, Fryer in 1675 describe its ever-increasing poverty and decay. In 1683 only the timely appearance of a Mogul army saved it from capture by a horde of Mahratta raiders, and in 1739 the whole territory was attacked by the same enemies, and only saved by the unexpected arrival of a new viceroy with a fleet. This peril was always imminent until 1759, when a peace with the Mahrattas was concluded. In the same year the proposal to remove the seat of government to Panjim was carried out; it had been discussed as early as 1684. Between 1695 and 1775 the population dwindled from 20,000 to 1600, and in 1835 Goa was only inhabited by a few priests, monks and nuns.

Ecclesiastical History.—Some Dominican friars came out to Goa in 1510, but no large missionary enterprise was undertaken before the arrival of the Franciscans in 1517. From their headquarters in Goa the Franciscan preachers visited many parts of western India, and even journeyed to Ceylon, Pegu and the Malay Archipelago. For nearly twenty-five years they carried on

the work of evangelization almost alone, with such success that in 1534 Pope Paul III. made Goa a bishopric, with spiritual jurisdiction over all Portuguese possessions between China and the Cape of Good Hope, though itself suffragan to the archbishopric of Funchal in Madeira. A Franciscan friar, João de Albuquerque, came to Goa as its first bishop in 1538. In 1542 St Francis Xavier came to Goa, and took over the Franciscan college of Santa Fé, for the training of native missionaries; this was renamed the College of St Paul, and became the headquarters of all Jesuit missions in the East, where the Jesuits were commonly styled *Paulistas*. By a Bull dated the 4th of February 1557 Goa was made an archbishopric, with jurisdiction over the sees of Malacca and Cochim, to which were added Macao (1575), Japan (1588), Angamale or Cranganore (1600), Meliapur (Mylapur) (1606), Peking and Nanking (1610), together with the bishopric of Mozambique, which included the entire coast of East Africa. In 1606 the archbishop received the title of Primate of the East, and the king of Portugal was named Patron of the Catholic Missions in the East; his right of patronage was limited by the Concordat of 1857 to Goa, Malacca, Macao and certain parts of British India. The Inquisition was introduced into Goa in 1560: a vivid account of its proceedings is given by C. DeKon, *Relation de l'acquisition de Goa* (1688). Five ecclesiastical councils, which dealt with matters of discipline, were held at Goa—in 1507, 1575, 1585, 1592 and 1606; the archbishop of Goa also presided over the more important synod of Diamper (Udayamperur, about 22 m. S.E. of Cochim), which in 1599 condemned as heretical the tenets and liturgy of the Indian Nestorians, or Christians of St Thomas (*q.v.*). In 1675 Fryer described Goa as "a Rome in India, both for absoluteness and fabrics," and Hamilton states that early in the 18th century the number of ecclesiastics in the settlement had reached the extraordinary total of 30,000. But the Jesuits were expelled in 1759, and by 1800 Goa had lost much even of its ecclesiastical importance. The Inquisition was abolished in 1814 and the religious orders were secularized in 1835.

BIBLIOGRAPHY.—J. N. da Fonseca, *An Historical and Archaeological Sketch of Goa* (Bombay, 1878) is a minute study of the city from the earliest times, illustrated. For the early history of Portuguese rule the chief authorities are *The Commentaries . . . of Dalboquerque* (Hakluyt Society's translation, London, 1877), the *Cartas of Albuquerque* (Lisbon, 1884), the *Historia . . . da India* of F. L. de Castanheda (Lisbon, 1833, written before 1552), the *Leitões da India* of G. Correa (Lisbon, 1860, written 1514–1566), and the *Decadas da India* of João de Barros and D. do Couto (Lisbon, 1778–1788, written about 1530–1616). Couto's *Saldado pratico* (Lisbon, 1790) and S. Botelho's *Cartas and Tombo*, written 1547–1554, published in "Subsidios" of the Lisbon Academy (1868), are valuable studies of military life and administration. The *Arquivo Portuguez oriental* (6 parts, New Goa, 1857–1877) is a most useful collection of documents dating from 1515; part 2 contains the privileges, &c. of the city of Goa, and part 4 contains the minutes of the ecclesiastical councils and of the synod of Diamper. The social life of Goa has been graphically described by many writers; see especially the travels of Varthema (c. 1505), Linschoten (c. 1580), Pyrard (1608) in the Hakluyt Society's translations; J. Macquet, *Voyages* (Paris, 1830, written 1608–1610); P. Baldaeus, in *Churchill's Voyages*, vol. 3 (London, 1732); J. Fryer, *A New Account of East India and Persia* (London, 1698); A. de Mandelslo, *Voyages* (London, 1669); *Les Voyages de M. de Thevenot aux Indes Orientales* (Amsterdam, 1779), and A. Hamilton, *A New Account of the East Indies* (London, 1774). For Goa in the 20th century see *The Imperial Gazetteer of India*. (K. C. J.)

GOAL, originally an object set up as the place where a race ends, the winning-post, and so used figuratively of the end to which any effort is directed. It is thus used to translate the Lat. *meta*, the boundary pillar, set one at each end of the circus to mark the turning-point. The word was quite early used in various games for the two posts, with or without a cross-bar, through or over which the ball has to be driven to score a point towards winning the game. The *New English Dictionary* quotes the use in Richard Stanyhurst's *Description of Ireland* (1577); but the word *goal* in the sense of a boundary appears as early as the beginning of the 14th century in the religious poems of William de Shoreham (c. 1315). The origin of the word is obscure. It is usually taken to be derived from a French word *goule*, meaning a pole or stick, but this meaning does not appear in the English

usage, nor does the usual English meaning appear in the French. There is an O. Eng. *gollan*, to hinder, which may point to a lost *gdl*, barrier, but there is no evidence in other Teutonic languages for such a word.

GOALPARA, a town and district of British India, in the Brahmaputra valley division of eastern Bengal and Assam. The town (pop. 6287) overlooks the Brahmaputra. It was the frontier outpost of the Mahomedan power, and has long been a flourishing seat of river trade. The civil station is built on the summit of a small hill commanding a magnificent view of the valley of the Brahmaputra, bounded on the north by the snowy ranges of the Himalayas and on the south by the Garo hills. The native town is built on the western slope of the hill, and the lower portion is subject to inundation from the marshy land which extends in every direction. It has declined in importance since the district headquarters were removed to Dhubri in 1879, and it suffered severely from the earthquake of the 12th of June 1897.

The DISTRICT comprises an area of 3961 sq. m. It is situated along the Brahmaputra, at the corner where the river takes its southerly course from Assam into Bengal. The scenery is striking. Along the banks of the river grow clumps of cane and reed; farther back stretch fields of rice cultivation, broken only by the fruit trees surrounding the villages, and in the background rise the forest-clad hills overtopped by the white peaks of the Himalayas. The soil of the hills is of a red ochreous earth, with blocks of granite and sandstone interspersed; that of the plains is of alluvial formation. Earthquakes are common and occasionally severe shocks have been experienced. The Brahmaputra annually inundates vast tracts of country. Numerous extensive forests yield valuable timber. Wild animals of all kinds are found. In 1901 the population was 462,083, showing an increase of 2% in the decade. Rice forms the staple crop. Mustard and jute are also largely grown. The manufactures consist of the making of brass and iron utensils and of gold and silver ornaments, weaving of silk cloth, basket-work and pottery. The cultivation of tea has been introduced but does not flourish anywhere in the district. Local trade is in the hands of Marwari merchants, and is carried on at the *bazars*, weekly *kats* or markets and periodical fairs. The chief exports are mustard-seed, jute, cotton, timber, lac, silk cloth, india-rubber and tea; the imports, Bengal rice, European piece goods, salt, hardware, oil and tobacco.

Dhubri (pop. 3737), the administrative headquarters of the district, stands on the Brahmaputra where that river takes its great bend south. It is the termination of the emigration road from North Bengal and of the river steamers that connect with the North Bengal railway. It is also served by the eastern Bengal State railway.

GOAT (a common Teut. word; O. Eng. *gdt*, Goth. *gaitis*, Mod. Ger. *Geiss*, cognate with Lat. *hædus*, a kid), properly the name of the well-known domesticated European ruminant (*Capra hircus*), which has for all time been regarded as the emblem of everything that is evil, in contradistinction to the sheep, which is the symbol of excellence and purity. Although the more typical goats are markedly distinct from sheep, there is, both as regards wild and domesticated forms, an almost complete gradation from goats to sheep, so that it is exceedingly difficult to define either group. The position of the genus *Capra* (to all the members of which, as well as some allied species, the name "goat" in its wider sense is applicable) in the family *Bovidae* is indicated in the article *BOVINE*, and some of the distinctions between goats and sheep are mentioned in the article *SHEEP*. Here then it will suffice to mention that goats are characterized by the strong and offensive odour of the males, which are furnished with a beard on the chin; while as a general rule glands are present between the middle toes of the fore feet only.

Goats, in the wild state, are an exclusively old-world group, of which the more typical forms are confined to Europe and south-western and central Asia, although there are two outlying species in northern Africa. The wild goat, or pasang, is represented in Europe in the *Cyclades* and *Crete* by rather small races,

more or less mingled with domesticated breeds, the Cretan animal being distinguished as *Capra hircus creticus*; but the large typical race *C. h. aegagrus* is met with in the mountains of Asia Minor and Persia, whence it extends to Sind, where it is represented by a somewhat different race known as *C. h. blytki*. The horns of the old bucks are of great length and beauty, and characterized by their bold scimitar-like backward sweep and sharp front edge, interrupted at irregular intervals by knots or bosses. Domesticated goats have run wild in many islands, such as the Hebrides, Shetland, Canaries, Azores, Ascension and Juan Fernandez. Some of these reverted breeds have developed horns of considerable size, although not showing that regularity of curve distinctive of the wild race. In the Azores the horns are remarkably upright and straight, whence the name of "antelope-goat" which has been given to these animals. The concretions known as *bezoar-stones*, formerly much used in medicine and as antidotes of poison, are obtained from the stomach of the wild goat.

Although there have in all probability been more or less important local crosses with other wild species, there can be no doubt that domesticated goats generally are descended from the wild goat. It is true that many tame goats show spirally twisted horns recalling those of the under-mentioned Asiatic markhor; but in nearly all such instances it will be found that the spiral twists in the opposite direction. Among the domesticated breeds the following are some of the more important.

Firstly, we have the common or European goats, of which there are several more or less well-marked breeds, differing from each other in length of hair, in colour and slightly in the configuration of the horns. The ears are more or less upright, sometimes horizontal, but never actually pendent, as in some Asiatic breeds. The horns are rather flat at the base and not unfrequently corrugated; they rise vertically from the head, curving to the rear, and are more or less laterally inclined. The colour varies from dirty white to dark-brown, but when pure-bred is never black, which indicates eastern blood. Most European countries possess more than one description of the common goat. In the British Isles there are two distinct types, one short and the other long haired. In the former the hair is thick and close, with frequently an under-coat resembling wool. The horns are large in the male, and of moderate size in the female, flat at the base and inclining outwards. The head is short and tapering, the forehead flat and wide, and the nose small; while the legs are strong, thick and well covered with hair. The colour varies from white or grey to black, but is frequently fawn, with a dark line down the spine and another across the shoulders. The other variety has a shaggy coat, generally reddish-black, though sometimes grey or pied and occasionally white. The head is long, heavy and ugly, the nose coarse and prominent, with the horns situated close together, often continuing parallel almost to the extremities, being also large, corrugated and pointed. The legs are long and the sides flat, the animal itself being generally gaunt and thin. This breed is peculiar to Ireland, the Welsh being of a similar type, but more often white. The short-haired goat is the English goat proper. Both British breeds, as well as those from abroad, are frequently ornamented with two tassel-like appendages, hanging near together under the throat. It has been supposed by many that these are traceable to foreign blood; but although there are foreign breeds that possess them, they appear to pertain quite as much to the English native breeds as to those of distant countries, the peculiarity being mentioned in very old works on the goats of the British Islands. The milk-produce in the common goat as well as other kinds varies greatly with individuals. Irish goats often yield a quantity of milk, but the quality is poor. The goats of France are similar to those of Britain, varying in length of hair, colour and character of horns. The Norway breed is frequently white with long hair; it is rather small in size, with small bones, a short rounded body, head small with a prominent forehead, and short, straight, corrugated horns. The facial line is concave. The horns of the males are very large, and curve round after the manner of the wild goat, with a tuft of hair between and in front.

The Maltese goat has the ears long, wide and hanging down below the jaw. The hair is long and cream-coloured. The breed is usually hornless.

The Syrian goat is met with in various parts of the East, in Lower Egypt, on the shores of the Indian Ocean and in Madagascar. The hair and ears are excessively long, the latter so much so that they are sometimes clipped to prevent their being torn by stones or thorny shrubs. The horns are somewhat erect and spiral, with an outward bend.

The Angora goat is often confounded with the Kashmir, but is in reality quite distinct. The principal feature of this breed, of which there are two or three varieties, is the length and quantity of the hair, which has a particularly soft and silky texture, covering the whole body and a great part of the legs with close matted ringlets. The horns of the male differ from those of the female, being directed vertically and in shape spiral, whilst in the female they have a horizontal tendency, somewhat like those of a ram. The coat is composed of two kinds of hair, the one short and coarse and of the character of hair, which lies close to the skin, the other long and curly and of the nature of wool, forming the outer covering. Both are used by the manufacturer, but the exterior portion, which makes up by far the greater bulk, is much the more valuable. The process of shearing takes place in early spring, the average amount of wool yielded

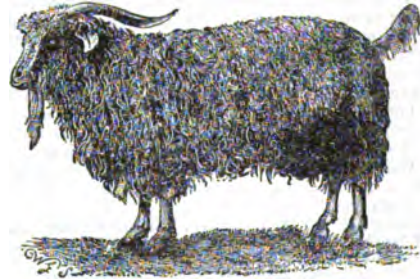

FIG. 1.—Male Angora Goat.

by each animal being about 2½ lb. The best quality comes from castrated males, females producing the next best.

The breed was introduced at the Cape about 1864. The Angora is a bad milker and an indifferent mother, but its flesh is better than that of any other breed, and in its native country is preferred to mutton. The kids are born small, but grow fast, and arrive early at maturity. The Kashmir, or rather Tibet, goat has a delicate head, with semi-pendulous ears, which are both long and wide. The hair varies in length, and is coarse and of different colours according to the individual. The horns are very erect, and sometimes slightly spiral, inclining inwards and to such an extent in some cases as to cross. The coat is composed, as in the Angora, of two materials; but in this breed it is the under-coat that partakes of the nature of wool and is valued as an article of commerce. This under-coat, or *pushm*, which is of a uniform greyish-white tint, whatever the colour of the hair may be, is beautifully soft and silky, and of a fluffy description resembling down. It makes its appearance in the autumn, and continues to grow until the following spring, when, if not removed, it falls off naturally; its collection then commences, occupying from eight to ten days. The animal undergoes during that time a process of combing by which all the wool and a portion of the hair, which of necessity comes with it, is removed. The latter is afterwards carefully separated, when the fleece in a good specimen weighs about half a pound. This is the material of which the far-famed and costly shawls are made, which at one time had such a demand that, it is stated, 16,000 looms were kept in constant work at Kashmir in their manufacture. Those goats having a short, neat head, long, thin, ears, a delicate skin, small bones, and a long heavy coat, are for this purpose deemed the best. There are several varieties

among other respects in its mode of nidification, is *Aegothales*, which belongs also to the Australian sub-region; and farther to the northward, extending throughout the Malay Archipelago and into India, comes *Batrachosomus*, wherein we again meet with species having aural tufts somewhat like *Lyncornis*. The *Podarginae* are thought by some to be represented in the new world by the genus *Nyctibius*, of which several species occur from the Antilles and Central America to Brazil. Finally, it may be stated that none of the *Caprimulgidae* seem to occur in Polynesia or in New Zealand, though there is scarcely any other part of the world suited to their habits in which members of the family are not found. (A. N.)

GOBAT, SAMUEL (1799-1879), bishop of Jerusalem, was born at Crémone, Bern, Switzerland, on the 26th of January 1799. After serving in the mission house at Basel from 1823 to 1826, he went to Paris and London, whence, having acquired some knowledge of Arabic and Ethiopic, he went out to Abyssinia under the auspices of the Church Missionary Society. The unsettled state of the country and his own ill health prevented his making much headway; he returned to Europe in 1835 and from 1839 to 1842 lived in Malta, where he supervised an Arabic translation of the Bible. In 1846 he was consecrated Protestant bishop of Jerusalem, under the agreement between the British and Prussian governments (1841) for the establishment of a joint bishopric for Lutherans and Anglicans in the Holy Land. He carried on a vigorous mission as bishop for over thirty years, his diocesan school and orphanage on Mount Zion being specially noteworthy. He died on the 11th of May 1879.

A record of his life, largely autobiographical, was published at Basel in 1884, and an English translation at London in the same year.

GOBEL, JEAN BAPTISTE JOSEPH (1727-1794), French ecclesiastic and politician, was born at Thann, in Alsace, on the 1st of September 1727. He studied theology in the German College at Rome, and then became successively a member of the chapter of Porrentruy, bishop in *partibus* of Lydda, and finally suffragan of Basel for that part of the diocese situated in French territory. His political life began when he was elected deputy to the states-general of 1789 by the clergy of the *bailliage* of Huningue. The turning-point of his life was his action in taking the oath of the civil constitution of the clergy (Jan. 3rd, 1791); in favour of which he had declared himself since the 5th of May 1790. The civil constitution of the clergy gave the appointment of priests to the electoral assemblies, and since taking the oath Gobel had become so popular that he was elected bishop in several dioceses. He chose Paris, and in spite of the difficulties which he had to encounter before he could enter into possession, was consecrated on the 27th of March 1791 by eight bishops, including Talleyrand. On the 8th of November 1792, Gobel was appointed administrator of Paris. He was careful to flatter the politicians by professing anti-clerical opinions, declaring himself, among other things, opposed to the celibacy of the clergy; and on the 17th Brumaire in the year II. (7th November 1793), he came before the bar of the Convention, and, in a famous scene, resigned his episcopal functions, proclaiming that he did so for love of the people, and through respect for their wishes. The followers of Hébert, who were then pursuing their anti-Christian policy, claimed Gobel as one of themselves; while, on the other hand, Robespierre looked upon him as an atheist, though apostasy cannot strictly speaking be laid to the charge of the ex-bishop, nor did he ever make any actual profession of atheism. Robespierre, however, found him an obstacle to his religious schemes, and involved him in the fate of the Hébertists. Gobel was condemned to death, with Chaumette, Hébert and Anacharsis Cloots, and was guillotined on the 12th of April 1794.

See E. Charavay, *Assemblée électorale de Paris* (Paris, 1890); H. Monin, *La Chanson et l'Église sous la Révolution* (Paris, 1892); A. Aulard, "La Culte de la raison" in the review, *La Révolution Française* (1891). For a bibliography of documents relating to his episcopate see "Episcopat de Gobel" in vol. iii. (1900) of M. Tournoux's *Bibliographie de l'histoire de Paris pendant la Rév. Fr.*

GOBELIN, the name of a family of dyers, who in all probability came originally from Reims, and who in the middle of the 15th

century established themselves in the Faubourg Saint Marcel, Paris, on the banks of the Bièvre. The first head of the firm was named Jehan (d. 1476). He discovered a peculiar kind of scarlet dyestuff, and he expended so much money on his establishment that it was named by the common people *la folie Gobelin*. To the dye-works there was added in the 16th century a manufactory of tapestry (*gobelins*). So rapidly did the wealth of the family increase, that in the third or fourth generation some of them forsook their trade and purchased titles of nobility. More than one of their number held offices of state, among others Balthasar, who became successively treasurer general of artillery, treasurer extraordinary of war, councillor secretary of the king, chancellor of the exchequer, councillor of state and president of the chamber of accounts, and who in 1601 received from Henry IV. the lands and lordship of Briecomte-Robert. He died in 1603. The name of the Gobelins as dyers cannot be found later than the end of the 17th century. In 1662 the works in the Faubourg Saint Marcel, with the adjoining grounds, were purchased by Colbert on behalf of Louis XIV., and transformed into a general upholstery manufactory, in which designs both in tapestry and in all kinds of furniture were executed under the superintendence of the royal painter, Le Brun. On account of the pecuniary embarrassments of Louis XIV., the establishment was closed in 1694, but it was reopened in 1697 for the manufacture of tapestry, chiefly for royal use and for presentation. During the Revolution and the reign of Napoleon the manufacture was suspended, but it was revived by the Bourbons, and in 1826 the manufacture of carpets was added to that of tapestry. In 1871 the building was partly burned by the Communists. The manufactory is still carried on under the state.

See Lacordaire, *Notice historique sur les manufactures impériales de tapisserie des Gobelin et de tapis de la Savonnerie, précédée du catalogue des tapisseries qui y sont exposés* (Paris, 1853); Genspach, *Répertoire détaillé des tapisseries exécutées aux Gobelins, 1662-1892* (Paris, 1893); Guiffrey, *Histoire de la tapisserie en France* (Paris, 1878-1885). The two last-named authors were directors of the manufactory.

GOBI (for which alternative Chinese names are SHA-MO, "sand desert," and HAN-HAI, "dry sea"), a term which in its widest significance means the long stretch of desert country that extends from the foot of the Pamirs, in about 77° E., eastward to the Great Khingan Mountains, in 116°-118° E., on the border of Manchuria, and from the foothills of the Altai, the Sayan and the Yablonoi Mountains on the N. to the Astin-tagh or Altyn-tagh and the Nan-shan, the northernmost constituent ranges of the Kuen-lun Mountains, on the south. By conventional usage a relatively small area on the east side of the Great Khingan, between the upper waters of the Sungari and the upper waters of the Liao-ho, is also reckoned to belong to the Gobi. On the other hand, geographers and Asiatic explorers prefer to regard the W. extremity of the Gobi region (as defined above), namely, the basin of the Tarim in E. Turkestan, as forming a separate and independent desert, to which they have given the name of Takla-makan. The latter restriction governs the present article, which accordingly excludes the Takla-makan, leaving it for separate treatment. The desert of Gobi as a whole is only very imperfectly known, information being confined to the observations which individual travellers have made from their respective itineraries across the desert. Amongst the explorers to whom we owe such knowledge as we possess about the Gobi, the most important have been Marco Polo (1273-1275), Gerbillon (1688-1698), Ijsbrand Ides (1692-1694), Lange (1727-1728 and 1736), Fuss and Bunge (1830-1831), Fritsche (1868-1873), Pavlinov and Matusovskii (1870), Ney Elias (1872-1873), N. M. Przhevsky (1870-1872 and 1876-1877), Zosnovsky (1875), M. V. Pjevstov (1878), G. N. Potanin (1877 and 1884-1886), Count Széchenyi and L. von Loczy (1879-1880), the brothers Grum-Grzhimailo (1880-1890), P. K. Kozlov (1893-1894 and 1899-1900), V. I. Rorobovsky (1894), V. A. Obruchev (1894-1896), Futterer and Holderer (1896), C. E. Bonin (1896 and 1899), Sven Hedin (1897 and 1900-1901), K. Bogdanovich (1898), Ladyghin (1899-1900) and Katsnakov (1899-1900).

Geographically the Gobi (a Mongol word meaning "desert")

is the deeper part of the gigantic depression which fills the interior of the lower terrace of the vast Mongolian plateau, and measures over 1000 m. from S.W. to N.E. and 450 to 600 m. from N. to S., being widest in the west, along the line joining the Baghrash-kol and the Lop-nor (87°-89° E.). Owing to the immense area covered, and the piecemeal character of the information, no general description can be made applicable to the whole of the Gobi. It will be more convenient, therefore, to describe its principal distinctive sections *seriatim*, beginning in the west.

Ghashiun-Gobi and Kuruk-tagh.—The Yulduz valley or valley of the Khaldyk-gol (83°-86° E., 43° N.) is enclosed by two prominent members of the Tian-shan system, namely the Chol-tagh and the Kuruk-tagh, running parallel and close to one another. As they proceed eastward they diverge, sweeping back on N. and S. respectively so as to leave room for the Baghrash-kol. These two ranges mark the northern and the southern edges respectively of a great swelling, which extends eastward for nearly twenty degrees of longitude. On its northern side the Chol-tagh descends steeply, and its foot is fringed by a string of deep depressions, ranging from Lukchun (25 ft. below the level of the sea) to Hami (2800 ft. above sea-level). To the south of the Kuruk-tagh lie the desert of Lop, the desert of Kum-tagh, and the valley of the Bulunzir-gol. To this great swelling, which arches up between the two border-ranges of the Chol-tagh and Kuruk-tagh, the Mongols give the name of Ghashiun-Gobi or Salt Desert. It is some 80 to 100 m. across from N. to S., and is traversed by a number of minor parallel ranges, ridges and chains of hills, and down its middle runs a broad stony valley, 25 to 50 m. wide, at an elevation of 3000 to 4500 ft. The Chol-tagh, which reaches an average altitude of 6000 ft., is absolutely sterile, and its northern foot rests upon a narrow belt of barren sand, which leads down to the depressions mentioned above.

The Kuruk-tagh is the greatly disintegrated, denuded and wasted relic of a mountain range which formerly was of incomparably greater magnitude. In the west, between Baghrash-kol and the Tarim, it consists of two, possibly of three, principal ranges, which, although broken in continuity, run generally parallel to one another, and embrace between them numerous minor chains of heights. These minor ranges, together with the principal ranges, divide the region into a series of long, narrow valleys, mostly parallel to one another and to the enclosing mountain chains, which descend like terraced steps, on the one side towards the depression of Lukchun and on the other towards the desert of Lop. In many cases these latitudinal valleys are barred transversely by ridges or spurs, generally elevations *en masse* of the bottom of the valley. Where such elevations exist, there is generally found, on the E. side of the transverse ridge, a cauldron-shaped depression, which some time or other has been the bottom of a former lake, but is now nearly a dry salt-basin. The surface configuration is in fact markedly similar to that which occurs in the inter-mont latitudinal valleys of the Kuen-lun. The hydrography of the Ghashiun-Gobi and the Kuruk-tagh is determined by these chequered arrangements of the latitudinal valleys. Most of the principal streams, instead of flowing straight down these valleys, cross them diagonally and only turn west after they have cut their way through one or more of the transverse barrier ranges.¹ To the highest range on the great swelling Grum-Grzhimailo gives the name of Tuge-tau, its altitude being 9000 ft. above the level of the sea and some 4000 ft. above the crown of the swelling itself. This range he considers to belong to the Chol-tagh system, whereas Sven Hedin would assign it to the Kuruk-tagh. This last, which is pretty certainly identical with the range of Khara-teken-ula (also known as the Kyzyl-sanghir, Sibir, and Singher Mountains), that overlooks the southern shore of the Baghrash-kol, though parted from it by the drift-sand desert of Ak-bel-kum (White Sands), has at first a W.N.W. to E.S.E. strike, but it gradually curves round like a scimitar towards the E.N.E. and at the same time gradually decreases in elevation. In 91° E., while the principal range of the Kuruk-tagh system wheels to the E.N.E., four of its subsidiary ranges terminate, or rather die away somewhat suddenly, on the brink of a long narrow depression (in which Sven Hedin sees a N.E. bay of the former great Central Asian lake of Lop-nor), having over against them the écheloned terminals of similar subordinate ranges of the Pe-ahan (Bay-san) system (see below). The Kuruk-tagh is throughout a relatively low, but almost completely barren range, being entirely destitute of animal life, save for hares, antelopes and wild camels, which frequent its few small, widely scattered oases. The vegetation, which is confined to these same relatively favoured spots, is of the scantiest and is mainly confined to bushes of saxaul (*Aeluropus ammoeandron*), reeds (*komish*), tamarisks, poplars, *Kalidium* and *Ephedra*.

Desert of Lop.—This section of the Gobi extends south-eastward from the foot of the Kuruk-tagh as far as the present terminal basin of the Tarim, namely Kara-koshun (Przhnevsky's Lop-nor), and is an almost perfectly horizontal expanse, for, while the Baghrash-kol in the N. lies at an altitude of 2940 ft., the Kara-koshun, over 200 m.

to the S., is only 300 ft. lower. The characteristic features of this almost dead level or but slightly undulating region are: (i.) broad, unbroken expanses of clay intermingled with sand, the clay (*shor*) being indurated and saliferous and often arranged in terraces; (ii.) hard, level, clay expanses, more or less thickly sprinkled with fine gravel (*soy*), the clay being mostly of a yellow or yellow-grey colour; (iii.) benches, flattened ridges and tabular masses of consolidated clay (*jardangs*), arranged in distinctly defined *laminæ*, three stories being sometimes superimposed one upon the other, and their vertical faces being abraded, and often undercut, by the wind, while the formations themselves are separated by parallel gullies or wind-furrows, 6 to 20 ft. deep, all sculptured in the direction of the prevailing wind, that is, from N.E. to S.W.; and (iv.) the absence of drift-sand and sand-dunes, except in the south, towards the outlying foothills of the Astin-tagh. Perhaps the most striking characteristic, after the *jardangs* or clay terraces, is the fact that the whole of this region is not only swept bare of sand by the terrific sandstorms (*burans*) of the spring months, the particles of sand with which the wind is laden acting like a sand-blast, but the actual substantive materials of the desert itself are abraded, filed, eroded and carried bodily away into the network of lakes in which the Tarim loses itself, or are even blown across the lower, constantly shifting watercourses of that river and deposited on or among the gigantic dunes which choke the eastern end of the desert of Fakhla-makan. Numerous indications, such as salt-stained depressions of a lacustrine appearance, traces of former lacustrine shore-lines, more or less parallel and concentric, the presence in places of vast quantities of fresh-water mollusc shells (species of *Lymnaea* and *Planorbis*), the existence of belts of dead poplars, patches of dead tamarisks and extensive beds of withered reeds, all these always on top of the *jardangs*, never in the wind-etched furrows, together with a few scrubby poplars and *Elaeagnus*, still struggling hard not to die, the presence of ripple marks of aqueous origin on the leeward sides of the clay terraces and in other wind-sheltered situations, all testify to the former existence in this region of more or less extensive fresh-water lakes, now of course completely desiccated. During the prevalence of the spring storms the atmosphere that overhangs the immediate surface of the desert is so heavily charged with dust as to be a veritable pall of desolation. Except for the wild camel which frequents the reed oases on the N. edge of the desert, animal life is even less abundant than in the Ghashiun-Gobi, and the same is true as regards the vegetation.

Desert of Kum-tagh.—This section lies E.S.E. of the desert of Lop, on the other side of the Kara-koshun and its more or less temporary continuations, and reaches north-eastwards as far as the vicinity of the town of Sa-chow and the lake of Kara-nor or Kala-chi. Its southern rim is marked by a labyrinth of hills, dotted in groups and irregular clusters, but evidently survivals of two parallel ranges which are now worn down as it were to mere fragments of their former skeletal structure. Between these and the Astin-tagh intervenes a broad latitudinal valley, seamed with watercourses which come down from the foothills of the Astin-tagh and beside which scrubby desert plants of the usual character maintain a precarious existence, water reaching them in some instances at intervals of years only. This part of the desert has a general slope N.W. towards the relative depression of the Kara-koshun. A noticeable feature of the Kum-tagh is the presence of large accumulations of drift-sand, especially along the foot of the crumbling desert ranges, where it rises into dunes sometimes as much as 250 ft. in height and climbs half-way up the flanks of ranges themselves. The prevailing winds in this region would appear to blow from the W. and N.W. during the summer, winter and autumn, though in spring, when they certainly are more violent, they no doubt come from the N.E., as in the desert of Lop. Anyway, the arrangement of the sand here "agrees perfectly with the law laid down by Potanin, that in the basins of Central Asia the sand is heaped up in greater mass on the south, all along the bordering mountain ranges where the floor of the depressions lies at the highest level."² The country to the north of the desert ranges is thus summarily described by Sven Hedin:³ "The first zone of drift-sand is succeeded by a region which exhibits proofs of wind-modelling on an extraordinarily energetic and well developed scale, the results corresponding to the *jardangs* and the wind-eroded gullies of the desert of Lop. Both sets of phenomena lie parallel to one another; from this we may infer that the winds which prevail in the two deserts are the same. Next comes, sharply demarcated from the zone just described, a more or less thin kamish steppe growing on level ground; and this in turn is followed by another very narrow belt of sand, immediately south of Achik-kuduk. . . . Finally in the extreme north we have the characteristic and sharply defined belt of kamish steppe, stretching from E.N.E. to W.S.W. and bounded on N. and S. by high, sharp-cut clay terraces. . . . At the points where we measured them the northern terrace was 113 ft. high and the southern 85 ft. . . . Both terraces belong to the same level, and would appear to correspond to the shore lines of a big bay of the last surviving remnant of the Central Asian Mediterranean. At the point where I crossed it the depression was 6 to 7 m. wide, and thus resembled a flat valley or immense river-bed."

¹ Cf. G. E. Grum-Grzhimailo, *Opisaniye Puteshestviya*, I. 381-417.

² Quoted in Sven Hedin, *Scientific Results*, II. 499.

³ *Op. cit.* II. 499-500.

Desert of Hami and the Pe-shan Mountains.—This section occupies the space between the Tian-shan system on the N. and the Nan-shan Mountains on the S., and is connected on the W. with the desert of Lop. The classic account is that of Przhevalsky, who crossed the desert from Hami (or Khami) to Su-chow (not Sa-chow) in the summer of 1879. In the middle this desert rises into a vast swelling, 80 m. across, which reaches an average elevation of 5000 ft. and a maximum elevation of 5500 ft. On its northern and southern borders it is overtopped by two divisions of the Bey-san (= Pe-shan) Mountains, neither of which attains any great relative altitude. Between the northern division and the Karlyk-tagh range or E. Tian-shan intervenes a somewhat undulating barren plain, 3000 ft. in altitude and 40 m. from N. to S., sloping downwards from both N. and S. towards the middle, where lies the oasis of Hami (2800 ft.). Similarly from the southern division of the Bey-san a second plain slopes down for 1000 ft. to the valley of the river Bulunzir or Su-lai-ho, which comes out of China, from the south side of the Great Wall, and finally empties itself into the lake of Kalachi or Kara-nor. From the Bulunzir the same plain continues southwards at a level of 3700 ft. to the foot of the Nan-shan Mountains. The total breadth of the desert from N. to S. is here 200 m. Its general character is that of an undulating plain, dotted over with occasional elevations of clay, which present the appearance of walls, table-topped mounds and broken towers (*Jardangs*), the surface of the plain being strewn with gravel and absolutely destitute of vegetation. Generally speaking, the Bey-san ranges consist of isolated hills or groups of hills, of low relative elevation (100 to 300 ft.), scattered without any regard to order over the arch of the swelling. They nowhere rise into well-defined peaks. Their axis runs from W.S.W. to E.N.E. But whereas Przhevalsky and Sven Hedin consider them to be a continuation of the Kuruk-tagh, though the latter regards them as separated from the Kuruk-tagh by a well-marked bay of the former Central Asian Mediterranean (Lop-nor), Futterer declares they are a continuation of the Chol-tagh. The swelling or undulating plain between these two ranges of the Bey-san measures about 70 m. across and is traversed by several stretches of high ground having generally an east-west direction.¹ Futterer, who crossed the same desert twenty years after Przhevalsky, agrees generally in his description of it, but supplements the account of the latter explorer with several particulars. He observes that the ranges in this part of the Gobi are much worn down and wasted, like the Kuruk-tagh farther west and the tablelands of S.E. Mongolia farther east, through the effects of century-long insolation, wind erosion, great and sudden changes of temperature, chemical action and occasional water erosion. Vast areas towards the N. consist of expanses of gently sloping (at a mean slope of 3°) clay, intermingled with gravel. He points out also that the greatest accumulations of sand and other products of aerial denudation do not occur in the deepest parts of the depressions but at the outlets of the valleys and glens, and along the foot of the ranges which flank the depressions on the S. Wherever water has been, desert scrub is found, such as tamarisks, *Dodaria orientalis*, *Agriophyllum gobicum*, *Calligonum sinense*, and *Lycium ruthenicum*, but all with their roots elevated on little mounds in the same way as the tamarisks grow in the Takla-makan and desert of Lop.

Farther east, towards central Mongolia, the relations, says Futterer, are the same as along the Hami-Su-chow route, except that the ranges have lower and broader crests, and the detached hills are more denuded and more disintegrated. Between the ranges occur broad, flat, cauldron-shaped valleys and basins, almost destitute of life except for a few hares and a few birds, such as the crow and the pheasant, and with scanty vegetation, but no great accumulations of drift-sand. The rocks are severely weathered on the surface, a thick layer of the coarser products of denudation covers the flat parts and climbs a good way up the flanks of the mountain ranges, but all the finer material, sand and clay has been blown away partly S.E. into Ordos, partly into the Chinese provinces of Shen-si and Shan-si, where it is deposited as loess, and partly W., where it chokes all the southern parts of the basin of the Tarim. In these central parts of the Gobi, as indeed in all other parts except the desert of Lop and Ordos, the prevailing winds blow from the W. and N.W. These winds are warm in summer, and it is they which in the desert of Hami bring the fierce sandstorms or burans. The wind does blow also from the N.E., but it is then cold and often brings snow, though it speedily clears the air of the over-laying dust haze. In summer great heat is encountered here on the relatively low (3000-4500 ft.), gravelly expanses (*szs*) on the N. and on those of the S. (4000-5000 ft.); but on the higher swelling between, which in the Pe-shan ranges ascends to 7530 ft., there is great cold even in summer, and a wide daily range of temperature. Above the broad and deep accumulations of the products of denudation which have been brought down by the rivers from the Tian-shan ranges (e.g. the Karlyk-tagh) on the N. and from the Nan-shan on the S., and have filled up the cauldron-shaped valleys, there rises a broad swelling, built up of granitic rocks, crystalline schists and metamorphosed sedimentary rocks of both Archaic and Palaeozoic age, all greatly folded and tilted up, and shot through with numerous intrusions of volcanic rocks, predominantly porphyritic and dioritic. On this swelling rise four more or less parallel mountain

ranges of the Pe-shan system, together with a fifth chain of hills farther S., all having a strike from W.N.W. to E.N.E. The range farthest N. rises to 1000 ft. above the desert and 7530 ft. above sea-level, the next two ranges reach 1300 ft. above the general level of the desert, and the range farthest south 1475 ft. or an absolute altitude of 7200 ft., while the fifth chain of hills does not exceed 650 ft. in relative elevation. All these ranges decrease in altitude from W. to E. In the depressions which border the Pe-shan swelling on N. and S. are found the sedimentary deposits of the Tertiary sea of the Han-hai; but no traces of these deposits have been found on the swelling itself at altitudes of 5500 to 5700 ft. Hence, Futterer infers, in recent geological times no large sea has occupied the central part of the Gobi. Beyond an occasional visit from a band of nomad Mongols, this region of the Pe-shan swelling is entirely uninhabited.² And yet it was from this very region, avers G. E. Grum-Grzhimailo, that the Yue-chi, a nomad race akin to the Tibetans, proceeded when, towards the middle of the 2nd century B.C., they moved westwards and settled near Lake Issyk-kul; and from here proceeded also the Shanshan, or people who some two thousand years ago founded the state of Shanshan or Lo-lan, ruins of the chief town of which Sven Hedin discovered in the desert of Lop in 1901. Here, says the Russian explorer, the Huns gathered strength, as also did the Tukin (Turks) in the 6th century, and the Uighur tribes and the rulers of the Tangut kingdom. But after Jenghiz Khan in the 12th century drew away the peoples of this region, and no others came to take their place, the country went out of cultivation and eventually became the barren desert it now is.

Ala-shan.—This division of the great desert, known also as the Hsi-tau and the Little Gobi, fills the space between the great N. loop of the Hwang-ho or Yellow river on the E., the Edzin-gol on the W., and the Nan-shan Mountains on the S.W., where it is separated from the Chinese province of Kan-suh by the narrow rocky chain of Lung-shan (Ala-shan), 10,500 to 11,600 ft. in altitude. It belongs to the middle basin of the three great depressions into which Potania divides the Gobi as a whole. "Topographically," says Przhevalsky, "it is a perfectly level plain, which in all probability once formed the bed of a huge lake or inland sea." The data upon which he bases this conclusion are the level area of the region as a whole, the hard saline clay and the sand-strewn surface, and lastly the salt lakes which occupy its lowest parts. For hundreds of miles there is nothing to be seen but bare sands; in some places they continue so far without a break that the Mongols call them Tyngheri (*tan, sky*). These vast expanses are absolutely waterless, nor do any oases relieve the unbroken stretches of yellow sand which alternate with equally vast areas of saline clay or, nearer the foot of the mountains, with barren shingle. Although on this whole a level country with a general altitude of 3300 to 5000 ft., this section, like most other parts of the Gobi, is crowned by a chequered network of hills and broken ranges going up 1000 ft. higher. The vegetation is confined to a few varieties of bushes and a dozen kinds of grasses, the most conspicuous being saxaul and *Agriophyllum gobicum* (a grass). The others include prickly convolvulus, field wormwood, acacia, *Isula ammodendron*, *Sophora flavescens*, *Comolobus Ammani*, *Peganum* and *Astragalus*, but all dwarfed, deformed and starved. The fauna consists of little else except antelopes, the wolf, fox, hare, hedgehog, marten, numerous lizards and a few birds, e.g. the sand-grouse, lark, stonechat, sparrow, crane, *Podiceps Hendersoni*, *Otocorys albigula* and *Galeria cristata*.³ The only human inhabitants of Ala-shan are the Torgod Mongols.

Ordos.—East of the desert of Ala-shan, and only separated from it by the Hwang-ho, is the desert of Ordos or Ho-tau, "a level steppe, partly bordered by low hills. The soil is altogether sandy or a mixture of clay and sand, ill adapted for agriculture. The absolute height of this country is between 3000 and 3500 ft., so that Ordos forms an intermediate step in the descent to China from the Gobi, separated from the latter by the mountain ranges lying on the N. and E. of the Hwang-ho or Yellow river."⁴ Towards the south Ordos rises to an altitude of over 5000 ft., and in the W., along the right bank of the Hwang-ho, the Arbus or Arbus Mountains, which overtop the steppe by some 3000 ft., serve to link the Ala-shan Mountains with the In-shan. The northern part of the great loop of the river is filled with the sands of Kuzupchi, a succession of dunes, 40 to 50 ft. high. Amongst them in scattered patches grow the shrub *Hedysarum* and the tree *Calligonum Fragopyrum* and *Pagionium cornutum*. In some places these sand-dunes approach close to the great river, in others they are parted from it by a belt of sand, intermingled with clay, which terminates in a steep escarpment, 50 ft. and in some localities 100 ft. above the river. This belt is studded with little mounds (7 to 10 ft. high), mostly overgrown with wormwood (*Artemisia campestris*) and the Siberian pea-tree (*Caragana*); and here too grows one of the most characteristic plants of Ordos, the liquorice root (*Glycyrrhiza uralensis*). Eventually

¹ Futterer, *Durch Asien*, i. p. 206-211.

² G. E. Grum-Grzhimailo, *Opisnie Puteshestviya v Sapsadny Kitai*, ii. p. 127.

³ Its seeds are pounded by the Mongols to flour and mixed with their tea.

⁴ Przhevalsky, *Mongolia* (Eng. trans. ed. by Sir H. Yule).

⁵ Przhevalsky, *op. cit.* p. 183.

¹ Przhevalsky, *Is Zayana cheres Hami v Tibet na Vostokoye Sholoy Raki*, pp. 84-91.

the sand-dunes cross over to the left bank of the Hwang-ho, and are threaded by the beds of dry watercourses, while the level spaces amongst them are studded with little mounds (3 to 6 ft. high), on which grow stunted *Nitraria Scoberi* and *Zygophyllum*. Ordos, which was recently known as Ho-nan ("the country south of the river") and still farther back in time as Ho-tau, was occupied by the Hiong-nu in the 1st and 2nd centuries A.D., but was almost depopulated during and after the Dungan revolt of 1869. North of the big loop of the Hwang-ho Ordos is separated from the central Gobi by a succession of mountain chains, the Kara-naryn-ula, the Sheiten-ula, and the In-shan Mountains, which link on to the south end of the Great Khingan Mountains. The In-shan Mountains, which stretch from 108° to 112° E., have a wild Alpine character and are distinguished from other mountains in the S.E. of Mongolia by an abundance of both water and vegetation. In one of their constituent ranges, the bold Munni-ula, 70 m. long and nearly 20 m. wide, they attain elevations of 7500 to 8500 ft., and have steep flanks, slashed with rugged gorges and narrow gisens. Forests begin on them at 5300 ft. and wild flowers grow in great profusion and variety in summer, though with a striking lack of brilliancy in colouring. In this same border range there is also a much greater abundance and variety of animal life, especially amongst the avifauna.

Eastern Gobi.—Here the surface is extremely diversified, although there are no great differences in vertical elevation. Between Urga (48° N. and 107° E.) and the little lake of Iren-dubasu-nor (111° 50' E. and 43° 45' N.) the surface is greatly eroded, and consists of broad flat depressions and basins separated by groups of flat-topped mountains of relatively low elevation (500 to 600 ft.), through which archaic rocks crop out as crags and isolated rugged masses. The floors of the depressions lie mostly between 2000 and 3200 ft. above sea-level. Farther south, between Iren-dubasu-nor and the Hwang-ho comes a region of broad tablelands alternating with flat plains, the latter ranging at altitudes of 3300 to 3600 ft. and the former at 3500 to 4000 ft. The slopes of the plateaus are more or less steep, and are sometimes penetrated by "bays" of the lowlands. As the border-range of the Khingan is approached the country steadily rises up to 4500 ft. and then to 5350 ft. Here small lakes frequently fill the depressions, though the water in them is generally salt or brackish. And both here, and for 200 m. south of Urga, streams are frequent, and grass grows more or less abundantly. There is, however, through all the central parts, until the bordering mountains are reached, an utter absence of trees and shrubs. Clay and sand are the predominant formations, the watercourses, especially in the north, being frequently excavated 6 to 8 ft. deep, and in many places in the flat, dry valleys or depressions farther south beds of loess, 15 to 20 ft. thick, are exposed. West of the route from Urga to Kalgan the country presents approximately the same general features, except that the mountains are not so irregularly scattered in groups but have more strongly defined strikes, mostly E. to W., N.W. to E.S.E., and W.S.W. to E.N.E. The altitudes too are higher, those of the lowlands ranging from 3300 to 5600 ft., and those of the ranges from 650 to 1650 ft. higher, though in a few cases they reach altitudes of 8000 ft. above sea-level. The elevations do not, however, as a rule form continuous chains, but make up a congeries of short ridges and groups rising from a common base and intersected by a labyrinth of ravines, gullies, gisens and basins. But the tablelands, built up of the horizontal red deposits of the Han-hai (Obruchev's Gobi formation) which are characteristic of the southern parts of eastern Mongolia, are absent here or occur only in one locality, near the Shara-muren river, and are then greatly intersected by gullies or dry watercourses. Here there is, however, a great dearth of water, no streams, no lakes, no wells, and precipitation falls but seldom. The prevailing winds blow from the W and N.W. and the pall of dust overshadows the country as in the Takla-makan and the desert of Lop. Characteristic of the flora are wild garlic, *Kalidium gracile*, wormwood, saxaul, *Nitraria Scoberi*, *Caragana*, *Ephedra*, saltwort and *Dirisun* (*Lasiagrostis splendens*).

This great desert country of Gobi is crossed by several trade routes, some of which have been in use for thousands of years. Among the most important are those from Kalgan on the frontier of China to Urga (600 m.), from Su-chow (in Kan-suh) to Hami (420 m.), from Hami to Peking (1300 m.), from Kwai-hwa-cheng (or Kuku-khoto) to Hami and Barkul, and from Lanchow (in Kan-suh) to Hami.

Climate.—The climate of the Gobi is one of great extremes, combined with rapid changes of temperature, not only at all seasons of the year but even within 24 hours (as much as 58° F.). For instance, at Urga (3770 ft.) the annual mean is 27.5° F., the January mean -15.7°, and the July mean 63.5°, the extremes being 100.5° and -44.5°; while at Sivantse (3905 ft.) the annual mean is 37°, the January mean 2.3°, and the July mean 60.3°, the range being from a recorded maximum of 93° to a recorded minimum of -53°. Even in southern Mongolia the thermometer goes down as low as -27°, and in Ala-shan it rises day after day in July as high as 99°. Although the south-east monsoons reach the S.E. parts of the Gobi, the air generally throughout this region is characterized by extreme dryness, especially during the winter. Hence the icy sandstorms and snowstorms of spring and early summer. The rainfall at Urga for the year amounts to only 9.7 in.

¹ Obruchev, in *Imestia* of Russ. Geogr. Soc. (1895).

Sands of the Gobi Deserts.—With regard to the origin of the masses of sand out of which the dunes and chains of dunes (*barkhans*) are built up in the several deserts of the Gobi, opinions differ. While some explorers consider them to be the product of marine, or at any rate lacustrine, denudation (the Central Asian Mediterranean), others—and this is not only the more reasonable view, but it is the view which is gaining most ground—consider that they are the products of the aerial denudation of the border ranges (e.g. Nan-shan, Karlyk-tagh, &c.), and more especially of the terribly wasted ranges and chains of hills, which, like the gaunt fragments of montane skeletal remains, lie littered all over the swelling uplands and tablelands of the Gobi, and that they have been transported by the prevailing winds to the localities in which they are now accumulated, the winds obeying similar transportation laws to the rivers and streams which carry down sediment in moister parts of the world. Potanin points out¹ that "there is a certain amount of regularity observable in the distribution of the sandy deserts over the vast uplands of central Asia. Two agencies are represented in the distribution of the sands, though what they really are is not quite clear; and of these two agencies one prevails in the north-west, the other in the south-east, so that the whole of Central Asia may be divided into two regions, the dividing line between them being drawn from north-east to south-west, from Urga via the eastern end of the Tian-shan to the city of Kashgar. North-west of this line the sandy masses are broken up into detached and disconnected areas, and are almost without exception heaped up around the lakes, and consequently in the lowest parts of the several districts in which they exist. Moreover, we find also that these sandy tracts always occur on the western or south-western shores of the lakes; this is the case with the lakes of Balkash, Ala-kul, Ebi-nor, Ayar-nor (or Telli-nor), Orku-nor, Zaisan-nor, Ulungur-nor, Ubsa-nor, Durgun-nor and Kara-nor lying E. of Kirghiz-nor. South-east of the line the arrangement of the sand is quite different. In that part of Asia we have three gigantic but disconnected basins. The first, lying farthest east, is embraced on the one side by the ramifications of the Kentei and Khanga Mountains and on the other by the In-shan Mountains. The second or middle division is contained between the Altai of the Gobi and the Ala-shan. The third basin, in the west, lies between the Tian-shan and the border ranges of western Tibet. The deepest parts of each of these three depressions occur near their northern borders; towards their southern boundaries they are all alike very much higher. . . . However, the sandy deserts are not found in the low-lying tracts but occur on the higher uplands which form the southern mountain ranges, the In-shan and the Nan-shan. Our maps show an immense expanse of sand south of the Tarim in the western basin; beginning in the neighbourhood of the city of Yarkent (Yarkand), it extends eastwards past the towns of Khotan, Keriya and Cherchen to Sa-chow. Along this stretch there is only one locality which forms an exception to the rule we have indicated, namely, the region round the lake of Lop-nor. In the middle basin the widest expanse of sand occurs between the Edzin-gol and the range of Ala-shan. On the south it extends nearly as far as a line drawn through the towns of Lian-chow, Kan-chow and Kao-tai at the foot of the Nan-shan; but on the south it does not approach anything like so far as the latitude (42° N.) of the lake of Ghashiun-nor. Still farther east come the sandy deserts of Ordos, extending south-eastward as far as the mountain range which separates Ordos from the (Chinese) provinces of Shan-si and Shen-si. In the eastern basin drift-sand is encountered between the district of Ude in the north (44° 30' N.) and the foot of the In-shan in the south." In two regions, if not in three, the sands have overwhelmed large tracts of once cultivated country, and even buried the cities in which men formerly dwelt. These regions are the southern parts of the desert of Takla-makan (where Sven Hedin and M. A. Stein² have discovered the ruins under the desert sands), along the N. foot of the Nan-shan, and probably in part (other agencies having helped) in the north of the desert of Lop, where Sven Hedin discovered the ruins of Lo-lan and of other towns or villages. For these vast accumulations of sand are constantly in movement; though the movement is slow, it has nevertheless been calculated that in the south of the Takla-makan the sand-dunes travel bodily at the rate of roughly something like 160 ft. in the course of a year. The shape and arrangement of the individual sand-dunes, and of the barkhans, generally indicate from which direction the predominant winds blow. On the windward side of the dune the slope is long and gentle, while the leeward side is steep and in outline concave like a horse-shoe. The dunes vary in height from 30 up to 300 ft., and in some places mount as it were upon one another's shoulders, and in some localities it is even said that a third tier is sometimes superimposed.

AUTHORITIES.—See N. M. Przhevalsky, *Mongolia, the Tangut Country, &c.* (Eng. trans., ed. by Sir H. Yule, London, 1876), and *From Kulja across the Tsan Shan to Lob Nor* (Eng. trans. by Delmar Morgan, London, 1879); G. N. Potanin, *Tsanguisho-Tibetshoo Okrasna Kitaya i Centralnaya Mongolia, 1884-1886* (1893, &c.); M. V. Pjevrtsov, *Sketch of a Journey to Mongolia* (in Russian, Omsk,

¹ In *Tsanguisho-Tibetshoo Okrasna Kitaya i Centralnaya Mongolia*, i. pp. 96, &c.

² See *Sand-buried Cities of Khotan* (London, 1902).

1883); G. E. Grun-Grzhimailo, *Opisanie Puteshestviya v Sepadnyy Khasi (1898-1899)*; V. A. Obruchev, *Centralnaya Aziya, Severnyy Khasi i Nan-shan, 1892-1894 (1900-1901)*; V. I. Roberovsky and P. K. Kozlov, *Trudy Ekspeditsii Imp. Russ. Geog. Obshchestva Po Centralnoy Azii, 1893-1895 (1900, etc.)*; Roberovsky, *Trudy Tibetsoy Ekspeditsii, 1889-1890*; Sven Hedin, *Scientific Results of a Journey in Central Asia, 1899-1902 (6 vols., 1905-1907)*; Futterer, *Durch Asien (1901, etc.)*; K. Bogdanovich, *Geoicheskaya Ispovedaniya v Vostochnom Turkestanie and Trudy Tibetsoy Ekspeditsii, 1889-1890*; L. von Loczy, *Die wissenschaftlichen Ergebnisse der Reise des Grafen Sitchenyi in Ostasien, 1877-1880 (1881)*; Ney Elias, in *Journ. Roy. Geog. Soc. (1873)*; C. W. Campbell's "Journeys in Mongolia," in *Geographical Journal (Nov. 1903)*; Posdnievym, *Mongolia and the Mongols (in Russian, St. Petersburg, 1897, etc.)*; Demker's summary of Kozlov's latest journeys in *La Géographie (1901, etc.)*; F. von Richtshofen, *China (1877)*.

GOBLET, RENÉ (1828-1905), French politician, was born at Aire-sur-la-Lys, in the Pas de Calais, on the 26th of November 1828, and was educated for the law. Under the Second Empire, he helped to found a Liberal journal, *Le Progrès de la Somme*, and in July 1871 was sent by the department of the Somme to the National Assembly, where he took his place on the extreme left. He failed to secure election in 1876, but next year was returned for Amiens. He held a minor government office in 1879, and in 1882 became minister of the interior in the Freycinet cabinet. He was minister of education, fine arts and religion in Henri Brisson's first cabinet in 1885, and again under Freycinet in 1886, when he greatly increased his reputation by an able defence of the government's education proposals. Meanwhile his extreme independence and excessive candour had alienated him from many of his party, and all through his life he was frequently in conflict with his political associates, from Gambetta downwards. On the fall of the Freycinet cabinet in December he formed a cabinet in which he reserved for himself the portfolios of the interior and of religion. The Goblet cabinet was unpopular from the outset, and it was with difficulty that anybody could be found to accept the ministry of foreign affairs, which was finally given to M. Flourens. Then came what is known as the Schnaebelé incident, the arrest on the German frontier of a French official named Schnaebelé, which caused immense excitement in France. For some days Goblet took no definite decision, but left Flourens, who stood for peace, to fight it out with General Boulanger, then minister of war, who was for the despatch of an ultimatum. Although he finally intervened on the side of Flourens, and peace was preserved, his weakness in face of the Boulangist propaganda became a national danger. Defeated on the budget in May 1887, his government resigned; but he returned to office next year as foreign minister in the radical administration of Charles Floquet. He was defeated at the polls by a Boulangist candidate in 1889, and sat in the senate from 1891 to 1893, when he returned to the popular chamber. In association with MM. E. Lockroy, Ferdinand Sarrien and P. L. Peytral he drew up a republican programme which they put forward in the *Petite République française*. At the elections of 1898 he was defeated, and thenceforward took little part in public affairs. He died in Paris on the 13th of September 1905.

GOBLET, a large type of drinking-vessel, particularly one shaped like a cup, without handles, and mounted on a shank with a foot. The word is derived from the O. Fr. *gobelet*, diminutive of *goblet*, *gobsons*, which Skeat takes to be formed from Low Lat. *cupellus*, cup, diminutive of *cupa*, tub, cask (see **DRAWING-VESSELS**).

GOBY. The gobies (*Gobius*) are small fishes readily recognized by their ventrals (the fins on the lower surface of the chest) being united into one fin, forming a suction disk, by which these fishes are enabled to attach themselves in every possible position to a rock or other firm substances. They are essentially coast-fishes, inhabiting nearly all seas, but disappearing towards the Arctic and Antarctic Oceans. Many enter, or live exclusively in, such fresh waters as are at no great distance from the sea. Nearly 500 different kinds are known. The largest British species, *Gobius capiv*, occurring in the rock-pools of Cornwall, measures 10 in. *Gobius alcocki*, from brackish and fresh waters of Lower Bengal, is one of the very smallest of fishes, not measuring over

16 millimetres (= 7 lines). The males are usually more brilliantly coloured than the females, and guard the eggs, which are often placed in a sort of nest made of the shell of some bivalve or of the carapace of a crab, with the convexity turned upwards and



FIG. 1.—*Gobius lentiginosus*.



FIG. 2.—United Ventrals of Goby.

covered with sand, the eggs being stuck to the inner surface of this roof.

Close allies of the gobies are the walking fish or jumping fish (*Periophthalmus*), of which various species are found in great



FIG. 3.—*Periophthalmus kodasteri*.

numbers on the mud flats at the mouths of rivers in the tropics, skipping about by means of the muscular, scaly base of their pectoral fins, with the head raised and bearing a pair of strongly-projecting versatile eyes close together.

GOCH, a town of Germany, in the Prussian Rhine province, on the Niern, 8 m. S. of Cleves at the junction of the railways Cologne-Zevenaar and Bortel-Wesel. Pop. (1905) 10,232. It has a Protestant and a Roman Catholic church and manufactures of brushes, plush goods, cigars and margarine. In the middle ages it was the seat of a large trade in linen. Goch became a town in 1231 and belonged to the dukes of Gelderland and later to the dukes of Cleves.

GOD, the common Teutonic word for a personal object of religious worship. It is thus, like the Gr. *θεός* and Lat. *deus*, applied to all those superhuman beings of the heathen mythologies who exercise power over nature and man and are often identified with some particular sphere of activity; and also to the visible material objects, whether an image of the supernatural being or a tree, pillar, &c. used as a symbol, an idol. The word "god," on the conversion of the Teutonic races to Christianity, was adopted as the name of the one Supreme Being, the Creator of the universe, and of the Persons of the Trinity. The *New English Dictionary* points out that whereas the old Teutonic type of the word is neuter, corresponding to the Latin *nomen*, in the Christian applications it becomes masculine, and that even where the earlier neuter form is still kept, as in Gothic it is *Gut*; Dutch has the same form as English; Danish and Swedish have *Gud*, German *Gott*. According to the *New English Dictionary*, the original may be found in two Aryan roots, both of the form *ghen*, one of which means "to invoke," the other "to pour" (cf. Gr. *χέω*); the last is used of sacrificial offerings. The word would thus mean the object either of religious invocation or of religious worship by sacrifice. It has been also suggested that the word might mean a "molten image" from the sense of "pour."

See **RELIGION; HEBREW RELIGION; TRINITY, &c.**

GODALMING, a market-town and municipal borough in the Guildford parliamentary division of Surrey, England, 34 m. S.W. of London by the London & South-Western railway. Pop. (1901) 8748. It is beautifully situated on the right bank of the Wey,

which is navigable thence to the Thames, and on the high road between London and Portsmouth. Steep hills, finely wooded, enclose the valley. The chief public buildings are the church of SS. Peter and Paul, a cruciform building of mixed architecture, but principally Early English and Perpendicular; the town-hall, Victoria hall, and market-house, and a technical institute and school of science and art. Charterhouse School, one of the principal English public schools, originally founded in 1611, was transferred from Charterhouse Square, London, to Godalming in 1872. It stands within grounds 92 acres in extent, half a mile north of Godalming, and consists of spacious buildings in Gothic style, with a chapel, library and hall, besides boarding-houses, masters' houses and sanatoria. (See CHARTERHOUSE.) Godalming has manufactures of paper, leather, parchment and hosiery, and some trade in corn, malt, bark, hoops and timber; and the Bargate stone, of which the parish church is built, is still quarried. The borough is under a mayor, 6 aldermen and 18 councillors. Area, 812 acres.

Godalming (Godelminge) belonged to King Alfred, and was a royal manor at the time of Domesday. The manor belonged to the see of Salisbury in the middle ages, but reverted to the crown in the time of Henry VIII. Godalming was incorporated by Elizabeth in 1574, when the borough originated. The charter was confirmed by James I. in 1620, and a fresh charter was granted by Charles II. in 1666. The borough was never represented in parliament. The bishop of Salisbury in 1300 received the grant of a weekly market to be held on Mondays: the day was altered to Wednesday by Elizabeth's charter. The bishop's grant included a fair at the feast of St Peter and St Paul (29th of June). Another fair at Candlemas (2nd of February) was granted by Elizabeth. The market is still held. The making of cloth, particularly Hampshire kerseys, was the staple industry of Godalming in the middle ages, but it began to decay early in the 17th century and by 1850 was practically extinct. As in other cases, dyeing was subsidiary to the cloth industry. Tanning, introduced in the 15th century, survives. The present manufacture of fleecy hosiery dates from the end of the 18th century.

GODARD, BENJAMIN LOUIS PAUL (1849-1895), French composer, was born in Paris, on the 18th of August 1849. He studied at the Conservatoire, and competed for the Prix de Rome without success in 1866 and 1867. He began by publishing a number of songs, many of which are charming, such as "Je ne veux pas d'autres choses," "Ninon," "Chanson de Florian," also a quantity of piano pieces, some chamber music, including several violin sonatas, a trio for piano and strings, a quartet for strings, a violin concerto and a second work of the same kind entitled "Concerto Romantique." Godard's chance arrived in the year 1878, when with his dramatic cantata, *Le Tasse*, he shared with M. Théodore Dubois the honour of winning the musical competition instituted by the city of Paris. From that time until his death Godard composed a surprisingly large number of works, including four operas, *Pedro de Zalamea*, produced at Antwerp in 1884; *Jocelyn*, given in Paris at the Théâtre du Château d'Eau, in 1888; *Dante*, played at the Opéra Comique two years later; and *La Vivandière*, left unfinished and partly scored by another hand. This last work was heard at the Opéra Comique in 1895, and has been played in England by the Carl Rosa Opera Company. His other works include the "Symphonie légendaire," "Symphonie gothique," "Diane" and various orchestral works. Godard's productivity was enormous, and his compositions are, for this reason only, decidedly unequal. He was at his best in works of smaller dimensions, and has left many exquisite songs. Among his more ambitious works the "Symphonie légendaire" may be singled out as being one of the most distinctive. He had a decided individuality, and his premature death at Cannes on the 10th of January 1895 was a loss to French art.

GODAVARI, a river of central and western India. It flows across the Deccan from the Western to the Eastern Ghats; its total length is 900 m., the estimated area of its drainage basin, 112,200 sq. m. Its traditional source is on the side of a hill behind the village of Trimbak in Nasik district, Bombay, where

the water runs into a reservoir from the lips of an image. But according to popular legend it proceeds from the same ultimate source as the Ganges, though underground. Its course is generally south-easterly. After passing through Nasik district, it crosses into the dominions of the nizam of Hyderabad. When it again strikes British territory it is joined by the Pranhita, with its tributaries the Wardha, the Penganga and Wainganga. For some distance it flows between the nizam's dominions and the Upper Godavari district, and receives the Indravati, the Tal and the Sabari. The stream has here a channel varying from 1 to 2 m. in breadth, occasionally broken by alluvial islands. Parallel to the river stretch long ranges of hills. Below the junction of the Sabari the channel begins to contract. The flanking hills gradually close in on both sides, and the result is a magnificent gorge only 200 yds. wide through which the water flows into the plain of the delta, about 60 m. from the sea. The head of the delta is at the village of Dowlaisheram, where the main stream is crossed by the irrigation anicut. The river has seven mouths, the largest being the Gautami Godavari. The Godavari is regarded as peculiarly sacred, and once every twelve years the great bathing festival called *Puskaram* is held on its banks at Rajahmundry.

The upper waters of the Godavari are scarcely utilized for irrigation, but the entire delta has been turned into a garden of perennial crops by means of the anicut at Dowlaisheram, constructed by Sir Arthur Cotton, from which three main canals are drawn off. The river channel here is 3½ m. wide. The anicut is a substantial mass of stone, bedded in lime cement, about 2½ m. long, 130 ft. broad at the base, and 12 ft. high. The stream is thus pent back so as to supply a volume of 3000 cubic ft. of water per second during its low season, and 12,000 cubic ft. at time of flood. The main canals have a total length of 493 m., irrigating 662,000 acres, and all navigable; and there are 1070 m. of distributary channels. In 1864 water-communication was opened between the deltas of the Godavari and Kistna. Rocky barriers and rapids obstruct navigation in the upper portion of the Godavari. Attempts have been made to construct canals round these barriers with little success, and the undertaking has been abandoned.

GODAVARI, a district of British India, in the north-east of the Madras presidency. It was remodelled in 1907-1908, when part of it was transferred to Kistna district. Its present area is 5634 sq. m. Its territory now lies mainly east of the Godavari river, including the entire delta, with a long narrow strip extending up its valley. The apex of the delta is at Dowlaisheram, where a great dam renders the waters available for irrigation. Between this point and the coast there is a vast extent of rice fields. Farther inland, and enclosing the valley of the great river, are low hills, steep and forest-clad. The north-eastern part, known as the Agency tract, is occupied by spurs of the Eastern Ghats. The coast is low, sandy and swampy, the sea very shallow, so that vessels must lie nearly 5 m. from Cocanada, the chief port. The Sabari is the principal tributary of the Godavari within the district. The Godavari often rises in destructive floods. The population of the present area in 1901 was 1,445,961. In the old district the increase during the last decade was 11%. The chief towns are Cocanada and Rajahmundry. The forests are of great value; coal is known, and graphite is worked. The population is principally occupied in agriculture, the principal crops being rice, oil-seeds, tobacco and sugar. The cigars known in England as Lunkas are partly made from tobacco grown on *lonkas* or islands in the river Godavari. Sugar (from the juice of the palmyra palm) and rum are made by European processes at Samalkot. The administrative headquarters are now at Cocanada, the chief seaport; but Rajahmundry, at the head of the delta, is the old capital. A large but decreasing trade is conducted at Cocanada, rice being shipped to Mauritius and Ceylon, and cotton and oil-seeds to Europe. Rice-cleaning mills have been established here and at other places. The district is traversed by the main line of the East Coast railway, with a branch to Cocanada; the iron girder bridge of forty-two spans over the

Godavari river near Rajahmundry was opened in 1900. There is a government college at Rajahmundry, with a training college attached, and an aided college at Cocanada.

The Godavari district formed part of the Andhra division of Dravida, the north-west portion being subject to the Orissa kings, and the south-western belonging to the Vengi kingdom. For centuries it was the battlefield on which various chiefs fought for independence with varying success till the beginning of the 16th century, when the whole country may be said to have passed under Mahomedan power. At the conclusion of the struggle with the French in the Carnatic, Godavari with the Northern Circars was conquered by the English, and finally ceded by imperial *sanad* in 1765. The district was constituted in 1859, by the redistribution of the territory comprising the former districts of Guntur, Rajahmundry and Masulipatam, into what are now the Kistna and Godavari districts.

See H. Morris, *District Manual* (1878); *District Gazetteer* (1906).

GODEFROY (GOTTHOFREDUS), a French noble family, which numbered among its members several distinguished jurists and historians. The family claimed descent from Symon Godefroy, who was born at Mons about 1320 and was lord of Sapigneux near Berry-au-bac, now in the department of Aisne.

DENIS GODEFROY (Dionysius Gothofredus) (1549-1622), jurist, son of Léon Godefroy, lord of Guignecourt, was born in Paris on the 17th of October 1549. He was educated at the Collège de Navarre, and studied law at Louvain, Cologne and Heidelberg, returning to Paris in 1573. He embraced the reformed religion, and in 1579 left Paris, where his abilities and connexions promised a brilliant career, to establish himself at Geneva. He became professor of law there, received the freedom of the city in 1580, and in 1587 became a member of the Council of the Two Hundred. Henry IV. induced him to return to France by making him *grand bailli* of Gez, but no sooner had he installed himself than the town was sacked and his library burnt by the troops of the duke of Savoy. In 1591 he became professor of Roman law at Strassburg, where he remained until April 1600, when in response to an invitation from Frederick IV., elector palatine, he removed to Heidelberg. The difficulties of his position led to his return to Strassburg for a short time, but in November 1604 he definitely settled at Heidelberg. He was made head of the faculty of law in the university, and was from time to time employed on missions to the French court. His repeated refusal of offers of advancement in his own country was due to his Calvinism. He died at Strassburg on the 7th of September 1622, having left Heidelberg before the city was sacked by the imperial troops in 1621. His most important work was the *Corpus juris civilis*, originally published at Geneva in 1583, which went through some twenty editions, the most valuable of them being that printed by the Elsevirs at Amsterdam in 1633 and the Leipzig edition of 1740.

Lists of his other learned works may be found in Senebier's *Hist. lit. de Genève*, vol. ii., and in Nicéron's *Mémoires*, vol. xvii. Some of his correspondence with his learned friends, with his kinsman President de Thou, Isaac Casaubon, Jean Jacques Grynæus and others, is preserved in the libraries of the British Museum, of Basel and Paris.

His eldest son, **THEODORE GODEFROY** (1580-1649), was born at Geneva on the 14th of July 1580. He abjured Calvinism, and was called to the bar in Paris. He became historiographer of France in 1613, and was employed from time to time on diplomatic missions. He was employed at the congress of Münster, where he remained after the signing of peace in 1648 as *chargé d'affaires* until his death on the 5th of October of the next year. His most important work is *Le Cérémonial de France* . . . (1619), a work which became a classic on the subject of royal ceremonial, and was re-edited by his son in an enlarged edition in 1649.

Besides his printed works he made vast collections of historical material which remains in MS. and fills the greater part of the Godefroy collection of over five hundred portfolios in the Library of the Institute in Paris. These were catalogued by Ludovic Lalanne in the *Annuaire Bulletin* (1865-1866 and 1892) of the *Société de l'histoire de France*.

The second son of Denis, **JACQUES GODEFROY** (1587-1652), jurist, was born at Geneva on the 13th of September 1587. He was sent to France in 1611, and studied law and history at Bourges and Paris. He remained faithful to the Calvinist persuasion, and soon returned to Geneva, where he became active in public affairs. He was secretary of state from 1632 to 1636, and syndic or chief magistrate in 1637, 1641, 1645 and 1649. He died on the 23rd of June 1652. In addition to his civic and political work he lectured on law, and produced, after thirty years of labour, his edition of the *Codex Theodosianus*. This code formed the principal, though not the only, source of the legal systems of the countries formed from the Western Empire. Godefroy's edition was enriched with a multitude of important notes and historical comments, and became a standard authority on the decadent period of the Western Empire. It was only printed thirteen years after his death under the care of his friend Antoine Marville at Lyons (4 vols. 1665), and was reprinted at Leipzig (6 vols.) in 1736-1745. Of his numerous other works the most important was the reconstruction of the twelve tables of early Roman law.

See also the dictionary of Moreri, Nicéron's *Mémoires* (vol. 17) and a notice in the *Bibliothèque universelle de Genève* (Dec. 1837).

DENIS GODEFROY (1615-1681), eldest son of Théodore, succeeded his father as historiographer of France, and re-edited various chronicles which had been published by him. He was entrusted by Colbert with the care and investigation of the records concerning the Low Countries preserved at Lille, where great part of his life was spent. He was also the historian of the reigns of Charles VII. and Charles VIII.

Other members of the family who attained distinction in the same branch of learning were the two sons of Denis Godefroy—Denis (1653-1719), also an historian, and Jean, sieur d'Aumont (1656-1732), who edited the letters of Louis XII., the memoirs of Marguerite de Valois, of Castelnaud and Pierre de l'Estoile, and left some useful material for the history of the Low Countries; Jean Baptiste Achille Godefroy, sieur de Maillart (1697-1759), and Denis Joseph Godefroy, sieur de Maillart (1740-1819), son and grandson of Jean Godefroy, who were both officials at Lille, and left valuable historical documents which have remained in MS.

For further details see *Les Savants Godefroy* (Paris, 1873) by the marquis de Godefroy-Ménilglaise, son of Denis Joseph Godefroy.

GODESBERG, a spa of Germany, in the Prussian Rhine province, on the left bank of the Rhine, almost opposite Königswinter, and 4 m. S. of Bonn, on the railway to Coblenz. It is a fashionable summer resort, and contains numerous pretty villas, the residences of merchants from Cologne, Elberfeld, Crefeld and other Rhenish manufacturing centres. It has an Evangelical and three Roman Catholic churches, a synagogue and several educational establishments. Its chalybeate springs annually attract a large number of visitors, and the pump-room, baths and public grounds are arranged on a sumptuous scale. On a conical basalt hill, close by, are the ruins, surmounted by a picturesque round tower, of Godesberg castle. Built by Archbishop Dietrich I. of Cologne in the 13th century, it was destroyed by the Bavarians in 1583.

See Dennert, *Godesberg, eine Perle des Rheins* (Godesberg, 1900).

GODET, FRÉDÉRIC LOUIS (1812-1900), Swiss Protestant theologian, was born at Neuchâtel on the 25th of October 1812. After studying theology at Neuchâtel, Bonn and Berlin, he was in 1850 appointed professor of theology at Neuchâtel. From 1851 to 1866 he also held a pastorate. In 1873 he became one of the founders of the free Evangelical Church of Neuchâtel, and professor in its theological faculty. He died there on the 29th of October 1900. A conservative scholar, Godet was the author of some of the most noteworthy French commentaries published in recent times.

His commentaries are on the Gospel of St John (2 vols., 1863-1865; 3rd ed., 1881-1888; Eng. trans. 1886, &c.); St Luke (2 vols., 1871; 3rd ed., 1888; Eng. trans. 1875, &c.); the Epistle to the Romans (2 vols., 1879-1880; 2nd ed., 1883-1890; Eng. trans., 1880, &c.); Corinthians (2 vols., 1886-1887; Eng. trans. 1886, &c.). His other

works include *Études bibliques* (2 vols., 1873-1874; 4th ed., 1889; Eng. trans. 1875 f.), and *Introduction au Nouveau Testament* (1893 f.; Eng. trans., 1894, &c.); *Lectures in Defence of the Christian Faith* (Eng. trans. 4th ed., 1900).

GODFREY, SIR EDMUND BERRY (1621-1678), English magistrate and politician, younger son of Thomas Godfrey (1586-1664), a member of an old Kentish family, was born on the 23rd of December 1621. He was educated at Westminster school and at Christ Church, Oxford, and after entering Gray's Inn became a dealer in wood. His business prospered. He was made a justice of the peace for the city of Westminster, and in September 1666 was knighted as a reward for his services as magistrate and citizen during the great plague in London; but in 1669 he was imprisoned for a few days for instituting the arrest of the king's physician, Sir Alexander Fraizer (d. 1681), who owed him money. The tragic events in Godfrey's life began in September 1678 when Titus Oates and two other men appeared before him with written information about the Popish Plot, and swore to the truth of their statements. During the intense excitement which followed the magistrate expressed a fear that his life was in danger, but took no extra precautions for safety. On the 12th of October he did not return home as usual, and on the 17th his body was found on Primrose Hill, Hampstead. Medical and other evidence made it certain that he had been murdered, and the excited populace regarded the deed as the work of the Roman Catholics. Two committees investigated the occurrence without definite result, but in December 1678 a certain Miles Prance, who had been arrested for conspiracy, confessed that he had shared in the murder. According to Prance the deed was instigated by some Roman Catholic priests, three of whom witnessed the murder, and was committed in the courtyard of Somerset House, where Godfrey was strangled by Robert Green, Lawrence Hill and Heary Berry, the body being afterwards taken to Hampstead. The three men were promptly arrested; the evidence of the informer William Bedloe, although contradictory, was similar on a few points to that of Prance, and in February 1679 they were hanged. Soon afterwards, however, some doubt was cast upon this story; a war of words ensued between Prance and others, and it was freely asserted that Godfrey had committed suicide. Later the falsehood of Prance's confession was proved and Prance pleaded guilty to perjury; but the fact remains that Godfrey was murdered. Godfrey was an excellent magistrate, and was very charitable both in public and in private life. Mr John Pollock, in the *Popish Plot* (London, 1903), confirms the view that the three men, Green, Hill and Berry, were wrongfully executed, and thinks the murder was committed by some Jesuits aided by Prance. Godfrey was feared by the Jesuits because he knew, through Oates, that on the 24th of April 1678 a Jesuit congregation had met at the residence of the duke of York to concert plans for the king's murder. He concludes thus: "The success of Godfrey's murder as a political move is indubitable. The duke of York was the pivot of the Roman Catholic scheme in England, and Godfrey's death saved both from utter ruin." On the other hand Mr Alfred Marks in his *Who killed Sir E. B. Godfrey?* (1905) maintains that suicide was the cause of Godfrey's death.

See the article OATES, TITUS, also R. Tuke, *Memoirs of the Life and Death of Sir Edmondbury Godfrey* (London, 1682); and G. Burnet, *History of my Own Time; The Reign of Charles II.*, edited by O. Airy (Oxford, 1900).

GODFREY OF BOUILLON (c. 1060-1100), a leader in the First Crusade, was the second son of Eustace II., count of Boulogne, by his marriage with Ida, daughter of Duke Godfrey II. of Lower Lorraine. He was designated by Duke Godfrey as his successor; but the emperor Henry IV. gave him only the mark of Antwerp, in which the lordship of Bouillon was included (1076). He fought for Henry, however, both on the Elster and in the siege of Rome; and he was invested in 1082 with the duchy of Lower Lorraine. Lorraine had been penetrated by Clunian influences, and Godfrey would seem to have been a man of notable piety. Accordingly, though he had himself served as an imperialist, and though the Germans in general had little sympathy with the Crusaders (*subsannabant . . . quasi delirantes*),

Godfrey, nevertheless, when the call came "to follow Christ," almost literally sold all that he had, and followed. Along with his brothers Eustace and Baldwin (the future Baldwin I. of Jerusalem) he led a German contingent, some 40,000 strong, along "Charlemagne's road," through Hungary to Constantinople, starting in August 1096, and arriving at Constantinople, after some difficulties in Hungary, in November. He was the first of the crusading princes to arrive, and on him fell the duty of deciding what the relations of the princes to the eastern emperor Alexius were to be. Eventually, after several disputes and some fighting, he did homage to Alexius in January 1097; and his example was followed by the other princes. From this time until the beginning of 1099 Godfrey appears as one of the minor princes, plodding onwards, and steadily fighting, while men like Bohemund and Raymond, Baldwin and Tancred were determining the course of events.

In 1099 he came once more to the front. The mass of the crusaders became weary of the political factions which divided some of their leaders; and Godfrey, who was more of a pilgrim than a politician, becomes the natural representative of this feeling. He was thus able to force the reluctant Raymond to march southward to Jerusalem; and he took a prominent part in the siege, his division being the first to enter when the city was captured. It was natural therefore that, when Raymond of Provence refused the offered dignity, Godfrey should be elected ruler of Jerusalem (July 22, 1099). He assumed the title not of king, but of "advocate" of the Holy Sepulchre. The new dignity proved still more onerous than honourable; and during his short reign of a year Godfrey had to combat the Arabs of Egypt, and the opposition of Raymond and the patriarch Dagobert. He was successful in repelling the Egyptian attack at the battle of Ascalon (August 1099); but he failed, owing to Raymond's obstinacy and greed, to acquire the town of Ascalon after the battle. Left alone, at the end of the autumn, with an army of some 2000 men, Godfrey was yet able, in the spring of 1100, probably with the aid of new pilgrims, to exact tribute from towns like Acre, Ascalon, Arsuf and Caesarea. But already, at the end of 1099 Dagobert, archbishop of Pisa, had been substituted as patriarch for Arnulf (who had been acting as vicar) by the influence of Bohemund; and Dagobert, whose vassal Godfrey had at once piously acknowledged himself, seems to have forced him to an agreement in April 1100, by which he promised Jerusalem and Jaffa to the patriarch, in case he should acquire in their place Cairo or some other town, or should die without issue. Thus were the foundations of a theocracy laid in Jerusalem; and when Godfrey died (July 1100) he left the question to be decided, whether a theocracy or a monarchy should be the government of the Holy Land.

Because he had been the first ruler in Jerusalem Godfrey was idolized in later saga. He was depicted as the leader of the crusades, the king of Jerusalem, the legislator who laid down the assizes of Jerusalem. He was none of these things. Bohemund was the leader of the crusades; Baldwin was first king; the assizes were the result of a gradual development. In still other ways was the figure of Godfrey idealized by the grateful tradition of later days; but in reality he would seem to have been a quiet, pious, hard-fighting knight, who was chosen to rule in Jerusalem because he had no dangerous qualities, and no obvious defects.

LITERATURE.—The narrative of Albert of Aix may be regarded as presenting the Lotharingian point of view, as the *Gesta* presents the Norman, and Raymond of Agiles the Provençal. The career of Godfrey has been discussed in modern times by R. Röhricht, *Die Deutschen im heiligen Lande*, Band ii., and *Geschichte des ersten Kreuzzuges*, passim (Innsbruck, 1901).

Romances.—Godfrey was the principal hero of two French *chansons de geste* dealing with the Crusade, the *Chanson d'Antioche* (ed. P. Paris, 2 vols., 1848) and the *Chanson de Jerusalem* (ed. C. Hippeau, 1868), and other poems, containing less historical

¹ An "advocate" was a layman who had been invested with part of an ecclesiastical estate, on condition that he defended the rest, and exercised the blood-ban in lieu of the ecclesiastical owner (see **ADVOCATE**, sec. *Advocatus ecclesiae*).

material, were subsequently added. In addition the parentage and early exploits of Godfrey were made the subject of legend. His grandfather was said to be Helias, knight of the Swan, one of the brothers whose adventures are well known, though with some variation, in the familiar fairy tale of "The Seven Swans." Helias, drawn by the swan, one day disembarked at Nijmegen, and reconquered her territory for the duchess of Bouillon. Marrying her daughter he exacted a promise that his wife should not inquire into his origin. The tale, which is almost identical with the Lohengrin legend, belongs to the class of the Cupid and Psyche narratives. See LOHENGRIN.

See also C. Hippau, *Le Chevalier au cygne* (Paris, 2 vols., 1874-1877); H. Pigeonneau, *Le Cycle de la croisade et de la famille de Bouillon* (1877); W. Golther, "Lohengrin," in *Roman. Forsch.* (vol. v., 1896); *Hist. litt. de la France*, vol. xxii, pp. 350-402; the English romance of *Helyas, Knyght of the Swanne* was printed by W. Copland about 1550.

GODFREY OF VITERBO (c. 1120-c. 1196), chronicler, was probably an Italian by birth, although some authorities assert that he was a Saxon. He evidently passed some of his early life at Viterbo, where also he spent his concluding days, but he was educated at Bamberg, gaining a good knowledge of Latin. About 1140 he became chaplain to the German king, Conrad III.; but the greater part of his life was spent as secretary (*notarius*) in the service of the emperor Frederick I., who appears to have thoroughly trusted him, and who employed him on many diplomatic errands. Incessantly occupied, he visited Sicily, France and Spain, in addition to many of the German cities, in the emperor's interests, and was by his side during several of the Italian campaigns. Both before and after Frederick's death in 1190 he enjoyed the favour of his son, the emperor Henry VI., for whom he wrote his *Speculum regum*, a work of very little value. Godfrey also wrote *Memoria seculorum*, or *Liber memorialis*, a chronicle dedicated to Henry VI., which professes to record the history of the world from the creation until 1185. It is written partly in prose and partly in verse. A revision of this work was drawn up by Godfrey himself as *Pantheon*, or *Universitatis libri qui chronici appellantur*. The author borrowed from Otto of Freising, but the earlier part of his chronicle is full of imaginary occurrences. *Pantheon* was first printed in 1559, and extracts from it are published by L. A. Muratori in the *Reum Italicarum scriptores*, tome viii. (Milan, 1725). The only part of Godfrey's work which is valuable is the *Gesta Friderici I.*, verses relating events in the emperor's career from 1155 to 1180. Concerned mainly with affairs in Italy, the poem tells of the sieges of Milan, of Frederick's flight to Pavia in 1167, of the treaty with Pope Alexander III. at Venice, and of other stirring episodes with which the author was intimately acquainted, and many of which he had witnessed. Attached to the *Gesta Friderici* is the *Gesta Heinrici VI.*, a shorter poem which is often attributed to Godfrey, although W. Wattenbach and other authorities think it was not written by him. The *Memoria seculorum* was very popular during the middle ages, and has been continued by several writers.

Godfrey's works are found in the *Monumenta Germaniae historica*, Band xxii. (Hanover, 1872). The *Gesta Friderici I. et Heinrici VI.* is published separately with an introduction by G. Walz (Hanover, 1872). See also H. Ullmann, *Gottfried von Viterbo* (Göttingen, 1863), and W. Wattenbach, *Deutschlands Geschichtsquellen*, Band ii. (Berlin, 1894). (A. W. H.)

GODHRA, a town of British India, administrative headquarters of the Panch Mahals district of Bombay, and also of the Rewa Kantha political agency; situated 52 m. N.E. of Baroda on the railway from Anand to Ratlam. Pop. (1901) 20,015. It has a trade in timber from the neighbouring forests.

GODIN, JEAN BAPTISTE ANDRÉ (1817-1888), French socialist, was born on the 26th of January 1817 at Esquehéries (Aisne). The son of an artisan, he entered an iron-works at an early age, and at seventeen made a tour of France as journeyman. Returning to Esquehéries in 1837, he started a small factory for the manufacture of castings for heating-stoves. The business increased rapidly, and for the purpose of railway facilities was transferred to Guise in 1846. At the time of Godin's death in 1888 the annual output was over four millions of francs (£1,600,000),

and in 1908 the employees numbered over 2000 and the output was over £280,000. An ardent disciple of Fourier, he advanced a considerable sum of money towards the disastrous Fourierist experiment of V. P. Considérant (q.v.) in Texas. He profited, however, by its failure, and in 1859 started the *familière* or community settlement of Guise on more carefully laid plans. It comprises, in addition to the workshops, three large buildings, four storeys high, capable of housing all the work-people, each family having two or three rooms. Attached to each building is a vast central court, covered with a glass roof, under which the children can play in all weathers. There are also crèches, nurseries, hospital, refreshment rooms and recreation rooms of various kinds, stores for the purchase of groceries, drapery and every necessity, and a large theatre for concerts and dramatic entertainments. In 1880 the whole was turned into a co-operative society, with provision by which it eventually became the property of the workers. In 1871 Godin was elected deputy for Aisne, but retired in 1876 to devote himself to the management of the *familière*. In 1882 he was created a knight of the legion of honour.

Godin was the author of *Solutions sociales* (1871); *Les Socialistes et les droits du travail* (1874); *Mutualité sociale* (1880); *La République du travail et la réforme parlementaire* (1889). See Bernardot, *Le Familistère de Guise et son fondateur* (Paris, 1887); Fischer, *Die Familistère Godin's* (Berlin, 1890); Lestelle, *Étude sur le Familistère de Guise* (Paris, 1904); D. F. P., *Le Familistère illustré, résultats de vingt ans d'association, 1880-1900* (Eng. trans., *Twenty-eight years of co-partnership at Guise*, by A. Williams, 1908).

GODIVA, a Saxon lady, who, according to the legend, rode naked through the streets of Coventry to gain from her husband a remission of the oppressive toll imposed on his tenants. The story is that she was the beautiful wife of Leofric, earl of Mercia and lord of Coventry. The people of that city suffering grievously under the earl's oppressive taxation, Lady Godiva appealed again and again to her husband, who obstinately refused to remit the tolls. At last, weary of her entreaties, he said he would grant her request if she would ride naked through the streets of the town. Lady Godiva took him at his word, and after issuing a proclamation that all persons should keep within doors or shut their windows, she rode through, clothed only in her long hair. One person disobeyed her proclamation, a tailor, ever afterwards known as Peeping Tom. He bored a hole in his shutters that he might see Godiva pass, and is said to have been struck blind. Her husband kept his word and abolished the obnoxious taxes.

The oldest form of the legend makes Godiva pass through Coventry market from one end to the other when the people were assembled, attended only by two soldiers, her long hair down so that none saw her, "apparentibus cruribus tamen candidissimis." This version is given in *Flores historiarum* by Roger of Wendover, who quoted from an earlier writer. The later story, with its episode of Peeping Tom, has been evolved by later chroniclers. Whether the lady Godiva of this story is the Godiva or Godgifu of history is undecided. That a lady of this name existed in the early part of the 11th century is certain, as evidenced by several ancient documents, such as the Stow charter, the Spalding charter and the Domesday survey, though the spelling of the name varies considerably. It would appear from *Liber Eliensis* (end of 12th century) that she was a widow when Leofric married her in 1040. In or about that year she aided in the founding of a monastery at Stow, Lincolnshire. In 1043 she persuaded her husband to build and endow a Benedictine monastery at Coventry. Her mark, "Ego Godiva Comitissa diu istud desideravi," was found on the charter given by her brother, Thorold of Bucknall—sheriff of Lincolnshire—to the Benedictine monastery of Spalding in 1051; and she is commemorated as benefactress of other monasteries at Leominster, Chester, Wenlock, Worcester and Evesham. She probably died a few years before the Domesday survey (1085-1086), and was buried in one of the porches of the abbey church. Dugdale (1656) says that a window, with representations of Leofric and Godiva, was placed in Trinity Church, Coventry, about the time of Richard II. The Godiva procession, a commemoration of the legendary ride instituted on the 31st of May

1678 as part of Coventry fair, was celebrated at intervals until 1826. From 1848 to 1887 it was revived, and recently further attempts have been made to popularize the pageant. The wooden effigy of Peeping Tom which, since 1812, has looked out on the world from a house at the north-west corner of Hertford Street, Coventry, represents a man in armour, and was probably an image of St George. It was removed from another part of the town to its present position.

GODKIN, EDWIN LAWRENCE (1831-1902), American publicist, was born in Moyné, county Wicklow, Ireland, on the 2nd of October 1831. His father, James Godkin, was a Presbyterian minister and a journalist, and the son, after graduating in 1851 at Queen's College, Belfast, and studying law in London, was in 1853-1855 war correspondent for the *London Daily News* in Turkey and Russia, being present at the capture of Sevastopol, and late in 1856 went to America and wrote letters to the same journal, giving his impressions of a tour of the southern states of the American Union. He studied law in New York City, was admitted to the bar in 1859, travelled in Europe in 1860-1862, wrote for the *London News* and the *New York Times* in 1862-1865, and in 1865 founded in New York City the *Nation*, a weekly projected by him long before, for which Charles Eliot Norton gained friends in Boston and James Miller McKim (1810-1874) in Philadelphia, and which Godkin edited until the end of the year 1899. In 1881 he sold the *Nation* to the *New York Evening Post*, and became an associate editor of the *Post*, of which he was editor-in-chief in 1883-1899, succeeding Carl Schurz. In the 'eighties he engaged in a controversy with Goldwin Smith over the Irish question. Under his leadership the *Post* broke with the Republican party in the presidential campaign of 1884, when Godkin's opposition to Blaine did much to create the so-called Mugwump party (see *MUGWUMP*), and his organ became thoroughly independent, as was seen when it attacked the Venezuelan policy of President Cleveland, who had in so many ways approximated the ideal of the *Post* and *Nation*. He consistently advocated currency reform, the gold basis, a tariff for revenue only, and civil service reform, rendering the greatest aid to the last cause. His attacks on Tammany Hall were so frequent and so virulent that in 1894 he was sued for libel because of biographical sketches of certain leaders in that organization—cases which never came up for trial. His opposition to the war with Spain and to imperialism was able and forcible. He retired from his editorial duties on the 30th of December 1899, and sketched his career in the *Evening Post* of that date. Although he recovered from a severe apoplectic stroke early in 1900, his health was shattered, and he died in Greenway, Devonshire, England, on the 21st of May 1902. Godkin shaped the lofty and independent policy of the *Post* and the *Nation*, which had a small but influential and intellectual class of readers. But as editor he had none of the personal magnetism of Greeley, for instance, and his superiority to the influence of popular feeling made Charles Dudley Warner style the *Nation* the "weekly judgment day." He was an economist of the school of Mill, urged the necessity of the abstraction called "economic man," and insisted that socialism put in practice would not improve social and economic conditions in general. In politics he was an enemy of sentimentalism and loose theories in government. He published *A History of Hungary, A.D. 300-1850* (1856), *Government* (1871, in the American Science Series), *Reflections and Comments* (1895), *Problems of Modern Democracy* (1896) and *Unforeseen Tendencies of Democracy* (1898).

See *Life and Letters of E. L. Godkin*, edited by Rollo Ogden (2 vols., New York, 1907).

GODMANCHESTER, a municipal borough in the southern parliamentary division of Huntingdonshire, England, on the right bank of the Ouse, 1 m. S.S.E. of Huntingdon, on a branch of the Great Eastern railway. Pop. (1901) 2017. It has a beautiful Perpendicular church (St Mary's) and an agricultural trade, with flour mills. The town is governed by a mayor, 4 aldermen and 12 councillors. Area, 4907 acres.

A Romano-British village occupied the site of Godmanchester.

The town (*Gumencestre, Gomecestre*) belonged to the king before the Conquest and at the time of the Domesday survey. In 1213 King John granted the manor to the men of the town at a fee-farm of £120 yearly, and confirmation charters were granted by several succeeding kings, Richard II. in 1391-1392 adding exemption from toll, pannage, &c. James I. granted an incorporation charter in 1605 under the title of bailiffs, assistants and commonalty, but under the Municipal Reform Act of 1835 the corporation was changed to a mayor, 4 aldermen and 12 councillors. Godmanchester was formerly included for parliamentary purposes in the borough of Huntingdon, which has ceased to be separately represented since 1885. The incorporation charter of 1605 recites that the burgesses are chiefly engaged in agriculture, and grants them a fair, which still continues every year on Tuesday in Easter week.

See *Victoria County History, Huntingdon*; Robert Fox, *The History of Godmanchester* (1831).

GÖDÖLLÖ, a market town of Hungary, in the county of Pest-Pilis-Solt-Kiskun, 23 m. N.E. of Budapest by rail. Pop. (1900) 5875. Gödöllő is the summer residence of the Hungarian royal family, and the royal castle, built in the second half of the 18th century by Prince Anton Grassalkovich, was, with the beautiful domain, presented by the Hungarian nation to King Francis Joseph I. after the coronation in 1867. In its park there are a great number of stags and wild boars. Gödöllő is a favourite summer resort of the inhabitants of Budapest. In its vicinity is the famous place of pilgrimage Mária-Besnyő, with a fine Franciscan monastery, which contains the tombs of the Grassalkovich family.

GODOLPHIN, SIDNEY GODOLPHIN, EARL OF (c. 1645-1712), was a cadet of an ancient family of Cornwall. At the Restoration he was introduced into the royal household by Charles II., with whom he had previously become a favourite, and he also at the same period entered the House of Commons as member for Helston. Although he very seldom addressed the House, and when he did so, only in the briefest manner, he gradually acquired a reputation as its chief if not its only financial authority. In March 1679 he was appointed a member of the privy council, and in the September following he was promoted, along with Viscount Hyde (afterwards earl of Rochester) and the earl of Sunderland, to the chief management of affairs. Though he voted for the Exclusion Bill in 1680, he was continued in office after the dismissal of Sunderland, and in September 1684 he was created Baron Godolphin of Kialton, and succeeded Rochester as first lord of the treasury. After the accession of James II. he was made chamberlain to the queen, and, along with Rochester and Sunderland, enjoyed the king's special confidence. In 1687 he was named commissioner of the treasury. He was one of the council of five appointed by King James to represent him in London, when he went to join the army after the landing of William, prince of Orange, in England, and, along with Halifax and Nottingham, he was afterwards appointed a commissioner to treat with the prince. On the accession of William, though he only obtained the third seat at the treasury board, he had virtually the chief control of affairs. He retired in March 1690, but was recalled on the November following and appointed first lord. While holding this office he for several years continued, in conjunction with Marlborough, a treacherous intercourse with James II., and is said even to have anticipated Marlborough in disclosing to James intelligence regarding the intended expedition against Brest. Godolphin was not only a Tory by inheritance, but had a romantic admiration for the wife of James II. He also wished to be safe whatever happened, and his treachery in this case was mostly due to caution. After Fenwick's confession in 1696 regarding the attempted assassination of William III., Godolphin, who was compromised, was induced to tender his resignation; but when the Tories came into power in 1700, he was again appointed lord treasurer and retained office for about a year. Though not a favourite with Queen Anne, he was, after her accession, appointed to his old office, on the strong recommendation of Marlborough. He also in 1704 received the honour of knighthood, and in December

1706 he was created Viscount Rialton and earl of Godolphin. Though a Tory he had an active share in the intrigues which gradually led to the predominance of the Whigs in alliance with Marlborough. The influence of the Marlboroughs with the queen was, however, gradually supplanted by that of Mrs Masham and Harley, earl of Oxford, and with the fortunes of the Marlboroughs those of Godolphin were indissolubly united. The services of both were so appreciated by the nation that they were able for a time to regard the loss of the queen's favour with indifference, and even in 1708 to procure the expulsion of Harley from office; but after the Tory reaction which followed the impeachment of Dr Sacheverel, who abused Godolphin under the name of Volpone, the queen made use of the opportunity to take the initiatory step towards delivering herself from the irksome thralldom of Marlborough by abruptly dismissing Godolphin from office on the 7th of August 1710. He died on the 15th of September 1712.

Godolphin owed his rise to power and his continuance in it under four sovereigns chiefly to his exceptional mastery of financial matters; for if latterly he was in some degree indebted for his promotion to the support of Marlborough, he received that support mainly because Marlborough recognized that for the prosecution of England's foreign wars his financial abilities were an indispensable necessity. He was cool, reserved and cautious, but his prudence was less associated with high sagacity than traceable to the weakness of his personal antipathies and prejudices, and his freedom from political predilections. Perhaps it was his unlikeness to Marlborough in that moral characteristic which so tainted Marlborough's greatness that rendered possible between them a friendship so intimate and undisturbed: he was, it would appear, exceptionally devoid of the passion of avarice; and so little advantage did he take of his opportunities of aggrandizement that, though his style of living was unostentatious,—and in connexion with his favourite pastimes of horse-racing, card-playing and cock-fighting he gained perhaps more than he lost,—all that he left behind him did not, according to the duchess of Marlborough, amount to more than £12,000.

Godolphin married Margaret Blagge, the pious lady whose life was written by Evelyn, on the 16th of May 1675, and married again after her death in 1678. His son and successor, Francis (1678-1766), held various offices at court, and was lord privy seal from 1735 to 1740. He married Henrietta Churchill (d. 1733), daughter of the duke of Marlborough, who in 1722 became in her own right duchess of Marlborough. He died without male issue in January 1766, when the earldom became extinct, and the estates passed to Thomas Osborne, 4th duke of Leeds, the husband of the earl's daughter Mary, whose descendant is the present representative of the Godolphins.

A life of Godolphin was published in 1888 in London by the Hon. H. Elliot.

GODOY, ALVAREZ DE FARIA, RIOS SANCHEZ Y ZARZOSA, MANUEL DE (1767-1851), duke of El Alcudia and prince of the Peace, Spanish royal favourite and minister, was born at Badajoz on the 12th of May 1767. His father, Don José de Godoy, was the head of a very ancient but impoverished family of nobles in Estremadura. His mother, whose maiden name was Maria Antonia Alvarez de Faria, belonged to a Portuguese noble family. Manuel boasts in his memoirs that he had the best masters, but it is certain that he received only the very slight education usually given at that time to the sons of provincial nobles. In 1784 he entered the Guardia de Corps, a body of gentlemen who acted as the immediate body-guard of the king. His well-built and stalwart person, his handsome foolish face, together with a certain geniality of character which he must have possessed, earned him the favour of Maria Luisa of Parma, the princess of Asturias, a coarse, passionate woman who was much neglected by her husband, who on his part cared for nothing but hunting.

When King Charles III. died in 1788, Godoy's fortune was soon made. The princess of Asturias, now queen, understood how to manage her husband Charles IV. Godoy says in his

memoirs that the king, who had been carefully kept apart from affairs during his father's life, and who disliked his father's favourite minister Floridablanca, wished to have a creature of his own. This statement is no doubt true as far as it goes. But it requires to be completed by the further detail that the queen put her lover in her husband's way, and that the king was guided by them, when he thought he was ruling for himself through a subservient minister. In some respects King Charles was obstinate, and Godoy is probably right in saying that he never was an absolute "viceroy," and that he could not always secure the removal of colleagues whom he knew to be his enemies. He could only rule by obeying. Godoy adopted without scruple this method of pushing his fortunes. When the king was set on a particular course, he followed it; the execution was left to him and the queen. His pliability endeared him to his master, whose lasting affection he earned. In practice he commonly succeeded in inspiring the wishes which he then proceeded to gratify. From the very beginning of the new reign he was promoted in the army with scandalous rapidity, made duke of El Alcudia, and in 1792 minister under the premiership of Aranda, whom he succeeded in displacing by the close of the year.

His official life is fairly divided by himself into three periods. From 1792 to 1798 he was premier. In the latter year his unpopularity and the intrigues of the French government, which had taken a dislike to him, led to his temporary retirement, without, however, any diminution of the king's personal favour. He asserts that he had no wish to return to office, but letters sent by him to the queen show that he begged for employment. They are written in a very unpleasant mixture of gush and vulgar familiarity. In 1801 he returned to office, and until 1807 he was the executant of the disastrous policy of the court. The third period of his public life is the last year, 1807-1808, when he was desperately striving for his place between the aggressive intervention of Napoleon on the one hand, and the growing hatred of the nation, organized behind, and about, the prince of Asturias, Ferdinand. On the 17th of March 1808 a popular outbreak at Aranjuez drove him into hiding. When driven out by hunger and thirst he was recognized and arrested. By Ferdinand's order he was kept in prison, till Napoleon demanded that he should be sent to Bayonne. Here he rejoined his master and mistress. He remained with them till Charles IV. died at Rome in 1819, having survived his queen. The rest of Godoy's life was spent in poverty and obscurity. After the death of Ferdinand VII., in 1833, he returned to Madrid, and endeavoured to secure the restoration of his property confiscated in 1808. Part of it was the estate of the Soto de Roma, granted by the cortes to the duke of Wellington. He failed, and during his last years lived on a small pension granted him by Louis Philippe. He died in Paris on the 4th of October 1851.

As a favourite Godoy is remarkable for the length of his hold on the affection of his sovereigns, and for its completeness. Latterly he was supported rather by the husband than by the wife. He got rid of Aranda by adopting, in order to please the king, a policy which tended to bring on war with France. When the war proved disastrous, he made the peace of Basle, and was created prince of the Peace for his services. Then he helped to make war with England, and the disasters which followed only made him dearer to the king. Indeed it became a main object with Charles IV. to protect "Manuelito" from popular hatred, and if possible secure him a principality. The queen endured his infidelities to her, which were flagrant. The king arranged a marriage for him with Doña Teresa de Bourbon, daughter of the infante Don Luis by a morganatic marriage, though he was probably already married to Doña Josefa Tudó, and certainly continued to live with her. Godoy, in his memoirs, lays claim to have done much for Spanish agriculture and industry, but he did little more than issue proclamations and appoint officers. His intentions may have been good, but the policy of his government was financially ruinous. In his private life he was not only profligate and profuse, but childishly ostentatious. The best that can be said for him is that he was good-natured, and

did his best to restrain the Inquisition and the purely reactionary parties.

AUTHORITIES.—Godoy's *Memoirs* were published in Spanish, English and French in 1836. A general account of his career will be found in the *Mémoires sur la Révolution d'Espagne*, by the Abbé de Pradt (1816).

GODROON, or **GADROON** (Fr. *godron*, of unknown etymology), in architecture, a convex decoration (said to be derived from raised work on linen) applied in France to varieties of the bead and reel, in which the bead is often carved with ornament. In England the term is constantly used by auctioneers to describe the raised convex decorations under the bowl of stone or terracotta vases. The godroons radiate from the vertical support of the vase and rise half-way up the bowl.

GODWIN, FRANCIS (1562-1633), English divine, son of Thomas Godwin, bishop of Bath and Wells, was born at Hannington, Northamptonshire, in 1562. He was elected student of Christ Church, Oxford, in 1578, took his bachelor's degree in 1580, and that of master in 1583. After holding two Somersetshire livings he was in 1587 appointed subdean of Exeter. In 1590 he accompanied William Camden on an antiquarian tour through Wales. He was created bachelor of divinity in 1593, and doctor in 1595. In 1601 he published his *Catalogue of the Bishops of England since the first planting of the Christian Religion in this Island*, a work which procured him in the same year the bishopric of Llandaff. A second edition appeared in 1615, and in 1616 he published an edition in Latin with a dedication to King James, who in the following year conferred upon him the bishopric of Hereford. The work was republished, with a continuation by William Richardson, in 1743. In 1616 Godwin published *Rerum Anglicarum, Henrico VIII., Edwardo VI. et Maria regnantibus, Annales*, which was afterwards translated and published by his son Morgan under the title *Annales of England* (1630). He is also the author of a somewhat remarkable story, published posthumously in 1638, and entitled *The Man in the Moone, or a Discourse of a Voyage thither, by Domingo Gonsales*, written apparently some time between the years 1599 and 1603. In this production Godwin not only declares himself a believer in the Copernican system, but adopts so far the principles of the law of gravitation as to suppose that the earth's attraction diminishes with the distance. The work, which displays considerable fancy and wit, was translated into French, and was imitated in several important particulars by Cyrano de Bergerac, from whom (if not from Godwin direct) Swift obtained valuable hints in writing of Gulliver's voyage to Laputa. Another work of Godwin's, *Nunciatus inanimatus Uspiae*, originally published in 1629 and again in 1657, seems to have been the prototype of John Wilkins's *Mercury, or the Secret and Swift Messenger*, which appeared in 1641. He died, after a lingering illness, in April 1633.

GODWIN, MARY WOLLSTONECRAFT (1759-1797), English miscellaneous writer, was born at Hoxton, on the 27th of April 1759. Her family was of Irish extraction, and Mary's grandfather, who was a respectable manufacturer in Spitalfields, realized the property which his son squandered. Her mother, Elizabeth Dixon, was Irish, and of good family. Her father, Edward John Wollstonecraft, after dissipating the greater part of his patrimony, tried to earn a living by farming, which only plunged him into deeper difficulties, and he led a wandering, shiftless life. The family roamed from Hoxton to Edmonton, to Essex, to Beverley in Yorkshire, to Laugharne, Pembrokeshire, and back to London again.

After Mrs Wollstonecraft's death in 1780, soon followed by her husband's second marriage, the three daughters, Mary, Everina and Eliza, sought to earn their own livelihood. The sisters were all clever women—Mary and Eliza far above the average—but their opportunities of culture had been few. Mary, the eldest, went in the first instance to live with her friend Fanny Blood, a girl of her own age, whose father, like Wollstonecraft, was addicted to drink and dissipation. As long as she lived with the Bloods, Mary helped Mrs Blood to earn money by taking in needlework, while Fanny painted in water-colours. Everina went to live with her brother Edward, and

Eliza made a hasty and, as it proved, unhappy marriage with a Mr Bishop. A legal separation was afterwards obtained, and the sisters, together with Fanny Blood, took a house, first at Islington, afterwards at Newington Green, and opened a school, which was carried on with indifferent success for nearly two years. During their residence at Newington Green, Mary was introduced to Dr Johnson, who, as Godwin tells us, "treated her with particular kindness and attention."

In 1785 Fanny Blood married Hugh Skeyes, a merchant, and went with him to Lisbon, where she died in childbirth after sending for Mary to nurse her. "The loss of Fanny," as she said in a letter to Mrs Skeyes's brother, George Blood, "was sufficient of itself to have cast a cloud over my brightest days. . . . I have lost all relias for pleasure, and life seems a burden almost too heavy to be endured." Her first novel, *Mary, a Fiction* (1788), was intended to commemorate her friendship with Fanny. After closing the school at Newington Green, Mary became governess in the family of Lord Kingsborough, in Ireland. Her pupils were much attached to her, especially Margaret King, afterwards Lady Mountcasbel; and indeed, Lady Kingsborough gave the reason for dismissing her after one year's service that the children loved their governess better than their mother. Mary now resolved to devote herself to literary work, and she was encouraged by Johnson, the publisher in St Paul's churchyard, for whom she acted as literary adviser. She also undertook translations, chiefly from the French. *The Elements of Morality* (1790) from the German of Salzmann, illustrated by Blake, an old-fashioned book for children, and Lavater's *Physiognomy* were among her translations. Her *Original Stories from Real Life* were published in 1791, and, with illustrations by Blake, in 1796. In 1792 appeared *A Vindication of the Rights of Woman*, the work with which her name is always associated.

It is not among the least oddities of this book that it is dedicated to M. Talleyrand Périgord, late bishop of Autun. Mary Wollstonecraft still believed him to be sincere, and working in the same direction as herself. In the dedication she states the "main argument" of the work, "built on this simple principle that, if woman be not prepared by education to become the companion of man, she will stop the progress of knowledge, for truth must be common to all, or it will be inefficacious with respect to its influence or general practice." In carrying out this argument she used great plainness of speech, and it was this that caused all, or nearly all, the outcry. For she did not attack the institution of marriage, nor assail orthodox religion; her book was really a plea for equality of education, passing into one for state education and for the joint education of the sexes. It was a protest against the assumption that woman was only the plaything of man, and she asserted that intellectual companionship was the chief, as it is the lasting, happiness of marriage. She thus directly opposed the teaching of Rousseau, of whom she was in other respects an ardent disciple.

Mrs Wollstonecraft, as she now styled herself, desired to watch the progress of the Revolution in France, and went to Paris in 1792. Godwin, in his memoir of his wife, considers that the change of residence may have been prompted by the discovery that she was becoming attached to Henry Fuseli, but there is little to confirm this surmise; indeed, it was first proposed that she should go to Paris in company with him and his wife, nor was there any subsequent breach in their friendship. She remained in Paris during the Reign of Terror, when communication with England was difficult or almost impossible. Some time in the spring or summer of 1793 Captain Gilbert Imlay, an American, became acquainted with Mary—an acquaintance which ended in a more intimate connexion. There was no legal ceremony of marriage, and it is doubtful whether such a marriage would have been valid at the time; but she passed as Imlay's wife, and Imlay himself terms her in a legal document, "Mary Imlay, my best friend and wife." In August 1793 Imlay was called to Havre on business, and was absent for some months, during which time most of the letters published after her death by Godwin were written. Towards the end of the year she joined Imlay at Havre, and there in the spring of 1794 she gave birth to a girl,

who received the name of Fanny, in memory of the dear friend of her youth. In this year she published the first volume of a never completed *Historical and Moral View of the French Revolution*. Imlay became involved in a multitude of speculations, and his affection for Mary and their child was already waning. He left Mary for some months at Havre. In June 1795, after joining him in England, Mary left for Norway on business for Imlay. Her letters from Norway, divested of all personal details, were afterwards published. She returned to England late in 1795, and found letters awaiting her from Imlay, intimating his intention to separate from her, and offering to settle an annuity on her and her child. For herself she rejected this offer with scorn: "From you," she wrote, "I will not receive anything more. I am not sufficiently humbled to depend on your beneficence." They met again, and for a short time lived together, until the discovery that he was carrying on an intrigue under her own roof drove her to despair, and she attempted to drown herself by leaping from Putney bridge, but was rescued by watermen. Imlay now completely deserted her, although she continued to bear his name.

In 1796, when Mary Wollstonecraft was living in London, supporting herself and her child by working, as before, for Mr Johnson, she met William Godwin. A friendship sprang up between them,—a friendship, as he himself says, which "melted into love." Godwin states that "ideas which he is now willing to denigrate prejudices made him by no means willing to conform to the ceremony of marriage"; but these prejudices were overcome, and they were married at St Pancras church on the 29th of March 1797. And now Mary had a season of real calm in her stormy existence. Godwin, for once only in his life, was stirred by passion, and his admiration for his wife equalled his affection. But their happiness was of short duration. The birth of her daughter Mary, afterwards the wife of Percy Bysshe Shelley, on the 30th of August 1797, proved fatal, and Mrs Godwin died on the 10th of September following. She was buried in the churchyard of Old St Pancras, but her remains were afterwards removed by Sir Percy Shelley to the churchyard of St Peter's, Bournemouth.

Her principal published works are as follows:—*Thoughts on the Education of Daughters*, . . . (1787); *The Female Reader* (selections) (1789); *Original Stories from Real Life* (1791); *An Historical and Moral View of the Origin and Progress of the French Revolution, and the effects it has produced in Europe*, vol. i. (no more published) (1792); *Vindication of the Rights of Woman* (1792); *Vindication of the Rights of Man* (1793); *Mary, a Fiction* (1788); *Letters written during a Short Residence in Sweden, Norway and Denmark* (1796); *Posthumous Works* (4 vols., 1798). It is impossible to trace the many articles contributed by her to periodical literature.

A memoir of her life was published by Godwin in 1798. A large portion of C. Kegan Paul's work, *William Godwin, his Friends and Contemporaries*, was devoted to her, and an edition of the *Letters to Imlay* (1879), of which the first edition was published by Godwin, is prefaced by a somewhat fuller memoir. See also E. Dowden, *The French Revolution and English Literature* (1897) pp. 82 et seq.; E. R. Pennell, *Mary Wollstonecraft Godwin* (1885), in the *Eminent Women Series*; E. R. Clough, *A Study of Mary Wollstonecraft and the Rights of Woman* (1896); an edition of her *Original Stories* (1906), with William Blake's illustrations and an introduction by E. V. Lucas; and the *Love Letters of Mary Wollstonecraft to Gilbert Imlay* (1908), with an introduction by Roger Inghen.

GODWIN, WILLIAM (1756-1836), English political and miscellaneous writer, son of a Nonconformist minister, was born on the 3rd of March 1756, at Wisbeach in Cambridgeshire. His family came on both sides of middle-class people, and it was probably only as a joke that Godwin, a stern political reformer and philosophical radical, attempted to trace his pedigree to a time before the Norman conquest and the great earl Godwine. Both parents were strict Calvinists. The father died young, and never inspired love or much regret in his son; but in spite of wide differences of opinion, tender affection always subsisted between William Godwin and his mother, until her death at an advanced age.

William Godwin was educated for his father's profession at Hoxton Academy, where he was under Andrew Kippis the biographer and Dr Abraham Rees of the *Cyclopædia*, and was at first more Calvinistic than his teachers, becoming a Sande-

manian, or follower of John Glas (q.v.), whom he describes as "a celebrated north-country apostle who, after Calvin had damned ninety-nine in a hundred of mankind, has contrived a scheme for damning ninety-nine in a hundred of the followers of Calvin." He then acted as a minister at Ware, Stowmarket and Beaconsfield. At Stowmarket the teachings of the French philosophers were brought before him by a friend, Joseph Fawcett, who held strong republican opinions. He came to London in 1782, still nominally a minister, to regenerate society with his pen—a real enthusiast, who shrank theoretically from no conclusions from the premises which he laid down. He adopted the principles of the Encyclopædists, and his own aim was the complete overthrow of all existing institutions, political, social and religious. He believed, however, that calm discussion was the only thing needful to carry every change, and from the beginning to the end of his career he deprecated every approach to violence. He was a philosophic radical in the strictest sense of the term.

His first published work was an anonymous *Life of Lord Chatham* (1783). Under the inappropriate title *Sketches of History* (1784) he published under his own name six sermons on the characters of Aaron, Hazael and Jesus, in which, though writing in the character of an orthodox Calvinist, he enunciates the proposition "God Himself has no right to be a tyrant." Introduced by Andrew Kippis, he began to write in 1785 for the *Annual Register* and other periodicals, producing also three novels now forgotten. The "Sketches of English History" written for the *Annual Register* from 1785 onward still deserve study. He joined a club called the "Revolutionists," and associated much with Lord Stanhope, Home Tooke and Holcroft. His clerical character was now completely dropped.

In 1793 Godwin published his great work on political science, *The Inquiry concerning Political Justice, and its Influence on General Virtue and Happiness*. Although this work is little known and less read now, it marks a phase in English thought. Godwin could never have been himself a worker on the active stage of life. But he was none the less a power behind the workers, and for its political effect, *Political Justice* takes its place with Milton's *Areopagitica*, with Locke's *Essay on Education* and with Rousseau's *Émile*. By the words "political justice" the author meant "the adoption of any principle of morality and truth into the practice of a community," and the work was therefore an inquiry into the principles of society, of government and of morals. For many years Godwin had been "satisfied that monarchy was a species of government unavoidably corrupt," and from desiring a government of the simplest construction, he gradually came to consider that "government by its very nature counteracts the improvement of original mind." Believing in the perfectibility of the race, that there are no innate principles, and therefore no original propensity to evil, he considered that "our virtues and our vices may be traced to the incidents which make the history of our lives, and if these incidents could be divested of every improper tendency, vice would be extirpated from the world." All control of man by man was more or less intolerable, and the day would come when each man, doing what seems right in his own eyes, would also be doing what is in fact best for the community, because all will be guided by principles of pure reason. But all was to be done by discussion, and matured change resulting from discussion. Hence, while Godwin thoroughly approved of the philosophic schemes of the precursors of the Revolution, he was as far removed as Burke himself from agreeing with the way in which they were carried out. So logical and uncompromising a thinker as Godwin could not go far in the discussion of abstract questions without exciting the most lively opposition in matters of detailed opinion. An affectionate son, and ever ready to give of his hard-earned income to more than one ne'er-do-well brother, he maintained that natural relationship had no claim on man, nor was gratitude to parents or benefactors any part of justice or virtue. In a day when the penal code was still extremely severe, he argued gravely against all punishments, not only that of death. Property was to belong to him who most wanted it;

accumulated property was a monstrous injustice. Hence marriage, which is law, is the worst of all laws, and as property the worst of all properties. A man so passionless as Godwin could venture thus to argue without suspicion that he did so only to gratify his wayward desires. Portions of this treatise, and only portions, found ready acceptance in those minds which were prepared to receive them. Perhaps no one received the whole teaching of the book. But it gave cohesion and voice to philosophic radicalism; it was the manifesto of a school without which liberalism of the present day had not been. Godwin himself in after days modified his communistic views, but his strong feeling for individualism, his hatred of all restrictions on liberty, his trust in man, his faith in the power of reason remained; it was a manifesto which enunciated principles modifying action, even when not wholly ruling it.

In May 1794 Godwin published the novel of *Caleb Williams, or Things as they are*, a book of which the political object is overlooked by many readers in the strong interest of the story. The book was dramatized by the younger Colman as *The Iron Chest*. It is one of the few novels of that time which may be said still to live.¹ A theorist who lived mainly in his study, Godwin yet came forward boldly to stand by prisoners arraigned of high treason in that same year—1794. The danger to persons so charged was then great, and he deliberately put himself into this same danger for his friends. But when his own trial was discussed in the privy council, Pitt sensibly held that *Political Justice*, the work on which the charge could best have been founded, was priced at three guineas, and could never do much harm among those who had not three shillings to spare.

From this time Godwin became a notable figure in London society, and there was scarcely an important person in politics, on the Liberal side, in literature, art or science, who does not appear familiarly in the pages of Godwin's singular diary. For forty-eight years, beginning in 1788, and continuing to the very end of his life, Godwin kept a record of every day, of the work he did, the books he read, the friends he saw. Condensed in the highest degree, the diary is yet easy to read when the style is once mastered, and it is a great help to the understanding of his cold, methodical, unimpassioned character. He carried his method into every detail of life, and lived on his earnings with extreme frugality. Until he made a large sum by the publication of *Political Justice*, he lived on an average of £120 a year.

In 1797, the intervening years having been spent in strenuous literary labour, Godwin married Mary Wollstonecraft (see GODWIN, MARY WOLLSTONECRAFT). Since both held the same views regarding the slavery of marriage, and since they only married at all for the sake of possible offspring, the marriage was concealed for some time, and the happiness of the avowed married life was very brief; his wife's death on the 10th of September left Godwin prostrated by affliction, and with a charge for which he was wholly unfit—his infant daughter Mary, and her stepsister, Fanny Imlay, who from that time bore the name of Godwin. His unfitness for the cares of a family, far more than love, led him to contract a second marriage with Mary Jane Clairmont in 1801. She was a widow with two children, one of whom, Clara Mary Jane Clairmont, became the mistress of Lord Byron. The second Mrs Godwin was energetic and painstaking, but a harsh stepmother; and it may be doubted whether the children were not worse off under her care than they would have been under Godwin's neglect.

The second novel which proceeded from Godwin's pen was called *St Leon*, and published in 1799. It is chiefly remarkable for the beautiful portrait of Marguerite, the heroine, drawn from the character of his own wife. His opinions underwent a change in the direction of theism, influenced, he says, by his acquaintance with Coleridge. He also became known to Wordsworth and Lamb. Study of the Elizabethan dramatists led to the production in 1800 of the *Tragedy of Antonio*. Kemble brought it out at Drury Lane, but the failure of this attempt made him refuse

¹ For an analysis of *Caleb Williams* see the chapter on "Theorists of Revolution" in Professor E. Dowden's *The French Revolution and English Literature* (1897).

Abbas, King of Persia, which Godwin offered him in the next year. He was more successful with his *Life of Chaucer*, for which he received £600.

The events of Godwin's life were few. Under the advice of the second Mrs Godwin, and with her active co-operation, he carried on business as a bookseller under the pseudonym of Edward Baldwin, publishing several useful school books and books for children, among them Charles and Mary Lamb's *Tales from Shakespeare*. But the speculation was unsuccessful, and for many years Godwin struggled with constant pecuniary difficulties, for which more than one subscription was raised by the leaders of the Liberal party and by literary men. He became bankrupt in 1822, but during the following years he accomplished one of his best pieces of work, *The History of the Commonwealth*, founded on pamphlets and original documents, which still retains considerable value. In 1833 the government of Earl Grey conferred upon him the office known as yeoman usher of the exchequer, to which were attached apartments in Palace Yard, where he died on the 7th of April 1836.

In his own time, by his writings and by his conversation, Godwin had a great power of influencing men, and especially young men. Though his character would seem, from much which is found in his writings, and from anecdotes told by those who still remember him, to have been unsympathetic, it was not so understood by enthusiastic young people, who hung on his words as those of a prophet. The most remarkable of these was Percy Bysshe Shelley, who in the glowing dawn of his genius turned to Godwin as his teacher and guide. The last of the long series of young men who sat at Godwin's feet was Edward Lytton Bulwer, afterwards Lord Lytton, whose early romances were formed after those of Godwin, and who, in *Eugene Aram*, succeeded to the story as arranged, and the plan to a considerable extent sketched out, by Godwin, whose age and falling health prevented him from completing it. Godwin's character appears in the worst light in connexion with Shelley. His early correspondence with Shelley, which began in 1811, is remarkable for its genuine good sense and kindness; but when Shelley carried out the principles of the author of *Political Justice* in eloping with Mary Godwin, Godwin assumed a hostile attitude that would have been unjustifiable in a man of ordinary views, and was ridiculous in the light of his professions. He was not, moreover, too proud to accept £1000 from his son-in-law, and after the reconciliation following on Shelley's marriage in 1816, he continued to demand money until Shelley's death. His character had no doubt suffered under his long embarrassments and his unhappy marriage.

Godwin's more important works are—*The Inquiry concerning Political Justice, and its Influence on General Virtue and Happiness* (1793); *Things as they are, or the Adventures of Caleb Williams* (1794); *The Inquirer, a series of Essays* (1797); *Memoirs of the Author of the Rights of Woman* (1798); *St Leon, a Tale of the Sixteenth Century* (1799); *Antonio, a Tragedy* (1800); *The Life of Chaucer* (1803); *Fleetwood, a Novel* (1805); *Faulkner, a Tragedy* (1807); *Essay on Sepulchres* (1809); *Lives of Edward and John Philips, the Nephews of Milton* (1815); *Mandeville, a Tale of the Times of Cromwell* (1817); *Of Population, an answer to Malthus* (1820); *History of the Commonwealth* (1824-1828); *Cloudesley, a Novel* (1830); *Thoughts on Man, a series of Essays* (1831); *Lives of the Necromancers* (1834). A volume of essays was also collected from his papers and published in 1873, as left for publication by his daughter Mrs Shelley. Many other short and anonymous works proceeded from his ever busy pen, but many are irrecoverable, and all are forgotten. Godwin's life was published in 1876 in two volumes, under the title *William Godwin, his Friends and Contemporaries*, by C. Kegan Paul. The best estimate of his literary position is that given by Sir Leslie Stephen in his *English Thought in the 18th Century* (ll. 264-281, ed. 1902). See also the article on William Godwin in W. Hazlitt's *The Spirit of the Age* (1825), and "Godwin and Shelley" in Sir L. Stephen's *Hours in a Library* (vol. iii., ed. 1892).

GODWIN-AUSTEN, ROBERT ALFRED CLOYNE (1808-1884), English geologist, the eldest son of Sir Henry E. Austen, was born on the 17th of March 1808. He was educated at Oriel College, Oxford, of which he became a fellow in 1830. He afterwards entered Lincoln's Inn. In 1833 he married the only daughter and heiress of General Sir Henry T. Godwin, K.C.B., and he took the additional name of Godwin by Royal licence

in 1854. At Oxford as a pupil of William Buckland he became deeply interested in geology, and soon afterwards becoming acquainted with De la Beche, he was inspired by that great master, and assisted him by making a geological map of the neighbourhood of Newton Abbot, which was embodied in the Geological Survey map. He also published an elaborate memoir "On the Geology of the South-East of Devonshire" (*Trans. Geol. Soc. ser. 2, vol. viii.*). His attention was next directed to the Cretaceous rocks of Surrey, his home-county, his estates being situated at Chilworth and Shalford near Guildford. Later he dealt with the superficial accumulations bordering the English Channel, and with the erratic boulders of Selsea. In 1855 he brought before the Geological Society of London his celebrated paper "On the possible Extension of the Coal-Measures beneath the South-Eastern part of England," in which he pointed out on well-considered theoretical grounds the likelihood of coal-measures being some day reached in that area. In this article he also advocated the freshwater origin of the Old Red Sandstone, and discussed the relations of that formation, and of the Devonian, to the Silurian and Carboniferous. He was elected F.R.S. in 1849, and in 1862 he was awarded the Wollaston medal by the Geological Society of London, on which occasion he was styled by Sir R. I. Murchison "pre-eminently the physical geographer of bygone periods." He died at Shalford House near Guildford on the 25th of November, 1884.

His son, Lieut. Colonel HENRY HAVERHAM GODWIN-AUSTEN (b. 1834), entered the army in 1851, and served for many years on the Trigonometrical Survey of India, retiring in 1877. He gave much attention to geology, but is more especially distinguished for his researches on the natural history of India and as the author of *The Land and Freshwater Mollusca of India* (1882-1887).

GODWINE (d. 1053), son of Wulfnoth, earl of the West-Saxons, the leading Englishman in the first half of the 11th century. His birth and origin are utterly uncertain, but he rose to power early in Canute's reign and was an earl in 1018. He received in marriage Gytha, a connexion of the king's, and in 1020 became earl of the West-Saxons. On the death of Canute in 1035 he joined with Queen Emma in supporting the claim of Hardicanute, the son of Canute and Emma, to the crown of his father, in opposition to Leofric and the northern party who supported Harold Harefoot (see **HARDICANUTE**). While together they held Wessex for Hardicanute, the archeling Ælfred, son of Emma by her former husband Æthelred II., landed in England in the hope of winning back his father's crown; but falling into the hands of Godwine, he and his followers were cruelly done to death. On the death of Hardicanute in 1042 Godwine was foremost in promoting the election of Edward (the Confessor) to the vacant throne. He was now the first man in the kingdom, though his power was still balanced by that of the other great earls, Leofric of Mercia and Sward of Northumberland. His sons Sweyn and Harold were promoted to earldoms; and his daughter Eadgyth was married to the king (1045). His policy was strongly national in opposition to the marked Normanizing tendencies of the king. Between him and Edward's foreign favourites, particularly Robert of Jumièges, there was deadly feud. The appointment of Robert to the archbishopric of Canterbury in 1051 marks the decline of Godwine's power; and in the same year a series of outrages committed by one of the king's foreign favourites led to a breach between the king and the earl, which culminated in the exile of the latter with all his family (see **EDWARD THE CONFESSOR**). But next year Godwine returned in triumph, and at a great meeting held outside London he and his family were restored to all their offices and possessions, and the archbishop and many other Normans were banished. In the following year Godwine was smitten with a fit at the king's table, and died three days later on the 15th of April 1053.

Godwine appears to have had seven sons, three of whom—King Harold, Gyth and Leofwine—were killed at Hastings; two others, Wulfnoth and Ælfgar, are of little importance; another was Earl Tostig (q.v.). The eldest son was Sweyn, or Swegen (d. 1052), who was outlawed for seducing Eadgyth

abbess of Leominster. After fighting for the king of Denmark he returned to England in 1049, when his murder of his cousin Beorn compelled him to leave England for the second time. In 1050, however, he regained his earldom, and in 1051 he shared his father's exile. To atone for the murder of Beorn, Sweyn went on a pilgrimage to Jerusalem, and on the return journey he died on the 29th of September 1052, meeting his death, according to one account, at the hands of the Saracens.

GODWIT, a word of unknown origin, the name commonly applied to a marsh-bird in great repute, when fattened, for the table, and formerly abundant in the fens of Norfolk, the Isle of Ely and Lincolnshire. In Turner's days (1544) it was worth three times as much as a snipe, and at the same period Belon said of it—"C'est un Oysean es delices des François." Cassaubon, who Latinized its name "*Dei ingenium* (*Ephemerides*, 19th September 1611), was told by the "*ornithotrophæus*" he visited at Wisbech that in London it fetched twenty pence. Its fame as a delicacy is perpetuated by many later writers, Ben Jonson among them, and Pennant says that in his time (1766) it sold for half-a-crown or five shillings. Under the name godwit two perfectly distinct species of British birds were included, but that which seems to have been especially prized is known to modern ornithologists as the black-tailed godwit, *Limosa accephala*, formerly called, from its loud cry, a yarwhelp,¹ shrieker or barker, in the districts it inhabited. The practice of netting this bird in large numbers during the spring and summer, coupled with the gradual reclamation of the fens, to which it resorted, has now rendered it but a visitor in England, and it probably ceased from breeding regularly in England in 1824 or thereabouts, though under favourable conditions it may have occasionally laid its eggs for some thirty years later or more (Stevenson, *Birds of Norfolk*, ii. 250). This godwit is a species of wide range, reaching Iceland, where it is called *Jarbræke* (=earth-raker), in summer, and occurring numerously in India in winter. Its chief breeding-quarters seem to extend from Holland eastwards to the south of Russia. The second British species is that which is known as the bar-tailed godwit, *L. lapponica*, and this seems to have never been more than a bird of double passage in the United Kingdom, arriving in large flocks on the south coast about the 12th of May, and, after staying a few days, proceeding to the north-eastward. It is known to breed in Lapland, but its eggs are of great rarity. Towards autumn the young visit the English coasts, and a few of them remain, together with some of the other species, in favourable situations throughout the winter. One of the local names by which the bar-tailed godwit is known to the Norfolk gunners is scammell, a word which, in the mouth of Caliban (*Tempest*, ii. ii.), has been the cause of much perplexity to Shakespearian critics.

The godwits belong to the group *Limicolæ*, and are about as big as a tame pigeon, but possess long legs, and a long bill with a slight upward turn. It is believed that in the genus *Limosa* the female is larger than the male. While the winter plumage is of a sober greyish-brown, the breeding-dress is marked by a predominance of bright bay or chestnut, rendering the wearer a very beautiful object. The black-tailed godwit, though varying a good deal in size, is constantly larger than the bar-tailed, and especially longer in the legs. The species may be further distinguished by the former having the proximal third of the tail-quills pure white, and the distal two-thirds black, with a narrow white margin, while the latter has the same feathers barred with black and white alternately for nearly their whole length.

America possesses two species of the genus, the very large marbled godwit or martin, *L. fedoa*, easily recognized by its size and the buff colour of its axillaries, and the smaller Hudsonian godwit, *L. audouinii*, which has its axillaries of a deep black. This last, though less numerous than its congener, seems to range over the whole of the continent, breeding in the extreme north, while it has been obtained also in the Strait of Magellan and the Falkland Islands. The first seems not to go farther southward than the Antilles and the Isthmus of Panama.

¹ This name seems to have survived in Whelp Moor, near Brandon, in Suffolk.

From Asia, or at least its eastern part, two species have been described. One of them, *L. melanuroides*, differs only from *L. aegcephala* in its smaller size, and is believed to breed in Amurland, wintering in the islands of the Pacific, New Zealand and Australia. The other, *L. wropygialis*, is closely allied to and often mistaken for *L. lapponica*, from which it chiefly differs by having the rump barred like the tail. This was found breeding in the extreme north of Siberia by Dr von Middendorff, and ranges to Australia, whence it was, like the last, first described by Gould. (A. N.)

GOEBEN, AUGUST KARL VON (1816-1886), Prussian general of infantry, came of old Hanoverian stock. Born at Stade on the 10th of December 1816, he aspired from his earliest years to the Prussian service rather than that of his own country, and at the age of seventeen obtained a commission in the 24th regiment of Prussian infantry. But there was little scope there for the activities of a young and energetic subaltern, and, leaving the service in 1836, he entered the Carlist army campaigning in Spain. In the five campaigns which he made in the service of Don Carlos he had many and various vicissitudes of fortune. He had not fought for two months when he fell, severely wounded, into the hands of the Spanish Royal troops. After eight months' detention he escaped, but it was not long before he was captured again. This time his imprisonment was long and painful, and on two occasions he was compelled to draw lots for his life with his fellow-captives. When released, he served till 1840 with distinction. In that year he made his way back, a beggar without means or clothing, to Prussia. The Carlist lieutenant-colonel was glad to be re-admitted into the Prussian service as a second lieutenant, but he was still young, and few subalterns could at the age of twenty-four claim five years' meritorious war service. In a few years we find him serving as captain on the Great General Staff, and in 1848 he had the good fortune to be transferred to the staff of the IV. army corps, his immediate superior being Major von Moltke. The two "coming men" became fast friends, and their mutual esteem was never disturbed. In the Baden insurrection Goeben served with distinction on the staff of Prince William, the future emperor. Staff and regimental duty (as usual in the Prussian service) alternated for some years after this, till in 1863 he became major-general commanding the 26th infantry brigade. In 1860, it should be mentioned, he was present with the Spanish troops in Morocco, and took part in the battle of Tetuan.

In the first of Prussia's great wars (1864) he distinguished himself at the head of his brigade at Rackebüll and Sonderburg. In the war of 1866 Lieutenant-General von Goeben commanded the 13th division, of which his old brigade formed part, and, in this higher sphere, once more displayed the qualities of a born leader and skillful tactician. He held almost independent command with conspicuous success in the actions of Dermbach, Laufach, Kissingen, Aschaffenburg, Gerchsheim, Tauber-Bischofsheim and Würzburg. The mobilization of 1870 placed him at the head of the VIII. (Rhine-land) army corps, forming part of the First Army under Steinmetz. It was his resolute and energetic leading that contributed mainly to the victory of Spicheren (6th August), and won the only laurels gained on the Prussian right wing at Gravelotte (18th August). Under Manteuffel the VIII. corps took part in the operations about Amiens and Bapaume, and on the 8th of January 1871 Goeben succeeded that general in the command of the First Army, with which he had served throughout the campaign as a corps commander. A fortnight later he had brought the war in northern France to a brilliant conclusion, by the decisive victory of St Quentin (18th and 19th January 1871). The close of the Franco-German War left Goeben one of the most distinguished men in the victorious army. He was colonel of the 28th infantry, and had the grand cross of the Iron Cross. He commanded the VIII. corps at Coblenz until his death in 1886.

General von Goeben left many writings. His memoirs are to be found in his works *Vier Jahre in Spanien* (Hanover, 1841), *Reise- und Lagerbriefe aus Spanien und vom spanischen Heere in Marokko* (Hanover, 1863) and in the Darmstadt *Allgemeine*

Militärzeitung. The former French port (Queuleu) at Metz was renamed Goeben after him, and the 28th infantry bears his name. A statue of Goeben by Schaper was erected at Coblenz in 1884. See G. Zernin, *Das Leben des Generals August von Goeben* (2 vols. Berlin, 1895-1897); H. Barth, *A. von Goeben* (Berlin, 1906); and, for his share in the war of 1870-71: H. Kunz, *Der Feldzug im N und N.W. Frankreichs 1870-1871* (Berlin, 1889), and the 14th Monograph of the Great General Staff (1891).

GOEJE, MICHAEL JAN DE (1836-1909), Dutch orientalist, was born in Friesland in 1836. He devoted himself at an early age to the study of oriental languages and became especially proficient in Arabic, under the guidance of Dozy and Juynboll, to whom he was afterwards an intimate friend and colleague. He took his degree of doctor at Leiden in 1860, and then studied for a year in Oxford, where he examined and collated the Bodleian MSS. of Idrial (part being published in 1866, in collaboration with R. P. Dozy, as *Description de l'Afrique et de l'Espagne*). About the same time he wrote *Mémoires de l'histoire et de la géographie orientales*, and edited *Espagnatio regionum*. In 1883, on the death of Dozy, he became Arabic professor at Leiden, retiring in 1906. He died on the 17th of May 1909. Though perhaps not a teacher of the first order, he wielded a great influence during his long professoriate not only over his pupils, but over theologians and eastern administrators who attended his lectures, and his many editions of Arabic texts have been of the highest value to scholars, the most important being his great edition of Tabari. Though entirely averse from politics, he took a keen interest in the municipal affairs of Leiden and made a special study of elementary education. He took the leading part in the International Congress of Orientalists at Algiers in 1905. He was a member of the Institut de France, was awarded the German Order of Merit, and received an honorary doctorate of Cambridge University. At his death he was president of the newly formed International Association of Academies of Science. Among his chief works are *Fragmenta historicorum Arabicorum* (1869-1871); *Dwan of Moslim ibn al-Walid* (1875); *Bibliotheca geographorum Arabicorum* (1870-1894); *Annals of Tabari* (1879-1901); edition of Ibn Qutaiba's biographies (1904); of the travels of Ibn Jubayr (1907, 5th vol. of Gibb Memorial). He was also the chief editor of the *Encyclopaedia of Islam* (vols. I.-III.), and contributed many articles to periodicals. He wrote for the 9th and the present edition of the *Encyclopaedia Britannica*.

GOES, DAMIÃO DE (1502-1574), Portuguese humanist, was born of a patrician family at Alenquer, in February 1502. Under King John III. he was employed abroad for many years from 1523 on diplomatic and commercial missions, and he travelled over the greater part of Europe. He was intimate with the leading scholars of the time, was acquainted with Luther and other Protestant divines, and in 1532 became the pupil and friend of Erasmus. Goes took his degree at Padua in 1538 after a four years' course. In 1537, at the instance of his friend Cardinal Sadoletto, he undertook to mediate between the Church and the Lutherans, but failed through the attitude of the Protestants. He married in Flanders a rich and noble Dutch lady, D. Joanna de Hargen, and settled at Louvain, then the literary centre of the Low Countries, where he was living in 1542 when the French besieged the town. He was given the command of the defending forces, and saved Louvain, but was taken prisoner and confined for nine months in France, till he obtained his freedom by a heavy ransom. He was rewarded, however, by a grant of arms from Charles V. He finally returned to Portugal in 1545, with a view of becoming tutor to the king's son, but he failed to obtain this post, owing to the denunciations of Father Simon Rodriguez, provincial of the Jesuits, who accused Goes of favouring the Lutheran doctrines and of being a disciple of Erasmus. Nevertheless in 1548 he was appointed chief keeper of the archives and royal chronicler, and at once introduced some much-needed reforms into the administration of his office.

In 1558 he was given a commission to write a history of the reign of King Manoel, a task previously confided to João de Barros, but relinquished by him. It was an onerous undertaking for a conscientious historian, since it was necessary to expose

the mysteries as well as relate the glories of the period, and so to offend some of the most powerful families. Goes had already written a *Chronicle* of Prince John (afterwards John II.), and when, after more than eight years' labour, he produced the First Part of his *Chronicle* of King Manoel (1566), a chthon of attacks greeted it, the edition was destroyed, and he was compelled to issue a revised version. He brought out the three other parts in 1566-1567, though chapters 23 to 27 of the Third Part were so mutilated by the censorship that the printed text differs largely from the MS. Hitherto Goes, notwithstanding his Liberalism, had escaped the Inquisition, though in 1540 his *Fides, religio, moresque Aethiopum* had been prohibited by the chief inquisitor, Cardinal D. Henrique; but the denunciation of Father Rodriguez in 1545, which had been vainly renewed in 1550, was now brought into action, and in 1571 he was arrested to stand his trial. There seems to be no doubt that the Inquisition made itself on this occasion, as on others, the instrument of private enmity; for eighteen months Goes lay ill in prison, and then he was condemned, though he had lived for thirty years as a faithful Catholic, and the worst that could be proved against him was that in his youth he had spoken against Indulgences, disbelieved in auricular confession, and consorted with heretics. He was sentenced to a term of reclusion; and his property was confiscated to the crown. After he had abjured his errors in private, he was sent at the end of 1572 to do penance at the monastery of Batalha. Later he was allowed to return home to Alemquer, where he died on the 30th of January 1574. He was buried in the church of Nossa Senhora da Varzea.

Damião de Goes was a man of wide culture and genial and courtly manners, a skilled musician and a good linguist. He wrote both Portuguese and Latin with classic strength and simplicity, and his style is free from affectation and rhetorical ornaments. His portrait by Albrecht Dürer shows an open, intelligent face, and the record of his life proves him to have been upright and fearless. His prosperity doubtless excited ill-will, but above all, his ideas, advanced for Portugal, his foreign ways, outspokenness and honesty contributed to the tragedy of his end, at a time when the forces of ignorant reaction held the ascendant. He had, it may be presumed, given some umbrage to the court by condemning, in the *Chronicle of King Manoel*, the royal ingratitude to distinguished public servants, though he received a pension and other rewards for that work, and he had certainly offended the nobility by his administration of the archive office and by exposing false genealogical claims in his *Nobiliario*. He paid the penalty for telling the truth, as he knew it, in an age when an historian had to choose between flattery of the great and silence. The *Chronicle of King Manoel* was the first official history of a Portuguese reign to be written in a critical spirit, and Damião de Goes has the honour of having been the first Portuguese royal chronicler to deserve the name of an historian.

His Portuguese works include *Chronica do felicissimo rei Dom Emanuel* (parts i. and ii., Lisbon, 1566, parts iii. and iv., *ib.* 1567). Other editions appeared in Lisbon in 1619 and 1749 and in Coimbra in 1790. *Chronica do principe Dom Joam* (Lisbon, 1558), with subsequent editions in 1567 and 1724 in Lisbon and in 1790 in Coimbra. *Livro de Marco Tulio Cicero chamado Catam Mayor* (Venice, 1538). This is a translation of Cicero's *De senectute*. His Latin works, published separately, comprise: (1) *Legatio magni imperatoris Presbiterii Joannis, &c.* (Antwerp, 1532); (2) *Legatio Davidis Ethiope regis, &c.* (Bologna, 1533); (3) *Commentarius rerum gestarum in India* (Louvain, 1539); (4) *Fides, religio, moresque Aethiopum* (Louvain, 1540), incorporating Nos. (1) and (2); (5) *Hispania* (Louvain, 1542); (6) *Aliquot epistolae Sadoletii Bembi et aliorum clarissimorum virorum, &c.* (Louvain, 1544); (7) *Damiani a Goes equitis Lusitani aliquot opuscula* (Louvain, 1544); (8) *Urbis Louanienensis obsidita* (Lisbon, 1546); (9) *De bello Cambaico ultimo* (Louvain, 1549); (10) *Urbis Orlinensis descriptio* (Evora, 1554); (11) *Epistola ad Hieronymum Cardanum* (Lisbon, 1556). Most of the above went through several editions, and many were afterwards included with new works in such collections as No. (7), and seven sets of *Opuscula* appeared, all incomplete. Nos. (3), (4), and (5) suffered mutilation in subsequent editions, at the hands of the censors, because they offended against religious orthodoxy or family pride.

AUTHORITIES.—(A) Joaquim de Vasconcellos, *Goesiana* (5 vols.), with the following sub-titles: (1) *O Retrato de Albrecht Dürer* (Porto, 1879); (2) *Bibliographia* (Porto, 1879), which describes 67

numbers of books by Goes: (3) *As Variantes das Chronicas Portuguezas* (Porto, 1881); (4) *Damião de Goes: Novos Estudos* (Porto, 1897); (5) *As Cartas Latinas*—in the press (1906). Sr. Vasconcellos only printed a very limited number of copies of these studies for distribution among friends, so that they are rare. (B) Guilherme J. C. Henriques, *Instituições Gossimões*, vol. i. (Lisbon, 1896), vol. ii. (containing the proceedings at the trial by the Inquisition) (Lisbon, 1898). (C) A. F. Lopes de Mendonça, *Damião de Goes e a Inquisição de Portugal* (Lisbon, 1899). (D) Dr Sousa Viterbo, *Damião de Goes e D. Afonso Pinheiro* (Coimbra, 1899). (E) Dr Theophilo Braga, *Historia da Universidade de Coimbra* (Lisbon, 1892), i. 374-380. (F) Menendez y Pelayo, *Historia de los Heter. Españoles*, ii. 129-143. (E. Pr.)

GOES, HUGO VAN DER (d. 1482), a painter of considerable celebrity at Ghent, was known to Vasari, as he is known to us, by a single picture in a Florentine monastery. At a period when the family of the Medici had not yet risen from the rank of a great mercantile firm to that of a reigning dynasty, it employed as an agent at the port of Bruges Tommaso Portinari, a lineal descendant, it was said, of Folco, the father of Dante's Beatrice. Tommaso, at that time patron of a chapel in the hospital of Santa Maria Nuova at Florence, ordered an altar-piece of Hugo van der Goes, and commanded him to illustrate the sacred theme of "Quem genuit adoravit." In the centre of a vast triptych, comprising numerous figures of life size, Hugo represented the Virgin kneeling in adoration before the new-born Christ attended by Shepherds and Angels. On the wings he portrayed Tommaso and his two sons in prayer under the protection of Saint Anthony and St Matthew, and Tommaso's wife and two daughters supported by St Margaret and St Mary Magdalen. The triptych, which has suffered much from decay and restoring, was for over 400 years at Santa Maria Nuova, and is now in the Uffizi Gallery. Imposing because composed of figures of unusual size, the altar-piece is more remarkable for portrait character than for charms of ideal beauty.

There are also small pieces in public galleries which claim to have been executed by Van der Goes. One of these pictures in the National Gallery in London is more nearly allied to the school of Memling than to the triptych of Santa Maria Nuova; another, a small and very beautiful "John the Baptist," at the Pinakothek of Munich, is really by Memling; whilst numerous fragments of an altar-piece in the Belvedere at Vienna, though assigned to Hugo, are by his more gifted countryman of Bruges. Van der Goes, however, was not habitually a painter of easel pieces. He made his reputation at Bruges by producing coloured hangings in distemper. After he settled at Ghent, and became a master of his guild in 1465, he designed cartoons for glass windows. He also made decorations for the wedding of Charles the Bold and Margaret of York in 1468, for the festivals of the Rhetoricians and papal jubilees on repeated occasions, for the solemn entry of Charles the Bold into Ghent in 1470-1471, and for the funeral of Philip the Good in 1474. The labour which he expended on these occasions might well add to his fame without being the less ephemeral. About the year 1475 he retired to the monastery of Rouge Cloutre near Ghent, where he took the cowl. There, though he still clung to his profession, he seems to have taken to drinking, and at one time to have shown decided symptoms of insanity. But his superiors gradually cured him of his intemperance, and he died in the odour of sanctity in 1482.

GOES, a town in the province of Zeeland, Holland, on the island of South Beveland, 12½ m. by rail E. of Middelburg. Pop. (1900) 6910. It is connected by a short canal with the East Scheldt, and has a good harbour (1810) defended by a fort. The principal buildings are the interesting Gothic church (1423) and the picturesque old town hall (restored 1771). There are various educational and charitable institutions. Goes has preserved for centuries its prosperous position as the market-town of the island. The chief industries are boat-building, brewing, book-binding and cigar-making. The town had its origin in the castle of Oostende, built here by the noble family of Borssele. It received a charter early in the 15th century from the countess Jacoba of Holland, who frequently stayed at the castle.

GOETHE, JOHANN WOLFGANG VON (1749-1832), German poet, dramatist and philosopher, was born at Frankfort-on-Main on the 28th of August 1749. He came, on his father's side, of Thuringian stock, his great-grandfather, Hans Christian Goethe, having been a farmer at Artern-on-the-Unstrut, about the middle of the 17th century. Hans Christian's son, Friedrich Georg, was brought up to the trade of a tailor, and in this capacity settled in Frankfort in 1686. A second marriage, however, brought him into possession of the Frankfort inn, "Zum Weidenhof," and he ended his days as a well-to-do innkeeper. His son, Johann Kaspar, the poet's father (1710-1782), studied law at Leipzig, and, after going through the prescribed courses of practical training at Wetzlar, travelled in Italy. He hoped, on his return to Frankfort, to obtain an official position in the government of the free city, but his personal influence with the authorities was not sufficiently strong. In his disappointment he resolved never again to offer his services to his native town, and retired into private life, a course which his ample means facilitated. In 1742 he acquired, as a consolation for the public career he had missed, the title of *kaiserlicher Rat*, and in 1748 married Katharina Elisabeth (1731-1808), daughter of the *Schultheiss* or *Bürgermeister* of Frankfort, Johann Wolfgang Textor. The poet was the eldest son of this union. Of the later children only one, Cornelia, born in 1750, survived the years of childhood; she died as the wife of Goethe's friend, J. G. Schlosser, in 1777. The best elements in Goethe's genius came from his mother's side; of a lively, impulsive disposition, and gifted with remarkable imaginative power, Frau Rat was the ideal mother of a poet; moreover, being hardly eighteen at the time of her son's birth, she was herself able to be the companion of his childhood. From his father, whose stern, somewhat pedantic nature repelled warmer feelings on the part of the children, Goethe inherited that "holy earnestness" and stability of character which brought him unscathed through temptations and passions, and held the balance to his all too powerful imagination.

Unforgettable is the picture which the poet subsequently drew of his childhood spent in the large house with its many nooks and crannies, in the Grosse Hirschgraben at Frankfort. Books, pictures, objects of art, antiquities, reminiscences of Rat Goethe's visit to Italy, above all a marionette theatre, kindled the child's quick intellect and imagination. His training was conducted in its early stages by his father, and was later supplemented by tutors. Meanwhile the varied and picturesque life of Frankfort was in itself an education. In 1759, during the Seven Years' War, the French, as Maria Theresa's allies, occupied the town, and, much to the irritation of Goethe's father, who was a staunch partisan of Frederick the Great, a French lieutenant, Count Thoranc, was quartered on the Goethe household. The foreign occupation also led to the establishment of a French troupe of actors, and to their performances the boy, through his grandfather's influence, had free access. Goethe has also recorded his memories of another picturesque event, the coronation of the emperor Joseph II. in the Frankfort Römer or town hall in 1764; but these memories were darkened by being associated in his mind with the tragic dénouement of his first love affair. The object of this passion was a certain Gretchen, who seems to have taken advantage of the boy's interest in her to further the dishonest ends of one of her friends. The discovery of the affair and the investigation that followed cooled Goethe's ardour and caused him to turn his attention seriously to the studies which were to prepare him for the university. Meanwhile the literary instinct had begun to show itself; we hear of a novel in letters—a kind of linguistic exercise, in which the characters carried on the correspondence in different languages—of a prose epic on the subject of Joseph, and various religious poems of which one, *Die Hülfsfabri Christi*, found its way in a revised form into the poet's complete works.

In October 1765, Goethe, then a little over sixteen, left Frankfort for Leipzig, where a wider and, in many respects, less provincial life awaited him. He entered upon his university studies with zeal, but his own education in Frankfort had not

been the best preparation for the scholastic methods which still dominated the German universities; of his professors, only Gellert seems to have won his interest, and that interest was soon exhausted. The literary beginnings he had made in Frankfort now seemed to him amateurish and trivial; he felt that he had to turn over a new leaf, and, under the guidance of E. W. Behriach, a genial, original comrade, he learned the art of writing those light Anacreontic lyrics which harmonized with the tone of polite Leipzig society. Artificial as this poetry is, Goethe was, nevertheless, inspired by a real passion in Leipzig, namely, for Anna Katharina Schönpkopf, the daughter of a wine-merchant at whose house he dined. She is the "Annette" after whom the recently discovered collection of lyrics was named, although it must be added that neither these lyrics nor the *Neue Lieder*, published in 1770, express very directly Goethe's feelings for Käthchen Schönpkopf. To his Leipzig student-days belong also two small plays in Alexandrine, *Die Lonne des Verliebten*, a pastoral comedy in one act, which reflects the lighter side of the poet's love affair, and *Die Mitschuldigen* (published in a revised form, 1769), a more sombre picture, in which comedy is incongruously mingled with tragedy. In Leipzig Goethe also had time for what remained one of the abiding interests of his life, for art; he regarded A. F. Oeser (1717-1799), the director of the academy of painting in the Pleissenburg, who had given him lessons in drawing, as the teacher who in Leipzig had influenced him most. His art studies were also furthered by a short visit to Dresden. His stay in Leipzig came, however, to an abrupt conclusion; the distractions of student life proved too much for his strength; a sudden hæmorrhage supervened, and he lay long ill, first in Leipzig, and, after it was possible to remove him, at home in Frankfort. These months of slow recovery were a time of serious introspection for Goethe. He still corresponded with his Leipzig friends, but the tone of his letters changed; life had become graver and more earnest for him. He pored over books on occult philosophy; he busied himself with alchemy and astrology. A friend of his mother's, Susanne Katharina von Klettenberg, who belonged to pietist circles in Frankfort, turned the boy's thoughts to religious mysticism. On his recovery his father resolved that he should complete his legal studies at Strassburg, a city which, although then outside the German empire, was, in respect of language and culture, wholly German. From the first moment Goethe set foot in the narrow streets of the Alsatian capital, in April 1770, the whole current of his thought seemed to change. The Gothic architecture of the Strassburg minster became to him the symbol of a national and German ideal, directly antagonistic to the French tastes and the classical and rationalistic atmosphere that prevailed in Leipzig. The second moment of importance in Goethe's Strassburg period was his meeting with Herder, who spent some weeks in Strassburg undergoing an operation of the eye. In this thinker, who was his senior by five years, Goethe found the master he sought; Herder taught him the significance of Gothic architecture, revealed to him the charm of nature's simplicity, and inspired him with enthusiasm for Shakespeare and the *Völklied*. Meanwhile Goethe's legal studies were not neglected, and he found time to add to knowledge of other subjects, notably that of medicine. Another factor of importance in Goethe's Strassburg life was his love for Friederike Brion, the daughter of an Alsatian village pastor in Sesenheim. Even more than Herder's precept and example, this passion showed Goethe how trivial and artificial had been the Anacreontic and pastoral poetry with which he had occupied himself in Leipzig; and the lyrics inspired by Friederike, such as *Kleine Blumen, kleine Blätter* and *Wie herrlich leuchtet mir die Natur!* mark the beginning of a new epoch in German lyric poetry. The idyll of Sesenheim, as described in *Dichtung und Wahrheit*, is one of the most beautiful love-stories in the literature of the world. From the first, however, it was clear that Friederike Brion could never become the wife of the Frankfort patrician's son; an unhappy ending to the romance was unavoidable, and, as it is to be seen in passionate outpourings like the *Wanderers Sturmlied*, and in the bitter self-accusations of *Clavigo*, it left deep wounds on the poet's sensitive soul.

To Strassburg we owe Goethe's first important drama, *Göts von Berlichingen*, or, as it was called in its earliest form, *Geschichte Gottfriedens von Berlichingens dramatisiert* (not published until 1831). Revised under the now familiar title, it appeared in 1773, after Goethe's return to Frankfurt. In estimating this drama we must bear in mind Goethe's own Strassburg life, and the turbulent spirit of his own age, rather than the historical facts, which the poet found in the autobiography of his hero published in 1731. The latter supplied only the rough materials; the Götz von Berlichingen whom Goethe drew, with his lofty ideals of right and wrong, and his enthusiasm for freedom, is a very different personage from the unscrupulous robber-knight of the 16th century, the rough friend of Franz von Sickingen and of the revolting peasants. Still less historical justification is to be found for the vacillating Weisslingen in whom Goethe exacted poetic justice on himself as the lover of Friederike, or in the women of the play, the gentle Maria, the heartless Adelheid. But there is genial, creative power in the very subjectivity of these characters, and a vigorous dramatic life, which is irresistible in its appeal. With Götz von Berlichingen, Shakespeare's art first triumphed on the German stage, and the literary movement known as *Sturm und Drang* was inaugurated.

Having received his degree in Strassburg, Goethe returned home in August 1771, and began his initiation into the routine of an advocate's profession. In the following year, in order to gain insight into another side of his calling, he spent four months at Wetzlar, where the imperial law-courts were established. But Goethe's professional duties had only a small share in the eventful years which lay between his return from Strassburg and that visit to Weimar at the end of 1775, which turned the whole course of his career, and resulted in his permanent attachment to the Weimar court. Goethe's life in Frankfurt was a round of stimulating literary intercourse; in J. H. Merck (1741-1791), an army official in the neighbouring town of Darmstadt, he found a friend and mentor, whose irony and common-sense served as a corrective to his own exuberance of spirits. Wetzlar brought new friends and another passion, that for Charlotte Buff, the daughter of the *Amme*; there—a love-story which has been immortalized in *Werthers Leiden*—and again the young poet's nature was obsessed by a love which was this time strong enough to bring him to the brink of that suicide with which the novel ends. A visit to the Rhine, where new interests and the attractions of Maximiliane von Laroche, a daughter of Wieland's friend, the novelist Sophie von Laroche, brought partial healing; his intense preoccupation with literary work on his return to Frankfurt did the rest. In 1775 Goethe was attracted by still another type of woman, Lili Schönemann, whose mother was the widow of a wealthy Frankfurt banker. A formal betrothal took place, and the beauty of the lyrics which Lili inspired leaves no room for doubt that here was a passion no less genuine than that for Friederike or Charlotte. But Goethe—more worldly wise than on former occasions—felt instinctively that the gay, social world in which Lili moved was not really congenial to him. A visit to Switzerland in the summer of 1775 may not have weakened his interest in her, but it at least allowed him to regard her objectively; and, without tragic consequences on either side, the passion was ultimately allowed to yield to the dictates of common-sense. Goethe's departure for Weimar in November made the final break less difficult.

The period from 1771 to 1775 was, in literary respects, the most productive of the poet's life. It had been inaugurated with *Götz von Berlichingen*, and a few months later this tragedy was followed by another, *Clavigo*, hardly less convincing in its character-drawing, and reflecting even more faithfully than the former the experiences Goethe had gone through in Strassburg. Again poetic justice is effected on the unfortunate hero who has chosen his own personal advancement in preference to his duty to the woman he loves; more pointedly than in *Götz* is the moral enforced by Clavigo's worldly friend Carlos, that the ground of Clavigo's tragic end lies not so much in the defiance of a moral law as in the hero's vacillation and want of character. With *Die Leiden des jungen Werthers* (1774), the literary precipitate of the author's own experiences in Wetzlar, Goethe

succeeded in attracting, as no German had done before him, the attention of Europe. Once more it was the gospel that the world belongs to the strong, which lay beneath the surface of this romance. This, however, was not the lesson which was drawn from it by Goethe's contemporaries; they shed tears of sympathy over the loveless youth whose burden becomes too great for him to bear. While Götz inaugurated the manlier side of the *Sturm und Drang* literature, *Werther* was responsible for its sentimental excesses. And to the sentimental rather than to the heroic side belongs also *Stello*, "a drama for lovers," in which the poet again reproduced, if with less fidelity than in *Werther*, certain aspects of his own love troubles. A lighter vein is to be observed in various dramatic satires written at this time, such as *Götter, Helden und Wieland* (1774), *Honoursturz Heckerl*, *Fastnachtsspiel vom Peter Brey*, *Saisyoc*, and in the *Singspiele*, *Erwin und Elmire* (1775) and *Claudine von Villa Bella* (1776); while in the *Frankfurter Gelehrte Anzeiger* (1773-1775), Goethe drove home the principles of the new movement of *Sturm und Drang* in terse and pointed criticism. The exuberance of the young poet's genius is also to be seen in the many unfinished fragments of this period; at one time we find him occupied with dramas on *Caesar* and *Mahomet*, at another with an epic on *Der ewige Jude*, and again with a tragedy on *Prometheus*, of which a magnificent fragment has passed into his works. Greatest of all the trophies of this period, however, was the dramatization of *Faust*. Thanks to a manuscript copy of the play in its earliest form—discovered as recently as 1887—we are now able to distinguish how much of this tragedy was the immediate product of the *Sturm und Drang*, and to understand the intentions with which the young poet began his masterpiece. Goethe's hero changed with the author's ripening experience and with his new conceptions of man's place and duties in the world, but the Gretchen tragedy was taken over into the finished poem, practically unaltered, from the earliest *Faust* of the *Sturm und Drang*. With these wonderful scenes, the most intensely tragic in all German literature, Goethe's poetry in this period reaches its climax. Still another important work, however, was conceived, and in large measure written at this time, the drama of *Egmont*, which was not published until 1788. This work may, to some extent, be regarded as supplementary to *Faust*; it presents the lighter, more cheerful and optimistic side of Goethe's philosophy in these years; Graf Egmont, the most winning and fascinating of the poet's heroes, is endowed with that "demotic" power over the sympathies of men and women, which Goethe himself possessed in so high a degree. But *Egmont* depends for its interest almost solely on two characters, Egmont himself and Klärchen, Gretchen's counterpart; regarded as a drama, it demonstrates the futility of that defiance of convention and rules with which the *Sturm und Drang* set out. It remained for Goethe, in the next period of his life, to construct on classic models a new vehicle for German dramatic poetry.

In December 1774 the young "hereditary prince" of Weimar, Charles Augustus, passing through Frankfurt on his way to Paris, came into personal touch with Goethe, and invited the poet to visit Weimar when, in the following year, he took up the reins of government. In October 1775 the invitation was repeated, and on the 7th of November of that year Goethe arrived in the little Saxon capital which was to remain his home for the rest of his life. During the first few months in Weimar the poet gave himself up to the pleasures of the moment as unreservedly as his patron; indeed, the Weimar court even looked upon him for a time as a tempter who led the young duke astray. But the latter, although himself a mere stripling, had implicit faith in Goethe, and a firm conviction that his genius could be utilized in other fields besides literature. Goethe was not long in Weimar before he was entrusted with responsible state duties, and events soon justified the duke's confidence. Goethe proved the soul of the Weimar government, and a minister of state of energy and foresight. He interested himself in agriculture, horticulture and mining, which were of paramount importance to the welfare of the duchy, and out of these interests sprang his own love for the natural sciences, which took up so much of his time in later

years. The inevitable love-interest was also not wanting. As Friederike had fitted into the background of Goethe's Strassburg life, Lotte into that of Wetzlar, and Lili into the gaieties of Frankfurt, so now Charlotte von Stein, the wife of a Weimar official, was the personification of the more aristocratic ideals of Weimar society. We possess only the poet's share of his correspondence with Frau von Stein, but it is possible to infer from it that, of all Goethe's loves, this was intellectually the most worthy of him. Frau von Stein was a woman of refined literary taste and culture, seven years older than he and the mother of seven children. There was something more spiritual, something that partook rather of the passionate friendships of the 18th century than of love in Goethe's relations with her. Frau von Stein dominated the poet's life for twelve years, until his journey to Italy in 1786-1788. Of other events of this period the most notable were two winter journeys, the first in 1777, to the Harz Mountains, the second, two years later, to Switzerland—journeys which gave Goethe scope for that introspection and reflection for which his Weimar life left him little time. On the second of these journeys he revisited Friederike in Sesenheim, saw Lili, who had married and settled in Strassburg, and made the personal acquaintance of Lavater in Zürich.

The literary results of these years cannot be compared with those of the preceding period; they are virtually limited to a few wonderful lyrics, such as *Wanderers Nachlied*, *An den Mond*, *Gesang der Geister über den Wassern*, or ballads, such as *Der Erlkönig*, a charming little drama, *Die Geschwister* (1776), in which the poet's relations to both Lili and Frau von Stein seem to be reflected, a dramatic satire, *Der Triumph der Empfindsamkeit* (1778), and a number of *Singspiele*, *Lila* (1777), *Die Fischerin*, *Schere*, *List und Rache*, and *Jery und Bätely* (1780). But greater works were in preparation. A religious epic, *Die Geheimnisse*, and a tragedy *Elpenor*, did not, it is true, advance much further than plans; but in 1777, under the influence of the theatrical experiments at the Weimar court, Goethe conceived and in great measure wrote a novel of the theatre, which was to have borne the title *Wilhelm Meisters theatralische Sendung*; and in 1779 himself took part in a representation before the court at Ettersburg, of his drama *Iphigenie auf Tauris*. This *Iphigenie* was, however, in prose; in the following year Goethe remoulded it in iambics, but it was not until he went to Rome that the drama finally received the form in which we know it.

In September, 1786 Goethe set out from Karlsbad—secretly and stealthily, his plan known only to his servant—on that memorable journey to Italy, to which he had looked forward with such intense longing; he could not cross the Alps quickly enough, so impatient was he to set foot in Italy. He travelled by way of Munich, the Brenner and Lago di Garda to Verona and Venice, and from thence to Rome, where he arrived on the 29th of October 1786. Here he gave himself up unreservedly to the new impressions which crowded on him, and he was soon at home among the German artists in Rome, who welcomed him warmly. In the spring of 1787 he extended his journey as far as Naples and Sicily, returning to Rome in June 1787, where he remained until his final departure for Germany on the 2nd of April 1788. It is difficult to exaggerate the importance of Goethe's Italian journey. He himself regarded it as a kind of climax to his life; never before had he attained such complete understanding of his genius and mission in the world; it afforded him a vantage-ground from which he could renew the past and make plans for the future. In Weimar he had felt that he was no longer in sympathy with the *Sturm und Drang*, but it was Italy which first taught him clearly what might take the place of that movement in German poetry. To the modern reader, who may well be impressed by Goethe's extraordinary receptivity, it may seem strange that his interests in Italy were so limited; for, after all, he saw comparatively little of the art treasures of Italy. He went to Rome in Winkelmann's footsteps; it was the antique he sought, and his interest in the artists of the Renaissance was virtually restricted to their imitation of classic models. This search for the classic ideal is reflected in the works he completed or wrote under the Italian sky. The calm beauty

of Greek-tragedy is seen in the new iambic version of *Iphigenie auf Tauris* (1787); the classicism of the Renaissance gives the ground-tone to the wonderful drama of *Torquato Tasso* (1790), in which the conflict of poetic genius with the prosaic world is transmuted into imperishable poetry. Classic, too, in this sense, were the plans of a drama on *Iphigenie auf Delphos* and of an epic, *Nausikaa*. Most interesting of all, however, is the reflection of the classic spirit in works already begun in earlier days, such as *Egmont* and *Faust*. The former drama was finished in Italy and appeared in 1788, the latter was brought a step further forward, part of it being published as a *Fragment* in 1790.

Disappointment in more senses than one awaited Goethe on his return to Weimar. He came back from Italy with a new philosophy of life, a philosophy at once classic and pagan, and with very definite ideas of what constituted literary excellence. But Germany had not advanced; in 1788 his countrymen were still under the influence of that *Sturm und Drang* from which the poet had fled. The times seemed to him more out of joint than ever, and he withdrew into himself. Even his relations to the old friends were changed. Frau von Stein had not known of his flight to Italy until she received a letter from Rome; but he looked forward to her welcome on his return. The months of absence, however, the change he had undergone, and doubtless those lighter loves of which the *Römische Elegien* bear evidence, weakened the Weimar memories; if he left Weimar as Frau von Stein's lover he returned only as her friend; and she naturally resented the change. Goethe, meanwhile, satisfied to continue the freer customs to which he had adapted himself in Rome, found a new mistress in Christiano Vulpius (1765-1816), the least interesting of all the women who attracted him. But Christiane gradually filled up a gap in the poet's life; she gave him, quietly, unobtrusively, without making demands on him, the comforts of a home. She was not accepted by court society; it did not matter to her that even Goethe's intimate friends ignored her; and she, who had suited the poet's whim when he desired to shut himself off from all that might dim the recollection of Italy, became with the years an indispensable helpmate to him. On the birth in 1789 of his son, Goethe had some thought of legalizing his relations with Christiane, but this intention was not realized until 1806, when the invasion of Weimar by the French made him fear for both life and property.

The period of Goethe's life which succeeded his return from Italy was restless and unsettled; relieved of his state duties, he returned in 1790 to Venice, only to be disenchanted with the Italy he had loved so intensely a year or two before. A journey with the duke of Weimar to Breslau followed, and in 1792 he accompanied his master on that campaign against France which ended so ingloriously for the German arms at Valmy. In later years Goethe published his account both of this *Campagne in Frankreich* and of the *Belagerung von Mainz*, at which he was also present in 1793. His literary work naturally suffered under these distractions. *Tasso*, and the edition of the *Schriften* in which it was to appear, had still to be completed on his return from Italy; the *Römische Elegien*, perhaps the most Latin of all his works, were published in 1795, and the *Venetianische Epigramme*, the result of the second visit to Italy, in 1796. The French Revolution, in which all Europe was engrossed, was in Goethe's eyes only another proof that the passing of the old régime meant the abrogation of all law and order, and he gave voice to his antagonism to the new democratic principles in the dramas *Der Grosskopft* (1792), *Der Bürgergeneral* (1793), and in the unfinished fragments *Die Aufgeregten* and *Das Mädchen von Oberbirch*. The spirited translation of the epic of *Reinecke Fuchs* (1794) he took up as a relief and an antidote to the social disruption of the time. Two new interests, however, strengthened the ties between Goethe and Weimar,—ties which the Italian journey had threatened to sever: his appointment in 1791 as director of the ducal theatre, a post which he occupied for twenty-two years, and his absorption in scientific studies. In 1790 he published his important *Versuch, die Metamorphose der Pflanzen zu erklären*, which was an even more fundamental achievement for the new science of comparative morphology

than his discovery some six years earlier of the existence of a formation in the human jaw-bone analogous to the intermaxillary bone in apes; and in 1791 and 1792 appeared two parts of his *Beiträge zur Optik*.

Meanwhile, however, Goethe had again taken up the novel of the theatre which he had begun years before, with a view to finishing it and including it in the edition of his *Neue Schriften* (1792-1800). *Wilhelm Meisters theatralische Sendung* became *Wilhelm Meisters Lehrjahre*; the novel of purely theatrical interests was widened out to embrace the history of a young man's apprenticeship to life. The change of plan explains, although it may not exculpate, the formlessness and loose construction of the work, its extremes of realistic detail and poetic allegory. A hero, who was probably originally intended to demonstrate the failure of the vacillating temperament when brought face to face with the problems of art, proved ill-adapted to demonstrate those precepts for the guidance of life with which the *Lehrjahre* closes; unstable of purpose, Wilhelm Meister is not so much an illustration of the author's life-philosophy as a lay-figure on which he demonstrates his views. *Wilhelm Meister* is a work of extraordinary variety, ranging from the commonplace realism of the troupe of strolling players to the poetic romanticism of Mignon and the harper; its flashes of intuitive criticism and its weighty apothegms add to its value as a *Bildungsroman* in the best sense of that word. Of all Goethe's works, this exerted the most immediate and lasting influence on German literature; it served as a model for the best fiction of the next thirty years.

In completing *Wilhelm Meister*, Goethe found a sympathetic and encouraging critic in Schiller, to whom he owed in great measure his renewed interest in poetry. After years of tentative approaches on Schiller's part, years in which that poet concealed even from himself his desire for a friendly understanding with Goethe, the favourable moment arrived; it was in June 1794, when Schiller was seeking collaborators for his new periodical *Die Horen*; and his invitation addressed to Goethe was the beginning of a friendship which continued unbroken until the younger poet's death. The friendship of Goethe and Schiller, of which their correspondence is a priceless record, had its limitations; it was purely intellectual in character, a certain barrier of personal reserve being maintained to the last. But for the literary life of both poets the gain was incommensurable. As far as actual work was concerned, Goethe went his own way as he had always been accustomed to do; but the mere fact that he devoted himself with increasing interest to literature was due to Schiller's stimulus. It was Schiller, too, who induced him to undertake those studies on the nature of epic and dramatic poetry which resulted in the epic of *Hermann und Dorothea* and the fragment of the *Achilleis*; without the friendship there would have been no *Xenien* and no ballads, and it was his younger friend's encouragement which induced Goethe to betake himself once more to the "misty path" of *Faust*, and bring the first part of that drama to a conclusion.

Goethe's share in the *Xenien* (1795) may be briefly dismissed. This collection of distichs, written in collaboration with Schiller, was prompted by the indifference and animosity of contemporary criticism, and its disregard for what the two poets regarded as the higher interests of German poetry. The *Xenien* succeeded as a retaliation on the critics, but the masterpieces which followed them proved in the long run much more effective weapons against the prevailing mediocrity. Prose works like the *Unterhaltungen deutscher Ausgewanderten* (1795) were unworthy of the poet's genius, and the translation of Benvenuto Cellini's *Life* (1796-1797) was only a translation. But in 1798 appeared *Hermann und Dorothea*, one of Goethe's most perfect poems. It is indeed remarkable—when we consider by how much reflection and theoretic discussion the composition of the poem was preceded and accompanied—that it should make upon the reader so simple and "naïve" an impression; in this respect it is the triumph of an art that conceals art. Goethe has here taken a simple story of village life, mirrored in it the most pregnant ideas of his time, and presented it with a skill which may well be called Homeric; but he has discriminated with

the insight of genius between the Homeric method of reproducing the heroic life of primitive Greece and the same method as adapted to the commonplace happenings of 18th-century Germany. In this respect he was undoubtedly guided by a forerunner who has more right than he to the attribute "naïve," by J. H. Voss, the author of *Luise*. Hardly less imposing in their calm, placid perfection are the poems with which, in friendly rivalry, Goethe seconded the more popular ballads of his friend; *Der Zauberlehrling*, *Der Gott und die Bayadere*, *Die Braut von Korinth*, *Alexis und Dora*, *Der neue Pausias* and *Die schöne Müllerin*—a cycle of poems in the style of the *Volkslied*—are among the masterpieces of Goethe's poetry. On the other hand, even the friendship with Schiller did not help him to add to his reputation as a dramatist. *Die natürliche Tochter* (1803), in which he began to embody his ideas of the Revolution on a wide canvas, proved impossible on the stage, and the remaining dramas, which were to have formed a trilogy, were never written. Goethe's classic principles, when applied to the swift, direct art of the theatre, were doomed to failure, and *Die natürliche Tochter*, notwithstanding its good theoretic intention, remains the most lifeless and shadowy of all his dramas. Even less in touch with the living present were the various prologues and *Festspiele*, such as *Paläophron und Neoterpe* (1800), *Was wir bringen* (1802), which in these years he composed for the Weimar theatre.

Goethe's classicism brought him into inevitable antagonism with the new Romantic movement which had been inaugurated in 1798 by the *Athenaeum*, edited by the brothers Schlegel. The sharpness of the conflict was, however, blunted by the fact that, without exception, the young Romantic writers looked up to Goethe as its master; they modelled their fiction on *Wilhelm Meister*; they regarded his lyrics as the high-water mark of German poetry; Goethe, Novalis declared, was the "Statthalter of poetry on earth." With regard to painting and sculpture, however, Goethe felt that a protest was necessary, if the insidious ideas propounded in works like Wackenroder's *Herzensergussungen* were not to do irreparable harm, by bringing back the confusion of the *Sturm und Drang*; and, as a rejoinder to the Romantic theories, Goethe, in conjunction with his friend Heinrich Meyer (1760-1832), published from 1798 to 1800 an art review, *Die Propyläen*. Again, in *Winckelmann und seine Zeit* (1805) Goethe vigorously defended the classical ideals of which Winckelmann had been the founder. But in the end he proved himself the greatest enemy to the strict classic doctrine by the publication in 1808 of the completed first part of *Faust*, a work which was accepted by contemporaries as a triumph of Romantic art. *Faust* is a patchwork of many colours. With the aid of the vast body of *Faust* literature which has sprung up in recent years, and the many new documents bearing on its history—above all, the so-called *Urfaust*, to which reference has already been made—we are able now to ascribe to their various periods the component parts of the work; it is possible to discriminate between the *Sturm und Drang* hero of the opening scenes and of the Gretchen tragedy—the contemporary of Götz and Clavigo—and the superimposed Faust of calmer moral and intellectual ideals—a Faust who corresponds to Hermann and Wilhelm Meister. In its original form the poem was the dramatization of a specific and individualized story; in the years of Goethe's friendship with Schiller it was extended to embody the higher strivings of 18th-century humanism; ultimately, as we shall see, it became, in the second part, a vast allegory of human life and activity. Thus the elements of which *Faust* is composed were even more difficult to blend than were those of *Wilhelm Meister*; but the very want of uniformity is one source of the perennial fascination of the tragedy, and has made it in a peculiar degree the national poem of the German people, the mirror which reflects the national life and poetry from the outburst of *Sturm und Drang* to the well-weighed and tranquil classicism of Goethe's old age.

The third and final period of Goethe's long life may be said to have begun after Schiller's death. He never again lost touch with literature as he had done in the years which preceded his

friendship with Schiller; but he stood in no active or immediate connexion with the literary movement of his day. His life moved on comparatively uneventfully. Even the Napoleonic régime of 1806-1813 disturbed but little his equanimity. Goethe, the cosmopolitan *Weltbürger* of the 18th century, had himself no very intense feelings of patriotism, and, having seen Germany flourish as a group of small states under enlightened despotisms, he had little confidence in the dreamers of 1813 who hoped to see the glories of Barbarossa's empire revived. Napoleon, moreover, he regarded not as the scourge of Europe, but as the defender of civilization against the barbarism of the Slavs; and in the famous interview between the two men at Erfurt the poet's admiration was reciprocated by the French conqueror. Thus Goethe had no great sympathy for the war of liberation which kindled young hearts from one end of Germany to the other; and when the national enthusiasm rose to its highest pitch he buried himself in those optical and morphological studies, which, with increasing years, occupied more and more of his time and interest.

The works and events of the last twenty-five years of Goethe's life may be briefly summarized. In 1805, as we have seen, he suffered an irreparable loss in the death of Schiller; in 1806, Christiane became his legal wife, and to the same year belongs the magnificent tribute to his dead friend, the *Epilog zu Schillers Glocke*. Two new friendships about this time kindled in the poet something of the juvenile fire and passion of younger days. Bettina von Arnim came into personal touch with Goethe in 1807, and her *Briefwechsel Goethes mit einem Kinde* (published in 1835) is, in its mingling of truth and fiction, one of the most delightful products of the Romantic mind; but the episode was of less importance for Goethe's life than Bettina would have us believe. On the other hand, his interest in Minna Herzlieb, foster-daughter of the publisher Frommann in Jena, was of a warmer nature, and has left its traces on his sonnets.

In 1808, as we have seen, appeared the first part of *Faust*, and in 1809 it was followed by *Die Wahlverwandtschaften*. The novel, hardly less than the drama, effected a change in the public attitude towards the poet. Since the beginning of the century the conviction had been gaining ground that Goethe's mission was accomplished, that the day of his leadership was over; but here were two works which not merely re-established his ascendancy, but proved that the old poet was in sympathy with the movement of letters, and keenly alive to the change of ideas which the new century had brought in its train. The intimate psychological study of four minds, which forms the subject of the *Wahlverwandtschaften*, was an essay in a new type of fiction, and pointed out the way for developments of the German novel after the stimulus of *Wilhelm Meister* had exhausted itself. Less important than *Die Wahlverwandtschaften* was *Pandora* (1810), the final product of Goethe's classicism, and the most uncompromisingly classical and allegorical of all his works. And in 1810, too, appeared his treatise on *Farbenlehre*. In the following year the first volume of his autobiography was published under the title *Aus meinem Leben, Dichtung und Wahrheit*. The second and third volumes of this work followed in 1812 and 1814; the fourth, bringing the story of his life up to the close of the Frankfurt period in 1833, after his death. Goethe felt, even late in life, too intimately bound up with Weimar to discuss in detail his early life there, and he shrank from carrying his biography beyond the year 1775. But a number of other publications—descriptions of travel, such as the *Italienische Reise* (1816-1817), the materials for a continuation of *Dichtung und Wahrheit* collected in *Tag- und Jahreshefte* (1830)—have also to be numbered among the writings which Goethe has left us as documents of his life. Meanwhile no less valuable biographical materials were accumulating in his diaries, his voluminous correspondence and his conversations, as recorded by J. P. Eckermann, the chancellor Müller and F. Soret. Several periodical publications, *Über Kunst und Altertum* (1816-1832), *Zur Naturwissenschaft überhaupt* (1817-1824), *Zur Morphologie* (1817-1824), bear witness to the extraordinary breadth of Goethe's interests in these years. Art, science, literature—little

escaped his ken—and that not merely in Germany: English writers, Byron, Scott and Carlyle, Italians like Manzoni, French scientists and poets, could all depend on friendly words of appreciation and encouragement from Weimar.

In *West-östlicher Diwan* (1819), a collection of lyrics—matchless in form and even more concentrated in expression than those of earlier days—which were suggested by a German translation of Hafiz, Goethe had another surprise in store for his contemporaries. And, again, it was an actual passion—that for Marianne von Willemer, whom he met in 1814 and 1815—which rekindled in him the lyric fire. Meanwhile the years were thinning the ranks of Weimar society: Wieland, the last of Goethe's greater literary contemporaries, died in 1813, his wife in 1816, Charlotte von Stein in 1827 and Duke Charles Augustus in 1828. Goethe's retirement from the direction of the theatre in 1817 meant for him a break with the literary life of the day. In 1822 a passion for a young girl, Ulrike von Levetzow, whom he met at Marienbad, inspired the fine *Trilogie der Leidenschaft*, and between 1821 and 1829 appeared the long-expected and long-promised continuation of *Wilhelm Meister*, *Wilhelm Meisters Wanderjahre*. The latter work, however, was a disappointment: perhaps it could not have been otherwise. Goethe had lost the thread of his romance and it was difficult for him to resume it. Problems of the relation of the individual to society and industrial questions were to have formed the theme of the *Wanderjahre*; but since the French Revolution these problems had themselves entered on a new phase and demanded a method of treatment which it was not easy for the old poet to learn. Thus his intentions were only partially carried out, and the volumes were filled out by irrelevant stories, which had been written at widely different periods.

But the crowning achievement of Goethe's literary life was the completion of *Faust*. The poem had accompanied him from early manhood to the end and was the repository for the fullest "confession" of his life; it is the poetic epitome of his experience. The second part is, in form, far removed from the impressive realism of the *Urfaust*. It is a phantasmagory; a drama the actors in which are not creatures of flesh and blood, but the shadows of an unreal world of allegory. The lover of Gretchen had, as far as poetic continuity is concerned, disappeared with the close of the first part. In the second part it is virtually a new Faust who, at the hands of a new Mephistopheles, goes out into a world that is not ours. Yet behind these unconvincing shadows of an imperial court with its financial difficulties, of the classical *Walpurgisnacht*, of the fantastic creation of the Homunculus, the noble Helena episode and the impressive mystery-scene of the close, where the centenarian Faust finally triumphs over the powers of evil, there lies a philosophy of life, a ripe wisdom born of experience, such as no European poet had given to the world since the Renaissance. *Faust* has been well called the "divine comedy" of 18th-century humanism.

The second part of *Faust* forms a worthy close to the life of Germany's greatest man of letters, who died in Weimar on the 22nd of March 1832. He was the last of those universal minds which have been able to compass all domains of human activity and knowledge; for he stood on the brink of an era of rapidly expanding knowledge which has made for ever impossible the universality of interest and sympathy which distinguished him. As a poet, his fame has undergone many vicissitudes since his death, ranging from the indifference of the "Young German" school to the enthusiastic admiration of the closing decades of the 19th century—an enthusiasm to which we owe the Weimar *Goethe-Gesellschaft* (founded in 1885) and a vast literature dealing with the poet's life and work; but the fact of his being Germany's greatest poet and the master of her classical literature has never been seriously put in question. The intrinsic value of his poetic work, regarded apart from his personality, is smaller in proportion to its bulk than is the case with many lesser German poets and with the greatest poets of other literatures. But Goethe was a type of literary man hitherto unrepresented among the leading writers of the world's literature; he was a poet whose supreme greatness lay in his subjectivity. Only a small fraction

of Goethe's work was written in an impersonal and objective spirit, and sprang from what might be called a conscious artistic impulse; by far the larger—and the better—part is the immediate reflex of his feelings and experiences.

It is as a lyric poet that Goethe's supremacy is least likely to be challenged; he has given his nation, whose highest literary expression has in all ages been essentially lyric, its greatest songs. No other German poet has succeeded in attuning feeling, sentiment and thought so perfectly to the music of words as he; none has expressed so fully that spirituality in which the quintessence of German lyricism lies. Goethe's dramas, on the other hand, have not, in the eyes of his nation, succeeded in holding their own beside Schiller's; but the reason is rather because Goethe, from what might be called a wilful obstinacy, refused to be bound by the conventions of the theatre, than because he was deficient in the cunning of the dramatist. For, as an interpreter of human character in the drama, Goethe is without a rival among modern poets, and there is not one of his plays that does not contain a few scenes or characters which bear indisputable testimony to his mastery. *Faust* is Germany's most national drama, and it remains perhaps for the theatre of the future to prove itself capable of popularizing psychological masterpieces like *Tasso* and *Iphigenie*. It is as a novelist that Goethe has suffered most by the lapse of time. *The Sorrows of Werther* no longer moves us to tears, and even *Wilhelm Meister* and *Die Wahlverwandtschaften* require more understanding for the conditions under which they were written than do *Faust* or *Egmont*. Goethe could fill his prose with rich wisdom, but he was only the perfect artist in verse.

Little attention is nowadays paid to Goethe's work in other fields, work which he himself in some cases prized more highly than his poetry. It is only as an illustration of his many-sidedness and his manifold activity that we now turn to his work as a statesman, as a theatre-director, as a practical political economist. His art-criticism is symptomatic of a phase of European taste which tried in vain to check the growing individualism of Romanticism. His scientific studies and discoveries awaken only an historical interest. We marvel at the obstinacy with which he, with inadequate mathematical knowledge, opposed the Newtonian theory of light and colour; and at his championship of "Neptunism," the theory of aqueous origin, as opposed to "Vulcanism," that of igneous origin of the earth's crust. Of far-reaching importance was, on the other hand, his foreshadowing of the Darwinian theory in his works on the metamorphosis of plants and on animal morphology. Indeed, the deduction to be drawn from Goethe's contributions to botany and anatomy is that he, as no other of his contemporaries, possessed that type of scientific mind which, in the 19th century, has made for progress, he was Darwin's predecessor by virtue of his enunciation of what has now become one of the common-places of natural science—organic evolution. Modern, too, was the outlook of the aging poet on the changing social conditions of the age, wonderfully sympathetic his attitude towards modern industry, which steam was just beginning to establish on a new basis, and towards modern democracy. The Europe of his later years was very different from the idyllic and enlightened autocracy of the 18th century, in which he had spent his best years and to which he had devoted his energies; yet Goethe was at home in it.

From the philosophic movement, in which Schiller and the Romanticists were so deeply involved, Goethe stood apart. Comparatively early in life he had found in Spinoza the philosopher who responded to his needs, Spinoza taught him to see in nature the "living garment of God," and more he did not seek or need to know. As a convinced realist he took his standpoint on nature and experience, and could afford to look on objectively at the controversies of the metaphysicians. Kant he by no means ignored, and under Schiller's guidance he learned much from him; but of the younger thinkers, only Schelling, whose mystic nature-philosophy was a development of Spinoza's ideas, touched a sympathetic chord in his nature. As a moralist and a guide to the conduct of life—an aspect of Goethe's work

which Carlyle, viewing him through the coloured glasses of Fichtean idealism, emphasized and interpreted not always justly—Goethe was a powerful force on German life in years of political and intellectual depression. It is difficult even still to get beyond the maxims of practical wisdom he scattered so liberally through his writings, the lessons to be learned from *Meister* and *Faust*, or even that calm, optimistic fatalism which never deserted Goethe, and was so completely justified by the tenor of his life. If the philosophy of Spinoza provided the poet with a religion which made individual creeds and dogmas unnecessary and impossible, so Leibnitz's doctrine of predestination supplied the foundations for his faith in the divine mission of human life.

This many-sided activity is a tribute to the greatness of Goethe's mind and personality; we may regard him merely as the embodiment of his particular age, or as a poet "for all time"; but with one opinion all who have felt the power of Goethe's genius are in agreement—the opinion which was condensed in Napoleon's often cited words, uttered after the meeting at Erfurt: *Voilà un homme!* Of all modern men, Goethe is the most universal type of genius. It is the full, rich humanity of his life and personality—not the art behind which the artist disappears, or the definite pronouncements of the thinker or the teacher—that constitutes his claim to a place in the front rank of men of letters. His life was his greatest work.

BIBLIOGRAPHY.—(a) *Collected Works, Diaries, Correspondence, Conversations.* The following authorized editions of Goethe's writings appeared in the poet's lifetime: *Schriften* (8 vols., Leipzig, 1787-1793); *Neue Schriften* (7 vols., Berlin, 1792-1801), *Werke* (13 vols., Stuttgart, 1806-1810); *Werke* (20 vols., Stuttgart, 1818-1819); to which six volumes were added in 1820-1822; *Werke* (Vollständige Ausgabe letzter Hand) (40 vols., Stuttgart, 1827-1830). Goethe's *Nachgelassene Werke* appeared as a continuation of this edition in 15 volumes (Stuttgart, 1832-1834), to which five volumes were added in 1842. These were followed by several editions of Goethe's *Sämtliche Werke*, mostly in forty volumes, published by Cotta of Stuttgart. The first critical edition with notes was published by Hempel, Berlin, in thirty-six volumes, 1868-1879; that in Kürschner's *Deutsche Nationalbibliothek*, vols. 82-117 (1882-1897) is also important. In 1887 the monumental Weimar edition, which is now approaching completion, began to appear; it is divided into four sections: I. *Werke* (c. 56 vols.); II. *Naturwissenschaftliche Werke* (12 vols.); III. *Tagebücher* (13 vols.); IV. *Briefe* (c. 45 vols.). Of other recent editions the most noteworthy are: *Sämtliche Werke* (Jubiläums-Ausgabe), edited by E. von der Hellen (40 vols., Stuttgart, 1902 ff.); *Werke*, edited by K. Heinemann (39 vols., Leipzig, 1900 ff.), and the cheap edition of the *Sämtliche Werke*, edited by L. Geiger (44 vols., Leipzig, 1901). There are also innumerable editions of selected works; references need only be made here to the useful collection of the early writings and letters published by S. Hitzel with an introduction by M. Bernays, *Der junge Goethe* (3 vols., Leipzig, 1875, 2nd ed., 1887). A French translation of Goethe's *Œuvres complètes*, by J. Porchat, appeared in 9 vols., at Paris, in 1860-1863. There is, as yet, no uniform English edition, but Goethe's chief works have all been frequently translated and a number of them will be found in Bohn's standard library.

The definitive edition of Goethe's diaries and letters is that forming Sections III. and IV. of the Weimar edition. Collections of selected letters based on the Weimar edition have been published by E. von der Hellen (6 vols., 1901 ff.), and by P. Stein (8 vols., 1902 ff.). Of the many separate collections of Goethe's correspondence mention may be made of the *Briefwechsel zwischen Schiller und Goethe*, edited by Goethe himself (1828-1829; 4th ed., 1881; also several cheap reprints. English translation by L. D. Schmitz, 1877-1879); *Briefwechsel zwischen Goethe und Zelter* (6 vols., 1833-1834; reprint in Reclam's *Universalsbibliothek*, 1904; English translation by A. D. Coleridge, 1887); *Bettina von Arnim, Goethes Briefwechsel mit einem Kinde* (1835; 4th ed., 1899; English translation, 1838); *Briefe von und an Goethe*, edited by F. W. Riemer (1846); *Goethes Briefe an Frau von Stern*, edited by A. Schöll (1848-1851; 2nd ed. by J. Wahlé, 1899-1900); *Briefwechsel zwischen Goethe und K. F. von Reinhard* (1859); *Briefwechsel zwischen Goethe und Knebel* (2 vols., 1851); *Briefwechsel zwischen Goethe und Staatsrat Schultz* (1853); *Briefwechsel des Herzogs Karl August mit Goethe* (2 vols., 1863); *Briefwechsel zwischen Goethe und Kaspar Graf von Sternberg* (1865); *Goethes naturwissenschaftliche Correspondenz, and Goethes Briefwechsel mit den Gebrüthern von Humboldt*, edited by F. T. Bratranek (1874-1876); *Goethes und Carlyles Briefwechsel* (1887), also in English: *Goethe und die Romantik*, edited by C. Schüddekopf and O. Walzel (2 vols., 1898-1899); *Goethe und Lavalet*, edited by H. Funck (1901); *Goethe und Osterrath*, edited by A. Sauer (2 vols., 1902-1903). Besides the correspondence with Schiller and Zelter, Bohn's library contains a translation of *Early and Miscellaneous*

Letters, by E. Bell (1884). The chief collections of Goethe's conversations are: J. P. Eckermann, *Gespräche mit Goethe* (1836; vol. iii., also containing conversations with Soret, 1848; 7th ed. by H. Düntzer, 1899; also new edition by L. Geiger, 1902; English translation by J. Osnford, 1850). The complete conversations with Soret have been published in German translation by C. A. H. Burkhardt (1905); *Goethes Unterhaltungen mit dem Kanstler F. von Müller* (1870). Goethe's collected *Gespräche* were published by W. von Biedermann in 10 vols. (1889-1896).

(b) *Biography*.—Goethe's autobiography, *Aus meinem Leben: Dichtung und Wahrheit*, appeared in three parts between 1811 and 1814, a fourth part, bringing the history of his life as far as his departure for Weimar in 1775, in 1833 (English translation by J. Osnford, 1846); it is supplemented by other biographical writings, as the *Italienische Reise*; *Aus einer Reise in die Schweiz im Jahre 1797*; *Aus einer Reise am Rhein, Main und Neckar in dem Jahre 1814*; and *1815, Tag- und Jahreshefte*, &c., and especially by his diaries and correspondence. The following are the more important biographies: H. Döring, *Goethes Leben* (1828; subsequent editions, 1833, 1849, 1856); H. Viehoff, *Goethes Leben* (4 vols., 1847-1854; 5th ed., 1887); J. W. Schäfer, *Goethes Leben* (2 vols., 1841; 3rd ed., 1877); G. H. Lewes, *The Life and Works of Goethe* (2 vols., 1855; 2nd ed., 1864; 3rd ed., 1875; cheap reprint, 1906; the German translation by J. Froese is in its 18th edition, 1900; a shorter biography was published by Lewes in 1873 under the title *The Story of Goethe's Life*); W. Mézières, *W. Goethe, les œuvres expliquées par la vie* (1872-1873); A. Bossert, *Goethe* (1872-1873); K. Goedeke, *Goethes Leben und Schriften* (1874; 2nd ed., 1877); H. Grimm, *Goethe: Vorträge* (1876; 8th ed., 1903; English translation, 1880); A. Hayward, *Goethe* (1878); H. H. Boyesen, *Goethe and Schiller, their Lives and Works* (1879); H. Düntzer, *Goethes Leben* (1880; 2nd ed., 1883; English translation, 1883); A. Baumgartner, *Goethe, sein Leben und seine Werke* (1885); J. Sime, *Life of Goethe* (1888); K. Heinemann, *Goethes Leben und Werke* (1889; 3rd ed., 1903); R. M. Meyer, *Goethe* (1894; 3rd ed., 1904); A. Bielschowsky, *Goethe, sein Leben und seine Werke* (vol. i., 1895; 5th ed., 1904; vol. ii., 1907; English translation by W. A. Cooper, 1905 ff.); G. Witkowski, *Goethe* (1899); H. G. Atkins, *J. W. Goethe* (1904); P. Hansen and R. Meyer, *Goethe, hans Liv og Værker* (1906).

Of writings on special periods and aspects of Goethe's life the more important are as follows (the titles are arranged as far as possible in the chronological sequence of the poet's life): H. Düntzer, *Goethes Stammbaum* (1894); K. Heinemann, *Goethes Mutter* (1891; 6th ed., 1900); P. Bastier, *La Mère de Goethe* (1902); *Briefe der Frau Rat* (2 vols., 2nd ed., 1905); F. Ewart, *Goethes Vater* (1899); G. Witkowski, *Cornelia die Schwester Goethes* (1903); P. Besson, *Goethe, sa sœur et ses amies* (1898); H. Düntzer, *Frauenbilder aus Goethes Jugendzeit* (1852); W. von Biedermann, *Goethe und Leipzig* (1865); P. F. Lucius, *Friederike Brion* (1878; 3rd ed., 1904); A. Bielschowsky, *Friederike Brion* (1880); F. E. von Durchheim, *Lili's Bild geschichtlich entworfen* (1879; 2nd ed., 1894); W. Herbst, *Goethe in Weimar* (1881); A. Diezmann, *Goethe und die lustige Zeit in Weimar* (1887; 2nd ed., 1901); H. Düntzer, *Goethe und Karl August* (1895-1894; 2nd ed., 1898); also, by the same author, *Aus Goethes Freundeskreis* (1868) and *Charlotte von Stein* (2 vols., 1874); J. Haunthun, *Auf Goethes Spuren in Italien* (1896-1898); O. Harnack, *Zur Nachgeschichte der italienischen Reise* (1890); H. Grimm, *Schiller und Goethe* (Essays, 1848; 3rd ed., 1884); G. Berlit, *Goethe und Schiller im persönlichen Verkehr, nach brieflichen Mitteilungen von H. Voss* (1895); E. Pasqué, *Goethes Theaterleitung in Weimar* (3 vols., 1865); C. A. H. Burkhardt, *Das Repertoire des weimarer Theaters unter Goethes Leitung* (1891); J. Wahle, *Das Weimarer Hoftheater unter Goethes Leitung* (1892); O. Harnack, *Goethe in der Epoche seiner Vollendung* (2nd ed., 1901); J. Barbey d'Aurevilly, *Goethe et Diderot* (1880); A. Fischer, *Goethe und Napoleon* (1899; 2nd ed., 1900); R. Steig, *Goethe und die Gebrüder Grimm* (1892).

(c) *Criticism*.—H. G. Graef, *Goethe über seine Dichtungen* (1901 ff.); J. W. Braun, *Goethe im Urtheile seiner Zeitgenossen* (3 vols., 1883-1885); T. Carlyle, *Essays on Goethe* (1828-1832); X. Marmier, *Études sur Goethe* (1835); W. von Biedermann, *Goethe-Forschungen* (1879, 1886); J. Minor and A. Sauer, *Studien zur Goethe-Philologie* (1880); H. Düntzer, *Abhandlungen zu Goethes Leben und Werken* (1881); A. Schön, *Goethe in Hauptzügen seines Lebens und Wirkens* (1882); V. Hehn, *Gedanken über Goethe* (1884; 4th ed., 1900); W. Scherer, *Aufsätze über Goethe* (1886); J. R. Seeley, *Goethe examined after Sixty Years* (1894); E. Dowden, *New Studies in Literature* (1895); E. Rod, *Essai sur Goethe* (1898); A. Luther, *Goethe, sechs Vorträge* (1905); R. Saitchik, *Goethes Charakter* (1898); W. Bode, *Goethes Lebenskunst* (1900; 2nd ed., 1902); by the same, *Goethes Ästhetik* (1901); T. Vollbeh, *Goethe und die bildende Kunst* (1895); E. Lichtenberger, *Études sur les poésies lyriques de Goethe* (1878); T. Achelis, *Grundzüge der Lyrik Goethes* (1900); B. Litzmann, *Goethes Lyrik* (1903); K. Riemann, *Goethes Romanistik* (1901); R. Virchow, *Goethe als Naturforscher* (1861); E. Caro, *La Philosophie de Goethe* (1866; 2nd ed., 1870); K. Steiner, *Goethes Weltanschauung* (1897); F. Siebeck, *Goethe als Denker* (1902); F. Baldensperger, *Goethe en France* (1904); S. Waetzoldt, *Goethe und die Romantiker* (1888).

More special treatises dealing with individual works are this

following: W. Scherer, *Aus Goethes Frühzeit* (1870); R. Weissenfels, *Goethe in Sturm und Drang*, vol. i (1894); W. Wilmanns, *Quellenstudien zu Goethes Götts von Berlichingen* (1874); J. Baechtold, *Goethes Götts von Berlichingen in dreifacher Gestalt* (1882); J. W. Appell, *Werther und seine Zeit* (1885; 4th ed., 1896); E. Schmidt, *Richardson, Rousseau und Goethe* (1875); M. Herrmann, *Das Jahr marktsfest zu Plundersweilen* (1900); E. Schmidt, *Goethes Faust in ursprünglicher Gestalt* (1887; 5th ed., 1901); J. Collin, *Goethes Faust in seiner ältesten Gestalt* (1896); H. Hettner, *Goethes Iphigene in ihrem Verhältnis zur Bildungsgeschichte des Dichters* (1861, in *Kleine Schriften*, 1884); K. Fischer, *Goethes Iphigene* (1888); F. T. Bratranek, *Goethes Egmont und Schillers Wallenstein* (1862); C. Schuchardt, *Goethes italienische Reise* (1862); H. Düntzer, *Iphigene auf Tauris; die drei ältesten Bearbeitungen* (1854); F. Kern, *Goethes Tasso* (1890); J. Schubart, *Die philosophischen Grundgedanken in Goethes Wilhelm Meister* (1896); E. Bona, *Schiller und Goethe in Xenienkampf* (1851); E. Schmidt and B. Suphaa, *Xenien 1796, nach den Handschriften* (1893); W. von Humboldt, *Ästhetische Verruchte: Hermann und Dorothea* (1893); A. Fries, *Quellen und Komposition der Achilleis* (1901); K. Alt, *Studien zur Entstehungsgeschichte der Dichtung und Wahrheit* (1898); A. Jung, *Goethes Wanderjahre und die wichtigsten Fragen des 19. Jahrhunderts* (1854); F. Kreyzig, *Vorlesungen über Goethes Faust* (1866); the editions of *Faust* by G. von Loeper (2 vols., 1879), and K. J. Schrüfer (2 vols., 3rd and 4th ed., 1868-1903); K. Fischer, *Goethes Faust* (3 vols., 1893, 1902, 1903); O. Paivower, *Goethes Faust, Zeugnisse und Excursus zu seiner Entstehungsgeschichte* (1899); J. Minor, *Goethes Faust, Entstehungsgeschichte und Erklärung* (2 vols., 1901).

(d) *Bibliographical Works, Goethe-Societies, &c.*—L. Ullrich, *Das Goethe-Literatur in Deutschland* (1878); S. Hirsch, *Vernachlässigt einer Goethe-Bibliothek* (1884), to which G. von Loeper and W. von Biedermann have supplied supplements. F. Strehle, *Goethes Briefe. Verzeichniss unter Angabe der Quelle* (1882-1884), *British Museum Catalogue of Printed Books: Goethe* (1885); *Goethes Grammatik zur Geschichte der deutschen Dichtung* (2nd ed., vol. iv, 1891); and the bibliographies in the *Goethe-Jahrbuch* (since 1880). Also K. Hoyer, *Zur Einführung in die Goethe-Literatur* (1904). On Goethe in England see E. Oswald, *Goethe in England and America* (1899; 2nd ed., 1900); W. Heinemann, *A Bibliographical List of the English Translations and Annotated Editions of Goethe's Faust* (1896). Reference may also be made here to F. Zarncke's *Verzeichniss der Originalaufnahmen von Goethes Bildnissen* (1888).

A Goethe-Gesellschaft was founded at Weimar in 1885, and numbers over 2800 members; its publications include the annual *Goethe-Jahrbuch* (since 1880), and a series of *Goethe-Schriften*. A Goethe-Verein has existed in Vienna since 1887, and an English Goethe society, which has also issued several volumes of publications, since 1886. (J. G. R.)

Goethe's Descendants.—Goethe's only son, AUGUST, born on the 25th of December 1789 at Weimar, married in 1817 Ottilie von Pogwisch (1796-1872), who had come as a child to Weimar with her mother (née Countess Henckel von Donnersmarck). The marriage was a very unhappy one, the husband having no qualities that could appeal to a woman who, whatever the censorious might say of her moral character, was distinguished to the last by a lively intellect and a singular charm. August von Goethe, whose sole distinction was his birth and his position as grand-ducal chamberlain, died in Italy, on the 17th of October 1830, leaving three children: WALTER WOLFGANG, born on April 9, 1818, died on April 15, 1885; WOLFGANG MAXIMILIAN, born on September 18, 1820, died on January 20, 1883; ALMA, born on October 22, 1827, died on September 29, 1844.

Of Walter von Goethe little need be said. In youth he had musical ambitions, studied under Mendelssohn and Weinlig at Leipzig, under Loewe at Stettin, and afterwards at Vienna. He published a few songs of no great merit, and had at his death no more than the reputation among his friends of a kindly and accomplished man.

Wolfgang or, as he was familiarly called, Wolf von Goethe, was by far the more gifted of the two brothers, and his gloomy destiny by so much the more tragic. A sensitive and highly imaginative boy, he was the favourite of his grandfather, who made him his constant companion. This fact, instead of being to the boy's advantage, was to prove his bane. The exalted atmosphere of the great man's ideas was too rarefied for the child's intellectual health, and a brain well fitted to do excellent work in the world was ruined by the effort to live up to an impossible ideal. To maintain himself on the same height as his grandfather, and to make the name of Goethe illustrious in his descendants also, became Wolfgang's ambition, and his incapacity to realise this, very soon borne in upon him, paralyzed

his efforts and plunged him at last into bitter revolt against his fate and gloomy isolation from a world that seemed to have no use for him but as a curiosity. From the first, too, he was hampered by wretched health; at the age of sixteen he was subjected to one of those terrible attacks of neuralgia which were to torment him to the last; physically and mentally alike he stood in tragic contrast with his grandfather, in whose gigantic personality the vigour of his race seems to have been exhausted.

From 1839 to 1845 Wolfgang studied law at Bonn, Jena, Heidelberg and Berlin, taking his degree of *doctor juris* at Heidelberg in 1845. During this period he had made his first literary efforts. His *Studenten-Briefe* (Jena, 1842), a medley of letters and lyrics, are wholly conventional. This was followed by *Der Mensch und die elementarische Natur* (Stuttgart and Tübingen, 1845), in three parts (*Beiträge*): (1) an historical and philosophical dissertation on the relations of mankind and the "soul of nature," largely influenced by Schelling, (2) a dissertation on the juridical side of the question, *De fragmento Vegeto*, being the thesis presented for his degree, (3) a lyrical drama, *Erkünde*. In this last, as in his other poetic attempts, Wolfgang showed a considerable measure of inherited or acquired ability, in his wealth of language and his easy mastery of the difficulties of rhythm and rhyme. But this was all. The work was characteristic of his self-centred isolation: ultra-romantic at a time when Romanticism was already an outworn fashion, remote alike from the spirit of the age and from that of Goethe. The cold reception it met with shattered at a blow the dream of Wolfgang's life; henceforth he realized that to the world he was interesting mainly as "Goethe's grandson," that anything he might achieve would be measured by that terrible standard, and he hated the legacy of his name.

The next five years he spent in Italy and at Vienna, tormented by facial neuralgia. Returning to Weimar in 1850, he was made a chamberlain by the grand-duke, and in 1852, his health being now somewhat restored, he entered the Prussian diplomatic service and went as attaché to Rome. The fruit of his long years of illness was a slender volume of lyrics, *Gedichte* (Stuttgart and Tübingen, 1852), good in form, but seldom inspired, and showing occasionally the influence of a morbid sensuality. In 1854 he was appointed secretary of legation; but the aggressive ultraromanticism of the Curia became increasingly intolerable to his overwrought nature, and in 1856 he was transferred, at his own request, as secretary of legation to Dresden. This post he resigned in 1859, in which year he was raised to the rank of *Freiherr* (baron). In 1866 he received the title of councillor of legation; but he never again occupied any diplomatic post.

The rest of his life he devoted to historical research, ultimately selecting as his special subject the Italian libraries up to the year 1500. The outcome of all his labours was, however, only the first part of *Studies and Researches in the Times and Life of Cardinal Bessarion*, embracing the period of the council of Florence (privately printed at Jena, 1871), a catalogue of the MSS. in the monastery of Sancta Justina at Padua (Jena, 1873), and a mass of undigested material, which he ultimately bequeathed to the university of Jena.

In 1870 Otilie von Goethe, who had resided mainly at Vienna, returned to Weimar and took up her residence with her two sons in the Goethehaus. So long as she lived, her small salon in the attic storey of the great house was a centre of attraction for many of the most illustrious personages in Europe. But after her death in 1872 the two brothers lived in almost complete isolation. The few old friends, including the grand-duke Charles Alexander, who continued regularly to visit the house, were entertained with kindly hospitality by Baron Walther; Wolfgang refused to be drawn from his isolation even by the advent of royalty. "Tell the empress," he cried on one occasion, "that I am not a wild beast to be stared at!" In 1879, his increasing illness necessitating the constant presence of an attendant, he went to live at Leipzig, where he died.

Goethe's grandsons have been so repeatedly accused of having displayed a dog-in-the-manger temper in closing the Goethehaus

to the public and the Goethe archives to research, that the charge has almost universally come to be regarded as proven. It is true that the house was closed and access to the archives only very sparingly allowed until Baron Walther's death in 1885. But the reason for this was not, as Herr Max Hecker rather absurdly suggests, Wolfgang's jealousy of his grandfather's oppressive fame, but one far more simple and natural. From one cause or another, principally Otilie von Goethe's extravagance, the family was in very straitened circumstances; and the brothers, being thoroughly unbusinesslike, believed themselves to be poorer than they really were.¹ They closed the Goethehaus and the archives, because to have opened them would have needed an army of attendants.² If they deserve any blame it is for the pride, natural to their rank and their generation, which prevented them from charging an entrance fee, an expedient which would not only have made it possible for them to give access to the house and collections, but would have enabled them to save the fabric from falling into the lamentable state of disrepair in which it was found after their death. In any case, the accusation is ungenerous. With an almost exaggerated *Pietät* Goethe's descendants preserved his house untouched, at great inconvenience to themselves, and left it, with all its treasures intact, to the nation. Had they been the selfish misers they are sometimes painted, they could have realized a fortune by selling its contents.

Wolf Goethe (Weimar, 1889) is a sympathetic appreciation by Otto Mejer, formerly president of the Lutheran consistory in Hanover. See also Jenny v. Gerstenbergk, *Otilie von Goethe und ihre Söhne Walther und Wolf* (Stuttgart, 1901), and the article on Maximilian Wolfgang von Goethe by Max F. Hecker in *Allgem. deutsche Biographie*, Bd. 49, *Nachträge* (Leipzig, 1904). (W. A. F.)

GOETZ, HERMANN (1840-1876), German musical composer, was born at Königsberg in Prussia, on the 17th of December 1840, and began his regular musical studies at the comparatively advanced age of seventeen. He entered the music-school of Professor Stern at Berlin, and studied composition chiefly under Ulrich and Hans von Bülow. In 1863 he was appointed organist at Winterthur in Switzerland, where he lived in obscurity for a number of years, occupying himself with composition during his leisure hours. One of his works was an opera, *The Taming of the Shrew*, the libretto skillfully adapted from Shakespeare's play. After much delay it was produced at Mannheim (in October 1874), and its success was as instantaneous as it has up to the present proved lasting. It rapidly made the round of the great German theatres, and spread its composer's fame over all the land. But Goetz did not live to enjoy this happy result for long. In December 1876 he died at Zürich from overwork. A second opera, *Francesca da Rimini*, on which he was engaged, remained a fragment; but it was finished according to his directions, and was performed for the first time at Mannheim a few months after the composer's death on the 4th of December 1876. Besides his dramatic work, Goetz also wrote various compositions for chamber-music, of which a trio (Op. 1) and a quintet (Op. 16) have been given with great success at the London Monday Popular Concerts. Still more important is the *Symphony in F*. As a composer of comic opera Goetz lacks the sprightliness and artistic *savoir faire* so rarely found amongst Germanic nations. His was essentially a serious nature, and passion and pathos were to him more congenial than humour. The more serious sides of the subject are therefore insisted upon more successfully than Katherine's ravings and Petruccio's eccentricities. There are, however, very graceful passages, e.g. the singing lesson Bianca receives from her disguised lover. Goetz's style, although influenced by Wagner and other masters, shows signs of a distinct individuality. The design of his music is essentially of a polyphonic character, and the working out and interweaving of his themes betray the musician of high scholarship. But breadth and beautiful flow of melody also were his,

¹ After Walther's death upwards of £10,000 in bonds, &c., were discovered put away and forgotten in escritories and odd corners.

² This was the reason given by Baron Walther himself to the writer's mother, an old friend of Frau von Goethe, who lived with her family in the Goethehaus for some years after 1871.

as is seen in the symphony, and perhaps still more in the quintet for pianoforte and strings above referred to. The most important of Goetz's posthumous works are a setting of the 137th Psalm for soprano solo, chorus and orchestra, a "Spring" overture (Op. 15), and a pianoforte sonata for four hands (Op. 17).

GOFFE (or **GOUGE**), **WILLIAM** (fl. 1642-1660), English parliamentarian, son of Stephen Goffe, puritan rector of Stanmer in Essex, began life as an apprentice to a London salter, a zealous parliamentarian, but on the outbreak of the civil war he joined the army and became captain in Colonel Harley's regiment of the new model in 1645. He was imprisoned in 1642 for his share in the petition to give the control of the militia to the parliament. By his marriage with Frances, daughter of General Edward Whalley, he became connected with Oliver Cromwell's family and one of his most faithful followers. He was a member of the deputation which on the 6th of July 1647 brought up the charge against the eleven members. He was active in bringing the king to trial and signed the death warrant. In 1649 he received the honorary degree of M.A. at Oxford. He distinguished himself at Dunbar, commanding a regiment there and at Worcester. He assisted in the expulsion of Barebone's parliament in 1653, took an active part in the suppression of Penruddock's rising in July 1654, and in October 1655 was appointed major-general for Berkshire, Sussex and Hampshire. Meanwhile he had been elected member for Yarmouth in the parliament of 1654 and for Hampshire in that of 1656. He supported the proposal to bestow a royal title upon Cromwell, who greatly esteemed him, was included in the newly-constituted House of Lords, obtained Lambert's place as major-general of the Foot, and was even thought of as a fit successor to Cromwell. As a member of the committee of nine appointed in June 1658 on public affairs, he was witness to the protector's appointment of Richard Cromwell as his successor. He supported the latter during his brief tenure of power and his fall involved his own loss of influence. In November 1659 he took part in the futile mission sent by the army to Monk in Scotland, and at the Restoration escaped with his father-in-law General Edward Whalley to Massachusetts. Goffe's political aims appear not to have gone much beyond fighting "to pull down Charles and set up Oliver"; and he was no doubt a man of deep religious feeling, who acted throughout according to a strict sense of duty as he conceived it. He was destined to pass the rest of his life in exile, separated from his wife and children, dying, it is supposed, about 1670.

GOFFER, to give a fluted or crimped appearance to anything, particularly to linen or lace frills or trimmings by means of heated irons of a special shape, called goffering-irons or tongs. "Goffering," or the French term *gaufrage*, is also used of the wavy or crimped edging in certain forms of porcelain, and also of the stamped or embossed decorations on the edges of the binding of books. The French word *gaufrage*, from which the English form is adapted, means a thin cake marked with a pattern like a honeycomb, a "wafer," which is etymologically the same word. *Waufré* appears in the phrase *un fer a waufrés*, an iron for baking cakes on (quotation of 1433 in J. B. Roquefort's *Glossaire de la langue romane*). The word is Teutonic, cf. Dutch *wafel*, Ger. *Waffel*, a form seen in "waffle," the name given to the well-known batter-cakes of America. The "wafer" was so called from its likeness to a honeycomb, *Wabe*, ultimately derived from the root *wab-*, to weave, the cells of the comb appearing to be woven together.

GOG (possibly connected with the Gentilic *Gagaya*, "of the land of Gag," used in Amarna Letters i. 38, as a synonym for "barbarian," or with Ass. *Gagu*, a ruler of the land of *Sahi*, N. of Assyria, or with *Cyges*, Ass. *Gugu*, a king of Lydia), a Hebrew name found in Ezek. xxxviii.-xxxix. and in Rev. xx., and denoting an antitheocratic power that is to manifest itself in the world immediately before the final dispensation. In the later passage, Gog and Magog are spoken of as co-ordinate; in the earlier, Gog is given as the name of the person or people and Magog as that of the land of origin. Magog is perhaps a contracted form of *Mat-gog*, *mat* being the common Assyrian word for "land." The passages are, however, intimately related

and both depend upon Gen. x. 2, though here Magog alone is mentioned. He is the second "son" of Japhet, and the order of the names here and in Ezekiel xxxviii. 2, indicates a locality between Cappadocia and Media, i.e. in Armenia. According to Josephus, who is followed by Jerome, the Scythians were primarily intended by this designation; and this plausible opinion has been generally followed. The name *Σαυθα*, it is to be observed, however, is often but a vague word for any or all of the numerous and but partially known tribes of the north; and any attempt to assign a more definite locality to Magog can only be very hesitatingly made. According to some, the Maiotes about the Palus Maeotis are meant; according to others, the Massagetae; according to Kiepert, the inhabitants of the northern and eastern parts of Armenia. The imagery employed in Ezekiel's prophetic description was no doubt suggested by the Scythian invasion which about the time of Josiah, 630 a.c., had devastated Asia (Herodotus i. 104-106; Jer. iv. 3-vi. 30). Following on this description, Gog figures largely in Jewish and Mahomedan as well as in Christian eschatology. In the district of Astrakhan a legend is still to be met with, to the effect that Gog and Magog were two great races, which Alexander the Great subdued and banished to the almost recesses of the Caucasus, where they are meanwhile kept in by the terror of twelve trumpets blown by the winds, but whence they are destined ultimately to make their escape and destroy the world.

The legends that attach themselves to the gigantic effigies (dating from 1708 and replacing those destroyed in the Great Fire) of Gog and Magog in Guildhall, London, are connected only remotely, if at all, with the biblical notices. According to the *Recueil des histoires de Troie*, Gog and Magog were the survivors of a race of giants descended from the thirty-three wicked daughters of Diocletian; after their brethren had been slain by Brute and his companions, Gog and Magog were brought to London (Troy-novant) and compelled to officiate as porters at the gate of the royal palace. It is known that effigies similar to the present existed in London as early as the time of Henry V.; but when this legend began to attach to them is uncertain. They may be compared with the giant images formerly kept at Antwerp (Antigomes) and Douai (Gayant). According to Geoffrey of Monmouth (*Chronicles*, i. 16), *Goemot* or *Goemagot* (either corrupted from or corrupted into "Gog and Magog") was a giant who, along with his brother *Corineus*, tyrannized in the western horn of England until slain by foreign invaders.

GOGO, or **GOGHA**, a town of British India in Ahmedabad district, Bombay, 103 m. N.W. of Bombay. Pop. (1901) 4798. About $\frac{1}{2}$ m. east of the town is an excellent anchorage, in some measure sheltered by the island of Pizam, which lies still farther east. The natives of this place are reckoned the best sailors in India; and ships touching here may procure water and supplies, or repair damages. The anchorage is a safe refuge during the south-west monsoon, the bottom being a bed of mud and the water always smooth. Gogo has lost its commercial importance and has steadily declined in population and trade since the time of the American Civil War, when it was an important cotton-mart.

GOGOL, **NIKOLAI VASILIEVICH** (1809-1852), Russian novelist, was born in the province of Poltava, in South Russia, on the 31st of March 1809. Educated at the Niezhin gymnasium, he there started a manuscript periodical, "The Star," and wrote several pieces including a tragedy, *The Brigands*. Having completed his course at Niezhin, he went in 1829 to St Petersburg, where he tried the stage but failed. Next year he obtained a clerkship in the department of appanages, but he soon gave it up. In literature, however, he found his true vocation. In 1829 he published anonymously a poem called *Italy*, and, under the pseudonym of V. Alov, an idyll, *Hans Kuchel Garten*, which he had written while still at Niezhin. The idyll was so ridiculed by a reviewer that its author bought up all the copies he could secure, and burnt them in a room which he hired for the purpose at an inn. Gogol then fell back upon South Russian popular literature, and especially the tales of Cossackdom on which his boyish fancy had been nursed, his father having occupied the

post of "regimental secretary," one of the honorary officials in the Zaporogian Cossack forces.

In 1830 he published in a periodical the first of the stories which appeared next year under the title of *Evenings in a Farm near Dikanka* by *Rudiy Panko*. This work, containing a series of attractive pictures of that Little-Russian life which lends itself to romance more readily than does the monotony of "Great-Russian" existence, immediately obtained a great success—its light and colour, its freshness and originality being hailed with enthusiasm by the principal writers of the day in Russia. Whereupon Gogol planned, not only a history of Little-Russia, but also one of the middle ages, to be completed in eight or nine volumes. This plan he did not carry out, though it led to his being appointed to a professorship in the university of St Petersburg, a post in which he met with small success and which he resigned in 1835. Meanwhile he had published his *Arabesques*, a collection of essays and stories; his *Taras Bulba*, the chief of the *Cossack Tales* translated into English by George Tolstoy; and a number of novelettes, which mark his transition from the romantic to the realistic school of fiction, such as the admirable sketch of the tranquil life led in a quiet country house by two kindly specimens of *Old-world Gentry*, or the description of the petty miseries endured by an ill-paid clerk in a government office, the great object of whose life is to secure the "cloak" from which his story takes its name. To the same period belongs his celebrated comedy, the *Revisor*, or government inspector. His aim in writing it was to drag into light "all that was bad in Russia," and to hold it up to contempt. And he succeeded in rendering contemptible and ludicrous the official life of Russia, the corruption universally prevailing throughout the civil service, the alternate arrogance and servility of men in office. The plot of the comedy is very simple. A traveller who arrives with an empty purse at a provincial town is taken for an inspector whose arrival is awaited with fear, and he receives all the attentions and bribes which are meant to propitiate the dreaded investigator of abuses. The play appeared on the stage in the spring of 1836, and achieved a full success, in spite of the opposition attempted by the official classes whose malpractices it exposed. The aim which Gogol had in view when writing the *Revisor* he afterwards fully attained in his great novel, *Merziya Dushi*, or *Dead Souls*, the first part of which appeared in 1842. The hero of the story is an adventurer who goes about Russia making fictitious purchases of "dead souls," i.e. of serfs who have died since the last census, with the view of pledging his imaginary property to the government. But his adventures are merely an excuse for drawing a series of pictures, of an unfavourable kind, of Russian provincial life, and of introducing on the scene a number of types of Russian society. Of the force and truth with which these delineations are executed the universal consent of Russian critics in their favour may be taken as a measure. From the French version of the story a general idea of its merits may be formed, and some knowledge of its plot and its principal characters may be gathered from the English adaptation published in 1854, as an original work, under the title of *Home Life in Russia*. But no one can fully appreciate Gogol's merits as a humorist who is not intimate with the language in which he wrote as well as with the society which he depicted.

In 1836 Gogol for the first time went abroad. Subsequently he spent a considerable amount of time out of Russia, chiefly in Italy, where much of his *Dead Souls* was written. His residence there, especially at Rome, made a deep impression on his mind, which, during his later years, turned towards mysticism. The last works which he published, his *Confession* and *Correspondence with Friends*, offer a painful contrast to the light, bright, vigorous, realistic, humorous writings which had gained and have retained for him his immense popularity in his native land. Asceticism and mystical exaltation had told upon his nervous system, and its feeble condition showed itself in his literary compositions. In 1848 he made a pilgrimage to Jerusalem, and on his return settled down at Moscow, where he died on the 3rd of March 1852.

See *Materials for the Biography of Gogol* (in Russian) (1897), by Shenrok; "Illness and Death of Gogol," by N. Bazhenov, *Russkaya Muza*, January 1902. (W. R. S.-R.)

GOGRA, or **GHAGRA**, a river of northern India. It is an important tributary of the Ganges, bringing down to the plains more water than the Ganges itself. It rises in Tibet near Lake Manasarowar, not far from the sources of the Brahmaputra and the Sutlej, passes through Nepal where it is known as the Kauriala, and after entering British territory becomes the most important waterway in the United Provinces. It joins the Ganges at Chupra after a course of 600 m. Its tributary, the Rapti, also has considerable commercial importance. The Gogra has the alternative name of Sarju, and in its lower course is also known as the Deoha.

GOHIER, LOUIS JÉRÔME (1746–1830), French politician, was born at Semblançay (Indre-et-Loire) on the 27th of February 1746, the son of a notary. He was called to the bar at Rennes, and practised there until he was sent to represent the town in the states-general. In the Legislative Assembly he represented Ille-et-Vilaine. He took a prominent part in the deliberations; he protested against the exaction of a new oath from priests (Nov. 22, 1791), and demanded the sequestration of the emigrants' property (Feb. 7, 1792). He was minister of justice from March 1793 to April 1794, and in June 1799 he succeeded Treilhard in the Directory, where he represented the republican interest. His wife was intimate with Josephine Bonaparte, and when Bonaparte suddenly returned from Egypt in October 1799 he repeatedly protested his friendship for Gohier, who was then president of the Directory, and tried in vain to gain him over. After the *coup d'état* of the 18th Brumaire (Nov. 9, 1799), he refused to abdicate his functions, and sought out Bonaparte at the Tuileries "to save the republic," as he boldly expressed it. He was escorted to the Luxembourg, and on his release he retired to his estate at Eaubonne. In 1803 Napoleon made him consul-general at Amsterdam, and on the union of the Netherlands with France he was offered a similar post in the United States. His health did not permit of his taking up a new appointment, and he died at Eaubonne on the 29th of May 1830.

His *Mémoires d'un vétéran irréprochable de la Révolution* was published in 1824, his report on the papers of the civil list preparatory to the trial of Louis XVI. is printed in *Le Procès de Louis XVI* (Paris, an III) and elsewhere, while others appear in the *Moniteur*.

GÖHRDE, a forest of Germany, in the Prussian province of Hanover, immediately W. of the Elbe, between Wittenberg and Lüneburg. It has an area of about 85 sq. m. and is famous for its oaks, beeches and game preserves. It is memorable for the victory gained here, on the 16th of September 1813, by the allies, under Wallmoden, over the French forces commanded by Pecheur. The hunting-box situated in the forest was built in 1689 and was restored by Ernest Augustus, King of Hanover. It is known to history on account of the constitution of Gôhrde, promulgated here in 1719.

GOITO, a village of Lombardy, Italy, in the province of Mantua, from which it is 11 m. N.W., on the road to Brescia. Pop. (village) 737; (commune) 5712. It is situated on the right bank of the Mincio near the bridge. Its position has given it a certain military importance in various campaigns and it has been repeatedly fortified as a bridge-head. The Piedmontese forces won two actions (8th of April and 30th of May 1848) over the Austrians here.

GOITRE (from Lat. *guttur*, the throat; synonyms, Bronchocele, Derbyshire Neck), a term applied to a swelling in the front of the neck caused by enlargement of the thyroid gland. This structure, which lies between the skin and the anterior surface of the windpipe, and in health is not large enough to give rise to any external prominence (except in the pictures of certain artists), is liable to variations in size, more especially in females, a temporary enlargement of the gland being not uncommon at the catamenial periods, as well as during pregnancy. In goitre the swelling is conspicuous and is not only unsightly but may occasion much discomfort from its pressure upon the windpipe and other important parts of the neck. J. L. Alibert recorded cases of

goitre where the tumour hung down over the breast, or reached as low as the middle of the thigh.

Goitre usually appears in early life, often from the eighth to the twelfth year; its growth is at first slow, but after several years of comparative quiescence a sudden increase is apt to occur. In the earlier stages the condition of the gland is simply an enlargement of its constituent parts, which retain their normal soft consistence; but in the course of time other changes supervene, and it may become cystic, or acquire hardness from increase of fibrous tissue or from calcareous deposits. Occasionally the enlargement is uniform, but more commonly one of the lobes, generally the right, is the larger. In rare instances the disease is limited to the isthmus which connects the two lobes of the gland. The growth is unattended with pain, and is not inconsistent with good health.

Goitre is a marked example of an endemic disease. There are few parts of the world where it is not found prevailing in certain localities, these being for the most part valleys and elevated plains in mountainous districts (see *CRETINISM*). The malady is generally ascribed to the use of drinking water impregnated with the salts of lime and magnesia, in which ingredients the water of goitrous districts abounds. But in localities not far removed from those in which goitre prevails, and where the water is of the same chemical composition, the disease may be entirely unknown. The disease may be the result of a combination of causes, among which local telluric or malarial influences concur with those of the drinking water. Goitre is sometimes cured by removal of the individual from the district where it prevails, and it is apt to be acquired by previously healthy persons who settle in goitrous localities; and it is only in such places that the disease exhibits hereditary tendencies.

In the early stages, change of air, especially to the seaside, is desirable, and small doses of iron and of iodine should be given; if this fails small doses of thyroid extract should be tried. If palliative measures prove unsuccessful, operation must be undertaken for the removal of one lateral lobe and the isthmus of the tumour. This may be done under chloroform or after the subcutaneous injection of cocaine. If chloroform is used, it must be given very sparingly, as the breathing is apt to become seriously embarrassed during the operation. After the successful performance of the operation great improvement takes place, the remaining part of the gland slowly decreasing in size. The whole of the gland must not be removed during the operation, lest the strange disease known as *Myxoedema* should be produced (see *METABOLIC DISEASES*).

In *exophthalmic goitre* the bronchocele is but one of three phenomena, which together constitute the disease, viz. palpitation of the heart, enlargement of the thyroid gland, and protrusion of the eyeballs. This group of symptoms is known by the name of "Graves's disease" or "Von Basedow's disease"—the physicians by whom the malady was originally described. Although occasionally observed in men, this affection occurs chiefly in females, and in comparatively early life. It is generally preceded by impoverishment of blood; and by nervous or hysterical disorders, and it is occasionally seen in cases of organic heart disease. It has been suddenly developed as the effect of fright or of violent emotion. The first symptom is usually the palpitation of the heart, which is aggravated by slight exertion, and may be so severe as not only to shake the whole frame but even to be audible at some distance. A throbbing is felt throughout the body, and many of the larger blood-vessels are, like the heart, seen to pulsate strongly. The enlargement of the thyroid is gradual, and rarely increases to any great size, thus differing from the commoner form of goitre. The enlarged gland is of soft consistence, and communicates a thrill to the touch from its dilated and pulsating blood-vessels. Accompanying the goitre a remarkable change is observed in the eyes, which attract attention by their prominence, and by the startled expression thus given to the countenance. In extreme cases the eyes protrude from their sockets to such a degree that the eyelids cannot be closed, and injury may thus arise to the constantly exposed eyeballs. Apart from such risk, however, the vision is rarely affected. It occasionally happens that in undoubted cases of the disease one or other of

the three above-named phenomena is absent, generally either the goitre or the exophthalmos. The palpitation of the heart is the most constant symptom. Sleeplessness, irritability, disorders of digestion, diarrhoea and uterine derangements, are frequent accompaniments. It is a serious disease and, if unchecked, may end fatally. Some cases are improved by general hygienic measures, others by electric treatment, or by the administration of animal extracts or of sera. Some cases, on the other hand, may be considered suitable for operative treatment. (E. O.)

GOKAK, a town of British India, in the Belgaum district of Bombay, 8 m. from a station on the Southern Mahratta railway. Pop. (1901) 9860. It contains old temples with inscriptions, and is known for a special industry of modelled toys. About 4 m. N.W. are the Gokak Falls, where the Ghatprabha throws itself over a precipice 170 ft. high. Close by, the water has been impounded for a large reservoir, which supplies not only irrigation but also motive power for a cotton-mill employing 2000 hands.

GOKCHA, (GÖK-ÇEAI; Armenian *Sevaga*; ancient *Haaravagha*), the largest lake of Russian Transcaucasia, in the government of Erivan, in 40° 9' to 40° 38' N. and 45° 1' to 45° 40' E. Its altitude is 6345 ft., it is of triangular shape, and measures from north-west to south-east 45 m., its greatest width being 25 m., and its maximum depth 67 fathoms. Its area is 540 sq. m. It is surrounded by barren mountains of volcanic origin, 12,000 ft. high. Its outflow is the Zanga, a left bank tributary of the Aras (*Araxes*); it never freezes, and its level undergoes periodical oscillations. It contains four species of *Salmonidae*, and two of *Cyprinidae*, which are only met with in the drainage area of this lake. A lava island in the middle is crowned by an Armenian monastery.

GOLCONDA, a fortress and ruined city of India, in the Nizâm's Dominions, 5 m. W. of Hyderabad city. In former times Golconda was the capital of a large and powerful kingdom of the Deccan, ruled by the Kutb Shahi dynasty which was founded in 1512 by a Turkoman adventurer on the downfall of the Bahmani dynasty, but the city was subdued by Aurangzeb in 1687, and annexed to the Delhi empire. The fortress of Golconda, situated on a rocky ridge of granite, is extensive, and contains many enclosures. It is strong and in good repair, but is commanded by the summits of the enormous and massive mausolea of the ancient kings about 600 yds. distant. These buildings, which are now the chief characteristics of the place, form a vast group, situated in an arid, rocky desert. They have suffered considerably from the ravages of time, but more from the hand of man, and nothing but the great solidity of their walls has preserved them from utter ruin. These tombs were erected at a great expense, some of them being said to have cost as much as £150,000. Golconda fort is now used as the Nizâm's treasury, and also as the state prison. Golconda has given its name in English literature to the diamonds which were found in other parts of the dominions of the Kutb Shahi dynasty, not near Golconda itself.

GOLD [symbol Au, atomic weight 195.7 (H = 1), 197.2 (O = 16)], a metallic chemical element, valued from the earliest ages on account of the permanency of its colour and lustre. Gold ornaments of great variety and elaborate workmanship have been discovered on sites belonging to the earliest known civilizations, Minoen, Egyptian, Assyrian, Etruscan (see *JEWELRY, PLATE, EGYPT, CRETE, ARABIAN CIVILIZATION, NUMISMATICS*), and in ancient literature gold is the universal symbol of the highest purity and value (cf. passages in the Old Testament, e.g. Ps. xix. 10 "More to be desired are they than gold, yea, than much fine gold"). With regard to the history of the metallurgy of gold, it may be mentioned that, according to Pliny, mercury was employed in his time both as a means of separating the precious metals and for the purposes of gilding. Vitruvius also gives a detailed account of the means of recovering gold, by amalgamation, from cloth into which it had been woven.

Physical Properties.—Gold has a characteristic yellow colour, which is, however, notably affected by small quantities of other metals; thus the tint is sensibly lowered by small quantities of silver, and heightened by copper. When the gold is finely

divided, as in "purple of Cassius," or when it is precipitated from solutions, the colour is ruby-red, while in very thin leaves it transmits a greenish light. It is nearly as soft as lead and softer than silver. When pure, it is the most malleable of all metals (see *GOLDBEATING*). It is also extremely ductile; a single grain may be drawn into a wire 500 ft. in length, and an ounce of gold covering a silver wire is capable of being extended more than 1300 m. The presence of minute quantities of cadmium, lead, bismuth, antimony, arsenic, tin, tellurium and zinc renders gold brittle, $\frac{1}{1000}$ th part of one of the three metals first named being sufficient to produce that quality. Gold can be readily welded cold; the finely divided metal, in the state in which it is precipitated from solution, may be compressed between dies into disks or medals. The specific gravity of gold obtained by precipitation from solution by ferrous sulphate is from 19.55 to 20.72. The specific gravity of cast gold varies from 18.29 to 19.37, and by compression between dies the specific gravity may be raised from 19.37 to 19.41; by annealing, however, the previous density is to some extent recovered, as it is then found to be 19.40. The melting-point has been variously given, the early values ranging from 1425° C. to 1035° C. Using improved methods, C. T. Heycock and F. H. Neville determined it to be 1061.7° C.; Daniel Berthelot gives 1064° C., while Jaquerod and Perrot give 1066.1-1067.4° C. At still higher temperatures it volatilizes, forming a reddish vapour. Macquer and Lavoisier showed that when gold is strongly heated, fumes arise which gild a piece of silver held in them. Its volatility has also been studied by L. Elsner, and, in the presence of other metals, by Napier and others. The volatility is barely appreciable at 1075°; at 1250° it is four times as much as at 1100°. Copper and zinc increase the volatility far more than lead, while the greatest volatility is induced, according to T. Kirke Rose, by tellurium. It has also been shown that gold volatilizes when a gold-amalgam is distilled. Gold is dissipated by sending a powerful charge of electricity through it when in the form of leaf or thin wire. The electric conductivity is given by A. Matthiessen as 73 at 0° C., pure silver being 100; the value of this coefficient depends greatly on the purity of the metal, the presence of a few thousandths of silver lowering it by 10%. Its conductivity for heat has been variously given as 103 (C. M. Despretz), 98 (F. Grace-Calvert and R. Johnson), and 60 (G. H. Wiedemann and R. Franz), pure silver being 100. Its specific heat is between 0.0298 (Dulong and Petit) and 0.03244 (Regnault). Its coefficient of expansion for each degree between 0° and 100° C. is 0.00004661, or for gold which has been annealed 0.00015136 (Laplace and Lavoisier). The spark spectrum of gold has been mapped by A. Kirchhoff, R. Thalén, Sir William Huggins and H. Krüss; the brightest lines are 6277, 5960, 5955 and 5836 in the orange and yellow, and 5230 and 4792 in the green and blue.

Chemical Properties.—Gold is permanent in both dry and moist air at ordinary or high temperatures. It is insoluble in hydrochloric, nitric and sulphuric acids, but dissolves in *aqua regia*—a mixture of hydrochloric and nitric acids—and when very finely divided in a heated mixture of strong sulphuric acid and a little nitric acid; dilution with water, however, precipitates the metal as a violet or brown powder from this solution. The metal is soluble in solutions of chlorine, bromine, thiocyanates and cyanides; and also in solutions which generate chlorine, such as mixtures of hydrochloric acid with nitric acid, chromic acid, antimonious acid, peroxides and nitrates, and of nitric acid with a chloride. Gold is also attacked when strong sulphuric acid is submitted to electrolysis with a gold positive pole. W. Skey showed that in substances which contain small quantities of gold the precious metal may be removed by the solvent action of iodine or bromine in water. Filter paper soaked with the clear solution is burnt, and the presence of gold is indicated by the purple colour of the ash. In solution minute quantities of gold may be detected by the formation of "purple of Cassius," a bluish-purple precipitate thrown down by a mixture of ferric and stannous chlorides.

The atomic weight of gold was first determined with accuracy

by Berzelius, who deduced the value 195.7 ($H=1$) from the amount of mercury necessary to precipitate it from the chloride, and 195.2 from the ratio between gold and potassium chloride in potassium aurichloride, $KAuCl_4$. Later determinations were made by Sir T. E. Thorpe and A. P. Laurie, Krüss and J. W. Mallet. Thorpe and Laurie converted potassium auribromide into a mixture of metallic gold and potassium bromide by careful heating. The relation of the gold to the potassium bromide, as well as the amounts of silver and silver bromide which are equivalent to the potassium bromide, were determined. The mean value thus adduced was 195.86. Krüss worked with the same salt, and obtained the value 195.65; while Mallet, by analyses of gold chloride and bromide, and potassium auribromide, obtained the value 195.77.

Occlusion of Gas by Gold.—T. Graham showed that gold is capable of occluding by volume 0.48% of hydrogen, 0.20% of nitrogen, 0.29% of carbon monoxide, and 0.16% of carbon dioxide. Varrentrapp pointed out that "cornets" from the assay of gold may retain gas if they are not strongly heated.

Occurrence and Distribution.—Gold is found in nature chiefly in the metallic state, *i.e.* as "native gold," and less frequently in combination with tellurium, lead and silver. These are the only certain examples of natural combinations of the metal, the minute, though economically valuable, quantity often found in pyrites and other sulphides being probably only present in mechanical suspension. The native metal crystallizes in the cubic system, the octahedron being the commonest form, but other and complex combinations have been observed. Owing to the softness of the metal, large crystals are rarely well defined, the points being commonly rounded. In the irregular crystalline aggregates branching and moss-like forms are most common, and in Transylvania thin plates or sheets with diagonal structures are found. More characteristic, however, than the crystallized are the irregular forms, which, when large, are known as "nuggets" or "pepites," and when in pieces below $\frac{1}{2}$ to $\frac{1}{4}$ oz. weight as gold dust, the larger sizes being distinguished as coarse or nuggetty gold, and the smaller as gold dust proper. Except in the larger nuggets, which may be more or less angular, or at times even masses of crystals, with or without associated quartz or other rock, gold is generally found bean-shaped or in some other flattened form, the smallest particles being scales of scarcely appreciable thickness, which, from their small bulk as compared with their surface, subside very slowly when suspended in water, and are therefore readily carried away by a rapid current. These form the "float gold" of the miner. The physical properties of native gold are generally similar to that of the melted metal.

Of the minerals containing gold the most important are sylvanite or graphic tellurium (Ag, Au)₂Te₈ with 24 to 26%; calaverite, $AuTe_2$ with 42%; nagyagite or foliate tellurium (Pb, Au)₁₀Sb₄(S, Te)₂₀ with 5 to 9% of gold; petzite, $(Ag, Au)_2Te_3$, and white tellurium. These are confined to a few localities, the oldest and best known being those of Nagyag and Offenbanya in Transylvania; they have also been found at Red Cloud, Colorado, in Calaveras county, California, and at Perth and Boulder, West Australia. The minerals of the second class, usually spoken of as "auriferous," are comparatively numerous. Prominent among these are galena and iron pyrites, the former being almost invariably gold-bearing. Iron pyrites, however, is of greater practical importance, being in some districts exceedingly rich, and, next to the native metal, is the most prolific source of gold. Magnetic pyrites, copper pyrites, zinc blende and arsenical pyrites are other and less important examples, the last constituting the gold ore formerly worked in Silesia. A native gold amalgam is found as a rarity in California, and bismuth from South America is sometimes rich in gold. Native arsenic and antimony are also very frequently found to contain gold and silver.

The association and distribution of gold may be considered under two different heads, namely, as it occurs in mineral veins—"reef gold," and in alluvial or other superficial deposits which are derived from the waste of the former—"alluvial gold." Four distinct types of reef gold deposits may be distinguished: (1) Gold may occur disseminated through metalliferous veins, generally with sulphides and more particularly with pyrites. These deposits seem to be the primary sources of native gold. (2) More common are the auriferous quartz-reefs—veins or masses of quartz containing gold in flakes visible to the naked eye, or so finely divided as to be invisible. (3) The "banket" formation, which characterizes the goldfields of South Africa, consists of a quartzite conglomerate throughout which gold is very finely disseminated. (4) The siliceous sinter at

Mount Morgan, Queensland, which is obviously associated with hydrothermal action, is also gold-bearing. The genesis of the last three types of deposit is generally assigned to the simultaneous percolation of solutions of gold and silica, the auriferous solution being formed during the disintegration of the gold-bearing metalliferous veins. But there is much uncertainty as to the mechanism of the process; some authors hold that the soluble chloride is first formed, while others postulate the intervention of a soluble aurate.

In the alluvial deposits the associated minerals are chiefly those of great density and hardness, such as platinum, osmiridium and other metals of the platinum group, tinstone, chromic, magnetic and brown iron ores, diamond, ruby and sapphire, zircon, topaz, garnet, &c. which represent the more durable original constituents of the rocks whose disintegration has furnished the detritus.

Statistics of Gold Production.—The supply of gold, and also its relation to the supply of silver, has, among civilized nations, always been of paramount importance in the economic questions concerning money (see MONEY and BIMETALLISM); in this article a summary of the modern gold-producing areas will be given, and for further details reference should be made to the articles on the localities named. The chief sources of the European supply during the middle ages were the mines of Saxony and Austria, while Spain also contributed. The supplies from Mexico and Brazil were important during the 16th and 17th centuries. Russia became prominent in 1823, and for fourteen years contributed the bulk of the supply. The United States (California) after 1848, and Australia after 1851, were responsible for enormous increases in the total production, which has been subsequently enhanced by discoveries in Canada, South Africa, India, China and other countries.

The average annual world's production for certain periods from 1801 to 1880 in ounces is given in Table I. The average

TABLE I.

Period.	Oz.	Period.	Oz.
1801-1810	590,750	1856-1860	6,350,180
1811-1820	380,300	1861-1865	5,951,770
1821-1830	472,400	1866-1870	6,169,660
1831-1840	674,200	1871-1875	5,487,400
1841-1850	1,819,600	1876-1880	5,729,300
1851-1855	6,350,180	—	—

production of the five years 1881-1885 was the smallest since the Australian and Californian mines began to be worked in 1848-1849; the minimum 4,614,588 oz., occurred in 1882. It was not until after 1885 that the annual output of the world began to expand. Of the total production in 1876, 5,016,488 oz., almost the whole was derived from the United States, Australasia and Russia. Since then the proportion furnished by these countries has been greatly lowered by the supplies from South Africa, Canada, India and China. The increase of production has not been uniform, the greater part having occurred most notably since 1895. Among the regions not previously important as gold-producers which now contribute to the annual output, the most remarkable are the goldfields of South Africa (Transvaal and Rhodesia, the former of which were discovered in 1885). India likewise has been added to the list, its active production having begun at about the same time as that of South Africa. The average annual production of India for the period 1886 to 1899 inclusive was 5698,208, and its present annual product averages about 550,000 oz., or about £2,200,000, obtained almost wholly from the free-milling quartz veins of the Colar goldfields in Mysore, southern India. In 1900 the output was valued at £1,891,804, in 1905 at £2,450,536, and in 1908 at £2,270,000. Canada, too, assumed an important rank, having contributed in 1900 £5,583,300; but the output has since steadily declined to £1,973,000 in 1908. The great increase during the few years preceding 1899 was due to the development of the goldfields of the North-Western Territory, especially British Columbia. From the district of Yukon (Klondike, &c.) £2,800,000 was obtained in 1899, wholly from alluvial workings, but the progress made since has been slower than was expected by sanguine people. It is, however, probable that the North-Western Territory will continue to yield gold in important quantities for some time to come.

The output of the United States increased from £7,050,000

in 1881 to £16,085,567 in 1900, £17,016,000 in 1905, and to £20,065,000 in 1908. This increase was chiefly due to the exploitation of new goldfields. The fall in the price of silver stimulated the discovery and development of gold deposits, and many states formerly regarded as characteristically silver districts have become important as gold producers. Colorado is a case in point, its output having increased from about £600,000 in 1880 to £6,065,000 in 1900; it was £5,139,800 in 1905. Somewhat more than one-half of the Colorado gold is obtained from the Cripple Creek district. Other states also showed a largely augmented product. On the other hand, the output of California, which was producing over £3,000,000 per annum in 1876, has fallen off, the average annual output from 1876 to 1900 being £2,800,000; in 1905 the yield was £3,830,000. This decrease was largely caused by the practical suspension for many years of the hydraulic mining operations, in preparation for which millions of dollars had been expended in deep tunnels, flumes, &c., and the active continuance of which might have been expected to yield some £2,000,000 of gold annually. This interruption, due to the practical prohibition of the industry by the United States courts, on the ground that it was injuring, through the deposit of tailings, agricultural lands and navigable streams, was lessened, though not entirely removed, by compromises and regulations which permit, under certain restrictions, the renewed exploitation of the ancient river-beds by the hydraulic method. On the other hand, the progressive reduction of mining and metallurgical costs effected by improved transportation and machinery, and the use of high explosives, compressed air, electric-power transmission, &c., resulted in California (as elsewhere) in a notable revival of deep mining. This was especially the case on the "Mother Lode," where highly promising results were obtained. Not only is vein-material formerly regarded as unremunerative now extracted at a profit, but in many instances increased gold-values have been encountered below zones of relative barrenness, and operators have been encouraged to make costly preparations for really deep mining—more than 3000 ft. below the surface. The gold product of California, therefore, may be fairly expected to maintain itself, and, indeed, to show an advance. Alaska appeared in the list of gold-producing countries in 1886, and gradually increased its annual output until 1897, when the country attracted much attention with a production valued at over £500,000; the opening up of new workings has increased this figure immensely, from about £1,400,000 in 1901 to £3,006,500 in 1905. The Alaska gold was derived almost wholly from the large low-grade quartz mines of Douglas Island prior to 1899, but in that year an important district was discovered at Cape Nome, on the north-western coast. The result of a few months' working during that year was more than £500,000 of gold, and a very much larger annual output may reasonably be anticipated in the future; in 1905 it was about £900,000. The gold occurs in alluvial deposits designated as gulch-, bar-, beach-, tundra- and bench-placers. The tundra is a coastal plain, swampy and covered with undergrowth and underlain by gravel. The most interesting and, thus far, the most productive are the beach deposits, similar to those on the coast of Northern California. These occur in a strip of comparatively fine gravel and sand, 150 yds. wide, extending along the shore. The gold is found in stratified layers, with "ruby" and black sand. The "ruby" sand consists chiefly of fine garnets and magnetites, with a few rose-quartz grains. Further exploration of the interior will probably result in the discovery of additional gold districts.

Mexico, from a gold production of £200,000 in 1891, advanced to about £1,881,800 in 1900 and to about £3,221,000 in 1905. Of this increase, a considerable part was derived from gold-quartz mining, though much was also obtained as a by-product in the working of the ores of other metals. The product of Colombia, Venezuela, the Guianas, Brazil, Uruguay, Argentina, Chile, Bolivia, Peru and Ecuador amounted in 1900 to £2,481,000 and to £2,046,000 in 1905.

In 1876 Australasia produced £7,364,000, of which Victoria contributed £3,984,000. The annual output of Victoria declined

until the year 1892, when it began to increase rapidly, but not to its former level, the values for 1900 and 1905 being £3,142,000 and £3,138,000. There has been an important increase in Queensland, which advanced from £1,696,000 in 1876 to £2,843,000 in 1900, and subsequently declined to £2,489,000 in 1905. There has been no increase, and, indeed, no large fluctuation until quite recently in the output of New Zealand, which averaged £1,054,000 per annum from 1876 to 1898, but the production of the two years 1900 and 1905 rose to £1,425,459 and £2,070,407 respectively. By far the most important addition to the Australasian product has come from West Australia, which began its production in 1887—about the time of the inception of mining at Witwatersrand ("the Rand") in South Africa—and by continuous increase, which assumed large proportions towards the close of the 19th century, was £6,426,000 in 1899, £6,179,000 in 1900, and £8,212,000 in 1905. The total Australasian production in 1908 was valued at £14,708,000.

Undoubtedly the greatest of the gold discoveries made in the latter half of the 19th century was that of the Witwatersrand district in the Transvaal. By reason of its unusual geological character and great economic importance this district deserves a more extended description. The gold occurs in conglomerate beds, locally known as "banket." There are several series of parallel beds, interstratified with quartzite and schist, the most important being the "main reef" series. The gold in this conglomerate reef is partly of detrital origin and partly of the genetic character of ordinary vein-gold. The formation is noted for its regularity as regards both the thickness and the gold-tenor of the ore-bearing reefs, in which respect it is unparalleled in the geology of the auriferous formations. The gold carries, on an average, £2 per ton, and is worked by ordinary methods of gold-mining, stamp-milling and cyaniding. In 1899, 5762 stamps were in operation, crushing 7,331,446 tons of ore, and yielding £15,134,000, equivalent to 25.5% of the world's production. Of this, 80% came from within 12 m. of Johannesburg. After September 1899 operations were suspended, almost entirely owing to the Boer War, but on the 2nd of May 1901 they were started again. In 1905 the yield was valued at £20,802,074, and in 1909 at £30,925,788. So certain is the ore-bearing formation that engineers in estimating its auriferous contents feel justified in assuming, as a factor in their calculations, a vertical extension limited only by the lowest depths at which mining is feasible. On such a basis they arrived at more than £600,000,000 as the available gold contained in the Witwatersrand conglomerates. This was a conservative estimate, and was made before the full extent of the reefs was known; in 1904 Lionel Phillips stated that the main reef series had been proved for 61 m., and he estimated the gold remaining to be mined to be worth £2,500,000,000. Deposits similar to the Witwatersrand banket occur in Zululand, and also on the Gold Coast of Africa. In Rhodesia, the country lying north of the Transvaal, where gold occurs in well-defined quartzveins, there is unquestionable evidence of extensive ancient workings. The economic importance of the region generally has been fully proved. Rhodesia produced £86,148 in 1900 and £722,656 in 1901, in spite of the South African War; the product for 1905 was valued at £1,480,449, and for 1908 at £2,526,000.

The gold production of Russia has been remarkably constant, averaging £4,899,262 per annum; the gold is derived chiefly from placer workings in Siberia.

The gold production of China was estimated for 1899 at £1,328,238 and for 1900 at £860,000; it increased in 1901 to about £1,700,000, to fall to £340,000 in 1905; in 1906 and 1907 it recovered to about £1,000,000.

TABLE II.—Gold Production of Certain Countries, 1881-1908 (in oz.)

Year.	Australasia.	Africa.	Canada.	India.	Mexico.	Russia.	United States.	Totals.
1881	1,475,161	..	52,483	..	41,543	1,181,853	1,678,612	4,976,980
1882	1,438,067	..	52,000	..	45,289	1,154,613	1,572,187	4,825,794
1883	1,333,849	..	46,150	..	46,229	1,132,219	1,451,250	4,614,588
1884	1,352,761	..	46,000	..	57,227	1,055,642	1,489,950	4,902,889
1885	1,309,804	..	53,987	..	46,941	1,225,738	1,538,325	5,002,584
1886	1,237,670	..	66,061	..	29,702	922,266	1,693,123	5,044,363
1887	1,290,202	28,754	59,884	15,403	39,861	971,656	1,996,375	5,061,490
1888	1,344,002	240,266	53,150	35,034	47,117	1,030,151	1,604,841	5,175,623
1889	1,540,607	366,023	62,658	78,649	33,862	1,154,076	1,581,000	5,611,243
1890	1,453,172	497,817	55,625	107,778	37,104	1,134,390	1,588,880	5,726,966
1891	1,518,690	728,268	43,022	131,778	48,375	1,168,764	1,604,840	6,287,591
1892	1,638,238	1,210,869	43,905	164,141	44,625	1,199,809	1,597,098	7,102,172
1893	1,711,892	1,478,477	44,853	207,152	63,144	1,345,224	1,739,323	7,772,585
1894	2,020,180	2,024,164	50,411	210,412	217,688	1,167,455	1,910,813	8,813,848
1895	2,170,595	2,277,640	52,440	257,830	290,250	1,397,767	2,254,760	9,814,505
1896	2,185,872	2,280,892	136,274	323,501	314,437	1,041,794	2,568,132	9,950,861
1897	2,547,704	2,832,776	294,582	350,585	362,812	1,124,511	2,774,935	11,420,066
1898	3,137,644	3,876,216	669,445	376,431	411,187	1,231,791	3,118,398	13,877,806
1899	3,837,181	3,532,488	1,031,563	418,869	411,187	1,072,333	3,437,210	14,827,773
1900	3,555,506	419,503	1,348,720	456,444	435,375	974,537	3,829,897	12,315,135
1901	3,719,080	439,704	1,167,216	454,527	497,527	1,105,412	3,805,500	12,698,089
1902	3,946,374	1,887,773	1,003,355	463,824	491,156	1,090,593	3,870,000	14,313,660
1903	4,315,538	3,289,409	911,118	552,873	516,524	1,191,582	3,560,000	15,852,620
1904	4,245,744	4,156,084	793,350	556,097	609,781	1,199,857	3,892,480	16,790,351
1905	4,159,220	5,477,841	700,863	576,889	779,181	1,063,883	4,265,742	18,360,945
1906	3,984,538	6,449,749	581,709	525,527	896,615	1,087,956	4,565,333	19,620,272
1907	3,659,693	7,270,464	399,844	495,965	903,672	1,282,635	4,374,827	19,988,144
1908	3,557,765	7,983,348	462,467	504,309	1,182,443	1,497,076	4,659,300	21,529,300

Alloys.—Gold forms alloys with most metals, and of these many are of great importance in the arts. The alloy with mercury—gold amalgam—is so readily formed that mercury is one of the most powerful agents for extracting the precious metal. With 10% of gold present the amalgam is fluid, and with 12.5% paste, while with 15% it consists of yellowish-white crystals. Gold readily alloys with silver and copper to form substances in use from remote times for money, jewelry and plate. Other metals which find application in the metallurgy of gold by virtue of their property of extracting the gold as an alloy are lead, which combines very readily when molten, and which can afterwards be separated by cupellation, and copper, which is separated from the gold by solution in acids or by electrolysis; molten lead also extracts gold from the copper-gold alloys. The relative amount of gold in an alloy is expressed in two ways: (1) as "fineness," i.e. the amount of gold in 1000 parts of alloy; (2) as "carats," i.e. the amount of gold in 24 parts of alloy. Thus, pure gold is 1000 "fine" or 24 carat. In England the following standards are used for plate and jewelry: 375, 500, 625, 750 and 916.6, corresponding to 9, 12, 15, 18 and 22 carats, the alloying metals being silver and copper in varying proportions. In France three alloys of the following standards are used for jewelry, 920, 840 and 750. A greenish alloy used by goldsmiths contains 70% of silver and 30% of gold. "Blue gold" is stated to contain 75% of gold and 25% of iron. The Japanese use for ornament an alloy of gold and silver, the standard of which varies from 350 to 500, the colour of the precious metal being developed by "pickling" in a mixture of plum-juice, vinegar and copper sulphate. They may be said to possess a series of bronzes, in which gold and silver replace tin and zinc, all these alloys being characterized by patina having a wonderful range of tint. The common alloy, Shi-yu-ku-Do, contains 70% of copper and 30% of gold; when exposed to air it becomes coated with a fine black patina, and is much used in Japan for sword ornaments. Gold wire may be drawn of any quality, but it is usual to add 5 to 9 dwts. of copper to the pound. The "soldiers" used for red gold contain 1 part of copper and 5 of gold; for light gold, 1 part of copper, 1 of silver and 4 of gold.

Gold and Silver.—Electrum is a natural alloy of gold and silver. Matthiessen observed that the density of alloys, the composition of which varies from AuAg₃ to AuAg₉, is greater than that calculated from the densities of the constituent metals. These alloys are harder, more fusible and more sonorous than pure gold. The alloys of the formulae AuAg, AuAg₂, AuAg₃, AuAg₄, and AuAg₅ are perfectly homogeneous, and have been studied by Levol. Molten alloys containing more than 80% of silver deposit on cooling the alloy AuAg, little gold remaining in the mother liquor.

Gold and Zinc.—When present in small quantities zinc renders gold

brittle, but it may be added to gold in larger quantities without destroying the ductility of the precious metal; Pélégot proved that a triple alloy of gold, copper and zinc, which contains 5.8% of the last-named, is perfectly ductile. The alloy of 11 parts gold and 1 part of zinc is, however, stated to be brittle.

Gold and Tin.—Alcherme showed that gold alloyed with $\frac{1}{4}$ th part of tin is sufficiently ductile to be rolled and stamped into coin, provided the metal is not annealed at a high temperature. The alloys of tin and gold are hard and brittle, and the combination of the metals is attended with contraction; thus the alloy SnAu has a density 14.243, instead of 14.828 indicated by calculation. Matthiessen and Bose obtained large crystals of the alloy Au_2Sn_3 , having the colour of tin, which changed to a bronze tint by oxidation.

Gold and Iron.—Hatchett found that the alloy of 11 parts gold and 1 part of iron is easily rolled without annealing. In these proportions the density of the alloy is less than the mean of its constituent metals.

Gold and Palladium.—These metals are stated to alloy in all proportions. According to Chenevix, the alloy composed of equal parts of the two metals is grey, is less ductile than its constituent metals and has the specific gravity 11.08. The alloy of 4 parts of gold and 1 part of palladium is white, hard and ductile. Graham showed that a wire of palladium alloyed with from 24 to 25 parts of gold does not exhibit the remarkable retraction which, in pure palladium, attends its loss of occluded hydrogen.

Gold and Platinum.—Clarke states that the alloy of equal parts of the two metals is ductile, and has almost the colour of gold.

Gold and Rhodium.—Gold alloyed with $\frac{1}{4}$ th or $\frac{1}{8}$ th of rhodium is, according to Wollaston, very ductile, infusible and of the colour of gold.

Gold and Iridium.—Small quantities of iridium do not destroy the ductility of gold, but this is probably because the metal is only disseminated through the mass, and not alloyed, as it falls to the bottom of the crucible in which the gold is fused.

Gold and Nickel.—Eleven parts of gold and 1 of nickel yield an alloy resembling brass.

Gold and Cobalt.—Eleven parts of gold and 1 of cobalt form a brittle alloy of a dull yellow colour.

Compounds.—Aurous oxide, Au_2O , is obtained by cautiously adding potash to a solution of aurous bromide, or by boiling mixed solutions of auric chloride and mercurous nitrate. It forms a dark-violet precipitate which dries to a greyish-violet powder. When freshly prepared it dissolves in cold water to form an indigo-coloured solution with a brownish fluorescence of colloidal aurous oxide; it is insoluble in hot water. This oxide is slightly basic. Auric oxide, Au_2O_3 , is a brown powder, decomposed into its elements when heated to about 250° or on exposure to light. When a concentrated solution of auric chloride is treated with caustic potash, a brown precipitate of auric hydrate, $\text{Au}(\text{OH})_3$, is obtained, which, on heating, loses water to form auryl hydrate, $\text{AuO}(\text{OH})$, and auric oxide, Au_2O_3 . It functions chiefly as an acidic oxide, being less basic than aluminium oxide, and forming no stable oxy-salts. It dissolves in alkalis to form well-defined crystalline salts; potassium aurate, $\text{KAuO}_4 \cdot 3\text{H}_2\text{O}$, is very soluble in water, and is used in electro-gilding. With concentrated ammonia auric oxide forms a black, highly explosive compound of the composition $\text{Au}_2\text{N}_2\text{H}_2 \cdot 3\text{H}_2\text{O}$, named "fulminating gold"; this substance is generally considered to be $\text{Au}(\text{NH}_2)\text{NH} \cdot 3\text{H}_2\text{O}$, but it may be an ammine of the formula $[\text{Au}(\text{NH}_2)_2(\text{OH})_2]\text{OH}$. Other oxides, e.g. Au_2O , have been described.

Aurous chloride, AuCl , is obtained as a lemon-yellow, amorphous powder, insoluble in water, by heating auric chloride to 185° . It begins to decompose into gold and chlorine at 185° , the decomposition being complete at 230° ; water decomposes it into gold and auric chloride. Auric chloride, or gold trichloride, AuCl_3 , is a dark ruby-red or reddish-brown, crystalline, deliquescent powder obtained by dissolving the metal in *aqua regia*. It is also obtained by carefully evaporating a solution of the metal in chlorine water. The gold chloride of commerce, which is used in photography, is really a hydrochloride, chlorauric or aurichloric acid, $\text{HAuCl}_4 \cdot 3\text{H}_2\text{O}$, and is obtained in long yellow needles by crystallizing the acid solution. Corresponding to this acid, a series of salts, named chloraurates or aurichlorides, are known. The potassium salt is obtained by crystallizing equivalent quantities of potassium and auric chlorides. Light-yellow monoclinic needles of $2\text{KAuCl}_4 \cdot \text{H}_2\text{O}$ are deposited from warm, strongly acid solutions, and transparent rhombic tables of $\text{KAuCl}_4 \cdot 2\text{H}_2\text{O}$ from neutral solutions. By crystallizing an aqueous solution, red crystals of $\text{AuCl}_3 \cdot 2\text{H}_2\text{O}$ are obtained. Auric chloride combines with the hydrochlorides of many organic bases—amines, alkaloids, &c.—to form characteristic compounds. Gold dichloride, probably $\text{Au}_2\text{Cl}_4 = \text{Au}_2\text{O} \cdot \text{AuCl}_3$, aurous chloraurate, is said to be obtained as a dark-red mass by heating finely divided gold to 140° – 170° in chlorine. Water decomposes it into gold and auric chloride.

The bromides and iodides resemble the chlorides. Aurous bromide, AuBr , is a yellowish-green powder obtained by heating the tribromide to 140° ; auric bromide, AuBr_3 , forms reddish-black or scarlet-red leafy crystals, which dissolve in water to form a reddish-brown solution, and combines with bromides to form bromaurates corresponding to the chloraurates. Aurous iodide, AuI , is a light-yellow, sparingly soluble powder obtained, together with free iodine, by adding potassium iodide to auric chloride; auric iodide, AuI_3 , is formed as a dark-green powder at the same time, but it readily

decomposes to aurous iodide and iodine. Aurous iodide is also obtained as a green solid by acting upon gold with iodine. The iodaurates correspond to the chlor- and bromaurates; the potassium salt, KAuI_4 , forms highly lustrous, intensely black, four-sided prisms.

Aurous cyanide, AuCN , forms yellow, microscopic, hexagonal tables, insoluble in water, and is obtained by the addition of hydrochloric acid to a solution of potassium aurocyanide, $\text{KAu}(\text{CN})_2$. This salt is prepared by precipitating a solution of gold in *aqua regia* by ammonia, and then introducing the well-washed precipitate into a boiling solution of potassium cyanide. The solution is filtered and allowed to cool, when colourless rhombic pyramids of the aurocyanide separate. It is also obtained in the action of potassium cyanide on gold in the presence of air, a reaction utilized in the MacArthur-Forrest process of gold extraction (see below). Auric cyanide, $\text{Au}(\text{CN})_2$, is not certainly known: its double salts, however, have been frequently described. Potassium auricyanide, $2\text{KAu}(\text{CN})_2 \cdot 3\text{H}_2\text{O}$, is obtained as large, colourless, efflorescent tablets by crystallizing concentrated solutions of auric chloride and potassium cyanide. The acid, auricyanic acid, $2\text{HAu}(\text{CN})_2 \cdot 3\text{H}_2\text{O}$, is obtained by treating the silver salt (obtained by precipitating the potassium salt with silver nitrate) with hydrochloric acid; it forms tabular crystals, readily soluble in water, alcohol and ether.

Gold forms three sulphides corresponding to the oxides; they readily decompose on heating. Aurous sulphide, Au_2S , is a brownish-black powder formed by passing sulphuretted hydrogen into a solution of potassium aurocyanide and then acidifying. Sodium aurosulphide, $\text{Na}_2\text{AuS}_2 \cdot 4\text{H}_2\text{O}$, is prepared by fusing gold with sodium sulphide and sulphur, the melt being extracted with water, filtered in an atmosphere of nitrogen, and evaporated in a vacuum over sulphuric acid. It forms colourless, monoclinic prisms, which turn brown on exposure to air. This method of bringing gold into solution is mentioned by Stahl in his *Observationes Chymico-Physico-Medicae*; he there remarks that Moses probably destroyed the golden calf by burning it with sulphur and alkali (Ex. xxxii. 20). Auric sulphide, Au_2S_3 , is an amorphous powder formed when lithium aurichloride is treated with dry sulphuretted hydrogen at -10° . It is very unstable, decomposing into gold and sulphur at 200° .

Oxy-salts of gold are almost unknown, but the sulphite and thio-sulphate form double salts. Thus by adding acid sodium sulphite to, or by passing sulphur dioxide at 50° into, a solution of sodium aurate, the salt, $3\text{Na}_2\text{SO}_3 \cdot \text{Au}_2\text{SO}_4 \cdot 3\text{H}_2\text{O}$ is obtained, which, when precipitated from its aqueous solution by alcohol, forms a purple powder, appearing yellow or green by reflected light. Sodium aurothiosulphate, $3\text{Na}_2\text{S}_2\text{O}_3 \cdot \text{Au}_2\text{S}_2\text{O}_8 \cdot 4\text{H}_2\text{O}$, forms colourless needles; it is obtained in the direct action of sodium thiosulphate on gold in the presence of an oxidizing agent, or by the addition of a dilute solution of auric chloride to a sodium thiosulphate solution.

Mining and Metallurgy.

The various deposits of gold may be divided into two classes—"veins" and "placers." The vein mining of gold does not greatly differ from that of similar deposits of metals (see MINERAL DEPOSITS). In the placer or alluvial deposits, the precious metal is found usually in a water-worn condition imbedded in earthy matter, and the method of working all such deposits is based on the disintegration of the earthy matter by the action of a stream of water, which washes away the lighter portions and leaves the denser gold. In alluvial deposits the richest ground is usually found in contact with the "bed rock"; and, when the overlying cover of gravel is very thick, or, as sometimes happens, when the older gravel is covered with a flow of basalt, regular mining by shafts and levels, as in what are known as tunnel-claims, may be required to reach the auriferous ground.

The extraction of gold may be effected by several methods; we may distinguish the following leading types:

1. By simple washing, *i.e.* dressing auriferous sands, gravels, &c.;
2. By amalgamation, *i.e.* forming a gold amalgam, afterwards removing the mercury by distillation;
3. By chlorination, *i.e.* forming the soluble gold chloride and then precipitating the metal;
4. By the cyanide process, *i.e.* dissolving the gold in potassium cyanide solution, and then precipitating the metal;
5. Electrolytically, generally applied to the solutions obtained in processes (3) and (4).

1. **Extraction of Gold by Washing.**—In the early days of gold-washing in California and Australia, when rich alluvial deposits were common at the surface, the most simple appliances sufficed. The most characteristic is the "pan," a circular dish of sheet-iron or "tin," with sloping sides about 13 or 14 in. in diameter. The pan, about two-thirds filled with the "pay dirt" to be washed, is held in the stream or in a hole filled with water. The larger stones having been removed by hand, gyratory motion is given to the pan by a combination of shaking and twisting movements

so as to keep its contents suspended in the stream of water, which carries away the bulk of the lighter material, leaving the heavy minerals, together with any gold which may have been present. The washing is repeated until enough of the enriched sand is collected, when the gold is finally recovered by careful washing or "panning out" in a smaller pan. In Mexico and South America, instead of the pan, a wooden dish or trough, known as "bates," is used.

The "cradle" is a simple appliance for treating somewhat larger quantities, and consists essentially of a box, mounted on rockers, and provided with a perforated bottom of sheet iron in which the "pay dirt" is placed. Water is poured on the dirt, and the rocking motion imparted to the cradle causes the finer particles to pass through the perforated bottom on to a canvas screen, and thence to the base of the cradle, where the auriferous particles accumulate on transverse bars of wood, called "riffles."

The "tom" is a sort of cradle with an extended sluice placed on an incline of about 1 in 12. The upper end contains a perforated riddle plate which is placed directly over the riffle box, and under certain circumstances mercury may be placed behind the riffles. Copper plates amalgamated with mercury are also used when the gold is very fine, and in some instances amalgamated silver coins have been used for the same purpose. Sometimes the stuff is disintegrated with water in a "puddling machine," which was used, especially in Australia, when the earthy matters are tenacious and water scarce. The machine frequently resembles a brickmaker's wash-mill, and is worked by horse or steam power.

In workings on a larger scale, where the supply of water is abundant, as in California, sluices were generally employed. They are shallow troughs about 12 ft. long, about 16 to 20 in. wide and 1 ft. in depth. The troughs taper slightly so that they can be joined in series, the total length often reaching several hundred feet. The incline of the sluice varies with the conformation of the ground and the tenacity of the stuff to be washed, from 1 in 16 to 1 in 8. A rectangular trough of boards, whose dimensions depend chiefly on the size of the planks available, is set up on the higher part of the ground at one side of the claim to be worked, upon trestles or piers of rough stone-work, at such an inclination that the stream may carry off all but the largest stones, which are kept back by a grating of boards about 2 in. apart. The gravel is dug by hand and thrown in at the upper end, the stones are kept back being removed at intervals by two men with four-pronged steel forks. The floor of the sluice is laid with riffles made of strips of wood 2 in. square laid parallel to the direction of the current, and at other points with boards having transverse notches filled with mercury. These were known originally as Hungarian riffles.

In larger plant the upper ends of the sluices are often cut in rock or lined with stone blocks, the grating stopping the larger stones being known as a "grizzly." In order to save very fine and especially rusty particles of gold, so-called "under-current sluices" are used; these are shallow wooden tanks, 50 sq. yds. and upwards in area, which are placed somewhat below the main sluice, and communicate with it above and below, the entry being protected by a grating so that only the finer material is admitted. These are paved with stone blocks or lined with mercury riffles, so that from the greatly reduced velocity of flow, due to the sudden increase of surface, the finer particles of gold may collect. In order to save finely divided gold amalgamated copper plates are sometimes placed in a nearly level position, at a considerable distance from the head of the sluice, the gold which is retained in it being removed from time to time. Sluices are often made double, and they are usually cleaned up—that is, the deposit rich in gold is removed from them—once a week.

The "pan" is now only used by prospectors, while the "cradle" and "tom" are practically confined to the Chinese; the sluice is considered to be the best contrivance for washing gold gravels.

2. *The Amalgamation Process.*—This method is employed to extract gold from both alluvial and reef deposits: in the first case it is combined with "hydraulic mining," *i.e.* disintegrating auriferous gravels by powerful jets of water, and the sluice system described above; in the second case the vein stuff is prepared by crushing and the amalgamation is carried out in mills.

Hydraulic mining has for the most part been confined to the country of its invention, California, and the western territories of America, where the conditions favourable for its use are more fully developed than elsewhere—notably the presence of thick banks of gravel that cannot be utilized by other methods, and abundance of water, even though considerable work may be required at times to make it available. The general conditions to be observed in such workings may be briefly stated as follows: (1) The whole of the auriferous gravel, down to the "bed rock," must be removed,—that is, no selection of rich or poor parts is possible; (2) this must be accomplished by the aid of water alone, or at times by water supplemented by blasting; (3) the conglomerates must be mechanically disintegrated without interrupting the whole system; (4) the gold must be saved without interrupting the continuous flow of water; and (5) arrangements must be made for disposing of the vast masses of impoverished gravel.

The water is brought from a ditch on the high ground, and through a line of pipes to the distributing box, whence the branch pipes

supplying the jets diverge. The stream issues through a nozzle, termed a "monitor" or "giant," which is fitted with a ball and socket joint, so that the direction of the jet may be varied through considerable angles by simply moving a handle. The material of the bank being loosened by blasting and the cutting action of the water, crumbles into holes, and the superincumbent mass, often with large trees and stones, falls into the lower ground. The stream, laden with stones and gravel, passes into the sluices, where the gold is recovered in the manner already described. Under the most advantageous conditions the loss of gold may be estimated at 15 or 20%, the amount recovered representing a value of about two shillings per ton of gravel treated. The loss of mercury is about the same, from 5 to 6 cwt. being in constant use per mile of sluice.

In working auriferous river-beds, dredges have been used with considerable success in certain parts of New Zealand and on the Pacific slope in America. The dredges used in California are almost exclusively of the endless-chain bucket or steam-shovel pattern. Some dredges have a capacity under favourable conditions of over 2000 cub. yds. of gravel daily. The gravel is excavated as in the ordinary form of endless-chain bucket dredge and dumped on to the deck of the dredge. It then passes through screens and grizzlies to retain the coarse gravel, the finer material passing on to sluice boxes provided with riffles, supplied with mercury. There are belt conveyers for discharging the gravel and tailings at the end of the vessel remote from the buckets. The water necessary to the process is pumped from the river; as much as 2000 gallons per minute is used on the larger dredges.

The dressing or mechanical preparation of vein stuff containing gold is generally similar to that of other ores (see ORE-DRESSING), except that the precious metal should be removed from the waste substances as quickly as possible, even although other minerals of value that are subsequently recovered may be present. In all cases the quartz or other vein stuff must be reduced to a very fine powder as a preliminary to further operations. This may be done in several ways, *e.g.* either (1) by the Mexican crusher or *arastira*, in which the grinding is effected upon a bed of stone, over which heavy blocks of stone are attached to cross arms and dragged by the rotation of the arms about a central spindle, or (2) by the Chilean mill or *trapiche*, also known as the edge-runner, where the grinding stones roll upon the floor at the same time turning about a central upright—contrivances which are mainly used for the preparation of silver ores; but by far the largest proportion of the gold quartz of California, Australia and Africa is reduced by (3) the stamp mill, which is similar in principle to that used in Europe for the preparation of tin and other ores.

The stamp mill was first used in California, and its use has since spread over the whole world. In the mills of the Californian type the stamp is a cylindrical iron pestle faced with a chilled cast iron shoe, removable so that it can be renewed when necessary, attached to a round iron rod or lifter, the whole weighing from 600 to 900 lb; stamps weighing 1320 lb are in use in the Transvaal. The lift is effected by cams acting on the under surface of tappets, and formed by cylindrical boxes keyed on to the stems of the lifter about one-fourth of their length from the top. As, however, the cams, unlike those of European stamp mills, are placed to one side of the stamp, the latter is not only lifted but turned partly round on its own axis, whereby the shoes are worn down uniformly. The height of lift may be between 4 and 18 in., and the number of blows from 30 to over 100 per minute. The stamps are usually arranged in batteries of five; the order of working is usually 1, 4, 2, 5, 3, but other arrangements, *e.g.* 1, 3, 5, 2, 4, and 1, 5, 2, 4, 3, are common. The stuff, previously broken to about 2-in. lumps in a rock-breaker, is fed in through an aperture at the back of the "battery box," a constant supply of water is admitted from above, and mercury in a finely divided state is added at frequent intervals. The discharge of the comminuted material takes place through an aperture, which is covered by a thin steel plate perforated with numerous slits about $\frac{1}{16}$ th in. broad and $\frac{1}{4}$ in. long, a certain volume being discharged at every blow and carried forward by the flushing water over an apron or table in front, covered by copper plates filled with mercury. Similar plates are often used to catch any particles of gold that may be thrown back, while the main operation is so conducted that the bulk of the gold may be reduced to the state of amalgam by bringing the two metals into intimate contact under the stamp head, and remain in the battery. The tables in front are laid at an incline of about 8° and are about 13 ft. long; they collect from 10 to 15% of the whole gold; a further quantity is recovered by leading the sands through a gutter about 16 in. broad and 120 ft. long, also lined with amalgamated copper plates, after the pyritic and other heavy minerals have been separated by depositing in catch pits and other similar contrivances.

When the ore does not contain any considerable amount of free gold mercury is not, as a rule, used during the crushing, but the amalgamation is carried out in a separate plant. Contrivances of the most diverse constructions have been employed. The most primitive is the rubbing together of the concentrated crushings with mercury in iron mortars. Barrel amalgamation, *i.e.* mixing the crushings with mercury in rotating barrels, is rarely used, the process being wasteful, since the mercury is specially apt to be "floured" (see below).

At Schemnitz, Kerpenyes, Kreuzberg and other localities in Hungary, quartz vein stuff containing a little gold, partly free and partly associated with pyrites and galena, is, after stamping in mills, similar to those described above, but without rotating stamps, passed through the so-called "Hungarian gold mill" or "quick-mill." This consists of a cast-iron pan having a shallow cylindrical bottom holding mercury, in which a wooden muller, nearly of the same shape as the inside of the pan, and armed below with several projecting blades, is made to revolve by gearing wheels. The stuff from the stamps is conveyed to the middle of the muller, and is distributed over the mercury, when the gold subsides, while the quartz and lighter materials are guided by the blades to the circumference and are discharged, usually into a second similar mill, and subsequently pass over blanket tables, *s. c.* boards covered with canvas or sackcloth, the gold and heavier particles becoming entangled in the fibres. The action of this mill is really more nearly analogous to that of a centrifugal pump, as no grinding action takes place in it. The amalgam is cleaned out periodically—fortnightly or monthly—and after filtering through linen bags to remove the excess of mercury, it is transferred to retorts for distillation (see below).

Many other forms of pan-amalgamators have been devised. The Laszlo is an improved Hungarian mill, while the Piccard is of the same type. In the Knox and Boss mills, which are also employed for the amalgamation of silver ores, the grinding is effected between flat horizontal surfaces instead of conical or curved surfaces as in the previously described forms.

One of the greatest difficulties in the treatment of gold by amalgamation, and more particularly in the treatment of pyrites, arises from the so-called "sickening" or "flouring" of the mercury; that is, the particles, losing their bright metallic surfaces, are no longer capable of coalescing with or taking up other metals. Of the numerous remedies proposed the most efficacious is perhaps sodium amalgam. It appears that amalgamation is often impeded by the tarnish found on the surface of the gold when it is associated with sulphur, arsenic, bismuth, antimony or tellurium. Henry Wurtz in America (1864) and Sir William Crookes in England (1865) made independently the discovery that, by the addition of a small quantity of sodium to the mercury, the operation is much facilitated. It is also stated that sodium prevents both the "sickening" and the "flouring" of the mercury which is produced by certain associated minerals. The addition of potassium cyanide has been suggested to assist the amalgamation and to prevent "flouring," but Skey has shown that its use is attended with loss of gold.

Separation of Gold from the Amalgam.—The amalgam is first pressed in wetted canvas or buckskin in order to remove excess of mercury. Lumps of the solid amalgam, about 2 in. in diameter, are introduced into an iron vessel provided with an iron tube that leads into a condenser containing water. The distillation is then effected by heating to dull redness. The amalgam yields about 30 to 40% of gold. Horizontal cylindrical retorts, holding from 200 to 1200 lb. of amalgam, are used in the larger Californian mills, pot retorts being used in the smaller mills. The bullion left in the retorts is then melted in black-lead crucibles, with the addition of small quantities of suitable fluxes, *e. g.* nitre, sodium carbonate, &c.

The extraction of gold from auriferous minerals by fusion, except as an incident in their treatment for other metals, is very rarely practised. It was at one time proposed to treat the concentrated black iron obtained in the Ural gold washings, which consists chiefly of magnetite, as an iron ore, by smelting it with charcoal for auriferous pig-iron, the latter metal possessing the property of dissolving gold in considerable quantity. By subsequent treatment with sulphuric acid the gold could be recovered. Experiments on this point were made by Anosov in 1835, but they have never been followed in practice.

Gold in galena or other lead ore is invariably recovered in the refining or treatment of the lead and silver obtained. Pyritic ores containing copper are treated by methods analogous to those of the copper smelter. In Colorado the pyritic ores containing gold and silver in association with copper are smelted in reverberatory furnaces for regulus, which, when desilverized by Ziervogel's method, leaves a residue containing 20 or 30 oz. of gold per ton. This is smelted with rich gold ores, notably those containing tellurium, for white metal or regulus; and by a following process of partial reduction analogous to that of selecting in copper smelting, "bottoms" of impure copper are obtained in which practically all the gold is concentrated. By continuing the treatment of these in the ordinary way of refining, poling and granulating, all the foreign matters other than gold, copper and silver are removed, and, by exposing the granulated metal to a high oxidizing heat for a considerable time the copper may be completely oxidized while the precious metals are unaltered. Subsequent treatment with sulphuric acid renders the copper soluble in water as sulphate, and the final residue contains only gold and silver, which is parted or refined in the ordinary way. This method of separating gold from copper, by converting the latter into oxide and sulphate, is also used at Oker in the Harz.

Extraction by Means of Aqueous Solutions.—Many processes have been suggested in which the gold of auriferous deposits is converted into products soluble in water, from which solutions the gold may be precipitated. Of these processes, two only are

of special importance, *viz.* the chlorination of Plattner process, in which the metal is converted into the chloride, and the cyanide or MacArthur-Forrest process, in which it is converted into potassium aurocyanide.

(3) **Chlorination or Plattner Process.**—In this process moistened gold ores are treated with chlorine gas, the resulting gold chloride dissolved out with water, and the gold precipitated with ferrous sulphate, charcoal, sulphuretted hydrogen or otherwise. The process originated in 1848 with C. F. Plattner, who suggested that the residues from certain mines at Reichenstein, in Silesia, should be treated with chlorine after the arsenical products had been extracted by roasting. It must be noticed, however, that Percy independently made the same discovery, and stated his results at the meeting of the British Association (at Swansea) in 1849, but the Report was not published until 1852. The process was introduced in 1858 by Deetken at Grass Valley, California, where the waste minerals, principally pyrites from tailings, had been worked for a considerable time by amalgamation. The process is rarely applied to ores direct; free-milling ores are generally amalgamated, and the tailings and slimes, after concentration, operated upon. Three stages in the process are to be distinguished: (i.) calcination, to convert all the metals, except gold and silver, into oxides, which are unacted upon by chlorine; (ii.) chlorinating the gold and lixiviating the product; (iii.) precipitating the gold.

The calcination, or roasting, is conducted at a low temperature in some form of reverberatory furnace. Salt is added in the roasting to convert any lime, magnesia or lead which may be present, into the corresponding chlorides. The auric chloride is, however, decomposed at the elevated temperature into finely divided metallic gold, which is then readily attacked by the chlorine gas. The high volatility of gold in the presence of certain metals must also be considered. According to Egleston the loss may be from 40 to 90% of the total gold present in cupiferous ores according to the temperature and duration of calcination. The roasted mineral, slightly moistened, is introduced into a vat made of stoneware or pitched planks, and furnished with a double bottom. Chlorine, generally prepared by the interaction of pyrolusite, salt and sulphuric acid, is led from a suitable generator beneath the false bottom, and rises through the moistened ore, which rests on a bed of broken quartz; the gold is thus converted into a soluble chloride, which is afterwards removed by washing with water. Both fixed and rotating vats are employed, the chlorination proceeding more rapidly in the latter case; rotating barrels are sometimes used. There have also been introduced processes in which the chlorine is generated in the chloridizing vat, the reagents used being dilute solutions of bleaching powder and an acid. Munkell's process is of this type. In the Thies process, used in many districts in the United States, the vats are rotating barrels made, in the later forms, of iron lined with lead, and provided with a filter formed of a finely perforated leaden grating running from one end of the barrel to the other, and rigidly held in place by wooden frames. Chlorine is generated within the barrel from sulphuric acid and chloride of lime. After charging, the barrel is rotated, and when the chlorination is complete the contents are emptied on a filter of quartz or some similar material, and the filtrate led to settling tanks.

After settling the solution is run into the precipitating tanks. The precipitants in use are: ferrous sulphate, charcoal and sulphuretted hydrogen, either alone or mixed with sulphur dioxide; the use of copper and iron sulphides has been suggested, but apparently these substances have achieved no success.

In the case of ferrous sulphate, prepared by dissolving iron in dilute sulphuric acid, the reaction follows the equation $AuCl_3 + 3FeSO_4 = FeCl_2 + Fe_2(SO_4)_3 + Au$. At the same time any lead, calcium, barium and strontium present are precipitated as sulphates; it is therefore advantageous to remove these metals by the preliminary addition of sulphuric acid, which also serves to keep any basic iron salts in solution. The precipitation is carried out in tanks or vats made with wooden sides and a cement bottom. The solutions are well mixed by stirring with wooden poles, and the gold allowed to settle, the time allowed varying from 12 to 72 hours. The supernatant liquid is led into settling tanks, where a further amount of gold is deposited, and is then filtered through sawdust or sand, the sawdust being afterwards burnt and the gold separated from the ashes and the sand treated in the chloridizing vat. The precipitated gold is washed, treated with salt and sulphuric acid to remove iron salts, roughly dried by pressing in cloths or on filter paper, and then melted with salt, borax and nitre in graphite crucibles. Thus prepared it has a fineness of 800-960, the chief impurities usually being iron and lead.

Charcoal is used as the precipitant at Mount Morgan, Australia. Its use was proposed as early as 1818 and 1819 by Hare and Henry; Percy advocated it in 1860, and Davis adopted it on the large scale at a works in Carolina in 1880. The action is not properly understood; it may be due to the reducing gases (hydrogen, hydrocarbons, &c.) which are invariably present in wood charcoal. The process consists essentially in running the solution over layers of charcoal, the charcoal being afterwards burned. It has been found that the reaction proceeds faster when the solution is heated.

Precipitation with sulphur dioxide and sulphuretted hydrogen proceeds much more rapidly, and has been adopted at many works. Sulphur dioxide, generated by burning sulphur, is forced into the solution under pressure, where it interacts with any free chlorine present to form hydrochloric and sulphuric acids. Sulphuretted hydrogen, obtained by treating iron sulphide or a coarse matte with dilute sulphuric acid, is forced in similarly. The gold is precipitated as the sulphide, together with any arsenic, antimony, copper, silver and lead which may be present. The precipitate is collected in a filter-press, and then roasted in muffle furnaces with nitre, borax and sodium carbonate. The fineness of the gold so obtained is 900 to 950.

4. Cyanide Process.—This process depends upon the solubility of gold in a dilute solution of potassium cyanide in the presence of air (or some other oxidizing agent), and the subsequent precipitation of the gold by metallic zinc or by electrolysis. The solubility of gold in cyanide solutions was known to K. W. Scheele in 1782; and M. Faraday applied it to the preparation of extremely thin films of the metal. L. Eläner recognized, in 1846, the part played by the atmosphere, and in 1879 Dixon showed that bleaching powder, manganese dioxide, and other oxidizing agents, facilitated the solution. S. B. Christy (*Transvaal A. J. M. E.*, 1896, vol. 26) has shown that the solution is hastened by many oxidizing agents, especially sodium and manganese dioxides and potassium ferricyanide. According to G. Bodländer (*Zeit. f. angew. Chem.*, 1896, vol. 19) the rate of solution in potassium cyanide depends upon the subdivision of the gold—the finer the subdivision the quicker the solution,—and on the concentration of the solution—the rate increasing until the solution contains 0.25% of cyanide, and remaining fairly stationary with increasing concentration. The action proceeds in two stages; in the first hydrogen peroxide and potassium aurocyanide are formed, and in the second the hydrogen peroxide oxidizes a further quantity of gold and potassium cyanide to aurocyanide, thus (1) $2Au + 4KCN + O_2 + 2H_2O = 2KAu(CN)_2 + 4KOH + H_2O_2$; (2) $2Au + 4KCN + 2H_2O_2 = 2KAu(CN)_2 + 4KOH$. The end reaction may be written $4Au + 8KCN + 2H_2O + O_2 = 4KAu(CN)_2 + 4KOH$.

The commercial process was patented in 1890 by MacArthur and Forrest, and is now in use all over the world. It is best adapted for free-milling ores, especially after the bulk of the gold has been removed by amalgamation. It has been especially successful in the Transvaal. In the Witwatersrand the ore, which contains about 9 dwts. of gold to the metric ton (2000 lb), is stamped and amalgamated, and the slimes and tailings, containing about $\frac{3}{4}$ dwts. per ton, are cyanided, about 2 dwts. more being thus extracted. The total cost per ton of ore treated is about 6s., of which the cyaniding costs from 2s. to 4s.

The process embraces three operations: (1) Solution of the gold; (2) precipitation of the gold; (3) treatment of the precipitate.

The ores, having been broken and ground, generally in tube mills, until they pass a 150 to 200-mesh sieve, are transferred to the leaching vats, which are constructed of wood, iron or masonry; steel vats, coated inside and out with pitch, of circular section and holding up to 1000 tons, have come into use. The diameter is generally 26 ft., but may be greater; the best depth is considered to be a quarter of the diameter. The vats are fitted with filters made of coco-nut matting and jute cloth supported on wooden frames. The leaching is generally carried out with a strong, medium, and with a weak liquor, in the order given; sometimes there is a preliminary leaching with a weak liquor. The strengths employed depend also upon the mode of precipitation adopted, stronger solutions (up to 0.25% KCN) being used when zinc is the precipitant. For electrolytic precipitation the solution may contain up to 0.1% KCN. The liquors are run off from the vats to the electrolyzing baths or precipitating tanks, and the leached ores are removed by means of doors in the sides of the vats into wagons. In the Transvaal the operation occupies $\frac{3}{4}$ to 4 days for fine sands, and up to 14 days for coarse sands; the quantity of cyanide per ton of tailings varies from 0.26 to 0.28 lb, for electrolytic precipitation, and 0.5 lb for zinc precipitation.

The precipitation is effected by zinc in the form of bright turnings, or coated with lead, or by electrolysis. According to Christy, the precipitation with zinc follows equations 1 or 2 according as potassium cyanide is present or not:

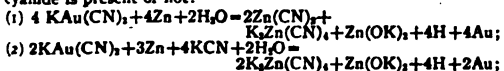

one part of zinc precipitating 3.1 parts of gold in the first case, and 2.06 in the second. It may be noticed that the potassium zinc cyanide is useless in gold extraction, for it neither dissolves gold nor can potassium cyanide be regenerated from it.

The precipitating boxes, generally made of wood but sometimes of steel, and set on an incline, are divided by partitions into alternately wide and narrow compartments, so that the liquor travels upwards in its passage through the wide divisions and downwards through the narrow divisions. In the wider compartments are placed sieves having sixteen holes to the square inch and bearing zinc turnings. The gold and other metals are precipitated on the under surfaces of the turnings and fall to the bottom of the compartment as a black slime. The slime is cleaned out fortnightly or monthly, the zinc

turnings being cleaned by rubbing and the supernatant liquor allowed to settle in the precipitating boxes or in separate vessels. The slime so obtained consists of finely divided gold and silver (5-50%), zinc (30-60%), lead (10%), carbon (10%), together with tin, copper, antimony, arsenic and other impurities of the zinc and ores. After well washing with water, the slimes are roughly dried in bag-filters or filter-presses, and then treated with dilute sulphuric acid, the solution being heated by steam. This dissolves out the zinc. Lime is added to bring down the gold, and the sediment, after washing and drying, is fused in graphite crucibles.

5. Electrolytic Processes.—The electrolytic separation of the gold from cyanide solutions was first practised in the Transvaal. The process, as elaborated by Messrs. Siemens and Halske, essentially consists in the electrolysis of weak solutions with iron or steel plate anodes, and lead cathodes, the latter, when coated with gold, being fused and cupelled. Its advantages over the zinc process are that the deposited gold is purer and more readily extracted, and that weaker solutions can be employed, thereby effecting an economy in cyanide.

In the process employed at the Worcester Works in the Transvaal, the liquors, containing about 150 grains of gold per ton and from 0.08 to 0.01% of cyanide, are treated in rectangular vats in which is placed a series of iron and leaden plates at intervals of 1 in. The cathodes, which are sheets of thin lead foil weighing $\frac{1}{2}$ lb to the sq. yd., are removed monthly, their gold content being from 0.5 to 10%, and after folding are melted in reverberatory furnaces to ingots containing 2 to 4% of gold. Cupellation brings up the gold to about 900 fine. Many variations of the electrolytic process as above outlined have been suggested. S. Cowper Cole has suggested aluminium cathodes; Andreoli has recommended cathodes of iron and anodes of lead coated with lead peroxide, the gold being removed from the iron cathodes by a brief immersion in molten lead; in the Pelatan-Cerici process the gold is amalgamated at a mercury cathode (see also below).

Refining or Parting of Gold.—Gold is almost always silver-bearing, and it may be also noted that silver generally contains some gold. Consequently the separation of these two metals is one of the most important metallurgical processes. In addition to the separation of the silver the operation extends to the elimination of the last traces of lead, tin, arsenic, &c. which have resisted the preceding cupellation.

The "parting" of gold and silver is of considerable antiquity. Thus Strabo states that in his time a process was employed for refining and purifying gold in large quantities by cementing or burning it with an aluminous earth, which, by destroying the silver, left the gold in a state of purity. Pliny shows that for this purpose the gold was placed on the fire in an earthen vessel with treble its weight of salt, and that it was afterwards again exposed to the fire with two parts of salt and one of argillaceous rock, which, in the presence of moisture, effected the decomposition of the salt; by this means the silver became converted into chloride.

The methods of parting can be classified into "dry," "wet" and electrolytic methods. In the "dry" methods the silver is converted into sulphide or chloride, the gold remaining unaltered; in the "wet" methods the silver is dissolved by nitric acid or boiling sulphuric acid; and in the electrolytic processes advantage is taken of the fact that under certain current densities and other circumstances silver passes from an anode composed of a gold-silver alloy to the cathode more readily than gold. Of the dry methods only F. B. Miller's chlorine process is of any importance, this method, and the wet process of refining by sulphuric acid, together with the electrolytic process, being the only ones now practised.

The conversion of silver into the sulphide may be effected by heating with antimony sulphide, litharge and sulphur, pyrites, or with sulphur alone. The antimony, or *Guss und Fluss*, method was practised up till 1846 at the Dresden mint; it is only applicable to alloys containing more than 50% of gold. The fusion results in the formation of a gold-antimony alloy, from which the antimony is removed by an oxidizing fusion with nitre. The sulphur and litharge, or *Pfannenschmied*, process was used to concentrate the gold in an alloy in order to make it amenable to "quartation," or parting with nitric acid. Fusion with sulphur was used for the same purpose as the *Pfannenschmied* process. It was employed in 1797 at the St Petersburg mint.

The conversion of the silver into the chloride may be effected by means of salt—the "cementation" process—or other chlorides, or by free chlorine—Miller's process. The first process consists essentially in heating the alloy with salt and brickdust; the latter absorbs the chloride formed, while the gold is recovered by washing. It is no longer employed. The second process depends upon the fact that, if chlorine be led into the molten alloy, the base metals and the silver are converted into chlorides. It was proposed in 1838 by Lewis Thompson, but it was only applied commercially after Miller's improvements in 1867, when it was adopted at the Sydney mint. Sir W. C. Roberts-Austen introduced it at the London mint; and it has also been used at Pretoria. It is especially suitable to gold containing little silver and base metals—a character of Australian gold—but it yields to the sulphuric acid and electrolytic methods in point of economy.

The separation of gold from silver in the wet way may be effected by nitric acid, sulphuric acid or by a mixture of sulphuric acid and *aqua regia*.

Parting by nitric acid is of considerable antiquity, being mentioned by Albertus Magnus (13th cent.), Biringuccio (1540) and Agricola (1556). It is now rarely practised, although in some refineries both the nitric acid and the sulphuric acid processes are combined, the alloy being first treated with nitric acid. It used to be called "quartation" or "inquantation," from the fact that the alloy best suited for the operation of refining contained 3 parts of silver to 1 of gold. The operation may be conducted in vessels of glass or platinum, and each pound of granulated metal is treated with a pound and a quarter of nitric acid of specific gravity 1.32. The method is sometimes employed in the assay of gold.

Refining by sulphuric acid, the process usually adopted for separating gold from silver, was first employed on the large scale by d'Arcet in Paris in 1802, and was introduced into the Mint refinery, London, by Mathison in 1829. It is based upon the facts that concentrated hot sulphuric acid converts silver and copper into soluble sulphates without attacking the gold, the silver sulphate being subsequently reduced to the metallic state by copper plates with the formation of copper sulphate. It is applicable to any alloy, and is the best method for parting gold with the exception of the electrolytic method.

The process embraces four operations: (1) the preparation of an alloy suitable for parting; (2) the treatment with sulphuric acid; (3) the treatment of the residue for gold; (4) the treatment of the solution for silver.

It is necessary to remove as completely as possible any lead, tin, bismuth, antimony, arsenic and tellurium, impurities which impair the properties of gold and silver, by an oxidizing fusion, e.g. with nitre. Over 20% of copper makes the parting difficult; consequently in such alloys the percentage of copper is diminished by the addition of silver free from copper, or else the copper is removed by a chemical process. Other undesirable impurities are the platinum metals, special treatment being necessary when these substances are present. The alloy, after the preliminary refining, is granulated by being poured, while molten, in a thin stream into cold water which is kept well agitated.

The acid treatment is generally carried out in cast iron pots; platinum vessels are employed, while porcelain vessels are only used for small operations, e.g. for charges of 100 to 225 oz. as at Oker in the Harz. The pots, which are usually cylindrical with a hemispherical bottom, may hold as much as 13,000 to 16,000 oz. of alloy. They are provided with lids, made either of lead or of wood lined with lead, which have openings to serve for the introduction of the alloy and acid, and a vent tube to lead off the vapours evolved during the operation. The bullion with about twice its weight of sulphuric acid of 66° B_é is placed in the pot, and the whole gradually heated. Since the action is sometimes very violent, especially when the bullion is treated in the granulated form (it is steadier when thin plates are operated upon), it is found expedient to add the acid in several portions. The heating is continued for 4 to 12 hours according to the amount of silver present; the end of the reaction is known by the absence of any hissing. Generally the reaction mixture is allowed to cool, and the residue, which settles to the bottom of the pot, consists of gold together with copper, lead and iron sulphates, which are insoluble in strong sulphuric acid; silver sulphate may also separate if present in sufficient quantity and the solution be sufficiently cooled. The solution is removed by ladles or by siphons, and the residue is leached out with boiling water; this removes the sulphates. A certain amount of silver is still present and, according to M. Pettenkofer, it is impossible to remove all the silver by means of sulphuric acid. Several methods are in use for removing the silver. Fusion with an alkaline bisulphate converts the silver into the sulphate, which may be extracted by boiling with sulphuric acid and then with water. Another process consists in treating a mixture of the residue with one-quarter of its weight of calcined sodium sulphate with sulphuric acid, the residue being finally boiled with a large quantity of acid. Or the alloy is dissolved in *aqua regia*, the solution filtered from the insoluble silver chloride, and the gold precipitated by ferrous chloride.

The silver present in the solution obtained in the sulphuric acid boiling is recovered by a variety of processes. The solution may be directly precipitated with copper, the copper passing into solution as copper sulphate, and the silver separating as a mud, termed "cement silver." Or the silver sulphate may be separated from the solution by cooling and dilution, and then mixed with iron clippings, the interaction being accompanied with a considerable evolution of heat. Or Gutzkow's method of precipitating the metal with ferrous sulphate may be employed.

The electrolytic parting of gold and silver has been shown to be more economical and free from the objections—such as the poisonous fumes—of the sulphuric acid process. One process depends upon the fact that, with a suitable current density, if a very dilute solution of silver nitrate be electrolysed between an auriferous silver anode and a silver cathode, the silver of the anode is dissolved out and deposited at the cathode, the gold remaining at the anode. The silver is quite free from gold, and the gold after boiling with nitric acid has a fineness of over 999.

Gold is left in the anode slime when copper or silver are refined by the usual processes, but if the gold precipitate in the anode these processes are inapplicable. A cyanide bath, as used in electroplating, would dissolve the gold, but is not suitable for refining, because other metals (silver, copper, &c.) passing with gold into the solution would deposit with it. Bock, however, in 1880 (*Berg- und hüttenmännische Zeitung*, 1880, p. 411) described a process used at the North German Refinery in Hamburg for the refining of gold containing platinum with a small proportion of silver, lead or bismuth, and a subsequent patent specification (1896) and a paper by Wohlwill (*Zells. f. Elektrochem.*, 1898, pp. 379, 402, 421) have thrown more light upon the process. The electrolyte is gold chloride (2.5-3 parts of pure gold per 100 of solution) mixed with from 2 to 6% of the strongest hydrochloric acid to render the gold anodes readily soluble, which they are not in the neutral chloride solution. The bath is used at 65° to 70° C. (150° to 158° F.), and if free chlorine be evolved, which is known at once by its pungent smell, the temperature is raised, or more acid is added, to promote the solubility of the gold. The bath is used with a current-density of 100 amperes per sq. ft. at 1 volt (or higher), with electrodes about 1-2 in. apart. In this process all the anode metals pass into solution except iridium and other refractory metals of that group which remain as metals, and silver, which is converted into insoluble chloride, lead and bismuth form chloride and oxychloride respectively, and these dissolve until the bath is saturated with them, and then precipitate with the silver in the tank. But if the gold-strength of the bath be maintained, only gold is deposited at the cathode—in a loose powdery condition from pure solutions, but in a smooth detachable deposit from impure liquors. Under good conditions the gold should contain 99.98% of the pure metal. The tank is of porcelain or glazed earthenware, the electrodes for impure solutions are $\frac{1}{2}$ in. apart (or more with pure solutions), and are on the multiple system, and the potential difference at the terminals of the bath is 1 volt. A high current-density being employed, the turn-over of gold is rapid—an essential factor of success when the costliness of the metal is taken into account. Platinum and palladium dissolved from the anode accumulate in the solution, and are removed at intervals of, say, a few months by chemical precipitation. It is essential that the bath should not contain more than 5% of palladium, or some of this metal will deposit with the gold. The slimes are treated chemically for the separation of the metals contained in them.

AUTHORITIES.—Standard works on the metallurgy of gold are the treatises of T. Kirke Rose and of M. Eissler. The cyanide process is especially treated by M. Eissler, *Cyanide Process for the Extraction of Gold*, which pays particular attention to the Witwatersrand methods; Alfred James, *Cyanide Practices*; H. Forbes Julian and Edgar Smart, *Cyaniding Gold and Silver Ores*. Gold milling is treated by Henry Louis, *A Handbook of Gold Milling*; C. G. Warnford Lock, *Gold Milling*; T. A. Rickard, *Stamp Milling of Gold Ores*. Gold dredging is treated by Captain C. C. Longridge in *Gold Dredging*, and hydraulic mining is discussed by the same author in his *Hydraulic Mining*. For operations in special districts see J. M. MacLaren, *Gold* (1908); J. H. Curle, *Gold Mines of the World*; Africa: F. H. Hatch and J. A. Chalmers, *Gold Mines of the Rand*; S. J. Truscott, *Witwatersrand Goldfields: Banket and Mining Practice*; Australasia: D. Clark, *Australian Mining and Metallurgy*; Karl Schmeisser, *Goldfields of Australasia*; A. G. Charleton, *Gold Mining and Milling in Western Australia*; India: F. H. Hatch, *The Kolar Gold-Field*.

GOLD AND SILVER THREAD. Under this heading some general account may be given of gold and silver strips, threads and gimp used in connexion with varieties of weaving, embroidery and twisting and plaiting or lace work. To this day, in many oriental centres where it seems that early traditions of the knowledge and the use of fabrics wholly or partly woven, ornamented, and embroidered with gold and silver have been maintained, the passion for such brilliant and costly textiles is still strong and prevalent. One of the earliest mentions of the use of gold in a woven fabric occurs in the description of the ephod made for Aaron (Exod. xxxix. 2, 3), "And he made the ephod of gold, blue, and purple, and scarlet, and fine twined linen. And they did beat the gold into thin plates, and cut it into wires (strips), to work it in the blue, and in the purple, and in the scarlet, and in the fine linen, with cunning work." This is suggestive of early Syrian or Arabic in-darning or weaving with gold strips or tinsel. In both the *Iliad* and the *Odyssey* allusion is frequently made to inwoven and embroidered golden textiles. Assyrian sculpture gives an elaborately designed ornament upon the robe of King Assur-nasir-pal (884 B.C.) which was probably an interweaving of gold and coloured threads, and testifies to the consummate skill of Assyrian or Babylonian workers at that date. From Assyrian and Babylonian weavers the conquering Persians of the time of Darius derived their celebrity as weavers and users of splendid stuffs. Herodotus describes

the corselet given by Amasis king of Egypt to the Minerva of Lindus and how it was inwoven or embroidered with gold. Darius, we are told, wore a war mantle on which were figured (probably inwoven) two golden hawks as if pecking at each other. Alexander the Great is said to have found Eastern kings and princes arrayed in robes of gold and purple. More than two hundred years later than Alexander the Great was the king of Pergamos (the third bearing the name Attalus) who gave much attention to working in metals and is mentioned by Pliny as having invented weaving with gold, hence the historic Attalic cloths. There are several references in Roman writings to costumes and stuffs woven and embroidered with gold threads and the Graeco-Roman *chryso-phrygium* and the Roman *aurei-phrygium* are evidences not only of Roman work with gold threads but also of its indebtedness to Phrygian sources. The famous tunics of Agrippina and those of Heliogabalus are said to have been of tissues made entirely with gold threads, whereas the robes which Marcus Aurelius found in the treasury of Hadrian, as well as the costumes sold at the dispersal of the wardrobe of Commodus, were different in character, being of fine linen and possibly even of silken stuffs inwoven or embroidered with gold threads. The same description is perhaps correct of the reputedly splendid hangings with which King Dagobert decorated the early medieval oratory of St Denis. Reference to these and many such stuffs is made by the respectively contemporary or almost contemporary writers; and a very full and interesting work by Monsieur Francisque Michel (Paris, 1852) is still a standard book for consultation in respect of the history of silk, gold and silver stuffs.

From indications such as these, as well as those of later date, one sees broadly that the art of weaving and embroidering with gold and silver threads passed from one great city to another, travelling as a rule westward. Babylon, Tarsus, Bagdad, Damascus, the islands of Cyprus and Sicily, Constantinople, Venice and southern Spain appear successively in the process of time as famous centres of these much-prized manufactures. During the middle ages European royal personages and high ecclesiastical dignitaries used cloth and tissues of gold and silver for their state and ceremonial robes, as well as for costly hangings and decoration; and various names—*ciclatoun*, *tartarium*, *naques* or *nac*, *baudekin* or *baldachin* (Bagdad) and *tissue*—were applied to textiles in the making of which gold threads were almost always introduced in combination with others. The thin filmy paper known as *tissue paper* is so called because it originally was placed between the folds of gold "tissue" (or weaving) to prevent the contiguous surfaces from fraying each other. Under the articles dealing with carpets, embroidery, lace and tapestry will be found notices of the occasional use in such productions of gold and silver threads. Of early date in the history of European weaving are rich stuffs produced in Southern Spain by Moors, as well as by Saracenic and Byzantine weavers at Palermo and Constantinople in the 12th century, in which metallic threads were freely used. Equally esteemed at about the same period were corresponding stuffs made in Cyprus, whilst for centuries later the merchants in such fabrics eagerly sought for and traded in Cyprus gold and silver threads. Later the actual manufacture of them was not confined to Cyprus, but was also carried on by Italian thread and trimming makers from the 14th century onwards. For the most part the gold threads referred to were of silver gilt. In rare instances of middle-age Moorish or Arabian fabrics the gold threads are made with strips of parchment or paper gilt and still rarer are instances of the use of real gold wire.

In India the preparation of variousities of gold and silver threads is an ancient and important art. The "gold wire" of the manufacturer has been and is as a rule silver wire gilt, the silver wire being, of course, composed of pure silver. The wire is drawn by means of simple draw-plates, with rude and simple appliances, from rounded bars of silver, or gold-plated silver, as the case may be. The wire is flattened into strip, tinsel or ribbon-like form, by passing fourteen or fifteen strands simultaneously, over a fine, smooth, round-topped anvil and

beating each as it passes with a heavy hammer having a slightly convex surface. Such strips or tinsel of wire so flattened are woven into Indian *sawiri*, tissue or cloth of gold, the web or warp being composed entirely of golden strips, and *rasperi*, similar tissue of silver. Other gold and silver threads suitable for use in embroidery, pillow and needlepoint lace making, &c., consist of fine strips of flattened wire wound round cores of orange (in the case of silver, white) silk thread so as to completely cover them. Wires flattened or partially flattened are also twisted into exceedingly fine spirals and much used for heavy embroideries. Spangles for embroideries, &c., are made from spirals of comparatively stout wire, by cutting them down ring by ring, laying each C-like ring on an anvil, and by a smart blow with a hammer flattening it out into a thin round disk with a slit extending from the centre to one edge. The demand for many kinds of loom-woven and embroidered gold and silver work in India is immense, and the variety of textiles so ornamented is also very great, chief amongst which are the golden or silvery tinsel fabrics known as *kincobs*.

Amongst Western communities the demand for gold and silver embroideries and braid lace now exists chiefly in connexion with naval, military and other uniforms, masonic insignia, court costumes, public and private liveries, ecclesiastical robes and draperies, theatrical dresses, &c.

The proportions of gold and silver in the gold thread for the woven braid lace or ribbon trade varies, but in all cases the proportion of gold is exceedingly small. An ordinary gold braid wire is drawn from a bar containing 90 parts of silver and 7 of copper, and plated with 3 of gold. On an average each ounce troy of a bar so plated is drawn into 1500 yds. of wire; and therefore about 16 grains of gold cover 1 m. of wire. (A. S. C.)

GOLDAST AB HAIMINSFELD, MELCHIOR (1576-1635), Swiss writer, an industrious though uncritical collector of documents relating to the medieval history and Constitution of Germany, was born on the 6th of January 1576 (some say 1578), of poor Protestant parents, near Bischofszell, in the Swiss Canton of Thurgau. His university career, first at Ingolstadt (1585-1586), then at Altdorf near Nuremberg (1597-1598), was cut short by his poverty, from which he suffered all his life, and which was the main cause of his wanderings. In 1598 he found a rich protector in the person of Bartholomaeus Schobinger, of St Gall, by whose liberality he was enabled to study at St Gall (where he first became interested in medieval documents, which abound in the conventual library) and elsewhere in Switzerland. Before his patron's death (1604) he became (1603) secretary to Henry, duke of Bouillon, with whom he went to Heidelberg and Frankfurt. But in 1604 he entered the service of the Baron von Hohensax, then the possessor of the precious MS. volume of old German poems, returned from Paris to Heidelberg in 1888, and, partially published by Goldast. Soon he was back in Switzerland, and by 1606 in Frankfurt, earning his living by preparing and correcting books for the press. In 1611 he was appointed councillor at the court of Saxe-Weimar, and in 1615 he entered the service of the count of Schaumburg at Bückeberg. In 1624 he was forced by the war to retire to Bremen; there in 1625 he deposited his library in that of the town (his books were bought by the town in 1646, but many of his MSS. passed to Queen Christina of Sweden, and hence are now in the Vatican library), he himself returning to Frankfurt. In 1627 he became councillor to the emperor and to the archbishop-elect of Trèves, and in 1633 passed to the service of the landgrave of Hesse-Darmstadt. He died at Giessen early in 1635.

His immense industry is shown by the fact that his biographer, Senckenburg, gives a list of 65 works published or written by him, some extending to several substantial volumes. Among the more important are his *Paraeneticorum veterum pars i.* (1604), which contained the old German tales of *König Tyrol von Schotten*, the *Winsbeke* and the *Winsbekin*; *Suevicarum rerum scriptores* (Frankfort, 1605, new edition, 1727); *Rerum Alamannicarum scriptores* (Frankfort, 1606, new edition by Senckenburg, 1730); *Constitutiones imperiales* (Frankfort, 1607-1613, 4 vols.); *Monarchia s. Romani imperii* (Hanover and Frankfurt, 1612-1614,

3 vols.); *Commentarii de regni Bohemiac juribus* (Frankfort, 1627, new edition by Schmink, 1719). He also edited De Thou's *History* (1609-1610) and Willibald Pirckheimer's works (1610). In 1688 a volume of letters addressed to him by his learned friends was published.

Life by Senckenburg, prefixed to his 1730 work. See also R. von Raumer's *Geschichte d. germanischen Philologie* (Munich, 1870). (W. A. B. C.)

GOLDBEATING.—The art of goldbeating is of great antiquity, being referred to by Homer; and Pliny (*N.H.* 33. 19) states that 1 oz. of gold was extended to 750 leaves, each leaf being four fingers (about 3 in.) square; such a leaf is three times as thick as the ordinary leaf gold of the present time. In all probability the art originated among the Eastern nations, where the working of gold and the use of gold ornaments have been distinguishing characteristics from the most remote periods. On Egyptian mummy cases specimens of original leaf-gilding are met with, where the gold is so thin that it resembles modern gilding (*q.v.*). The minimum thickness to which gold can be beaten is not known with certainty. According to Mersenne (1621) 1 oz. was spread out over 105 sq. ft.; Réaumur (1711) obtained 146½ sq. ft.; other values are 180 sq. ft. and 300 sq. ft. Its malleability is greatly diminished by the presence of other metals, even in very minute quantity. In practice the average degree of tenuity to which the gold is reduced is not nearly so great as the last example quoted above. A "book of gold" containing 25 leaves measuring each 3½ in., equal to an area of 264 sq. in., generally weighs from 4 to 5 grains.

The gold used by the goldbeater is variously alloyed, according to the colour required. Fine gold is commonly supposed to be incapable of being reduced to thin leaves. This, however, is not the case, although its use for ordinary purposes is undesirable on account of its greater cost. It also adheres on one part of a leaf touching another, thus causing a waste of labour by the leaves being spoiled; but for work exposed to the weather it is much preferable, as it is more durable, and does not tarnish or change colour. The external gilding on many public buildings, e.g. the Albert Memorial in Kensington Gardens, London, is done with pure gold. The following is a list of the principal classes of leaf recognized and ordinarily prepared by British beaters, with the proportions of alloy per oz. they contain.

Name of Leaf.	Proportion of Gold.	Proportion of Silver.	Proportion of Copper.
	Grains.	Grains.	Grains.
Red	456-460	..	20-24
Pale red	464	..	16
Extra deep	456	12	12
Deep	444	24	12
Citron	440	30	10
Yellow	408	72	..
Pale yellow	384	96	..
Lemon	360	120	..
Green or pale	312	168	..
White	240	240	..

The process of goldbeating is as follows: The gold, having been alloyed according to the colour desired, is melted in a crucible at a higher temperature than is simply necessary to fuse it, as its malleability is improved by exposure to a greater heat; sudden cooling does not interfere with its malleability, gold differing in this respect from some other metals. It is then cast into an ingot, and flattened, by rolling between a pair of powerful smooth steel rollers, into a ribbon of 1½ in. wide and 10 ft. in length to the oz. After being flattened it is annealed and cut into pieces of about 6½ gra. each, or about 75 per oz., and placed between the leaves of a "cutch," which is about ½ in. thick and 3½ in. square, containing about 180 leaves of a tough paper. Formerly fine vellum was used for this purpose, and generally still it is interleafed in the proportion of about one of vellum to six of paper. The cutch is beaten on for about 20 minutes with a 17-lb hammer, which rebounds by the elasticity of the skin, and saves the labour of lifting, by which the gold is spread to the size of the cutch; each leaf is then taken out, and cut into four pieces, and put between the skins of a "shoder," 4½ in. square and ½ in. thick, containing about 720 skins, which have been worn out in the finishing or "mould" process. The shoder requires about two hours' beating upon with a 9-lb hammer. As the gold will spread unequally, the shoder is beaten upon after the larger leaves have reached the edges. The effect of this is that the margins of

larger leaves come out of the edges in a state of dust. This allows time for the smaller leaves to reach the full size of the shoder, thus producing a general evenness of size in the leaves. Each leaf is again cut into four pieces, and placed between the leaves of a "mould," composed of about 950 of the finest gold-beaters' skins, 5 in. square and ½ in. thick, the contents of one shoder filling three moulds. The material has now reached the last and most difficult stage of the process; and on the fineness of the skin and judgment of the workman the perfection and thinness of the leaf of gold depend. During the first hour the hammer is allowed to fall principally upon the centre of the mould. This causes gaping cracks upon the edges of the leaves, the sides of which readily coalesce and unite without leaving any trace of the union after being beaten upon. At the second hour, when the gold is about the 150,000th part of an inch in thickness, it for the first time permits the transmission of the rays of light. Pure gold, or gold but slightly alloyed, transmits green rays; gold highly alloyed with silver transmits pale violet rays. The mould requires in all about four hours' beating with a 7-lb hammer, when the ordinary thinness for the gold leaf of commerce will be reached. A single ounce of gold will at this stage be extended to 75 X 4 X 4 = 1200 leaves, which will trim to squares of about 3½ in. each. The finished leaf is then taken out of the mould, and the rough edges are trimmed off by slips of the ratan fixed in parallel grooves of an instrument called a waggon, the leaf being laid upon a leathern cushion. The leaves thus prepared are placed into "books" capable of holding 25 leaves each, which have been rubbed over with red ochre to prevent the gold clinging to the paper. Dentist gold is leaf gold carried no farther than the cutch stage, and should be perfectly pure gold.

By the above process also silver is beaten, but not so thin, the inferior value of the metal not rendering it commercially desirable to bestow so much labour upon it. Copper, tin, zinc, palladium, lead, cadmium, platinum and aluminium can be beaten into thin leaves, but not to the same extent as gold or silver.

The fine membrane called goldbeater's skin, used for making up the shoder and mould, is the outer coat of the caecum or blind gut of the ox. It is stripped off in lengths about 25 or 30 in., and freed from fat by dipping in a solution of caustic alkali and scraping with a blunt knife. It is afterwards stretched on a frame; two membranes are glued together, treated with a solution of aromatic substances or camphor in isinglass, and subsequently coated with white of egg. Finally they are cut into squares of 5 or 5½ in.; and to make up a mould of 950 pieces the gut of about 380 oxen is required, about 2½ skins being got from each animal. A skin will endure about 200 beatings in the mould, after which it is fit for use in the shoder alone.

The dryness of the cutch, shoder and mould is a matter of extreme delicacy. They require to be hot-pressed every time they are used, although they may be used daily, to remove the moisture which they acquire from the atmosphere, except in extremely frosty weather, when they acquire so little moisture that a difficulty arises from their over-dryness, whereby the brilliancy of the gold is diminished, and it spreads very slowly under the hammer. On the contrary, if the cutch or shoder be damp, the gold will become pierced with innumerable microscopic holes; and in the moulds in its more attenuated state it will become reduced to a pulverulent state. This condition is more readily produced in alloyed golds than in fine gold. It is necessary that each skin of the mould should be rubbed over with calcined gypsum each time the mould may be used, in order to prevent the adhesion of the gold to the surface of the skin in beating.

GOLDBERG, a town of Germany, in the Prussian province of Silesia, 14 m. by rail S.W. of Liegnitz, on the Katzbach, an affluent of the Oder. Pop. (1905) 6804. The principal buildings are an old church dating from the beginning of the 13th century, the Schwabe-Priesemuth Institution, completed in 1876, for the board and education of orphans, and the classical school or gymnasium (founded in 1524 by Duke Frederick II. of Liegnitz), which in the 17th century enjoyed great prosperity, and numbered Wallenstein among its pupils. The chief manufactures are woollen cloth, flannel, gloves, stockings, leather and beer, and there is a considerable trade in corn and fruit. Goldberg owes its origin and name to a gold mine in the neighbourhood, which, however, has been wholly abandoned since the time of the Hussite wars. The town obtained civic rights in 1211. It suffered heavily from the Tatars in 1241, from the plague in 1334, from the Hussites in 1428, and from the Saxon, Imperial and Swedish forces during the Thirty Years' War. On the 27th of May 1813 a battle took place near it between the French and the

¹ Goldberg is also the name of a small town in the grand-duchy of Mecklenburg-Schwerin.

Russians; and on the 23rd and the 27th of August of the same year fights between the allies and the French.

See Sturm, *Geschichte der Stadt Goldberg in Schlesien* (1887).

GOLD COAST, that portion of the Guinea Coast (West Africa) which extends from Assini upon the west to the river Volta on the east. It derives its name from the quantities of grains of gold mixed with the sand of the rivers traversing the district. The term Gold Coast is now generally identified with the British Gold Coast colony. This extends from $3^{\circ} 7' W.$ to $1^{\circ} 14' E.$, the length of the coast-line being about 370 m. It is bounded W. by the Ivory Coast colony (French), E. by Togoland (German). On the north the British possessions, including Ashanti (q.v.) and the Northern Territories, extend to the 11th degree of north latitude. The frontier separating the colony from Ashanti (fixed by order



in council, 22nd of October 1906) is in general 130 m. from the coast, but in the central portion of the colony the southern limits of Ashanti project wedge-like to the confluence of the rivers Ofin and Pra, which point is but 60 m. from the sea at Cape Coast. The combined area of the Gold Coast, Ashanti and the Northern Territories, is about 80,000 sq. m., with a total population officially estimated in 1908 at 2,700,000; the Gold Coast colony alone has an area of 24,200 sq. m., with a population of over a million, of whom about 2000 are Europeans.

Physical features.—Though the lagoons common to the West African coast are found both at the western and eastern extremities of the colony (Assini in the west and Kwitta in the east) the greater part of the coast-line is of a different character. Cape Three Points ($4^{\circ} 44' 40'' N.$, $2^{\circ} 5' 45'' W.$) juts boldly into the sea, forming the most southerly point of the colony. Thence the coast trends E. by N., and is but slightly indented. The usually low sandy beach is, however, diversified by bold, rocky headlands. The flat belt of country does not extend inland any considerable distance, the spurs of the great plateau which forms the major part of West Africa advancing in the east, in the Akwapim district, near to the coast. Here the hills reach an altitude of over 2000 ft. Out of the level plain rise many isolated peaks, generally of conical formation. Numerous rivers descend

from the hills, but bars of sand block their mouths, and the Gold Coast possesses no harbours. Great Atlantic rollers break unceasingly upon the shore. The chief rivers are the Volta (q.v.), the Ankobra and the Pra. The Ankobra or Snake river traverses auriferous country, and reaches the sea some 20 m. west of Cape Three Points. It has a course of about 150 m., and is navigable in steam launches for about 80 m. The Pra ("Busum Pra," sacred river) is regarded as a fetish stream by the Fanti and Ashanti. One of its sub-tributaries has its rise near Kumasi. The Pra rises in the N.E. of the colony and flows S.W. Some 60 m. from its mouth it is joined by the Ofin, which comes from the north-west. The united stream flows S. and reaches the sea in $1^{\circ} 35' W.$ As a waterway the river, which has a course of 400 m., is almost useless, owing to the many cataracts in its course. Another river is the Tano, which for some distance in its lower course forms the boundary between the colony and the Ivory Coast.

Geology.—Cretaceous rocks occur at intervals along the coast belt, but are mostly hidden under an extensive development of superficial deposits. Basalt occurs at Axim. Inland is a broad belt of sandstone and marl with an occasional band of auriferous conglomerate, best known and most extensively worked for gold in the Wasaw district. Though the conglomerates bear some resemblance to the "Banket" of South Africa they are most probably of more recent date. The alluvial silts and gravels also carry gold.

Climate.—The climate on the coast is hot, moist and unhealthy, especially for Europeans. The mean temperature in the shade in the coast towns is 78° to $80^{\circ} F.$ Fevers and dysentery are the diseases most to be dreaded by the European. The native inhabitants, although they enjoy tolerable health and live to an average age, are subject in the rainy season to numerous chest complaints. There are two wet seasons. From April to August are the greater rains, whilst in October and November occur the "small" or second rains. From the end of December to March the dry harmattan wind blows from the Sahara. In consequence of the prevalence of the sea-breeze from the south-west the western portion of the colony, up to the mouth of the Sekum river (a small stream to the west of Accra), is called the windward district, the eastward portion being known as the leeward. The rainfall at Accra, in the leeward district, averages 27 in. in the year, but at places in the windward district is much greater, averaging 79 in. at Axim.

Flora.—The greater part (probably three-fourths) of the colony is covered with primeval forest. Here the vegetation is so luxuriant that for great distances the sky is shut out from view. As a result of the struggle to reach the sunlight the forest growths are almost entirely vertical. The chief trees are silk cottons, especially the bombax, and gigantic hard-wood trees, such as the African mahogany, ebony, odum and camwood. The bombax rises for over 100 ft., a straight column-like shaft, 25 to 30 ft. in circumference, and then throws out horizontally a large number of branches. The lowest growth in the forest consists of ferns and herbaceous plants. Of the ferns some are climbers reaching 30 to 40 ft. up the stems of the trees they entwine. Flowering plants are comparatively rare; they include orchids and a beautiful white lily. The "bush" or intermediate growth is made up of small trees, the rubber vine and other creepers, some as thick as hawsers, bamboos and sensitive mimosa, and has a height of from 30 to 60 ft. The creepers are found not only in the bush, but on the ground and hanging from the branches of the highest trees. West of the Pra the forest comes down to the edge of the Atlantic. East of that river the coast land is covered with bushes 5 to 12 ft. high, occasional large trees and groves of oil palms. Still farther east, by Accra, are numerous arborescent Euphorbias, and immediately west of the lower Volta forests of oil palms and grassy plains with fan palms. Behind all these eastern regions is a belt of thin forest country before the denser forest is reached. In the north-east are stretches of orchard-like country with wild plum, shea-butter and kola trees, baobabs, dwarf date and fan palms. The cotton and tobacco plants grow wild. At the mouths of the rivers and along the lagoons the mangrove is the characteristic tree. There are numerous coco-nut palms along the coast. The fruit trees and plants also include the orange, pineapple, mango, papaw, banana and avocado or alligator pear.

Fauna.—The fauna includes leopards, panthers, hyenas, Potto lemons, jackals, antelopes, buffaloes, wild-hogs and many kinds of monkey, including the chimpanzee and the *Colobus vellerosus*, whose skin, with long black silky hair, is much prized in Europe. The elephant has been almost exterminated by ivory hunters. The snakes include pythons, cobras, horned and puff adders and the venomous water snake. Among the lesser denizens of the forest are the squirrel and porcupine. Crocodiles and in fewer numbers manates and otters frequent the rivers and lagoons and hippopotami are found in the Volta. Lizards of brilliant hue, tortoises and great snails are common. Birds, which are not very numerous, include parrots and hornbills, kingfishers, ospreys, herons, crossbills, curlews, woodpeckers, doves, pigeons, storks, pelicans, swallows, vultures and the spur plover (the last-named rare). Shoals of herrings frequent the coast, and the other fish include mackerel, sole, skate, mullet, bonito, flying fish, fighting fish and shyuno. Sharks abound at the mouths of all the rivers, edible turtle are fairly common, as are the sword fish, dolphin and sting ray (with poisonous caudal spine). Oysters are numerous on rocks running into the sea and on the

exposed roots of mangrove trees. Insect life is multitudinous; beetles, spiders, ants, fireflies, butterflies and jiggers abound. The earthworm is rare. The mosquitoes include the *Culex* or ordinary kind, the *Anopheles*, which carry malarial fever, and the *Sigomyia*, a striped white and black mosquito which carries yellow-fever.

Inhabitants.—The natives are all of the Negro race. The most important tribe is the Fanti (q.v.), and the Fanti language is generally understood throughout the colony. The Fanti and Ashanti are believed to have a common origin. It is certain that the Fanti came originally from the north and conquered many of the coast tribes, who anciently had owned the rule of the king of Benin. The districts in general are named after the tribes inhabiting them. Those in the western part of the colony are mainly of Fanti stock; the Accra and allied tribes inhabit the eastern portion and are believed to be the aboriginal inhabitants. The Akim (Akem), who occupy the north-east portion of the colony, have engaged in gold-digging from time immemorial. The capital of their country is Kibbi. The Akwapim (Aquapem), southern neighbours of the Akim, are extensively engaged in agriculture and in trade. The Accra, a clever race, are to be found in all the towns of the West African coast as artisans and sailors. They are employed by the interior tribes as middlemen and interpreters. On the right bank of the Volta occupying the low marshy land near the sea are the Adangme. The Krobo live in little villages in the midst of the palm tree woods which grow round about the Kroboberg, an eminence about 1000 ft. high. Their country lies between that of the Akim and the Adangme. In the west of the colony is the Ahanta country, formerly an independent kingdom. The inhabitants were noted for their skill in war. They are one of the finest and most intelligent of the tribes of Accra stock. The Apollonia, a kindred race, occupy the coast region nearest the Ivory Coast.

The Tshi, Tchwi or Chi language,¹ which is that spoken on the Gold Coast, belongs to the great prefix-pronominal group. It comprises many dialects, which may, however, be reduced to two classes or types. Akan dialects are spoken in Assini, Amanahia (Apollonia), Awini, Ahanta, Wasaw, Tshuloro (Juffer or Tufol), and Denkyera in the west, and in Aseu, Akim, and Akwapim in the east, as well as in the different parts of Ashanti. Fanti dialects are spoken, not only in Fanti proper, but in Afutu or the country round Cape Coast, in Abora, Agyimak, Akomfi, Gomoa and Agona. The difference between the two types is not very great; a Fanti, for example, can converse without much difficulty with a native of Akwapim or Ashanti, his language being in fact a deteriorated form of the same original. Akim is considered the finest and purest of all the Akan dialects. The Akwapim, which is based on the Akim but has imbibed Fanti influences, has been made the book-language by the Basel missionaries. They had reduced it to writing before 1850. About a million people in all, it is estimated, speak dialects of the Tshi.

The south-eastern corner of the Gold Coast is occupied by another language known as the Ga or Accra, which comprises the Ga proper and the Adangme and Krobo dialects. Ga proper is spoken by about 40,000 people, including the inhabitants of Ga and Kinka (i.e. Accra, in Tshi, Nkran and Kankan), Osu (i.e. Christiansborg), La, Tessi, Ningua and numerous inland villages. It has been reduced to writing by the missionaries. The Adangme and Krobo dialects are spoken by about 80,000 people. They differ very considerably from Ga proper, but books printed in Ga can be used by both the Krobo and Adangme natives. Another language known as Guan is used in parts of Akwapim and in Anum beyond the Volta; but not much is known either about it or the Obutu tongue spoken in a few towns in Agona, Gomoa and Akomfi.

Fetichism (q.v.) is the prevailing religion of all the tribes. Belief in a God is universal, as also is a belief in a future state. Christianity and Mahomedanism are both making progress. The natives professing Christianity number about 40,000. A Moravian mission was started at Christiansborg about 1736; the Basel mission (Evangelical) was begun in 1828, the missionaries combining manual training and farm labour with purely religious work; the Wesleyans started a mission among the Fanti in 1835, and the Anglican and Roman Catholic Churches are also represented, as well as the Bremen Missionary Society. Elementary education is chiefly in the hands of the Wesleyan, Basel, Bremen and Roman Catholic missions, who have schools at many towns along the coast and in the interior. There are also government and Mahomedan schools. The natives generally are extremely intelligent. They obtain easily the means of subsistence, and are disinclined to unaccustomed labour, such as working in mines. They are keen traders. The native custom of burying the dead under the floors of the houses prevailed until 1874, when it was prohibited by the British authorities.

Towns.—Unlike the other British possessions on the west coast of Africa, the colony has many towns along the shore, this being due to the multiplicity of traders of rival nations who went thither in quest of gold. Beginning at the west, Newtown, on the Assini or Eyi lagoon, is just within the British frontier. The first place of im-

portance reached is Axim (pop., 1901, 2189), the site of an old Dutch fort built near the mouth of the Axim river, and in the pre-railway days the port of the gold region. Rounding Cape Three Points, whose vicinity is marked by a line of breakers nearly 2½ m. long, Dixcove is reached. Twenty miles farther east is Sekondi (q.v.) (pop. about 5000), the starting-point of the railway to the gold-belts and Kumasi. Elmina (q.v.), formerly one of the most important posts of European settlement, is reached some distance after passing the mouth of the Pra. Eight miles east of Elmina is Cape Coast (q.v.), pop. of (1901) 28,948. Anamabo is 9 m. farther east. Here, in 1807, a handful of English soldiers made a heroic and successful defence of its fort against the whole Ashanti host. Saltpond, towards the end of the 19th century, diverted to itself the trade formerly done by Anamabo, from which it is distant 9 m. Saltpond is a well-built, flourishing town, and is singular in possessing no ancient fort. Between Anamabo and Saltpond is Kormantyne (Kormantyne), noted as the place whence the English first exported slaves from this coast. Hence the general name *Coromantynes* given in the West Indies to slaves from the Gold Coast. Eighty miles from Cape Coast is Accra (q.v.) (pop. 17,892), capital of the colony. (Winnebah is passed 30 m. before Accra is reached. It is an old town noted for the manufacture of canoes.) There is no station of much importance in the 60 m. between Accra and the Volta, on the right bank of which river, near its mouth, is the town of Addah (pop. 13,240). Kwitta (pop. 3018) lies beyond the Volta not far from the German frontier. Of the inland towns Akropong, the residence of the king of Akwapim, is one of the best known. It is 39 m. N.E. of Accra, stands on a ridge 1400 ft. above sea-level, and is a healthy place for European residents. At Akropong are the headquarters of the Basel Missionary Society. Akuse is a large town on the banks of the Volta. Tarkwa is the centre of the gold mining industry in the Wasaw district. Its importance dates from the beginning of the 20th century. Accra, Cape Coast and Sekondi possess municipal government.

Agriculture and Trade.—The soil is everywhere very fertile and the needs of the people being few there is little incentive to work. The forests alone supply an inexhaustible source of wealth, notably in the oil palm. Among vegetable products cultivated are cocoa, cotton, Indian corn, yams, casava, peas, peppers, onions, tomatoes, groundnuts (*Arachis hypogaea*), Guinea corn (*Sorghum vulgare*) and Guinea grains (*Anomium grana-paradisii*). The most common article of cultivation is, however, the kola nut (*Sterculia acuminata*), the favourite substitute in West Africa for the betel nut. In 1890 efforts were made by the establishment of a government botanical station at Aburi in the Accra district to induce the natives to improve their methods of cultivation and to enlarge the number of their crops. This resulted in the formation of hundreds of cocoa plantations, chiefly in the district immediately north of Accra. Subsequently the cultivation of the plant extended to every district of the colony. The industry had been founded in 1879 by a native of Accra, but it was not until 1901, as the result of the government's fostering care, that the export became of importance. In that year the quantity exported slightly exceeded 2,000,000 lb and fetched £42,000. In 1907 the quantity exported was nearly 21,000,000 lb and in value exceeded £515,000. In 1904 efforts were begun by the government and the British Cotton Growing Association in co-operation to foster the growing of cotton for export and by 1907 the cotton industry had become firmly established. Tobacco and coffee are grown at some of the Basel missionary stations.

The chief exports are gold, palm oil and palm kernels, cocoa, rubber, timber (including mahogany) and kola nuts. Of these articles the gold and rubber are shipped chiefly to England, whilst Germany, France and America, take the palm products and groundnuts. The rubber comes chiefly from Ashanti. The imports consist of cotton goods, rum, gin and other spirits, rice, sugar, tobacco, beads, machinery, building materials and European goods generally.

The value of the trade increased from £1,628,309 in 1896 to £4,055,351 in 1906. In the last named year the imports were valued at £2,058,839 and the exports at £1,996,412. While the value of imports had remained nearly stationary since 1902 the value of exports had nearly trebled in that period. In the five years 1903-1907 the total trade increased from £3,063,486 to £5,007,869. Great Britain and British colonies take 66% of the exports and supply over 60% of the imports. In both import and export trade Germany is second, followed by France and the United States. Specie is included in these totals, over a quarter of a million being imported in 1904.

Fishing is carried on extensively along the coast, and salted and sun-dried fish from Addah and Kwitta districts find a ready sale inland. Cloths are woven by the natives from home-grown and imported yarn; the making of canoes, from the silk-cotton tree, is a flourishing industry, and salt from the lagoons near Addah is roughly prepared. There are also native artificers in gold and other metals, the workmanship in some cases being of conspicuous merit. Odum wood is largely used in building and for cabinet work.

Gold Mining.—Gold is found in almost every part of the colony, but only in a few districts in paying quantities. Although since the discovery of the coast gold had been continuously exported to Europe from its ports, it was not until the last twenty years of the 19th century that efforts were made to extract gold according to modern methods. The richness of the Tarkwa main reef was first

¹ This name appears in a great variety of forms—Kwi, Ekwi, Okwi, Oji, Odschi, Otsui, Tyi, Twi, Tachi, Chwee or Chee.

discovered by a French trader, M. J. Bannat, about 1880. During the period 1880 to 1900 the value of the gold exported varied from a minimum of £32,000 to a maximum (1889) of £103,000. The increased interest shown in the industry led to the construction of a railway (see below) to the chief gold-fields, whereby the difficulties of transport were largely overcome. Consequently upon the taking up of a number of concessions, a concessions ordinance was issued in August 1900. This was followed in 1901 by the grant of 2825 concessions, and a "boom" in the West African market on the London stock exchange. Many concessions were speedily abandoned, and in 1901 the export of gold dropped to its lowest point, 6162 oz., worth £2186, but in 1902 a large company began crushing ore and the output of gold rose to 26,911 oz., valued at £96,880. In 1907 the export was 292,125 oz., worth £1,164,676. It should be noted that one of the principal gold mines is not in the colony proper, but at Obuassi in Ashanti. Underground labour is performed mainly by Basas and Krumea from Liberia. Of native tribes the Apollonia have proved the best for underground work, as they have mining traditions dating from Portuguese times. A good deal of alluvial gold is obtained by dredging apparatus. The use of dredging apparatus is modern, but the natives have worked the alluvial soil and the sand of the seashore for generations to get the gold they contain.

Communications.—The colony possesses a railway, built and owned by the government, which serves the gold mines, and has its sea terminus at Sekondi. Work was begun in August 1898, but owing to the disturbance caused by the Ashanti rising of 1900 the rails only reached Tarkwa (39 m.) in May 1901. Thence the line is carried to Kumasi, the distance to Obuassi (124 m.) being completed by December 1902, whilst the first train entered the Ashanti capital on the 1st of October 1903. The total length of the line is 168 m. The cost of construction was £1,820,000. The line has a gauge 1 ft. 6 in. There is a branch line, 20 m. long, from Tarkwa N.W. to Prestea on the Ankobra river. Another railway, built 1907-10, 35 m. in length, runs from Accra to Mangoase, in the centre of the chief cocoa plantations. An extension to Kumasi has been surveyed.

Tortuous bush tracks are the usual means of internal communication. These are kept in fair order in the neighbourhood of government stations. There is a well-constructed road 141 m. long from Cape Coast to Kumasi, and roads connecting neighbouring towns are maintained by the government. Systematic attempts to make use of the upper Volta as a means of conveying goods to the interior were first tried in 1900. The rapids about 60 m. from the mouth of the river effectually prevent boats of large size passing up the stream. Where railways or canoes are not available goods are generally carried on the heads of porters, 60 lb being a full load. Telegraphs, introduced in 1882, connect all the important towns in the colony, and a line starting at Cape Coast stretches far inland, via Kumasi to Wa in the Northern Territories. Accra and Sekondi are in telegraphic communication with Europe, the Ivory Coast, Lagos and the Cape of Good Hope. There is regular and frequent steamship communication with Europe by British, Belgian and German lines.

Administration, Revenue, &c.—The country is governed as a crown colony, the governor being assisted by a legislative council composed of officials and nominated unofficial members. Laws, called ordinances, are enacted by the governor with the advice and consent of this council. The law of the colony is the common law and statutes of general application in force in England in 1874, modified by local ordinances passed since that date. The governor is also governor of Ashanti and the Northern Territories, but in those dependencies the legislative council has no authority.

Native laws and customs—which are extremely elaborate and complicated—are not interfered with "except when repugnant to natural justice." Those relating to land tenure and succession may be thus summarized. Individual tenure is not unknown, but most land is held by the tribe or by the family in common, each member having the right to select a part of the common land for his own use. Permanent alienation can only take place with the unanimous consent of the family and is uncommon, but long leases are granted. Succession is through the female, *i.e.* when a man dies his property goes to his sister's children. The government of the tribes is by their own kings and chiefs under the supervision of district commissioners. Slavery has been abolished in the colony. In the Northern Territories the dealing in slaves is unlawful, neither can any person be put in pawn for debt; nor will any court give effect to the relations between master and slave except in so far as those relations may be in accordance with the English laws relating to master and servant.

For administrative purposes the colony is divided into three provinces under provincial commissioners, and each province is subdivided into districts presided over by commissioners, who exercise judicial as well as executive functions. The supreme court consists of a chief justice and three puisne judges. The defence of the colony is entrusted to the Gold Coast regiment of the West African Frontier Force, a force of natives controlled by the Colonial Office but officered from the British army. There is also a corps of volunteers (formed 1892).

The chief source of revenue is the customs and (since 1902) railway receipts, whilst the heaviest items of expenditure are transport (including railways) and mine surveys, medical and sanitary services, and maintenance of the military force. The revenue, which in the period 1894-1898 averaged £244,559 yearly, rose in 1898-1903 to an

average of £556,316 a year. For the five years 1903-1907 the average annual revenue was £647,537, and the average annual expenditure £615,696. Save for municipal purposes there is no direct taxation in the colony and no poor-houses exist. There is a public debt of (December 1907) £2,206,964. It should be noted that the expenditure on Ashanti and the Northern Territories is included in the Gold Coast budget.

History.—It is a debated question whether the Gold Coast was discovered by French or by Portuguese sailors. The evidence available is insufficient to prove the assertion, of which there is no contemporary record, that a company of Norman merchants established themselves about 1364 at a place they named La Mina (Elmina), and that they traded with the natives for nearly fifty years, when the enterprise was abandoned. It is well established that a Portuguese expedition under Diogo d'Azambuja, accompanied probably by Christopher Columbus, took possession of (or founded) Elmina in 1482-1482. By the Portuguese it was called variously São Jorge da Mina or Ora del Mina—the mouth of the (gold) mines. That besides alluvial washings they also worked the gold mines was proved by discoveries in the latter part of the 16th century. The Portuguese remained undisturbed in their trade until the Reformation, when the papal bull which had given the country, with many others, to Portugal ceased to have a binding power. English ships in 1553 brought back from Guinea gold to the weight of 150 lb. The fame of the Gold Coast thereafter attracted to it adventurers from almost every European nation. The English were followed by French, Danes, Brandenburgers, Dutch and Swedes. The most aggressive were the Dutch, who from the end of the 16th century sought to oust the Portuguese from the Gold Coast, and in whose favour the Portuguese did finally withdraw in 1642, in return for the withdrawal on the part of the Dutch of their claims to Brazil. The Dutch henceforth made Elmina their headquarters on the coast. Traces of the Portuguese occupation, which lasted 160 years, are still to be found, notably in the language of the natives. Such familiar words as palaver, fetish, caboccer and dash (*i.e.* a gift) have all a Portuguese origin.

An English company built a fort at Komantine previously to 1651, and some ten years later Cape Coast Castle was built. The settlements made by the English provoked the hostility of the Dutch and led to war between England and Holland, during which Admiral de Ruyter destroyed (1664-1665) all the English forts save Cape Coast castle. The treaty of Breda in 1667 confirmed the Dutch in the possession of their conquests, but the English speedily opened other trading stations. Charles II. in 1672 granted a charter to the Royal African Company, which built forts at Dixcove, Sekondi, Accra, Whydah and other places, besides repairing Cape Coast Castle. At this time the trade both in slaves and gold was very great, and at the beginning of the 18th century the value of the gold exported annually was estimated by Willem Bosman, the chief Dutch factor at Elmina, to be over £300,000. The various European traders were constantly quarrelling among themselves and exercised scarcely any control over the natives. Piracy was rife along the coast, and was not indeed finally stamped out until the middle of the 19th century. The Royal African Company, which lost its monopoly of trade with England in 1700, was succeeded by another, the African Company of Merchants, which was constituted in 1750 by act of parliament and received an annual subsidy from government. The slave trade was then at its height and some 10,000 negroes were exported yearly. Many of the slaves were prisoners of war sold to the merchants by the Ashanti, who had become the chief native power. The abolition of the slave trade (1807) crippled the company, which was dissolved in 1821, when the crown took possession of the forts.

Since the beginning of the 19th century the British had begun to exercise territorial rights in the towns where they held forts, and in 1817 the right of the British to control the natives living in the coast towns was recognized by Ashanti. In 1824 the first step towards the extension of British authority beyond the coast region was taken by Governor Sir Charles M'Carthy, who incited the Fanti to rise against their oppressors, the Ashanti. (The Fanti's country had been conquered by the Ashanti in 1807.)

Appearance of the English.

Sir Charles and the Fanti army were defeated, the governor losing his life, but in 1826 the English gained a victory over the Ashanti at Dodowah. At this period, however, the home government, disgusted with the Gold Coast by reason of the perpetual disturbances in the protectorate and the trouble it occasioned, determined to abandon the settlements, and sent instructions for the forts to be destroyed and the Europeans brought home. The merchants, backed by Major Ricketts, 2nd West India regiments, the administrator, protested, and as a compromise the forts were handed over to a committee of merchants (Sept. 1828), who were given a subsidy of £4000 a year. The merchants secured (1830) as their administrator Mr. George Maclean—a gentleman with military experience on the Gold Coast and not engaged in trade. To Maclean is due the consolidation of British interests in the interior. He concluded, 1831, a treaty with the Ashanti advantageous to the Fanti, whilst with very inadequate means he contrived to extend British influence over the whole region of the present colony. In the words of a Fanti trader Maclean understood the people, "he settled things quietly with them and the people also loved him."¹ Complaints that Maclean encouraged slavery reached England, but these were completely disproved, the governor being highly commended on his administration by the House of Commons Committee. It was decided, nevertheless, that the Colonial Office should resume direct control of the forts, which was done in 1843, Maclean continuing to direct native affairs until his death in 1847. The jurisdiction of England on the Gold Coast was defined by the bond of the 6th of March 1844, an agreement with the native chiefs by which the crown received the right of trying criminals, repressing human sacrifice, &c. The limits of the protectorate inland were not defined. The purchase of the Danish forts in 1850, and of the Dutch forts and territory in 1871, led to the consolidation of the British power along the coast; and the Ashanti war of 1873-74 resulted in the extension of the area of British influence. Since that time the colony has been chiefly engaged in the development of its material resources, a development accompanied by a slow but substantial advance in civilization among the native population. (For further historical information see ASHANTI.)

For a time the Gold Coast formed officially a limb of the "West African Settlements" and was virtually a dependency of Sierra Leone. In 1874 the settlements on the Gold Coast and Lagos were created a separate crown colony, this arrangement lasting until 1886 when Lagos was cut off from the Gold Coast administration.

Northern Territories.

The Northern Territories of the Gold Coast form a British protectorate to the north of Ashanti. They are bounded W. and N.—where 11° N. is the frontier line except at the eastern extremity—by the French colonies of the Ivory Coast and Upper Senegal and Niger, E. by the German colony of Togoland. The southern frontier, separating the protectorate from Ashanti, is the Black Volta to a point a little above its junction with the White Volta. Thence the frontier turns south and afterwards east so as to include the Brumasi district in the protectorate, the frontier gaining the main Volta below Yeji. The Territories include nearly all the country from the meridian of Greenwich to 3° W. and between 8° and 11° N., and cover an area of about 33,000 sq. m.

Lying north of the great belt of primeval forest which extends parallel to the Guinea coast, the greater part of the protectorate consists of open country, well timbered, and much of it presenting a park-like appearance. There are also large stretches of grassy plains, and in the south-east an area of treeless steppe. The flora and fauna resemble those of Ashanti. The country is well watered, the Black Volta forming the west and southern frontier for some distance, while the White Volta traverses its central regions. Both rivers, and also the united stream, contain rapids which impede but do not prevent navigation (see VOLTA). The climate is much healthier than that of the coast districts, and the

¹ Blue Book on Africa (Western Coast) (1865), p. 233.

fewer experienced is of a milder type. The rainfall is less than on the coast; the dry season lasts from November (when the harmattan begins to blow) to March. The mean temperature at Gambaga is 80° F., the mean annual rainfall 43 in. The inhabitants were officially estimated in 1907 to number "at least 1,000,000." The Dagomba, Dagarti, Grunshi, Kangarga, Moshi and Zebarima, Negro or Negroid tribes, constitute the bulk of the people, and Fula, Hausa and Yoruba have settled as traders or cattle raisers. A large number of the natives are Moslems, the rest are fetish worshippers. The tribal organization is maintained by the British authorities, who found comparatively little difficulty in putting an end to slave-raiding and gaining the confidence of the chiefs. Trained by British officers, the natives make excellent soldiers.

Agriculture and Trade.—The chief crops are maize, guinea-corn, millet, yams, rice, beans, groundnuts, tobacco and cotton. Cotton is grown in most parts of the protectorate, the soil and climate in many districts being very suitable for its cultivation. Rubber is found in the north-western regions. When the protectorate was assumed by Great Britain the Territories were singularly destitute of fruit trees. The British have introduced the orange, citron, lime, guava, mango and soursop, and among plants the banana, pine-apple and papaw. A large number of vegetables and flowers have also been introduced by the administration.

Stock-raising is carried on extensively, and besides oxen and sheep there are large numbers of horses and donkeys in the Territories. The chief exports are cattle, *dawa-dawa* (a favourite flavouring matter for soup among the Ashanti and other tribes) and shea-butter—the latter used in cooking and as an illuminant. The principal imports are kola-nuts, salt and cotton goods. A large proportion of the European goods imported is German and comes through Togoland. The administration levies a tax on traders' caravans, and in return ensures the safety of the roads. This tax is the chief local source of revenue. The revenue and expenditure of the Territories, as well as statistics of trade, are included in those of the Gold Coast.

Gold exists in quartz formation, chiefly in the valley of the Black Volta, and is found equally on the British and French sides of the frontier.

Towns.—The headquarters of the administration are at Tamale (or Tamari), a town in the centre of the Dagomba country east of the White Volta and 200 m. N.E. of Kumasi. Its inhabitants are keen traders, and it forms a distributing centre for the whole protectorate. Gambaga, an important commercial centre and from 1897 to 1907 the seat of government, is in Mamprusi, the north-east corner of the protectorate and is 85 m. N.N.E. of Tamale. A hundred and forty miles due south of Gambaga is Salaga. This town is situated on the caravan route from the Hausa states to Ashanti, and has a considerable trade in kola-nuts, shea-butter and salt. On the White Volta, midway between Gambaga and Salaga, is the thriving town of Daboya. On the western frontier are Bole (Baule) and Wa. They carry on an extensive trade with Bontuku, the capital of Jaman, and other places in the Ivory Coast colony. In all the towns the population largely consists of aliens—Hausa, Ashanti, Mandingos, &c.

Communications.—Lack of easy communication with the sea hinders the development of the country. The ancient caravan routes have been, however, supplemented by roads built by the British, who have further organized a service of boats on the Volta. Large cargo boats, chiefly laden with salt, ascend that river from Addah to Yeji and Daboya. From Yeji, the port of Salaga, a good road, 150 m. long, has been made to Gambaga. There is also a river service from Yeji to Longoro on the Black Volta, the port of Kintampo, in northern Ashanti. There is a complete telegraphic system connecting the towns of the protectorate with Kumasi and the Gold Coast ports.

History.—It was not until the last quarter of the 19th century that the country immediately north of Ashanti became known to Europeans. The first step forward was made by Monsieur M. J. Bonnat (one of the Kumasi captives, see ASHANTI) who, ascending the Volta, reached Salaga (1875-1876). In 1882 Captain R. La Trobe Lonsdale, an officer in British colonial service, went farther, visiting Yendi in the north and Bontuku in the west. Two years later Captain Brandon Kirby made his way to Kintampo. In 1887-1889 Captain L. G. Binger, a French officer, traversed the country from north to south. Thereafter the whole region was visited by British, French and German political missions. Prominent among the British agents was Mr George E. Ferguson, a native of West Africa, who had previously explored northern Ashanti. Between 1892 and 1897 Ferguson concluded several treaties guarding British interests. In 1897 Lieutenant Henderson and Ferguson occupied Wa, where they were attacked by the *sofas* of Samory (see SENEGAL, § 3).

Henderson, who had gone to the *sefs* camp to parley, was held prisoner for some time, while Ferguson was killed. Meantime negotiations were opened in Europe to settle the spheres of influence of the respective countries. (The Anglo-French agreement of 1859 had fixed the boundaries of the hinterlands of the French colony of the Ivory Coast and the British colony of the Gold Coast as far as 9° N. only.) A period of considerable tension, arising from the proximity of British and French troops in the disputed territory, was ended by the signature of a convention in Paris (14th of June 1898), in which the western and northern boundaries were defined. The British abandoned their claim to the important town and district of Wagadugu in the north. In the following year (14th of November 1899) an agreement defining the eastern frontier was concluded with Germany. Previously a square block of territory to the north of 8° N. had been regarded as neutral, both by Britain and Germany. This was in virtue of an arrangement made in 1888. By the 1899 convention the neutral zone was parcelled out between the two powers. The delimitation of the frontiers agreed upon took place during 1900-1904.

In 1897 the Northern Territories were constituted a separate district of the Gold Coast hinterland, and were placed in charge of a chief commissioner. Colonel H. P. Northcott (killed in the Boer War, 1899-1902) was the first commissioner and commandant of the troops. He was succeeded by Col. A. H. Morris. In 1901 the Territories were made a distinct administration, under the jurisdiction of the governor of the Gold Coast colony. The government was at first of a semi-military character, but in 1907 a civilian staff was appointed to carry on the administration, and a force of armed constabulary replaced the troops which had been stationed in the protectorate and which were then disbanded. The prosperity of the country under British administration has been marked.

BIBLIOGRAPHY.—A good summary of the condition and history of the colony to the close of the 19th century will be found in vol. 3, "West Africa," of the *Historical Geography of the British Empire* by C. P. Lucas (2nd ed., Oxford, 1900). For current information see the *Gold Coast Civil Service List* (London, yearly), the annual Blue Books published in the colony, and the annual *Report* issued by the Colonial Office, London. For fuller information consult the *Report from the Select Committee on Africa (Western Coast)* (London, 1865), a mine of valuable information; *The Gold Coast, Past and Present*, by G. Macdonald (London, 1898); *History of the Gold Coast and Ashanti*, by C. C. Reinhardt, a native pastor (Basel, 1895); *A History of the Gold Coast*, by Col. A. B. Ellis (London, 1893); *Wanderings in West Africa* (London, 1863) and *To the Gold Coast for Gold* (London, 1883), both by Sir Richard Burton. Of the earlier books the most notable are *The Golden Coast or a Description of Gambia together with a relation of such persons as got wonderful estates by their trade thither* (London, 1665), and *A New and Accurate Description of the Coast of Guinea* written (in Dutch) by Willem Bosman, chief factor for the Dutch at Elmina (Eng. trans., 2nd ed., 1721). For a complete survey of the Gold Coast under Dutch control see "Die Niederländisch West-Indische Compagnie an der Gold-Küste" by J. G. Doornik in *Tijds Indische Taal-, Land- en Volkken*, vol. 40 (1898). For ethnography, religion, law, &c., consult *The Land of Fehik* (London, 1883) and *The Tshi-speaking Peoples of the West Coast of Africa* (London, 1887), both by Col. A. B. Ellis; *Fanti Customary Law* (2nd ed., London, 1904) and *Fanti Law Report* (London, 1904), both by J. M. Sarbah. The *Sketch of the Forestry of West Africa* by Sir Alfred Moloney (London, 1887) contains a comprehensive list of economic plants. See also *Report on Economic Agriculture on the Gold Coast* (Colonial Office Reports, No. 110, 1890), and *Papers relating to the Construction of Railways in . . . the Gold Coast* (London, 1904). The best map is that of Major F. G. Guggisberg, over 70 sheets, scale 1 : 125,000 (London, 1907-1909). There is a War Office map on the scale 1 : 1,000,000 in one sheet. See also the works quoted under ASHANTI.

For the Northern Territories see L. G. Binger, *Du Niger au Golf de Guinée* (Paris, 1892), a standard authority; H. P. Northcott, *Report on the Northern Territories of the Gold Coast* (War Office, London, 1899), a valuable compilation summarizing the then available information. Annual Reports on the protectorate are issued by the British Colonial Office. A map on the scale of 1 : 1,000,000 is issued by the War Office. (F. R. C.)

GOLDEN, a city and the county-seat of Jefferson county, Colorado, U. S. A., on Clear Creek (formerly called the Vasquez fork of the South Platte), about 14 m. W. by N. of Denver. Pop. (1900) 2152, (1910) 2477. Golden is a residential suburb of Denver, served by the Colorado & Southern, the Denver &

Intermountain (electric), and the Denver & North-Western Electric railways. It is about 5700 ft. above sea-level. About 600 ft. above the city is Castle Rock, with an amusement park, and W. of Golden is Lookout Mountain, a natural park of 3400 acres. About 1 m. S. of the city is a state industrial school for boys, and in Golden is the Colorado State School of Mines (opened 1874), which offers courses in mining engineering and metallurgical engineering. The Independent Pyritic Smelter is at Golden, and among the city's manufactures are pottery, firebrick and tile, made from clays found near by, and flour. There are deposits of coal, copper and gold in the vicinity. Truck-farming and the growing of fruit are important industries in the neighbourhood. The first settlement here was a gold mining camp, established in 1859, and named in honour of Tom Golden, one of the pioneer prospectors. The village was laid out in 1860, and Golden was incorporated as a town in 1865 and was chartered as a city in 1870. Golden was made the capital of Colorado Territory in 1862, and several sessions (or parts of sessions) of the Assembly were held here between 1864 and 1868, when the seat of government was formally established at Denver; the territorial offices of Colorado, however, were at Golden only in 1866-1867.

GOLDEN BULL (Lat. *Bulla Aurea*), the general designation of any charter decorated with a golden seal or *bulle*, either owing to the intrinsic importance of its contents, or to the rank and dignity of the bestower or the recipient. The custom of thus giving distinction to certain documents is said to be of Byzantine origin, though if this be the case it is somewhat strange that the word employed as an equivalent for golden bull in Byzantine Greek should be the hybrid χρυσόβουλον (cf. Codinus Cypriolates, *ὁ μέγας λογοθέτης διατάττει τὰ παρὰ τοῦ βασιλέως ἀποσταλλόμενα προσηγόμια καὶ χρυσόβουλλα πρὸς τοὺς Ῥήγας, Ζούλτανας, καὶ τοπάρχους*; and Anna Comnena, *Alexiad.*, lib. iii. βὰ χρυσόβουλου λόγου; lib. viii., χρυσόβουλον λόγου). In Germany a Golden Bull is mentioned under the reign of Henry I. the Fowler in *Chronica Cassin.* ii. 31, and the oldest German example, if it be genuine, dates from 983. At first the golden seal was formed after the type of a solid coin, but at a later date, while the golden surface presented to the eye was greatly increased, the seal was really composed of two thin metal plates filled in with wax. The number of golden bulls issued by the imperial chancery must have been very large; the city of Frankfort, for example, preserves no fewer than eight.

The name, however, has become practically restricted to a few documents of unusual political importance, the golden bull of the Empire, the golden bull of Brabant, the golden bull of Hungary and the golden bull of Milan—and of these the first is undoubtedly the Golden Bull *par excellence*. The main object of the Golden Bull was to provide a set of rules for the election of the German kings, or kings of the Romans, as they are called in this document. Since the informal establishment of the electoral college about a century before (see ELECTORS), various disputes had taken place about the right of certain princes to vote at the elections, these and other difficulties having arisen owing to the absence of any authoritative ruling. The spiritual electors, it is true, had exercised their votes without challenge, but far different was the case of the temporal electors. The families ruling in Saxony and in Bavaria had been divided into two main branches and, as the German states had not yet accepted the principles of primogeniture, it was uncertain which member of the divided family should vote. Thus, both the prince ruling in Saxe-Latzenburg and the prince ruling in Saxe-Wittenberg claimed the vote, and the two branches of the family of Wittelsbach, one settled in Bavaria and the other in the Rhenish palatinate, were similarly at variance, while the duke of Bavaria also claimed the vote at the expense of the king of Bohemia. Moreover, there had been several disputed and double elections to the German crown during the past century. In more than one instance a prince, chosen by a minority of the electors, had claimed to exercise the functions of king, and as often civil war had been the result. Under these circumstances the emperor Charles IV. determined by an

authoritative pronouncement to make such proceedings impossible in the future, and at the same time to add to his own power and prestige, especially in his capacity as king of Bohemia.

Having arranged various disputes in Germany, and having in April 1355 secured his coronation in Rome, Charles gave instructions for the bull to be drawn up. It is uncertain who is responsible for its actual composition. The honour has been assigned to Bartolo of Sassoferrato, professor of law at Pisa and Perugia, to the imperial secretary, Rudolph of Friedberg, and even to the emperor himself, but there is no valid authority for giving it to any one of the three in preference to the others. In its first form the bull was promulgated at the diet of Nuremberg on the 10th of January 1356, but it was not accepted by the princes until some modifications had been introduced, and in its final form it was issued at the diet of Metz on the 25th of December following.

The text of the Golden Bull consists of a prologue and of thirty-one chapters. Some lines of verse invoking the aid of Almighty God are followed by a rhetorical statement of the evils which arise from discord and division, illustrations being taken from Adam, who was divided from obedience and thus fell, and from Helen of Troy who was divided from her husband. The early chapters are mainly concerned with details of the elaborate ceremonies which are to be observed on the occasion of an election. The number of electors is fixed at seven, the duke of Saxe-Wittenberg, not the duke of Saxe-Lauenburg, receiving the Saxon vote, and the count palatine, not the duke of Bavaria, obtaining the vote of the Wittelsbachs. The electors were arranged in order of precedence thus: the archbishops of Mainz, of Trier and of Cologne, the king of Bohemia, *qui inter electores laicos ex regia dignitate fastigio jure et merito obtinet primatiam*, the count palatine of the Rhine, the duke of Saxony and the margrave of Brandenburg. The three archbishops were respectively arch-chancellors of the three principal divisions of the Empire, Germany, Arles and Italy, and the four secular electors each held an office in the imperial household, the functions of which they were expected to discharge on great occasions. The king of Bohemia was the arch-cupbearer, the count palatine was the arch-steward (*dapifer*), the duke of Saxony was arch-marshal, and the margrave of Brandenburg was arch-chamberlain. The work of summoning the electors and of presiding over their deliberations fell to the archbishop of Mainz, but if he failed to discharge this duty the electors were to assemble without summons within three months of the death of a king. Elections were to be held at Frankfurt; they were to be decided by a majority of votes, and the subsequent coronation at Aix-la-Chapelle was to be performed by the archbishop of Cologne. During a vacancy in the Empire the work of administering the greater part of Germany was entrusted to the count palatine of the Rhine, the duke of Saxony being responsible, however, for the government of Saxony, or rather for the districts *ubi Saxonica jura servantur*.

The chief result of the bull was to add greatly to the power of the electors; for, to quote Bryce (*Holy Roman Empire*), it "confessed and legalized the independence of the electors and the powerlessness of the crown." To these princes were given sovereign rights in their dominions, which were declared indivisible and were to pass according to the rule of primogeniture. Except in extreme cases, there was to be no appeal from the sentences of their tribunals, and they were confirmed in the right of coining money, of taking tolls, and in other privileges, while conspirators against their lives were to suffer the penalties of treason. One clause gave special rights and immunities to the king of Bohemia, who, it must be remembered, at this time was Charles himself, and others enjoined the observance of the public peace. Provision was made for an annual meeting of the electors, to be held at Metz four weeks after Easter, when matters *pro bono et salute communi* were to be discussed. This arrangement, however, was not carried out, although the electors met occasionally. Another clause forbade the cities to receive *Pfahlbürger*, i.e. forbade them to take men dwelling outside their walls under their protection. It may be noted that there is no admission

whatever that the election of a king needs confirmation from the pope.

The Golden Bull was thus a great victory for the electors, but it weakened the position of the German king and was a distinct humiliation for the other princes and for the cities. The status of those rulers who did not obtain the electoral privilege was lowered by this very fact, and the regulations about the *Pfahlbürger*, together with the prohibition of new leagues and associations, struck a severe blow at the cities. The German kings were elected according to the conditions laid down in the bull until the dissolution of the Empire in 1806. At first the document was known simply as the *Lex Carolina*; but gradually the name of the Book with the Golden Bull came into use, and the present elliptical title was sufficiently established by 1417 to be officially employed in a charter by King Sigismund. The original autograph was committed to the care of the elector of Mainz, and it was preserved in the archives at Mainz till 1789. Official transcripts were probably furnished to each of the seven electors at the time of the promulgation, and before long many of the other members of the Empire secured copies for themselves. The transcript which belonged to the elector of Trier is preserved in the state archives at Stuttgart, that of the elector of Cologne in the court library at Darmstadt, and that of the king of Bohemia in the imperial archives at Vienna. Berlin, Munich and Dresden also boast the possession of an electoral transcript; and the town of Kitzingen has a contemporary copy in its municipal archives. There appears, however, to be good reason to doubt the genuineness of most of these so-called original transcripts. But perhaps the best known example is that of Frankfurt-on-Main, which was procured from the imperial chancery in 1366, and is adorned with a golden seal like the original. Not only was it regularly quoted as the indubitable authority in regard to the election of the emperors in Frankfurt itself, but it was from time to time officially consulted by members of the Empire.

The manuscript consists of 43 leaves of parchment of medium quality, each measuring about 10½ in. in height by 7½ in breadth. The seal is of the plate and wax type. On the obverse appears a figure of the emperor seated on his throne, with the sceptre in his right hand and the globe in his left; a shield, with the crowned imperial eagle, occupies the space on the one side of the throne, and a corresponding shield, with the crowned Bohemian lion with two tails, occupies the space on the other side; and round the margin runs the legend, *Karolus quartus divina favente clementia, Romanorum imperator semper Augustus et Boemiarum rex*. On the reverse is a castle, with the words *Aurea Roma* on the gate, and the circumscription reads, *Roma caput mundi resipit orbis frenus rotundi*. The original Latin text of the bull was printed at Nuremberg by Friedrich Cressner in 1474, and a second edition by Anthonius Koburger (d. 1532) appeared at the same place in 1477. Since that time it has been frequently reprinted from various manuscripts and collections. M. Goldast gave the Palatine text, compared with those of Bohemia and Frankfurt, in his *Collectio constitutionum et legum imperialis* (Frankfurt, 1613). Another is to be found in *De comitibus imperii* of O. Panvinius, and a third, of unknown history, is prefixed to the *Codex sassanus Imperii* (Mainz, 1599, and again 1615). The Frankfurt text appeared in 1742 as *Aurea Bulla secundum exemplar originale Frankfurtense*, edited by W. C. Miltz, and the text is also found in J. J. Schmauss, *Corpus juris publici*, edited by R. von Hommel (Leipzig, 1794), and in the *Ausgewählte Urkunden zur Erläuterung der Verfassungsgeschichte Deutschlands im Mittelalter*, edited by W. Altmann and E. Bernheim (Berlin, 1891, and again 1895). German translations, none of which, however, had any official authority, were published at Nuremberg about 1474, at Venice in 1476, and at Strasburg in 1485. Among the earlier commentators on the document are H. Canisius and J. Limmaeus who wrote *In Auream Bullam* (Strasburg, 1662). The student will find a good account of the older literature on the subject in C. G. Biener's *Commentarii de origine et progressu legum jurisque Germaniae* (1787-1795). See also J. D. von Oleneschläger, *Neue Erläuterungen der Goldenen Bulle* (Frankfurt and Leipzig, 1766); H. G. von Thulemeyer, *De Bulla Aurea, Argentica, &c.* (Heidelberg, 1682); J. St. Pütter, *Historische Entwicklung der heutigen Staatsverfassung des deutschen Reichs* (Göttingen, 1786-1787), and O. Stobbe, *Geschichte der deutschen Rechtsquellen* (Brunswick, 1860-1864). Among the more modern works may be mentioned: E. Nerges, *Die Goldne Bulle nach ihrem Ursprung* (Göttingen, 1877), O. Hahn, *Ursprung und Bedeutung der Goldenen Bulle* (Breslau, 1903); and M. C. Schmidt, *Die staatsrechtliche Anwendung der Goldenen Bulle* (Halle, 1894). There is a valuable contribution to the subject in the *Quellensammlung zur Geschichte der deutschen Reichsverfassung*, edited by K. Zeumer (Leipzig, 1904), and

another by O. Harnack in his *Das Kurfürsten Kollegium bis zur Mitte des 17ten Jahrhunderts* (Giessen, 1883). There is an English translation of the bull in E. F. Henderson's *Select Historical Documents of the Middle Ages* (London, 1903). (A. W. H.)*

GOLDEN-EYE, a name indiscriminately given in many parts of Britain to two very distinct species of ducks, from the rich yellow colour of their irides. The commonest of them—the *Anas fuligula* of Linnaeus and *Fuligula cristata* of most modern ornithologists—is, however, usually called by English writers the tufted duck, while "golden-eye" is reserved in books for the *A. clangula* and *A. glaucion* of Linnaeus, who did not know that the birds he so named were but examples of the same species, differing only in age or sex; and to this day many fowlers perpetuate a like mistake, deeming the "Morillon," which is the female or young male, distinct from the "Golden-eye" or "Rattle-wings" (as from its noisy flight they oftener call it), which is the adult male. This species belongs to the group known as diving ducks, and is the type of the very well-marked genus *Clangula* of later systematists, which, among other differences, has the posterior end of the sternum prolonged so as to extend considerably over, and, we may not unreasonably suppose, protect the belly—a character possessed in a still greater degree by the mergansers (*Merginae*), while the males also exhibit in the extraordinarily developed bony labyrinth of their trachea and its midway enlargement another resemblance to the members of the same subfamily. The golden-eye, *C. glaucion* of modern writers, has its home in the northern parts of both hemispheres, whence in winter it migrates southward; but as it is one of the ducks that constantly resorts to hollow trees for the purpose of breeding it hardly transcends the limit of the Arctic forests on either continent. So well known is this habit to the people of the northern districts of Scandinavia, that they very commonly devise artificial nest-boxes for its accommodation and their own profit. Hollow logs of wood are prepared, the top and bottom closed, and a hole cut in the side. These are affixed to the trunks of living trees in suitable places, at a convenient distance from the ground, and, being readily occupied by the birds in the breeding-season, are regularly robbed, first of the numerous eggs, and finally of the down they contain, by those who have set them up.

The adult male golden-eye is a very beautiful bird, mostly black above, but with the head, which is slightly crested, reflecting rich green lights, a large oval white patch under each eye and elongated white scapulars; the lower parts are wholly white and the feet bright orange, except the webs, which are dusky. In the female and young male, dark brown replaces the black; the cheek-spots are indistinct and the elongated white scapulars wanting. The golden-eye of North America has been by some authors deemed to differ, and has been named *C. americana*, but apparently on insufficient grounds. North America, however, has, in common with Iceland, a very distinct species, *C. islandica*, often called Barrow's duck, which is but a rare straggler to the continent of Europe, and never, so far as known, to Britain. In Iceland and Greenland it is the only habitual representative of the genus, and it occurs from thence to the Rocky Mountains. In breeding-habits it differs from the commoner species, not placing its eggs in tree-holes; but how far this difference is voluntary may be doubted, for in the countries it frequents trees are wanting. It is a larger and stouter bird, and in the male the white cheek-patches take a more crescentic form, while the head is glossed with purple rather than green, and the white scapulars are not elongated. The New World also possesses a third and still more beautiful species of the genus in *C. albicollis*, known in books as the buff-headed duck, and to American fowlers as the "spirit-duck" and "butter-ball"—the former name being applied from its rapidity in diving, and the latter from its exceeding fatness in autumn. This is of small size, but the lustre of the feathers in the male is most brilliant, exhibiting a deep plum-coloured gloss on the head. It breeds in trees, and is supposed to have occurred more than once in Britain. (A. N.)

GOLDEN FLEECE, in Greek mythology, the fleece of the ram on which Phrixus and Helle escaped, for which see

ARGONAUTS. For the modern order of the Golden Fleece, see **KNIGHTHOOD AND CHIVALRY**, section *Orders of Knighthood*.

GOLDEN HORDE, the name of a body of Tatars who in the middle of the 13th century overran a great portion of eastern Europe and founded in Russia the Tatar empire of khanate known as the Empire of the Golden Horde or Western Kipchaks. They invaded Europe about 1237 under the leadership of Batu Khan, a younger son of Juji, eldest son of Jenghis Khan, passed over Russia with slaughter and destruction, and penetrated into Silesia, Poland and Hungary, finally defeating Henry II., duke of Silesia, at Liegnitz in the battle known as the Wahlstatt on the 9th of April 1241. So costly was this victory, however, that Batu, finding he could not reduce Neustadt, retraced his steps and established himself in his magnificent tent (whence the name "golden") on the Volga. The new settlement was known as *Sir Orda* ("Golden Camp," whence "Golden Horde"). Very rapidly the powers of Batu extended over the Russian princes, and so long as the khanate remained in the direct descent from Batu nothing occurred to check the growth of the empire. The names of Batu's successors are Sartak (1256), Bereke (Baraka) (1256-1266), Mangū-Timūr (1266-1280), Tuda Mangū (1280-1287), (?) Tula Bughā (1287-1290), Tōktā (1290-1312), Ūzbeġ (1312-1340), Tin-Beg (1340), Jāni-Beg (1340-1357). The death of Jāni-Beg, however, threw the empire into confusion. Birdi-Beg (Berdī-Beg) only reigned for two years, after which two rulers, calling themselves sons of Jāni-Beg occupied the throne during one year. From that time (1359) till 1378 no single ruler held the whole empire under control, various members of the other branches of the old house of Juji assuming the title. At last in 1378 Tōktā-mish, of the Eastern Kipchaks, succeeded in ousting all rivals, and establishing himself as ruler of eastern and western Kipchak. For a short time the glory of the Golden Horde was renewed, until it was finally crushed by Timur in 1395.

See further **MONGOLS AND RUSSIA**; Sir Henry Howorth's *History of the Mongols*; S. Lane-Poole's *Mohammedan Dynasties* (1894), pp. 222-231; for the relations of the various descendants of Jenghis, see Stockvis, *Manuel d'histoire*, vol. i. chap. ix. table 7.

GOLDEN ROD, in botany, the popular name for *Solidago virgaurea* (natural order Compositae), a native of Britain and widely distributed in the north temperate region. It is an old-fashioned border-plant flowering from July to September, with an erect, sparingly-branched stem and small bright-yellow clustered heads of flowers. It grows well in common soil and is readily propagated by division in the spring or autumn.

GOLDEN ROSE (*rosa aurea*), an ornament made of wrought gold and set with gems, generally sapphires, which is blessed by the pope on the fourth (*Laetare*) Sunday of Lent, and usually afterwards sent as a mark of special favour to some distinguished individual, to a church, or a civil community. Formerly it was a single rose of wrought gold, coloured red, but the form finally adopted is a thorny branch with leaves and flowers, the petals of which are decked with gems, surmounted by one principal rose. The origin of the custom is obscure. From very early times popes have given away a rose on the fourth Sunday of Lent, whence the name *Dominica Rosa*, sometimes given to this feast. The practice of blessing and sending some such symbol (*e.g. eulogiae*) goes back to the earliest Christian antiquity, but the use of the rose itself does not seem to go farther back than the 17th century. According to some authorities it was used by Leo IX. (1049-1054), but in any case Pope Urban II. sent one to Fulk of Anjou during the preparations for the first crusade. Pope Urban V., who sent a golden rose to Joanna of Naples in 1366, is alleged to have been the first to determine that one should be consecrated annually. Beginning with the 16th century there went regularly with the rose a letter relating the reasons why it was sent, and reciting the merits and virtues of the receiver. When the change was made from the form of the simple rose to the branch is uncertain. The rose sent by Innocent IV. in 1244 to Count Raymond Berengar IV. of Provence was a simple flower without any accessory ornamentation, while the one given by Benedict XI. in 1303 or 1304 to the

church of St Stephen at Perugia consisted of a branch garnished with five open and two closed roses enriched with a sapphire, the whole having a value of seventy ducats. The value of the gift varied according to the character or rank of the recipient. John XXII. gave away some weighing 12 oz., and worth from £250 to £325. Among the recipients of this honour have been Henry VI. of England, 1446; James III. of Scotland, on whom the rose (made by Jacopo Magnolio) was conferred by Innocent VIII.; James IV. of Scotland; Frederick the Wise, elector of Saxony, who received a rose from Leo X. in 1518; Henry VIII. of England, who received three, the last from Clement VII. in 1524 (each had nine branches, and rested on different forms of feet, one on oxen, the second on acorns, and the third on lions); Queen Mary, who received one in 1555 from Julius III.; the republic of Lucca, so favoured by Pius IV., in 1564; the Lateran Basilica by Pius V. three years later; the sanctuary of Loreto by Gregory XIII. in 1584; Maria Theresa, queen of France, who received it from Clement IX. in 1668; Mary Casimir, queen of Poland, from Innocent XI. in 1684 in recognition of the deliverance of Vienna by her husband, John Sobieski; Benedict XIII. (1726) presented one to the cathedral of Capua, and in 1833 it was sent by Gregory XVI. to the church of St Mark's, Venice. In more recent times it was sent to Napoleon III. of France, the empress Eugénie, and the queens Isabella II., Christina (1886) and Victoria (1906) of Spain. The gift of the golden rose used almost invariably to accompany the coronation of the king of the Romans. If in any particular year no one is considered worthy of the rose, it is laid up in the Vatican.

Some of the most famous Italian goldsmiths have been employed in making the earlier roses; and such intrinsically valuable objects have, in common with other priceless historical examples of the goldsmiths' art, found their way to the melting-pot. It is, therefore, not surprising that the number of existing historic specimens is very small. These include one of the 14th century in the Cluny Museum, Paris, believed to have been sent by Clement V. to the prince-bishop of Basel; another conferred in 1458 on his native city of Siena by Pope Pius II.; and the rose bestowed upon Siena by Alexander VII., a son of that city, which is depicted in a procession in a fresco in the Palazzo Pubblico at Siena. The surviving roses of more recent date include that presented by Benedict XIII. to Capua cathedral; the rose conferred on the empress Caroline by Pius VII., 1819, at Vienna; one of 1833 (Gregory XVI.) at St Mark's, Venice; and Pope Leo XIII.'s rose sent to Queen Christina of Spain, which is at Madrid.

AUTHORITIES.—Angelo Rocca, *Aurea Rosa*, &c. (1719); Busenelli, *De Rosa Aurea. Epistola* (1759); Girbal, *La Rosa de oro* (Madrid, 1820); C. Joret, *La Rose d'or dans l'antiquité et au moyen âge* (Paris, 1892), pp. 432-435; Eugène Muntz in *Revue d'art chrétien* (1901), series v. vol. 12 pp. 1-11; De F. Mely, *Le Trésor de Chartres* (1886); Marquis de Mac Swiney Maahanaglaan, *Le Portugal et le Saint Siège: Les Roses d'or envoyées par les Papes aux rois de Portugal au XVI^e siècle* (1904); Sir C. Young, *Ornaments and Gift consecrated by the Roman Pontiffs: the Golden Rose, the Cap and Swords presented to Sovereigns of England and Scotland* (1864).

(J. T. S.*; E. A. J.)

GOLDEN RULE, the term applied in all European languages to the rule of conduct laid down in the New Testament (Matthew vii. 12 and Luke vi. 31), "whatsoever ye would that men should do to you, do ye even so to them, for this is the law and the prophets." This principle has often been stated as the fundamental precept of social morality. It is sometimes put negatively or passively, "do not that to another which thou wouldst not have done to thyself" (cf. Hobbes, *Leviathan*, xv. 79, xvii. 85), but it should be observed that in this form it implies merely abstention from evil doing. In either form the precept in ordinary application is part of a hedonistic system of ethics, the criterion of action being strictly utilitarian in character.

See H. Sidgwick, *History of Ethics* (5th ed., 1902), p. 167; James Seth, *Ethical Principles*, p. 97 foll.

GOLDFIELD, a town and the county-seat of Esmeralda county, Nevada, U.S.A., about 170 m. S.E. of Carson City. Pop. (1910, U. S. census) 4838. It is served by the Tonopah & Goldfield, Las Vegas & Tonopah, and Tonopah & Tidewater

railways. The town lies in the midst of a desert abounding in high-grade gold ores, and is essentially a mining camp. The discovery of gold at Tonopah, about 28 m. N. of Goldfield, in 1900 was followed by its discovery at Goldfield in 1902 and 1903; in 1904 the Goldfield district produced about 800 tons of ore, which yielded \$2,300,000 worth of gold, or 30% of that of the state. This remarkable production caused Goldfield to grow rapidly, and it soon became the largest town in the state. In addition to the mines, there are large reduction works. In 1907 Goldfield became the county-seat. The gold output in 1907 was \$8,408,396; in 1908, \$4,880,251. Soon after mining on an extensive scale began, the miners organized themselves as a local branch of the Western Federation of Miners, and in this branch were included many labourers in Goldfield other than miners. Between this branch and the mine-owners there arose a series of more or less serious differences, and there were several set strikes—in December 1906 and January 1907, for higher wages; in March and April 1907, because the mine-owners refused to discharge carpenters who were members of the American Federation of Labour, but did not belong to the Western Federation of Miners or to the Industrial Workers of the World affiliated with it, this last organization being, as a result of the strike, forced out of Goldfield; in August and September 1907, because a rule was introduced at some of the mines requiring miners to change their clothing before entering and after leaving the mines,—a rule made necessary, according to the operators, by the wholesale stealing (in miners' parlance, "high-grading") of the very valuable ore (some of it valued at as high as \$20 a pound); and in November and December 1907, because some of the mine-owners, avowedly on account of the hard times, adopted a system of paying in cashier's checks. Excepting occasional attacks upon non-union workmen, or upon persons supposed not to be in sympathy with the miners' union, there had been no serious disturbance in Goldfield; but in December 1907, Governor Sparks, at the instance of the mine-owners, appealed to President Roosevelt to send Federal troops to Goldfield, on the ground that the situation there was ominous, that destruction of life and property seemed probable, and that the state had no militia and would be powerless to maintain order. President Roosevelt thereupon (December 4th) ordered General Frederick Funston, commanding the Division of California, at San Francisco, to proceed with 300 Federal troops to Goldfield. The troops arrived in Goldfield on the 6th of December, and immediately afterwards the mine-owners reduced wages and announced that no members of the Western Federation of Miners would thereafter be employed in the mines. President Roosevelt, becoming convinced that conditions had not warranted Governor Sparks's appeal for Federal assistance, but that the immediate withdrawal of the troops might nevertheless lead to serious disorders, consented that they should remain for a short time on condition that the state should immediately organize an adequate militia or police force. Accordingly, a special meeting of the legislature was immediately called, a state police force was organized, and on the 7th of March 1908 the troops were withdrawn. Thereafter work was gradually resumed in the mines, the contest having been won by the mine-owners.

GOLDFINCH (Ger. *Goldfink*), the *Fringilla carduelis* of Linnaeus and the *Carduelis elegans* of later authors, an extremely well-known bird found over the greater parts of Europe and North Africa, and eastwards to Persia and Turkestan. Its gay plumage is matched by its sprightly nature; and together they make it one of the most favourite cage-birds among all classes. As a songster it is indeed surpassed by many other species, but its docility and ready attachment to its master or mistress make up for any defect in its vocal powers. In some parts of England the trade in goldfinches is very considerable. In 1860 Mr Hussey reported (*Zool.*, p. 7144) the average annual captures near Worthing to exceed 11,000 dozens—nearly all being cock-birds; and a witness before a committee of the House of Commons in 1873 stated that, when a boy, he could take forty

*The more common German name, however, is *Distelfink* (Thistle-Finch) or *Stieglitz*.

dozens in a morning near Brighton. In these districts and others the number has become much reduced, owing doubtless in part to the fatal practice of catching the birds just before or during the breeding-season; but perhaps the strongest cause of their growing scarcity is the constant breaking-up of waste lands, and the extirpation of weeds (particularly of the order *Compositae*) essential to the improved system of agriculture; for in many parts of Scotland, East Lothian for instance, where goldfinches were once as plentiful as sparrows, they are now only rare stragglers, and yet there they have not been thinned by netting. Though goldfinches may occasionally be observed in the coldest weather, incomparably the largest number leave Britain in autumn, returning in spring, and resorting to gardens and orchards to breed, when the lively song of the cock, and the bright yellow wings of both sexes, quickly attract notice. The nest is a beautifully neat structure, often placed at no great height from the ground, but generally so well hidden by the leafy bough on which it is built as not to be easily found, until the young being hatched, the constant visits of the parents reveal its site. When the broods leave the nest they move into the more open country, and frequenting pastures, commons, heaths and downs, assemble in large flocks towards the end of summer. Eastward of the range of the present species its place is taken by its congener *C. caniceps*, which is easily recognized by wanting the black hood and white ear-coverts of the British bird. Its home seems to be in Central Asia, but it moves southward in winter, being common at that season in Cashmere, and is not unfrequently brought for sale to Calcutta. The position of the genus *Carduelis* in the family *Fringillidae* is not very clear. Structurally it would seem to have some relation to the siskins (*Chrysomitris*), though the members of the two groups have very different habits, and perhaps its nearest kinship lies with the larks (*Coccothraustes*). See FINCH. (A. N.)

GOLDFISH (*Cyprinus* or *Carassius auratus*), a small fish belonging to the Cyprinid family, a native of China but natur-

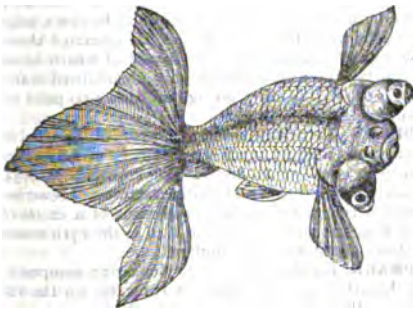

Telescope-fish.

alized in other countries. In the wild state its colours do not differ from those of a Crucian carp, and like that fish it is tenacious of life and easily domesticated. Albinos seem to be rather common; and as in other fishes (for instance, the tench, carp, eel, flounder), the colour of most of these albinos is a bright orange or golden yellow; occasionally even this shade of colour is lost, the fish being more or less pure white or silvery. The Chinese have domesticated these albinos for a long time, and by careful selection have succeeded in propagating all those strange varieties, and even monstrosities, which appear in every domestic animal. In some individuals the dorsal fin is only half its normal length, in others entirely absent; in others the anal fin has a double spine; in others all the fins are of nearly double the usual length. The snout is frequently malformed, giving the head of the fish an appearance similar to that of a bull-dog. The variety most highly prized has an extremely short snout, eyes which almost wholly project beyond the orbit, no dorsal fin, and a very long three- or four-lobed caudal fin (Telescope-fish).

The domestication of the goldfish by the Chinese dates back from the highest antiquity, and they were introduced into Japan at the beginning of the 16th century; but the date of their importation into Europe is still uncertain. The great German ichthyologist, M. E. Bloch, thought he could trace it back in England to the reign of James I., whilst other authors fix the date at 1691. It appears certain that they were brought to France, only much later, as a present to Mme de Pompadour, although the de Goncourts, the historians of the mistresses of Louis XV., have failed to trace any records of this event. The fish has since spread over a considerable part of Europe, and in many places it has reverted to its wild condition. In many parts of south-eastern Asia, in Mauritius, in North and South Africa, in Madagascar, in the Azores, it has become thoroughly acclimatized, and successfully competes with the indigenous fresh-water fishes. It will not thrive in rivers; in large ponds it readily reverts to the coloration of the original wild stock. It flourishes best in small tanks and ponds, in which the water is constantly changing and does not freeze; in such localities, and with a full supply of food, which consists of weeds, crumbs of bread, bran, worms, small crustaceans and insects, it attains to a length of from 6 to 12 in., breeding readily, sometimes at different times of the same year.

GOLDFUSS, GEORG AUGUST (1782-1848), German palaeontologist, born at Thurau near Bayreuth on the 18th of April 1782, was educated at Erlangen, where he graduated Ph.D. in 1804 and became professor of zoology in 1818. He was subsequently appointed professor of zoology and mineralogy in the university of Bonn. Aided by Count G. Münster he issued the important *Petrefacta Germaniae* (1826-1844), a work which was intended to illustrate the invertebrate fossils of Germany, but it was left incomplete after the sponges, corals, crinoids, echinoids and part of the mollusca had been figured. Goldfuss died at Bonn on the 2nd of October 1848.

GOLDIE, SIR GEORGE DASHWOOD TAUBMAN (1846-), English administrator, the founder of Nigeria, was born on the 20th of May 1846 at the Nunnery in the Isle of Man, being the youngest son of Lieut.-Colonel John Taubman Goldie-Taubman, speaker of the House of Keys, by his second wife Caroline, daughter of John E. Hoveden of Hemingford, Cambridgeshire. Sir George resumed his paternal name, Goldie, by royal licence in 1887. He was educated at the Royal Military Academy, Woolwich, and for about two years held a commission in the Royal Engineers. He travelled in all parts of Africa, gaining an extensive knowledge of the continent, and first visited the country of the Niger in 1877. He conceived the idea of adding to the British empire the then little known regions of the lower and middle Niger, and for over twenty years his efforts were devoted to the realization of this conception. The method by which he determined to work was the revival of government by chartered companies within the empire—a method supposed to be buried with the East India Company. The first step was to combine all British commercial interests in the Niger, and this he accomplished in 1879 when the United African Company was formed. In 1881 Goldie sought a charter from the imperial government (the 2nd Gladstone ministry). Objections of various kinds were raised. To meet them the capital of the company (renamed the National African Company) was increased from £125,000 to £1,000,000, and great energy was displayed in founding stations on the Niger. At this time French traders, encouraged by Gambetta, established themselves on the lower river, thus rendering it difficult for the company to obtain territorial rights; but the Frenchmen were bought out in 1884, so that at the Berlin conference on West Africa in 1885 Mr Goldie, present as an expert on matters relating to the river, was able to announce that on the lower Niger the British flag alone flew. Meantime the Niger coast line had been placed under British protection. Through Joseph Thomson, David McIntosh, D. W. Sargent, J. Flint, William Wallace, E. Dangerfield and numerous other agents, over 400 political treaties—drawn up by Goldie—were made with the chiefs of the lower Niger and the Hausa states. The scruples of the British government being overcome, a charter was at length granted

(July 1886), the National African Company becoming the Royal Niger Company, with Lord Aberdare as governor and Goldie as vice-governor. In 1895, on Lord Aberdare's death, Goldie became governor of the company, whose destinies he had guided throughout.

The building up of Nigeria as a British state had to be carried on in face of further difficulties raised by French travellers with political missions, and also in face of German opposition. From 1884 to 1890, Prince Bismarck was a persistent antagonist, and the strenuous efforts he made to secure for Germany the basin of the lower Niger and Lake Chad were even more dangerous to Goldie's schemes of empire than the ambitions of France. Herr E. R. Flegel, who had travelled in Nigeria during 1882-1884 under the auspices of the British company, was sent out in 1885 by the newly-formed German Colonial Society to secure treaties for Germany, which had established itself at Cameroon. After Flegel's death in 1886 his work was continued by his companion Dr Staudinger, while Herr Hoenigsberg was despatched to stir up trouble in the occupied portions of the Company's territory,—or, as he expressed it, "to burst up the charter." He was finally arrested at Onitsha, and, after trial by the company's supreme court at Asaba, was expelled the country. Prince Bismarck then sent out his nephew, Herr von Puttkamer, as German consul-general to Nigeria, with orders to report on this affair, and when this report was published in a White Book, Bismarck demanded heavy damages from the company. Meanwhile Bismarck maintained constant pressure on the British government to compel the Royal Niger Company to a division of spheres of influence, whereby Great Britain would have lost a third, and the most valuable part, of the company's territory. But he fell from power in March 1890, and in July following Lord Salisbury concluded the famous "Heligoland" agreement with Germany. After this event the aggressive action of Germany in Nigeria entirely ceased, and the door was opened for a final settlement of the Nigeria-Cameroon frontiers. These negotiations, which resulted in an agreement in 1893, were initiated by Goldie as a means of arresting the advance of France into Nigeria from the direction of the Congo. By conceding to Germany a long but narrow strip of territory between Adamawa and Lake Chad, to which she had no treaty claims, a barrier was raised against French expeditions, semi-military and semi-exploratory, which sought to enter Nigeria from the east. Later French efforts at aggression were made from the western or Dahomeyan side, despite an agreement concluded with France in 1890 respecting the northern frontier.

The hostility of certain Fula princes led the company to despatch, in 1897, an expedition against the Mahommedan states of Nupé and Ilorin. This expedition was organized and personally directed by Goldie and was completely successful. Internal peace was thus secured, but in the following year the differences with France in regard to the frontier line became acute, and compelled the intervention of the British government. In the negotiations which ensued Goldie was instrumental in preserving for Great Britain the whole of the navigable stretch of the lower Niger. It was, however, evidently impossible for a chartered company to hold its own against the state-supported protectorates of France and Germany, and in consequence, on the 1st of January 1900, the Royal Niger Company transferred its territories to the British government for the sum of £865,000. The ceded territory together with the small Niger Coast Protectorate, already under imperial control, was formed into the two protectorates of northern and southern Nigeria (see further NIGERIA).

In 1903-1904, at the request of the Chartered Company of South Africa, Goldie visited Rhodesia and examined the situation in connexion with the agitation for self-government by the Rhodesians. In 1902-1903 he was one of the royal commissioners who inquired into the military preparations for the war in South Africa (1899-1902) and into the operations up to the occupation of Pretoria, and in 1905-1906 was a member of the royal commission which investigated the methods of disposal of war stores after peace had been made. In 1905 he was elected president of the Royal Geographical Society and held that office for three years. In 1908 he was chosen an alderman of the London County

Council. Goldie was created K.C.M.G. in 1887, and a privy councillor in 1898. He became an F.R.S., honorary D.C.L. of Oxford University (1897) and honorary LL.D. of Cambridge (1897). He married in 1870 Matilda Catherine (d. 1898), daughter of John William Elliott of Wakefield.

GOLDING, ARTHUR (c. 1536-c. 1605), English translator, son of John Golding of Belchamp St Paul and Halsted, Essex, one of the auditors of the exchequer, was born probably in London about 1536. His half-sister, Margaret, married John de Vere, 16th earl of Oxford. In 1549 he was already in the service of Protector Somerset, and the statement that he was educated at Queen's College, Cambridge, lacks corroboration. He seems to have resided for some time in the house of Sir William Cecil, in the Strand, with his nephew, the poet, the 17th earl of Oxford, whose receiver he was, for two of his dedications are dated from Cecil House. His chief work is his translation of Ovid. *The First Fower Bookes of P. Ovidius Nasos worke, entitled Metamorphosis, translated oute of Latin into Englishe meter* (1565), was supplemented in 1567 by a translation of the fifteen books. Strangely enough the translator of Ovid was a man of strong Puritan sympathies, and he translated many of the works of Calvin. To his version of the *Metamorphoses* he prefixed a long metrical explanation of his reasons for considering it a work of edification. He sets forth the moral which he supposes to underlie certain of the stories, and shows how the pagan machinery may be brought into line with Christian thought. It was from Golding's pages that many of the Elizabethans drew their knowledge of classical mythology, and there is little doubt that Shakespeare was well acquainted with the book. Golding translated also the *Commentaries* of Caesar (1565), Calvin's commentaries on the Psalms (1571), his sermons on the Galatians and Ephesians, on Deuteronomy and the book of Job, Theodore Beza's *Tragedie of Abrahams Sacrifice* (1577) and the *De Beneficiis* of Seneca (1578). He completed a translation begun by Sidney from Philippe de Mornay, *A Worke concerning the Trewnesse of the Christian Religion* (1604). His only original work is a prose *Discourse* on the earthquake of 1580, in which he saw a judgment of God on the wickedness of his time. He inherited three considerable estates in Essex, the greater part of which he sold in 1595. The last trace we have of Golding is contained in an order dated the 25th of July 1605, giving him licence to print certain of his works.

GOLDINGEN (Lettish, *Kuldiga*), a town of Russia, in the government of Courland, 55 m. by rail N.E. of Libau, and on Windau river, in 56° 58' N. and 22° E. Pop. (1897) 9733. It has woollen mills, needle and match factories, breweries and distilleries, a college for teachers, and ruins of a castle of the Teutonic Knights, built in 1248 and used in the 17th century as the residence of the dukes of Courland.

GOLDMARK, KARL (1832-), Hungarian composer, was born at Keszthely-am-Plattensee, in Hungary, on the 18th of May 1832. His father, a poor cantor in the local Jewish synagogue, was unable to assist to any extent financially in the development of his son's talents. Yet in the household much music was made, and on a cheap violin and home-made flute, constructed by Goldmark himself from reeds cut from the river-bank, the future composer gave rein to his musical ideas. His talent was fostered by the village schoolmaster, by whose aid he was able to enter the music-school of the Oedenburger Verein. Here he remained but a short time, his success at a school concert finally determining his parents to allow him to devote himself entirely to music. In 1844, then, he went to Vienna, where Jansa took up his cause and eventually obtained for him admission to the conservatorium. For two years Goldmark worked under Jansa at the violin, and on the outbreak of the revolution, after studying all the orchestral instruments he obtained an engagement in the orchestra at Raab. There, on the capitulation of Raab, he was to have been shot for a spy, and was only saved at the eleventh hour by the happy arrival of a former colleague. In 1850 Goldmark left Raab for Vienna, where from his friend Mittrich he obtained his first real knowledge of the classics. There, too, he devoted himself to composition. In 1857 Goldmark

who was then engaged in the Karl-theater band, gave a concert of his own works with such success that his first quartet attracted very general attention. Then followed the "Sakuntala" and "Pentheles" overtures, which show how Wagner's influence had supervened upon his previous domination by Mendelssohn, and the delightful "Ländliche Hochzeit" symphony, which carried his fame abroad. Goldmark's reputation was now made, and very largely increased by the production at Vienna in 1875 of his first and best opera, *Die Königin von Saba*. Over this opera he spent seven years. Its popularity is still almost as great as ever. It was followed in November 1886, also at Vienna, by *Merlin*, much of which has been re-written since then. A third opera, a version of Dickens's *Cricket on the Hearth*, was given by the Royal Carl Rosa Company in London in 1900. Goldmark's chamber music has not made much lasting impression, but the overtures "Im Frühling," "Prometheus Bound," and "Sappho" are fairly well known. A "programme" seems essential to him. In opera he is most certainly at his best, and as an orchestral colourist he ranks among the very highest.

GOLDONI, CARLO (1707-1793), Italian dramatist, the real founder of modern Italian comedy, was born at Venice, on the 25th of February 1707, in a fine house near St Thomas's church. His father Giulio was a native of Modena. The first playthings of the future writer were puppets which he made dance; the first books he read were plays,—among others, the comedies of the Florentine Cicognini. Later he received a still stronger impression from the *Mandragora* of Machiavelli. At eight years old he had tried to sketch a play. His father, meanwhile, had taken his degree in medicine at Rome and fixed himself at Perugia, where he made his son join him; but, having soon quarrelled with his colleagues in medicine, he departed for Chioggia, leaving his son to the care of a philosopher, Professor Caldini of Rimini. The young Goldoni soon grew tired of his life at Rimini, and ran away with a Venetian company of players. He began to study law at Venice, then went to continue the same pursuit at Pavia, but at that time he was studying the Greek and Latin comic poets much more and much better than books about law. "I have read over again," he writes in his own *Memoirs*, "the Greek and Latin poets, and I have told to myself that I should like to imitate them in their style, their plots, their precision; but I would not be satisfied unless I succeeded in giving more interest to my works, happier issues to my plots, better drawn characters and more genuine comedy." For a satire entitled *Il Colosso*, which attacked the honour of several families of Pavia, he was driven from that town, and went first to study with the juriconsult Morelli at Udine, then to take his degree in law at Modena. After having worked some time as clerk in the chanceries of Chioggia and Feltre, his father being dead, he went to Venice, to exercise there his profession as a lawyer. But the wish to write for the stage was always strong in him, and he tried to do so; he made, however, a mistake in his choice, and began with a tragedy, *Amalantia*, which was represented at Milan and proved a failure. In 1734 he wrote another tragedy, *Belisario*, which, though not much better, chanced nevertheless to please the public. This first success encouraged him to write other tragedies, some of which were well received; but the author himself saw clearly that he had not yet found his proper sphere, and that a radical dramatic reform was absolutely necessary for the stage. He wished to create a characteristic comedy in Italy, to follow the example of Molière, and to delineate the realities of social life in as natural a manner as possible. His first essay of this kind was *Momolo Cortasan* (*Momolo the Courtier*), written in the Venetian dialect, and based on his own experience. Other plays followed—some interesting from their subject, others from the characters; the best of that period are—*Le Trentadue Disgrazie d'Arlecchino*, *La Notte critica*, *La Bancarotta*, *La Donna di Garbo*. Having, while consul of Genoa at Venice, been cheated by a captain of Ragusa, he founded on this his play *L'Impostore*. At Leghorn he made the acquaintance of the comedian Medebac, and followed him to Venice, with his company,

for which he began to write his best plays. Once he promised to write sixteen comedies in a year, and kept his word; among the sixteen are some of his very best, such as *Il Caffè*, *Il Bugiardo*, *La Pamela*. When he left the company of Medebac, he passed over to that maintained by the patrician Vendramin, continuing to write with the greatest facility. In 1761 he was called to Paris, and before leaving Venice he wrote *Una delle ultime sere di Carnevale* (*One of the Last Nights of Carnival*), an allegorical comedy in which he said good-bye to his country. At the end of the representation of this play, the theatre resounded with applause, and with shouts expressive of good wishes. Goldoni, at this proof of public sympathy, wept as a child. At Paris, during two years; he wrote comedies for the Italian actors; then he taught Italian to the royal princesses; and for the wedding of Louis XVI. and of Marie Antoinette he wrote in French one of his best comedies, *Le Bourgeois bienfaisant*, which was a great success. When he retired from Paris to Versailles, the king made him a gift of 6000 francs, and fixed on him an annual pension of 2200 francs. It was at Versailles he wrote his *Memoirs*, which occupied him till he reached his eightieth year. The Revolution deprived him all at once of his modest pension, and reduced him to extreme misery; he dragged on his unfortunate existence till 1793, and died on the 6th of February. The day after, on the proposal of André Chénier, the Convention agreed to give the pension back to the poet; and as he had already died, a reduced allowance was granted to his widow.

The best comedies of Goldoni are: *La Donna di Garbo*, *La Bottega di Caffè*, *Pamela nubile*, *Le Baruffe chiozzotte*, *I Rusteghi*, *Todaro Bronzolon*, *Gli Innamorati*, *Il Venetiglo*, *Il Bugiardo*, *La Casa nova*, *Il Burbero benefico*, *La Locandiera*. A collected edition (Venice, 1788) was republished at Florence in 1827. See P. G. Mommenti, *Carlo Goldoni* (Venice, 1875); Rabany, *Carlo Goldoni* (Paris, 1896). The *Memoirs* were translated into English by John Black (Boston, 1877), with preface by W. D. Howells.

GOLDS, a Mongolo-Tatar people, living on the Lower Amur in south-eastern Siberia. Their chief settlements are on the right bank of the Amur and along the Sungari and Usuri rivers. In physique they are typically Mongolic. Like the Chinese they wear a pigtail, and from them, too, have learnt the art of silk embroidery. The Golds live almost entirely on fish, and are excellent boatmen. They keep large herds of swine and dogs, which live, like themselves, on fish. Geese, wild duck, eagles, bears, wolves and foxes are also kept in menageries. There is much reverence paid to the eagles, and hence the Manchus call the Golds "Eaglets." Their religion is Shamanism.

See L. Schrenck, *Die Völker des Amurlandes* (St Petersburg, 1891); Laufer, "The Amoor Tribes," in *American Anthropologist* (New York, 1900); E. G. Ravenstein, *The Russians on the Amur* (1861).

GOLDSBORO, a city and the county-seat of Wayne county, North Carolina, U.S.A., on the Neuse river, about 50 m. S.E. of Raleigh. Pop. (1890) 4017; (1900) 5877 (2520 negroes); (1910) 6107. It is served by the Southern, the Atlantic Coast Line and the Norfolk & Southern railways. The surrounding country produces large quantities of tobacco, cotton and grain, and trucking is an important industry, the city being a distributing point for strawberries and various kinds of vegetables. The city's manufactures include cotton goods, knit goods, cotton-seed oil, agricultural implements, lumber and furniture. Goldsboro is the seat of the Eastern insane asylum (for negroes) and of an Odd Fellows' orphan home. The municipality owns and operates its water-works and electric-lighting plant. Goldsboro was settled in 1838, and was first incorporated in 1841. In the campaign of 1865 Goldsboro was the point of junction of the Union armies under generals Sherman and Schofield, previous to the final advance to Greensboro.

GOLDSCHMIDT, HERMANN (1802-1866), German painter and astronomer, was the son of a Jewish merchant, and was born at Frankfort on the 17th of June 1802. He for ten years assisted his father in his business; but, his love of art having been awakened while journeying in Holland, he in 1832 began the study of painting at Munich under Cornelius and Schnorr, and in 1836 established himself at Paris, where he painted a number of pictures of more than average merit, among which may be mentioned the "Cumæan Sibyl" (1844); an "Offering to

Venus" (1845); a "View of Rome" (1849); the "Death of Romeo and Juliet" (1857); and several Alpine landscapes. In 1847 he began to devote his attention to astronomy; and from 1852 to 1861 he discovered fourteen asteroids between Mars and Jupiter, on which account he received the grand astronomical prize from the Academy of Sciences. His observations of the protuberances on the sun, made during the total eclipse on the 10th of July 1860, are included in the work of Mädler on the eclipse, published in 1861. Goldschmidt died at Fontainebleau on the 26th of August 1866.

GOLDSMID, the name of a family of Anglo-Jewish bankers sprung from Aaron Goldsmid (d. 1782), a Dutch merchant who settled in England about 1763. Two of his sons, Benjamin Goldsmid (c. 1753-1808) and Abraham Goldsmid (c. 1756-1810), began business together about 1777 as bill-brokers in London, and soon became great powers in the money market, during the Napoleonic war, through their dealings with the government. Abraham Goldsmid was in 1810 joint contractor with the Barings for a government loan, but owing to a depreciation of the scrip he was forced into bankruptcy and committed suicide. His brother, in a fit of depression, had similarly taken his own life two years before. Both were noted for their public and private generosity, and Benjamin had a part in founding the Royal Naval Asylum. Benjamin left four sons, the youngest being Lionel Prager Goldsmid; Abraham a daughter, Isabel.

Their nephew, Sir Isaac Lyon Goldsmid, Bart. (1778-1859), was born in London, and began in business with a firm of bullion brokers to the Bank of England and the East India Company. He amassed a large fortune, and was made Baron da Palmeira by the Portuguese government in 1846 for services rendered in settling a monetary dispute between Portugal and Brazil, but he is chiefly known for his efforts to obtain the emancipation of the Jews in England and for his part in founding University College, London. The Jewish Disabilities Bill, first introduced in Parliament by Sir Robert Grant in 1830, owed its final passage to Goldsmid's energetic work. He helped to establish the University College hospital in 1834, serving as its treasurer for eighteen years, and also aided in the efforts to obtain reform in the English penal code. Moreover he assisted by his capital and his enterprise to build part of the English southern railways and also the London docks. In 1841 he became the first Jewish baronet, the honour being conferred upon him by Lord Melbourne. He had married his cousin Isabel (see above), and their second son was Sir Francis Henry Goldsmid, Bart. (1808-1878), born in London, and called to the bar at Lincoln's Inn in 1833 (the first Jew to become an English barrister; Q.C. 1858). After the passing of the Jewish Disabilities Bill, in which he had aided his father with a number of pamphlets that attracted great attention, he entered Parliament in 1860 (having succeeded to the baronetcy) as member for Reading, and represented that constituency until his death. He was strenuous on behalf of the Jewish religion, and the founder of the great Jews' Free School. He was a munificent contributor to charities and especially to the endowment of University College. He, like his father, married a cousin, and, dying without issue, was succeeded in the baronetcy by his nephew Sir Julian Goldsmid, Bart. (1838-1896), son of Frederick David Goldsmid (1812-1866), long M.P. for Honiton. Sir Julian was for many years in Parliament, and his wealth, ability and influence made him a personage of considerable importance. He was eventually made a privy councillor. He had eight daughters, but no son, and his entailed property passed to his relation, Mr d'Avigdor, his house in Piccadilly being converted into the Isthmian Club.

Another distinguished member of the same family, Sir Frederic John Goldsmid (1818-1908), son of Lionel Prager Goldsmid (see above), was educated at King's College, London, and entering the Madras army in 1839 served in the China War of 1840-41, with the Turkish troops in eastern Crimea in 1855-56, and was given political employment by the Indian government. He received the thanks of the commander-in-chief and of the war office for services during the Egyptian campaign, and was retired a major-general in 1875. Sir Frederic Goldsmid's name

is, however, associated less with military service than with much valuable work in exploration and in surveying, for which he repeatedly received the thanks of government. From 1865 to 1870 he was director-general of the Indo-European telegraph, and carried through the telegraph convention with Persia; and between 1870 and 1872, as commissioner, he settled with Persia the difficult questions of the Perso-Baluch and Perso-Afghan boundaries. In the course of his work he had to travel extensively, and he followed this up by various responsible missions connected with emigration questions. In 1881-1882 he was in Egypt, as controller of the Daira Sanieh, and doing other miscellaneous military work; and in 1883 he went to the Congo, on behalf of the king of the Belgians, as one of the organizers of the new state, but had to return on account of illness. From his early years he had made studies of several Eastern languages, and he ranked among the foremost Orientalists of his day. In 1886 he was president of the geographical section of the British Association meeting held at Birmingham. He had married in 1849, and had two sons and four daughters. In 1871 he was made a K.C.S.I. Besides important contributions to the 9th edition of the *Encyclopædia Britannica* and many periodicals, he wrote an excellent and authoritative biography of Sir James Outram (2 vols., 1880).

A sister of the last-named married Henry Edward Goldsmid (1812-1855), an eminent Indian civil servant, son of Edward Goldsmid; his reform of the revenue system in Bombay, and introduction of a new system, established after his death, through his reports in 1840-1847, and his devoted labour in land-surveys, were of the highest importance to western India, and established his memory there as a public benefactor.

GOLDSMITH, LEWIS (c. 1763-1846), Anglo-French publicist, of Portuguese-Jewish extraction, was born near London about 1763. Having published in 1801 *The Crimes of Cabinets, or a Review of the Plans and Aggressions for Annihilating the Liberties of France, and the Dismemberment of her Territories*, an attack on the military policy of Pitt, he moved, in 1802, from England to Paris. Talleyrand introduced him to Napoleon, who arranged for him to establish in Paris an English tri-weekly, the *Argus*, which was to review English affairs from the French point of view. According to his own account, he was in 1803 entrusted with a mission to obtain from the head of the French royal family, afterwards Louis XVIII., a renunciation of his claims to the throne of France, in return for the throne of Poland. The offer was declined, and Goldsmith says that he then received instructions to kidnap Louis and kill him if he resisted, but, instead of executing these orders, he revealed the plot. He was, nevertheless, employed by Napoleon on various other secret service missions till 1807, when his Republican sympathies began to wane. In 1809 he returned to England, where he was at first imprisoned but soon released; and he became a notary in London. In 1811, being now violently anti-republican, he founded a Sunday newspaper, the *Anti-Gallican Monitor* and *Anti-Corsican Chronicle*, subsequently known as the *British Monitor*, in which he denounced the French Revolution. In 1811 he proposed that a public subscription should be raised to put a price on Napoleon's head, but this suggestion was strongly reprobated by the British government. In the same year he published *Secret History of the Cabinet of Bonaparte and Recueil des manifestes, or a Collection of the Decrees of Napoleon Bonaparte*, and in 1812 *Secret History of Bonaparte's Diplomacy*. Goldsmith alleged that in the latter year he was offered £200,000 by Napoleon to discontinue his attacks. In 1815 he published *An Appeal to the Governments of Europe on the Necessity of bringing Napoleon Bonaparte to a Public Trial*. In 1825 he again settled down in Paris, and in 1832 published his *Statistics of France*. His only child, Georgiana, became, in 1837, the second wife of Lord Lyndhurst. He died in Paris on the 6th of January 1846.

GOLDSMITH, OLIVER (1728-1774), English poet, playwright, novelist and man of letters, came of a Protestant and Saxon family which had long been settled in Ireland. He is usually said to have been born at Pallas or Pallasmore, Co. Longford; but recent investigators have contended, with much

show of probability, that his true birthplace was Smith-Hill House, Elphin, Roscommon, the residence of his mother's father, the Rev Oliver Jones. His father, Charles Goldsmith, lived at Pallas, supporting with difficulty his wife and children on what he could earn, partly as a curate and partly as a farmer.

While Oliver was still a child his father was presented to the living of Kilkenny West, in the county of West Meath. This was worth about £200 a year. The family accordingly quitted their cottage at Pallas for a spacious house on a frequented road, near the village of Lissoy. Here the boy was taught his letters by a relative and dependent, Elizabeth Delap, and was sent in his seventh year to a village school kept by an old quartermaster on half-pay, who professed to teach nothing but reading, writing and arithmetic, but who had an inexhaustible fund of stories about ghosts, banshees and fairies, about the great Rapparee chiefs, Baldearg O'Donnell and galloping Hogan, and about the exploits of Peterborough and Stanhope, the surprise of Monjuich and the glorious disaster of Brihuega. This man must have been of the Protestant religion; but he was of the aboriginal race, and not only spoke the Irish language, but could pour forth unpremeditated Irish verses. Oliver early became, and through life continued to be, a passionate admirer of the Irish music, and especially of the compositions of Carolan, some of the last notes of whose harp he heard. It ought to be added that Oliver, though by birth one of the English, and though connected by numerous ties with the Established Church, never showed the least sign of that contemptuous antipathy with which, in his days, the ruling minority in Ireland too generally regarded the subject majority. So far indeed was he from sharing in the opinions and feelings of the caste to which he belonged that he conceived an aversion to the *Glorious and Immortal Memory*, and, even when George III. was on the throne, maintained that nothing but the restoration of the banished dynasty could save the country.

From the humble academy kept by the old soldier Goldsmith was removed in his ninth year. He went to several grammar-schools, and acquired some knowledge of the ancient languages. His life at this time seems to have been far from happy. He had, as appears from the admirable portrait of him by Reynolds at Kneio, features harsh even to ugliness. The small-pox had set its mark on him with more than usual severity. His stature was small, and his limbs ill put together. Among boys little tenderness is shown to personal defects; and the ridicule excited by poor Oliver's appearance was heightened by a peculiar simplicity and a disposition to blunder which he retained to the last. He became the common butt of boys and masters, was pointed at as a fright in the play-ground, and flogged as a dunce in the school-room. When he had risen to eminence, those who had once derided him ransacked their memory for the events of his early years, and recited repartees and couplets which had dropped from him, and which, though little noticed at the time, were supposed, a quarter of a century later, to indicate the powers which produced the *Vicar of Wakefield* and the *Deserted Village*.

On the 11th of June 1744, being then in his sixteenth year, Oliver went up to Trinity College, Dublin, as a sizar. The sizar paid nothing for food and tuition, and very little for lodging; but they had to perform some menial services from which they have long been relieved. Goldsmith was quartered, not alone, in a garret of what was then No. 35 in a range of buildings which has long since disappeared. His name, scrawled by himself on one of its window-panes is still preserved in the college library. From such garrets many men of less parts than his have made their way to the woolstack or to the episcopal bench. But Goldsmith, while he suffered all the humiliations, threw away all the advantages of his situation. He neglected the studies of the place, stood low at the examinations, was turned down to the bottom of his class for playing the buffoon in the lecture-room, was severely reprimanded for pumping on a constable, and was caned by a brutal tutor for giving a ball in the attic storey of the college to some gay youths and damsels from the city.

While Oliver was leading at Dublin a life divided between squalid distress and squalid dissipation, his father died, leaving a mere pittance. In February 1749 the youth obtained his

bachelor's degree, and left the university. During some time the humble dwelling to which his widowed mother had retired was his home. He was now in his twenty-first year; it was necessary that he should do something; and his education seemed to have fitted him to do nothing but to dress himself in gaudy colours, of which he was as fond as a magpie, to take a hand at cards, to sing Irish airs, to play the flute, to angle in summer and to tell ghost stories by the fire in winter. He tried five or six professions in turn without success. He applied for ordination; but, as he applied in scarlet clothes, he was speedily turned out of the episcopal palace. He then became tutor in an opulent family, but soon quitted his situation in consequence of a dispute about pay. Then he determined to emigrate to America. His relations, with much satisfaction, saw him set out for Cork on a good horse, with £30 in his pocket. But in six weeks he came back on a miserable hack, without a penny, and informed his mother that the ship in which he had taken his passage, having got a fair wind while he was at a party of pleasure, had sailed without him. Then he resolved to study the law. A generous uncle, Mr Contarine, advanced £50. With this sum Goldsmith went to Dublin, was enticed into a gaming-house and lost every shilling. He then thought of medicine. A small purse was made up; and in his twenty-fourth year he was sent to Edinburgh. At Edinburgh he passed eighteen months in nominal attendance on lectures, and picked up some superficial information about chemistry and natural history. Thence he went to Leiden, still pretending to study physic. He left that celebrated university, the third university at which he had resided, in his twenty-seventh year, without a degree, with the merest smattering of medical knowledge, and with no property but his clothes and his flute. His flute, however, proved a useful friend. He rambled on foot through Flanders, France and Switzerland, playing tunes which everywhere set the peasantry dancing, and which often procured for him a supper and a bed. He wandered as far as Italy. His musical performances, indeed, were not to the taste of the Italians; but he contrived to live on the alms which he obtained at the gates of convents. It should, however, be observed that the stories which he told about this part of his life ought to be received with great caution; for strict veracity was never one of his virtues; and a man who is ordinarily inaccurate in narration is likely to be more than ordinarily inaccurate when he talks about his own travels. Goldsmith, indeed, was so regardless of truth as to assert in print that he was present at a most interesting conversation between Voltaire and Fontenelle, and that this conversation took place at Paris. Now it is certain that Voltaire never was within a hundred leagues of Paris during the whole time which Goldsmith passed on the continent.

In February 1756 the wanderer landed at Dover, without a shilling, without a friend and without a calling. He had indeed, if his own unsupported evidence may be trusted, obtained a doctor's degree on the continent; but this dignity proved utterly useless to him. In England his flute was not in request; there were no convents; and he was forced to have recourse to a series of desperate expedients. There is a tradition that he turned strolling player. He pounded drugs and ran about London with phials for charitable chemists. He asserted, upon one occasion, that he had lived "among the beggars in Axe Lane." He was for a time usher of a school, and felt the miseries and humiliations of this situation so keenly that he thought it a promotion to be permitted to earn his bread as a bookseller's hack; but he soon found the new yoke more galling than the old one, and was glad to become an usher again. He obtained a medical appointment in the service of the East India Company; but the appointment was speedily revoked. Why it was revoked we are not told. The subject was one on which he never liked to talk. It is probable that he was incompetent to perform the duties of the place. Then he presented himself at Surgeons' Hall for examination, as "mate to an hospital." Even to so humble a post he was found unequal. Nothing remained but to return to the lowest drudgery of literature. Goldsmith took a room in a tiny square off Ludgate Hill, to which he had to climb

from Sea-coal Lane by a dizzy ladder of flagstones called Break-neck Steps. Green Arbour Court and the ascent have long disappeared. Here, at thirty, the unlucky adventurer sat down to toil like a galley slave. Already, in 1758, during his first bondage to letters, he had translated Marteihe's remarkable *Memoirs of a Protestant, Condemned to the Gallies of France for his Religion*. In the years that now succeeded he sent to the press some things which have survived, and many which have perished. He produced articles for reviews, magazines and newspapers; children's books, which, bound in gilt paper and adorned with hideous woodcuts, appeared in the window of Newbery's once far-famed shop at the corner of Saint Paul's churchyard; *An Inquiry into the State of Polite Learning in Europe*, which, though of little or no value, is still reprinted among his works; a volume of essays entitled *The Bee; a Life of Beau Nash*; a superficial and incorrect, but very readable, *History of England*, in a series of letters purporting to be addressed by a nobleman to his son; and some very lively and amusing sketches of London Society in another series of letters purporting to be addressed by a Chinese traveller to his friends. All these works were anonymous; but some of them were well known to be Goldsmith's; and he gradually rose in the estimation of the booksellers for whom he drudged. He was, indeed, emphatically a popular writer. For accurate research or grave disquisition he was not well qualified by nature or by education. He knew nothing accurately; his reading had been desultory; nor had he meditated deeply on what he had read. He had seen much of the world; but he had noticed and retained little more of what he had seen than some grotesque incidents and characters which had happened to strike his fancy. But, though his mind was very scantily stored with materials, he used what materials he had in such a way as to produce a wonderful effect. There have been many greater writers; but perhaps no writer was ever more uniformly agreeable. His style was always pure and easy, and, on proper occasions, pointed and energetic. His narratives were always amusing, his descriptions always picturesque, his humour rich and joyous, yet not without an occasional tinge of amiable sadness. About everything that he wrote, serious or sportive, there was a certain natural grace and decorum, hardly to be expected from a man a great part of whose life had been passed among thieves and beggars, street-walkers and merryandrews, in those squalid dens which are the reproach of great capitals.

As his name gradually became known, the circle of his acquaintance widened. He was introduced to Johnson, who was then considered as the first of living English writers; to Reynolds, the first of English painters; and to Burke, who had not yet entered parliament, but had distinguished himself greatly by his writings and by the eloquence of his conversation. With these eminent men Goldsmith became intimate. In 1763 he was one of the nine original members of that celebrated fraternity which has sometimes been called the Literary Club, but which has always disclaimed that epithet, and still glories in the simple name of the Club.

By this date Goldsmith had quitted his miserable dwelling at the top of Breakneck Steps, and, after living for some time at No. 6 Wine Office Court, Fleet Street, had moved into the Temple. But he was still often reduced to pitiable shifts, the most popular of which is connected with the sale of his solitary novel, the *Vicar of Wakefield*. Towards the close of 1764(?) his rent is alleged to have been so long in arrear that his landlady one morning called in the help of a sheriff's officer. The debtor, in great perplexity, despatched a messenger to Johnson; and Johnson, always friendly, though often surly, sent back the messenger with a guinea, and promised to follow speedily. He came, and found that Goldsmith had changed the guinea, and was railing at the landlady over a bottle of Madeira. Johnson put the cork into the bottle, and entreated his friend to consider calmly how money was to be procured. Goldsmith said that he had a novel ready for the press. Johnson glanced at the manuscript, saw that there were good things in it, took it to a bookseller, sold it for £60 and soon returned with the money. The rent was paid; and the sheriff's officer withdrew. (Unfortunately,

however, for this time-honoured version of the circumstances, it has of late years been discovered that as early as October 1762 Goldsmith had already sold a third of the *Vicar* to one Benjamin Collins of Salisbury, a printer, by whom it was eventually printed for F. Newbery, and it is difficult to reconcile this fact with Johnson's narrative.)

But before the *Vicar of Wakefield* appeared in 1766, came the great crisis of Goldsmith's literary life. In Christmas week 1764 he published a poem, entitled the *Traveller*. It was the first work to which he had put his name, and it at once raised him to the rank of a legitimate English classic. The opinion of the most skilful critics was that nothing finer had appeared in verse since the fourth book of the *Dunciad*. In one respect the *Traveller* differs from all Goldsmith's other writings. In general his designs were bad, and his execution good. In the *Traveller* the execution, though deserving of much praise, is far inferior to the design. No philosophical poem, ancient or modern, has a plan so noble, and at the same time so simple. An English wanderer, seated on a crag among the Alps, near the point where three great countries meet, looks down on the boundless prospect, reviews his long pilgrimage, recalls the varieties of scenery, of climate, of government, of religion, of national character, which he has observed, and comes to the conclusion, just or unjust, that our happiness depends little on political institutions, and much on the temper and regulation of our own minds.

While the fourth edition of the *Traveller* was on the counters of the booksellers, the *Vicar of Wakefield* appeared, and rapidly obtained a popularity which has lasted down to our own time, and which is likely to last as long as our language. The fable is indeed one of the worst that ever was constructed. It wants, not merely that probability which ought to be found in a tale of common English life, but that consistency which ought to be found even in the wildest fiction about witches, giants and fairies. But the earlier chapters have all the sweetness of pastoral poetry, together with all the vivacity of comedy. Moses and his spectacles, the vicar and his monogamy, the sharper and his cosmogony, the squire proving from Aristotle that relatives are related, Olivia preparing herself for the arduous task of converting a rakish lover by studying the controversy between Robinson Crusoe and Friday, the great ladies with their scandal about Sir Tomkyn's amours and Dr Burdock's verses, and Mr Burchell with his "Fudge," have caused as much harmless mirth as has ever been caused by matter packed into so small a number of pages. The latter part of the tale is unworthy of the beginning. As we approach the catastrophe, the absurdities lie thicker and thicker, and the gleams of pleasantry become rarer and rarer.

The success which had attended Goldsmith as a novelist emboldened him to try his fortune as a dramatist. He wrote the *Good Natur'd Man*, a piece which had a worse fate than it deserved. Garrick refused to produce it at Drury Lane. It was acted at Covent Garden in January 1768, but was coldly received. The author, however, cleared by his benefit nights, and by the sale of the copyright, no less than £500, five times as much as he had made by the *Traveller* and the *Vicar of Wakefield* together. The plot of the *Good Natur'd Man* is, like almost all Goldsmith's plots, very ill constructed. But some passages are exquisitely ludicrous,—much more ludicrous indeed than suited the taste of the town at that time. A canting, mawkish play, entitled *False Delicacy*, had just been produced, and sentimentality was all the mode. During some years more tears were shed at comedies than at tragedies; and a pleasantry which moved the audience to anything more than a grave smile was reprobated as low. It is not strange, therefore, that the very best scene in the *Good Natur'd Man*, that in which Miss Richland finds her lover attended by the bailiff and the bailiff's follower in full court dresses, should have been mercilessly hissed, and should have been omitted after the first night, not to be restored for several years.

In May 1770 appeared the *Deserted Village*. In mere diction and versification this celebrated poem is fully equal, perhaps superior, to the *Traveller*; and it is generally preferred to the

Traveller by that large class of readers who think, with Bayes in the *Rehearsal*, that the only use of a plot is to bring in fine things. More discerning judges, however, while they admire the beauty of the details, are shocked by one unpardonable fault which pervades the whole. The fault which we mean is not that theory about wealth and luxury which has so often been censured by political economists. The theory is indeed false; but the poem, considered merely as a poem, is not necessarily the worse on that account. The finest poem in the Latin language—indeed, the finest didactic poem in any language—was written in defence of the silliest and meanest of all systems of natural and moral philosophy. A poet may easily be pardoned for reasoning ill; but he cannot be pardoned for describing ill, for observing the world in which he lives so carelessly that his portraits bear no resemblance to the originals, for exhibiting as copies from real life monstrous combinations of things which never were and never could be found together. What would be thought of a painter who should mix August and January in one landscape, who should introduce a frozen river into a harvest scene? Would it be a sufficient defence of such a picture to say that every part was exquisitely coloured, that the green hedges, the apple-trees loaded with fruit, the waggons reeling under the yellow sheaves, and the sun-burned reapers wiping their foreheads were very fine, and that the ice and the boys sliding were also very fine? To such a picture the *Deserted Village* bears a great resemblance. It is made up of incongruous parts. The village in its happy days is a true English village. The village in its decay is an Irish village. The felicity and the misery which Goldsmith has brought close together belong to two different countries and to two different stages in the progress of society. He had assuredly never seen in his native island such a rural paradise, such a seat of plenty, content and tranquillity, as his Auburn. He had assuredly never seen in England all the inhabitants of such a paradise turned out of their homes in one day and forced to emigrate in a body to America. The hamlet he had probably seen in Kent; the ejection he had probably seen in Munster; but by joining the two, he has produced something which never was and never will be seen in any part of the world.

In 1773 Goldsmith tried his chance at Covent Garden with a second play, *She Stoops to Conquer*. The manager was, not without great difficulty, induced to bring this piece out. The sentimental comedy still reigned, and Goldsmith's comedies were not sentimental. The *Good Natur'd Man* had been too funny to succeed; yet the mirth of the *Good Natur'd Man* was sober when compared with the rich drollery of *She Stoops to Conquer*, which is, in truth, an incomparable farce in five acts. On this occasion, however, genius triumphed. Pit, boxes and galleries were in a constant roar of laughter. If any bigoted admirer of Kelly and Cumberland ventured to hiss or groan, he was speedily silenced by a general cry of "turn him out," or "throw him over." Later generations have confirmed the verdict which was pronounced on that night.

While Goldsmith was writing the *Deserted Village* and *She Stoops to Conquer*, he was employed on works of a very different kind—works from which he derived little reputation but much profit. He compiled for the use of schools a *History of Rome*, by which he made £250; a *History of England*, by which he made £500; a *History of Greece*, for which he received £250; a *Natural History*, for which the booksellers covenanted to pay him 800 guineas. These works he produced without any elaborate research, by merely selecting, abridging and translating into his own clear, pure and flowing language, what he found in books well known to the world, but too bulky or too dry for boys and girls. He committed some strange blunders, for he knew nothing with accuracy. Thus, in his *History of England*, he tells us that Naseby is in Yorkshire; nor did he correct this mistake when the book was reprinted. He was very nearly hoaxed into putting into the *History of Greece* an account of a battle between Alexander the Great and Montezuma. In his *Animated Nature* he relates, with faith and with perfect gravity, all the most absurd lies which he could find in books of travels about gigantic

Patagonians, monkeys that preach sermons, nightingales that repeat long conversations. "If he can tell a horse from a cow," said Johnson, "that is the extent of his knowledge of zoology." How little Goldsmith was qualified to write about the physical sciences is sufficiently proved by two anecdotes. He on one occasion denied that the sun is longer in the northern than in the southern signs. It was vain to cite the authority of Maupertuis. "Maupertuis!" he cried, "I understand those matters better than Maupertuis." On another occasion he, in defiance of the evidence of his own senses, maintained obstinately, and even angrily, that he chewed his dinner by moving his upper jaw.

Yet, ignorant as Goldsmith was, few writers have done more to make the first steps in the laborious road to knowledge easy and pleasant. His compilations are widely distinguished from the compilations of ordinary bookmakers. He was a great, perhaps an unequalled, master of the arts of selection and condensation. In these respects his histories of Rome and of England, and still more his own abridgments of these histories, well deserved to be studied. In general nothing is less attractive than an epitome; but the epitomes of Goldsmith, even when most concise, are always amusing; and to read them is considered by intelligent children not as a task but as a pleasure.

Goldsmith might now be considered as a prosperous man. He had the means of living in comfort, and even in what to one who had so often slept in barns and on bulks must have been luxury. His fame was great and was constantly rising. He lived in what was intellectually far the best society of the kingdom, in a society in which no talent or accomplishment was wanting, and in which the art of conversation was cultivated with splendid success. There probably were never four talkers more admirable in four different ways than Johnson, Burke, Beauclerk and Garrick; and Goldsmith was on terms of intimacy with all the four. He aspired to share in their colloquial renown, but never was ambition more unfortunate. It may seem strange that a man who wrote with so much perspicuity, vivacity and grace should have been, whenever he took a part in conversation, an empty, noisy, blundering rattle. But on this point the evidence is overwhelming. So extraordinary was the contrast between Goldsmith's published works and the silly things which he said, that Horace Walpole described him as an inspired idiot. "Noll," said Garrick, "wrote like an angel, and talked like poor Poll." Chamier declared that it was a hard exercise of faith to believe that so foolish a chatterer could have really written the *Traveller*. Even Boswell could say, with contemptuous compassion, that he liked very well to hear honest Goldsmith run on. "Yes, sir," said Johnson, "but he should not like to hear himself." Minds differ as rivers differ. There are transparent and sparkling rivers from which it is delightful to drink as they flow; to such rivers the minds of such men as Burke and Johnson may be compared. But there are rivers of which the water when first drawn is turbid and noisome, but becomes pellucid as crystal and delicious to the taste, if it be suffered to stand till it has deposited a sediment; and such a river is a type of the mind of Goldsmith. His first thoughts on every subject were confused even to absurdity, but they required only a little time to work themselves clear. When he wrote they had that time, and therefore his readers pronounced him a man of genius; but when he talked he talked nonsense and made himself the laughing-stock of his hearers. He was painfully sensible of his inferiority in conversation; he felt every failure keenly; yet he had not sufficient judgment and self-command to hold his tongue. His animal spirits and vanity were always impelling him to try to do the one thing which he could not do. After every attempt he felt that he had exposed himself, and writhed with shame and vexation; yet the next moment he began again.

His associates seem to have regarded him with kindness, which, in spite of their admiration of his writings, was not unminged with contempt. In truth, there was in his character much to love, but very little to respect. His heart was soft even to weakness;

he was so generous that he quite forgot to be just; he forgave injuries so readily that he might be said to invite them, and was so liberal to beggars that he had nothing left for his tailor and his butcher. He was vain, sensual, frivolous, profuse, improvident. One vice of a darker shade was imputed to him, envy. But there is not the least reason to believe that this bad passion, though it sometimes made him wince and utter fretful exclamations, ever impelled him to injure by wicked arts the reputation of any of his rivals. The truth probably is that he was not more envious, but merely less prudent, than his neighbours. His heart was on his lips. All those small jealousies, which are but too common among men of letters, but which a man of letters who is also a man of the world does his best to conceal, Goldsmith avowed with the simplicity of a child. When he was envious, instead of affecting indifference, instead of damning with faint praise, instead of doing injuries slyly and in the dark, he told everybody that he was envious. "Do not, pray, do not, talk of Johnson in such terms," he said to Boswell; "you harrow up my very soul." George Stevens and Cumberland were men far too cunning to say such a thing. They would have echoed the praises of the man whom they envied, and then have sent to the newspapers anonymous libels upon him. Both what was good and what was bad in Goldsmith's character was to his associates a perfect security that he would never commit such villainy. He was neither ill-natured enough, nor long-headed enough, to be guilty of any malicious act which required contrivance and disguise.

Goldsmith has sometimes been represented as a man of genius, cruelly treated by the world, and doomed to struggle with difficulties, which at last broke his heart. But no representation can be more remote from the truth. He did, indeed, go through much sharp misery before he had done anything considerable in literature. But after his name had appeared on the title-page of the *Traveller*, he had none but himself to blame for his distresses. His average income, during the last seven years of his life, certainly exceeded £400 a year, and £400 a year ranked, among the incomes of that day, at least as high as £300 a year would rank at present. A single man living in the Temple, with £400 a year, might then be called opulent. Not one in ten of the young gentlemen of good families who were studying the law there had so much. But all the wealth which Lord Clive had brought from Bengal and Sir Lawrence Dundas from Germany, joined together, would not have sufficed for Goldsmith. He spent twice as much as he had. He wore fine clothes, gave dinners of several courses, paid court to venal beauties. He had also, it should be remembered, to the honour of his heart, though not of his head, a guinea, or five, or ten, according to the state of his purse, ready for any tale of distress, true or false. But it was not in dress or feasting, in promiscuous amours or promiscuous charities, that his chief expense lay. He had been from boyhood a gambler, and at once the most sanguine and the most unskillful of gamblers. For a time he put off the day of inevitable ruin by temporary expedients. He obtained advances from booksellers by promising to execute works which he never began. But at length this source of supply failed. He owed more than £2000; and he saw no hope of extrication from his embarrassments. His spirits and health gave way. He was attacked by a nervous fever, which he thought himself competent to treat. It would have been happy for him if his medical skill had been appreciated as justly by himself as by others. Notwithstanding the degree which he pretended to have received on the continent, he could procure no patients. "I do not practise," he once said; "I make it a rule to prescribe only for my friends." "Pray, dear Doctor," said Beauclerk, "alter your rule; and prescribe only for your enemies." Goldsmith, now, in spite of this excellent advice, prescribed for himself. The remedy aggravated the malady. The sick man was induced to call in real physicians; and they at one time imagined that they had cured the disease. Still his weakness and restlessness continued. He could get no sleep. He could take no food. "You are worse," said one of his medical attendants, "than you should be from the degree of fever which you have. Is your mind at ease?" "No; it is

not," were the last recorded words of Oliver Goldsmith. He died on the 4th of April 1774, in his forty-sixth year. He was laid in the churchyard of the Temple; but the spot was not marked by any inscription and is now forgotten. The coffin was followed by Burke and Reynolds. Both these great men were sincere mourners. Burke, when he heard of Goldsmith's death, had burst into a flood of tears. Reynolds had been so much moved by the news that he had flung aside his brush and palette for the day.

A short time after Goldsmith's death, a little poem appeared, which will, as long as our language lasts, associate the names of his two illustrious friends with his own. It has already been mentioned that he sometimes felt keenly the sarcasm which his wild blundering talk brought upon him. He was, not long before his last illness, provoked into retaliating. He wisely betook himself to his pen; and at that weapon he proved himself a match for all his assailants together. Within a small compass he drew with a singularly easy and vigorous pencil the characters of nine or ten of his intimate associates. Though this little work did not receive his last touches, it must always be regarded as a masterpiece. It is impossible, however, not to wish that four or five likenesses which have no interest for posterity were wanting to that noble gallery, and that their places were supplied by sketches of Johnson and Gibbon, as happy and vivid as the sketches of Burke and Garrick.

Some of Goldsmith's friends and admirers honoured him with a cenotaph in Westminster Abbey. Nollekens was the sculptor, and Johnson wrote the inscription. It is much to be lamented that Johnson did not leave to posterity a more durable and a more valuable memorial of his friend. A life of Goldsmith would have been an inestimable addition to the Lives of the Poets. No man appreciated Goldsmith's writings more justly than Johnson; no man was better acquainted with Goldsmith's character and habits; and no man was more competent to delineate with truth and spirit the peculiarities of a mind in which great powers were found in company with great weaknesses. But the list of poets to whose works Johnson was requested by the booksellers to furnish prefaces ended with Lyttelton, who died in 1773. The line seems to have been drawn expressly for the purpose of excluding the person whose portrait would have most fitly closed the series. Goldsmith, however, has been fortunate in his biographers. (M.)

Goldsmith's life has been written by Prior (1837), by Washington Irving (1844-1849), and by John Forster (1848, 2nd ed. 1854). The diligence of Prior deserves great praise; the style of Washington Irving is always pleasing; but the highest place must, in justice, be assigned to the eminently interesting work of Forster. Subsequent biographies are by William Black (1878), and Austin Dobson (1888, American ed. 1899). The above article by Lord Macaulay has been slightly revised for this edition by Mr Austin Dobson, as regards questions of fact for which there has been new evidence.

GOLDSTÜCKER, THEODOR (1821-1872), German Sanskrit scholar, was born of Jewish parents at Königsberg on the 18th of January 1821, and, after attending the gymnasium of that town, entered the university in 1836 as a student of Sanskrit. In 1838 he removed to Bonn, and, after graduating at Königsberg in 1840, proceeded to Paris; in 1842 he edited a German translation of the *Prabodha Chandradaya*. From 1847 to 1850 he resided at Berlin, where his talents and scholarship were recognized by Alexander von Humboldt, but where his advanced political views caused the authorities to regard him with suspicion. In the latter year he removed to London, where in 1852 he was appointed professor of Sanskrit in University College. He now worked on a new Sanskrit dictionary, of which the first instalment appeared in 1856. In 1861 he published his chief work: *Panini: his place in Sanskrit Literature*; and he was one of the founders and chief promoters of the Sanskrit Text Society; he was also an active member of the Philological Society, and of other learned bodies. He died in London on the 6th of March 1872.

As *Literary Remains* some of his writings were published in two volumes (London, 1879), but his papers were left to the India Office with the request that they were not to be published until 1920.

GOLDWELL, THOMAS (d. 1585), English ecclesiastic, began his career as vicar of Cheriton in 1531, after graduating M.A. at All Souls College, Oxford. He became chaplain to Cardinal Pole and lived with him at Rome, was attainted in 1539, but returned to England on Mary's accession, and in 1555 became bishop of St. Asaph, a diocese which he did much to win back to the old faith. On the death of Mary, Goldwell escaped from England and in 1561 became superior of the Theatines at Naples. He was the only English bishop at the council of Trent, and in 1562 was again attainted. In the following year he was appointed vicar-general to Carlo Borromeo, archbishop of Milan. He died in Rome in 1585, the last of the English bishops who had refused to accept the Reformation.

GOLDZIEHER, IGNAZ (1850–), Jewish Hungarian orientalist, was born in Stuhlweissenburg on the 22nd of June 1850. He was educated at the universities of Budapest, Berlin, Leipzig and Leiden, and became privat docent at Budapest in 1872. In the next year, under the auspices of the Hungarian government, he began a journey through Syria, Palestine and Egypt, and took the opportunity of attending lectures of Mahommedan sheiks in the mosque of el-Azhar in Cairo. He was the first Jewish scholar to become professor in the Budapest University (1894), and represented the Hungarian government and the Academy of Sciences at numerous international congresses. He received the large gold medal at the Stockholm Oriental Congress in 1889. He became a member of several Hungarian and other learned societies, was appointed secretary of the Jewish community in Budapest. He was made Litt. D. of Cambridge (1904) and LL.D. of Aberdeen (1906). His eminence in the sphere of scholarship is due primarily to his careful investigation of pre-Mahommedan and Mahommedan law, tradition, religion and poetry, in connexion with which he published a large number of treatises, review articles and essays contributed to the collections of the Hungarian Academy.

Among his chief works are: *Beiträge zur Literaturgeschichte der Schi's* (1874); *Beiträge zur Geschichte der Sprachlehrsamkeit bei den Arabern* (Vienna, 1871–1873); *Der Mythos bei den Hebräern und seine geschichtliche Entwicklung* (Leipzig, 1876; Eng. trans., R. Martineau, London, 1877); *Mohammedanische Studien* (Halle, 1889–1890, 2 vols.); *Abhandlungen zur arabischen Philologie* (Leiden, 1896–1899, 2 vols.); *Buch v. Wesen d. Seele* (ed. 1907).

GOLETTA [LA GOULETTE], a town on the Gulf of Tunis in 36° 50' N. 10° 19' E., a little south of the ruins of Carthage, and on the north side of the ship canal which traverses the shallow Lake of Tunis and leads to the city of that name. Built on the narrow strip of sand which separates the lake from the gulf, Goletta is defended by a fort and battery. The town contains a summer palace of the bey, the old seraglio, arsenal and custom-house, and many villas, gardens and pleasure resorts, Goletta being a favourite place for sea-bathing. A short canal, from which the name of the town is derived (Arab. *Halk-el-Wad*, "throat of the canal"), 40 ft. broad and 8½ ft. deep, divides the town and affords communication between the ship canal and a dock or basin, 1082 ft. long and 541 ft. broad. An electric tramway which runs along the north bank of the ship canal connects Goletta with the city of Tunis (*q.v.*). Pop. (1907) about 5000, mostly Jews and Italian fishermen.

Beyond Cape Carthage, 5 m. N. of Goletta, is La Marsa, a summer resort overlooking the sea. The bey has a palace here, and the French resident-general, the British consul, other officials, and many Tunisians have country-houses, surrounded by groves of olive trees.

Before the opening of the ship canal in 1893 Goletta, as the port of Tunis, was a place of considerable importance. The basin at the Goletta end of the canal now serves as a subsidiary harbour to that of Tunis. The most stirring events in the history of the town are connected with the Turkish conquest of the Barbary states. Khair-ed-Din Barbarossa having made himself master of Tunis and its port, Goletta was attacked in 1535 by the emperor Charles V., who seized the pirate's fleet, which was sheltered in the small canal, his arsenal, and 300 brass cannon. The Turks regained possession in 1574. (See TUNISIA: *History*.)

GOLF (in its older forms *Goff*, *Gouff* or *Gowff*, the last of which gives the genuine old pronunciation), a game which probably derives its name from the Ger. *Kolbe*, a club—in Dutch, *kolf*—which last is nearly in sound identical and might suggest a Dutch origin,¹ which many pictures and other witnesses further support.

History.—One of the most ancient and most interesting of the pictures in which the game is portrayed is the tailpiece to an illuminated *Book of Hours* made at Bruges at the beginning of the 16th century. The original is in the British Museum. The players, three in number, have but one club apiece. The heads of the clubs are steel or steel covered. They play with a ball each. That which gives this picture a peculiar interest over the many pictures of Dutch schools that portray the game in progress is that most of them show it on the ice, the putting being at a stake. In this *Book of Hours* they are putting at a hole in the turf, as in our modern golf. It is scarcely to be doubted that the game is of Dutch origin, and that it has been in favour since very early days. Further than that our knowledge does not go. The early Dutchmen played golf, they painted golf, but they did not write it.

It is uncertain at what date golf was introduced into Scotland, but in 1457 the popularity of the game had already become so great as seriously to interfere with the more important pursuit of archery. In March of that year the Scottish parliament "decreted and ordained that *wapinshawings* be balden be the lordis and baronis spirituale and temporale, four times in the zeir; and that the fute-ball and *golf* be utterly cryit down, and nocht usit; and that the bowe-merkis be maid at ilk parochie kirk a pair of buttis, and *schuttin* be usit ilk Sunday." Fourteen years afterwards, in May 1471, it was judged necessary to pass another act "anent wapenshawings," and in 1491 a final and evidently angry fulmination was issued on the general subject, with pains and penalties annexed. It runs thus— "Futeball and Golfe forbydden. Item, it is statut and ordainit that in na place of the realm the be usit fute-ball, *golfe*, or ither sik unprofitabil sportis," &c. This, be it noted, is an edict of James IV.; and it is not a little curious presently to find the monarch himself setting an ill example to his commons, by practice of this "unprofitabil sport," as is shown by various entries in the accounts of the lord high treasurer of Scotland (1503–1506).

About a century later, the game again appears on the surface of history, and it is quite as popular as before. In the year 1592 the town council of Edinburgh "ordainis proclamation to be made thre this burgh, that na inhabitants of the samyn be seen at ony pastymes within or without the town, upon the Sabbath day, sic as *golfe*, &c."² The following year the edict was re-announced, but with the modification that the prohibition was "in tyme of sermons."

Golf has from old times been known in Scotland as "The Royal and Ancient Game of Goff." Though no doubt Scottish monarchs handled the club before him, James IV. is the first who figures formally in the golfing record. James V. was also very partial to the game distinctively known as "royal"; and there is some scrap of evidence to show that his daughter, the unhappy Mary Stuart, was a golfer. It was alleged by her enemies that, as showing her shameless indifference to the fate of her husband, a very few days after his murder, she "was seen playing *golf* and pallmall in the fields beside Seton."³ That her son, James VI. (afterwards James I. of England), was a golfer, tradition confidently asserts, though the evidence which connects him with the personal practice of the game is slight. Of the interest he took in it we have evidence in his act—already alluded to—"anent *golfe ballis*," prohibiting their importation,⁴ except under certain

¹ From an enactment of James VI. (then James I. of England), bearing date 1618, we find that a considerable importation of golf balls at that time took place from Holland, and as thereby "na small quantitie of gold and silver is transported zierly out of his Hienes' kingdome of Scotland" (see letter of His Majesty from Salisbury, the 5th of August 1618), he issues a royal prohibition, at once as a wise economy of the national moneys, and a protection to native industry in the article. From this it might almost seem that the game was at that date still known and practised in Holland.

² *Records of the City of Edinburgh*.

³ *Inventories of Mary Queen of Scots*, preface, p. lxx. (1863).

restrictions. Charles I. (as his brother Prince Henry had been¹) was devotedly attached to the game. Whilst engaged in it on the links of Leith, in 1642, the news reached him of the Irish rebellion of that year. He had not the equanimity to finish his match, but returned precipitately and in much agitation to Holyrood.² Afterwards, while prisoner to the Scots army at Newcastle, he found his favourite diversion in "the royal game." "The King was nowhere treated with more honour than at Newcastle, as he himself confessed, both he and his train having liberty to go abroad and play at goff in the Shield Field, without the walls."³ Of his son, Charles II., as a golfer, nothing whatever is ascertained, but James II. was a known devotee.⁴ After the Restoration, James, then duke of York, was sent to Edinburgh in 1681/2 as commissioner of the king to parliament, and an historical monument of his prowess as a golfer remains there to this day in the "Golfer's Land," as it is still called, 77 Canongate. The duke having been challenged by two English noblemen of his suite, to play a match against them, for a very large stake, along with any Scotch ally he might select, chose as his partner one "John Paterson," a shoemaker. The duke and the said John won easily, and half of the large stake the duke made over to his humble coadjutor, who therewith built himself the house mentioned above. In 1834 William IV. became patron of the St Andrews Golf Club (St Andrews being then, as now, the most famous seat of the game), and approved of its being styled "The Royal and Ancient Golf Club of St Andrews." In 1837, as further proof of royal favour, he presented to it a magnificent gold medal, which "should be challenged and played for annually"; and in 1838 the queen dowager, duchess of St Andrews, became patroness of the club, and presented to it a handsome gold medal—"The Royal Adelaide"—with a request that it should be worn by the captain, as president, on all public occasions. In June 1863 the prince of Wales (afterwards Edward VII.) signified his desire to become patron of the club, and in the following September was elected captain by acclamation. His engagements did not admit of his coming in person to undertake the duties of the office, but his brother Prince Leopold (the duke of Albany), having in 1876 done the club the honour to become its captain, twice visited the ancient city in that capacity.

In more recent days, golf has become increasingly popular in a much wider degree. In 1880 the man who travelled about England with a set of golf clubs was an object of some astonishment, almost of alarm, to his fellow-travellers. In those days the commonest of questions in regard to the game was, "You have to be a fine rider, do you not, to play golf?" so confounded was it in the popular mind with the game of polo. At Blackheath a few Scotsmen resident in London had long played golf. In 1864 the Royal North Devon Club was formed at Westward Ho, and this was the first of the seaside links discovered and laid out for golf in England. In 1869 the Royal Liverpool Club established itself in possession of the second English course of this quality at Hoylake, in Cheshire. A golf club was formed in connexion with the London Scottish Volunteers corps, which had its house on the Putney end of Wimbledon Common on Putney Heath; and, after making so much of a start, the progress of the game was slow, though steady, for many years. A few more clubs were formed; the numbers of golfers grew; but it could not be said that the game was yet in any sense popular in England. All at once, for no very obvious reason, the qualities of the ancient Scottish game seemed to strike home, and from that moment its popularity has been wonderfully and increasingly great. The English links that rose into most immediate favour was the fine course of the St George's Golf Club, near Sandwich, on the coast of Kent. To the London golfer it was the first course of the first class that was reasonably accessible, and the fact made something like an epoch in English golf. A very considerable increase, it is true, in the number of English golfers and English golf clubs had taken place before the discovery for golfing purposes of the links at Sandwich.

¹ Anonymous author of MS. in the Harcourt Library.

² See *History of Leith*, by A. Campbell (1827).

³ *Local Records of Northumberland*, by John Sykes (Newcastle, 1833).

⁴ *Robertson's Historical Notices of Leith*.

Already there was a chain of links all round the coast, besides numerous inland courses; but since 1800 their increase has been extraordinary, and the number which has been formed in the colonies and abroad is very large also, so that in the *Golfer's Year Book* for 1906 a space of over 300 pages was allotted to the Club Directory alone, each page containing, on a rough average, six clubs. To compute the average membership of these clubs is very difficult. There is not a little overlapping, in the sense that a member of one club will often be a member of several others; but probably the average may be placed at something like 200 members for each club.

The immense amount of golf-playing that this denotes, the large industry in the making of clubs and balls, in the upkeep of links, in the actual work of club-carrying by the caddies, and in the instruction given by the professional class, is obvious. Golf has taken a strong hold on the affections of the people in many parts of Ireland, and the fashion for golf in England has reacted strongly on Scotland itself, the ancient home of the game, where since 1880 golfers have probably increased in the ratio of forty to one. Besides the industry that such a growth of the game denotes in the branches immediately connected with it, as mentioned above, there is to be taken into further account the visiting population that it brings to all lodging-houses and hotels within reach of a tolerable golf links, so that many a fishing village has risen into a moderate watering-place by virtue of no other attractions than those which are offered by its golf course. Therefore to the Briton, golf has developed from something of which he had a vague idea—as of "curling"—to something in the nature of an important business, a business that can make towns and has a considerable effect on the receipts of railway companies.

Moreover, ladies have learned to play golf. Although this is a crude and brief sentence, it does not state the fact too widely nor too forcibly, for though it is true that before 1885 many played on the short links of St Andrews, North Berwick, Westward Ho and elsewhere, still it was virtually unknown that they should play on the longer courses, which till then had been in the undisputed possession of the men. At many places women now have their separate links, at others they play on the same course as the men. But even where links are set apart for women, they are far different from the little courses that used to be assigned to them. They are links only a little less formidable in their bunkers, a little less varied in their features than those of men. The ladies have their annual championship, which they play on the long links of the men, sometimes on one, sometimes on another, but always on courses of the first quality, demanding the finest display of golfing skill.

The claim that England made to a golfing fellowship with Scotland was conceded very strikingly by the admission of three English greens, first those of Hoylake and of Sandwich, and in 1909 Deal, into the exclusive list of the links on which the open championship of the game is decided. Before England had so fully assimilated Scotland's game this great annual contest was waged at St Andrews, Musselburgh and Prestwick in successive years. Now the ancient green of Musselburgh, somewhat worn out with length of hard and gallant service, and moreover, as a nine-holes course inadequately accommodating the numbers who compete in the championships to-day, has been superseded by the course at Muirfield as a championship arena.

While golf had been making itself a force in the southern kingdom, the professional element—men who had learned the game from childhood, had become past-masters, were capable of giving instruction, and also of making clubs and balls and looking after the greens on which golf was played—had at first been taken from the northern side of the Border. But when golf had been started long enough in England for the little boys who were at first employed as "caddies"—in carrying the players' clubs—to grow to sufficient strength to drive the ball as far as their masters, it was inevitable that out of the number who thus began to play in their boyhood some few should develop an exceptional talent for the game. This, in fact, actually happened, and English golfers, both of the amateur

and the professional classes, have proved themselves so adept at Scotland's game, that the championships in either the Open or the Amateur competitions have been won more often by English than by Scottish players of late years. Probably in the United Kingdom to-day there are as many English as Scottish professional golf players, and their relative number is increasing.

Golf also "caught on," to use the American expression, in the United States. To the American of 1890 golf was largely an unknown thing. Since then, however, golf has become perhaps a greater factor in the life of the upper and upper-middle classes in the United States than it ever has been in England or Scotland. Golf to the English and the Scots meant only one among several of the sports and pastimes that take the man and the woman of the upper and upper-middle classes into the country and the fresh air. To the American of like status golf came as the one thing to take him out of his towns and give him a reason for exercise in the country. To-day golf has become an interest all over North America, but it is in the Eastern States that it has made most difference in the life of the classes with whom it has become fashionable. Westerners and Southerners found more excuses before the coming of golf for being in the open country air. It is in the Eastern States more especially that it has had so much influence in making the people live and take exercise out of doors. In a truly democratic spirit the American woman golfer plays on a perfect equality with the American man. She does not compete in the men's championships; she has championships of her own; but she plays, without question, on the same links. There is no suggestion of relegating her, as a certain cynical writer in the *Badminton* volume on golf described it, to a waste corner, a kind of "Jews' Quarter," of the links. And the Americans have taken up golf in the spirit of a sumptuous and opulent people, spending money on magnificent clubhouses beyond the finest dreams of the Englishman or the Scot. The greatest success achieved by any American golfer fell to the lot of Mr Walter Travis of the Garden City club, who in 1904 won the British amateur championship.

So much enthusiasm and so much golf in America have not failed to make their influence felt in the United Kingdom. Naturally and inevitably they have created a strong demand for professional instruction, both by example and by precept, and for professional advice and assistance in the laying-out and upkeep of the many new links that have been created in all parts of the States, sometimes out of the least promising material. By the offer of great prizes for exhibition matches, and of wages that are to the British rate on the scale of the dollar to the shilling, they have attracted many of the best Scottish and English professionals to pay them longer or shorter visits as the case may be, and thus a new opening has been created for the energies of the professional golfing class.

The Game.—The game of golf may be briefly defined as consisting in hitting the ball over a great extent of country, preferably of that sand-hill nature which is found by the sea-side, and finally hitting or "putting" it into a little hole of some 4 in. diameter cut in the turf. The place of the hole is commonly marked by a flag. Eighteen is the recognized number of these holes on a full course, and they are at varying distances apart, from 100 yds. up to anything between $\frac{1}{2}$ and $\frac{3}{4}$ m. For the various strokes required to achieve the hitting of the ball over the great hills, and finally putting it into the small hole, a number of different "clubs" has been devised to suit the different positions in which the ball may be found and the different directions in which it is wished to propel it. At the start for each hole the ball may be placed on a favourable position (e.g. "tee'd" on a small mound of sand) for striking it, but after that it may not be touched, except with the club, until it is hit into the next hole. A "full drive," as the farthest distance that the ball can be hit is called, is about 200 yds. in length, of which some three-fourths will be traversed in the air, and the rest by bounding or running over the ground. It is easily to be understood that when the ball is lying on the turf behind a tall sand-hill, or in a bunker, a differently-shaped club is required for raising it over such an obstacle from that which is needed

when it is placed on the tee to start with; and again, that another club is needed to strike the ball out of a cup or out of heavy grass. It is this variety that gives the game its charm. Each player plays with his own ball, with no interference from his opponent, and the object of each is to hit the ball from the starting-point into each successive hole in the fewest strokes. The player who at the end of the round (i.e. of the course of eighteen holes) has won the majority of the holes is the winner of the round; or the decision may be reached before the end of the round by one side gaining more holes than there remain to play. For instance, if one player be four holes to the good, and only three holes remain to be played, it is evident that the former must be the winner, for even if the latter win every remaining hole, he still must be one to the bad at the finish.

The British Amateur Championship is decided by a tournament in matches thus played, each defeated player retiring, and his opponent passing on into the next round. In the case of the Open Championship, and in most medal competitions, the scores are differently reckoned—each man's total score (irrespective of his relative merit at each hole) being reckoned at the finish against the total score of the other players in the competition. There is also a species of competition called "bogey" play, in which each man plays against a "bogey" score—a score fixed for each hole in the round before starting—and his position in the competition relatively to the other players is determined by the number of holes that he is to the good or to the bad of the "bogey" score at the end of the round. The player who is most holes to the good, or fewest holes to the bad, wins the competition. It may be mentioned incidentally that golf occupies the almost unique position of being the only sport in which even a single player can enjoy his game, his opponent in this event being "Colonel Bogey"—more often than not a redoubtable adversary.

The links which have been thought worthy, by reason of their geographical positions and their merits, of being the scenes on which the golf championships are fought out, are, as we have already said, three in Scotland—St Andrews, Prestwick and Muirfield—and three in England—Hoylake, Sandwich and Deal. This brief list is very far from being complete as regards links of first-class quality in Great Britain. Besides those named, there are in Scotland—Carnoustie, North Berwick, Cruden Bay, Nairn, Aberdeen, Dornoch, Troon, Machrihanish, South Uist, Islay, Gullane, Luffness and many more. In England there are—Westward Ho, Bembridge, Littlestone, Great Yarmouth, Brancaster, Seaton Carew, Forby, Lytham, Harlech, Burnham, among the seaside ones; while of the inland, some of them of very fine quality, we cannot even attempt a selection, so large is their number and so variously estimated their comparative merits. Ireland has Portrush, Newcastle, Portsalon, Dollymount and many more of the first class; and there are excellent courses in the Isle of Man. In America many fine courses have been constructed. There is not a British colony of any standing that is without its golf course—Australia, India, South Africa, all have their golf championships, which are keenly contested. Canada has had courses at Quebec and Montreal for many years, and the Calcutta Golf Club, curiously enough, is the oldest established (next to the Blackheath Club), the next oldest being the club at Pau in the Basées-Pyrénées.

The Open Championship of golf was started in 1860 by the Prestwick Club giving a belt to be played for annually under the condition that it should become the property of any who could win it thrice in succession. The following is the list of the champions:—

1860.	W. Park, Musselburgh	174—at Prestwick.
1861.	Tom Morris, sen., Prestwick	163—at Prestwick.
1862.	Tom Morris, sen., Prestwick	163—at Prestwick.
1863.	W. Park, Musselburgh	168—at Prestwick.
1864.	Tom Morris, sen., Prestwick	160—at Prestwick.
1865.	A. Strath, St Andrews	162—at Prestwick.
1866.	W. Park, Musselburgh	169—at Prestwick.
1867.	Tom Morris, sen., St Andrews	170—at Prestwick.
1868.	Tom Morris, jun., St Andrews	154—at Prestwick.
1869.	Tom Morris, jun., St Andrews	157—at Prestwick.
1870.	Tom Morris, jun., St Andrews	149—at Prestwick.

Tom Morris, junior, thus won the belt finally, according to the conditions. In 1871 there was no competition; but by 1872 the three clubs of St Andrews, Prestwick and Musselburgh had subscribed for a cup which should be played for over the course of each subscribing club successively, but should never become the property of the winner. In later years the course at Muirfield was substituted for that at Musselburgh, and Hoylake and Sandwich were admitted into the list of championship courses. Up to 1891, inclusive, the play of two rounds, or thirty-six holes, determined the championship, but from 1892 the result has been determined by the play of 72 holes

After the interregnum of 1871, the following were the champions:—

1872.	Tom Morris, jun., St Andrews	166—at Prestwick.
1873.	Tom Kidd, St Andrews	179—at St Andrews.
1874.	Mungo Park, Musselburgh	159—at Musselburgh.
1875.	Willie Park, Musselburgh	166—at Prestwick.
1876.	Bob Martin, St Andrews	176—at St Andrews.
1877.	Jamie Anderson, St Andrews	160—at Musselburgh.
1878.	Jamie Anderson, St Andrews	157—at Prestwick.
1879.	Jamie Anderson, St Andrews	170—at St Andrews.
1880.	Bob Fergusson, Musselburgh	162—at Musselburgh.
1881.	Bob Fergusson, Musselburgh	170—at Prestwick.
1882.	Bob Fergusson, Musselburgh	171—at St Andrews.
1883.	W. Fernie, Dumfries	159—at Musselburgh.
1884.	Jack Simpson, Carnoustie	160—at Prestwick.
1885.	Bob Martin, St Andrews	171—at St Andrews.
1886.	D. Brown, Musselburgh	157—at Musselburgh.
1887.	Willie Park, jun., Musselburgh	161—at Prestwick.
1888.	Jack Burns, Warwick	171—at St Andrews.
1889.	Willie Park, jun., Musselburgh	155—at Musselburgh.
1890.	Mr John Ball, jun., Hoylake	164—at Prestwick.
1891.	Hugh Kirkaldy, St Andrews	166—at St Andrews.
1892.	Mr H. H. Hilton, Hoylake	305—at Muirfield.
1893.	W. Auchterlonie, St Andrews	322—at Prestwick.
1894.	J. H. Taylor, Winchester	326—at Sandwich.
1895.	J. H. Taylor, Winchester	322—at St Andrews.
1896.	H. Vardon, Scarborough	316—at Muirfield.
1897.	Mr H. H. Hilton, Hoylake	314—at Hoylake.
1898.	H. Vardon, Scarborough	307—at Prestwick.
1899.	H. Vardon, Scarborough	310—at Sandwich.
1900.	J. H. Taylor, Richmond	309—at St Andrews.
1901.	J. Braid, Romford	309—at Muirfield.
1902.	A. Herd, Huddersfield	307—at Hoylake.
1903.	H. Vardon, Ganton	300—at Prestwick.
1904.	J. White, Sunningdale	296—at Sandwich.
1905.	J. Braid, Walton Heath	318—at St Andrews.
1906.	J. Braid, Walton Heath	300—at Muirfield.
1907.	Arnaud Massey, La Boulie	312—at Hoylake.
1908.	J. Braid, Walton Heath	291—at Prestwick.
1909.	J. H. Taylor, Richmond	295—at Deal.
1910.	J. Braid, Walton Heath	298—at St Andrews.

The Amateur Championship is of far more recent institution.

1886.	Mr Horace Hutchinson	at St Andrews.
1887.	Mr Horace Hutchinson	at Hoylake.
1888.	Mr John Ball	at Prestwick.
1889.	Mr J. E. Laidlay	at St Andrews.
1890.	Mr John Ball	at Hoylake.
1891.	Mr J. E. Laidlay	at St Andrews.
1892.	Mr John Ball	at Sandwich.
1893.	Mr P. Anderson	at Prestwick.
1894.	Mr John Ball	at Hoylake.
1895.	Mr L. Balfour-Mélville	at St Andrews.
1896.	Mr F. G. Tait	at Sandwich.
1897.	Mr J. T. Allan	at Muirfield.
1898.	Mr John Ball	at Prestwick.
1899.	Mr F. G. Tait	at Hoylake.
1900.	Mr H. H. Hilton	at Sandwich.
1901.	Mr H. H. Hilton	at St Andrews.
1902.	Mr C. Hutchings	at Hoylake.
1903.	Mr R. Maxwell	at Muirfield.
1904.	Mr W. J. Travis	at Sandwich.
1905.	Mr A. G. Barry	at St Andrews.
1906.	Mr J. Robb	at Hoylake.
1907.	Mr John Ball	at St Andrews.
1908.	Mr E. A. Lassen	at Sandwich.
1909.	Mr Robert Maxwell	at Muirfield.
1910.	Mr John Ball	at Hoylake.

The Ladies' Championship was started in 1893.

1893.	Lady M. Scott	at St Annes.
1894.	Lady M. Scott	at Littlestone.
1895.	Lady M. Scott	at Portrush.
1896.	Miss A. B. Pascoe	at Hoylake.
1897.	Miss E. C. Orr	at Gullane.
1898.	Miss L. Thompson	at Yarmouth.
1899.	Miss M. Hezlet	at Newcastle.
1900.	Miss R. K. Adair	at Westward Ho.
1901.	Miss M. A. Graham	at Aberdovy.
1902.	Miss M. Hezlet	at Deal.
1903.	Miss R. K. Adair	at Portrush.
1904.	Miss L. Dod	at Troon.
1905.	Miss B. Thompson	at Cromer.
1906.	Mrs Kennion	at Burnham.
1907.	Miss M. Hezlet	at Newcastle(Co.Down).
1908.	Miss M. Titterton	at St Andrews.
1909.	Miss D. Campbell	at Birkdale.
1910.	Miss Grant Suttie	at Westward Ho.

There have been some slight changes of detail and arrangement as time has gone on, in the rules of the game (the latest edition

of the Rules should be consulted). A new class of golfer has arisen, requiring a code of rules framed rather more exactly than the older code. The Scottish golfer, who was "teethed" on a golf club, as Mr Andrew Lang has described it, imbibed all the traditions of the game with his natural sustenance. Very few rules sufficed for him. But when the Englishman, and still more the American (less in touch with the traditions), began to play golf as a new game, then they began to ask for a code of rules that should be lucid and illuminating on every point—an ideal perhaps impossible to realize. It was found, at least, that the code put forward by the Royal and Ancient Club of St Andrews did not realize it adequately. Nevertheless the new golfers were very loyal indeed to the club that had ever of old held, by tacit consent, the position of fount of golfing legislation. The Royal and Ancient Club was appealed to by English golfers to step into the place, analogous to that of the Marylebone Cricket Club in cricket, that they were both willing and anxious to give it. It was a place that the Club at St Andrews did not in the least wish to occupy, but the honour was thrust so insistently upon it, that there was no declining. The latest effort to meet the demands for some more satisfactory legislation on the thousand and one points that continually must arise for decision in course of playing a game of such variety as golf, consists of the appointment of a standing committee, called the "Rules of Golf Committee." Its members all belong to the Royal and Ancient Club; but since this club draws its membership from all parts of the United Kingdom, this restriction is quite consistent with a very general representation of the views of north, south, east and west—from Westward Ho and Sandwich to Dornoch, and all the many first-rate links of Ireland—on the committee. Ireland has, indeed, some of the best links in the kingdom, and yields to neither Scotland nor England in enthusiasm for the game. This committee, after a general revision of the rules into the form in which they now stand, consider every month, either by meeting or by correspondence, the questions that are sent up to it by clubs or by individuals; and the committee's answers to these questions have the force of law until they have come before the next general meeting of the Royal and Ancient Club at St Andrews, which may confirm or may reject them at will. The ladies of Great Britain manage otherwise. They have a Golfing Union which settles questions for them; but since this union itself accepts as binding the answers given by the Rules of Golf Committee, they really arrive at the same conclusions by a slightly different path. Nor does the American Union, governing the play of men and women alike in the States, really act differently. The Americans naturally reserve to themselves freedom to make their own rules, but in practice they conform to the legislation of Scotland, with the exception of a more drastic definition of the status of the amateur player, and certain differences as to the clubs used.

A considerable modification has been effected in the implements of the game. The tendency of the modern wooden clubs is to be short in the head as compared with the clubs of, say, 1880 or 1885. The advantage claimed (probably with justice) for this shape is that it masses the weight behind the point on which the ball is struck. Better material in the wood of the club is a consequence of the increased demand for these articles and the increased competition among their makers. Whereas under the old conditions a few workers at the few greens then in existence were enough to supply the golfing wants, now there is a very large industry in golf club and ball making, which not only employs workers in the local club-makers' shops all the kingdom over, but is an important branch of the commerce of the stores and of the big athletic outfitters, both in Great Britain and in the United States. By far the largest modification in the game since the change to gutta-percha balls from balls of leather-covering stuffed with feathers, is due to the American invention of the india-rubber cased balls. Practically it is an American invention that it is still regarded, although the British law courts decided, after a lengthy trial (1905), that there had been "prior users" of the principle of the balls' manufacture, and therefore that the patent of Mr Haskell, by whose name the

first balls of the kind were called, was not good. It is singular to remark that in the first introduction of the gutta-percha balls, superseding the leather and feather compositions, they also were called by the name of their first maker, "Gourlay." The general mode of manufacture of the rubber-cored ball, which is now everywhere in use, is interiorly, a hard core of gutta-percha or some other such substance; round this is wound, by machinery, india-rubber thread or strips at a high tension, and over all is an outer coat of gutta-percha. Some makers have tried to dispense with the kernel of hard substance, or to substitute for it kernels of some fluid or gelatinous substance, but in general the above is a sufficient, though rough, description of the mode of making all these balls. Their superiority over the solid gutta-percha lies in their superior resiliency. The effect is that they go much more lightly off the club. It is not so much in the tee-shots that this superiority is observed, as in the second shots, when the ball is lying badly; balls of the rubber-cored kind, with their greater liveliness, are more easy to raise in the air from a lie of this kind. They also go remarkably well off the iron clubs, and thus make the game easier by placing the player within an iron shot of the hole at a distance at which he would have to use a wooden club if he were playing with a solid gutta-percha ball. They also tend to make the game more easy by the fact that if they are at all mis-hit they go much better than a gutta-percha ball similarly inaccurately struck. As a slight set-off against these qualities, the ball, because of the greater liveliness, is not quite so good for the short game as the solid ball; but on the whole its advantages distinctly overbalance its disadvantages.

When these balls were first put on the market they were sold at two shillings each and even, when the supply was quite unequal to the demand, at a greater deal higher price, rising to as much as a guinea a ball. But the normal price, until about a year after the decision in the British courts of law affirming that there was no patent in the balls, was always two shillings for the best quality of ball. Subsequently there was a reduction down to one shilling for the balls made by many of the manufacturing companies, though in 1910 the rise in the price of rubber sent up the cost. The rubber-cored ball does not go out of shape so quickly as the gutta-percha solid ball and does not show other marks of ill-usage with the club so obviously. It has had the effect of making the game a good deal easier for the second- and third-class players, favouring especially those who were short drivers with the old gutta-percha ball. To the best players it has made the least difference, nevertheless those who were best with the old ball are also best with the new; its effect has merely been to bring the second, third and fourth best closer to each other and to the best.

Incidentally, the question of the expense of the game has been touched on in this notice of the new balls. There is no doubt that the balls themselves tend to a greater economy, not only because of their own superior durability but also because, as a consequence of their greater resiliency, they are not nearly so hard on the clubs, and the clubs themselves being perhaps made of better material than used to be given to their manufacture, the total effect is that a man's necessary annual expenditure on them is very small indeed even though he plays pretty constantly. Four or five rounds are not more than the average of golfers will make an india-rubber cored ball last them, so that the outlay on the weapons is very moderate. On the other hand the expenditure of the clubs on their courses has increased and tends to increase. Demands are more insistent than they used to be for a well kept course, for perfectly mown greens, renewed teeing grounds and so on, and probably the modern golfer is a good deal more luxurious in his clubhouse wants than his father used to be. This means a big staff of servants and workers on the green, and to meet this a rather heavy subscription is required. Such a subscription as five guineas added to a ten or fifteen guinea entrance fee is not uncommon, and even this is very moderate compared with the subscriptions to some of the clubs in the United States, where a hundred dollars a year, or twenty pounds of our money, is not unusual. But on the whole golf is a very economical pastime, as compared with almost

any other sport or pastime which engages the attention of Britons, and it is a pastime for all the year round, and for all the life of a man or woman.

Glossary of Technical Terms used in the Game.

- Addressing the Ball.**—Putting oneself in position to strike the ball.
- All Square.**—Term used to express that the score stands level, neither side being a hole up.
- Baff.**—To strike the ground with the club when playing, and so loft the ball unduly.
- Baffy.**—A short wooden club, with laid-back face, for lofting shots.
- Bogey.**—The number of strokes which a good average player should take to each hole. This imaginary player is usually known as "Colonel Bogey," and plays a fine game.
- Brassy.**—A wooden club with a brass sole.
- Bulger.**—A driver in which the face "bulges" into a convex shape. The head is shorter than in the older-fashioned driver.
- Bunker.**—A sand-pit.
- Bye.**—The holes remaining after one side has become more holes up than remain for play.
- Caddie.**—The person who carries the clubs. Diminutive of "cad"; cf. laddie (from Fr. *cadet*).
- Cleek.**—The iron-headed club that is capable of the farthest drive of any of the clubs with iron heads.
- Cup.**—A depression in the ground causing the ball to lie badly.
- Dead.**—A ball is said to be "dead" when so near the hole that the putting it in in the next stroke is a "dead" certainty. A ball is said to "fall dead" when it pitches with hardly any run.
- Divot.**—A piece of turf cut out in the act of playing, which, be it noted, should always be replaced before the player moves on.
- Dormy.**—One side is said to be "dormy" when it is as many holes to the good as remain to be played—so that it cannot be beaten.
- Driver.**—The longest driving club, used when the ball lies very well and a long shot is needed.
- Foosle.**—Any very badly missed or bungled stroke.
- Fore!**—A cry of warning to people in front.
- Foursome.**—A match in which four persons engage, two on each side playing alternately with the same ball.
- Green.**—(a) The links as a whole; (b) the "putting-greens" around the holes.
- Grip.**—(a) The part of the club-shaft which is held in the hands while playing; (b) the grasp itself—e.g. "a firm grip," "a loose grip," are common expressions.
- Half-Shot.**—A shot played with something less than a full swing.
- Halved.**—A hole is "halved" when both sides have played it in the same number of strokes. A round is "halved" when each side has won and lost the same number of holes.
- Handicap.**—The strokes which a player receives either in match play or competition.
- Hanging.**—Said of a ball that lies on a slope inclining downwards in regard to the direction in which it is wished to drive.
- Hazard.**—A general term for bunker, whin, long grass, roads and all kinds of bad ground.
- Head.**—To hit the ball on the "heel" of the club, i.e. the part of the face nearest the shaft, and so send the ball to the right, with the same result as from a slice.
- Honour.**—The privilege (which its holder is not at liberty to decline) of striking off first from the tee.
- Iron.**—An iron-headed club intermediate between the cleek and lofting mashie. There are driving irons and lofting irons according to the purposes for which they are intended.
- Lie.**—(a) The angle of the club-head with the shaft (e.g. a "flat lie," "an upright lie"); (b) the position of the ball on the ground (e.g. "a good lie," "a bad lie").
- Like The.**—The stroke which makes the player's score equal to his opponent's in course of playing a hole.
- Like-as-we-Lie.**—Said when both sides have played the same number of strokes.
- Line.**—The direction in which the hole towards which the player is progressing lies with reference to the present position of his ball.
- Mashie.**—An iron club with a short head. The lofting mashie has the blade much laid back, for playing a short lofting shot. The driving mashie has the blade less laid back, and is used for longer, less lofted shots.
- Match-Play.**—Play in which the score is reckoned by holes won and lost.
- Modal-Play.**—Play in which the score is reckoned by the total of strokes taken on the round.
- Niblick.**—A short stiff club with a short, laid back, iron head, used for getting the ball out of a very bad lie.
- Odd-The.**—A stroke more than the opponent has played.
- Press.**—To strive to hit harder than you can hit with accuracy.
- Pull.**—To hit the ball with a pulling movement of the club, so as to make it curve to the left.
- Putt.**—To play the short strokes near the hole (pronounced as in "put").
- Putter.**—The club used for playing the short strokes near the hole. Some have a wooden head, some an iron head.

Rub-of-the-Green.—Any chance deflection that the ball receives as it goes along.

Kiss Up.—To send the ball low and close to the ground in approaching the hole—opposite to lofting it up.

Scratch Player.—Player who receives no odds in handicap competitions.

Slice.—To hit the ball with a cut across it, so that it flies curving to the right.

Stance.—(a) The place on which the player has to stand when playing—a.g., "a bad stance," "a good stance," are common expressions; (b) the position relative to each other of the player's feet.

Stymie.—When one ball lies in a straight line between another and the hole the first is said to "stymie," or "to be a stymie to" the other—from an old Scottish word given by Jamieson to mean "the faintest form of anything." The idea probably was, the "stymie" only left you the "faintest form" of the hole to aim at.

Tea.—The little mound of sand on which the ball is generally placed for the first drive to each hole.

Teeing-Ground.—The place marked as the limit, outside of which it is not permitted to drive the ball off. This marked-out ground is also sometimes called "the tea."

Top.—To hit the ball above the centre, so that it does not rise much from the ground.

Up.—A player is said to be "one up," "two up," &c., when he is so many holes to the good of his opponent.

Wrist-Shot.—A shot less in length than a half-shot, but longer than a putt.

BIBLIOGRAPHY.—The literature of the game has grown to some considerable bulk. For many years it was practically comprised in the fine work by Mr Robert Clark, *Golf: A Royal and Ancient Game*, together with two handbooks on the game by Mr Chambers and by Mr Forgan respectively, and the *Golfiana Miscellanea* of Mr Stewart. A small book by Mr Horace Hutchinson, named *Hints on Golf*, was very shortly followed by a much more important work by Sir Walter Simpson, Bart., called *The Art of Golf*, a title which sufficiently explains itself. The Badminton Library book on *Golf* attempted to collect into one volume the most interesting historical facts known about the game, with *obiter dicta* and advice to learners, and, on similar didactic lines, books have been written by Mr H. C. S. Everard, Mr Garden Smith and W. Park, the professional player. Mr H. J. Whigham, sometime amateur champion golfer of the United States, has given us a book about the game in that country. *The Book of Golf and Golfers*, compiled, with assistance, by Mr Horace Hutchinson, is in the first place a picture-gallery of famous golfers in their respective attitudes of play. Taylor, Vardon and Braid have each contributed a volume of instruction, and Mr G. W. Beldam has published a book with admirable photographs of players in action, called *Great Golfers: their Methods at a Glance*. A work intended for the use of green committees is among the volumes of the *Country Life Library of Sport*. Much interesting lore is contained in the *Golfing Annual*, in the *Golfer's Year Book* and in the pages of *Golf*, which has now become *Golf Illustrated*, a weekly paper devoted to the game. Among works that have primarily a local interest, but yet contain much of historical value about the game, may be cited the *Golf Book of East Lothian*, by the Rev. John Keir, and the *Chronicle of Blackheath Golfers*, by Mr W. E. Hughes. (H. G. H.)

GOLIAD, an unincorporated village and the county-seat of Goliad county, Texas, U.S.A., on the N. bank of the San Antonio river, 85 m. S.E. of San Antonio. Pop. (1900) about 1700. It is served by the Galveston, Harrisburg & San Antonio railway (Southern Pacific System). Situated in the midst of a rich farming and stock-raising country, Goliad has flour mills, cotton gins and cotton-seed oil mills. Here are the interesting ruins of the old Spanish mission of La Bahia, which was removed to this point from the Guadalupe river in 1747. During the struggle between Mexico and Spain the Mexican leader Bernardo Gutierrez (1778-1814) was besieged here. The name Goliad, probably an anagram of the name of the Mexican patriot Hidalgo (1753-1811), was first used about 1829. On the outbreak of the Texan War of Liberation Goliad was garrisoned by a small force of Mexicans, who surrendered to the Texans in October 1835, and on the 20th of December a preliminary "declaration of independence" was published here, antedating by several months the official Declaration issued at Old Washington, Texas, on the 2nd of March 1836. In 1836, when Santa Anna began his advance against the Texan posts, Goliad was occupied by a force of about 350 Americans under Colonel James W. Fannin (c. 1800-1836), who was overtaken on the Coletto Creek while attempting to carry out orders to withdraw from Goliad and to unite with General Houston; he surrendered after a sharp fight (March 19-20) in which he inflicted a heavy loss on the Mexicans, and was marched back with his force to Goliad, where on the morning of the 27th of March they were shot down by Santa Anna's

orders. Goliad was nearly destroyed by a tornado on the 19th of May 1903.

GOLIARD, a name applied to those wandering students (*vagantes*) and clerks in England, France and Germany, during the 12th and 13th centuries, who were better known for their rioting, gambling and intemperance than for their scholarship. The derivation of the word is uncertain. It may come from the Lat. *gula*, gluttony (Wright), but was connected by them with a mythical "Bishop Goliath," also called "*archipöeta*" and "*primas*"—especially in Germany—in whose name their satirical poems were mostly written. Many scholars have accepted Büdinger's suggestion (*Über einige Reste der Vagantenpoesie in Osterreich*, Vienna, 1854) that the title of Goliath goes back to the letter of St Bernard to Innocent II., in which he referred to Abelard as Goliath, thus connecting the goliards with the keen-witted student adherents of that great medieval critic. Giesebrecht and others, however, support the derivation of goliard from *gailliard*, a gay fellow, leaving "Goliath" as the imaginary "patron" of their fraternity.

Spiegel has ingeniously disentangled something of a biography of an *archipöeta* who flourished mainly in Burgundy and at Salzburg from 1160 to beyond the middle of the 13th century; but the proof of the reality of this individual is not convincing. It is doubtful, too, if the jocular references to the rules of the "gild" of goliards should be taken too seriously, though their aping of the "orders" of the church, especially their contrasting them with the mendicants, was too bold for church synods. Their satires were almost uniformly directed against the church, attacking even the pope. In 1227 the council of Trèves forbade priests to permit the goliards to take part in chanting the service. In 1229 they played a conspicuous part in the disturbances at the university of Paris, in connexion with the intrigues of the papal legate. During the century which followed they formed a subject for the deliberations of several church councils, notably in 1289 when it was ordered that "no clerks shall be jongleurs, goliards or buffoons," and in 1300 (at Cologne) when they were forbidden to preach or engage in the indulgence traffic. This legislation was only effective when the "privileges of clergy" were withdrawn from the goliards. Those historians who regard the middle ages as completely dominated by ascetic ideals, regard the goliard movement as a protest against the spirit of the time. But it is rather indicative of the wide diversity in temperament among those who crowded to the universities in the 13th century, and who found in the privileges of the clerk some advantage and attraction in the student life. The goliard poems are as truly "medieval" as the monastic life which they despised; they merely voice another section of humanity. Yet their criticism was most keenly pointed, and marks a distinct step in the criticism of abuses in the church.

Along with these satires went many poems in praise of wine and riotous living. A remarkable collection of them, now at Munich, from the monastery at Benedictbeuren in Bavaria, was published by Schmeller (3rd ed., 1895) under the title *Carmina Burana*. Many of these, which form the main part of song-books of German students to-day, have been delicately translated by John Addington Symonds in a small volume, *Wine, Women and Song* (1884). As Symonds has said, they form a prelude to the Renaissance. The poems of "Bishop Goliath" were later attributed to Walter Mapes, and have been published by Thomas Wright in *The Latin Poems commonly attributed to Walter Mapes* (London, 1841).

The word "goliard" itself outlived these turbulent bands which had given it birth, and passed over into French and English literature of the 14th century in the general meaning of jongleur or minstrel, quite apart from any clerical association. It is thus used in *Piers Plowman*, where, however, the goliard still rhymes in Latin, and in Chaucer.

See, besides the works quoted above, M. Haenzner, *Goliardendichtung und die Satire im 13ten Jahrhundert in England* (Leipzig, 1905); Spiegel, *Die Vaganten und ihr "Orden"* (Spire, 1892); Hubatsch, *Die lateinischen Vagantlieder des Mittelalters* (Görlitz, 1870); and the article in *La grande Encyclopédie*. All of these have bibliographical apparatus. (J. T. S. *)

GOLIATH, the name of the giant by slaying whom David achieved renown (1 Sam. xvii.). The Philistines had come up to make war against Saul and, as the rival camps lay opposite each other, this warrior came forth day by day to challenge to single combat. Only David ventured to respond, and armed with a sling and pebbles he overcame Goliath. The Philistines, seeing their champion killed, lost heart and were easily put to flight. The giant's arms were placed in the sanctuary, and it was his famous sword which David took with him in his fight from Saul (1 Sam. xxi. 1-9). From another passage we learn that Goliath of Gath, "the shaft of whose spear was like a weaver's beam," was slain by a certain Elhanan of Bethlehem in one of David's conflicts with the Philistines (2 Sam. xxi. 18-22)—the parallel 1 Chron. xx. 5, avoids the contradiction by reading the "brother of Goliath." But this old popular story has probably preserved the more original tradition, and if Elhanan is the son of Dodo in the list of David's mighty men (2 Sam. xxiii. 9, 24), the resemblance between the two names may have led to the transference. The narratives of David's early life point to some exploit by means of which he gained the favour of Saul, Jonathan and Israel, but the absence of all reference to his achievement in the subsequent chapters (1 Sam. xxi. 11, xxix. 5) is evidence of the relatively late origin of a tradition which in course of time became one of the best-known incidents in David's life (Pa. cxliv., LXX. title, the apocryphal Pa. cli., Eclus. xiv. 4).

See **DAVID**; **SAMUEL** (BOOKS) and especially Cheyne, *Aids and Deeds of Criticism*, pp. 80 sqq., 125 sqq. In the old Egyptian romance of *Siwukhi* (ascribed to about 2000 B.C.), the story of the slaying of the Bedouin hero has several points of resemblance with that of David and Goliath. See L. B. Paton, *Hist. of Syr. and Pal.* p. 60; A. Jeremia, *Das A. T. im Lichte d. alten Orients*, 2nd ed. pp. 299, 491; A. R. S. Kennedy, *Century Bible: Samuel*, p. 122, argues that David's Philistine adversary was originally nameless, in 1 Sam. xvii. he is named only in v. 4.

GOLITSUIN, BORIS ALEKSYEVICH (1654-1714), Russian statesman, came of a princely family, claiming descent from Prince Gedimin of Lithuania. Earlier members of the family were Mikhail (d. c. 1552), a famous soldier, and his great-grandson Vasily Vasilevich (d. 1619), who was sent as ambassador to Poland to offer the Russian crown to Prince Ladislaus. Boris became court chamberlain in 1676. He was the young tsar Peter's chief supporter when, in 1689, Peter resisted the usurpations of his elder sister Sophia, and the head of the loyal council which assembled at the Troitsa monastery during the crisis of the struggle. Golitsuin it was who suggested taking refuge in that strong fortress and won over the boyars of the opposite party. In 1690 he was created a boyar and shared with Lev Narushkin, Peter's uncle, the conduct of home affairs. After the death of the tsaritsa Natalia, Peter's mother, in 1694, his influence increased still further. He accompanied Peter to the White Sea (1694-1695); took part in the Azov campaign (1695); and was one of the triumvirate who ruled Russia during Peter's first foreign tour (1697-1698). The Astrakhan rebellion (1706), which affected all the districts under his government, shook Peter's confidence in him, and seriously impaired his position. In 1707 he was superseded in the Volgan provinces by Andrei Matvyeev. A year before his death he entered a monastery. Golitsuin was a typical representative of Russian society of the end of the 17th century in its transition from barbarism to civilization. In many respects he was far in advance of his age. He was highly educated, spoke Latin with graceful fluency, frequented the society of scholars and had his children carefully educated according to the best European models. Yet this eminent, this superior personage was an habitual drunkard, an uncouth savage who intruded upon the hospitality of wealthy foreigners, and was not ashamed to seize upon any dish he took a fancy to, and send it home to his wife. It was his reckless drunkenness which ultimately ruined him in the estimation of Peter the Great, despite his previous inestimable services.

See S. Solovev, *History of Russia* (Rus.), vol. xiv. (Moscow, 1858); R. N. Bain, *The First Romanovs* (London, 1905). (R. N. B.)

GOLITSUIN, DMITRY MIKHAILOVICH (1665-1737), Russian statesman, was sent in 1697 to Italy to learn "military

affairs"; in 1704 he was appointed to the command of an auxiliary corps in Poland against Charles XII.; from 1711 to 1718 he was governor of Byelgorod. In 1718 he was appointed president of the newly erected *Kammer Kollegium* and a senator. In May 1723 he was implicated in the disgrace of the vice-chancellor Shafirov and was deprived of all his offices and dignities, which he only recovered through the mediation of the empress Catherine I. After the death of Peter the Great, Golitsuin became the recognized head of the old Conservative party which had never forgiven Peter for putting away Eudoxia and marrying the plebeian Martha Skavronskaya. But the reformers, as represented by Alexander Menshikov and Peter Tolstoi, prevailed; and Golitsuin remained in the background till the fall of Menshikov, 1727. During the last years of Peter II. (1728-1730), Golitsuin was the most prominent statesman in Russia and his high aristocratic theories had full play. On the death of Peter II. he conceived the idea of limiting the autocracy by subordinating it to the authority of the supreme privy council, of which he was president. He drew up a form of constitution which Anne of Courland, the newly elected Russian empress, was forced to sign at Mittau before being permitted to proceed to St Petersburg. Anne lost no time in repudiating this constitution, and never forgave its authors. Golitsuin was left in peace, however, and lived for the most part in retirement, till 1736, when he was arrested on suspicion of being concerned in the conspiracy of his son-in-law Prince Constantine Cantimir. This, however, was a mere pretext, it was for his anti-monarchical sentiments that he was really prosecuted. A court, largely composed of his antagonists, condemned him to death, but the empress reduced the sentence to lifelong imprisonment in Schlüsselburg and confiscation of all his estates. He died in his prison on the 14th of April 1737, after three months of confinement.

See R. N. Bain, *The Pupils of Peter the Great* (London, 1897). (R. N. B.)

GOLITSUIN, VASILY VASILEVICH (1643-1714), Russian statesman, spent his early days at the court of Tsar Alexius where he gradually rose to the rank of boyar. In 1676 he was sent to the Ukraine to keep in order the Crimean Tatars and took part in the Chigirin campaign. Personal experience of the inconveniences and dangers of the prevailing system of preferment, the so-called *vyestnichestvo*, or rank priority, which had paralysed the Russian armies for centuries, induced him to propose its abolition, which was accomplished by Tsar Theodore III. (1678). The May revolution of 1682 placed Golitsuin at the head of the *Posolsky Prikas*, or ministry of foreign affairs, and during the regency of Sophia, sister of Peter the Great, whose lover he became, he was the principal minister of state (1682-1689) and "keeper of the great seal," a title bestowed upon only two Russians before him, Athanasius Orduin-Nashchokin and Artamon Matvyeev. In home affairs his influence was insignificant, but his foreign policy was distinguished by the peace with Poland in 1683, whereby Russia at last recovered Kiev. By the terms of the same treaty, he acceded to the grand league against the Porte, but his two expeditions against the Crimea (1687 and 1689), "the First Crimean War," were unsuccessful and made him extremely unpopular. Only with the utmost difficulty could Sophia get the young tsar Peter to decorate the defeated commander-in-chief as if he had returned a victor. In the civil war between Sophia and Peter (August-September 1689), Golitsuin half-heartedly supported his mistress and shared her ruin. His life was spared owing to the supplications of his cousin Boris, but he was deprived of his boyardom, his estates were confiscated and he was banished successively to Kargopol, Mezen and Kologora, where he died on the 21st of April 1714. Golitsuin was unusually well educated. He understood German and Greek as well as his mother-tongue, and could express himself fluently in Latin. He was a great friend of foreigners, who generally alluded to him as "the great Golitsuin."

His brother MIKHAIL (1674-1730) was a celebrated soldier, who is best known for his governorship of Finland (1714-1721), where his admirable qualities earned the remembrance of the people whom he had conquered. And Mikhail's son Alexander (1718-

1783) was a diplomat and soldier, who rose to be field-marshal and governor of St Petersburg.

See R. N. Bain, *The First Romanovs* (London, 1905); A. Brückner, *Fürst Golizin* (Leipzig, 1887); S. Solovev, *History of Russia* (Rus.), vols. xiii-xiv. (Moscow, 1858, &c.). (R. N. B.)

GOLIUS or (**GOHL**), **JACOBUS** (1596-1667), Dutch Orientalist, was born at the Hague in 1596, and studied at the university of Leiden, where in Arabic and other Eastern languages he was the most distinguished pupil of Erpenius. In 1622 he accompanied the Dutch embassy to Morocco, and on his return he was chosen to succeed Erpenius (1624). In the following year he set out on a Syrian and Arabian tour from which he did not return until 1629. The remainder of his life was spent at Leiden where he held the chair of mathematics as well as that of Arabic. He died on the 28th of September 1667.

His most important work is the *Lexicon Arabico-Latinum*, fol., Leiden, 1653, which, based on the *Sikah* of Al-Jauhari, was only superseded by the corresponding work of Freytag. Among his earlier publications may be mentioned editions of various Arabic texts (*Proverbia quaedam Ahi, imperatoris Mulemici, et Carmen Tegris-podae doctissimi, necnon disertio quaedam Aben Synae, 1629*); and *Ahmedi Arabiadae sive et rerum gestarum Timari, qui vulgo Tamer-lanes dicitur, historia, 1636*). In 1656 he published a new edition with considerable additions, of the *Grammatica Arabica* of Erpenius. After his death, there was found among his papers a *Dictionarium Persico-Latinum* which was published, with additions, by Edmund Castell in his *Lexicon heptaglotton* (1669). Golius also edited, translated and annotated the astronomical treatise of Alfragan (Almuham-medis, filii Ketiri Ferganensis, qui vulgo Alfraganus dicitur, *elementa astronomica Arabice et Latina, 1669*).

GOLLNOW, a town of Germany, in the Prussian province of Pomerania, on the right bank of the Ihna, 14 m. N.N.E. of Stettin, with which it has communication by rail and steamer. Pop. (1905) 8539. It possesses two Evangelical churches, a synagogue and some small manufactures. Gollnow was founded in 1190, and was raised to the rank of a town in 1268. It was for a time a Hanse town, and came into the possession of Prussia in 1720, having belonged to Sweden since 1648.

GOLOSH, or **GALOSH** (from the Fr. *galoche*, Low Lat. *calopedes*, a wooden shoe or clog; an adaptation of the Gr. *καλοπόδιον*, a diminutive formed of *κάλον*, wood, and *πόδι*, foot), originally a woulen shoe or patten, or merely a wooden sole fastened to the foot by a strap or cord. In the middle ages "galosh" was a general term for a boot or shoe, particularly one with a wooden sole. In modern usage, it is an outer shoe worn in bad weather to protect the inner one, and keep the feet dry. Goloshes are now almost universally made of rubber, and in the United States they are known as "rubbers" simply, the word golosh being rarely if ever used. In the bootmakers' trade, a "golosh" is the piece of leather, of a make stronger than, or different from that of the "uppers," which runs around the bottom part of a boot or shoe, just above the sole.

GOLOVIN, FEDOR ALEKSYEVICH, COUNT (d. 1706), Russian statesman, learnt, like so many of his countrymen in later times, the business of a ruler in the Far East. During the regency of Sophia, sister of Peter the Great, he was sent to the Amur to defend the new Muscovite fortress of Albazin against the Chinese. In 1689 he concluded with the Celestial empire the treaty of Nerchinsk, by which the line of the Amur, as far as its tributary the Gorbitsa, was retroceded to China because of the impossibility of seriously defending it. In Peter's grand embassy to the West in 1697 Golovin occupied the second place immediately after Lefort. It was his chief duty to hire foreign sailors and obtain everything necessary for the construction and complete equipment of a fleet. On Lefort's death, in March 1699, he succeeded him as admiral-general. The same year he was created the first Russian count, and was also the first to be decorated with the newly-instituted Russian order of St Andrew. The conduct of foreign affairs was at the same time entrusted to him, and from 1699 to his death he was "the premier minister of the tsar." Golovin's first achievement as foreign minister was to supersede the treaty of Carlowitz, by which peace with Turkey had only been secured for three years, by concluding with the Porte a new treaty at Constantinople (June 13, 1700), by which the term of the peace was extended to thirty years and,

besides other concessions, the Asov district and a strip of territory extending thence to Kuban were ceded to Russia. He also controlled, with consummate ability, the operations of the brand-new Russian diplomatists at the various foreign courts. His superiority over all his Muscovite contemporaries was due to the fact that he was already a statesman, in the modern sense, while they were still learning the elements of statesmanship. His death was an irreparable loss to the tsar, who wrote upon the despatch announcing it, the words "Peter filled with grief."

See R. N. Bain, *The First Romanovs* (London, 1905). (R. N. B.)

GOLOVKIN, GAVRIIL IVANOVICH, COUNT (1660-1734), Russian statesman, was attached (1677), while still a lad, to the court of the tsarevitch Peter, afterwards Peter the Great, with whose mother Natalia he was connected, and vigilantly guarded him during the disquieting period of the regency of Sophia, sister of Peter the Great (1682-1689). He accompanied the young tsar abroad on his first foreign tour, and worked by his side in the dockyards of Saardam. In 1706 he succeeded Golovin in the direction of foreign affairs, and was created the first Russian grand-chancellor on the field of Poltava (1709). Golovkin held this office for twenty-five years. In the reign of Catherine I. he became a member of the supreme privy council which had the chief conduct of affairs during this and the succeeding reigns. The empress also entrusted him with her last will whereby she appointed the young Peter II. her successor and Golovkin one of his guardians. On the death of Peter II. in 1730 he declared openly in favour of Anne, duchess of Courland, in opposition to the aristocratic Dolgorukis and Golitsuins, and his determined attitude on behalf of autocracy was the chief cause of the failure of the proposed constitution, which would have converted Russia into a limited monarchy. Under Anne he was a member of the first cabinet formed in Russia, but had less influence in affairs than Ostermann and Münnich. In 1707 he was created a count of the Holy Roman empire, and in 1710 a count of the Russian empire. He was one of the wealthiest, and at the same time one of the stingiest, magnates of his day. His ignorance of any language but his own made his intercourse with foreign ministers very inconvenient.

See R. N. Bain, *The Pupils of Peter the Great* (London, 1897). (R. N. B.)

GOLOVNIN, VASILY MIKHAILOVICH (1776-1831), Russian vice-admiral, was born on the 20th of April 1776 in the village of Gulyнки in the province of Ryazan, and received his education at the Cronstadt naval school. From 1801 to 1806 he served as a volunteer in the English navy. In 1807 he was commissioned by the Russian government to survey the coasts of Kamchatka and of Russian America, including also the Kurile Islands. Golovnin sailed round the Cape of Good Hope, and on the 5th of October 1809, arrived in Kamchatka. In 1810, whilst attempting to survey the coast of the island of Kunashiri, he was seized by the Japanese, and was retained by them as a prisoner, until the 13th of October 1813, when he was liberated, and in the following year he returned to St Petersburg. Soon after this the government planned another expedition, which had for its object the circumnavigation of the globe by a Russian ship, and Golovnin was appointed to the command. He started from St Petersburg on the 7th of September 1817, sailed round Cape Horn, and arrived in Kamchatka in the following May. He returned to Europe by way of the Cape of Good Hope, and landed at St Petersburg on the 17th of September 1819. He died on the 12th of July 1831.

Golovnin published several works, of which the following are the most important:—*Journey to Kamchatka* (2 vols., 1819); *Journey Round the World* (2 vols., 1822); and *Narrative of my Captivity in Japan, 1811-1813* (2 vols., 1816). The last has been translated into French, German and English, the English edition being in three volumes (1824). A complete edition of his works was published at St Petersburg in five volumes in 1864, with maps and charts, and a biography of the author by N. Grech.

GOLTZ, BOGUMIL (1801-1870), German humorist and satirist, was born at Warsaw on the 20th of March 1801. After attending the classical schools of Marienwerder and Königsberg, he learnt farming on an estate near Thorn, and in 1821 entered the university of Breslau as a student of philosophy. But he

soon abandoned an academical career, and, after returning for a while to country life, retired to the small town of Gollub, where he devoted himself to literary studies. In 1847 he settled at Thorn, "the home of Copernicus," where he died on the 12th of November 1870. Goltz is best known to literary fame by his *Buch der Kindheit* (Frankfurt, 1847; 4th ed., Berlin, 1877), in which, after the style of Jean Paul, and Adalbert Stifter, but with a more modern realism, he gives a charming and idyllic description of the impressions of his own childhood. Among his other works must be noted *Ein Jugendleben* (1852); *Der Mensch und die Leute* (1858); *Zur Charakteristik und Naturgeschichte der Frauen* (1859); *Zur Geschichte und Charakteristik des deutschen Genius* (1864), and *Die Weltklugheit und die Lebensweisheit* (1860).

Goltz's works have not been collected, but a selection will be found in Reclam's *Universalbibliothek* (ed. by P. Stein, 1901 and 1906). See O. Roquette, *Siebzig Jahre*, i. (1894).

GOLTZ, COLMAR, FREIHERR VON DER (1843-), Prussian soldier and military writer, was born at Bielkenfeld, East Prussia, on the 12th of August 1843, and entered the Prussian infantry in 1861. In 1864 he entered the Berlin Military Academy, but was temporarily withdrawn in 1866 to serve in the Austrian war, in which he was wounded at Trautenuau. In 1867 he joined the topographical section of the general staff, and at the beginning of the Franco-German War of 1870-71 was attached to the staff of Prince Frederick Charles. He took part in the battles of Vionville and Gravelotte and in the siege of Metz. After its fall he served under the Red Prince in the campaign of the Loire, including the battles of Orleans and Le Mans. He was appointed in 1871 professor at the military school at Potsdam, and the same year was promoted captain and placed in the historical section of the general staff. It was then he wrote *Die Operationen der II. Armee bis zur Capitulation von Metz* and *Die Sieben Tage von Le Mans*, both published in 1873. In 1874 he was appointed to the staff of the 6th division, and while so employed wrote *Die Operationen der II. Armee an der Loire und Le Mans* and *Le Mans*, published in 1875 and 1877 respectively. The latter was translated into French the same year, and both are impartially written. The views expressed in the latter work led to his being sent back to regimental duty for a time, but it was not long before he returned to the military history section. In 1878 von der Goltz was appointed lecturer in military history at the military academy at Berlin, where he remained for five years and attained the rank of major. He published, in 1883, *Rosbach und Jena* (new and revised edition, *Von Rosbach bis Jena und Auerstädt*, 1906), *Das Volk im Waffen* (English translation *The Nation in Arms*), both of which quickly became military classics, and during his residence in Berlin contributed many articles to the military journals. In June 1883 his services were lent to Turkey to reorganize the military establishments of the country. He spent twelve years in this work, the result of which appeared in the Greco-Turkish War of 1897, and he was made a pasha and in 1895 a *mushir* or field-marshal. On his return to Germany in 1896 he became a lieutenant-general and commander of the 5th division, and in 1898, head of the Engineer and Pioneer Corps and inspector-general of fortifications. In 1900 he was made general of infantry and in 1902 commander of the I. army corps. In 1907 he was made inspector-general of the newly created sixth army inspection established at Berlin, and in 1908 was given the rank of colonel-general (*Generallieutenant*).

In addition to the works already named and frequent contributions to military periodical literature, he wrote *Kriegführung* (1895, later edition *Krieg- und Heerführung*, 1901; Eng. trans. *The Conduct of War*); *Der türkische Krieg* (Berlin, 1898); *Ein Ausflug nach Macedonia* (1894); *Anatolische Ausflüge* (1896); a map and description of the environs of Constantinople: *Von Jena bis Pr. Eylau* (1907), a most important historical work, carrying on the story of *Rosbach und Jena* to the peace of Tilsit, &c.

GOLTZIUS, HENDRIK (1558-1617), Dutch painter and engraver, was born in 1558 at Mûlebrecht, in the duchy of Jülich. After studying painting on glass for some years under his father, he was taught the use of the burin by Dirk Volkertsz Coornert, a Dutch engraver of mediocre attainment, whom he

soon surpassed, but who retained his services for his own advantage. He was also employed by Philip Galle to engrave a set of prints of the history of Lucretia. At the age of twenty-one he married a widow somewhat advanced in years, whose money enabled him to establish at Haarlem an independent business; but his unpleasant relations with her so affected his health that he found it advisable in 1590 to make a tour through Germany to Italy, where he acquired an intense admiration for the works of Michelangelo, which led him to surpass that master in the grotesqueness and extravagance of his designs. He returned to Haarlem considerably improved in health, and laboured there at his art till his death, on the 1st of January 1617. Goltzius ought not to be judged chiefly by the works he valued most, his eccentric imitations of Michelangelo. His portraits, though mostly miniatures, are master-pieces of their kind, both on account of their exquisite finish, and as fine studies of individual character. Of his larger heads, the life-size portrait of himself is probably the most striking example. His "master-pieces," so called from their being attempts to imitate the style of the old masters, have perhaps been overpraised. In his command of the burin Goltzius is not surpassed even by Dürer; but his technical skill is often unequally aided by higher artistic qualities. Even, however, his eccentricities and extravagances are greatly counterbalanced by the beauty and freedom of his execution. He began painting at the age of forty-two, but none of his works in this branch of art—some of which are in the imperial collection at Vienna—display any special excellences. He also executed a few pieces in *chiaroscuro*.

His prints amount to more than 300 plates, and are fully described in Bartsch's *Peintre-graveur*, and Weigel's supplement to the same work.

GOLUCHOWSKI, AGENOR, COUNT (1849-), Austrian statesman, was born on the 25th of March 1849. His father, descended from an old and noble Polish family, was governor of Galicia. Entering the diplomatic service, the son was in 1872 appointed attaché to the Austrian embassy at Berlin, where he became secretary of legation, and thence he was transferred to Paris. After rising to the rank of counsellor of legation, he was in 1887 made minister at Bucharest, where he remained till 1893. In these positions he acquired a great reputation as a firm and skilful diplomatist, and on the retirement of Count Kalnoky in May 1895 was chosen to succeed him as Austro-Hungarian minister for foreign affairs. The appointment of a Pole caused some surprise in view of the importance of Austrian relations with Russia (then rather strained) and Germany, but the choice was justified by events. In his speech of that year to the delegations he declared the maintenance of the Triple Alliance, and in particular the closest intimacy with Germany, to be the keystone of Austrian policy; at the same time he dwelt on the traditional friendship between Austria and Great Britain, and expressed his desire for a good understanding with all the powers. In pursuance of this policy he effected an understanding with Russia, by which neither power was to exert any separate influence in the Balkan peninsula, and thus removed a long-standing cause of friction. This understanding was formally ratified during a visit to St Petersburg on which he accompanied the emperor in April 1897. He took the lead in establishing the European concert during the Armenian troubles of 1896, and again resisted isolated action on the part of any of the great powers during the Cretan troubles and the Greco-Turkish War. In November 1897, when the Austro-Hungarian flag was insulted at Mersina, he threatened to bombard the town if instant reparation were not made, and by his firm attitude greatly enhanced Austrian prestige in the East. In his speech to the delegations in 1898 he dwelt on the necessity of expanding Austria's mercantile marine, and of raising the fleet to a strength which, while not vying with the fleets of the great naval powers, would ensure respect for the Austrian flag wherever her interests needed protection. He also hinted at the necessity for European combination to resist American competition. The understanding with Russia in the matter of the Italian States temporarily endangered friendly relations with Italy,

who thought her interests threatened, until Goluchowski guaranteed in 1808 the existing order. He further encouraged a good understanding with Italy by personal conferences with the Italian foreign minister, Tittoni, in 1804 and 1805. Count Lamsdorff visited Vienna in December 1802, when arrangements were made for concerted action in imposing on the sultan reforms in the government of Macedonia. Further steps were taken after Goluchowski's interview with the tsar at Mürtzberg in 1803, and two civil agents representing the countries were appointed for two years to ensure the execution of the promised reforms. This period was extended in 1805, when Goluchowski was the chief mover in forcing the Porte, by an international naval demonstration at Mitylene, to accept financial control by the powers in Macedonia. At the conference assembled at Algieras to settle the Morocco Question, Austria supported the German position, and after the close of the conferences the emperor William II. telegraphed to Goluchowski: "You have proved yourself a brilliant second on the duelling ground and you may feel certain of like services from me in similar circumstances." This pledge was redeemed in 1808, when Germany's support of Austria in the Balkan crisis proved conclusive. By the Hungarians, however, Goluchowski was hated; he was suspected of having inspired the emperor's opposition to the use of Magyar in the Hungarian army, and was made responsible for the slight offered to the Magyar deputation by Francis Joseph in September 1805. So long as he remained in office there was no hope of arriving at a settlement of a matter which threatened the disruption of the Dual monarchy, and on the 11th of October 1806 he was forced to resign.

GOMAL, or **GUMAL**, the name of a river of Afghanistan, and of a mountain pass on the Dera Ismail Khan border of the North-West Frontier Province of British India. The Gomal river, one of the most important rivers in Afghanistan, rises in the unexplored regions to the south-east of Ghazni. Its chief tributary is the Zhub. Within the limits of British territory the Gomal forms the boundary between the North-West Frontier Province and Baluchistan, and more or less between the Pathan and Baluch races. The Gomal pass is the most important pass on the Indian frontier between the Khyber and the Bolan. It connects Dera Ismail Khan with the Gomal valley in Afghanistan, and has formed for centuries the outlet for the povidah trade. Until the year 1889 this pass was almost unknown to the Anglo-Indian official; but in that year the government of India decided that, in order to maintain the safety of the railway as well as to perfect communication between Quetta and the Punjab, the Zhub valley should, like the Bori valley, be brought under British protection and control, and the Gomal pass should be opened. After the Waziristan expedition of 1804 Wana was occupied by British troops in order to dominate the Gomal and Waziristan; but on the formation of the North-West Frontier Province in 1901 it was decided to replace these troops by the South Waziristan militia, who now secure the safety of the pass.

GOMARUS, FRANZ (1563-1641), Dutch theologian, was born at Bruges on the 30th of January 1563. His parents, having embraced the principles of the Reformation, emigrated to the Palatinate in 1578, in order to enjoy freedom to profess their new faith, and they sent their son to be educated at Strassburg under Johann Sturm (1507-1589). He remained there three years, and then went in 1580 to Neustadt, whither the professors of Heidelberg had been driven by the elector-palatine because they were not Lutherans. Here his teachers in theology were Zacharius Ursinus (1534-1583), Hieronymus Zanchius (1560-1590), and Daniel Tossanus (1541-1602). Crossing to England towards the end of 1582, he attended the lectures of John Rainolds (1549-1607) at Oxford, and those of William Whitaker (1548-1595) at Cambridge. He graduated at Cambridge in 1584, and then went to Heidelberg, where the faculty had been by this time re-established. He was pastor of a Reformed Dutch church in Frankfurt from 1587 till 1593, when the congregation was dispersed by persecution. In 1594 he was appointed professor of theology at Leiden, and before going thither received from

the university of Heidelberg the degree of doctor. He taught quietly at Leiden till 1603, when Jakobus Arminius came to be one of his colleagues in the theological faculty, and began to teach Pelagian doctrines and to create a new party in the university. Gomarus immediately set himself earnestly to oppose these views in his classes at college, and was supported by Johann B. Bogermann (1570-1637), who afterwards became professor of theology at Franeker. Arminius "sought to make election dependent upon faith, whilst they sought to enforce absolute predestination as the rule of faith, according to which the whole Scriptures are to be interpreted" (J. A. Dorner, *History of Protestant Theology*, i. p. 417). Gomarus then became the leader of the opponents of Arminius, who from that circumstance came to be known as Gomarists. He engaged twice in personal disputation with Arminius in the assembly of the estates of Holland in 1608, and was one of five Gomarists who met five Arminians or Remonstrants in the same assembly of 1609. On the death of Arminius shortly after this time, Konrad Vorstius (1569-1622), who sympathized with his views, was appointed to succeed him, in spite of the keen opposition of Gomarus and his friends; and Gomarus took his defeat so ill that he resigned his post, and went to Middleburg in 1611, where he became preacher at the Reformed church, and taught theology and Hebrew in the newly founded *Illustré Schule*. From this place he was called in 1614 to a chair of theology at Saumur, where he remained four years, and then accepted a call as professor of theology and Hebrew to Groningen, where he stayed till his death on the 11th of January 1641. He took a leading part in the synod of Dort, assembled in 1618 to judge of the doctrines of Arminius. He was a man of ability, enthusiasm and learning, a considerable Oriental scholar, and also a keen controversialist. He took part in revising the Dutch translation of the Old Testament in 1633, and after his death a book by him, called the *Lyra Davidis*, was published, which sought to explain the principles of Hebrew metre, and which created some controversy at the time, having been opposed by Louis Cappel. His works were collected and published in one volume folio, in Amsterdam in 1645. He was succeeded at Groningen in 1643 by his pupil Samuel Maresius (1599-1673).

GOMBERVILLE, MARIN LE ROY, SEUR DU PARC ET DE (1600-1674), French novelist and miscellaneous writer, was born at Paris in 1600. At fourteen years of age he wrote a volume of verse, at twenty a *Discours sur l'histoire* and at twenty-two a pastoral, *La Carthage*, which is really a novel. The persons in it, though still disguised as shepherds and shepherdesses, represent real persons for whose identification the author himself provides a key. This was followed by a more ambitious attempt, *Polexandre* (5 vols. 1632-1637). The hero wanders through the world in search of the island home of the princess Alcidiane. It contains much history and geography; the travels of Polexandre extending to such unexpected places as Benin, the Canary Islands, Mexico and the Antilles, and incidentally we learn all that was then known of Mexican history. *Cytheree* (4 vols.) appeared in 1630-1642, and in 1651 the *Jeu des Alcidiens*, intended to undo any harm the earlier novels may have done, for Gomberville became a Jansenist and spent the last twenty-five years of his life in pious retirement. He was one of the earliest and most energetic members of the Academy. He died in Paris on the 14th of June 1674.

GOMER, the biblical name of a race appearing in the table of nations (Gen. x. 3), as the "eldest son" of Japheth and the "father" of Ashkenaz, Riphath and Togarmah; and in Ezek. xxxviii. 6 as a companion of "the house of Togarmah in the uttermost parts of the north," and an ally of Gog; both Gomer and Togarmah being credited with "hordes,"¹ E.V., i.e. "bands" or "armies." The "sons" of Gomer are probably tribes of north-east Asia Minor and Armenia, and Gomer is identified with the Cimmerians. These are referred to in cuneiform inscriptions under the Assyrian name *gimmirā* (*gimiri*) as raiding Asia Minor from the north and north-east of the Black Sea. ¹ *Agaph*, a word peculiar to Ezekiel, Clarendon Press *Heb. Lex.*

Sea, and overturning Lydia in the 7th century B. C. (see **COMENIUS**, **SCYTHIA**, **LYDIA**). They do not seem to have made any permanent settlements, unless some such are indicated by the fact that the Armenians called Cappadocia *Gomir*. It is, however, suggested that this name is borrowed from the Old Testament.¹

The name Gomer (Gomer bath Diblaim) was also borne by the unfaithful wife of Hosea, whom he pardoned and took back (Hosea i. 3). Hosea uses these incidents as symbolic of the sin, punishment and redemption of Israel, but there is no need to regard Gomer as a purely imaginary person.

(W. H. Bz.)
GOMERA, an island in the Atlantic Ocean, forming part of the Spanish archipelago of the Canary Islands (q.v.). Pop. (1900) 15,358; area 144 sq. m. Gomera lies 20 m. W.S.W. of Teneriffe. Its greatest length is about 23 m. The coast is precipitous and the interior mountainous, but Gomera has the most wood and is the best watered of the group. The inhabitants are very poor. Dromedaries are bred on Gomera in large numbers. San Sebastian (3187) is the chief town and a port. It was visited by Columbus on his first voyage of discovery in 1492.

GOMEZ, DIEGO (DIEGO) (fl. 1440-1482), Portuguese seaman, explorer and writer. We first trace him as a *caballero* of the royal household; in 1440 he was appointed receiver of the royal customs—in 1466 judge—at Cintra (*juiz das causas e feitorias contadas de Cintra*); on the 5th of March 1482 he was confirmed in the last-named office. He wrote, especially for the benefit of Martin Behaim, a Latin chronicle of great value, dealing with the life and discoveries of Prince Henry the Navigator, and divided into three parts: (1) *De prima inventione Guineae*; (2) *De insultis primo inventis in mare (sic) Occidentis*; (3) *De inventione insularum de Açores*. This chronicle contains the only contemporary account of the rediscovery of the Azores by the Portuguese in Prince Henry's service, and is also noteworthy for its clear ascription to the prince of deliberate scientific and commercial purpose in exploration. For, on the one hand, the infante sent out his caravels to search for new lands (*ad quaerendas terras*) from his wish to know the more distant parts of the western ocean, and in the hope of finding islands or *terra firma* beyond the limits laid down by Ptolemy (*ultra descriptionem Tolomei*); on the other hand, his information as to the native trade from Tunis to Timbuktu and the Gambia helped to inspire his persistent exploration of the West African coast—"to seek those lands by way of the sea." Chart and quadrant were used on the prince's vessels, as by Gomez himself on reaching the Cape Verde Islands; Henry, at the time of Diogo's first voyage, was in correspondence with an Oran merchant who kept him informed upon events even in the Gambia *hinterland*; and, before the discovery of the Senegal and Cape Verde in 1445, Gomez' royal patron had already gained reliable information of some route to Timbuktu. In the first part of his chronicle Gomez tells how, no long time after the disastrous expedition of the Danish nobleman "Vallarte" (Adalbert) in 1448, he was sent out in command of three vessels along the West African coast, accompanied by one Jacob, an Indian interpreter, to be employed in the event of reaching India. After passing the Rio Grande, beyond Cape Verde, strong currents checked his course; his officers and men feared that they were approaching the extremity of the ocean, and he put back to the Gambia. He ascended this river a considerable distance, to the negro town of "Cantor," whither natives came from "Kukia" and Timbuktu for trade; he gives elaborate descriptions of the negro world he had now penetrated, refers to the Sierra Leone ("Serra Lyoa") Mountains, sketches the course of this range, and says much of Kukia (in the upper Niger basin?), the centre of the West African gold trade, and the resort of merchants and caravans from Tunis, Fez, Cairo and "all the land of the Saracens." Mahomedanism was already dominant at the Cambria estuary, but Gomez seems to have won over at least one important chief, with his court, to Christianity and Portuguese allegiance. Another African voyage, apparently made in 1462, two years after Henry

¹ A. Jeremias, *Das A.T. im Lichte des alten Orients*, pp. 145 f.

the Navigator's death (though assigned by some to 1460), resulted in a fresh discovery of the Cape Verde Islands, already found by Cadamosto (q.v.). To the island of Santiago Gomez, like his Venetian forerunner, claims to have given its present name. His narrative is a leading authority on the last illness and death of Prince Henry, as well as on the life, achievements and purposes of the latter; here alone is recorded what appears to have been the earliest of the navigator's exploring ventures, that which under João de Trasto reached Grand Canary in 1415.

Of Gomez' chronicle there is only one MS., viz. *Cod. Hisp. 27*, in the Hof- und Staats-Bibliothek, Munich; the original Latin text was printed by Schmeller "Über Valentim Fernandez Alencão" in the *Abhandlungen der philosoph.-philolog. Kl. der bayrisch. Akademie der Wissenschaften*, vol. iv., part iii. (Munich, 1847); see also Sophus Ruge, "Die Entdeckung der Azoren," pp. 149-180 (Esp. 178-179) in the 27th *Jahresbericht des Vereins für Erdkunde* (Dresden, 1901); Jules Mees, *Histoire de la découverte des Açores*, pp. 44-45, 125-127 (Ghent, 1901); R. H. Major, *Life of Prince Henry the Navigator*, pp. xviii., xix., 64-65, 287-299, 303-305 (London, 1868); C. R. Beazley, *Prince Henry the Navigator*, 289-298, 304-305; and Introduction to *Azurara's Discovery and Conquest of Guinea*, ii., iv., xiv., xv., xvii., xviii., xcvi. (London, 1899). (C. R. B.)

GOMEZ DE AVELLANEDA, GERTRUDIS (1814-1873), Spanish dramatist and poet, was born at Puerto Principe (Cuba) on the 23rd of March 1814, and removed to Spain in 1836. Her *Poesías líricas* (1841), issued with a laudatory preface by Gallego, made a most favourable impression and were republished with additional poems in 1850. In 1846 she married a diplomatist named Pedro Sabater, became a widow within a year, and in 1853 married Colonel Domingo Verdugo. Meanwhile she had published *Sab* (1839), *Guatimozin* (1846), and other novels of no great importance. She obtained, however, a series of successes on the stage with *Alfonso Munio* (1844), a tragedy in the new romantic manner; with *Saúl* (1849), a biblical drama indirectly suggested by Alfieri, and with *Baltasar* (1858), a piece which bears some resemblance to Byron's *Sardanapalus*. Her commerce with the world had not diminished her natural piety, and, on the death of her second husband, she found so much consolation in religion that she had thoughts of entering a convent. She died at Madrid on the 2nd of February 1873, full of mournful forebodings as to the future of her adopted country. It is impossible to agree with Villemain that "le génie de don Luis de Léon et de sainte Thérèse a reparu sous le voile funèbre de Gomez de Avellaneda," for she has neither the monk's mastery of poetic form nor the nun's sublime simplicity of soul. She has a grandiose tragical vision of life, a vigorous eloquence rooted in pietistic pessimism, a dramatic gift effective in isolated acts or scenes; but she is deficient in constructive power and in intellectual force, and her lyrics, though instinct with melancholy beauty, or the tenderness of resigned devotion, too often lack human passion and sympathy. The edition of her *Obras literarias* (5 vols., 1869-1871), still incomplete, shows a scrupulous care for minute revision uncommon in Spanish writers; but her emendations are seldom happy. But she is interesting as a link between the classic and romantic schools of poetry, and, whatever her artistic shortcomings, she has no rivals of her own sex in Spain during the 19th century.

GOMM, SIR WILLIAM MAYNARD (1784-1875), British soldier, was gazetted to the 9th Foot at the age of ten, in recognition of the services of his father, Lieut.-Colonel William Gomm, who was killed in the attack on Guadaloupe (1794). He joined his regiment as a lieutenant in 1799, and fought in Holland under the duke of York, and subsequently was with Pulteney's Ferrol expedition. In 1803 he became Captain, and shortly afterwards qualified as a staff officer at the High Wycombe military college. On the general staff he was with Cathcart at Copenhagen, with Wellington in the Peninsula, and on Moore's staff at Corunna. He was also on Chatham's staff in the disastrous Walksheren expedition of 1809. In 1810 he rejoined the Peninsular army as Leith's staff officer, and took part in all the battles of 1810, 1811 and 1812, winning his majority after Fuentes d'Onor and his lieutenant-colonelcy at Salamanca. His careful reconnaissances and skilful leading were invaluable to Wellington in the Vittoria campaign, and to the end of the war he was one of the

most trusted men of his staff. His reward was a transfer to the Coldstream Guards and the K.C.B. In the Waterloo campaign he served on the staff of the 5th British Division. From the peace until 1839 he was employed on home service, becoming colonel in 1829 and major-general in 1837. From 1839 to 1842 he commanded the troops in Jamaica. He became lieutenant-general in 1846, and was sent out to be commander-in-chief in India, arriving only to find that his appointment had been cancelled in favour of Sir Charles Napier, whom, however, he eventually succeeded (1850-1855). In 1854 he became general and in 1868 field marshal. In 1872 he was appointed constable of the Tower, and he died in 1875. He was twice married, but had no children. His *Letters and Journals* were published by F. C. Carr-Gomm in 1881. Five "Field Marshal Gomm" scholarships were afterwards founded in his memory at Keble College, Oxford.

GOMPERS, SAMUEL (1850-), American labour leader, was born in London on the 27th of January 1850. He was put to work in a shoe-factory when ten years old, but soon became apprenticed to a cigar-maker, removed to New York in 1863, became a prominent member of the International Cigar-makers' Union, was its delegate at the convention of the Federation of Organized Trade and Labor Unions of the United States and Canada, later known as the American Federation of Labor, of which he became first president in 1882. He was successively re-elected up to 1895, when the opposition of the Socialist Labor Party, then attempting to incorporate the Federation into itself, secured his defeat; he was re-elected in the following year. In 1894 he became editor of the Federation's organ, *The American Federationist*.

GOMPERZ, THEODOR (1832-), German philosopher and classical scholar, was born at Brünn on the 29th of March 1832. He studied at Brünn and at Vienna under Herman Bonitz. Graduating at Vienna in 1867 he became *Privatdozent*, and subsequently professor of classical philology (1873). In 1882 he was elected a member of the Academy of Science. He received the degree of Doctor of Philosophy *honoris causa* from the university of Königsberg, and Doctor of Literature from the universities of Dublin and Cambridge, and became correspondent for several learned societies. His principal works are: *Demosithen der Staatsmann* (1864), *Philodemi de ira liber* (1864), *Traumdeutung und Zauberei* (1866), *Herkulanische Studien* (1865-1866), *Beiträge zur Kritik und Erklärung griech. Schriftsteller* (7 vols., 1875-1900), *Neue Bruchstücke Epikurs* (1876), *Die Bruchstücke der griech. Tragiker und Cobets neueste kritische Manier* (1878), *Herodotische Studien* (1883), *Ein bisher unbekanntes griech. Schriftsystem* (1884), *Zu Philodems Büchern von der Musik* (1885), *Über den Abschluss des herodotischen Geschichtswerkes* (1886), *Platonische Aufsätze* (3 vols., 1887-1905), *Zu Heraklits Lehre und den Überresten seines Werkes* (1887), *Zu Aristoteles' Poetik* (2 parts, 1888-1896), *Über die Charaktere Theophrasts* (1888), *Nachlese zu den Bruchstücken der griech. Tragiker* (1888), *Die Apologie der Heilkunst* (1890), *Philodem und die ästhetischen Schriften der herculanischen Bibliothek* (1891), *Die Schrift vom Staatswesen der Athener* (1891), *Die jüngst entdeckten Überreste einer den Platonischen Phädon enthaltenden Papyrusrolle* (1892), *Aus der Hekale des Kallimachos* (1893), *Essays and Erinnerungen* (1905). He supervised a translation of J. S. Mill's complete works (12 vols., Leipzig, 1869-1880), and wrote a life (Vienna, 1880) of Mill. His *Griechische Denker: Geschichte der antiken Philosophie* (vols. i. and ii., Leipzig, 1893 and 1902) was translated into English by L. Magnus (vol. i., 1901).

GONAGUAS ("borderers"), descendants of a very old cross between the Hottentots and the Kafirs, on the "ethnic divide" between the two races, apparently before the arrival of the whites in South Africa. They have been always a despised race and regarded as outcasts by the Bantu peoples. They were threatened with extermination during the Kafir wars, but were protected by the British. At present they live in settled communities under civil magistrates without any tribal organization, and in some districts could be scarcely distinguished from the other natives but for their broken Hottentot-Dutch-English speech.

GONÇALVES DIAS, ANTONIO (1823-1864), Brazilian lyric poet, was born near the town of Caxias, in Maranhão. From the university of Coimbra, in Portugal, he returned in 1845 to his native province, well-equipped with legal lore, but the literary tendency which was strong within him led him to try his fortune as an author at Rio de Janeiro. Here he wrote for the newspaper press, ventured to appear as a dramatist, and in 1846 established his reputation by a volume of poems—*Primeiros Cantos*—which appealed to the national feelings of his Brazilian readers, were remarkable for their autobiographic impress, and by their beauty of expression and rhythm placed their author at the head of the lyric poets of his country. In 1848 he followed up his success by *Segundos Cantos e sextilhas de Frei Antão*, in which, as the title indicates, he puts a number of the pieces in the mouth of a simple old Dominican friar; and in the following year, in fulfilment of the duties of his new post as professor of Brazilian history in the Imperial College of Pedro II. at Rio de Janeiro, he published an edition of Berredo's *Annoes historicos do Maranhão* and added a sketch of the migrations of the Indian tribes. A third volume of poems, which appeared with the title of *Ultimos Cantos* in 1851, was practically the poet's farewell to the service of the muse, for he spent the next eight years engaged under government patronage in studying the state of public instruction in the north and the educational institutions of Europe. On his return to Brazil in 1860 he was appointed a member of an expedition for the exploration of the province of Ceará, was forced in 1862 by the state of his health to try the effects of another visit to Europe, and died in September 1864, the vessel that was carrying him being wrecked off his native shores. While in Germany he published at Leipzig a complete collection of his lyrical poems, which went through several editions, the four first cantos of an epic poem called *Os Tymbiras* (1857) and a *Diccionario da lingua Tupy* (1858).

A complete edition of the works of Dias has made its appearance at Rio de Janeiro. See *Wolff, Brésil littéraire* (Berlin, 1863); Innocencio de Silva, *Diccionario bibliographico portuguez*, viii. 157; Sotero dos Reis, *Curso de litteratura portugueza e brasileira*, iv. (Maranhão, 1868); José Verissimo, *Estudos de literatura brasileira, segunda serie* (Rio, 1901).

GONCHAROV, IVAN ALEXANDROVICH (1812-1891), Russian novelist, was born 6/18 July 1812, being the son of a rich merchant in the town of Simbirsk. At the age of ten he was placed in one of the gymnasiums at Moscow, from which he passed, though not without some difficulty on account of his ignorance of Greek, into the Moscow University. He read many French works of fiction, and published a translation of one of the novels of Eugène Sue. During his university career he devoted himself to study, taking no interest in the political and Socialistic agitation among his fellow-students. He was first employed as secretary to the governor of Simbirsk, and afterwards in the ministry of finance at St Petersburg. Being absorbed in bureaucratic work, Goncharov paid no attention to the social questions then ardently discussed by such men as Herzen, Aksakov and Bielinski. He began his literary career by publishing translations from Schiller, Goethe and English novelists. His first original work was *Obniakovennaya Istoria*, "A Common Story" (1847). In 1856 he sailed to Japan as secretary to Admiral Putiatin for the purpose of negotiating a commercial treaty, and on his return to Russia he published a description of the voyage under the title of "The Frigate *Pallada*." His best work is *Oblomov* (1857), which exposed the laziness and apathy of the smaller landed gentry in Russia anterior to the reforms of Alexander II. Russian critics have pronounced this work to be a faithful characterization of Russia and the Russians. Dobrolov said of it, "Oblomovka [the country-seat of the Oblomovs] is our fatherland: something of Oblomov is to be found in every one of us." Peesarev, another celebrated critic, declared that "Oblomovism," as Goncharov called the sum total of qualities with which he invested the hero of his story, "is an illness fostered by the nature of the Slavonic character and the life of Russian society." In 1858 Goncharov was appointed a censor, and in 1868 he published another novel called *Obreev*. He was not a voluminous writer, and during the latter part of his life produced nothing of any importance. His death occurred on 15/27 September 1891.

GONCOURT, DE, a name famous in French literary history. EDMOND LOUIS ANTOINE HUOT DE GONCOURT was born at Nancy on the 26th of May 1822, and died at Champrosay on the 16th of July 1896. JULES ALFRED HUOT DE GONCOURT, his brother, was born in Paris on the 17th of December 1830, and died in Paris on the 20th of June 1870.

Writing always in collaboration, until the death of the younger, it was their ambition to be not merely novelists, inventing a new kind of novel, but historians; not merely historians, but the historians of a particular century, and of what was intimate and what is unknown in it; to be also discriminating, indeed innovating, critics of art, but of a certain section of art, the 18th century, in France and Japan; and also to collect pictures and bibelots, always of the French and Japanese 18th century. Their histories (*Portraits intimes du XVIII^e siècle* (1857), *La Femme au XVIII^e siècle* (1862), *La du Barry* (1878), &c.) are made entirely out of documents, autograph letters, scraps of costume, engravings, songs, the unconscious self-revelations of the time; their three volumes on *L'Art du XVIII^e siècle* (1859-1875) deal with Watteau and his followers in the same scrupulous, minutely enlightening way, with all the detail of unpublished documents; and when they came to write novels, it was with a similar attempt to give the inner, undiscovered, minute truths of contemporary existence, the *inédit* of life. The same morbidly sensitive noting of the *inédit*, of whatever came to them from their own sensations of things and people around them, gives its curious quality to the nine volumes of the *Journal*, 1887-1896, which will remain, perhaps, the truest and most poignant chapter of human history that they have written. Their novels, *Sœur Philomène* (1861), *Renée Mauperin* (1864), *Germinie Lacerteux* (1865), *Manette Salomon* (1865), *Madame Gervaisais* (1869), and, by Edmond alone, *La Fille Elisa* (1878), *Les Frères Zemganno* (1879), *La Faustine* (1882), *Chérie* (1884), are, however, the work by which they will live as artists. Learning something from Flaubert, and teaching almost everything to Zola, they invented a new kind of novel, and their novels are the result of a new vision of the world, in which the very element of sight is decomposed, as in a picture of Monet. Seen through the nerves, in this conscious abandonment to the tricks of the eyesight, the world becomes a thing of broken patterns and conflicting colours, and uneasy movement. A novel of the Goncourts is made up of an infinite number of details, set side by side, every detail equally prominent. While a novel of Flaubert, for all its detail, gives above all things an impression of unity, a novel of the Goncourts deliberately dispenses with unity in order to give the sense of the passing of life, the heat and form of its moments as they pass. It is written in little chapters, sometimes no longer than a page, and each chapter is a separate notation of some significant event, some emotion or sensation which seems to throw sudden light on the picture of a soul. To the Goncourts humanity is as pictorial a thing as the world it moves in; they do not search further than "the physical basis of life," and they find everything that can be known of that unknown force written visibly upon the sudden faces of little incidents, little expressive moments. The soul, to them, is a series of moods, which succeed one another, certainly without any of the too arbitrary logic of the novelist who has conceived of character as a solid or consistent thing. Their novels are hardly stories at all, but picture-galleries, hung with pictures of the momentary aspects of the world. French critics have complained that the language of the Goncourts is no longer French, no longer the French of the past; and this is true. It is their distinction—the finest of their inventions—that, in order to render new sensations, a new vision of things, they invented a new language.

(A. Sv.)

In his will Edmond de Goncourt left his estate for the endowment of an academy, the formation of which was entrusted to MM. Alphonse Daudet and Léon Hennique. The society was to consist of ten members, each of whom was to receive an annuity of 6000 francs, and a yearly prize of 5000 francs was to be awarded to the author of some work of fiction. Eight of the members of the new academy were nominated in the will. They were: Alphonse Daudet, J. K. Huysmans, Léon Hennique, Octave Mirbeau, the two brothers J. H. Rosny, Gustave Geffroy and Paul Marguerite. On the 19th of January 1903, after much litigation, the academy was constituted,

with Elémir Bourges, Lucien Descaves and Léon Daudet as members in addition to those mentioned in de Goncourt's will, the place of Alphonse Daudet having been left vacant by his death in 1897.

On the brothers de Goncourt see the *Journal des Goncourts* already cited; also M. A. Belloc (afterwards Lowndes) and M. L. Shedlock, *Edmond and Jules de Goncourt, with Letters and Leaves from their Journals* (1895); Alidor Delzant, *Les Goncourts* (1889) which contains a valuable bibliography; *Lettres de Jules de Goncourt* (1888), with preface by H. Céard; R. Doumic, *Portraits d'écrivains* (1892); Paul Bourget, *Nouveaux Essais de psychologie contemporaine* (1886); Emile Zola, *Les Romanciers naturalistes* (1881), &c.

GONDA, a town and district of British India, in the Fyzabad division of the United Provinces. The town is 28 m. N.W. of Fyzabad, and is an important junction on the Bengal & North-Western railway. The site on which it stands was originally a jungle, in the centre of which was a cattle-fold (*Gonka* or *Gothak*), where the cattle were enclosed at night as a protection against wild beasts, and from this the town derives its name. Pop. (1901) 15,811. The cantonments were abandoned in 1863.

The district of Gonda has an area of 2813 sq. m. It consists of a vast plain with very slight undulations, studded with groves of mango trees. The surface consists of a rich alluvial deposit which is naturally divided into three great belts known as the *tarai* or swampy tract, the *uparhar* or uplands, and the *tarkar* or wet lowlands, all three being marvellously fertile. Several rivers flow through the district, but only two, the Gogra and Rapti, are of any commercial importance, the first being navigable throughout the year, and the latter during the rainy season. The country is dotted with small lakes, the water of which is largely used for irrigation. On the outbreak of the Mutiny in 1857, the raja of Gonda, after honourably escorting the government treasure to Fyzabad, joined the rebels. His estates, along with those of the rani of Tulsipur, were confiscated, and conferred as rewards upon the maharajas of Balrampur and Ajodhya, who had remained loyal. In 1901 the population was 1,403,195, showing a decrease of 4% in one decade. The district is traversed by the main line and three branches of the Bengal & North-Western railway.

GONDAL, a native state of India, in the Kathiawar political agency of Bombay, situated in the centre of the peninsula of Kathiawar. Its area is 1024 sq. m.; pop. (1901) 162,859. The estimated gross revenue is about £100,000, and the tribute £7000. Grain and cotton are the chief products. The chief, whose title is Thakur Sahib, is a Jadeja Rajput, of the same clan as the Rao of Cutch. The Thakur Sahib, Sir Bhagvat Sinhji (b. 1865), was educated at the Rajkot college, and afterwards graduated in arts and medicine at the university of Edinburgh. He published (in English) a *Journal of a Visit to England and A Short History of Aryan Medical Science*. In 1892 he received the honorary degree of D.C.L. of Oxford University. He was created K.C.I.E. in 1887 and G.C.I.E. in 1897. The state has long been conspicuous for its progressive administration. It is traversed by a railway connecting it with Bhaunagar, Rajkot and the sea-board. The town of Gondal is 23 m. by rail S. of Rajkot; pop. (1901) 19,592.

GONDAR, properly GUENDAR, a town of Abyssinia, formerly the capital of the Amharic kingdom, situated on a basaltic ridge some 7500 ft. above the sea, about 21 m. N.E. of Lake Tsana, a splendid view of which is obtained from the castle. Two streams, the Angreb on the east side and the Gaha or Kaba on the west, flow from the ridge, and meeting below the town, pass onwards to the lake. In the early years of the 20th century the town was much decayed, numerous ruins of castles, palaces and churches indicating its former importance. It was never a compact city, being divided into districts separated from each other by open spaces. The chief quarters were those of the Abun-Bed or bishop, the Etchege-Bed or chief of the monks, the Debra Berhan or Church of the Light, and the Gemp or castle. There was also a quarter for the Mahomedans. Gondar was a small village when at the beginning of the 16th century it was chosen by the Negus Sysenim (Seged I.) as the capital of his kingdom. His son Fasilidas, or A'lem-Seged (1633-1667), was the builder of the castle which bears his name. Later emperors built other castles and palaces, the latest in date being

that of the Negus Yesu II. This was erected about 1736, at which time Gondar appears to have been at the height of its prosperity. Thereafter it suffered greatly from the civil wars which raged in Abyssinia, and was more than once sacked. In 1868 it was much injured by the emperor Theodore, who did not spare either the castle or the churches. After the defeat of the Abyssinians at Debra Sin in August 1887 Gondar was looted and fired by the dervishes under Abu Anga. Although they held the town but a short time they inflicted very great damage, destroying many churches, further damaging the castles and carrying off much treasure. The population, estimated by James Bruce in 1770 at 10,000 families, had dwindled in 1905 to about 7000. Since the pacification of the Sudan by the British (1886-1889) there has been some revival of trade between Gondar and the regions of the Blue Nile. Among the inhabitants are numbers of Mahomedans, and there is a settlement of Falashas. Cotton, cloth, gold and silver ornaments, copper wares, fancy articles in bone and ivory, excellent saddles and shoes are among the products of the local industry.

Unlike any other buildings in Abyssinia, the castles and palaces of Gondar resemble, with some modifications, the medieval fortresses of Europe, the style of architecture being the result of the presence in the country of numbers of Portuguese. The Portuguese were expelled by Fasilidas, but his castle was built, by Indian workmen, under the superintendence of Abyssinians who had learned something of architecture from the Portuguese adventurers, helped possibly by Portuguese still in the country. The castle has two storeys, is 90 ft. by 84 ft., has a square tower and circular domed towers at the corners. The most extensive ruins are a group of royal buildings enclosed in a wall. These ruins include the palace of Yesu II., which has several fine chambers. Christian Levantines were employed in its construction and it was decorated in part with Venetian mirrors, &c. In the same enclosure is a small castle attributed to Yesu I. The exterior walls of the castles and palaces named are little damaged and give to Gondar a unique character among African towns. Of the forty-four churches, all in the circular Abyssinian style, which are said to have formerly existed in Gondar or its immediate neighbourhood, Major Powell-Cotton found only one intact in 1900. This church contained some well-executed native paintings of St. George and the Dragon, The Last Supper, &c. Among the religious observances of the Christians of Gondar is that of bathing in large crowds in the Gaha on the Feast of the Baptist, and again, though in more orderly fashion, on Christmas day.

See E. Ruppell, *Reise in Abyssinien* (Frankfort-on-the-Main, 1838-1840); T. von Heuglin, *Reise nach Abessinien* (Jena, 1868); G. Lejean, *Voyage en Abyssinie* (Paris, 1872); Achille Raffray, *Afrique orientale; Abyssinie* (Paris, 1876); P. H. G. Powell-Cotton, *A Sporting Trip through Abyssinia*, chaps. 27-30 (London, 1902); and *Bull. Soc. Geog. Italiana* for 1909. Views of the castle are given by Heuglin, Raffray and Powell-Cotton.

GONDOKORO, a government station and trading-place on the east bank of the upper Nile, in 4° 54' N., 31° 43' E. It is the headquarters of the Northern Province of the (British) Uganda protectorate, is 1070 m. by river S. of Khartoum and 350 m. N.N.W. in a direct line of Entebbe on Victoria Nyanza. The station, which is very unhealthy, is at the top of a cliff 25 ft. above the river-level. Besides houses for the civil and military authorities and the lines for the troops, there are a few huts inhabited by Bari, the natives of this part of the Nile. The importance of Gondokoro lies in the fact that it is within a few miles of the limit of navigability of the Nile from Khartoum up stream. From this point the journey to Uganda is continued overland.

Gondokoro was first visited by Europeans in 1841-1842, when expeditions sent out by Mehemet Ali, pasha of Egypt, ascended the Nile as far as the foot of the rapids above Gondokoro. It soon became an ivory and slave-trading centre. In 1851 an Austrian Roman Catholic mission was established here, but it was abandoned in 1859. It was at Gondokoro that J. H. Speke and J. A. Grant, descending the Nile after their discovery of its source, met, on the 15th of February 1863, Mr (afterwards Sir)

Samuel Baker and his wife who were journeying up the river. In 1871 Baker, then governor-general of the equatorial provinces of Egypt, established a military post at Gondokoro which he named Ismailia, after the then khedive. Baker made this post his headquarters, but Colonel (afterwards General) C. G. Gordon, who succeeded him in 1874, abandoned the station on account of its unhealthy site, removing to Lado. Gondokoro, however, remained a trading-station. It fell into the hands of the Mahdists in 1885. After the destruction of the Mahdist power in 1898 Gondokoro was occupied by British troops and has since formed the northernmost post on the Nile of the Uganda protectorate (see SUDAN; NILE; and UGANDA).

GONDOMAR, DIEGO SARMIENTO DE ACUÑA, COUNT OF (1567-1626). Spanish diplomatist, was the son of Garcia Sarmiento de Sotomayor, corregidor of Granada, and governor of the Canary Islands, by his marriage with Juana de Acuña, an heiress. Diego Sarmiento, their eldest son, was born in the parish of Gondomar, in the bishopric of Tuy, Galicia, Spain, on the 1st of November 1567. He inherited wide estates both in Galicia and in Old Castile. In 1583 he was appointed by Philip II. to the military command of the Portuguese frontier and sea coast of Galicia. He is said to have taken an active part in the repulse of an English coast-raid in 1585, and in the defence of the country during the unsuccessful English attack on Corunna in 1589. In 1593 he was named corregidor of Toro. In 1603 he was sent from court to Vigo to superintend the distribution of the treasure brought from America by two galleons which were driven to take refuge at Vigo, and on his return was named a member of the board of finance. In 1600 he was again employed on the coast of Galicia, this time to repel a naval attack made by the Dutch. Although he held military commands, and administrative posts, his habitual residence was at Valladolid, where he owned the Casa del Sol and was already collecting his fine library. He was known as a courtier, and apparently as a friend of the favourite, the duke of Lerma. In 1612 he was chosen as ambassador in England, but did not leave to take up his appointment till May 1613.

His reputation as a diplomatist is based on his two periods of service in England from 1613 to 1618 and from 1619 to 1622. The excellence of his latinity pleased the literary tastes of James I., whose character he judged with remarkable insight. He flattered the king's love of books and of peace, and he made skilful use of his desire for a matrimonial alliance between the prince of Wales and a Spanish infanta. The ambassador's task was to keep James from aiding the Protestant states against Spain and the house of Austria, and to avert English attacks on Spanish possessions in America. His success made him odious to the anti-Spanish and puritan parties. The active part he took in promoting the execution of Sir Walter Raleigh aroused particular animosity. He was attacked in pamphlets, and the dramatist Thomas Middleton made him a principal person in the strange political play *A Game of Chess*, which was suppressed by order of the council. In 1617 Sarmiento was created count of Gondomar. In 1618 he obtained leave to come home for his health, but was ordered to return by way of Flanders and France with a diplomatic mission. In 1619 he returned to London, and remained till 1622, when he was allowed to retire. On his return he was named a member of the royal council and governor of one of the king's palaces, and was appointed to a complimentary mission to Vienna. Gondomar was in Madrid when the prince of Wales—afterwards Charles I.—made his journey there in search of a wife. He died at the house of the constable of Castile, near Haro in the Rioja, on the 2nd of October 1626.

Gondomar was twice married, first to his niece Beatriz Sarmiento, by whom he had no children, and then to his cousin Constanza de Acuña, by whom he had four sons and three daughters. The hatred he aroused in England, which was shown by constant jeers at the intestinal complaint from which he suffered for years, was the best tribute to the zeal with which he served his own master. Gondomar collected, both before he came to London and during his residence there, a very fine

library of printed books and manuscripts. Orders for the arrangement, binding and storing of his books in his house at Valladolid take a prominent place in his voluminous correspondence. In 1785 the library was ceded by his descendant and representative the marquis of Malpica to King Charles III., and it is now in the Royal Library at Madrid. A portrait of Gondomar, attributed to Valazquez, was formerly at Stowe. It was mezzotinted by Robert Cooper.

AUTHORITIES.—Gondomar's missions to England are largely dealt with in S. R. Gardiner's *History of England* (London, 1883-1884). In Spanish, Don Pascual de Gayangos wrote a useful bibliographical introduction to a publication of a few of his letters—*Cinco Cartas politico-literarias de Don Diego Sarmiento de Acuña, Conde de Gondomar*, issued at Madrid 1869 by the *Sociedad de Bibliófilos* of the Spanish Academy; and there is a life in English by F. H. Lyon (1910). (D. H.)

GONDOPHARES, or **GONDOPHERNES**, an Indo-Parthian king who ruled over the Kabul valley and the Punjab. By means of his coins his accession may be dated with practical certainty at A.D. 21, and his reign lasted for some thirty years. He is notable for his association with St Thomas in early Christian tradition. The legend is that India fell to St Thomas, who showed unwillingness to start until Christ appeared in a vision and ordered him to serve King Gondophares and build him a palace. St Thomas accordingly went to India and suffered martyrdom there. This legend is not incompatible with what is known of the chronology of Gondophares' reign.

GONDWANA, the historical name for a large tract of hilly country in India which roughly corresponds with the greater part of the present Central Provinces. It is derived from the aboriginal tribe of Gonds, who still form the largest element in the population and who were at one time the ruling power. From the 12th to as late as the 18th century three or four Gond dynasties reigned over this region with a degree of civilization that seems surprising when compared with the existing condition of the people. They built large walled cities, and accumulated immense treasures of gold and silver and jewels. On the whole, they maintained their independence fairly well against the Mahomedans, being subject only to a nominal submission and occasional payment of tribute. But when the Mahratta invaders appeared, soon after the beginning of the 18th century, the Gond kingdoms offered but a feeble resistance and the aboriginal population fled for safety to the hills. Gondwana was thus included in the dominions of the Bhonsla raja of Nagpur, from whom it finally passed to the British in 1853.

The Gonds, who call themselves Koitur or "highlanders," are the most numerous tribe of Dravidian race in India. Their total number in 1901 was 2,286,913, of whom nearly two millions were enumerated in the Central Provinces, where they form 20% of the population. They have a language of their own, with many dialects, which is intermediate between the two great Dravidian languages, Tamil and Telugu. It is unwritten and has no literature, except a little provided by the missionaries. More than half the Gonds in the Central Provinces have now abandoned their own dialects, and have adopted Aryan forms of speech. This indicates the extent to which they have become Hinduized. The higher class among them, called Raj Gonds, have been definitely admitted into Hinduism as a pure cultivating caste; but the great majority still retain the animistic beliefs, ceremonial observances and impure customs of food which are common to most of the aboriginal tribes of India.

GONFALON (the late French and Italian form, also found in other Romanic languages, of *gonfanon*, which is derived from the O.H. Ger. *gundfano*, *gund*, war, and *fano*, flag, cf. Mod. Ger. *Fahne*, and English "vane"), a banner or standard of the middle ages. It took the form of a small pennon attached below the head of a knight's lance, or when used in religious processions and ceremonies, or as the banner of a city or state or military order, it became a many-streamed rectangular ensign, frequently swinging from a cross-bar attached to a pole. This is the most frequent use of the word. The title of "gonfalonier," the bearer of the gonfalon, was in the middle ages both military and civil. It was borne by the counts of Vexin, as leaders of the

men of Saint Denis, and when the Vexin was incorporated in the kingdom of France the title of *Gonfalonier de Saint Denis* passed to the kings of France, who thus became the bearers of the "oriflamme," as the banner of St Denis was called. "Gonfalonier" was the title of civic magistrates of various degrees of authority in many of the city republics of Italy, notably of Florence, Sienna and Lucca. At Florence the functions of the office varied. At first the gonfaloniers were the leaders of the various military divisions of the inhabitants. In 1293 was created the office of gonfalonier of justice, who carried out the orders of the signiory. By the end of the 14th century the gonfalonier was the chief of the signiory. At Lucca he was the chief magistrate of the republic. At Rome two gonfaloniers must be distinguished, that of the church and that of the Roman people; both offices were conferred by the pope. The first was usually granted to sovereigns, who were bound to defend the church and lead her armies. The second bore a standard with the letters S.P.Q.R. on any enterprise undertaken in the name of the church and the people of Rome, and also at ceremonies, processions, &c. This was granted by the pope to distinguished families. Thus the Cesarini held the office till the end of the 17th century. The Pamphili held it from 1686 till 1764.

GONG (Chinese, *gong-gong* or *lam-tam*), a sonorous or musical instrument of Chinese origin and manufacture, made in the form of a broad thin disk with a deep rim. Gongs vary in diameter from about 20 to 40 in., and they are made of bronze containing a maximum of 22 parts of tin to 78 of copper; but in many cases the proportion of tin is considerably less. Such an alloy, when cast and allowed to cool slowly, is excessively brittle, but it can be tempered and annealed in a peculiar manner. If suddenly cooled from a cherry-red heat, the alloy becomes so soft that it can be hammered and worked on the lathe, and afterwards it may be hardened by re-heating and cooling it slowly. In these properties it will be observed, the alloy behaves in a manner exactly opposite to steel, and the Chinese avail themselves of the known peculiarities for preparing the thin sheets of which gongs are made. They cool their castings of bronze in water, and after hammering out the alloy in the soft state, harden the finished gongs by heating them to a cherry-red and allowing them to cool slowly. These properties of the alloy long remained a secret, said to have been first discovered in Europe by Jean Pierre Joseph d'Arcet at the beginning of the 19th century. Riche and Champion are said to have succeeded in producing tam-tams having all the qualities and timbre of the Chinese instruments. The composition of the alloy of bronze used for making gongs is stated to be as follows: Copper, 76.52; Tin, 22.43; Lead, 0.62; Zinc, 0.23; Iron, 0.18. The gong is beaten with a round, hard, leather-covered pad, fitted on a short stick or handle. It emits a peculiarly sonorous sound, its complex vibrations bursting into a wave-like succession of tones, sometimes shrill, sometimes deep. In China and Japan it is used in religious ceremonies, state processions, marriages and other festivals; and it is said that the Chinese can modify its tone variously by particular ways of striking the disk.

The gong has been effectively used in the orchestra to intensify the impression of fear and horror in melodramatic scenes. The tam-tam was first introduced into a western orchestra by François Joseph Gossec in the funeral march composed at the death of Mirabeau in 1791. Gaspard Spontini used it in *La Vestale* (1807), in the finale of act II., an impressive scene in which the high pontiff pronounces the anathema on the faithless vestal. It was also used in the funeral music played when the remains of Napoleon the Great were brought back to France in 1840. Meyerbeer made use of the instrument in the scene of the resurrection of the three nuns in *Robert le diable*. Four tam-tams are now used at Bayreuth in *Parsifal* to reinforce the bell instruments, although there is no indication given in the score (see *PARSIFAL*). The tam-tam has been treated from its ethnographical side by Franz Heger.² (K. S.)

GÓNGORA Y ARGOTE, LUIS DE (1561-1627), Spanish lyric poet, was born at Cordova on the 11th of July 1561. His father, Francisco de Argote, was *corregidor* of that city; the poet early adopted the surname of his mother, Leonora de Góngora, who

¹ See *La grande Encyclopédie*, vol. viii. (Paris). "Bronze," p. 146a.

² *Alle Metallinstrumente aus Südost-Asien* (Leipzig, 1900). Bd. i. Text; Bd. ii., Tafeln.

was descended from an ancient family. At the age of fifteen he entered as a student of civil and canon law at the university of Salamanca, but he obtained no academic distinctions and was content with an ordinary pass degree. He was already known as a poet in 1585 when Cervantes praised him in the *Galatea*; in this same year he took minor orders, and shortly afterwards was nominated to a canonry at Cordova. About 1605-1606 he was ordained priest, and thenceforth resided principally at Valladolid and Madrid, where, as a contemporary remarks, he "noted and stabbed at everything with his satirical pen." His circle of admirers was now greatly enlarged; but the acknowledgment accorded to his singular genius was both slight and tardy. Ultimately indeed, through the influence of the duke of Sandoval, he obtained an appointment as honorary chaplain to Philip III., but even this slight honour he was not permitted long to enjoy. In 1626 a severe illness, which seriously impaired his memory, compelled his retirement to Cordova, where he died on the 24th of May 1627. An edition of his poems was published almost immediately after his death by Juan Lopez de Vicuña; the frequently reprinted edition by Hozes did not appear till 1633. The collection consists of numerous sonnets, odes, ballads, songs for the guitar, and of certain larger poems, such as the *Soledades* and the *Polifemo*. Too many of them exhibit that tortuous elaboration of style (*estilo culto*) with which the name of Góngora is inseparably associated; but though Góngora has been justly censured for affected Latinisms, unnatural transpositions, strained metaphors and frequent obscurity, it must be admitted that he was a man of rare genius,—a fact cordially acknowledged by those of his contemporaries who were most capable of judging. It was only in the hands of those who imitated Góngora's style without inheriting his genius that *culteranismo* became absurd. Besides his lyrical poems Góngora is the author of a play entitled *Las Fiermezas de Isabel* and of two incomplete dramas, the *Comedia venetoria* and *El Doctor Carlino*. The only satisfactory edition of his works is that published by R. Foulché-Delbosc in the *Bibliotheca Hispanica*.

See Edward Churton, *Góngora* (London, 1862, 2 vols.); M. González y Francés, *Góngora racinero* (Córdoba, 1895); M. González y Francés, *Don Luis de Góngora vindicando su fama ante el propio obispo* (Córdoba, 1899); "Vingt-six Lettres de Góngora" in the *Revue hispanique*, vol. x, pp. 184-225 (Paris, 1903).

GONIOMETER (from Gr. *γωνία*, angle, and *μέτρον*, measure), an instrument for measuring the angles of crystals; there are two kinds—the contact goniometer and the reflecting goniometer. Nicolaus Stena in 1669 determined the interfacial angles of quartz crystals by cutting sections perpendicular to the edges, the plane angles of the sections being then the angles between the faces which are perpendicular to the sections. The earliest instrument was the contact goniometer devised by Carangeot in 1783.

The Contact Goniometer (or Hand-Goniometer).—This consists of two metal rules pivoted together at the centre of a graduated semicircle (fig. 1). The instrument is placed with its plane perpendicular

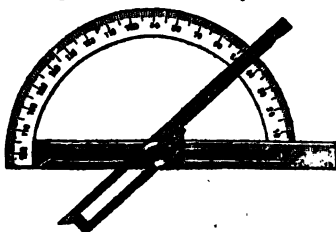

FIG. 1.—Contact Goniometer.

to an edge between two faces of the crystal to be measured, and the rules are brought into contact with the faces; this is best done by holding the crystal up against the edge in the line of sight. The angle between the rules, as read on the graduated semicircle, then gives the angle between the two faces. The rules are slotted, so that they may be shortened and their tips applied to a crystal partly embedded in its matrix. The instrument represented in fig. 1 is practically the same in all its details as that made for Carangeot, and it is employed at the present day for the approximate measurement of large crystals with dull and rough faces. S. L. Penfield (1900) has devised some cheap and simple forms of contact goniometer, consisting of jointed arms and protractors made of cardboard or celluloid.

The Reflecting Goniometer.—This is an instrument of far greater precision, and is always used for the accurate measurement of the angles when small crystals with bright faces are available. As a rule, the smaller the crystal the more even are its faces, and when these are smooth and bright they reflect sharply defined images of a bright object. By turning the crystal about an axis parallel to the edge between two faces, the image reflected from a second face may be brought into the same position as that formerly occupied by the image reflected from the first face, the angle through which the crystal has been rotated, as determined by a graduated circle to which the crystal is fixed, is the angle between the normals to the two faces.

Several forms of instruments depending on this principle have been devised, the earliest being the vertical-circle goniometer of W. H. Wollaston, made in 1809. This consists of a circle *w* (fig. 2), graduated to degrees of arc and reading with the vernier *h* to minutes, which turns with the milled head *l* about a horizontal axis. The crystal is attached with wax (a mixture of bees-wax and pitch) to the holder *g*, and by means of the pivoted arcs it may be adjusted so that the edge between two faces (a zone-axis) is parallel to, and coincident with, the axis of the instrument. The crystal-holder and adjustment-arcs, together with the milled head *s*, are carried on an axis which passes through the hollow of the graduated circle, and may thus be rotated independently of the circle. In use, the goniometer is placed directly opposite to a window, with its axis parallel to the horizontal window-bars, and as far distant as possible. The eye is placed quite close to the crystal, and the image of an upper window-bar (or better still a slit in a dark screen) as seen in the crystal-face is made to coincide with a lower window-bar (or chalk mark on the floor) as seen directly; this is done by turning the milled head *s*, the reading of the graduated circle having previously been observed.

Without moving the eye, the milled head *l*, together with the crystal, is then rotated until the image from a second face is brought into the same position; the difference between the first and second readings of the graduated circle will then give the angle between the normals of the two faces.

Several improvements have been made on Wollaston's goniometer. The adjustment-arcs have been modified; a mirror of black glass fixed to the stand beneath the crystal gives a reflected image of the signal, with which the reflection from the crystal can be more conveniently made to coincide; a telescope provided with cross-wires gives greater precision to the direction of the reflected rays of light; and with the telescope a collimator has sometimes been used.

A still greater improvement was effected by placing the graduated circle in a horizontal position, as in the instruments of E. L. Malus (1810), F. C. von Rüch (1829) and J. Babinet (1839). Many forms of the horizontal-circle goniometer have been constructed; they are essentially the same as a spectrometer, with the addition of arrangements for adjusting and centring the crystal. The instrument shown in fig. 3 is made by R. Fuess of Berlin. It has four concentric axes, which enable the crystal-holder *A*, together with the adjustment-arcs *B* and centring-slides *D*, to be raised or lowered, or to be rotated independently of the circle *H*; further, either the crystal-holder or the telescope *T* may be rotated with the circle, while the other

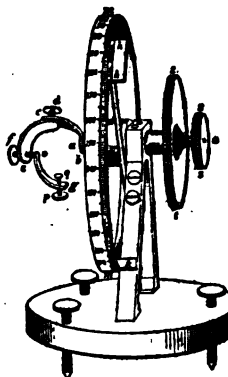

FIG. 2.—Vertical-Circle Goniometer.

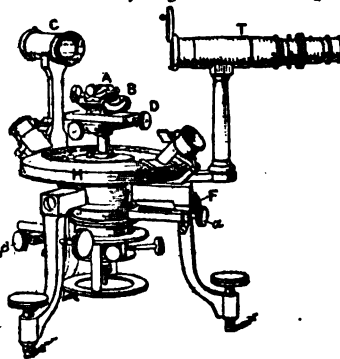

FIG. 3.—Horizontal-Circle Goniometer.

remains fixed. The crystal is placed on the holder and adjusted so that the edge (zone-axis) between two faces is coincident with the axis of the instrument. Light from an incandescent gas-burner passes through the slit of the collimator C, and the image of the slit (signal) reflected from the crystal face is viewed in the telescope. The clamp α and slow-motion screw F enable the image to be brought exactly on the cross-wires of the telescope, and the position of the circle with respect to the vernier is read through the lens. The crystal and the circle are then rotated together until the image from a second face is brought on the cross-wires of the telescope, and the angle through which they have been turned is the angle between the normals to the two faces. While measuring the angles between the faces of crystals the telescope remains fixed by the clamp β , but when this is released the instrument may be used as a spectrometer or refractometer for determining, by the method of minimum deviation, the indices of refraction of an artificially cut prism or of a transparent crystal when the faces are suitably inclined to one another.

With a one-circle goniometer, such as is described above, it is necessary to mount and re-adjust the crystal afresh for the measurement of each zone of faces (i.e. each set of faces intersecting in parallel edges); with very small crystals this operation takes a considerable time, and the minute faces are not readily identified again. Further, in certain cases, it is not possible to measure the angles between zones, nor to determine the position of small faces which do not lie in prominent zones on the crystal. These difficulties have been overcome by the use of a two-circle goniometer or theodolite-goniometer, which as a combination of a vertical-circle goniometer and one with a horizontal-circle was first employed by W. H. Miller in 1874. Special forms have been designed by E. S. Fedorov (1889), V. Goldschmidt (1893), S. Casapoli (1893) and F. Stoeber (1898), which differ mainly in the arrangement of the optical parts. In these instruments the crystal is set up and adjusted once for all, with the axis of a prominent zone parallel to the axis of either the horizontal or the vertical circle. As a rule, only in this zone can the angles between the faces be measured directly; the positions of all the other faces, which need be observed only once, are fixed by the simultaneous readings of the two circles. These readings, corresponding to the polar distance and azimuth, or latitude and longitude readings of astronomical telescopes, must be plotted on a projection before the symmetry of the crystal is apparent; and laborious calculations are necessary in order to determine the indices of the faces and the angles between them, and the other constants of the crystal, or to test whether any three faces are accurately in a zone.

These disadvantages are overcome by adding still another graduated circle to the instrument, with its axis perpendicular to the axis of the vertical circle, thus forming a three-circle goniometer. With such an instrument measurements may be made in any zone or between any two faces without re-adjusting the crystal; further the troublesome calculations are avoided, and, indeed, the instrument may be used for solving spherical triangles. Different forms of three-circle goniometers have been designed by G. F. H. Smith (1899 and 1904), E. S. Fedorov (1900) and J. F. C. Klein (1900). Besides being used as a one-, two-, or three-circle goniometer for the measurement of the interfacial angles of crystals, and as a refractometer for determining refractive indices by the prismatic method or by total reflection, Klein's instrument, which is called a polarimeter, is fitted with accessory optical apparatus which enables it to be used for examining a crystal in parallel or convergent polarized light and for measuring the optic axial angle.

Goniometers of special construction have been devised for certain purposes; for instance, the inverted horizontal-circle goniometer of H. A. Miers (1903) for measuring crystals during their growth in the mother-liquid. A. E. Tutton (1894) has combined a goniometer with lapidary's appliances for cutting section-plates and prisms from crystals accurately in any desired direction. The instrument commonly employed for measuring the optic axial angle of biaxial crystals is really a combination of a goniometer with a polariscope. For the optical investigation of minute crystals under the microscope, various forms of stage-goniometer with one, two or three graduated circles have been constructed. An ordinary microscope fitted with cross-wires and a rotating graduated stage serves the purpose of a goniometer for measuring the plane angles of a crystal face or section, being the same in principle as the contact goniometer.

For fuller descriptions of goniometers reference may be made to the text-books of Crystallography and Mineralogy, especially to F. H. Groth, *Physikalische Kristallographie* (4th ed., Leipzig, 1905). See also C. Weiss, *Die optischen Instrumente der Firma R. Fuess, deren Beschreibung, Justierung und Anwendung* (Leipzig, 1899). (L. J. S.)

GONTAUT, MARIE JOSEPHINE LOUISE, DUCHESS OF (1773-1857), was born in Paris on the 3rd of August 1773, daughter of Augustin François, comte de Montaut-Navailles, who had been governor of Louis XVI. and his two brothers when children. The count of Provence (afterwards Louis XVIII.) and his wife stood sponsors to Joséphine de Montaut, and she shared the lessons given by Madame de Genlis to the Orleans family, with whom her mother broke off relations after the out-

break of the Revolution. Mother and daughter emigrated to Coblenz in 1792; thence they went to Rotterdam, and finally to England, where Joséphine married the marquis Charles Michel de Gontaut-Saint-Blancard. They returned to France at the Restoration, and resumed their place at court. Madame de Gontaut became lady-in-waiting to Caroline, duchess of Berry, and, on the birth of the princess Louise (Mlle d'Artois, afterwards duchess of Parma), governess to the children of France. Next year the birth of Henry, duke of Bordeaux (afterwards known as the comte de Chambord), added to her charge the heir of the Bourbons. She remained faithful to his cause all her life. Her husband died in 1802, and in 1827 she was created duchesse de Gontaut. She followed the exiled royal family in 1830 to Holyrood Palace, and then to Prague, but in 1834, owing to differences with Pierre Louis, duc de Blacas, who thought her comparatively liberal views dangerous for the prince and princess, she received a brusque congé from Charles X. Her twin daughters, Joséphine (1796-1844) and Charlotte (1796-1818), married respectively Ferdinand de Chabot, prince de Léon and afterwards duc de Rohan, and François, comte de Bourbon-Busset. She herself wrote in her old age some naïve memoirs, which throw an odd light on the pretensions of the "governess of the children of France." She died in Paris in 1857.

See her *Memoirs* (Eng. ed., 2 vols., 1894), and *Lettres inédites* (1895).

GONVILLE, EDMUND (d. 1351), founder of Gonville Hall, now Gonville and Caius College, at Cambridge, England, is thought to have been the son of William de Gonville, and the brother of Sir Nicholas Gonville. In 1320 he was rector of Theltham, Suffolk, and steward there for William, earl Warren and the earl of Lancaster. Six years later he was rector of Rushworth, and in 1348 rector of Terrington St John and commissioner for the marshlands of Norfolk. In this year he founded and endowed a collegiate church at Rushworth, suppressed in 1541. The foundation of Gonville Hall at Cambridge was effected by a charter granted by Edward III. in 1348. It was called, officially, the Hall of the Annunciation of the Blessed Virgin, but was usually known as Gonnell or Gonville Hall. Its original site was in Free-school Lane, where Corpus Christi College now stands. Gonville apparently wished it to be devoted to training for theological study, but after his death the foundation was completed by William Bateman, bishop of Norwich and founder of Trinity Hall, on a different site and with considerably altered statutes. (See also CAIUS, JOHN.)

GONZAGA, an Italian princely family named after the town where it probably had its origin. Its known history begins with the 13th century, when Luigi I. (1267-1360), after fierce struggles supplanted his brother-in-law Rinaldo (nicknamed Passerino) Bonacolsi as lord of Mantua in August 1328, with the title of captain-general, and afterwards of vicar-general of the empire, adding the designation of count of Mirandola and Concordia, which his father the Gonzagas held from 1328 to 1354. In July 1355 his son Guido, with the help of Filippino and Feltrino Gonzaga, wrested Reggio from the Scaligeri and held it until 1371. Luigi succeeded by Guido (d. 1369); the latter's son Luigi II. came next in succession (d. 1382), and then Giovan Francesco I. (d. 1407), who, although at one time allied with the treacherous Gian Galeazzo Visconti, incurred the latter's enmity and all but lost his estates and his life in consequence; eventually he joined the Florentines and Bolognese, enemies of Visconti. He promoted commerce and wisely developed the prosperity of his dominions. His son Giovan Francesco II. (d. 1444) succeeded him under the regency of his uncle Carlo Malatesta and the protection of the Venetians. He became a famous general, and was rewarded for his services to the emperor Sigismund with the title of marquis of Mantua for himself and his descendants (1432), an investiture which legitimized the usurpations of the house of Gonzaga. His son Luigi III. "il Turco" (d. 1478) likewise became a celebrated soldier, and was also a learned and liberal prince, a patron of literature and the arts. His son Federico I. (d. 1484) followed in his father's footsteps, and served under various foreign sovereigns, including Bonas of Savoy and Lorenzo de' Medici; subsequently he upheld the rights of the house of

Este against Pope Sixtus IV. and the Venetians, whose ambitious claims were a menace to his own dominions of Ferrara and Mantova. His son Giovan Francesco III. (d. 1519) continued the military traditions of the family, and commanded the allied Italian forces against Charles VIII. at the battle of Fornovo; he afterwards fought in the kingdom of Naples and in Tuscany, until captured by the Venetians in 1509. On his liberation he adopted a more peaceful and conciliatory policy, and with the help of his wife, the famous Isabella d'Este, he promoted the fine arts and letters, collecting pictures, statues and other works of art with intelligent discrimination. He was succeeded by his son Federico II. (d. 1540), captain-general of the papal forces. After the peace of Cambrai (1529) his ally and protector, the emperor Charles V., raised his title to that of duke of Mantua in 1530; in 1536 the emperor decided the controversy for the succession of Monferrato between Federico and the house of Savoy in favour of the former. His son Francesco I. succeeded him, and, being a minor, was placed under the regency of his uncle Cardinal Ercole; he was accidentally drowned in 1550, leaving his possessions to his brother Guglielmo. The latter was an extravagant spendthrift, but having subdued a revolt in Monferrato was presented with that territory by the emperor Maximilian II. At his death in 1587 he was succeeded by his son Vincenzo I. (d. 1612), who was more addicted to amusements than to warfare. Then followed in succession his sons Francesco II. (d. 1612), Ferdinand (d. 1626), and Vincenzo II. (d. 1627), all three incapable and dissolute princes. The last named appointed as his successor Charles, the son of Henriette, the heiress of the French family of Nevers-Kethel, who was only able to take possession of the ducal throne after a bloody struggle; his dominions were laid waste by foreign invasions and he himself was reduced to the sorest straits. He died in 1637, leaving his possessions to his grandson Charles (Carlo) II. under the regency of the latter's mother Maria Gonzaga, which lasted until 1647. Charles died in consequence of his own profligacy and was succeeded by his son Ferdinand Charles (Ferdinando Carlo), who was likewise for some years under the regency of his mother Isabella of Austria. Ferdinand Charles, another extravagant and dissolute prince, acquired the county of Guastalla by marriage in 1678, but lost it soon afterwards; he involved his country in useless warfare, with the result that in 1708 Austria annexed the duchy. On the 5th of July of the same year he died in Venice, and with him the Gonzagas of Mantua came to an end.

Of the cadet branches of the house one received the lordship of Bozzolo, another the counties of Novellara and Bagnolo, a third, of which the founder was Ferrante I. (d. 1557), retained the county of Guastalla, raised to a duchy in 1621, and came to an end with the death of Giuseppe Maria on the 16th of August 1746.

BIBLIOGRAPHY.—S. Maffei, *Annali di Mantova* (Tortona, 1675); G. Veronesi, *Quadro storico della Mirandola* (Modena, 1847); T. Affò, *Storia di Guastalla* (Guastalla, 1875, 4 vols.); Alessandro Luzio, *I Precattori d'Isabella d'Este* (Ancona, 1887); A. Luzio and R. Renier, "Francesco Gonzaga alla battaglia di Fornovo (1495), secondo i documenti Mantovani" (in *Archivio storico italiano*, ser. v. vol. vi., 205-246); *id.*, *Mantova e Urbino, Isabella d'Este e Elisabeth Gonzaga nelle relazioni famigliari e nelle vicende politiche* (Turin, 1893); L. G. Pélissier, "Les Relations de François de Gonzague, marquis de Mantoue, avec Ludovico Strozzi et Louis XII" (in *Annales de la Faculté de Lettres de Bordeaux*, 1893); Antonino Bertolotti, "Lettere del duca di Savoia Emanuele Filiberto a Guglielmo Gonzaga, duca di Mantova" (*Arch. stor. it.*, ser. v., vol. ix., pp. 250-283); Edmondo Solari, *Lettere inedite del card. Gaspare Contarini nel casteggio del card. Ercole Gonzaga* (Venice, 1904); Arturo Segrè, *Il Richiamo di Don Ferrante Gonzaga dal governo di Milano, e sue conseguenze* (Turin, 1904).

GONZAGA, THOMAZ ANTONIO (1744-1800), Portuguese poet, was a native of Oporto and the son of a Brazilian-born judge. He spent a part of his boyhood at Bahia, where his father was *disembargador* of the appeal court, and returning to Portugal he went to the university of Coimbra and took his law degree at the age of twenty-four. He remained on there for some years and compiled a treatise of natural law on regalist lines, dedicating it to Pombal, but the fall of the marquis led him to

leave Coimbra and become a candidate for a magistracy, and in 1782 he obtained the posts of *ouvidor* and *procurador* of the goods of deceased and absent persons at Villa Rica in the province of Minas Geraes in Brazil. In 1786 he was named *disembargador* of the appeal court at Bahia, and three years later, as he was about to marry a young lady of position, D. Maria de Seixas Brandão, the *Marília* of his verses, he suddenly found himself arrested on the charge of being the principal author of a Republican conspiracy in Minas. Conducted to Rio, he was imprisoned in a fortress and interrogated, but constantly asserted his innocence. However, his friendship with the conspirators compromised him in the eyes of his absolutist judges, who, on the ground that he had known of the plot and not denounced it, sentenced him in April 1792 to perpetual exile in Angola, with the confiscation of his property. Later, this penalty was commuted into one of ten years of exile to Mozambique, with a death sentence if he should return to America. After having spent three years in prison, Gonzaga sailed in May 1792 for Mozambique and shortly after his arrival a violent fever almost ended his life. A wealthy Portuguese gentleman, married to a lady of colour, charitably received him into his house, and when the poet recovered, he married their young daughter who had nursed him through the attack. He lived in exile until his death, practising advocacy at intervals, but his last years were embittered by fits of melancholia, deepening into madness, which were brought on by the remembrance of his misfortunes. His reputation as a poet rests on a little volume of bucolics entitled *Marília*, which includes all his published verses and is divided into two parts, corresponding with those of his life. The first extends to his imprisonment and breathes only love and pleasure, while the main theme of the second part, written in prison, is his *saudade* for *Marília* and past happiness. Gonzaga borrowed his forms from the best models, Anacreon and Theocritus, but the matter, except for an occasional imitation of Petrarch, the natural, elegant style and the harmonious metrifaction, are all his own. The booklet comprises the most celebrated collection of erotic poetry dedicated to a single person in the Portuguese tongue; indeed its popularity is so great as to exceed its intrinsic merit.

Twenty-nine editions had appeared up to 1854, but the Paris edition of 1862 in 2 vols. is in every way the best, although the authenticity of the verses in its 3rd part, which do not relate to *Marília*, is doubtful. A popular edition of the first two parts was published in 1888 (Lisbon, Corazzi). A French version of *Marília* by Monglave and Chalas appeared in Paris in 1825, an Italian by Vezzi Ruscalla at Turin in 1844, a Latin by Dr Castro Lopes at Rio in 1868, and there is a Spanish one by Vedia.

See Innocencio da Silva, *Dicionário bibliográfico português*, vol. vii. p. 320, also Dr T. Braga, *Filinto Elysio e os Disidentes da Arcadia* (Oporto, 1901). (E. Pz.)

GONZÁLEZ-CARVAJAL, TOMAS JOSÉ (1753-1834), Spanish poet and statesman, was born at Seville in 1753. He studied at the university of Seville, and took the degree of LL.D. at Madrid. He obtained an office in the financial department of the government; and in 1795 was made intendant of the colonies which had just been founded in Sierra Morena and Andalusia. During 1809-1811 he held an intendency in the patriot army. He became, in 1812, director of the university of San Isidro; but having offended the government by establishing a chair of international law, he was imprisoned for five years (1815-1820). The revolution of 1820 reinstated him, but the counter-revolution of three years later forced him into exile. After four years he was allowed to return, and he died, in 1834, a member of the supreme council of war. González-Carvajal enjoyed European fame as author of metrical translations of the poetical books of the Bible. To fit himself for this work he commenced the study of Hebrew at the age of fifty-four. He also wrote other works in verse and prose, avowedly taking Luis de Leon as his model.

See biographical notice in *Biblioteca de Rivadeneyra*, vol. lxxiv., *Poetas del siglo 18*.

GONZALO DE BERCEO (c. 1180-c. 1246), the earliest Castilian poet whose name is known to us, was born at Berceo, a village in the neighbourhood of Calahorra in the province of Logroño. In 1221 he became a deacon and was attached, as a secular priest, to the Benedictine monastery of San Millán de la Cogolla, in the

diocese of Calahorra. His name is to be met with in a number of documents between the years 1237 and 1246. He wrote upwards of 13,000 verses, all on devotional subjects. His best work is a life of St Oria; others treat of the life of St Millan, of St Dominic of Silos, of the Sacrifice of the Mass, the Martyrdom of St Laurence, the visible signs preceding the Last Judgment, the Praises of Our Lady, the Miracles of Our Lady and the Lamentations of the Virgin on the Passion of her Son. He writes in the common tongue, the *roman paladino*, and his claim to the name of poet rests on his use of the *cuaderna via* (single-rhymed quatrains, each verse being of fourteen syllables). Sometimes, however, he takes the more modest title of *jugar* (*jongleur*), when claiming payment for his poems. His literary attainments are not great, and he lacks imagination and animation of style, but he has a certain eloquence, and in speaking of the Virgin and the saints a certain charm, while his verse bears at times the imprint of a passionate devotion, recalling the lyrical style of the great Spanish mystics. There is, however, a very strong popular element in his writings, which explains his long vogue. The great majority of his legends of the Virgin are obviously borrowed from the collection of a Frenchman, Gautier de Coinci; but he has succeeded in making this material entirely his own by reason of a certain conciseness and a realism in detail which make his work far superior to the tedious and colourless narrative of his model.

His *Poestas* are in the *Biblioteca de autores españoles* of Rivadeneyra, vol. lvii. (1864); *La Vida de San Domingo de Silos* has been edited by J. D. FitzGerald (Paris, 1904; see the *Bibliothèque de l'École des Hautes Études*, part 149); see also F. Fernández y González in the *Razón* (vol. 1, Madrid, 1860); N. Hergueta, "Documentos referentes a Gonzalo de Berceo," in the *Revista de archivos*, 3rd series, Feb.-March, 1904, pp. 178-179. (P. A.)

GOOCH, SIR DANIEL, Bart. (1816-1889), English mechanical engineer, was born at Bedlington, in Northumberland, on the 16th of August 1816. At the age of fifteen, having shown a taste for mechanics, he was put to work at the Tredegar Ironworks, Monmouthshire. In 1834 he went to Warrington, where, at the Vulcan foundry, under Robert Stephenson, he acquired the principles of locomotive design. Subsequently, after passing a year at Dundee, he was engaged by the Stephensons at their Gateshead works, where he seems to have conceived that predilection for the broad gauge for which he was afterwards distinguished, through having to design some engines for a 6-foot gauge in Russia and noticing the advantages it offered in allowing greater space for the machinery, &c., as compared with the standard gauge favoured by Stephenson. In 1837, on I. K. Brunel's recommendation, he was appointed locomotive superintendent to the Great Western railway at a time when the engines possessed by the railway were very poor and inefficient. He soon improved this state of affairs, and gradually provided his employers with locomotives which were unsurpassed for general excellence and economy of working. One of the most famous, the "Lord of the Isles," was awarded a gold medal at the Great Exhibition of 1851, and when, thirty years afterwards, it was withdrawn from active service it had run more than three-quarters of a million miles, all with its original boiler. In 1864, he left the Great Western and interested himself in the problem of laying a telegraph cable across the Atlantic. At this time the "Great Eastern" was in the hands of the bondholders, of whom he himself was one of the most important, and it occurred to him that she might advantageously be utilized in the enterprise. Accordingly, at his instance she was chartered by the Telegraph Construction Company, of which also he was a director, and in 1865 was employed in the attempt to lay a cable, Gooch himself superintending operations. The cable, however, broke in mid-ocean, and the attempt was a failure. Next year it was renewed with more success, for not only was a new cable safely put in place, but the older one was picked up and spliced, so that there were two complete lines between England and America. For this achievement Gooch was created a baronet. Meanwhile the Great Western railway had fallen on evil days, being indeed on the verge of bankruptcy, when in 1866 the directors appealed to him to accept the chairmanship of the board and undertake the

rehabilitation of the company. He agreed to the proposal, and was so successful in restoring its prosperity that in 1869, at the last meeting over which he presided, a dividend was declared at the rate of 7½%. Under his administration the system was greatly enlarged and consolidated by the absorption of various smaller lines, such as the Bristol and Exeter and the Cornwall railways; and his appreciation of its strategic value caused him to be a strenuous supporter of the construction of the Severn Tunnel. His death occurred on the 15th of October 1889 at his residence, Clewer Park, near Windsor.

GOOD, JOHN MASON (1764-1827), English writer on medical, religious and classical subjects, was born on the 15th of May 1764 at Epping, Essex. After attending a school at Romsey kept by his father, the Rev. Peter Good, who was a Nonconformist minister, he was, at about the age of fifteen, apprenticed to a surgeon-apothecary at Gosport. In 1783 he went to London to prosecute his medical studies, and in the autumn of 1784 he began to practise as a surgeon at Sudbury in Suffolk. In 1793 he removed to London, where he entered into partnership with a surgeon and apothecary. But the partnership was soon dissolved, and to increase his income he began to devote attention to literary pursuits. Besides contributing both in prose and verse to the *Analytical* and *Critical Reviews* and the *British* and *Monthly Magazines*, and other periodicals, he wrote a large number of works relating chiefly to medical and religious subjects. In 1794 he became a member of the British Pharmaceutical Society, and in that connexion, and especially by the publication of his work, *A History of Medicine* (1795), he did much to effect a greatly needed reform in the profession of the apothecary. In 1820 he took the diploma of M.D. at Marischal College, Aberdeen. He died at Shepperton, Middlesex, on the 2nd of January 1827. Good was not only well versed in classical literature, but was acquainted with the principal European languages, and also with Persian, Arabic and Hebrew. His prose works display wide erudition; but their style is dull and tedious. His poetry never rises above pleasant and well-verified commonplace. His translation of Lucretius, *The Nature of Things* (1803-1807), contains elaborate philological and explanatory notes, together with parallel passages and quotations from European and Asiatic authors.

GOOD FRIDAY (probably "God's Friday"), the English name for the Friday before Easter, kept as the anniversary of the Crucifixion. In the Greek Church it has been or is known as *πέντηκοστή* (*pentecostē*), *παρασκευή*, *παρασκευὴ μεγάλη* or *δύλη*, *συντήρια* or *τὰ σωτήρια*, *ἡμέρα τοῦ σταυροῦ*, while among the Latins the names of most frequent occurrence are *Pascha Crucis*, *Dies Dominicae Passionis*, *Parasceve*, *Foris Sexta Paschae*, *Feria Sexta Major* in Hierusalem, *Dies Absolutionis*. It was called Long Friday by the Anglo-Saxons¹ and *Dames*, possibly in allusion to the length of the services which marked the day. In Germany it is sometimes designated *Stiller Freitag* (compare Greek, *ἡβδόμη ἄπρακτος*; Latin, *hebdōmas inefficax, non laboriosa*), but more commonly *Charfreitag*. The etymology of this last name has been much disputed, but there seems now to be little doubt that it is derived from the Old High German *chara*, meaning suffering or mourning.

The origin of the custom of a yearly commemoration of the Crucifixion is somewhat obscure. It may be regarded as certain that among Jewish Christians it almost imperceptibly grew out of the old habit of annually celebrating the Passover on the 14th of Nisan, and of observing the "days of unleavened bread" from the 15th to the 21st of that month. In the Gentile churches, on the other hand, it seems to be well established that originally no yearly cycle of festivals was known at all. (See **EASTER**.)

From its earliest observance, the day was marked by a specially rigorous fast, and also, on the whole, by a tendency to greater simplicity in the services of the church. Prior to the 4th century there is no evidence of non-celebration of the eucharist on Good Friday; but after that date the prohibition of communion

¹ See Johnson's *Collection of Ecclesiastical Laws* (vol. 1, anno 957): "Housel ought not to be hallowed on Long Friday, because Christ suffered for us on that day."

became common. In Spain, indeed, it became customary to close the churches altogether as a sign of mourning; but this practice was condemned by the council of Toledo (633). In the Roman Catholic Church the Good Friday ritual at present observed is marked by many special features, most of which can be traced back to a date at least prior to the close of the 8th century (see the *Ordo Romanus* in Muratori's *Liturg. Rom. Vet.*). The altar and officiating clergy are draped in black, this being the only day on which that colour is permitted. Instead of the epistle, sundry passages from Hosea, Habakkuk, Exodus and the Psalms are read. The gospel for the day consists of the history of the Passion as recorded by St John. This is often sung in plain-chant by three priests, one representing the "narrator," the other two the various characters of the story. The singing of this is followed by bidding prayers for the peace and unity of the church, for the pope, the clergy, all ranks and conditions of men, the sovereign, for catechumens, the sick and afflicted, heretics and schismatics, Jews and heathen. Then follows the "adoration of the cross" (a ceremony derived from the church of Jerusalem and said to date back to near the time of Helena's "invention of the cross"); the hymns *Pange lingua* and *Vexilla regis* are sung, and then follows the "Mass of the Presanctified." The name is derived from the fact that it is celebrated with elements consecrated the day before, the liturgy being omitted on this day. The priest merely places the Sacrament on the altar, censes it, elevates and breaks the host, and communicates, the prayers and responses interspersed being peculiar to the day. This again is followed by vespers, with a special anthem; after which the altar is stripped in silence. In many Roman Catholic countries—in Spain, for example—it is usual for the faithful to spend much time in the churches in meditation on the "seven last words" of the Saviour; no carriages are driven through the streets; the bells and organs are silent; and in every possible way it is sought to deepen the impression of a profound and universal grief. In the Greek Church also the Good Friday fast is excessively strict; as in the Roman Church, the Passion history is read and the cross adored; towards evening a dramatic representation of the entombment takes place, amid open demonstrations of contempt for Judas and the Jews. In Lutheran churches the organ is silent on this day, and altar, font and pulpit are draped in black, as indeed throughout Holy Week. In the Church of England the history of the Passion from the gospel according to John is also read; the collects for the day are based upon the bidding prayers which are found in the *Ordo Romanus*. The "three hours" service, borrowed from Roman Catholic usage and consisting of prayers, addresses on the "seven last words from the cross" and intervals for meditation and silent prayer, has become very popular in the Anglican Church, and the observance of the day is more marked than formerly among Nonconformist bodies, even in Scotland.

GOODMAN, GODFREY (1583-1656), bishop of Gloucester, was born at Ruthin, Denbighshire, and educated at Westminster and Cambridge. He took orders in 1603, and in 1606 obtained the living of Stapleford Abbots, Essex, which he held together with several other livings. He was canon of Windsor from 1617 and dean of Rochester 1620-1621, and became bishop of Gloucester in 1625. From this time his tendencies towards Roman Catholicism constantly got him into trouble. He preached an unsatisfactory sermon at court in 1626, and in 1628 incurred charges of introducing popery at Windsor. In 1633 he secured the see of Hereford by bribery, but Archbishop Laud persuaded the king to refuse his consent. In 1638 he was said to be converted to Rome, and two years later he was imprisoned for refusing to sign the new canons denouncing popery and affirming the divine right of kings. He afterwards signed and was released on bail, but next year the bishops who had signed were all imprisoned in the Tower, by order of parliament, on the charge of treason. After eighteen weeks' imprisonment Goodman was allowed to return to his diocese. About 1650 he settled in London, where he died a confessed Roman Catholic. His best known book is *The Fall of Man* (London, 1616).

GOODRICH, SAMUEL GRISWOLD (1793-1860), American author, better known under the pseudonym of "Peter Parley," was born, the son of a Congregational minister, at Ridgefield, Connecticut, on the 19th of August 1793. He was largely self-educated, became an assistant in a country store at Danbury, Conn., in 1808, and at Hartford, Conn., in 1811, and from 1816 to 1822 was a bookseller and publisher at Hartford. He visited Europe in 1823-1824, and in 1826 removed to Boston, where he continued in the publishing business, and from 1828 to 1842 he published an illustrated annual, the *Token*, to which he was a frequent contributor both in prose and verse. A selection from these contributions was published in 1841 under the title *Sketches from a Student's Window*. The *Token* also contained some of the earliest work of Nathaniel Hawthorne, N. P. Willis, Henry W. Longfellow and Lydia Maria Child. In 1841 he established *Merry's Museum*, which he continued to edit till 1854. In 1827 he began, under the name of "Peter Parley," his series of books for the young, which embraced geography, biography, history, science and miscellaneous tales. Of these he was the sole author of only a few, but in 1857 he wrote that he was "the author and editor of about 170 volumes," and that about seven millions had been sold. In 1857 he published *Recollections of a Lifetime*, which contains a list both of the works of which he was the author or editor and of the spurious works published under his name. By his writings and publications he amassed a large fortune. He was chosen a member of the Massachusetts House of Representatives in 1836, and of the state Senate in 1837, his competitor in the last election being Alexander H. Everett, and in 1851-1853 he was consul at Paris, where he remained till 1855, taking advantage of his stay to have several of his works translated into French. After his return to America he published, in 1859, *Illustrated History of the Animal Kingdom*. He died, in New York, on the 9th of May 1860.

His brother, CHARLES AUGUSTUS GOODRICH (1790-1862), a Congregational clergyman, published various ephemeral books, and helped to compile some of the "Peter Parley" series.

GOODRICH, or GOODRICKE, THOMAS (d. 1554), English ecclesiastic, was a son of Edward Goodrich of East Kirby, Lincolnshire, and was educated at Corpus Christi College, Cambridge, afterwards becoming a fellow of Jesus College in the same university. He was among the divines consulted about the legality of Henry VIII.'s marriage with Catherine of Aragon, became one of the royal chaplains about 1530, and was consecrated bishop of Ely in 1534. He was favourable to the Reformation, helped in 1537 to draw up the *Institution of a Christian Man* (known as the *Bishops' Book*), and translated the Gospel of St John for the revised New Testament. On the accession of Edward VI. in 1547 the bishop was made a privy councillor, and took a conspicuous part in public affairs during the reign. "A busy secular spirited man," as Burnet calls him, he was equally opposed to the zealots of the "old" and the "new religion." He assisted to compile the First Prayer Book of Edward VI., was one of the commissioners for the trial of Bishop Gardiner, and in January 1551-1552 succeeded Rich as lord high chancellor. This office he continued to hold during the nine days' reign of "Queen Jane" (Lady Jane Grey); but he continued to make his peace with Queen Mary, conformed to the restored religion, and, though deprived of the chancellorship, was allowed to keep his bishopric until his death on the 10th of May 1554.

See the *Dict. Nat. Biog.*, where further authorities are cited.

GOODSIR, JOHN (1814-1867), Scottish anatomist, born at Anstruther, Fife, on the 20th of March 1814, was the son of Dr John Goodsir, and grandson of Dr John Goodsir of Largo. He was educated at the burgh and grammar-schools of his native place and at the university of St Andrews. In 1830 he was apprenticed to a surgeon-dentist in Edinburgh, where he studied anatomy under Robert Knox, and in 1835 he joined his father in practice at Anstruther. Three years later he communicated to the British Association a paper on the pulps and sacs of the human teeth, his researches on the whole process of dentition

being at this time distinguished by their completeness; and about the same date, on the nomination of Edward Forbes, he was elected to the famous coterie called the "Universal Brotherhood of the Friends of Truth," which comprised artists, scholars, naturalists and others, whose relationship became a potent influence in science. With Forbes he worked at marine zoology, but human anatomy, pathology and morphology formed his chief study. In 1840 he moved to Edinburgh, where in the following year he was appointed conservator of the museum of the College of Surgeons, in succession to William Macgillivray. Much of his reputation rested on his knowledge of the anatomy of tissues. In his lectures in the theatre of the college in 1842-1843 he evidenced the largeness of his observation of cell-life, both physiologically and pathologically, insisting on the importance of the cell as a centre of nutrition, and pointing out that the organism is subdivided into a number of departments. R. Virchow recognized his indebtedness to these discoveries by dedicating his *Cellular Pathologie* to Goodair, as "one of the earliest and most acute observers of cell-life." In 1843 Goodair obtained the post of curator in the university of Edinburgh; the following year he was appointed demonstrator of anatomy, and in 1845 curator of the entire museum. A year later he was elected to the chair of anatomy in the university, and devoted all his energies to anatomical research and teaching.

Human myology was his strong point; no one had laboured harder at the dissecting-table; and he strongly emphasized the necessity of practice as a means of research. He believed that anatomy, physiology and pathology could never be properly advanced without daily consideration and treatment of disease. In 1848 he became a fellow of the Royal College of Surgeons, and in the same year he joined the Highland and Agricultural Society, acting as chairman of the veterinary department, and advising on strictly agricultural matters. In 1847 he delivered a series of systematic lectures on the comparative anatomy of the invertebrata; and, about this period, as member of an aesthetic club, he wrote papers on the natural principles of beauty, the aesthetics of the ugly, of smell, the approbation or disapprobation of sounds, &c. Owing to the failing health of Professor Robert Jameson, Goodair was induced to deliver the course of lectures on natural history during the summer of 1853.

The lectures were long remembered for their brilliancy, but the infinite amount of thought and exertion which they cost broke down the health of the lecturer. Goodair, nevertheless, persevered in his labours, writing in 1855 on organic electricity, in 1856 on morphological subjects, and afterwards on the structure of organized forms. His speculations in the latter domain gave birth to his theory of a triangle as the mathematical figure upon which nature had built up both the organic and inorganic worlds, and he hoped to complete this triangle theory of formation and law as the greatest of his works. In his lectures on the skull and brain he held the doctrine that symmetry of brain had more to do with the higher faculties than bulk or form. He died at Wardie, near Edinburgh, on the 6th of March 1867, in the same cottage in which his friend Edward Forbes died. His anatomical lectures were remarkable for their solid basis of fact; and no one in Britain took so wide a field for survey or marshalled so many facts for anatomical tabulation and synthesis.

See *Anatomical Memoirs of John Goodair, F.R.S.*, edited by W. Turner, with *Memoir* by H. Lonsdale (2 vols., Edinburgh, 1868), in which Goodair's lectures, addresses and writings are epitomized; *Proc. Roy. Soc.* vol. iv. (1868); *Trans. Bot. Soc. Edin.* vol. ix. (1868).

GOODWILL, in the law of property, a term of somewhat vague significance. It has been defined as every advantage which has been acquired in carrying on a business, whether connected with the premises in which the business has been carried on, or with the name of the firm by whom it has been conducted (*Churlton v. Douglas*, 1859, Johns, 174). Goodwill may be either professional or trade. Professional goodwill usually takes the form of the recommendation by a retiring professional man, doctor, solicitor, &c., to his clients of the successor or purchaser coupled generally with an undertaking not to compete with him. Trade goodwill varies with the nature of

the business with which it is connected, but there are two rights which, whatever the nature of the business may be, are invariably associated with it, viz. the right of the purchaser to represent himself as the owner of the business, and the right to restrain competition. For the purposes of the Stamp Act, the goodwill of a business is property, and the proper duty must be paid on the conveyance of such. (See also PARTNERSHIP; PATENTS.)

GOODWIN, JOHN (c. 1594-1665), English Nonconformist divine, was born in Norfolk and educated at Queens' College, Cambridge, where he was elected fellow in 1617. He was vicar of St Stephen's, Coleman Street, London, from 1633 to 1645, when he was ejected by parliament for his attacks on Presbyterianism, especially in his *Θεωρηματα* (1644). He thereupon established an independent congregation, and put his literary gifts at Oliver Cromwell's service. In 1648 he justified the proceedings of the army against the parliament ("Pride's Purge") in a pamphlet *Right and Wrong Met*, and in 1649 defended the proceedings against Charles I. (to whom he had offered spiritual advice) in *T' Smerobical*. At the Restoration this tract, with some that Milton had written to Monk in favour of a republic, was publicly burnt, and Goodwin was ordered into custody, though finally indemnified. He died in 1665. Among his other writings are *Anti-Cavalierisme* (1642), a translation of the *Stragemata Salomonis* of Giacomo Aconcio, the Elizabethan advocate of toleration, tracts against Fifth-Monarchy Men, Cromwell's "Triers" and Baptists, and *Redemption Redeemed, containing a thorough discussion of . . . election, reprobation and the perseverance of the saints* (1651, reprinted 1840). Goodwin's strongly Arminian tendencies brought him into conflict with Robert Baillie, professor of divinity of Glasgow, George Kendall, the Calvinist prebendary of Exeter, and John Owen (q.v.), who replied to *Redemption Redeemed* in *The Doctrine of the Saints' Perseverance*, paying a high tribute to his opponent's learning and controversial skill. Goodwin answered all three in the *Triumviri* (1658). John Wesley in later days held him in much esteem and published an abridged edition of his *Impulatio fidei*, a work on justification that had originally appeared in 1642.

Life by T. Jackson (London, 1839).

GOODWIN, NATHANIEL GARL (1857-), American actor, was born in Boston on the 25th of July 1857. While clerk in a large shop he studied for the stage, and made his first appearance in 1873 in Boston in Stuart Robson's company as the newsboy in Joseph Bradford's *Law*. He made an immediate success by his imitations of popular actors. A hit in the burlesque *Black-eyed Suson* led to his taking part in Rice and Goodwin's *Evangeline* company. It was at this time that he married Eliza Weathersby (d. 1887), an English actress with whom he played in B. E. Woolf's *Hobbies*. It was not until 1889, however, that Nat Goodwin's talent as a comedian of the "legitimate" type began to be recognized. From that time he appeared in a number of plays designed to display his dryly humorous method, such as *Brayder Matthews*, and George H. Jessop's *A Gold Mine*, Henry Guy Carleton's *A Gilded Fool* and *Ambition*, Clyde Fitch's *Nathan Hale*, H. V. Esmond's *When we were Twenty-one*, &c. Till 1903 he was associated in his performances with his third wife, the actress Maxine Elliott (b. 1873), whom he married in 1898; this marriage was dissolved in 1908.

GOODWIN, THOMAS (1600-1680), English Nonconformist divine, was born at Rollesby, Norfolk, on the 5th of October 1600, and was educated at Christ's College, Cambridge, where in 1616 he graduated B.A. In 1619 he removed to Catharine Hall, where in 1620 he was elected fellow. In 1625 he was licensed a preacher of the university; and three years afterwards he became lecturer of Trinity Church, to the vicarage of which he was presented by the king in 1632. Worried by his bishop, who was a zealous adherent of Laud, he resigned all his preferments and left the university in 1634. He lived for some time in London, where in 1638 he married the daughter of an alderman; but in the following year he withdrew to Holland, and for some time was pastor of a small congregation of English merchants and refugees at Arnheim. Returning to London soon after Laud's impeachment by the Long Parliament, he ministered for some years to the

Independent congregation meeting at Paved Alley Church, Lime Street, in the parish of St Dunstan's-in-the-East, and rapidly rose to considerable eminence as a preacher; in 1643 he was chosen a member of the Westminster Assembly, and at once identified himself with the Congregational party, generally referred to in contemporary documents as "the dissenting brethren." He frequently preached by appointment before the Commons, and in January 1650 his talents and learning were rewarded by the House with the presidentship of Magdalen College, Oxford, a post which he held until the Restoration. He rose into high favour with the protector, and was one of his intimate advisers, attending him on his death-bed. He was also a commissioner for the inventory of the Westminster Assembly, 1650, and for the approbation of preachers, 1653, and together with John Owen (*q.v.*) drew up an amended Westminster Confession in 1658. From 1660 until his death on the 23rd of February 1680 he lived in London, and devoted himself exclusively to theological study and to the pastoral charge of the Fetter Lane Independent Church.

The works published by Goodwin during his lifetime consist chiefly of sermons printed by order of the House of Commons; but he was also associated with Philip Nye and others in the preparation of the *Apologetical Narration* (1643). His collected writings, which include expositions of the Epistle to the Ephesians and of the Apocalypse, were published in five folio volumes between 1681 and 1704, and were reprinted in twelve 8vo volumes (Edin., 1861-1866). Characterized by abundant yet one-sided reading, remarkable at once for the depth and for the narrowness of their observation and spiritual experience, often admirably thorough in their workmanship, yet in style intolerably prolix—they fairly exemplify both the merits and the defects of the special school of religious thought to which they belong. Calamy's estimate of Goodwin's qualities may be quoted as both friendly and just. "He was a considerable scholar and an eminent divine, and had a very happy faculty in descanting upon Scripture so as to bring forth surprising remarks, which yet generally tended to illustration." A memoir, derived from his own papers, by his son (Thomas Goodwin, "the younger," 1650?-1716), Independent minister at London and Pinner, and author of the *History of the Reign of Henry V.* is prefixed to the fifth volume of his collected works; as a "patriarch and Atlas of Independency" he is also noticed by Anthony Wood in the *Athenae Oxonienses*. An amusing sketch, from Addison's point of view, of the austere and somewhat fanatical president of Magdalen is preserved in No. 494 of the *Spectator*.

GOODWIN, WILLIAM WATSON (1831-), American classical scholar, was born in Concord, Massachusetts, on the 9th of May 1831. He graduated at Harvard in 1851, studied in Germany, was tutor in Greek at Harvard in 1856-1860, and Eliot professor of Greek there from 1860 until his resignation in 1901. He became an overseer of Harvard in 1903. In 1882-1883 he was the first director of the American School for Classical Studies at Athens. Goodwin edited the *Panegyricus* of Isocrates (1864) and Demosthenes *On The Crown* (1902); and assisted in preparing the seventh edition of Liddell and Scott's *Greek-English Lexicon*. He revised an English version by several writers of *Plutarch's Morals* (5 vols., 1871; 6th ed., 1889), and published the Greek text with literal English version of Aeschylus' *Agamemnon* (1906) from the Harvard production of that play in June 1906. As a teacher he did much to raise the tone of classical reading from that of a mechanical exercise to literary study. But his most important work was his *Syntax of the Moods and Tenses of the Greek Verb* (1860), of which the seventh revised edition appeared in 1877 and another (enlarged) in 1890. This was "based in part on Madvig and Krüger," but, besides making accessible to American students the works of these continental grammarians, it presented original matter, including a "radical innovation in the classification of conditional sentences," notably the "distinction between particular and general suppositions." Goodwin's *Greek Grammar* (elementary edition, 1870; enlarged 1879; revised and enlarged 1892) gradually superseded in most American schools the *Grammar* of Hadley and Allen. Both the *Moods and Tenses* and the *Grammar* in later editions are largely dependent on the theories of Gildersleeve for additions and changes. Goodwin also wrote a few elaborate syntactical studies, to be found in *Harvard Studies in Classical Philology*, the twelfth volume of which was dedicated to him upon the completion of fifty years as an alumnus of Harvard and forty-one years as Eliot professor.

GOODWIN SANDS, a dangerous line of shoals at the entrance to the Strait of Dover from the North Sea, about 6 m. from the Kent coast of England, from which they are separated by the anchorage of the Downs. For this they form a shelter. They are partly exposed at low water, but the sands are shifting, and in spite of lights and bell-buoys the Goodwins are frequently the scene of wrecks, while attempts to erect a lighthouse or beacon have failed. Tradition finds in the Goodwins the remnant of an island called Lomea, which belonged to Earl Godwine in the first half of the 11th century, and was afterwards submerged, when the funds devoted to its protection were diverted to build the church steeple at Tenterden (*q.v.*). Four lightships mark the limits of the sands, and also signal by rockets to the lifeboat stations on the coast when any vessel is in distress on the sands. Perhaps the most terrible catastrophe recorded here was the wreck of thirteen ships of war during a great storm in November 1703.

GOODWOOD, a mansion in the parish of Boxgrove, in the Chichester parliamentary division of Sussex, England, 4 m. N.E. of Chichester. It was built from designs of Sir William Chambers with additions by Wyatt, after the purchase of the property by the first duke of Richmond in 1720. The park is in a hilly district, and is enriched with magnificent trees of many varieties, including some huge cedars. In it is a building containing a Roman slab recording the construction of a temple to Minerva and Neptune at Chichester. There is mention of a British tributary prince named Cogidubnus, who perhaps served also as a Roman official. A reference to early Christianity in Britain has been erroneously read into this inscription. On the racecourse a famous annual meeting, dating from 1802, is held in July. The parish church of SS. Mary and Blaize, Boxgrove, is almost entirely a rich specimen of Early English work.

GOODYEAR, CHARLES (1800-1860), American inventor, was born at New Haven, Connecticut, on the 29th of December 1800, the son of Amasa Goodyear, an inventor (especially of farming implements) and a pioneer in the manufacture of hardware in America. The family removed to Naugatuck, Conn., when Charles was a boy; he worked in his father's button factory and studied at home until 1816, when he apprenticed himself to a firm of hardware merchants in Philadelphia. In 1821 he returned to Connecticut and entered into a partnership with his father at Naugatuck, which continued till 1830, when it was terminated by business reverses. Already he was interested in an attempt to discover a method of treatment by which india-rubber could be made into merchandizable articles that would stand extremes of heat and cold. To the solution of this problem the next ten years of his life were devoted. With ceaseless energy and unwavering faith in the successful outcome of his labours, in the face of repeated failures and hampered by poverty, which several times led him to a debtor's prison, he persevered in his endeavours. For a time he seemed to have succeeded with a treatment (or "cure") of the rubber with *aqua fortis*. In 1836 he secured a contract for the manufacture by this process of mail bags for the U.S. government, but the rubber fabric was useless at high temperatures. In 1837 he met and worked with Nathaniel Hayward (1808-1865), who had been an employee of a rubber factory in Roxbury and had made experiments with sulphur mixed with rubber. Goodyear bought from Hayward the right to use this imperfect process. In 1839, by dropping on a hot stove some india-rubber mixed with sulphur, he discovered accidentally the process for the vulcanization of rubber. Two years more passed before he could find any one who had faith enough in his discovery to invest money in it. At last, in 1844, by which time he had perfected his process, his first patent was granted, and in the subsequent years more than sixty patents were granted to him for the application of his original process to various uses. Numerous infringements had to be fought in the courts, the decisive victory coming in 1852 in the case of *Goodyear v. Day*, in which his rights were defended by Daniel Webster and opposed by Rufus Choate. In 1852 he went to England, where articles made under his patents had been displayed at the International Exhibition of 1851, but he

was unable to establish factories there. In France a company for the manufacture of vulcanized rubber by his process failed, and in December 1855 he was arrested and imprisoned for debt in Paris. Owing to the expense of the litigation in which he was engaged and to bad business management, he profited little from his inventions. He died in New York City on the 1st of July 1860. He wrote an account of his discovery entitled *Gum-Elastic and its Varieties* (2 vols., New Haven, 1855-1855).

See also B. K. Peirce, *Trials of an Inventor, Life and Discoveries of Charles Goodyear* (New York, 1866); James Parton, *Famous Americans of Recent Times* (Boston, 1867); and Herbert L. Terry, *India Rubber and its Manufacture* (New York, 1907).

GOOGE, BARNABE (1540-1594), English poet, son of Robert Googe, recorder of Lincoln, was born on the 17th of June 1540 at Alvingham, Lincolnshire. He studied at Christ's College, Cambridge, and at New College, Oxford, but does not seem to have taken a degree at either university. He afterwards removed to Staple's Inn, and was attached to the household of his kinsman, Sir William Cecil. In 1563 he became a gentleman pensioner to Queen Elizabeth. He was absent in Spain when his poems were sent to the printer by a friend, L. Blundeston. Googe then gave his consent, and they appeared in 1563 as *Eglogs, Epytaphes, and Sonettes*. There is extant a curious correspondence on the subject of his marriage with Mary Darrell, whose father refused Googe's suit on the ground that she was bound by a previous contract. The matter was decided by the intervention of Sir William Cecil with Archbishop Parker, and the marriage took place in 1564 or 1565. Googe was provost-marshal of the court of Connaught, and some twenty letters of his in this capacity are preserved in the record office. He died in February 1594. He was an ardent Protestant, and his poetry is coloured by his religious and political views. In the third "Eglog," for instance, he laments the decay of the old nobility and the rise of a new aristocracy of wealth, and he gives an indignant account of the sufferings of his co-religionists under Mary. The other eclogues deal with the sorrows of earthly love, leading up to a dialogue between Corydon and Cornix, in which the heavenly love is extolled. The volume includes epitaphs on Nicholas Grimald, John Bale and on Thomas Phaer, whose translation of Virgil Googe is uncritical enough to prefer to the versions of Surrey and of Gavin Douglas. A much more charming pastoral than any of those contained in this volume, "Phyllida was a fayer maid" (*Tottel's Miscellany*) has been ascribed to Barnabe Googe. He was one of the earliest English pastoral poets, and the first who was inspired by Spanish romance, being considerably indebted to the *Diana Enamorada* of Montemayor.

His other works include a translation from Marcellus Palingenius (said to be an anagram for Pietro Angelo Manzolli) of a satirical Latin poem, *Zodiacus vitæ* (Venice, 1531?), in twelve books, under the title of *The Zodyake of Life* (1560); *The Popish Kingdome, or reign of Antichrist* (1570), translated from Thomas Kirchmayer or Naogeorgus; *The Spiritual Husbandrie* from the same author, printed with the last; *Four Bookes of Husbandrie* (1577), collected by Conradus Heresbachius; and *The Proverbs of . . . Lopes de Mendosa* (1579).

GOOLE, a market town and port in the Osgoldcross parliamentary division of the West Riding of Yorkshire, England, at the confluence of the Don and the Ouse, 24 m. W. by S. from Hull, served by the North Eastern, Lancashire & Yorkshire, Great Central and Asholme joint railways. Pop. of urban district (1901) 16,576. The town owes its existence to the construction of the Knottingley canal in 1826 by the Aire and Calder Navigation Company, after which, in 1829, Goole was made a bonding port. Previously it had been an obscure hamlet. The port was administratively combined with that of Hull in 1885. It is 47 m. from the North Sea (mouth of the Humber), and a wide system of inland navigation opens from it. There are eight docks supplied with timber ponds, quays, warehouses and other accommodation. The depth of water is 21 or 22 ft. at high water, spring tides. Chief exports are coal, stone, woollen goods and machinery; imports, butter, fruit, indigo, logwood, timber and wool. Industries include the manufacture of alum, sugar, rope and agricultural instruments, and iron-founding. Ship-building is also carried on, and there is a large dry dock and a

patent slip for repairing vessels. Passenger steamship services are worked in connexion with the Lancashire & Yorkshire railway to Amsterdam, Antwerp, Bruges, Copenhagen, Rotterdam and other north European ports. The handsome church of St John the Evangelist, with a lofty tower and spire, dates from 1844.

GOOSE (a common Teut. word, O. Eng. *gōs*, pl. *gēs*, Ger. *Gans*, O. Norse *gds*, from Aryan root, *ghans*, whence Sans. *kaysa*, Lat. *anser* (for *hanser*), Gr. *χῆψ*, &c.), the general English name for a considerable number of birds, belonging to the family *Anatidae* of modern ornithologists, which are mostly larger than ducks and less than swans. Technically the word goose is reserved for the female, the male being called gander (A.-S. *gandra*).

The most important species of goose, and the type of the genus *Anser*, is undoubtedly that which is the origin of the well-known domestic race (see *POULTRY*), the *Anser ferus* or *A. cinereus* of most naturalists, commonly called in English the grey or grey lag¹ goose, a bird of exceedingly wide range in the Old World, apparently breeding where suitable localities are to be found in most European countries from Lapland to Spain and Bulgaria. Eastwards it extends to China, but does not seem to be known in Japan. It is the only species indigenous to the British Islands, and in former days bred abundantly in the English Fen-country, where the young were caught in large numbers and kept in a more or less reclaimed condition with the vast flocks of tame-bred geese that at one time formed so valuable a property to the dwellers in and around the Fens. It is impossible to determine when the wild grey lag goose ceased from breeding in England, but it certainly did so towards the end of the 18th century, for Daniel mentions (*Rural Sports*, iii. 242) his having obtained two broods in one season. In Scotland this goose continues to breed sparingly in several parts of the Highlands and in certain of the Hebrides, the nests being generally placed in long heather, and the eggs seldom exceeding five or six in number. It is most likely the birds reared here that are from time to time obtained in England, for at the present day the grey lag goose, though once so numerous, is, and for many years has been, the rarest species of those that habitually resort to the British Islands. The domestication of this species, as Darwin remarks (*Animals and Plants under Domestication*, i. 287), is of very ancient date, and yet scarcely any other animal that has been tamed for so long a period, and bred so largely in captivity, has varied so little. It has increased greatly in size and fecundity, but almost the only change in plumage is that tame geese commonly lose the browner and darker tints of the wild bird, and are more or less marked with white—being often indeed wholly of that colour.² The most generally recognized breeds of domestic geese are those to which the distinctive names of Emden and Toulouse are applied; but a singular breed, said to have come from Sevastopol, was introduced into western Europe about the year 1856. In this the upper plumage is elongated, curled and spirally twisted, having their shaft transparent, and so thin that it often splits into fine filaments, which, remaining free for an inch or more, often coalesce again;³ while the quills are aborted, so that the birds cannot fly.

¹ The meaning and derivation of this word *lag* had long been a puzzle until Skat suggested (*Ibis*, 1870, p. 301) that it signified late, last, or slow, as in *laggard*, *lojterer*, *lagman*, the last man, *lagteeth*, the posterior molar or "widdom" teeth (as the last to appear), and *lagclock*, a clock that is behind time. Thus the grey lag goose is the grey goose which in England when the name was given was not migratory but lagged behind the other wild species at the season when they betook themselves to their northern breeding-quarters. In connexion with this word, however, must be noticed the curious fact mentioned by Rowley (*Orn. Miscell.*, iii. 213), that the flocks of tame geese in Lincolnshire are urged on by their drivers with the cry of "lag'em, lag'em."

² From the times of the Romans white geese have been held in great estimation, and hence, doubtless, they have been preferred as breeding stock, but the practice of plucking geese alive, continued for so many centuries, has not improbably also helped to perpetuate this variation, for it is well known to many bird-keepers that a white feather is often produced in place of one of the natural colour that has been pulled out.

³ In some English counties, especially Norfolk and Lincoln, it was no uncommon thing formerly for a man to keep a stock of a thousand geese, each of which might be reckoned to rear on an

The other British species of typical geese are the bean-geese (*A. segetum*), the pink-footed (*A. brachyrhynchus*) and the white-fronted (*A. albifrons*). On the continent of Europe, but not yet recognized as occurring in Britain, is a small form of the last (*A. erythropus*) which is known to breed in Lapland. All these, for the sake of discrimination, may be divided into two groups—(1) those having the "nail" at the tip of the bill white, or of a very pale flesh colour, and (2) those in which this "nail" is black. To the former belong the grey lag goose, as well as *A. albifrons* and *A. erythropus*, and to the latter the other two. *A. albifrons* and *A. erythropus*, which differ little but in size,—the last being not much bigger than a mallard (*Anas boschas*),—may be readily distinguished from the grey lag goose by their bright orange legs and their mouse-coloured upper wing-coverts, to say nothing of their very conspicuous white face and the broad black bars which cross the belly, though the last two characters are occasionally observable to some extent in the grey lag goose, which has the bill and legs flesh-coloured, and the upper wing-coverts of a bluish-grey. Of the second group, with the black "nail," *A. segetum* has the bill long, black at the base and orange in the middle; the feet are also orange, and the upper wing-coverts mouse-coloured, as in *A. albifrons* and *A. erythropus*, while *A. brachyrhynchus* has the bill short, bright pink in the middle, and the feet also pink, the upper wing-coverts being nearly of the same bluish-grey as in the grey lag goose. Eastern Asia possesses in *A. grandis* a third species of this group, which chiefly differs from *A. segetum* in its larger size. In North America there is only one species of typical goose, and that belongs to the white-"nailed" group. It very nearly resembles *A. albifrons*, but is larger, and has been described as distinct under the name of *A. gambeli*. Central Asia and India possess in the bar-headed goose (*A. indicus*) a bird easily distinguished from any of the foregoing by the character implied by its English name; but it is certainly somewhat abnormal, and, indeed, under the name of *Eulabia*, has been separated from the genus *Anser*, which has no other member indigenous to the Indian Region, nor any at all to the Ethiopian, Australian or Neotropical Regions.

America possesses by far the greatest wealth of Anserine forms. Beside others, presently to be mentioned, its northern portions are the home of all the species of snow-geese belonging to the genus *Chen*. The first of these is *C. hyperboreus*, the snow-geese proper, a bird of large size, and when adult of a pure white, except the primaries, which are black. This has long been deemed a visitor to the Old World, and sometimes in considerable numbers, but the later discovery of a smaller form, *C. albatas*, scarcely differing except in size, throws some doubt on the older records, especially since examples which have been obtained in the British Islands undoubtedly belong to this lesser bird, and it would be satisfactory to have the occurrence in the Old World of the true *C. hyperboreus* placed on a surer footing. So nearly allied to the species last named as to have been often confounded with it, is the blue-winged goose, *C. coarulescens*, which is said never to attain a snowy plumage. Then we have a very small species, long ago described as distinct by Samuel Hearne, the Arctic traveller, but until 1861 discredited by ornithologists. Its distinctness has now been fully recognized, and it has received, somewhat unjustly, the name of *C. rossii*. Its face is adorned with numerous papillae, whence it has been removed by Elliot to a separate genus, *Exanthemops*, and for the same reason it has long been known to the European residents in the fur countries as the "horned wavy"—the last word being a rendering of a native name, *Wawa*, which signifies goose. Finally, average seven goings. The flocks were regularly taken to pasture and water, just as sheep are, and the man who tended them was called the gooseherd, corrupted into goserd. The birds were plucked five times in the year, and in autumn the flocks were driven to London or other large markets. They travelled at the rate of about a mile an hour, and would get over nearly 10 m. in the day. For further particulars the reader may be referred to Pennant's *British Zoology*; Montagu's *Ornithological Dictionary*; Latham's *General History of Birds*; and Rowley's *Ornithological Miscellany* (iii. 206-215), where some account also may be found of the goose-fattening at Strasburg.

there appears to belong to this section, though it has been frequently referred to another (*Chloephaga*), and has also been made the type of a distinct genus (*Philacte*), the beautiful emperor goose, *P. canagica*, which is almost peculiar to the Aleutian Islands, though straying to the continent in winter, and may be recognized by the white edging of its remiges.

The southern portions of the New World are inhabited by about half a dozen species of geese not nearly akin to the foregoing, and separated as the genus *Chloephaga*. The most noticeable of them are the rock or kelp goose, *C. antarctica*, and the upland goose, *C. magellanica*. In both of these the sexes are totally unlike in colour, but in others a greater similarity obtains.¹ Formerly erroneously associated with the birds of this group comes one which belongs to the northern hemisphere, and is common to the Old World as well as the New. It contains the geese which have received the common names of bernacles or brents,² and the scientific appellations of *Bernicla* and *Branta*—for the use of either of which much may be said by nomenclaturists. All the species of this section are distinguished by their general dark sooty colour, relieved in some by white of greater or less purity, and by way of distinction from the members of the genus *Anser*, which are known as grey geese, are frequently called by fowlers black geese. Of these, the best known both in Europe and North America is the brent-geese—the *Anas bernicla* of Linnaeus, and the *B. torquata* of many modern writers—a truly marine bird, seldom (in Europe at least) quitting salt-water, and coming southwards in vast flocks towards autumn, frequenting bays and estuaries on the British coasts, where it lives chiefly on sea-grass (*Zostera maritima*). It is known to breed in Spitsbergen and in Greenland. A form which is by some ornithologists deemed a good species, and called by them *B. nigricans*, occurs chiefly on the Pacific coast of North America. In it the black of the neck, which in the common brent terminates just above the breast, extends over most of the lower parts. The true bernacle-geese,³ the *B. leucopsis* of most authors, is but a casual visitor to North America, but is said to breed in Iceland, and occasionally in Norway. Its usual *incunabula*, however, still form one of the puzzles of the ornithologist, and the difficulty is not lessened by the fact that it will breed freely in semi-captivity, while the brent-geese will not. From the latter the bernacle-geese is easily distinguished by its larger size and white cheeks. Hutchins's goose (*B. Hutchinsii*) seems to be its true representative in the New World. In this the face is dark, but a white crescentic or triangular patch extends from the throat on either side upwards behind the eye. Almost exactly similar in coloration to the last, but greatly superior in size, and possessing 18 rectrices, while all the foregoing have but 16, is the common wild goose of America, *B. canadensis*, which, for more than two centuries has been introduced into Europe, where it propagates so freely that it has been included by nearly all the ornithologists of this quarter of the globe as a member of its fauna. An allied form, by some deemed a species, is *B. leucopareia*, which ranges over the western part of North America, and, though having 18 rectrices, is distinguished by a white collar round the lower part of the neck. The most diverse species of this group of geese are the beautiful *B. ruficollis*, a native of north-eastern Asia, which occasionally strays to western Europe, and has been obtained more than once in Britain, and that which is peculiar to the Hawaiian archipelago, *B. sandvicensis*.

The largest living goose is that called the Chinese, Guinea or swan-geese, *Cygnopsis cygnoides*, and this is the stock whence the domestic geese of several eastern countries have sprung. It may often be seen in English parks, and it is found to cross readily with the common tame goose, the offspring being fertile,

¹ See Slater and Salvin, *Proc. Zool. Society* (1876), pp. 361-369.

² The etymology of these two words is exceedingly obscure. The ordinary spelling bernacle seems to be wrong, if we may judge from the analogy of the French *Bernache*. In both words the *s* should be sounded as *a*.

³ The old fable, perhaps still believed by the uneducated in some parts of the world, was that bernacle-geese were produced from the barnacles (*Lepadidae*) that grow on timber exposed to salt-water.

and Blyth has said that these crosses are very abundant in India. The true home of the species is in eastern Siberia or Mongolia. It is distinguished by its long smooth neck, marked dorsally by a chocolate streak. The reclaimed form is usually distinguished by the knob at the base of the bill, but the evidence of many observers shows that this is not found in the wild race. Of this bird there is a perfectly white breed.

We have next to mention a very curious form, *Cereopsis novae-hollandiae*, which is peculiar to Australia, and is a more terrestrial type of goose than any other now existing. Its short, decurved bill and green cere give it a very peculiar expression, and its almost uniform grey plumage, bearing rounded black spots, is also remarkable. It bears captivity well, breeding in confinement, but is now seldom seen. It appears to have been formerly very abundant in many parts of Australia, from which it has of late been exterminated. Some of its peculiarities seem to have been still more exaggerated in a bird that is wholly extinct, the *Cnemionis calcitrans* of New Zealand, the remains of which were described in full by Sir R. Owen in 1873 (*Trans. Zool. Society*, ix. 253). Among the first portions of this singular bird that were found were the *tibiae*, presenting an extraordinary development of the *patella*, which, united with the shank-bone, gave rise to the generic name applied. For some time the affinity of the owner of this wonderful structure was in doubt, but all hesitation was dispelled by the discovery of a nearly perfect skeleton, now in the British Museum, which proved the bird to be a goose, of great size, and unable, from the shortness of its wings, to fly. In correlation with this loss of power may also be noted the dwindling of the keel of the sternum. Generally, however, its osteological characters point to an affinity to *Cereopsis*, as was noticed by Dr Hector (*Trans. New Zeal. Institute*, vi. 76-84), who first determined its Anserine character.

Birds of the genera *Chenalopez* (the Egyptian and Orinoco geese), *Plectropterus*, *Sarcidornis*, *Chloamydochen* and some others, are commonly called geese. It seems uncertain whether they should be grouped with the *Anserinae*. The males of all, like those of the above-mentioned genus *Chloëphaga*, appear to have that curious enlargement at the junction of the bronchial tubes and the trachea which is so characteristic of the ducks or *Anatinae*. (A. N.)

GOOSE (GAME OF), an ancient French game, said to have been derived from the Greeks, very popular at the close of the middle ages. It was played on a piece of card-board upon which was drawn a fantastic scroll, called the *jardin de l'Oie* (goose-garden), divided into 63 spaces marked with certain emblems, such as dice, an inn, a bridge, a labyrinth, &c. The emblem inscribed on 1 and 63, as well as every ninth space between, was a goose. The object was to land one's counter in number 63, the number of spaces moved through being determined by throwing two dice. The counter was advanced or retired according to the space on which it was placed. For instance if it rested on the *inn* it must remain there until each adversary, of which there might be several, had played twice; if it rested on the *death's head* the player must begin over again; if it went beyond 63 it must be retired a certain number of spaces. The game was usually played for a stake, and special fines were exacted for resting on certain spaces. At the end of the 18th century a variation of the game was called the *jeu de la Révolution Française*.

GOOSEBERRY, *Ribes Grossularia*, a well-known fruit-bush of northern and central Europe, placed in the same genus of the natural order to which it gives name (Ribesiaceae) as the closely allied currants. It forms a distinct section *Grossularia*, the members of which differ from the true currants chiefly in their spinous stems, and in their flowers growing on short foot-stalks, solitary, or two or three together, instead of in racemes.

The wild gooseberry is a small, straggling bush, nearly resembling the cultivated plant,—the branches being thickly set with sharp spines, standing out singly or in diverging tufts of two or three from the bases of the short spurs or lateral leaf shoots, on which the bell-shaped flowers are produced, singly or in pairs, from the groups of rounded, deeply-crenated 3- or 5-lobed leaves. The fruit is smaller than in the garden kinds,

but is often of good flavour; it is generally hairy, but in one variety smooth, constituting the *R. Uva-crispa* of writers; the colour is usually green, but plants are occasionally met with having deep purple berries. The gooseberry is indigenous in Europe and western Asia, growing naturally in alpine thickets and rocky woods in the lower country, from France eastward, perhaps as far as the Himalaya. In Britain it is often found in copses and hedgerows and about old ruins, but has been so long a plant of cultivation that it is difficult to decide upon its claim to a place in the native flora of the island. Common as it is now on some of the lower slopes of the Alps of Piedmont and Savoy, it is uncertain whether the Romans were acquainted with the gooseberry, though it may possibly be alluded to in a vague passage of Pliny: the hot summers of Italy, in ancient times as at present, would be unfavourable to its cultivation. Abundant in Germany and France, it does not appear to have been much grown there in the middle ages, though the wild fruit was held in some esteem medicinally for the cooling properties of its acid juice in fevers; while the old English name, *Fea-berry*, still surviving in some provincial dialects, indicates that it was similarly valued in Britain, where it was planted in gardens at a comparatively early period. William Turner describes the gooseberry in his *Herball*, written about the middle of the 16th century, and a few years later it is mentioned in one of Thomas Tusser's quaint rhymes as an ordinary object of garden culture. Improved varieties were probably first raised by the skilful gardeners of Holland, whose name for the fruit, *Kruisbesse*, may have been easily corrupted into the present English vernacular word.¹ Towards the end of the 18th century the gooseberry became a favourite object of cottage-horticulture, especially in Lancashire, where the working cotton-spinners have raised numerous varieties from seed, their efforts having been chiefly directed to increasing the size of the fruit. Of the many hundred sorts enumerated in recent horticultural works, few perhaps equal in flavour some of the older denizens of the fruit-garden, such as the "old rough red" and "hairy amber." The climate of the British Islands seems peculiarly adapted to bring the gooseberry to perfection, and it may be grown successfully even in the most northern parts of Scotland; indeed, the flavour of the fruit is said to improve with increasing latitude. In Norway even, the bush flourishes in gardens on the west coast nearly up to the Arctic circle, and it is found wild as far north as 63°. The dry summers of the French and German plains are less suited to it, though it is grown in some hilly districts with tolerable success. The gooseberry in the south of England will grow well in cool situations, and may be sometimes seen in gardens near London flourishing under the partial shade of apple trees; but in the north it needs full exposure to the sun to bring the fruit to perfection. It will succeed in almost any soil, but prefers a rich loam or black alluvium, and, though naturally a plant of rather dry places, will do well in moist land, if drained.

The varieties are most easily propagated by cuttings planted in the autumn, which root rapidly, and in a few years form good fruit-bearing bushes. Much difference of opinion prevails regarding the mode of pruning this valuable shrub; it is probable that in different situations it may require varying treatment. The fruit being borne on the lateral spurs, and on the shoots of the last year, it is the usual practice to shorten the side branches in the winter, before the buds begin to expand; some reduce the longer leading shoots at the same time, while others prefer to nip off the ends of these in the summer while they are still

¹ The first part of the word has been usually treated as an etymological corruption either of this Dutch word or the allied Ger. *Krausbeere*, or of the earlier forms of the Fr. *groseille*. The *New English Dictionary* takes the obvious derivation from "goose" and "berry" as probable: "the grounds on which plants and fruits have received names associating them with animals are so commonly inexplicable, that the want of appropriateness in the meaning affords no sufficient ground for assuming that the word is an etymologizing corruption." Skeat (*Etym. Dict.*, 1898) connects the French, Dutch and German words, and finds the origin in the M.H.G. *gras*, curling, crisped, applied here to the hairs on the fruit. The French word was latinized as *grossularia* and confused with *grosus*, thick, fat.

succulent. When large fruit is desired, plenty of manure should be supplied to the roots, and the greater portion of the berries picked off while still small. If standards are desired, the gooseberry may be with advantage grafted or budded on stocks of some other species of *Ribes*, *R. aureum*, the ornamental golden currant of the flower garden, answering well for the purpose. The giant gooseberries of the Lancashire "fanciers" are obtained by the careful culture of varieties specially raised with this object, the growth being encouraged by abundant manuring, and the removal of all but a very few berries from each plant. Single gooseberries of nearly 2 oz. in weight have been occasionally exhibited; but the produce of such fanciful horticulture is generally insipid. The bushes at times suffer much from the ravages of the caterpillars of the gooseberry or magpie moth, *Abraxas grossulariata*, which often strip the branches of leaves in the early summer, if not destroyed before the mischief is accomplished. The most effectual way of getting rid of this pretty but destructive insect is to look over each bush carefully, and pick off the larvae by hand; when larger they may be shaken off by striking the branches, but by that time the harm is generally done—the eggs are laid on the leaves of the previous season. Equally annoying in some years is the smaller larva of the V-moth, *Halijs vanaria*, which often appears in great numbers, and is not so readily removed. The gooseberry is sometimes attacked by the grub of the gooseberry sawfly, *Nematus ribesii*, of which several broods appear in the course of the spring and summer, and are very destructive. The grubs bury themselves in the ground to pass into the pupal state; the first brood of flies, hatched just as the bushes are coming into leaf in the spring, lay their eggs on the lower side of the leaves, where the small greenish larvae soon after emerge. For the destruction of the first broods it has been recommended to syringe the bushes with tar-water; perhaps a very weak solution of carbolic acid might prove more effective. The powdered root of white hellebore is said to destroy both this grub and the caterpillars of the gooseberry moth and V-moth; infusion of foxglove, and tobacco-water, are likewise tried by some growers. If the fallen leaves are carefully removed from the ground in the autumn and burnt, and the surface of the soil turned over with the fork or spade, most eggs and chrysalids will be destroyed.

The gooseberry was introduced into the United States by the early settlers, and in some parts of New England large quantities of the green fruit are produced and sold for culinary use in the towns; but the excessive heat of the American summer is not adapted for the healthy maturation of the berries, especially of the English varieties. Perhaps if some of these, or those raised in the country, could be crossed with one of the indigenous species, kinds might be obtained better fitted for American conditions of culture, although the gooseberry does not readily hybridize. The attacks of the American gooseberry mildew

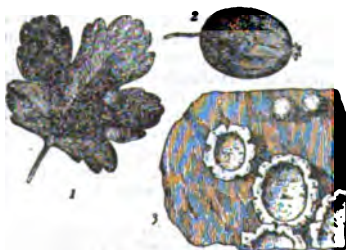

FIG. 1.—A Fungal Disease of the Gooseberry (*Aecidium Grossulariae*.)

1, Leaf showing patches of cluster-cups on surface; 2, Fruit, showing same; 3, Cluster-cups much enlarged.

spores contained in these cups will not reproduce the disease on the gooseberry, but infect species of *Carex* (sedges) on which they produce a fungus of a totally different appearance. This

stage in the life-history of the parasite gives its name to the whole fungus, so that it is now known as *Puccinia Pringheimiana*.

Both *uredospores* and *teleutospores* are formed on the sedge, and the latter live through the winter and produce the disease on the gooseberry in the succeeding year. In cases where the disease proves troublesome the sedges in the neighbourhood should be destroyed.

A much more prevalent disease is that caused by *Microsphaeria Grossulariae*. This is a mildew growing on the surface of the leaf and sending suckers into the epidermis. The white mycelium gives the leaves of the plant the appearance of having been whitewashed

(fig. 2). Numerous fructifications or *perithecia*; the end of one of its numerous appendages is shown more highly magnified in 3, 4, 5, spore sacs (*asci*) from the *perithecia*, containing spores. Immediately, and later small blackish fruits (*perithecia*) are produced that pass uninjured through the winter liberating the spores they contain in the spring, which infect the young developing leaves of the bush. In bad cases the plants are greatly injured but frequently little harm is done. Attacked plants should be sprayed with potassium sulphide.

An allied fungus, *Sphaerotheca mors-uvae*, of much greater virulence, has recently appeared in England, causing the disease known as "American gooseberry mildew" (fig. 3A). In the main the mode of attack is similar to that of the last-mentioned, but not only are the leaves attacked, but the tips of the young shoots and the fruits become covered by the cobweb-like mycelium, the attack frequently resulting in the death of the shoots and the destruction of the fruits. After a

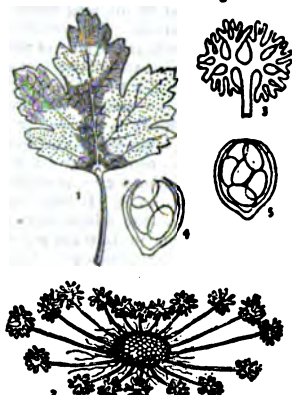

From George Manser's *Text-Book of Plant Diseases*, by permission of Duckworth & Co. FIG. 2.—Gooseberry Mildew (*Microsphaeria Grossulariae*.)



From the *Journal of the Board of Agriculture* (May 1907), by permission of the Dept. of Agriculture and Technical Instruction for Ireland.

FIG. 3A.—American Gooseberry Mildew (*Sphaerotheca mors-uvae*). Plant with leaves and fruit attacked by the fungus.

time the mycelium becomes rusty brown and produces the winter form of the fungus. Through the winter the shoots are covered thickly with the brown mycelium and in the spring the spores contained in the perithecia germinate and start the infection anew, as in the case of the European mildew. This fungus has recently been the subject of legislation, and when it appears in a district strong repressive measures are called for. In bad cases the attacked bushes should be destroyed, while in milder attacks frequent spraying with potassium sulphide and the pruning off and immediate destruction by fire of all the young shoots showing the mildew should be resorted to.

The gooseberry, when ripe, yields a fine wine by the fermentation of the juice with water and sugar, the resulting sparkling liquor retaining much of the flavour of the fruit. By similarly treating the juice of the green fruit, picked just before it ripens, an effervescent wine is produced, nearly resembling some kinds of champagne, and, when skillfully prepared, far superior to

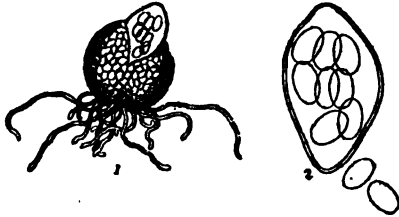

FIG. 32.—1, Fructification (*perithecium*) bursting, ascus containing spores protruding; 2, Ascus with spores more highly magnified.

much of the liquor sold under that name. Brandy has been made from ripe gooseberries by distillation; by exposing the juice with sugar to the acetous fermentation a good vinegar may be obtained. The gooseberry, when perfectly ripe, contains a large quantity of sugar, most abundant in the red and amber varieties; in the former it amounts to from 6 to upwards of 3%. The acidity of the fruit is chiefly due to malic acid.

Several other species of the sub-genus produce edible fruit, though none have as yet been brought under economic culture. Among them may be noticed *R. oxycanthoides* and *R. cynosbati*, abundant in Canada and the northern parts of the United States, and *R. gracile*, common along the Alleghany range. The group is a widely distributed one in the north temperate zone,—one species is found in Europe extending to the Caucasus and North Africa (Atlas Mountains), five occur in Asia and nineteen in North America, the range extending southwards to Mexico and Guatemala.

GOOTY, a town and hill fortress in southern India, in the Anantapur district of Madras, 48 m. E. of Bellary. Pop. (1901) 9682. The town is surrounded by a circle of rocky hills, connected by a wall. On the highest of these stands the citadel, 2100 ft. above sea-level and 1000 ft. above the surrounding country. Here was the stronghold of Morari Rao Ghorpade, a famous Marhatta warrior and ally of the English, who was ultimately starved into surrender by Hayder Ali in 1775.

GOPHER (*Testudo polyphemus*), the only living representative on the North American continent of the genus *Testudo* of the family *Testudinidae* or land tortoises; it occurs in the south-eastern parts of the United States, from Florida in the south to the river Savannah in the north. Its carapace, which is oblong and remarkably compressed, measures from 12-18 in. in extreme length, the shields which cover it being grooved, and of a yellow-brown colour. It is characterized by the shape of the front lobe of the plastron, which is bent upwards and extends beyond the carapace. The gopher abounds chiefly in the forests, but occasionally visits the open plains, where it does great damage, especially to the potato crops, on which it feeds. It is a nocturnal animal, remaining concealed by day in its deep burrow, and coming forth at night to feed. The eggs, five in number, almost

round and $1\frac{1}{2}$ in. in diameter, are laid in a separate cavity near the entrance. The flesh of the gopher or mangofa, as it is also called, is considered excellent eating.

The name "gopher" is more commonly applied to certain small rodent mammals, particularly the pocket-gopher.

GÖPPINGEN, a town of Germany, in the kingdom of Württemberg, on the right bank of the Fils, 22 m. E.S.E. of Stuttgart on the railway to Friedrichshafen. Pop. (1905) 20,870. It possesses a castle built, partly with stones from the ruined castle of Hohenstaufen, by Duke Christopher of Württemberg in the 16th century and now used as public offices, two Evangelical churches, a Roman Catholic church, a synagogue, a classical school, and a modern school. The manufactures are considerable and include linen and woollen cloth, leather, glue, paper and toys. There are machine shops and tanneries in the town. Three m. N. of the town are the ruins of the castle of Hohenstaufen. Göppingen originally belonged to the house of Hohenstaufen, and in 1270 came into possession of the counts of Württemberg. It was surrounded by walls in 1129, and was almost entirely rebuilt after a fire in 1782.

See Pfeiffer, *Beschreibung und Geschichte der Stadt Göppingen* (1885).

GORAKHPUR, a city, district and division of the United Provinces of British India. The city is situated on the left bank of the river Rapti. Pop. (1901) 64,148. It is believed to have been founded about 1400 A.D. It is the civil headquarters of the district and was formerly a military cantonment. It consists of a number of adjacent village sites, sometimes separated by cultivated land, and most of the inhabitants are agriculturists.

The DISTRICT OF GORAKHPUR has an area of 4535 sq. m. It lies immediately south of the lower Himalayan slopes, but itself forms a portion of the great alluvial plain. Only a few sandhills break the monotony of its level surface, which is, however, intersected by numerous rivers studded with lakes and marshes. In the north and centre dense forests abound, and the whole country has a verdant appearance. The principal rivers are the Rapti, the Gogra, the Gandak and Little Gandak, the Kuana, the Rohin, the Ami and the Gunghi. Tigers are found in the north, and many other wild animals abound throughout the district. The lakes are well stocked with fish. The district is not subject to very intense heat, from which it is secured by its vicinity to the hills and the moisture of its soil. Dust-storms are rare, and cool breezes from the north, rushing down the gorges of the Himalayas, succeed each short interval of warm weather. The climate is, however, relaxing. The southern and eastern portions are as healthy as most parts of the province, but the *terai* and forest-tracts are still subject to malaria.

Gautama Buddha, the founder of the religion bearing his name, was born, and died near the boundaries of the district. From the beginning of the 6th century the country was the scene of a continuous struggle between the Bhars and their Aryan antagonists, the Rathors. About 900 the Dombatars or military Brahmans appeared, and expelled the Rathors from the town of Gorakhpur, but they also were soon driven back by other invaders. During the 15th and 16th centuries, after the district had been desolated by incessant war, the descendants of the various conquerors held parts of the territory, and each seems to have lived quite isolated, as no bridges or roads attest any intercourse with each other. Towards the end of the 16th century Mussulmans occupied Gorakhpur town, but they interfered very little with the district, and allowed it to be controlled by the native rajas. In the middle of the 18th century a formidable foe, the Banjaras from the west, so weakened the power of the rajas that they could not resist the fiscal exactions of the Oudh officials, who plundered the country to a great extent. The district formed part of the territory ceded by Oudh to the British under the treaty of 1801. During the Mutiny it was lost for a short time, but under the friendly Gurkhas the rebels were driven out. The population in 1901 was 2,957,074, showing a decrease of 3% in the decade. The district is traversed by the main line and several branches of the Bengal & North-Western railway, and the Gandak, the Gogra and the Rapti are navigable.

The DIVISION has an area of 9534 sq. m. The population in 1901 was 6,333,012, giving an average density of 664 persons per sq. m., being more than one to every acre, and the highest for any large tract in India.

GORAL, the native name of a small Himalayan rough-haired and cylindrical-horned ruminant classed in the same group as the chamois. Scientifically this animal is known as *Urotragus* (or *Cemas*) *goral*; and the native name is now employed as the designation of all the other members of the same genus. In addition to certain peculiarities in the form of the skull, gorals are chiefly distinguished from serows (*q.v.*) by not possessing a gland below the eye, nor a corresponding depression in the skull. Several species are known, ranging from the Himalaya to Burma, Tibet and North China. Of these, the two Himalayan gorals (*U. goral* and *U. bedfordi*) are usually found in small parties, but less commonly in pairs. They generally frequent grassy hills, or rocky ground clothed with forest; in fine weather feeding only in the mornings and evenings, but when the sky is cloudy grazing throughout the day.

GORAMY, or **GOURAMY** (*Osphromenus olfax*), reputed to be one of the best-flavoured freshwater fishes in the East Indian archipelago. Its original home is Java, Sumatra, Borneo and several other East Indian islands, but thence it has been transported to and acclimatized in Penang, Malacca, Mauritius and even Cayenne. Being an almost omnivorous fish and tenacious of life,

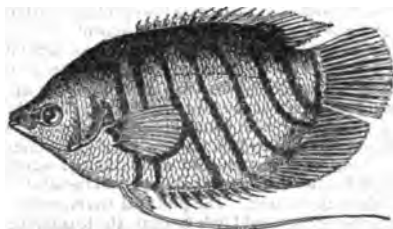

Goramy.

it seems to recommend itself particularly for acclimatization in other tropical countries; and specimens kept in captivity become as tame as carps. It attains the size of a large turbot. Its shape is flat and short, the body covered with large scales; the dorsal and anal fins are provided with numerous spines, and the ventral fins produced into long filaments. Like *Anabas*, the climbing perch, it possesses a suprabranchial accessory respiratory organ.

GÖRBERSDORF, a village and climatic health resort of Germany, in the Prussian province of Silesia, romantically situated in a deep and well-wooded valley of the Waldenburg range, 1900 ft. above the sea, 60 m. S.W. of Breslau by the railway to Friedland and 3 m. from the Austrian frontier. Pop. 700. It has four large sanatoria for consumptives, the earliest of which was founded in 1854 by Hermann Brehmer (1826-1889).

GORBODUC, a mythical king of Britain. He gave his kingdom away during his lifetime to his two sons, Ferrex and Porrex. The two quarrelled and the younger stabbed the elder. Their mother, loving the latter most, avenged his death by murdering her son, and the people, horrified at her act, revolted and murdered both her and King Gorboduc. This legend was the subject of the earliest regular English tragedy which in 1561 was played before Queen Elizabeth in the Inner Temple hall. It was written by Thomas Sackville, Lord Buckhurst and Thomas Norton in collaboration. Under the title of *Gorboduc* it was published first very corruptly in 1565, and in better form as *The Tragedy of Ferrex and Porrex* in 1570.

GORCHAKOV, or **GORTCHAKOFF**, a noble Russian family, descended from Michael Vsevolodovich, prince of Chernigov, who, in 1246, was assassinated by the Mongols. **PRINCE ANDREY IVANOVICH** (1768-1855), general in the Russian army, took a conspicuous part in the final campaigns against Napoleon. **ALEXANDER IVANOVICH** (1769-1825) served with distinction

under his relative Suvarov in the Turkish Wars, and took part as a general officer in the Italian and Swiss operations of 1799, and in the war against Napoleon in Poland in 1806-1807 (battle of Heilsberg). **PETR DMITRIEVICH** (1790-1868) served under Kamenski and Kutusov in the campaign against Turkey, and afterwards against France in 1813-1814. In 1820 he suppressed an insurrection in the Caucasus, for which service he was raised to the rank of major-general. In 1828-1829 he fought under Wittgenstein against the Turks, won an action at Aidos, and signed the treaty of peace at Adrianople. In 1839 he was made governor of Eastern Siberia, and in 1851 retired into private life. When the Crimean War broke out he offered his services to the emperor Nicholas, by whom he was appointed general of the VI. army corps in the Crimea. He commanded the corps in the battles of Alma and Inkerman. He retired in 1855 and died at Moscow, on the 18th of March 1868.

PRINCE MIKHAIL DMITRIEVICH (1795-1861), brother of the last named, entered the Russian army in 1807 and took part in the campaigns against Persia in 1810, and in 1812-1815 against France. During the Russo-Turkish War of 1828-1829 he was present at the sieges of Silistria and Shumla. After being appointed, in 1830, a general officer, he was present in the campaign in Poland, and was wounded at the battle of Grochow, on the 25th of February 1831. He also distinguished himself at the battle of Ostrolenka and at the taking of Warsaw. For these services he was promoted to the rank of lieutenant-general. In 1846 he was nominated military governor of Warsaw. In 1849 he commanded the Russian artillery in the war against the Hungarians, and in 1852 he visited London as a representative of the Russian army at the funeral of the duke of Wellington. At this time he was chief of the staff of the Russian army and adjutant-general to the tsar. Upon Russia declaring war against Turkey in 1853, he was appointed commander-in-chief of the troops which occupied Moldavia and Wallachia. In 1854 he crossed the Danube and besieged Silistria, but was superseded in April by Prince Paskevich, who, however, resigned on the 8th of June, when Gorchakov resumed the command. In July the siege of Silistria was raised, and the Russian armies recrossed the Danube; in August they withdrew to Russia. In 1855 he was appointed commander-in-chief of the Russian forces in the Crimea in place of Prince Menshikov. Gorchakov's defence of Sevastopol, and final retreat to the northern part of the town, which he continued to defend till peace was signed in Paris, were conducted with skill and energy. In 1856 he was appointed governor-general of Poland in succession to Prince Paskevich. He died at Warsaw on the 30th of May 1861, and was buried, in accordance with his own wish, at Sevastopol.

PRINCE GORCHAKOV, **ALEXANDER MIKHAILOVICH** (1798-1883), Russian statesman, cousin of Princes Petr and Mikhail Gorchakov, was born on the 16th of July 1798, and was educated at the lyceum of Tsarkoye Selo, where he had the poet Pushkin as a school-fellow. He became a good classical scholar, and learnt to speak and write in French with facility and elegance. Pushkin in one of his poems described young Gorchakov as "Fortune's favoured son," and predicted his success. On leaving the lyceum Gorchakov entered the foreign office under Count Nesselrode. His first diplomatic work of importance was the negotiation of a marriage between the grand duchess Olga and the crown prince Charles of Württemberg. He remained at Stuttgart for some years as Russian minister and confidential adviser of the crown princess. He foretold the outbreak of the revolutionary spirit in Germany and Austria, and was credited with counselling the abdication of Ferdinand in favour of Francis Joseph. When the German confederation was re-established in 1850 in place of the parliament of Frankfort, Gorchakov was appointed Russian minister to the diet. It was here that he first met Prince Bismarck, with whom he formed a friendship which was afterwards renewed at St Petersburg. The emperor Nicholas found that his ambassador at Vienna, Baron Meyendorff, was not a sympathetic instrument for carrying out his schemes in the East. He therefore transferred Gorchakov to Vienna, where the latter remained through the critical period of the Crimean War.

Gorchakov perceived that Russian designs against Turkey, supported by Great Britain and France, were impracticable, and he counselled Russia to make no more useless sacrifices, but to accept the bases of a pacification. At the same time, although he attended the Paris conference of 1856, he purposely abstained from affixing his signature to the treaty of peace after that of Count Orlov, Russia's chief representative. For the time, however, he made a virtue of necessity, and Alexander II., recognizing the wisdom and courage which Gorchakov had exhibited, appointed him minister of foreign affairs in place of Count Nesselrode. Not long after his accession to office Gorchakov issued a circular to the foreign powers, in which he announced that Russia proposed, for internal reasons, to keep herself as free as possible from complications abroad, and he added the now historic phrase, "*La Russie ne boude pas; elle se recueille.*" During the Polish insurrection Gorchakov rebuffed the suggestions of Great Britain, Austria and France for assuaging the severities employed in quelling it, and he was especially acrid in his replies to Earl Russell's despatches. In July 1863 Gorchakov was appointed chancellor of the Russian empire expressly in reward for his bold diplomatic attitude towards an indignant Europe. The appointment was hailed with enthusiasm in Russia, and at that juncture Prince Chancellor Gorchakov was unquestionably the most powerful minister in Europe.

An *approchement* now began between the courts of Russia and Prussia; and in 1863 Gorchakov smoothed the way for the occupation of Holstein by the Federal troops. This seemed equally favourable to Austria and Prussia, but it was the latter power which gained all the substantial advantages; and when the conflict arose between Austria and Prussia in 1866, Russia remained neutral and permitted Prussia to reap the fruits and establish her supremacy in Germany. When the Franco-German War of 1870-71 broke out Russia answered for the neutrality of Austria. An attempt was made to form an anti-Prussian coalition, but it failed in consequence of the cordial understanding between the German and Russian chancellors. In return for Russia's service in preventing the aid of Austria from being given to France, Gorchakov looked to Bismarck for diplomatic support in the Eastern Question, and he received an instalment of the expected support when he successfully denounced the Black Sea clauses of the treaty of Paris. This was justly regarded by him as an important service to his country and one of the triumphs of his career, and he hoped to obtain further successes with the assistance of Germany, but the cordial relations between the cabinets of St Petersburg and Berlin did not subsist much longer. In 1875 Bismarck was suspected of a design of again attacking France, and Gorchakov gave him to understand, in a way which was not meant to be offensive, but which roused the German chancellor's indignation, that Russia would oppose any such scheme. The tension thus produced between the two statesmen was increased by the political complications of 1875-1878 in south-eastern Europe, which began with the Herzegovinian insurrection and culminated at the Berlin congress. Gorchakov hoped to utilize the complications in such a way as to recover, without war, the portion of Bessarabia ceded by the treaty of Paris, but he soon lost control of events, and the Slavophil agitation produced the Russo-Turkish campaign of 1877-78. By the preliminary peace of San Stefano the Slavophil aspirations seemed to be realized, but the stipulations of that peace were considerably modified by the congress of Berlin (13th June to 13th July 1878), at which the aged chancellor held nominally the post of first plenipotentiary, but left to the second plenipotentiary, Count Shuvalov, not only the task of defending Russian interests, but also the responsibility and odium for the concessions which Russia had to make to Great Britain and Austria. He had the satisfaction of seeing the lost portion of Bessarabia restored to his country by the Berlin treaty, but at the cost of greater sacrifices than he anticipated. After the congress he continued to hold the post of minister for foreign affairs, but lived chiefly abroad, and resigned formally in 1882, when he was succeeded by M. de Giers. He died at Baden-Baden on the 11th of March 1883. Prince Gorchakov devoted

himself entirely to foreign affairs, and took no part in the great internal reforms of Alexander II.'s reign. As a diplomatist he displayed many brilliant qualities—adroitness in negotiation, incisiveness in argument and elegance in style. His statesmanship, though marred occasionally by personal vanity and love of popular applause, was far-seeing and prudent. In the latter part of his career his main object was to raise the prestige of Russia by undoing the results of the Crimean War, and it may fairly be said that he in great measure succeeded. (D. M. W.)

GORDIAN, or **GORDIANUS**, the name of three Roman emperors. The first, Marcus Antonius Gordianus Sempronianus Romanus Africanus (A.D. 159-238), an extremely wealthy man, was descended from the Gracchi and Trajan, while his wife was the great-granddaughter of Antoninus Pius. While he gained unbounded popularity by his magnificent games and shows, his prudent and retired life did not excite the suspicion of Caracalla, in whose honour he wrote a long epic called *Antoninias*. Alexander Severus called him to the dangerous honours of government in Africa, and during his proconsulship occurred the usurpation of Maximin. The universal discontent roused by the oppressive rule of Maximin culminated in a revolt in Africa in 238, and Gordian reluctantly yielded to the popular clamour and assumed the purple. His son, Marcus Antonius Gordianus (192-238), was associated with him in the dignity. The senate confirmed the choice of the Africans, and most of the provinces gladly sided with the new emperors; but, even while their cause was so successful abroad, they had fallen before the sudden inroad of Cappellianus, legatus of Numidia and a supporter of Maximin. They had reigned only thirty-six days. Both the Gordians had deserved by their amiable character their high reputation; they were men of great accomplishments, fond of literature, and voluminous authors; but they were rather intellectual voluptuaries than able statesmen or powerful rulers. Having embraced the cause of Gordian, the senate was obliged to continue the revolt against Maximin, and appointed Pupienus Maximus and Caelius Balbinus, two of its noblest and most esteemed members, as joint emperors. At their inauguration a sedition arose, and the popular outcry for a Gordian was appeased by the association with them of M. Antonius Gordianus Pius (224-244), grandson of the elder Gordian, then a boy of thirteen. Maximin forthwith invaded Italy, but was murdered by his own troops while besieging Aquileia, and a revolt of the praetorian guards, to which Pupienus and Balbinus fell victims, left Gordian sole emperor. For some time he was under the control of his mother's eunuchs, till Timesitheus,⁴ his father-in-law and praefect of the praetorian guard, persuaded him to assert his independence. When the Persians under Shapur (Sapor) I, invaded Mesopotamia, the young emperor opened the temple of Janus for the last time recorded in history, and marched in person to the East. The Persians were driven back over the Euphrates and defeated in the battle of Resaena (243), and only the death of Timesitheus (under suspicious circumstances) prevented an advance into the enemy's territory. Philip the Arabian, who succeeded Timesitheus, stirred up discontent in the army, and Gordian was murdered by the mutinous soldiers in Mesopotamia.

See lives of the Gordians by Capitolinus in the *Scriptores Historiae Augustae*; Herodian vii. viii.; Zosimus I. 16, 18; Anianianus Marcellinus xxiii. 5; Eutropius ix. 2; Aurelius Victor, *Caesares*, 27; article SHAPUR (I.); Pauly-Wissowa, *Realencyclopädie*, I. 2619 f. (von Rohden).

GORDIUM, an ancient city of Phrygia situated on the Persian "Royal road" from Pessinus to Ancyra, and not far from the Sangarius. It lies opposite the village Pebi, a little north of the point where the Constantinople-Angora railway crosses the Sangarius. It is not to be confused with Gordiou-kome, refounded as Juliopolis, a Bithynian town on a small tributary of the Sangarius, about 47 m. in an air-line N.W. of Gordium. According to the legend, Gordium was founded by Gordius, a Phrygian peasant who had been called to the throne by his countrymen in obedience to an oracle of Zeus commanding them to select the first person that rode up to the temple of the god in a wagon. The king afterwards dedicated his car to the god, and another

⁴ For this name see footnote to SHAPUR.

oracle declared that whoever succeeded in untying the strangely entwined knot of cornel bark which bound the yoke to the pole should reign over all Asia. Alexander the Great, according to the story, cut the knot by a stroke of his sword. Gordium was captured and destroyed by the Gauls soon after 333 B.C. and disappeared from history. In imperial times only a small village existed on the site. Excavations made in 1900 by two German scholars, G. and A. Koerte, revealed practically no remains later than the middle of the 6th century B.C. (when Phrygia fell under Persian power).

See *Jahrbuch des Instituts, Ergänzungsheft v.* (1904). (J. G. C. A.)

GORDON, the name of a Scottish family, no fewer than 157 main branches of which are traced by the family historians. A laird of Gordon, in Berwickshire, near the English border, is said to have fallen in the battle of the Standard (1138). The families of the two sons ascribed to him by tradition, Richard Gordon of Gordon and Adam Gordon of Huntly, were united by the marriage of their great-grandchildren Alicia and Sir Adam, whose grandson Sir Adam (killed at Halidon Hill, 1333) at first took the English side in the Scottish struggle for independence, and is the first member of the family definitely to emerge into history. He was justiciar of Scotland in 1310, but after Bannockburn he attached himself to Robert Bruce, who granted him in 1318 the lordship of Strathbogie in Aberdeenshire, to which Gordon gave the name of Huntly from a village on the Gordon estate in Berwickshire. He had two sons, Adam and William. The younger son, laird of Stichel in Roxburghshire, was the ancestor of William de Gordon of Stichel and Lochinvar, founder of the Galloway branch of the family represented in the Scottish peerage by the dormant viscounty of Kenmure (q.v.), created in 1633; most of the Irish and Virginian Gordons are offshoots of this stock. The elder son, Adam, inherited the Gordon-Huntly estates. He had two grandsons, Sir John (d. 1394) and Sir Adam (slain at Homildon Hill, 1403). Sir John had two illegitimate sons, Jock of Scurdargue, the ancestor of the earls of Aberdeen, and Tam of Ruthven. From these two stocks most of the northern Gordon families are derived. Sir Adam's daughter and heiress, Elizabeth, married Sir Alexander Seton, and with her husband was confirmed in 1408 in the possession of the barony of Gordon and Huntly in Berwickshire and of the Gordon lands in Aberdeen. The Seton-Gordons are their descendants. Their son Alexander was created earl of Huntly (see HUNTLY, EARLS AND MARQUESSES OF), probably in 1445; and his heirs became dukes of Gordon, George Gordon (c. 1650-1716), 4th marquess of Huntly, being created duke of Gordon in 1684. He had been educated in a French Catholic seminary, and served in the French army in the campaigns of 1673 to 1675. Under James II. he was made keeper of Edinburgh Castle on account of his religion, but he refused to support James's efforts to impose Roman Catholicism on his subjects. He offered little active resistance when the castle was besieged by William III.'s forces. After his submission he was more than once imprisoned on suspicion of Jacobite leanings, and was ordered by George I. to reside on parole in Edinburgh. For some time before his death he was separated from his wife Elizabeth Howard, daughter of the 6th duke of Norfolk. His son Alexander, 2nd duke of Gordon (c. 1678-1728), joined the Old Pretender, but gained the royal pardon after the surrender of Gordon Castle in 1716. Of his children by his wife Henrietta Mordaunt, second daughter of Charles Mordaunt, earl of Peterborough, Cosmo George (c. 1720-1752) succeeded as 3rd duke; Lord Lewis Gordon (d. 1754) took an active part in the Jacobite rising of 1745; and General Lord Adam Gordon (c. 1726-1801) became commander of the forces in Scotland in 1782, and governor of Edinburgh Castle in 1786. Lord George Gordon (q.v.) was a younger son of the 3rd duke.

The title, with the earldom of Norwich and the barony of Gordon Huntly, became extinct on the death of George, 5th duke (1770-1836), a distinguished soldier who raised the corps now known as the 2nd battalion of the Gordon Highlanders. The marquessate of Huntly passed to his cousin and heir-male, George, 5th earl of Aboyne. Lady Charlotte Gordon, sister of and co-heiress with the 5th duke, married Charles Lennox, 4th

duke of Richmond, whose son took the name of Gordon-Lennox. The dukedom of Gordon was revived in 1876 in favour of the 6th duke of Richmond, who thenceforward was styled duke of Richmond and Gordon. Adam Gordon of Aboyne (d. 1537) took the courtesy title of earl of Sutherland in right of his wife Elisabeth, countess of Sutherland in her own right, sister of the 9th earl. The lawless and turbulent Gordons of Gight were the maternal ancestors of Lord Byron.

Among the many soldiers of fortune bearing the name of Gordon was Colonel John Gordon, one of the murderers of Wallenstein. Patrick Gordon (1635-1699) was born at Auchleuchries in Aberdeenshire, entered the service of Charles X. of Sweden in 1651 and served against the Poles. He changed sides more than once before he found his way to Moscow in 1661 and took service under the tsar Alexis. He became general in 1687; in 1688 he helped to secure Peter the Great's ascendancy; and later he crushed the revolt of the Streltzi. His diary was published in German (3 vols., 1849-1853, Moscow and St Petersburg), and selections from the English original by the Spalding Club (Aberdeen, 1859).

The Gordons fill a considerable place in Scottish legend and ballad. "Captain Car," or "Edom (Adam) of Gordon" describes an incident in the struggle between the Forbeses and Gordons in Aberdeenshire in 1571; "The Duke of Gordon's Daughter" has apparently no foundation in fact, though "Geordie" of the ballad is sometimes said to have been George, 4th earl of Huntly; "The Fire of Frendraught" goes back to a feud (1630) between James Crichton of Frendraught and William Gordon of Rothiemay; the "Gallant Gordons Gay" figure in "Chevy Chase"; William Gordon of Earliston, the Covenanter, appears in "Bothwell Bridge" &c.

See William Gordon (of old Aberdeen), *The History of the Ancient, Noble, and Illustrious House of Gordon* (2 vols., Edinburgh, 1766-1727), of which *A Concise History of the . . . House of Gordon*, by C. A. Gordon (Aberdeen, 1754) is little more than an abridgment; *The Records of Aboyne, 1230-1687*, edited by Charles, 11th marquess of Huntly, &c. (New Spalding Club, Aberdeen, 1894); *The Gordon Book*, ed. J. M. Bulloch (1902); *The House of Gordon*, ed. J. M. Bulloch (Aberdeen, vol. 1., 1903); and Mr Bulloch's *The First Duke of Gordon* (1909).

GORDON, ADAM LINDSAY (1833-1870), Australian poet, was born at Fayal in the Azores, in 1833, the son of a retired Indian officer who taught Hindustani at Cheltenham College. Young Gordon was educated there and at Merton College, Oxford, but a youthful indiscretion led to his being sent in 1853 to South Australia, where he joined the mounted police. He then became a horsebreaker, but on his father's death he inherited a fortune and obtained a seat in the House of Assembly. At this time he had the reputation of being the best non-professional steeplechase rider in the colony. In 1867 he moved to Victoria and set up a livery stable at Ballarat. Two volumes of poems, *Sea Spray and Smoke Drift* and *Asharoth*, were published in this year, and two years later he gave up his business and settled at New Brighton, near Melbourne. A second volume of poetry, *Bush Ballads and Galloping Rhymes*, appeared in 1870. It brought him more praise than emolument, and, thoroughly discouraged by his failure to make good his claim to some property in Scotland to which he believed himself entitled, he committed suicide on the 24th of June 1870. His reputation rose after his death, and he became the best known and most widely popular of Australian poets. Much of Gordon's poetry might have been written in England; when, however, it is really local, it is vividly so; his genuine feeling frequently kindles into passion; his versification is always elastic and sonorous, but sometimes too reminiscent of Swinburne. His compositions are almost entirely lyrical, and their merit is usually in proportion to the degree in which they partake of the character of the ballad.

Gordon's poems were collected and published in 1880 with a biographical introduction by Marcus Clarke.

GORDON, ALEXANDER (c. 1692-c. 1754), Scottish antiquary, is believed to have been born in Aberdeen in 1692. He is the "Sandy Gordon" of Scott's *Antiquary*. Of his parentage and early history nothing is known. He appears to have

distinguished himself in classics at Aberdeen University, and to have made a living at first by teaching languages and music. When still young he travelled abroad, probably in the capacity of tutor. He returned to Scotland previous to 1726, and devoted himself to antiquarian work. In 1726 appeared the *Itinerarium Septentrionale*, his greatest and best-known work. He was already the friend of Sir John Clerk, of Penicuik, better known as Baron Clerk (a baron of the exchequer); and the baron and Roger Gale (vice-president of the Society of Antiquaries) are the "two gentlemen, the honour of their age and country," whose letters were published, without their consent it appears, as an appendix to the *Itinerarium*. Subsequently Gordon was appointed secretary to the Society for the Encouragement of Learning, with an annual salary of £50. Resigning this post, or, as there seems reason for believing, being dismissed for carelessness in his accounts, he succeeded Dr Stukely as secretary to the Society of Antiquaries, and also acted for a short time as secretary to the Egyptian Club, an association composed of gentlemen who had visited Egypt. In 1741 he accompanied James Glen (afterwards governor), to South Carolina. Through his influence Gordon, besides receiving a grant of land in South Carolina, became registrar of the province and justice of the peace, and filled several other offices. From his will, dated the 22nd of August 1754, it appears he had a son Alexander and a daughter Frances, to whom he bequeathed most of his property, among which were portraits of himself and of friends painted by his own hand.

See Sir Daniel Wilson, *Alexander Gordon, the Antiquary*; and his Papers in the *Proceedings of the Society of Antiquaries of Scotland*, with Additional Notes and an Appendix of Original Letters by Dr David Laing (*Proc. Soc. of Antiq. of Scot.* x. 363-382).

GORDON, CHARLES GEORGE (1833-1885). British soldier and administrator, fourth son of General H. W. Gordon, Royal Artillery, was born at Woolwich on the 28th of January 1833. He received his early education at Taunton school, and was given a cadetship in the Royal Military Academy, Woolwich, in 1848. He was commissioned as second lieutenant in the corps of Royal Engineers on the 23rd of June 1852. After passing through a course of instruction at the Royal Engineers' establishment, Chatham, he was promoted lieutenant in 1854, and was sent to Pembroke dock to assist in the construction of the fortifications then being erected for the defence of Milford Haven. The Crimean War broke out shortly afterwards, and Gordon was ordered on active service, and landed at Balaklava on the 1st of January 1855. The siege of Sevastopol was in progress, and he had his full share of the arduous work in the trenches. He was attached to one of the British columns which assaulted the Redan on the 18th of June, and was also present at the capture of that work on the 8th of September. He took part in the expedition to Kinburn, and then returned to Sevastopol to superintend a portion of the demolition of the Russian dockyard. After peace with Russia had been concluded, Gordon was attached to an international commission appointed to delimit the new boundary, as fixed by treaty, between Russia and Turkey in Bessarabia; and on the conclusion of this work he was ordered to Asia Minor on similar duty, with reference to the eastern boundary between the two countries. While so employed Gordon took the opportunity to make himself well acquainted with the geography and people of Armenia, and the knowledge of dealing with eastern nations then gained was of great use to him in after life.

He returned to England towards the end of 1858, and was then selected for the appointment of adjutant and field-works instructor at the Royal Engineers' establishment, *in China*, and took up his new duties at Chatham after promotion to the rank of captain in April 1859. But his stay in England was brief, for in 1860 war was declared against China, and Gordon was ordered out there, arriving at Tientsin in September. He was too late for the attack on the Taku forts, but was present at the occupation of Peking and destruction of the Summer Palace. He remained with the British force of occupation in northern China until April 1862, when the British troops, under the command of General Staveley, proceeded to Shanghai,

in order to protect the European settlement at that place from the Taiping rebels. The Taiping revolt, which had some remarkable points of similarity with the Mahdist rebellion in the Sudan, had commenced in 1850 in the province of Kwangsi. The leader, Hung Sin Tsuan, a semi-political, semi-religious enthusiast, assumed the title of Tien Wang, or Heavenly King, and by playing on the feelings of the lower class of people gradually collected a considerable force. The Chinese authorities endeavoured to arrest him, but the imperialist troops were defeated. The area of revolt extended northwards through the provinces of Hunan and Hupeh, and down the valley of the Yangtze-kiang as far as the great city of Nanking, which was captured by the rebels in 1853. Here the Tien Wang established his court, and while spending his own time in heavenly contemplation and earthly pleasures, sent the assistant Wangs on warlike expeditions through the adjacent provinces. For some years a constant struggle was maintained between the Chinese imperialist troops and the Taipings, with varying success on both sides. The latter gradually advanced eastwards, and approaching the important city of Shanghai, alarmed the European inhabitants, who subscribed to raise a mixed force of Europeans and Manila men for the defence of the town. This force, which was placed under the command of an American, Frederick Townsend Ward (1831-1862), took up a position in the country west of Shanghai to check the advance of the rebels. Fighting continued round Shanghai for about two years, but Ward's force was not altogether successful, and when General Staveley arrived from Tientsin affairs were in a somewhat critical condition. He decided to clear the district of rebels within a radius of 30 m. from Shanghai, and Gordon was attached to his staff as engineer officer. A French force, under the command of Admiral Prôtet, co-operated with Staveley and Ward, with his little army, also assisted. Kahding, Singpo and other towns were occupied, and the country was fairly cleared of rebels by the end of 1862. Ward was, unfortunately, killed in the assault of Tseki, and his successor, Burgewine, having had a quarrel with the Chinese authorities, Li Hung Chang, the governor of the Kiang-su province, requested General Staveley to appoint a British officer to command the contingent. Staveley selected Gordon, who had been made a brevet-major in December 1862 for his previous services, and the nomination was approved by the British government. The choice was judicious as further events proved. In March 1863 Gordon proceeded to Sungkiang to take command of the force, which had received the name of "The Ever-Victorious Army," an encouraging though somewhat exaggerated title, considering its previous history. Without waiting to reorganize his troops he marched at once to the relief of Chansu, a town 40 m. north-west of Shanghai, which was invested by the rebels. The relief was successfully accomplished, and the operation established Gordon in the confidence of his troops. He then reorganized his force, a matter of no small difficulty, and advanced against Quinsan, which was captured, though with considerable loss. Gordon then marched through the country, seizing town after town from the rebels until at length the great city of Suchow was invested by his army and a body of Chinese imperialist troops. The city was taken on the 29th of November, and after its capture Gordon had a serious dispute with Li Hung Chang, as the latter had beheaded certain of the rebel leaders whose lives the former had promised to spare if they surrendered. This action, though not opposed to Chinese ethics, was so opposed to Gordon's ideas of honour that he withdrew his force from Suchow and remained inactive at Quinsan until February 1864. He then came to the conclusion that the subjugation of the rebels was more important than his dispute with Li, and visited the latter in order to arrange for further operations. By mutual consent no allusion was made to the death of the Wangs. This was a good example of one of Gordon's marked characteristics, that, though a man of strong personal feelings, he was always prepared to subdue them for the public benefit. He declined, however, to take any decoration or reward from the emperor for his services at the capture of Suchow. After

the meeting with Li Hung Chang the "Ever-Victorious Army" again advanced and took a number of towns from the rebels, ending with Chanchufu, the principal military position of the Taipings. This fell in May, when Gordon returned to Quinsan and disbanded his force. In June the Tien Wang, seeing his cause was hopeless, committed suicide, and the capture of Nanking by the imperialist troops shortly afterwards brought the Taiping revolt to a conclusion. The suppression of this serious movement was undoubtedly due in great part to the skill and energy of Gordon, who had shown remarkable qualities as a leader of men. The emperor promoted him to the rank of Titu, the highest grade in the Chinese army, and also gave him the 'Yellow Jacket, the most important decoration in China. He wished to give him a large sum of money, but this Gordon refused. He was promoted lieutenant-colonel for his Chinese services, and made a Companion of the Bath. Henceforth he was often familiarly spoken of as "Chinese" Gordon.

Gordon was appointed on his return to England Commanding Royal Engineer at Gravesend, where he was employed in superintending the erection of forts for the defence of the Thames. He devoted himself with energy to his official duties, and his leisure hours to practical philanthropy. All the acts of kindness which he did for the poor during the six years he was stationed at Gravesend will never be fully known. In October 1871 he was appointed British representative on the international commission which had been constituted after the Crimean War to maintain the navigation of the mouth of the river Danube, with headquarters at Galatz. During 1872 Gordon was sent to inspect the British military cemeteries in the Crimea, and when passing through Constantinople on his return to Galatz he made the acquaintance of Nubar Pasha, prime minister of Egypt, who sounded him as to whether he would take service under the khedive. Nothing further was settled at the time, but the following year he received a definite offer from the khedive, which he accepted with the consent of the British government, and proceeded to Egypt early in 1874. He was then a colonel in the army, though still only a captain in the corps of Royal Engineers.

To understand the object of the appointment which Gordon accepted in Egypt, it is necessary to give a few facts with reference to the Sudan. In 1820-22 Nubia, Sennar and Kordofan had been conquered by Egypt, and the authority of the Egyptians was subsequently extended southward, eastward to the Red Sea and westward over Darfur (conquered by Zobeir Pasha in 1874). One result of the Egyptian occupation of the country was that the slave trade was largely developed, especially in the White Nile and Bahr-el-Ghazal districts. Captains Speke and Grant, who had travelled through Uganda and came down the White Nile in 1863, and Sir Samuel Baker, who went up the same river as far as Albert Nyanza, brought back harrowing tales of the misery caused by the slave-hunters. Public opinion was considerably moved, and in 1869 the khedive Ismail decided to send an expedition up the White Nile, with the double object of limiting the evils of the slave trade and opening up the district to commerce. The command of the expedition was given to Sir Samuel Baker, who reached Khartum in February 1870, but, owing to the obstruction of the river by the sudd or grass barrier, did not reach Gondokoro, the centre of his province, for fourteen months. He met with great difficulties, and when his four years' service came to an end little had been effected beyond establishing a few posts along the Nile and placing some steamers on the river. It was to succeed Baker as governor of the equatorial regions that the khedive asked for Gordon's services, having come to the conclusion that the latter was the most likely person to bring the affair to a satisfactory conclusion. After a short stay in Cairo, Gordon proceeded to Khartum by way of Suakin and Berber, a route which he ever afterwards regarded as the best mode of access to the Sudan. From Khartum he proceeded up the White Nile to Gondokoro, where he arrived in twenty-four days, the sudd, which had proved such an obstacle to Baker, having been removed since the departure of the latter by the Egyptian governor-general. Gordon remained in the equatorial

provinces until October 1876, and then returned to Cairo. The two years and a half thus spent in Central Africa was a time of incessant toil. A line of stations was established from the Sobat confluence on the White Nile to the frontier of Uganda—to which country he proposed to open a route from Mombasa—and considerable progress was made in the suppression of the slave trade. The river and Lake Albert were mapped by Gordon and his staff, and he devoted himself with wonted energy to improving the condition of the people. Greater results might have been obtained but for the fact that Khartum and the whole of the Sudan north of the Sobat were in the hands of an Egyptian governor, independent of Gordon, and not too well disposed towards his proposals for diminishing the slave trade. On arriving in Cairo Gordon informed the khedive of his reasons for not wishing to return to the Sudan, but did not definitely resign the appointment of governor of the equatorial provinces. But on reaching London he telegraphed to the British consul-general in Cairo, asking him to let the khedive know that he would not go back to Egypt. Ismail Pasha, feeling, no doubt, that Gordon's resignation would injure his prestige, wrote to him saying that he had promised to return, and that he expected him to keep his word. Upon this Gordon, to whom the keeping of a promise was a sacred duty, decided to return to Cairo, but gave an assurance to some friends that he would not go back to the Sudan unless he was appointed governor-general of the entire country. After some discussion the khedive agreed, and made him governor-general of the Sudan, inclusive of Darfur and the equatorial provinces.

One of the most important questions which Gordon had to take up on his appointment was the state of the political relations between Egypt and Abyssinia, which had been in an unsatisfactory condition for some years. The dispute centred round the district of Bogos, lying not far inland from Massawa, which both the khedive and King John of Abyssinia claimed as belonging to their respective dominions. War broke out in 1875, when an Egyptian expedition was despatched to Abyssinia, and was completely defeated by King John near Gundet. A second and larger expedition, under Prince Hassan, the son of the khedive, was sent the following year from Massawa. The force was routed by the Abyssinians at Gura, but Prince Hassan and his staff got back to Massawa. Matters then remained quiet until March 1877, when Gordon proceeded to Massawa to endeavour to make peace with King John. He went up to Bogos, and had an interview with Walad Michael, an Abyssinian chief and the hereditary ruler of Bogos, who had joined the Egyptians with a view to raiding on his own account. Gordon, with his usual powers of diplomacy, persuaded Michael to remain quiet, and wrote to the king proposing terms of peace. But he received no reply at that time, as John, feeling pretty secure on the Egyptian frontier after his two successful actions against the khedive's troops, had gone southwards to fight with Menelek, king of Shoa. Gordon, seeing that the Abyssinian difficulty could wait for a few months, proceeded to Khartum. Here he took up the slavery question, and proposed to issue regulations making the registration of slaves compulsory, but his proposals were not approved by the Cairo government. In the meantime an insurrection had broken out in Darfur, and Gordon proceeded to that province to relieve the Egyptian garrisons, which were considerably stronger than the force he had available, the insurgents also being far more numerous than his little army. On coming up with the main body of rebels he saw that diplomacy gave a better chance of success than fighting, and, accompanied only by an interpreter, rode into the enemy's camp to discuss the situation. This bold move, which probably no one but Gordon would have attempted, proved quite successful, as part of the insurgents joined him, and the remainder retreated to the south. The relief of the Egyptian garrisons was successfully accomplished, and Gordon visited the provinces of Berber and Dongola, whence he had again to return to the Abyssinian frontier to treat with King John. But no satisfactory settlement was arrived at, and Gordon came back to Khartum in January 1878. There he had scarcely a week's rest when the

Governor-General.

khedive summoned him to Cairo to assist in settling the financial affairs of Egypt. He reached Cairo in March, and was at once appointed by Ismail as president of a commission of inquiry into the finances, on the understanding that the European commissioners of the debt, who were the representatives of the bondholders, and whom Ismail regarded as interested parties, should not be members of the commission. Gordon accepted the post on these terms, but the consuls-general of the different powers refused to agree to the constitution of the commission, and it fell to the ground, as the khedive was not strong enough to carry his point. The attempt of the latter to utilize Gordon as a counterpoise to the European financiers having failed, Ismail fell into the hands of his creditors, and was deposed by the sultan in the following year in favour of his son Tewfik. After the conclusion of the financial episode, Gordon proceeded to the province of Harrar, south of Abyssinia, and, finding the administration in a bad condition, dismissed Raouf Pasha, the governor. He then returned to Khartum, and in 1879 went again into Darfur to pursue the slave traders, while his subordinate, Gessj Pasha, fought them with great success in the Bahr-el-Ghazal district and killed Sulciman, their leader and a son of Zobeir. This put an end to the revolt, and Gordon went back to Khartum. Shortly afterwards he went down to Cairo, and when there was requested by the new khedive to pay a visit to King John and make a definite treaty of peace with Abyssinia. Gordon had an interesting interview with the king, but was not able to do much, as the king wanted great concessions from Egypt, and the khedive's instructions were that nothing material was to be conceded. The matter ended by Gordon being made a prisoner and sent back to Massawa. Thence he returned to Cairo and resigned his Sudan appointment. He was considerably exhausted by the three years' incessant work, during which he had ridden no fewer than 8500 m. on camels and mules, and was constantly engaged in the task of trying to reform a vicious system of administration.

In March 1880 Gordon visited the king of the Belgians at Brussels, and King Leopold suggested that he should at some future date take charge of the Congo Free State. ^{1880-1884.} In April the government of the Cape Colony telegraphed to him offering the position of commandant of the Cape local forces, but he declined the appointment. In May the marquis of Ripon, who had been given the post of governor-general of India, asked Gordon to go with him as private secretary. This he agreed to do, but a few days later, feeling that he was not suitable for the position, asked Lord Ripon to release him. The latter refused to do so, and Gordon accompanied him to India, but definitely resigned his post on Lord Ripon's staff shortly afterwards. Hardly had he resigned when he received a telegram from Sir Robert Hart, inspector-general of customs in China, inviting him to go to Peking. He started at once and arrived at Tientsin in July, where he met Li Hung Chang, and learnt that affairs were in a critical condition, and that there was risk of war with Russia. Gordon proceeded to Peking and used all his influence in favour of peace. His arguments, which were given with much plainness of speech, appear to have convinced the Chinese government, and war was avoided. Gordon returned to England, and in April 1881 exchanged with a brother officer, who had been ordered to Mauritius as Commanding Royal Engineer, but who for family reasons was unable to accept the appointment. He remained in Mauritius until the March following, when, on promotion to the rank of major-general, he had to vacate the position of Commanding Royal Engineer. Just at the same time the Cape ministry telegraphed to him to ask if he would go to the Cape to consult with the government as regards settling affairs in Basutoland. The telegram stated that the position of matters was grave, and that it was of the utmost importance that the colony should secure the services of someone of proved ability, firmness and energy. Gordon sailed at once for the Cape, and saw the governor, Sir Hercules Robinson, Mr Thos. Scanlen, the premier, and Mr. J. X. Merriman, a member of the ministry, who, for political reasons, asked him not to go to Basutoland, but to take the

appointment of commandant of the colonial forces at King William's Town. After a few months, which were spent in reorganizing the colonial forces, Gordon was requested to go up to Basutoland to try to arrange a settlement with the chief Masupha, one of the most powerful of the Basuto leaders. Greatly to his surprise, at the very time he was with Masupha, Mr. J. W. Sauer, a member of the Cape government, was taking steps to induce Lerethodi, another chief, to advance against Masupha. This not only placed Gordon in a position of danger, but was regarded by him as an act of treachery. He advised Masupha not to deal with the Cape government until the hostile force was withdrawn, and resigned his appointment. He considered that the Basuto difficulty was due to the bad system of administration by the Cape government. That Gordon's views were correct is proved by the fact that a few years later Basutoland was separated from Cape Colony and placed directly under the imperial government. After his return to England from the Cape, being unemployed, Gordon decided to go to Palestine, a country he had long desired to visit. Here he remained for a year, and devoted his time to the study of Biblical history and of the antiquities of Jerusalem. The king of the Belgians then asked him to take charge of the Congo Free State, and he accepted the mission and returned to London to make the necessary preparations. But a few days after his arrival he was requested by the British government to proceed immediately to the Sudan. To understand the reasons for this, it is necessary briefly to recapitulate the course of events in that country since Gordon had left it in 1879.

After his resignation of the post of governor-general, Raouf Pasha, an official of the ordinary type, who, as already mentioned, had been dismissed by Gordon for misgovernment in 1878, was appointed to succeed him. As Raouf was instructed to increase the receipts and diminish the expenditure, the system of government naturally reverted to the old methods, which Gordon had endeavoured to improve. The fact that justice and firmness were succeeded by injustice and weakness tended naturally to the outbreak of revolt, and unfortunately there was a leader ready to head a rebellion—one Mahommed Ahmed, already known for some years as a holy man, who was insulted by an Egyptian official, and retiring with some followers to the island of Abba on the White Nile, proclaimed himself as the mahdi, a successor of the prophet. Raouf endeavoured to take him prisoner but without success, and the revolt spread rapidly. Raouf was recalled, and succeeded by Abdel Kader Pasha, a much stronger governor, who had some success, but whose forces were quite insufficient to cope with the rebels. The Egyptian government was too busily engaged in suppressing Arabi's revolt to be able to send any help to Abdel Kader, and in September 1882, when the British troops entered Cairo, the position in the Sudan was very perilous. Had the British government listened to the representations then made to them, that, having conquered Egypt, it was imperative at once to suppress the revolt in the Sudan, the rebellion could have been crushed, but unfortunately Great Britain would do nothing herself, while the steps she allowed Egypt to take ended in the disaster to Hicks Pasha's expedition. Then, in December 1883, the British government saw that something must be done, and ordered Egypt to abandon the Sudan. But abandonment was a policy most difficult to carry out, as it involved the withdrawal of thousands of Egyptian soldiers, civilian employes and their families. Abdel Kader Pasha was asked to undertake the work, and he agreed on the understanding that he would be supported, and that the policy of abandonment was not to be announced. But the latter condition was refused, and he declined the task. The British government then asked General Gordon to proceed to Khartum to report on the best method of carrying out the evacuation. The mission was highly popular in England. Sir Evelyn Baring (Lord Cromer) was, however, at first opposed to Gordon's appointment. His objections were overcome, and Gordon received his instructions in London on the 18th of January 1884, and started at once for Cairo, accompanied by Lieut.-Colonel J. D. H. Stewart.

At Cairo he received further instructions from Sir Evelyn Baring, and was appointed by the khedive as governor-general, with executive powers. Travelling by Korosko and Berber, he arrived at Khartum on the 18th of February, and was well received by the inhabitants, who believed that he had come to save the country from the rebels. Gordon at once commenced the task of sending the women and children and the sick and wounded to Egypt, and about two thousand five hundred had been removed before the mahdi's forces closed upon Khartum. At the same time he was impressed with the necessity of making some arrangement for the future government of the country, and asked for the help of Zobeir (q.v.), who had great influence in the Sudan, and had been detained in Cairo for some years. This request was made on the very day Gordon reached Khartum, and was in accordance with a similar proposal he had made when at Cairo. But, after delays which involved the loss of much precious time, the British government refused (13th of March) to sanction the appointment, because Zobeir had been a notorious slave-hunter. With this refusal vanished all hope of a peaceful retreat of the Egyptian garrisons. Wavering tribes went over to the mahdi. The advance of the rebels against Khartum was combined with a revolt in the eastern Sudan, and the Egyptian troops in the vicinity of Suakin met with constant defeat. At length a British force was sent to Suakin under the command of General Sir Gerald Graham, and routed the rebels in several hard-fought actions. Gordon telegraphed to Sir Evelyn Baring urging that the road from Suakin to Berber should be opened by a small force. But this request, though strongly supported by Baring and the British military authorities in Cairo, was refused by the government in London. In April General Graham and his forces were withdrawn from Suakin, and Gordon and the Sudan were seemingly abandoned to their fate. The garrison of Berber, seeing that there was no chance of relief, surrendered a month later and Khartum was completely isolated. Had it not been for the presence of Gordon the city would also soon have fallen, but with an energy and skill that were almost miraculous, he so organized the defence that Khartum held out until January 1885. When it is remembered that Gordon was of a different nationality and religion to the garrison and population, that he had only one British officer to assist him, and that the town was badly fortified and insufficiently provided with food, it is just to say that the defence of Khartum is one of the most remarkable episodes in military history. The siege commenced on the 18th of March, but it was not until August that the British government under the pressure of public opinion decided to take steps to relieve Gordon. General Stephenson, who was in command of the British troops in Egypt, wished to send a brigade at once to Dongola, but he was overruled, and it was not until the beginning of November that the British relief force was ready to start from Wadi Halfa under the command of Lord Wolseley. The force reached Korti towards the end of December, and from that place a column was despatched across the Bayuda desert to Metemma on the Nile. After some severe fighting in which the leader of the column, Sir Herbert Stewart, was mortally wounded, the force reached the river on the 20th of January, and the following day four steamers, which had been sent down by Gordon to meet the British advance, and which had been waiting for them for four months, reported to Sir Charles Wilson, who had taken command after Sir Herbert Stewart was wounded.

Death. On the 24th Wilson started with two of the steamers for Khartum, but on arriving there on the 28th he found that the place had been captured by the rebels and Gordon killed two days before. A belief has been entertained that Wilson might have started earlier and saved the town, but this is quite groundless. In the first place, Wilson could not have started sooner than he did; and in the second, even if he had been able to do so, it would have made no difference, as the rebels could have taken Khartum any time they pleased after the 5th of January, when the provisions were exhausted. Another popular notion, that the capture of the place was due to treachery on the part of the garrison, is equally without foundation. The

attack was made at a point in the fortifications where the rampart and ditch had been destroyed by the rising of the Nile, and when the mahdi's troops entered the soldiers were too weak to make any effectual resistance. Gordon himself expected the town to fall before the end of December, and it is really difficult to understand how he succeeded in holding out until the 26th of January. Writing on the 14th of December he said, "Now, mark this, if the expeditionary force—and I ask for no more than two hundred men—does not come in ten days, the town may fall, and I have done my best for the honour of my country." He had indeed done his best, and far more than could have been regarded as possible. To understand what he went through during the latter months of the siege, it is only necessary to read his own journal, a portion of which, dating from 10th September to 14th December 1884, was fortunately preserved and published.

Gordon was not an author, but he wrote many short memoranda on subjects that interested him, and a considerable number of these have been utilized, especially in the work by his brother, Sir Henry Gordon, entitled *Events in the Life of Charles George Gordon, from its Beginning to its End*. He was a voluminous letter-writer, and much of his correspondence has been published. His character was remarkable, and the influence he had over those with whom he came in contact was very striking. His power to command men of non-European races was probably unique. He had no fear of death, and cared but little for the opinion of others, adhering tenaciously to the course he believed to be right in the face of all opposition. Though not holding to outward forms of religion, he was a truly religious man in the highest sense of the word, and was a constant student of the Bible. To serve God and to do his duty were the great objects of his life, and he died as he had lived, carrying out the work that lay before him to the best of his ability. The last words of his last letter to his sister, written when he knew that death was very near, sum up his character: "I am quite happy, thank God, and, like Lawrence, I have tried to do my duty."

With this estimate of Gordon's character may be contrasted those of Lord Cromer (the most severe of Gordon's critics), and of Lord Morley of Blackburn; in their strictures as in their praise they help to explain both the causes of the extraordinary influence wielded by Gordon over all sorts and conditions of men and also his difficulties. Lord Cromer's criticism, it should be remembered, does not deal with Gordon's career as a whole but solely with his last mission to the Sudan; Lord Morley's is a more general judgment.

Lord Cromer (*Modern Egypt*, vol. 1, ch. xxvii., p. 565-571) says: "We may admire, and for my own part I do very much, to admire General Gordon's personal courage, his disinterestedness and his chivalrous feeling in favour of the beleaguered garrisons, but admiration of these qualities is no sufficient plea against a condemnation of his conduct on the ground that it was quixotic. In his last letter to his sister, dated December 14, 1884, he wrote: 'I am quite happy, thank God, and, like Lawrence, I have tried to do my duty' . . . I am not now dealing with General Gordon's character, which was in many respects noble, or with his military defence of Khartoum, which was heroic, but with the political conduct of his mission, and from this point of view I have no hesitation in saying that General Gordon cannot be considered to have tried to do his duty unless a very strained and mistaken view be taken of what his duty was. . . . As a matter of public morality I cannot think that General Gordon's process of reasoning is defensible. . . . I do not think that it can be held that General Gordon made any serious effort to carry out the main ends of British and Egyptian policy in the Sudan. He thought more of his personal opinions than of the interests of the state. . . . In fact, except personal courage, great fertility in military resource, a lively though sometimes ill-directed repugnance to injustice, oppression and meanness of every description, and a considerable power of acquiring influence over those, necessarily limited in numbers, with whom he was brought into personal contact, General Gordon does not appear to have possessed any of the qualities which would have fitted him to undertake the difficult task he had in hand."

Lord Morley (*Life of Gladstone*, vol. iii., 1st ed., 1903, ch. 9, p. 151) says: "Gordon, as Mr Gladstone said, was a hero of heroes. He was a soldier of infinite personal courage and daring, of striking military energy, initiative and resource; a high, pure and single character, dwelling much in the region of the unseen. But as all who knew him admit, and as his own records testify, notwithstanding an undercurrent of shrewd common sense, he was the creature, almost the sport, of impulse; his impressions and purposes changed with the speed of lightning; anger often mastered him; he went very often by intuitions and inspirations rather than by cool

AUTHORITIES.—*The Journals of Major-General Gordon at Khartoum* (1885); Lord Cromer, *Modern Egypt* (2 vols., 1908); F. R. Wingate, *Mahdism and the Egyptian Sudan* (1891); the *British Parliamentary Paper on Egypt* (1884–1885); C. G. Gordon, *Reflections in Palestine* (1884); edited by D. C. Boulger, *General Gordon's Letters from the Crimea, the Danube, and Armenia* (1884); edited by G. B. Hill, *Colonel Gordon in Central Africa* (1881); *Letters of General C. G. Gordon to his Sister* (1888); H. W. Gordon, *Events in the Life of C. G. Gordon* (1886); Commander L. Brine, *The Taeping Rebellion in China* (1862); A. Wilson, *Gordon's Campaigns and the Taeping Rebellion* (1868); D. C. Boulger, *Life of Gordon* (1896); A. Egmont Hake, *The Story of Chinese Gordon* (1st vol., 1884, 2nd vol., 1885); Colonel Sir W. F. Butler, *Charles George Gordon* (1889); Archibald Forbes, *Chinese Gordon* (1884); edited by A. Egmont Hake, *Events in the Taeping Rebellion* (1891); S. Mossman, *General Gordon's Diary in China* (1885); Lieutenant T. Lister, R.E., *With Gordon in the Crimea* (1891); Lieutenant-General Sir G. Graham, *Last Words with Gordon* (1887); "War Correspondent," *Why Gordon Perished* (C. M. W.)

GORDON, LORD GEORGE (1751–1793), third and youngest son of Cosmo George, duke of Gordon, was born in London on the 26th of December 1751. After completing his education at Eton, he entered the navy, where he rose to the rank of lieutenant in 1772, but Lord Sandwich, then at the head of the admiralty, would not promise him the command of a ship, and he resigned his commission shortly before the beginning of the American War. In 1774 the pocket borough of Ludgershall was bought for him by General Fraser, whom he was opposing in Invernesshire, in order to bribe him not to contest the county. He was considered flighty, and was not looked upon as being of any importance. In 1779 he organized, and made himself head of the Protestant associations, formed to secure the repeal of the Catholic Relief Act of 1778. On the 2nd of June 1780 he headed the mob which marched in procession from St George's Fields to the Houses of Parliament in order to present the monster petition against the acts. After the mob reached Westminster a terrific riot ensued, which continued several days, during which the city was virtually at their mercy. At first indeed they dispersed after threatening to make a forcible entry into the House of Commons, but reassembled soon afterwards and destroyed several Roman Catholic chapels, pillaged the private dwellings of many Roman Catholics, set fire to Newgate and broke open all the other prisons, attacked the Bank of England and several other public buildings, and continued the work of violence and conflagration until the interference of the military, by whom no fewer than 450 persons were killed and wounded before the riots were quelled. For his share in instigating the riots Lord Gordon was apprehended on a charge of high treason; but, mainly through the skilful and eloquent defence of Erskine, he was acquitted on the ground that he had no treasonable intentions. His life was henceforth full of crack-brained schemes, political and financial. In 1786 he was excommunicated by the archbishop of Canterbury for refusing to bear witness in an ecclesiastical suit; and in 1787 he was convicted of libelling the queen of France, the French ambassador and the administration of justice in England. He was, however, permitted to withdraw from the court without bail, and made his escape to Holland; but on account of representations from the court of Versailles he was commanded to quit that country, and, returning to England, was apprehended, and in January 1788 was sentenced

inference from carefully surveyed fact; with many variations of mood he mixed, as we often see in people less famous, an invincible faith in his own rapid prepossessions while they lasted. Everybody now discerns that to despatch a soldier of this temperament on a piece of business (the mission to the Sudan in 1884) that was not only difficult and dangerous, as Sir E. Baring said, but profoundly obscure, and needing vigilant sanity and self-control, was little better than to call in a wizard with his magic. Mr Gladstone always professed perplexity in understanding why the violent end of the gallant Cavagnari in Afghanistan stirred the world so little in comparison with the fate of Gordon. The answer is that Gordon seized the imagination of England, and seized it on its higher side. His religion was eccentric, but it was religion; the Bible was the rock on which he founded himself, both old dispensation and new; he was known to hate forms, ceremonies and all the 'solemn plausibilities'; his speech was sharp, pithy, rapid and ironic; above all, he knew the ways of war and would not bear the sword for sought."

to five years' imprisonment in Newgate, where he lived at his ease, giving dinners and dances. As he could not obtain securities for his good behaviour on the termination of his term of imprisonment, he was not allowed to leave Newgate, and there he died of delirious fever on the 1st of November 1793. Some time before his apprehension he had become a convert to Judaism, and had undergone the initiatory rite.

A serious defence of most of his eccentricities is undertaken in *The Life of Lord George Gordon, with a Philosophical Review of his Political Conduct*, by Robert Watson, M.D. (London, 1795). The best accounts of Lord George Gordon are to be found in the *Annual Registers* from 1780 to the year of his death.

GORDON, SIR JOHN WATSON (1788–1864), Scottish painter, was the eldest son of Captain Watson, R.N., a cadet of the family of Watson of Overmains, in the county of Berwick. He was born in Edinburgh in 1788, and was educated specially with a view to his joining the Royal Engineers. He entered as a student in the government school of design, under the management of the Board of Manufactures. His natural taste for art quickly developed itself, and his father was persuaded to allow him to adopt it as his profession. Captain Watson was himself a skilful draughtsman, and his brother George Watson, afterwards president of the Scottish Academy, stood high as a portrait painter, second only to Sir Henry Raeburn, who also was a friend of the family. In the year 1808 John sent to the exhibition of the Lyceum in Nicolson Street a subject from the *Lay of the Last Minstrel*, and continued for some years to exhibit fancy subjects; but, although freely and sweetly painted, they were altogether without the force and character which stamped his portrait pictures as the works of a master. After the death of Sir Henry Raeburn in 1823, he succeeded to much of his practice. He assumed in 1826 the name of Gordon. One of the earliest of his famous sitters was Sir Walter Scott, who sat for a first portrait in 1820. Then came J. G. Lockhart in 1821; Professor Wilson, 1822 and 1850, two portraits; Sir Archibald Alison, 1839; Dr Chalmers, 1844; a little later De Quincey, and Sir David Brewster, 1864. Among his most important works may be mentioned the earl of Dalhousie (1833), in the Archers' Hall, Edinburgh; Sir Alexander Hope (1835), in the county buildings, Linlithgow; Lord President Hope, in the Parliament House; and Dr Chalmers. These, unlike his later works, are generally rich in colour. The full length of Dr Brunton (1844), and Dr Lee, the principal of the university (1846), both on the staircase of the college library, mark a modification of his style, which ultimately resolved itself into extreme simplicity, both of colour and treatment.

During the last twenty years of his life he painted many distinguished Englishmen who came to Edinburgh to sit to him. And it is significant that David Cox, the landscape painter, on being presented with his portrait, subscribed for by many friends, chose to go to Edinburgh to have it executed by Watson Gordon, although he neither knew the painter personally nor had ever before visited the country. Among the portraits painted during this period, in what may be termed his third style, are De Quincey, in the National Portrait Gallery, London; General Sir Thomas Macdougall Brisbane, in the Royal Society; the prince of Wales, Lord Macaulay, Sir M. Packington, Lord Murray, Lord Cockburn, Lord Rutherford and Sir John Shaw Lefevre, in the Scottish National Gallery. These latter pictures are mostly clear and grey, sometimes showing little or no positive colour, the flesh itself being very grey, and the handling extremely masterly, though never obtruding its cleverness. He was very successful in rendering acute observant character. A good example of his last style, showing pearly flesh-painting freely handled, yet highly finished, is his head of Sir John Shaw Lefevre.

John Watson Gordon was one of the earlier members of the Royal Scottish Academy, and was elected its president in 1850; he was at the same time appointed linner for Scotland to the queen, and received the honour of knighthood. Since 1841 he had been an associate of the Royal Academy, and in 1851 he was elected a royal academican. He died on the 1st of June 1864.

GORDON, LEON, originally **JUDAH LOEB BEN ASHER** (1831-1892), Russian-Jewish poet and novelist (Hebrew), was born at Wilna in 1831 and died at St Petersburg in 1892. He took a leading part in the modern revival of the Hebrew language and culture. His satires did much to rouse the Russian Jews to a new sense of the reality of life, and Gordon was the apostle of enlightenment in the Ghetos. His Hebrew style is classical and pure. His poems were collected in four volumes, *Kol Shire Yehudah* (St Petersburg, 1883-1884); his novels in *Kol Kithbe Yehuda* (Odessa, 1889).

For his works see *Jewish Quarterly Review*, xviii. 437 seq.

GORDON, PATRICK (1635-1699), Russian general, was descended from a Scottish family of Aberdeenshire, who possessed the small estate of Auchleuchries, and were connected with the house of Haddo. He was born in 1635, and after completing his education at the parish schools of Cruden and Ellon, entered, in his fifteenth year, the Jesuit college at Braunsberg, Prussia; but, as "his humour could not endure such a still and strict way of living," he soon resolved to return home. He changed his mind, however, before re-embarking, and after journeying on foot in several parts of Germany, ultimately, in 1655, enlisted at Hamburg in the Swedish service. In the course of the next five years he served alternately with the Poles and Swedes as he was taken prisoner by either. In 1661, after further experience as a soldier of fortune, he took service in the Russian army under Alexis I., and in 1665 he was sent on a special mission to England. After his return he distinguished himself in several wars against the Turks and Tatars in southern Russia, and in recognition of his services he in 1678 was made major-general, in 1679 was appointed to the chief command at Kiev, and in 1683 was made lieutenant-general. He visited England in 1686, and in 1687 and 1689 took part as quartermaster-general in expeditions against the Crim Tatars in the Crimea, being made full general for his services, in spite of the denunciations of the Greek Church to which, as a heretic, he was exposed. On the breaking out of the revolution in Moscow in 1689, Gordon with the troops he commanded virtually decided events in favour of the tsar Peter I., and against the tsaritsa Sophia. He was therefore during the remainder of his life in high favour with the tsar, who confided to him the command of his capital during his absence from Russia, employed him in organizing his army according to the European system, and latterly raised him to the rank of general-in-chief. He died on the 20th of November 1699. The tsar, who had visited him frequently during his illness, was with him when he died, and with his own hands closed his eyes.

General Gordon left behind him a diary of his life, written in English. This is preserved in MS. in the archives of the Russian foreign office. A complete German translation, edited by Dr Maurice Possalt (*Tagebuch des Generals Patrick Gordon*) was published, the first volume at Moscow in 1849, the second at St Petersburg in 1851, and the third at St Petersburg in 1853; and *Passages from the Diary of General Patrick Gordon of Auchleuchries (1635-1699)*, was printed, under the editorship of Joseph Robertson, for the Spalding Club, Aberdeen, 1859.

GORDON-CUMMING, ROUALEYN GEORGE (1820-1866), Scottish traveller and sportsman, known as the "lion hunter," was born on the 15th of March 1820. He was the second son of Sir William G. Gordon-Cumming, 2nd baronet of Altyre and Gordonstown, Elginshire. From his early years he was distinguished by his passion for sport. He was educated at Eton, and at eighteen joined the East India Co.'s service as a cornet in the Madras Light Cavalry. The climate of India not suiting him, after two years' experience he retired from the service and returned to Scotland. During his stay in the East he had laid the foundation of his collection of hunting trophies and specimens of natural history. In 1843 he joined the Cape Mounted Rifles, but for the sake of absolute freedom sold out at the end of the year and with an ox wagon and a few native followers set out for the interior. He hunted chiefly in Bechuanaland and the Limpopo valley, regions then swarming with big game. In 1848 he returned to England. The story of his remarkable exploits is vividly told in his book, *Five Years of a Hunter's*

Life in the Far Interior of South Africa (London, 1850, 3rd ed. 1851). Of this volume, received at first with incredulity by stay-at-home critics, David Livingstone, who furnished Gordon-Cumming with most of his native guides, wrote: "I have no hesitation in saying that Mr Cumming's book conveys a truthful idea of South African hunting" (*Missionary Travels*, chap. vii.). His collection of hunting trophies was exhibited in London in 1851 at the Great Exhibition, and was illustrated by a lecture delivered by Gordon-Cumming. The collection, known as "The South Africa Museum," was afterwards exhibited in various parts of the country. In 1858 Gordon-Cumming went to live at Fort Augustus on the Caledonian Canal, where the exhibition of his trophies attracted many visitors. He died there on the 24th of March 1866.

An abridgment of his book was published in 1856 under the title of *The Lion Hunter of South Africa*, and in this form was frequently reprinted, a new edition appearing in 1904.

GORE, CATHERINE GRACE FRANCES (1799-1861), English novelist and dramatist, the daughter of Charles Moody, a wine-merchant, was born in 1799 at East Retford, Nottinghamshire. In 1823 she was married to Captain Charles Gore; and, in the next year, she published her first work, *Theresa Marchmont, or the Maid of Honour*. Then followed, among others, the *Lettre de Cachet* (1827), *The Reign of Terror* (1827), *Hungarian Tales* (1829), *Manners of the Day* (1830), *Mothers and Daughters* (1831), and *The Fair of May Fair* (1832), *Mrs Armytage* (1836). Every succeeding year saw several volumes from her pen: *The Cabinet Minister* and *The Courtier of the Days of Charles II.*, in 1839; *Preferment* in 1840. In 1841 *Cecil, or the Adventures of a Coxcomb*, attracted considerable attention. *Greville, or a Season in Paris* appeared in the same year; then *Ormington, or Cecil a Peer*, *Fascination*, *The Ambassador's Wife*; and in 1843 *The Banker's Wife*. Mrs Gore continued to write, with unflinching fertility of invention, till her death on the 20th of January 1861. She also wrote some dramas of which the most successful was the *School for Coquettes*, produced at the Haymarket (1831). She was a woman of versatile talent, and set to music Burns's "And ye shall walk in silk attire," one of the most popular songs of her day. Her extraordinary literary industry is proved by the existence of more than seventy distinct works. Her best novels are *Cecil, or the Adventures of a Coxcomb*, and *The Banker's Wife*. *Cecil* gives extremely vivid sketches of London fashionable life, and is full of happy epigrammatic touches. For the knowledge of London clubs displayed in it Mrs Gore was indebted to William Beckford, the author of *Valdek*. *The Banker's Wife* is distinguished by some clever studies of character, especially in the persons of Mr Hamlyn, the cold calculating money-maker, and his warm-hearted country neighbour, Colonel Hamilton.

Mrs Gore's novels had an immense temporary popularity; they were parodied by Thackeray in *Punch*, in his "Lords and Liveries by the author of *Dukes and Dejeuners*"; but, tedious as they are to present-day readers, they presented on the whole faithful pictures of the contemporary life and pursuits of the English upper classes.

GORE, CHARLES (1853-), English divine, was born in 1853, the 3rd son of the Hon. Charles Alexander Gore, brother of the 4th earl of Arran. His mother was a daughter of the 4th earl of Bessborough. He was educated at Harrow and at Balliol College, Oxford, and was elected fellow of Trinity College in 1875. From 1880 to 1883 he was vice-principal of the theological college at Cuddesdon, and, when in 1884 Pusey House was founded at Oxford as a home for Dr Pusey's library and a centre for the propagation of his principles, he was appointed principal, a position which he held until 1893. As principal of Pusey House Mr Gore exercised a wide influence over undergraduates and the younger clergy, and it was largely, if not mainly, under this influence that the "Oxford Movement" underwent a change which to the survivors of the old school of Tractarians seemed to involve a break with its basic principles. "Puseyism" had been in the highest degree conservative, basing itself on authority and tradition, and repudiating any compromise with the modern critical and liberalizing spirit. Mr Gore, starting from the same

basis of faith and authority, soon found from his practical experience in dealing with the "doubts and difficulties" of the younger generation that this uncompromising attitude was untenable, and set himself the task of reconciling the principle of authority in religion with that of scientific authority by attempting to define the boundaries of their respective spheres of influence. To him the divine authority of the Catholic Church was an axiom, and in 1889 he published two works, the larger of which, *The Church and the Ministry*, is a learned vindication of the principle of Apostolic Succession in the episcopate against the Presbyterians and other Protestant bodies, while the second, *Roman Catholic Claims*, is a defence, couched in a more popular form, of the Anglican Church and Anglican orders against the attacks of the Romanists.

So far his published views had been in complete consonance with those of the older Tractarians. But in 1890 a great stir was created by the publication, under his editorship, of *Lux Mundi*, a series of essays by different writers, being an attempt "to succour a distressed faith by endeavouring to bring the Christian Creed into its right relation to the modern growth of knowledge, scientific, historic, critical; and to modern problems of politics and ethics." Mr Gore himself contributed an essay on "The Holy Spirit and Inspiration." The book, which ran through twelve editions in a little over a year, met with a somewhat mixed reception. Orthodox churchmen, Evangelical and Tractarian alike, were alarmed by views on the incarnate nature of Christ that seemed to them to impugn his Divinity, and by concessions to the Higher Criticism in the matter of the inspiration of Holy Scriptures which appeared to them to convert the "impregnable rock," as Gladstone had called it, into a foundation of sand; sceptics, on the other hand, were not greatly impressed by a system of defence which seemed to draw an artificial line beyond which criticism was not to advance. None the less the book produced a profound effect, and that far beyond the borders of the English Church, and it is largely due to its influence, and to that of the school it represents, that the High Church movement developed thenceforth on "Modernist" rather than Tractarian lines.

In 1891 Mr Gore was chosen to deliver the Bampton lectures before the university, and chose for his subject the Incarnation. In these lectures he developed the doctrine, the enunciation of which in *Lux Mundi* had caused so much heart-searching. This is an attempt to explain how it came that Christ, though incarnate God, could be in error, e.g. in his citations from the Old Testament. The orthodox explanation was based on the principle of accommodation (q.v.). This, however, ignored the difficulty that if Christ during his sojourn on earth was not subject to human limitations, especially of knowledge, he was not a man as other men, and therefore not subject to their trials and temptations. This difficulty Gore sought to meet through the doctrine of the *εἰσῆσις*. Ever since the Pauline epistles had been received into the canon theologians had, from various points of view, attempted to explain what St Paul meant when he wrote of Christ (2 Phil. ii. 7) that "he emptied himself and took upon him the form of a servant" (*ἐαυτὸν ἐκένωσεν μορφῆν δούλου λαβῶν*). According to Mr Gore this means that Christ, on his incarnation, became subject to all human limitations, and had, so far as his life on earth was concerned, stripped himself of all the attributes of the Godhead, including the Divine omniscience, the Divine nature being, as it were, hidden under the human.¹

Lux Mundi and the Bampton lectures led to a situation of some tension which was relieved when in 1893 Dr Gore resigned his principalship and became vicar of Radley, a small parish near Oxford. In 1894 he became canon of Westminster. Here he gained commanding influence as a preacher and in 1898 was appointed one of the court chaplains. In 1902 he succeeded

¹ Cf. the Lutheran theologian Ernst Sartorius in his *Lehre von der heiligen Liebe* (1844), *Lehre* ii. pp. 21 et seq.: "The Son of God veils his all-seeing eye and descends into human darkness and as child of man opens his eye as the gradually growing light of the world of humanity, until at the right hand of the Father he allows it to shine forth in all its glory." See Loofs, *Art.* "Kenosis" in Herzog-Hauck, *Realencyklopädie* (ed. 1901), x. 247.

J. J. S. Perowas as bishop of Worcester and in 1905 was installed bishop of Birmingham, a new see the creation of which had been mainly due to his efforts. While adhering rigidly to his views on the divine institution of episcopacy as essential to the Christian Church, Dr Gore from the first cultivated friendly relations with the ministers of other denominations, and advocated co-operation with them in all matters when agreement was possible. In social questions he became one of the leaders of the considerable group of High Churchmen known, somewhat loosely, as Christian Socialists. He worked actively against the sweating system, pleaded for European intervention in Macedonia, and was a keen supporter of the Licensing Bill of 1908. In 1892 he founded the clerical fraternity known as the Community of the Resurrection. Its members are priests, who are bound by the obligation of celibacy, live under a common rule and with a common purse. Their work is pastoral, evangelistic, literary and educational. In 1898 the House of the Resurrection at Mirfield, near Huddersfield, became the centre of the community; in 1903 a college for training candidates for orders was established there, and in the same year a branch house, for missionary work, was set up in Johannesburg in South Africa.

Dr Gore's works include *The Incarnation* (Bampton Lectures, 1891), *The Creed of the Christian* (1895), *The Body of Christ* (1901), *The New Theology and the Old Religion* (1908), and expositions of *The Sermon on the Mount* (1896), *Ephesians* (1898), and *Romans* (1899), while in 1910 he published *Orders and Unity*.

GORGE. (1) (O. Eng. *gor*, dung or filth), a word formerly used in the sense of dirt, but now confined to blood that has thickened after being shed. (2) (O. Eng. *gāra*, probably connected with *gare*, an old word for "spear"), something of triangular shape, resembling therefore a spear-head. The word is used for a tapering strip of land, in the "common or open field" system of agriculture, where from the shape of the land the acre or half-acre strips could not be portioned out in straight divisions. Similarly "gore" is used in the United States, especially in Maine and Vermont, for a strip of land left out in surveying when divisions are made and boundaries marked. The triangular sections of material used in forming the covering of a balloon or an umbrella are also called "gores," and in dressmaking the term is used for a triangular piece of material inserted in a dress to adjust the difference in widths. To gore, i.e. to stab or pierce with any sharp instrument, but more particularly used of piercing with the horns of a bull, is probably directly connected with *gore*, a spear.

GORÉE, an island off the west coast of Africa, forming part of the French colony of Senegal. It lies at the entrance of the large natural harbour formed by the peninsula of Cape Verde. The island, some 900 yds. long by 330 broad, and 3 m. distant from the nearest point of the mainland, is mostly barren rock. The greater part of its surface is occupied by a town, formerly a thriving commercial entrepôt and a strong military post. Until 1906 it was a free port. With the rise of Dakar (q.v.), c. 1860, on the adjacent coast, Gorée lost its trade and its inhabitants, mostly Jolofs, had dwindled in 1905 to about 1500. Its healthy climate, however, makes it useful as a sanatorium. The streets are narrow, and the houses, mainly built of dark-red stone, are flat-roofed. The castle of St Michael, the governor's residence, the hospital and barracks, testify to the former importance of the town. Within the castle is an artesian well, the only water-supply, save that collected in rain tanks, on the island. Gorée was first occupied by the Dutch, who took possession of it early in the 17th century and called it Goeree or Goede-reede, in memory of the island on their own coast now united with Overflakkee. Its native name is Bir, i.e. a belly, in allusion to its shape. It was captured by the English under Commodore (afterwards Admiral Sir Robert) Holmes in 1663, but retaken in the following year by de Ruyster. The Dutch were finally expelled in 1677 by the French under Admiral d'Estrees. Gorée subsequently fell again into the hands of the English, but was definitely occupied by France in 1817 (see SENEGAL: *History*).

GORGE, strictly the French word for the throat considered externally. Hence it is applied in falconry to a hawk's crop,

and thus, with the sense of something greedy or ravenous, to food given to a hawk and to the contents of a hawk's crop or stomach. It is from this sense that the expression of a person's "gorge rising at" anything in the sense of loathing or disgust is derived. "Gorge" from analogy with "throat," is used with the meaning of a narrow opening as of a ravine or valley between hills; in fortification, of the neck of an outwork or bastion; and in architecture, of the narrow part of a Roman Doric column, between the echinus and the astragal. From "gorge" also comes a diminutive "gorget," a portion of a woman's costume in the middle ages, being a close form of wimple covering the neck and upper part of the breast, and also that part of the body armour covering the neck and collar-bone (see GORGET). The word "gorgeous," of splendid or magnificent appearance, comes from the O. Fr. *gorgias*, with the same meaning, and has very doubtfully been connected with gorge, a ruffie or neck-covering, of a supposed elaborate kind.

GÖRGEI, ARTHUR (1818—), Hungarian soldier, was born at Toporc, in Upper Hungary, on the 30th of January 1818. He came of a Saxon noble family who were converts to Protestantism. In 1837 he entered the Bodyguard of Hungarian Nobles at Vienna, where he combined military service with a course of study at the university. In 1845, on the death of his father, he retired from the army and devoted himself to the study of chemistry at Prague, after which he retired to the family estates in Hungary. On the outbreak of the revolutionary war of 1848, Görgei offered his sword to the Hungarian government. Entering the Honvéd army with the rank of captain, he was employed in the purchase of arms, and soon became major and commandant of the national guards north of the Theiss. Whilst he was engaged in preventing the Croatian army from crossing the Danube, at the island of Csepel, below Pest, the wealthy Hungarian magnate Count Eugene Zichy fell into his hands, and Görgei caused him to be arraigned before a court-martial on a charge of treason and immediately hanged. After various successes over the Croatian forces, of which the most remarkable was that at Ozora, where 10,000 prisoners fell into his hands, Görgei was appointed commander of the army of the Upper Danube, but, on the advance of Prince Windischgrätz across the Leitha, he resolved to fall back, and in spite of the remonstrances of Kossuth he held to his resolution and retreated upon Waitzen. Here, irritated by what he considered undue interference with his plans, he issued (January 5th, 1849) a proclamation throwing the blame for the recent want of success upon the government, thus virtually revolting against their authority. Görgei retired to the Hungarian Erzgebirge and conducted operations on his own initiative. Meanwhile the supreme command had been conferred upon the Pole Dembinski, but the latter fought without success the battle of Kopolna, at which action Görgei's corps arrived too late to take an effective part, and some time after this the command was again conferred upon Görgei. The campaign in the spring of 1849 was brilliantly conducted by him, and in a series of engagements, he defeated Windischgrätz. In April he won the victories of Gödöllő, Isaszeg and Nagy Sarló, relieved Komorn, and again won a battle at Acs or Waitzen. Had he followed up his successes by taking the offensive against the Austrian frontier, he might perhaps have dictated terms in the Austrian capital itself. As it was, he contented himself with reducing Ofen, the Hungarian capital, in which he desired to re-establish the diet, and after effecting this capture he remained inactive for some weeks. Meanwhile, at a diet held at Debreczin, Kossuth had formally proposed the dethronement of the Habsburg dynasty and Hungary had been proclaimed a republic. Görgei had refused the field-marshal's bâton offered him by Kossuth and was by no means in sympathy with the new régime. However, he accepted the portfolio of minister of war, while retaining the command of the troops in the field. The Russians had now intervened in the struggle and made common cause with the Austrians; the allies were advancing into Hungary on all sides, and Görgei was defeated by Haynau at Pered (20th-21st of June). Kossuth, perceiving

the impossibility of continuing the struggle and being unwilling himself to make terms, resigned his position as dictator, and was succeeded by Görgei, who meanwhile had been fighting hard against the various columns of the enemy. Görgei, convinced that he could not break through the enemy's lines, surrendered, with his army of 20,000 infantry and 2000 cavalry, to the Russian general Rüdiger at Vilagos. Görgei was not court-martialled, as were his generals, but kept in confinement at Klagenfurt, where he lived, chiefly employed in chemical work, until 1867, when he was pardoned and returned to Hungary. The surrender, and particularly the fact that his life was spared while his generals and many of his officers and men were hanged or shot, led, perhaps naturally, to his being accused of treason by public opinion of his countrymen. After his release he played no further part in public life. Even in 1885 an attempt which was made by a large number of his old comrades to rehabilitate him was not favourably received in Hungary. After some years' work as a railway engineer he retired to Visegrád, where he lived thenceforward in retreat. (See also HUNGARY: History.)

General Görgei wrote a justification of his operations (*Mein Leben und Wirken in Ungarn 1848-1859*, Leipzig, 1852), an anonymous paper under the title *Was verdanken wir der Revolution?* (1875), and a reply to Kossuth's charges (signed "Joh. Demár") in *Budapesti Szemle*, 1881, 25-26. Amongst those who wrote in his favour were Captain Stephan Görgei (1848 & 1849 *bbl*, Budapest, 1885), and Colonel Aschermann (*Ein offenes Wort in der Sache des Honvéd-Generals Arthur Görgei*, Klausenburg, 1867).

See also A. G. Horn, *Görgei, Oberkommandant d. ung. Armee* (Leipzig, 1850); Kinsey, *Görgei's Life and Work in Hungary* (London, 1853); Sainay, in *Magyar 1848* (ii. 1378); Hentaller, *Görgei as a Statesman* (Hungarian); Elemár, *Görgei in 1848-1849* (Hungarian, Budapest, 1886).

GORGES, SIR FERDINANDO (c. 1566-1647), English colonial pioneer in America and the founder of Maine, was born in Somersetshire, England, probably in 1566. From youth both a soldier and a sailor, he was a prisoner in Spain at the age of twenty-one, having been captured by a ship of the Spanish Armada. In 1589 he was in command of a small body of troops fighting for Henry IV. of France, and after distinguishing himself at the siege of Rouen was knighted there in 1591. In 1596 he was commissioned captain and keeper of the castle and fort at Plymouth and captain of St Nicholas Isle; in 1597 he accompanied Essex on the expedition to the Azores; in 1599 assisted him in the attempt to suppress the Tyrone rebellion in Ireland, and in 1600 was implicated in Essex's own attempt at rebellion in London. In 1603, on the accession of James I., he was suspended from his post at Plymouth, but was restored in the same year and continued to serve as "governor of the forts and island of Plymouth" until 1629, when, his garrison having been without pay for three and a half years, his fort a ruin, and all his applications for aid having been ignored, he resigned. About 1605 he began to be greatly interested in the New World; in 1606 he became a member of the Plymouth Company, and he laboured zealously for the founding of the Popham colony at the mouth of the Sagadahoc (now the Kennebec) river in 1607. For several years following the failure of that enterprise in 1608 he continued to fit out ships for fishing, trading and exploring, with colonization as the chief end in view. He was largely instrumental in procuring the new charter of 1620 for the Plymouth Company, and was at all times of its existence perhaps the most influential member of that body. He was the recipient, either solely or jointly, of several grants of territory from it, for one of which he received in 1639 the royal charter of Maine (see MAINE). In 1635 he sought to be appointed governor-general of all New England, but the English Civil War—in which he espoused the royal cause—prevented him from ever actually holding that office. A short time before his death at Long Ashton in 1647 he wrote his *Briefve Narration of the Original Undertakings of the Advancement of Plantations into the Parts of America*. He was an advocate, especially late in life, of the feudal type of colony.

See J. P. Baxter (ed.), *Sir Ferdinando Gorges and his Province of Maine* (3 vols., Boston, 1890; in the Prince Society Publications), the first volume of which is a memoir of Gorges, and the other volumes contain a reprint of the *Briefve Narration*, Gorges's letters, and other documentary material.

GORGET (O. Fr. *gorgete*, dim. of *gorge*, throat), the name applied after about 1480 to the collar-piece of a suit of armour. It was generally formed of small overlapping rings of plate, and attached either to the body armour or to the armet. It was worn in the 16th and 17th centuries with the half-armour, with the plain cuirass, and even occasionally without any body armour at all. During these times it gradually became a distinctive badge for officers, and as such it survived in several armies—in the form of a small metal plate affixed to the front of the collar of the uniform coat—until after the Napoleonic wars. In the German army to-day a gorget-plate of this sort is the distinctive mark of military police, while the former officer's gorget is represented in British uniforms by the red patches or tabs worn on the collar by staff officers and by the white patches of the midshipmen in the Royal Navy.

GORGAS (c. 483–375 B.C.), Greek sophist and rhetorician, was a native of Leontini in Sicily. In 427 he was sent by his fellow-citizens at the head of an embassy to ask Athenian protection against the aggression of the Syracusans. He subsequently settled in Athens, and supported himself by the practice of oratory and by teaching rhetoric. He died at Larissa in Thessaly. His chief claim to recognition consists in the fact that he transplanted rhetoric to Greece, and contributed to the diffusion of the Attic dialect as the language of literary prose. He was the author of a lost work *On Nature or the Non-existent* (*Περὶ τοῦ μὴ ὄντος ἢ περὶ φθούρας*, fragments edited by M. C. Valetton, 1876), the substance of which may be gathered from the writings of Sextus Empiricus, and also from the treatise (ascribed to Theophrastus) *De Melisso, Xenophane, Gorgia*. Gorgias is the central figure in the Platonic dialogue *Gorgias*. The genuineness of two rhetorical exercises (*The Encomium of Helen* and *The Defence of Palamedes*, edited with Antiphon by F. Blass in the Teubner series, 1881), which have come down under his name, is disputed.

For his philosophical opinions see SOPHISTS and SCEPTICISM. See also *Compend. Greek Thinkers*, Eng. trans. vol. i. bk. iii. chap. vii.; Jebb's *Attic Orators*, introd. to vol. i. (1893); F. Blass, *Die attische Beredsamkeit*, i. (1887); and article RHETORIC.

GORGON, GORGONS (Gr. *Γοργώ, Γοργόνες*, the "terrible," or, according to some, the "loud-roaring"), a figure or figures in Greek mythology. Homer speaks of only one Gorgon, whose head is represented in the *Iliad* (v. 741) as fixed in the centre of the aegis of Zeus. In the *Odyssey* (xi. 633) she is a monster of the under-world. Hesiod increases the number of Gorgons to three—Stheno (the mighty), Euryale (the far-springer) and Medusa (the queen), and makes them the daughters of the sea-god Phorcys and of Keto. Their home is on the farthest side of the western ocean; according to later authorities, in Libya (Hesiod, *Theog.* 274; Herodotus ii. 91; Pausanias ii. 21). The Attic tradition, reproduced in Euripides (*Iow* 1002), regarded the Gorgon as a monster, produced by Gaea to aid her sons the giants against the gods and slain by Athena (the passage is a *locus classicus* on the aegis of Athena).

The Gorgons are represented as winged creatures, having the form of young women; their hair consists of snakes; they are round-faced, flat-nosed, with tongues lolling out and large projecting teeth. Sometimes they have wings of gold, brazen claws and the tusks of boars. Medusa was the only one of the three who was mortal; hence Perseus was able to kill her by cutting off her head. From the blood that spurted from her neck sprang Chrysaor and Pegasus, her two sons by Poseidon. The head, which had the power of turning into stone all who looked upon it, was given to Athena, who placed it in her shield; according to another account, Perseus buried it in the marketplace of Argos. The hideously grotesque original type of the Gorgoneion, as the Gorgon's head was called, was placed on the walls of cities, and on shields and breastplates to terrify an enemy (cf. the hideous faces on Chinese soldiers' shields), and used

generally as an amulet, a protection against the evil eye. Heracles is said to have obtained a lock of Medusa's hair (which possessed the same powers as the head) from Athena and given it to Sterope, the daughter of Cepheus, as a protection for the town of Tegea against attack (Apollodorus ii. 7. 3). According to Roscher, it was supposed, when exposed to view, to bring on a storm, which put the enemy to flight. Frazer (*Golden Bough*, i. 378) gives examples of the superstition that cut hair caused storms. According to the later idea of Medusa as a beautiful maiden, whose hair had been changed into snakes by Athena, the head was represented in works of art with a wonderfully handsome face, wrapped in the calm repose of death. The Rondanini Medusa at Munich is a famous specimen of this conception. Various accounts of the Gorgons were given by later ancient writers. According to Diod. Sic. (iii. 54. 55) they were female warriors living near Lake Tritonis in Libya, whose queen was Medusa; according to Alexander of Myndus, quoted in Athenaeus (v. p. 221), they were terrible wild animals whose mere look turned men to stone. Pliny (*Nat. Hist.* vi. 36 [31]) describes them as savage women, whose persons were covered with hair, which gave rise to the story of their snake hair and girdle. Modern authorities have explained them as the personification of the waves of the sea or of the barren, unproductive coast of Libya; or as the awful darkness of the storm-cloud, which comes from the west and is scattered by the sun-god Perseus. More recent is the explanation of anthropologists that Medusa, whose virtue is really in her head, is derived from the ritual mask common to primitive cults.

See Jane E. Harrison, *Prolegomena to the Study of Greek Religion* (1903); W. H. Roscher, *Die Gorgonen und Verwandtes* (1879); J. Six, *De Gorgone* (1885), on the types of the Gorgon's head; articles by Roscher and Furtwängler in Roscher's *Lexikon der Mythologie*, by G. Glotz in Daremberg and Saglio's *Dictionnaire des antiquités*, and by R. Gädchens in Ersch and Gruber's *Allgemeine Encyclopädie*; N. G. Politis ('Ο περὶ τῶν Γοργόνων μύθος κατά τῆς Ἐλληνικῆς ἀνάγ. 1878) gives an account of the Gorgons, and of the various superstitions connected with them, from the modern Greek point of view, which regards them as malevolent spirits of the sea.

GORGONZOLA, a town of Lombardy, Italy, in the province of Milan, from which it is 11 m. E.N.E. by steam tramway. Pop. (1901) 5134. It is the centre of the district in which is produced the well-known Gorgonzola cheese.

GORI, a town of Russian Transcaucasia, in the government of Tiflis and 40 m. by rail N.W. of the city of Tiflis, on the river Kura; altitude, 3010 ft. Pop. (1897) 10,457. The surrounding country is very picturesque. Gori has a high school for girls, and a school for Russian and Tatar teachers. At one time celebrated for its silk and cotton stuffs, it is now famous for corn, reputed the best in Georgia, and the wine is also esteemed. The climate is excellent, delightfully cool in summer, owing to the refreshing breezes from the mountains, though these are, however, at times disagreeable in winter. Gori was founded (1123) by the Georgian king David II., the Renovator, for the Armenians who fled their country on the Persian invasion. The earliest remains of the fortress are Byzantine; it was thoroughly restored in 1634–1658, but destroyed by Nadir Shah of Persia in the 18th century. There is a church constructed in the 17th century by Capuchin missionaries from Rome. Five miles east of Gori is the remarkable rock-cut town of Uplis-tyshki, which was a fortress in the time of Alexander the Great of Macedon, and an inhabited city in the reign of the Georgian king Bagrat III. (980–1014).

GORILLA (or *Powgo*), the largest of the man-like apes; and a native of West Africa from the Congo to Cameroon, whence it extends eastwards across the continent to German East Africa. Many naturalists regard the gorilla as best included in the same genus as the chimpanzee, in which case it should be known as *Australopithecus gorilla*, but by others it is regarded as the representative of a genus by itself, when its title will be *Gorilla sswagei*, or *G. gorilla*. That there are local forms of gorilla is quite certain; but whether any of these are entitled to rank as distinct species may be a matter of opinion. It was long supposed that the apes encountered on an island off the west coast of Africa by Hanno, the Carthaginian, were gorillas, but in the

opinion of some of those best qualified to judge, it is probable that the creatures in question were really baboons. The first real account of the gorilla appears to be the one given by an English sailor, Andrew Battel, who spent some time in the wilds of West Africa during and about the year 1590; his account being presented in Purchas's *Pilgrimage*, published in the year 1613. From this it appears that Battel was familiar with both the chimpanzee and the gorilla, the former of which he terms *engeco* and the latter *pongo*—names which ought apparently to be adopted for these two species in place of those now in use. Between Battel's time and 1846 nothing appears to have been heard of the gorilla or pongo, but in that year a missionary at the Gabun accidentally discovered a skull of the huge ape; and in 1847 a sketch of that specimen, together with two others, came into the hands of Sir R. Owen, by whom the name *Gorilla ssvagei* was proposed for the new ape in 1848. Dr Thomas Savage, a missionary at the Gabun, who sent Owen information with regard to the original skull, had, however, himself proposed the name *Trogodytes gorilla* in 1847. The first complete skeleton of a gorilla sent to Europe was received at the museum of the Royal College of Surgeons in 1851, and the first complete skin appears to have reached the British Museum in 1858. Paul-B. du Chaillu's account (1861) of his journeys in the Gabun region popularized the knowledge of the existence of the gorilla. Male gorillas largely exceed the females in size, and attain a height of from 5½ ft. to 6½ ft., or perhaps even more. Some of the features distinguishing the gorilla from the mere gorilla-like chimpanzees will be found mentioned in the article PRIMATES. Among them are the small ears, elongated head, the presence of a deep groove alongside the nostrils, the small size of the thumb, and the great length of the arm, which reaches half-way down the shin-bone (tibia) in the erect posture. In old males the eyes are overhung by a beetling penthouse of bone, the hinder half of the middle line of the skull bears a wall-like bony ridge for the attachment of the powerful jaw-muscles, and the tusks, or canines, are of monstrous size, recalling those of a carnivorous animal. The general colour is blackish, with a more or less marked grey or brownish tinge on the hair of the shoulders, and sometimes of chestnut on the head. Mr G. L. Bates (in *Proc. Zool. Soc.*, 1905, vol. i.) states that gorillas only leave the depths of the forest to enter the outlying clearings in the neighbourhood of human settlements when they are attracted by some special fruit or succulent plant; the favourite being the fruit of the "mejom," a tall cane-like plant (perhaps a kind of *Amomum*) which grows abundantly on deserted clearings. At one isolated village the natives, who were unarmed, reported that they not unfrequently saw and heard the gorillas, which broke down the stalks of the plantains in the rear of the habitations to tear out and eat the tender heart. On the old clearings of another village Mr Bates himself, although he did not see a gorilla, saw the fresh tracks of these great apes and the torn stems and discarded fruit rinds of the "mejoms," as well as the broken stalks of the latter, which had been used for beds. On another occasion he came across the bed of an old gorilla which had been used only the night before, as was proved by a negro woman, who on the previous evening had heard the animal breaking and treading down the stalks to form its couch. According to native report, the gorillas sleep on these beds, which are of sufficient thickness to raise them a foot or two above the ground, in a sitting posture, with the head inclined forwards on the breast. In the first case Mr Bates states that the tracks and beds indicated the presence of three or four gorillas, some of which were small. This account does not by any means accord with one given by von Koppenfels, in which it is stated that while the old male gorilla sleeps in a sitting posture at the base of a tree-trunk (no mention being made of a bed), the female and young ones pass the night in a nest in the tree several yards above the ground, made by bending the boughs together and covering them with twigs and moss. Mr Bates's account, as being based on actual inspection of the beds, is probably the more trustworthy. Even when asleep and snoring, gorillas are difficult to approach, since they awake at the slightest rustle, and an attempt to surround the one heard

making his bed by the woman resulted in failure. Most gorillas killed by natives are believed by Mr Bates to have been encountered suddenly in the daytime on the ground or in low trees in the outlying clearings. Many natives, even if armed, refuse, however, to molest an adult male gorilla, on account of its ferocity when wounded. Mr Bates, like Mr Winwood Reade, refused to credit du Chaillu's account of his having killed gorillas, and stated that the only instance he knew of one of these animals being slain by a European was an old male (now in Mr Walter Rothschild's museum at Tring) shot by the German trader Paschen in the Yaunde district, of which an illustrated account was published in 1901. Mr E. J. Corns states, however, that two European traders, apparently in the "eighties" of the 19th century, were in the habit of surrounding and capturing these animals as occasion offered.¹ Fully adult gorillas have never been seen alive in captivity—and perhaps never will be, as the creature is ferocious and morose to a degree. So long ago as the year 1855, when the species was known to zoologists only by its skeleton, a gorilla was actually living in England. This animal, a young female, came from the Gabun, and was kept for some months in Wombwell's travelling menagerie, where it was treated as a pet. On its death, the body was sent to Mr Charles Waterton, of Walton Hall, by whom the skin was mounted in a grotesque manner, and the skeleton given to the Leeds museum. Apparently, however, it was not till several years later that the skin was recognized by Mr A. D. Bartlett as that of a gorilla; the animal having probably been regarded by its owner as a chimpanzee. A young male was purchased by the Zoological Society in October 1887, from Mr Cross, the Liverpool dealer in animals. At the time of arrival it was supposed to be about three years old, and stood 2½ ft. high. A second, a male, supposed to be rather older, was acquired in March 1896, having been brought to Liverpool from the French Congo. It is described as having been thoroughly healthy at the date of its arrival, and of an amiable and tractable disposition. Neither survived long. Two others were received in the Zoological Society's menagerie in 1904, and another was housed there for a short time in the following year, while a fifth was received in 1906. Falkenstein's gorilla, exhibited at the Westminster aquarium under the name of pongo, and afterwards at the Berlin aquarium, survived for eighteen months. "Passi," the gorilla of the Breslau Zoological Gardens, holds a record for longevity, with over seven years of menagerie life. Writing in 1903 Mr W. T. Hornaday stated that but one live gorilla, and that a tiny infant, had ever landed in the United States; and it lived only five days after arrival. (R. L. *)

GORINCHEM, or **GORCUM**, a fortified town of Holland in the province of south Holland, on the right bank of the Merwede at the confluence of the Linge, 16 m. by rail W. of Dordrecht. It is connected by the Zederik and Merwede canals with Amsterdam, and steamers ply hence in every direction. Pop. (1900) 11,987. Gorinchem possesses several interesting old houses, and overlooking the river are some fortified gateways of the 17th century. The principal buildings are the old church of St Vincent, containing the monuments of the lords of Arkel; the town hall, a prison, custom-house, barracks and a military hospital. The charitable and benevolent institutions are numerous, and there are also a library and several learned associations. Gorinchem possesses a good harbour, and besides working in gold and silver, carries on a considerable trade in grain, hemp, cheese, potatoes, cattle and fish, the salmon fishery being noted. Woerkum, or Woudrichem, a little below the town on the left bank of the Merwede, is famous for its quaint old buildings, which are decorated with mosaics.

GORING, **GEORGE GORING**, Lord (1608–1657), English Royalist soldier, son of George Goring, earl of Norwich, was born on the 14th of July 1608. He soon became famous at court for his prodigality and dissolute manners. His father-in-law, Richard Boyle, earl of Cork, procured for him a post in the Dutch

¹ In 1905 the Rev. Geo. Grenfell reported that he had that summer shot a gorilla in the Bwela country, east of the Mongala affluent of the Congo.

army with the rank of colonel. He was permanently lame by a wound received at Breda in 1637, and returned to England early in 1639, when he was made governor of Portsmouth. He served in the Scottish war, and already had a considerable reputation when he was concerned in the "Army Plot." Officers of the army stationed at York proposed to petition the king and parliament for the maintenance of the royal authority. A second party was in favour of more violent measures, and Goring, in the hope of being appointed lieutenant-general, proposed to march the army on London and overawe the parliament during Strafford's trial. This proposition being rejected by his fellow officers, he betrayed the proceedings to Mountjoy Blount, earl of Newport, who passed on the information indirectly to Pym in April. Colonel Goring was thereupon called on to give evidence before the Commons, who commended him for his services to the Commonwealth. This betrayal of his comrades induced confidence in the minds of the parliamentary leaders, who sent him back to his Portsmouth command. Nevertheless he declared for the king in August. He surrendered Portsmouth to the parliament in September 1642 and went to Holland to recruit for the Royalist army, returning to England in December. Appointed to a cavalry command by the earl of Newcastle, he defeated Fairfax at Searcroft Moor near Leeds in March 1643, but in May he was taken prisoner at Wakefield on the capture of the town by Fairfax. In April 1644 he effected an exchange. At Marston Moor he commanded the Royalist left, and charged with great success, but, allowing his troops to disperse in search of plunder, was routed by Cromwell at the close of the battle. In November 1644, on his father's elevation to the earldom of Norwich, he became Lord Goring. The parliamentary authorities, however, refused to recognize the creation of the earldom, and continued to speak of the father as Lord Goring and the son as General Goring. In August he had been despatched by Prince Rupert, who recognized his ability, to join Charles in the south, and in spite of his disolute and insubordinate character he was appointed to supersede Henry, Lord Wilmot, as lieutenant-general of the Royalist horse (see GREAT REBELLION). He secured some successes in the west, and in January 1645 advanced through Hampshire and occupied Farnham; but want of money compelled him to retreat to Salisbury and thence to Exeter. The excesses committed by his troops seriously injured the Royalist cause, and his exactions made his name hated throughout the west. He had himself prepared to besiege Taunton in March, yet when in the next month he was desired by Prince Charles, who was at Bristol, to send reinforcements to Sir Richard Grenville for the siege of Taunton, he obeyed the order only with ill-humour. Later in the month he was summoned with his troops to the relief of the king at Oxford. Lord Goring had long been intriguing for an independent command, and he now secured from the king what was practically supreme authority in the west. It was alleged by the earl of Newport that he was willing to transfer his allegiance once more to the parliament. It is not likely that he meditated open treason, but he was culpably negligent and occupied with private ambitions and jealousies. He was still engaged in desultory operations against Taunton when the main campaign of 1645 opened. For the part taken by Goring's army in the operations of the Naseby campaign see GREAT REBELLION. After the decisive defeat of the king, the army of Fairfax marched into the west and defeated Goring in a disastrous fight at Langport on the 10th of July. He made no further serious resistance to the parliamentary general, but wasted his time in frivolous amusements, and in November he obtained leave to quit his disorganized forces and retire to France on the ground of health. His father's services secured him the command of some English regiments in the Spanish service. He died at Madrid in July or August 1657. Clarendon gives him a very unpleasing character, declaring that "Goring . . . would, without hesitation, have broken any trust, or done any act of treachery to have satisfied an ordinary passion or appetite; and in truth wanted nothing but industry (for he had wit, and courage, and understanding and ambition, uncontrolled by any

fear of God or man) to have been as eminent and successful in the highest attempt of wickedness as any man in the age he lived in or before. Of all his qualifications dissimulation was his masterpiece; in which he so much excelled, that men were not ordinarily ashamed, or out of countenance, with being deceived but twice by him."

See the life by C. H. Firth in the *Dictionary of National Biography*; Dugdale's *Baronage*, where there are some doubtful stories of his life in Spain; the *Clarendon State Papers*; Clarendon's *History of the Great Rebellion*; and S. R. Gardiner's *History of the Great Civil War*.

GORKEI, MAXIM (1868-), the pen-name of the Russian novelist Alexei Maximovich Pleshkov, who was born at Nizhni-Novgorod on the 26th of March 1868. His father was a dyer, but he lost both his parents in childhood, and in his ninth year was sent to assist in a boot-shop. We find him afterwards in a variety of callings, but devouring books of all sorts greedily, whenever they fell into his hands. He ran away from the boot-shop and went to help a land-surveyor. He was then a cook on board a steamer and afterwards a gardener. In his fifteenth year he tried to enter a school at Kazan, but was obliged to betake himself again to his drudgery. He became a baker, than hawked about *kras*, and helped the barefooted tramps and labourers at the docks. From these he drew some of his most striking pictures, and learned to give sketches of humble life generally with the fidelity of a Defoe. After a long course of drudgery he had the good fortune to obtain the place of secretary to a barrister at Nizhni-Novgorod. This was the turning-point of his fortunes, as he found a sympathetic master who helped him. He also became acquainted with the novelist Korolenko, who assisted him in his literary efforts. His first story was *Makar Chudra*, which was published in the journal *Katka*. He contributed to many periodicals and finally attracted attention by his tale called *Chelkash*, which appeared in *Russkoe Bogatstvo* ("Russian wealth"). This was followed by a series of tales in which he drew with extraordinary vigour the life of the *bozniki*, or tramps. He has sometimes described other classes of society, tradesmen and the educated classes, but not with equal success. There are some vigorous pictures, however, of the trading class in his *Poma Gordenyev*. But his favourite type is the rebel, the man in revolt against society, and him he describes from personal knowledge, and enlists our sympathies with him. We get such a type completely in *Konovodov*. Gorki is always preaching that we must have ideals—something better than everyday life, and this view is brought out in his play *At the Lowest Depths*, which had great success at Moscow, but was coldly received at St Petersburg.

For a good criticism of Gorki see *Ideas and Realities in Russian Literature*, by Prince Kropotkin. Many of his works have been translated into English.

GÖRLITZ, a town of Germany, in the Prussian province of Silesia, on the left bank of the Neisse, 62 m. E. from Dresden on the railway to Breslau, and at the junction of lines to Berlin, Zittau and Halle. Pop. (1885) 55,702, (1905) 80,931. The Neisse at this point is crossed by a railway bridge 1650 ft. long and 120 ft. high, with 32 arches. Görlitz is one of the handsomest, and, owing to the extensive forests of 70,000 acres, which are the property of the municipality, one of the wealthiest towns in Germany. It is surrounded by beautiful walks and fine gardens, and although its old walls and towers have now been demolished, many of its ancient buildings remain to form a picturesque contrast with the signs of modern industry. From the hill called Landakrone, about 1500 ft. high, an extensive prospect is obtained of the surrounding country. The principal buildings are the fine Gothic church of St Peter and St Paul, dating from the 15th century, with two stately towers, a famous organ and a very heavy bell; the Frauen Kirche, erected about the end of the 15th century, and possessing a fine portal and choir in pierced work; the Kloster Kirche, restored in 1868, with handsome choir stalls and a carved altar dating from 1383; and the Roman Catholic church, founded in 1853, in the Roman style of architecture, with beautiful glass windows and oil-paintings. The old town hall (Rathaus) contains a very valuable library, having at its entrance a fine flight of steps. There is

also a new town hall which was erected in 1904-1906. Other buildings are: the old bastion, named Kaisertrutz, now used as a guardhouse and armoury; the gymnasium buildings in the Gothic style erected in 1851; the Ruhmeshalle with the Kaiser Friedrich museum, the house of the estates of the province (Ständehaus), two theatres and the barracks. Near the town is the chapel of the Holy Cross, where there is a model of the Holy Sepulchre at Jerusalem made during the 15th century. In the public park there is a bust of Schiller, a monument to Alexander von Humboldt, and a statue of the mystic Jakob Böhme (1575-1624); a monument has been erected in the town in commemoration of the war of 1870-71, and also one to the emperor William I. and a statue of Prince Frederick Charles. In connexion with the natural history society there is a valuable museum, and the scientific institute possesses a large library and a rich collection of antiquities, coins and articles of *virtu*. Görlitz, next to Breslau, is the largest and most flourishing commercial town of Silesia, and is also regarded as classic ground for the study of German Renaissance architecture. Besides cloth, which forms its staple article of commerce, it has manufacturing of various linen and woollen wares, machines, railway wagons, glass, sago, tobacco, leather, chemicals and tiles.

Görlitz existed as a village from a very early period, and at the beginning of the 12th century received civic rights. It was then known as Drebenau, but on being rebuilt after its destruction by fire in 1131 it received the name of Zgorzelice. About the end of the 12th century it was strongly fortified, and for a short time it was the capital of a duchy of Görlitz. It was several times besieged and taken during the Thirty Years' War, and it also suffered considerably in the Seven Years' War. In the battle which took place near it between the Austrians and Prussians on the 7th of September 1757, Hans Karl von Winterfeldt, the general of Frederick the Great, was slain. In 1815 the town, with the greater part of Upper Lusatia, came into the possession of Prussia.

See Neumann, *Geschichte von Görlitz* (1850).

GÖRRES, JOHANN JOSEPH VON (1776-1848), German writer, was born on the 25th of January 1776, at Coblenz. His father was a man of moderate means, who sent his son to a Latin college under the direction of the Roman Catholic clergy. The sympathies of the young Görres were from the first strongly with the French Revolution, and the dissoluteness and irreligion of the French exiles in the Rhineland confirmed him in his hatred of princes. He harangued the revolutionary clubs, and insisted on the unity of interests which should ally all civilized states to one another. He then commenced a republican journal called *Das rote Blatt*, and afterwards *Rübezahl*, in which he strongly condemned the administration of the Rhenish provinces by France.

After the peace of Campo Formio (1797) there was some hope that the Rhenish provinces would be constituted into an independent republic. In 1799 the provinces sent an embassy, of which Görres was a member, to Paris to put their case before the directory. The embassy reached Paris on the 20th of November 1799; two days before this Napoleon had assumed the supreme direction of affairs. After much delay the embassy was received by him; but the only answer they obtained was "that they might rely on perfect justice, and that the French government would never lose sight of their wants." Görres on his return published a tract called *Resolute meiner Sendung nach Paris*, in which he reviewed the history of the French Revolution. During the thirteen years of Napoleon's dominion Görres lived a retired life, devoting himself chiefly to art or science. In 1801 he married Catherine de Lasaulx, and was for some years teacher at a secondary school in Coblenz; in 1806 he moved to Heidelberg, where he lectured at the university. As a leading member of the Heidelberg Romantic group, he edited together with K. Brentano and L. von Arnim the famous *Zeitung für Einsiedler* (subsequently re-named *Tröst-Einsiedler*), and in 1807 he published *Die deutschen Volksbücher*. He returned to Coblenz in 1808, and again found occupation as a teacher in a secondary school, supported by civic funds. He now studied Persian, and

in two years published a *Mythengeschichte der asiatischen Welt*,

which was followed ten years later by *Das Heldenbuch von Iran*, a translation of part of the *Shahname*, the epic of Firdousi. In 1813 he actively took up the cause of national independence, and in the following year founded *Der rheinische Merkur*. The intense earnestness of the paper, the bold outspokenness of its hostility to Napoleon, and its fiery eloquence secured for it almost instantly a position and influence unique in the history of German newspapers. Napoleon himself called it *le cinquième puissance*. The ideal it insisted on was a united Germany, with a representative government, but under an emperor after the fashion of other days,—for Görres now abandoned his early advocacy of republicanism. When Napoleon was at Elba, Görres wrote an imaginary proclamation issued by him to the people, the intense irony of which was so well veiled that many Frenchmen mistook it for an original utterance of the emperor. He inveighed bitterly against the second peace of Paris (1815), declaring that Alsace and Lorraine should have been demanded back from France.

Stein was glad enough to use the *Merkur* at the time of the meeting of the congress of Vienna as a vehicle for giving expression to his hopes. But Hardenberg, in May 1815, warned Görres to remember that he was not to arouse hostility against France, but only against Bonaparte. There was also in the *Merkur* an antipathy to Prussia, a continual expression of the desire that an Austrian prince should assume the imperial title, and also a tendency to pronounced liberalism—all of which made it most distasteful to Hardenberg, and to his master King Frederick William III. Görres disregarded warnings sent to him by the censorship and continued the paper in all its fierceness. Accordingly it was suppressed early in 1816, at the instance of the Prussian government; and soon after Görres was dismissed from his post as teacher at Coblenz. From this time his writings were his sole means of support, and he became a most diligent political pamphleteer. In the wild excitement which followed Kptzebue's assassination, the reactionary decrees of Carlsbad were framed, and these were the subject of Görres's celebrated pamphlet *Teutschland und die Revolution* (1820). In this work he reviewed the circumstances which had led to the murder of Kotzebue, and, while expressing all possible horror at the deed itself, he urged that it was impossible and undesirable to repress the free utterance of public opinion by reactionary measures. The success of the work was very marked, despite its ponderous style. It was suppressed by the Prussian government, and orders were issued for the arrest of Görres and the seizure of his papers. He escaped to Strassburg, and thence went to Switzerland. Two more political tracts, *Europa und die Revolution* (1821) and *In Sachen der Rheinprovinzen und in eigener Angelegenheit* (1822), also deserve mention.

In Görres's pamphlet *Die heilige Allianz und die Völker auf dem Kongress zu Verona* he asserted that the princes had met together to crush the liberties of the people, and that the people must look elsewhere for help. The "elsewhere" was to Rome; and from this time Görres became a vehement Ultramontane writer. He was summoned to Munich by King Ludwig of Bavaria as Professor of History in the university, and there his writing enjoyed very great popularity. His *Christliche Mystik* (1836-1842) gave a series of biographies of the saints, together with an exposition of Roman Catholic mysticism. But his most celebrated ultramontane work was a polemical one. Its occasion was the deposition and imprisonment by the Prussian government of the archbishop Clement Wencelaus, in consequence of the refusal of that prelate to sanction in certain instances the marriages of Protestants and Roman Catholics. Görres in his *Athanasius* (1837) fiercely upheld the power of the church, although the liberals of later date who have claimed Görres as one of their own school deny that he ever insisted on the absolute supremacy of Rome. *Athanasius* went through several editions, and originated a long and bitter controversy. In the *Historisch-politische Blätter*, a Munich journal, Görres and his son Guido (1805-1852) continually upheld the claims of the church. Görres received from the king the order of merit for his services. He died on the 29th of January 1848.

Görres's Gesammelte Schriften (only his political writings) appeared in six volumes (1854-1860), to which three volumes of *Gesammelte Briefe* were subsequently added (1858-1874). Cp. J. Galland, *Joseph von Görres* (1876, 2nd ed. 1877); J. N. Sepp, *Görres und seine Zeitgenossen* (1877), and by the same author, *Görres, in der seine Geisteswelt* (1896). A *Görres-Gesellschaft* was founded in 1876.

GORSAS, ANTOINE JOSEPH (1752-1793), French publicist and politician, was born at Limoges (Haute-Vienne) on the 24th of March 1752, the son of a shoemaker. He established himself as a private tutor in Paris, and presently set up a school for the army at Versailles, which was attended by commoners as well as nobles. In 1781 he was imprisoned for a short time in the Bicêtre on an accusation of corrupting the morals of his pupils, his real offence being the writing of satirical verse. These circumstances explain the violence of his anti-monarchical sentiment. At the opening of the states-general he began to publish the *Courrier de Versailles et de Paris et de Versailles*, in which appeared on the 4th of October 1789 the account of the banquet of the royal bodyguard. Gorsas is said to have himself read it in public at the Palais Royal, and to have headed one of the columns that marched on Versailles. He then changed the name of his paper to the *Courrier des quatre-vingt-trois départements*, continuing his incendiary propaganda, which had no small share in provoking the popular insurrections of June and August 1792. During the September massacres he wrote in his paper that the prisons were the centre of an anti-national conspiracy and that the people exercised a just vengeance on the guilty. On the 10th of September 1792 he was elected to the Convention for the department of Seine-et-Oise, and on the 10th of January 1793 was elected one of its secretaries. He sat at first with the Mountain, but having been long associated with Roland and Brissot, his agreement with the Girondists became gradually more pronounced; during the trial of Louis XVI. he disassociated himself more and more from the principles of the Mountain, and he voted for the king's detention during the war and subsequent banishment. A violent attack on Marat in the *Courrier* led to an armed raid on his printing establishment on the 9th of March 1793. The place was sacked, but Gorsas escaped the popular fury by flight. The facts being reported to the Convention, little sympathy was shown to Gorsas, and a resolution (which was evaded) was passed forbidding representatives to occupy themselves with journalism. On the 2nd of June he was ordered by the Convention to hold himself under arrest with other members of his party. He escaped to Normandy to join Buzot, and after the defeat of the Girondists at Facy-sur-Eure he found shelter in Brittany. He was imprudent enough to return to Paris in the autumn, where he was arrested on the 6th of October and guillotined the next day.

See the *Moniteur*, No. 268 (1792), Nos. 20, 70 new series 18 (1793); M. Tournoux, *Bibl. de l'Hist. de Paris*, 10, 291 seq. (1894).

GORST, SIR JOHN ELDON (1835-), English statesman, was born at Preston in 1835, the son of Edward Chaddock Gorst, who took the name of Lowndes on succeeding to the family estate in 1853. He graduated third wrangler from St John's College, Cambridge, in 1857, and was admitted to a fellowship. After beginning to read for the bar in London, his father's illness and death led to his sailing to New Zealand, where he married in 1860 Mary Elizabeth Moore. The Maoris had at that time set up a king of their own in the Waikato district and Gorst, who had made friends with the chief Tamihana (William Thomson), acted as an intermediary between the Maoris and the government. Sir George Grey made him inspector of schools, then resident magistrate, and eventually civil commissioner in Upper Waikato. Tamihana's influence secured his safety in the Maori outbreak of 1863. In 1868 he published a volume of recollections, under the title of *New Zealand Revisited: Recollections of the Days of my Youth*. He then returned to England and was called to the bar at the Inner Temple in 1865, becoming Q.C. in 1875. He stood unsuccessfully for Hastings in the Conservative interest in 1865, and next year entered parliament as member for the borough of Cambridge, but failed to secure re-election at the dissolution of 1868. After the Conservative defeat of that year he was entrusted by Disraeli

with the reorganization of the party machinery, and in five years of hard work he paved the way for the Conservative success at the general election of 1874. At a bye-election in 1875 he re-entered parliament as member for Chatham, which he continued to represent until 1892. He joined Sir Henry Drummond-Wolff, Lord Randolph Churchill and Mr Arthur Balfour in the "Fourth Party," and he became solicitor-general in the administration of 1885-1886 and was knighted. On the formation of the second Salisbury administration (1886) he became under-secretary for India and in 1891 financial secretary to the Treasury. At the general election of 1892 he became member for Cambridge University. He was deputy chairman of committees in the House of Commons from 1888 to 1891, and on the formation of the third Salisbury administration in 1895 he became vice-president of the committee of the council on education (until 1902). Sir John Gorst adhered to the principles of Tory democracy which he had advocated in the days of the fourth party, and continued to exhibit an active interest in the housing of the poor, the education and care of their children, and in social questions generally, both in parliament and in the press. But he was always exceedingly "independent" in his political action. He objected to Mr Chamberlain's proposals for tariff reform, and lost his seat at Cambridge at the general election of 1906 to a tariff reformer. He then withdrew from the vice-chancellorship of the Primrose League, of which he had been one of the founders, on the ground that it no longer represented the policy of Lord Beaconsfield. In 1910 he contested Preston as a Liberal, but failed to secure election.

His elder son, SIR J. ELDON GORST (b. 1861), was financial adviser to the Egyptian government from 1898 to 1904, when he became assistant under-secretary of state for foreign affairs. In 1907 he succeeded Lord Cromer as British agent and consul-general in Egypt.

An account of Sir John Gorst's connexion with Lord Randolph Churchill will be found in the *Fourth Party* (1906), by his younger son, Harold E. Gorst.

GORTON, SAMUEL (c. 1600-1677), English sectary and founder of the American sect of Gortonites, was born about 1600 at Gorton, Lancashire. He was first apprenticed to a clothier in London, but, fearing persecution for his religious convictions, he sailed for Boston, Massachusetts, in 1636. Constantly involved in religious disputes, he fled in turn to Plymouth, and (in 1637-1638) to Aquidneck (Newport), where he was publicly whipped for insulting the clergy and magistrates. In 1643 he bought land from the Narraganset Indians at Shawomet—now Warwick—where he was joined by a number of his followers; but he quarrelled with the Indians and the authorities at Boston sent soldiers to arrest Gorton and six of his companions. He served a term of imprisonment for heresy at Charlestown, after which he was ejected from the colony. In England in 1646 he published the curious tract "Simplifications Defence against Seven Headed Policy" (reprinted in 1835), giving an account of his grievances against the Massachusetts government. In 1648 he returned to New England with a letter of protection from the earl of Warwick, and joining his former companions at Shawomet, which he named Warwick, in honour of the earl, he remained there till his death at the end of 1677. He is chiefly remembered as the founder of a small sect called the Gortonites, which survived till the end of the 18th century. They had a great contempt for the regular clergy and for all outward forms of religion, holding that the true believers partook of the perfection of God.

Among his quaint writings are: *An Inconspicible Key composed of the C.X. Psalms wherewith you may open the rest of the Scriptures* (1647), and *Saltmarsh returned from the Dead*, with its sequel, *An Antidote against the Common Plague of the World* (1657). See L. G. Jones, *Samuel Gorton: a forgotten Founder of our Liberties* (Providence, 1896).

GORTON, an urban district in the Gorton parliamentary division of Lancashire, England, forming an eastern suburb of Manchester. Pop. (1901) 26,564. It is largely a manufacturing district, having cotton mills and iron, engineering and chemical works.

GORTYNA, or **GORTYN**, an important ancient city on the southern side of the island of Crete. It stood on the banks of the small river Lethæus (Mitropolipotamo), about three hours distant from the sea, with which it communicated by means of its two harbours, Metallum and Lebena. It had temples of Apollo Pythius, Artemis and Zeus. Near the town was the famous fountain of Sauros, inclosed by fruit-bearing poplars; and not far from this was another spring, overhung by an evergreen plane tree which in popular belief marked the scene of the amours of Zeus and Europa. Gortyna was, next to Cnossus, the largest and most powerful city of Crete. The two cities combined to subdue the rest of the island; but when they had gained their object they quarrelled with each other, and the history of both towns is from this time little more than a record of their feuds. Neither plays a conspicuous part in the history of Greece. Under the Romans Gortyna became the metropolis of the island. Extensive ruins may still be seen at the modern village of Hagii Deka, and here was discovered the great inscription containing chapters of its ancient laws. Though partly ruinous, the church of St Titus is a very interesting monument of early Christian architecture, dating from about the 4th century.

See also **CRETE**, and for a full account of the laws see **GREEK LAW**.

GÖRTZ, **GEORG HEINRICH VON**, **BARON VON SCHLITZ** (1668-1719), Holstein statesman, was educated at Jena. He entered the Holstein-Gottorp service, and after the death of the duchess Hedwig Sophia, Charles XII.'s sister, became very influential during the minority of her son Duke Charles Frederick. His earlier policy aimed at strengthening Holstein-Gottorp at the expense of Denmark. With this object, during Charles XII.'s stay at Altranstädt (1706-1707), he tried to divert the king's attention to the Holstein question, and six years later, when the Swedish commander, Magnus Stenbock, crossed the Elbe, Görtz rendered him as much assistance as was compatible with not openly breaking with Denmark, even going so far as to surrender the fortress of Tönning to the Swedes. Görtz next attempted to undermine the grand alliance against Sweden by negotiating with Russia, Prussia and Saxony for the purpose of isolating Denmark, or even of turning the arms of the allies against her, a task by no means impossible in view of the strained relations between Denmark and the tsar. The plan foundered, however, on the refusal of Charles XII. to save the rest of his German domains by ceding Stettin to Prussia. Another simultaneous plan of procuring the Swedish crown for Duke Charles Frederick also came to nought. Görtz first suggested the marriage between the duke of Holstein and the tsarevna Anne of Russia, and negotiations were begun in St Petersburg with that object. On the arrival of Charles XII. from Turkey at Stralsund, Görtz was the first to visit him, and emerged from his presence chief minister or "grand-vizier" as the Swedes preferred to call the bold and crafty satrap, whose absolute devotion to the Swedish king took no account of the intense wretchedness of the Swedish nation. Görtz, himself a man of uncommon audacity, seems to have been fascinated by the heroic element in Charles's nature and was determined, if possible, to save him from his difficulties. He owed his extraordinary influence to the fact that he was the only one of Charles's advisers who believed, or pretended to believe, that Sweden was still far from exhaustion, or at any rate had a sufficient reserve of power to give support to an energetic diplomacy—Charles's own opinion, in fact. Görtz's position, however, was highly peculiar. Ostensibly, he was only the Holstein minister at Charles's court, in reality he was everything in Sweden except a Swedish subject—finance minister, plenipotentiary to foreign powers, factotum, and responsible to the king alone, though he had not a line of instructions. But he was just the man for a hero in extremities, and his whole course of procedure was, of necessity, revolutionary. His chief financial expedient was to debase, or rather ruin, the currency by issuing copper tokens redeemable in better times; but it was no fault of his that Charles XII., during his absence, flung upon the market too enormous an amount of this copper money for Görtz to deal

with. By the end of 1718 it seemed as if Görtz's system could not go on much longer, and the hatred of the Swedes towards him was so intense and universal that they blamed him for Charles XII.'s tyranny as well as for his own. Görtz hoped, however, to conclude peace with at least some of Sweden's numerous enemies before the crash came and then, by means of fresh combinations, to restore Sweden to her rank as a great power. It must be admitted that, in pursuance of his "system," Görtz displayed a genius for diplomacy which would have done honour to a Metternich or a Talleyrand. He desired peace with Russia first of all, and at the congress of Åland even obtained relatively favourable terms, only to have them rejected by his obstinately optimistic master. Simultaneously, Görtz was negotiating with Cardinal Alberoni and with the whigs in England; but all his ingenious combinations collapsed like a house of cards on the sudden death of Charles XII. The whole fury of the Swedish nation instantly fell upon Görtz. After a trial before a special commission which was a parody of justice—the accused was not permitted to have any legal assistance or the use of writing materials—he was condemned to decapitation and promptly executed. Perhaps Görtz deserved his fate for "unnecessarily making himself the tool of an unheard-of despotism," but his death was certainly a judicial murder, and some historians even regard him as a political martyr.

See R. N. Bain, *Charles XII.* (London, 1895), and *Scandinavia*, chap. 12 (Cambridge, 1905); B. von Beskow, *Fürst von Görtz* (Stockholm, 1868). (R. N. B.)

GÖRZ (Ital. *Gorizia*; Slovene, *Gorica*), the capital of the Austrian crownland of Görz and Gradisca, about 300 m. S.W. of Vienna by rail. Pop (1900) 25,432, two-thirds Italians, the remainder mostly Slovenes and Germans. It is picturesquely situated on the left bank of the Isonzo in a fertile valley, 35 m. N.N.W. of Trieste by rail. It is the seat of an archbishop and possesses an interesting cathedral, built in the 14th century and the richly decorated church of St Ignatius, built in the 17th century by the Jesuits. On an eminence, which dominates the town, is situated the old castle, formerly the seat of the counts of Görz, now partly used as barracks. Owing to the mildness of its climate Görz has become a favourite winter-resort, and has received the name of the Nice of Austria. Its mean annual temperature is 55° F.; while the mean winter temperature is 38.7° F. It is adorned with several pretty gardens with a luxuriant southern vegetation. On a height to the N. of the town is situated the Franciscan convent of Castagnavizza, in whose chapel lie the remains of Charles X. of France (d. 1836), the last Bourbon king, of the duke of Angoulême (d. 1844), his son, and of the duke of Chambord (d. 1883). Seven miles to the north of Görz is the Monte Santo (2275 ft.), a much-frequented place on which stands a pilgrimage church. The industries include cotton and silk weaving, sugar refining, brewing, the manufacture of leather and the making of rosoglio. There is also a considerable trade in wooden work, vegetables, early fruit and wine. Görz is mentioned for the first time at the beginning of the 11th century, and received its charter as a town in 1307. During the middle ages the greater part of its population was German.

GÖRZ AND GRADISCA, a county and crownland of Austria, bounded E. by Carniola, S. by Istria, the Triestine territory and the Adriatic, W. by Italy and N. by Carinthia. It has an area of 1140 sq. m. The coast line, though extending for 25 m., does not present any harbour of importance. It is fringed by alluvial deposits and lagoons, which are for the most part of very modern formation, for as late as the 4th or 5th centuries Aquileia was a great seaport. The harbour of Grado is the only one accessible to the larger kind of coasting craft. On all sides, except towards the south-west where it unites with the Friulian lowland, it is surrounded by mountains, and about four-sixths of its area is occupied by mountains and hills. From the Julian Alps, which traverse the province in the north, the country descends in successive terraces towards the sea, and may roughly be divided into the upper highlands, the lower highlands, the hilly district and the lowlands. The principal peaks in the

Julian Alps are the Monte Canin (8469 ft.), the Manhart (8784 ft.), the Jalouc (8708 ft.), the Ern (7367 ft.), the Matajur (5386 ft.), and the highest peak in the whole range, the Triglav or Terglou (9394 ft.). The Julian Alps are crossed by the Predil Pass (3811 ft.), through which passes the principal road from Carinthia to the Coastland. The southern part of the province belongs to the Karst region, and here are situated the famous cascades and grottoes of Sankt Kanzian, where the river Reka begins its subterranean course. The principal river of the province is the Isonzo, which rises in the Triglav, and pursues a strange zigzag course for a distance of 78 m. before it reaches the Adriatic. At Görz the Isonzo is still 138 ft. above the sea, and it is navigable only in its lowest section, where it takes the name of the Sdöbba. Its principal affluents are the Idria, the Wippach and the Torre with its tributary the Judrio, which forms for a short distance the boundary between Austria and Italy. Of special interest not only in itself but for the frequent allusions to it in classical literature is the Timavus or Timavo, which appears near Duino, and after a very short course flows into the Gulf of Trieste. In ancient times it used, according to the well-known description of Virgil (*Æn.* i. 244) to have rushed from the mountain by nine separate mouths and with much noise and commotion, but at present it usually issues from only three mouths and flows quiet and still. It is strange enough, however, to see the river coming out full formed from the rock, and capable at its very source of bearing vessels on its bosom. According to a probable hypothesis it is a continuation of the above-mentioned river Reka, which is lost near Sankt Kanzian.

Agriculture, and specially viticulture, is the principal occupation of the population, and the vine is here planted not only in regular vineyards, but is introduced in long lines through the ordinary fields and carried up the hills in terraces locally called *ronchi*. The rearing of the silk-worm, especially in the lowlands, constitutes another great source of revenue, and furnishes the material for the only extensive industry of the country. The manufacture of silk is carried on at Görz, and in and around the village of Haldenschaft. Görz and Gradisca had in 1900 a population of 232,338, which is equivalent to 203 inhabitants per square mile. According to nationality about two-thirds were Slovenes, and the remainder Italians, with only about 2200 Germans. Almost the whole of the population (99.6%) belongs to the Roman Catholic Church. The local diet, of which the archbishop of Görz is a member *ex-officio*, is composed of 22 members, and the crownland sends 5 deputies to the Reichsrat at Vienna. For administrative purposes the province is divided into 4 districts and an autonomous municipality, Görz (pop. 25,432), the capital. Other principal places are Cormons (5824), Monfalcone (5536), Kirchheim (5699), Gradisca (3843) and Aquileia (2319).

Görz first appears distinctly in history about the close of the 10th century, as part of a district bestowed by the emperor Otto III. on John, patriarch of Aquileia. In the 11th century it became the seat of the Eppenstein family, who frequently bore the title of counts of Gorizia; and in the beginning of the 12th century the countship passed from them to the Lurngau family which continued to exist till the year 1500, and acquired possessions in Tirol, Carinthia, Friuli and Styria. On the death of Count Leonhard (12th April 1500) the fief reverted to the house of Habsburg. The countship of Gradisca was united with it in 1754. The province was occupied by the French in 1809, but reverted again to Austria in 1815. It formed a district of the administrative province of Trieste until 1861, when it became a separate crownland under its actual name.

GOSCHEN, GEORGE JOACHIM GOSCHEN, 1st Viscount (1831-1907), British statesman, son of William Henry Goschen, a London merchant of German extraction, was born in London on the 10th of August 1831. He was educated at Rugby under Dr Tait, and at Oriol College, Oxford, where he took a first-class in classics. He entered his father's firm of Fröhling & Göschen, of Austin Friars, in 1853, and three years later became a director of the Bank of England. His entry into public life

took place in 1863, when he was returned without opposition as member for the city of London in the Liberal interest, and this was followed by his re-election, at the head of the poll, in the general election of 1865. In November of the same year he was appointed vice-president of the Board of Trade and paymaster-general, and in January 1866 he was made chancellor of the duchy of Lancaster, with a seat in the cabinet. When Mr Gladstone became prime minister in December 1868, Mr Goschen joined the cabinet as president of the Poor Law Board, and continued to hold that office until March 1871, when he succeeded Mr Childers as first lord of the admiralty. In 1874 he was elected lord rector of the university of Aberdeen. Being sent to Cairo in 1876 as delegate for the British holders of Egyptian bonds, in order to arrange for the conversion of the debt, he succeeded in effecting an agreement with the Khedive.

In 1878 his views upon the county franchise question prevented him from voting uniformly with his party, and he informed his constituents in the city that he would not stand again at the forthcoming general election. In 1880 he was elected for Ripon, and continued to represent that constituency until the general election of 1885, when he was returned for the Eastern Division of Edinburgh. Being opposed to the extension of the franchise, he was unable to join Mr Gladstone's government in 1880; declining the post of viceroy of India, he accepted that of special ambassador to the Porte, and was successful in settling the Montenegrin and Greek frontier questions in 1880 and 1881. He was made ecclesiastical commissioner in 1882, and when Sir Henry Brand was raised to the peerage in 1884, the speakership of the House of Commons was offered to him, but declined. During the parliament of 1880-1885 he frequently found himself unable to concur with his party, especially as regards the extension of the franchise and questions of foreign policy; and when Mr Gladstone adopted the policy of Home Rule for Ireland, Mr Goschen followed Lord Hartington (afterwards duke of Devonshire) and became one of the most active of the Liberal Unionists. His vigorous and eloquent opposition to Mr Gladstone's Home Rule Bill of 1886 brought him into greater public prominence than ever, but he failed to retain his seat for Edinburgh at the election in July of that year. On the resignation of Lord Randolph Churchill in December 1886, Mr Goschen, though a Liberal Unionist, accepted Lord Salisbury's invitation to join his ministry, and became chancellor of the exchequer. Being defeated at Liverpool, 26th of January 1887, by seven votes, he was elected for St George's, Hanover Square, on the 9th of February. His chancellorship of the exchequer during the ministry of 1886 to 1892 was rendered memorable by his successful conversion of the National Debt in 1888 (see NATIONAL DEBT). With that financial operation, under which the new 2½% Consols became known as "Goschens," his name will long be connected. Aberdeen University again conferred upon him the honour of the lord rectorship in 1888, and he received a similar honour from the University of Edinburgh in 1890. In the Unionist opposition of 1893 to 1895 Mr Goschen again took a vigorous part, his speeches both in and out of the House of Commons being remarkable for their eloquence and debating power. From 1895 to 1900 Mr Goschen was first lord of the admiralty, and in that office he earned the highest reputation for his businesslike grasp of detail and his statesmanlike outlook on the naval policy of the country. He retired in 1900, and was raised to the peerage by the title of Viscount Goschen of Hawkhurst, Kent. Though retired from active politics he continued to take a great interest in public affairs; and when Mr Chamberlain started his tariff reform movement in 1903, Lord Goschen was one of the weightiest champions of free trade on the Unionist side. He died on the 7th of February 1907, being succeeded in the title by his son George Joachim (b. 1866), who was Conservative M.P. for East Grinstead from 1895 to 1900, and married a daughter of the 1st earl of Cranbrook.

In educational subjects Goschen had always taken the greatest interest, his best known, but by no means his only, contribution to popular culture being his participation in the University

Extension Movement; and his first efforts in parliament were devoted to advocating the abolition of religious tests and the admission of Dissenters to the universities. His published works indicate how ably he combined the wise study of economics with a practical instinct for business-like progress, without neglecting the more ideal aspects of human life. In addition to his well-known work on *The Theory of the Foreign Exchanges*, he published several financial and political pamphlets and addresses on educational and social subjects, among them being that on *Cultivation of the Imagination*, Liverpool, 1877, and that on *Intellectual Interest*, Aberdeen, 1888. He also wrote *The Life and Times of Georg Joachim Goschen, publisher and printer of Leipzig* (1903). (H. CH.)

GOS-HAWK, i.e. goose-hawk, the *Astur palumbarius* of ornithologists, and the largest of the short-winged hawks used in falconry. Its English name, however, has possibly been transferred to this species from one of the long-winged hawks or true falcons, since there is no tradition of the gos-hawk, now so called, having ever been used in Europe to take geese or other large and powerful birds. The genus *Astur* may be readily distinguished from *Falco* by the smooth edges of its beak, its short wings (not reaching beyond about the middle of the tail), and its long legs and toes—though these last are stout and comparatively shorter than in the sparrow-hawks (*Accipiter*). In plumage the gos-hawk has a general resemblance to the peregrine falcon, and it undergoes a corresponding change as it advances from youth to maturity—the young being longitudinally streaked beneath, while the adults are transversely barred. The irides, however, are always yellow, or in old birds orange, while those of the falcons are dark brown. The sexes differ greatly in size. There can be little doubt that the gos-hawk, nowadays very rare in Britain, was once common in England, and even towards the end of the 18th century Thornton obtained a nestling in Scotland, while Irish gos-hawks were of old highly celebrated. Being strictly a woodland-bird, its disappearance may be safely connected with the disappearance of the ancient forests in Great Britain, though its destructiveness to poultry and pigeons has doubtless contributed to its present scarcity. In many parts of the continent of Europe it still abounds. It ranges eastward to China and is much valued in India. In North America it is represented by a very nearly allied species, *A. atricapillus*, chiefly distinguished by the closer barring of the breast. Three or four examples corresponding with this form have been obtained in Britain. A good many other species of *Astur* (some of them passing into *Accipiter*) are found in various parts of the world, but the only one that need here be mentioned is the *A. nosac-hollandiae* of Australia, which is remarkable for its dimorphism—one form possessing the normal dark-coloured plumage of the genus and the other being perfectly white, with crimson irides. Some writers hold these two forms to be distinct species and call the dark-coloured one *A. cinereus* or *A. raii*. (A. N.)

GOSHEN, a division of Egypt settled by the Israelites between Jacob's immigration and the Exodus. Its exact delimitation is a difficult problem. The name may possibly be of Semitic, or at least non-Egyptian origin, as in Palestine we meet with a district (Josh. x. 41) and a city (*ib. xv. 51*) of the same name. The Septuagint reads Γόσην Ἀραβίας in Gen. xiv. 10, and xvi. 34, elsewhere simply Γόσην. In xvi. 28 "Goshen . . . the land of Goshen" are translated respectively "Heroopolis . . . the land of Rameses." This represents a late Jewish identification. Ptolemy defines "Arabia" as an Egyptian nome on the eastern border of the delta, with capital Phacusa, corresponding to the Egyptian nome Sopt and town Kesem. It is doubtful whether Phacusa be situated at the mounds of Fakhis, or at another place, Saft-el-Henneh, which suits Strabo's description of its locality rather better. The extent of Goshen, according to the apocryphal book of Judith (i. 9, 10), included Tanis and Memphis; this is probably an overstatement. It is indeed impossible to say more than that it was a place of good pasture, on the frontier of Palestine, and fruitful in edible vegetables and in fish (Numbers xi. 5). (R. A. S. M.)

GOSHEN, a city and the county-seat of Elkhart county, Indiana, U.S.A., on the Elkhart river, about 95 m. E. by S. of Chicago, at an altitude of about 800 ft. Pop. (1890) 6033; (1900) 7810 (462 foreign-born); (1910) 8514. Goshen is served by the Cleveland, Cincinnati, Chicago & St. Louis, and the Lake Shore & Michigan Southern railways, and is connected by electric railway with Warsaw and South Bend. The city has a Carnegie library, and is the seat of Goshen College (under Mennonite control), chartered as Elkhart Institute, at Elkhart, Ind., in 1895, and removed to Goshen and opened under its present name in 1903. The college includes a collegiate department, an academy, a Bible school, a normal school, a summer school and correspondence courses, and schools of business, of music and of oratory, and in 1908-1909 had 331 students, 73 of whom were in the Academy. Goshen is situated in a good farming region and is an important lumber market. There is a good water-power. Among the city's manufactures are wagons and carriages, furniture, wooden-ware, veneering, sash and doors, ladders, lawn swings, rubber goods, flour, foundry products and agricultural machinery. The municipality owns its water works and its electric-lighting system. Goshen was first settled in 1828 and was first chartered as a city in 1868.

GOSLAR, a town of Germany, in the Prussian province of Hanover, romantically situated on the Gose, an affluent of the Oker, at the north foot of the Harz, 24 m. S.E. of Hildesheim and 31 m. S.W. from Brunswick, by rail. Pop. (1905) 17,817. It is surrounded by walls and is of antique appearance. Among the noteworthy buildings are the "Zwinger," a tower with walls 23 ft. thick; the market church, in the Romanesque style, restored since its partial destruction by fire in 1844, and containing the town archives and a library in which are some of Luther's manuscripts; the old town hall (Rathaus), possessing many interesting antiquities; the Kaiserworth (formerly the hall of the tailors' guild and now an inn) with the statues of eight of the German emperors; and the Kaiserhaus, the oldest secular building in Germany, built by the emperor Henry III. before 1050 and often the residence of his successors. This was restored in 1867-1878 at the cost of the Prussian government, and was adorned with frescoes portraying events in German history. Other buildings of interest are:—the small chapel which is all that remains since 1820 of the old and famous cathedral of St. Simon and St. Jude founded by Henry III. about 1040, containing among other relics of the cathedral an old altar supposed to be that of the idol Krodo which formerly stood on the Burgberg near Neustadt-Harzburg; the church of the former Benedictine monastery of St. Mary, or Neuwerk, of the 12th century, in the Romanesque style, with wall-paintings of considerable merit; and the house of the bakers' guild now an hotel, the birthplace of Marshal Saxe. There are four Evangelical churches, a Roman Catholic church, a synagogue, several schools, a natural science museum, containing a collection of Harz minerals, the Fenkner museum of antiquities and a number of small foundations. The town has equestrian statues of the emperor Frederick I. and of the German emperor William I. The population is chiefly occupied in connexion with the sulphur, copper, silver and other mines in the neighbourhood. The town has also been long noted for its beer, and possesses some small manufactures and a considerable trade in fruit.

Goslar is believed to have been founded by Henry the Fowler about 920, and when in the time of Otto the Great the mineral treasures in the neighbourhood were discovered it increased rapidly in prosperity. It was often the meeting-place of German diets, twenty-three of which are said to have been held here, and was frequently the residence of the emperors. About 1350 it joined the Hanseatic League. In the middle of the 14th century the famous *Goslar statutes*, a code of laws, which was adopted by many other towns, was published. The town was unsuccessfully besieged in 1625, during the Thirty Years' War, but was taken by the Swedes in 1632 and nearly destroyed by fire. Further conflagrations in 1728 and 1780 gave a severe blow to its prosperity. It was a free town till 1802, when it

came into the possession of Prussia. In 1807 it was joined to Westphalia, in 1816 to Hanover and in 1866 it was, along with Hanover, re-united to Prussia.

See T. Erdmann, *Die alte Kaiserstadt Goslar und ihre Umgebung in Geschichte, Sage und Bild* (Goslar, 1892); *Crusius, Geschichte der normals kaiserlichen freien Reichstadt Goslar* (1842-1843); A. Wollstieg, *Verfassungsgeschichte von Goslar* (Berlin, 1885); T. Anche, *Die Kaiserpfalz zu Goslar* (1892); Neuburg, *Goslar's Bergbau bis 1552* (Hanover, 1892); and the *Urkundenbuch der Stadt Goslar*, edited by G. Bode (Halle, 1893-1900). For the *Goslarische Statuten* see the edition published by Cöchehen (Berlin, 1840).

GOSLICKI, WAWRZYŃCIEC (? 1533-1607), Polish bishop, better known under his Latinized name of Laurentius Grimalius Goslicius, was born about 1533. After having studied at Cracow and Padua, he entered the church, and was successively appointed bishop of Kamizietz and of Posen. Goslicki was an active man of business, was held in high estimation by his contemporaries and was frequently engaged in political affairs. It was chiefly through his influence, and through the letter he wrote to the pope against the Jesuits, that they were prevented from establishing their schools at Cracow. He was also a strenuous advocate of religious toleration in Poland. He died on the 31st of October 1607.

His principal work is *De optimo senatore*, &c. (Venice, 1568). There are two English translations published respectively under the titles *A commonwealth of good counsaile*, &c. (1607), and *The Accomplished Senuar, done into English by Mr Oldisworth* (1733).

GOSLIN, or GAULINUS (d. c. 886), bishop of Paris and defender of the city against the Northmen (885), was, according to some authorities, the son of Roricon II., count of Maine, according to others the natural son of the emperor Louis I. In 848 he became a monk, and entered a monastery at Reims, later he became abbot of St Denis. Like most of the prelates of his time he took a prominent part in the struggle against the Northmen, by whom he and his brother Louis were taken prisoners (858), and he was released only after paying a heavy ransom (*Prudentii Trecentis episcopi Annales*, ann. 858). From 855 to 867 he held intermittently, and from 867 to 881 regularly, the office of chancellor to Charles the Bald and his successors. In 883 or 884 he was elected bishop of Paris, and foreseeing the dangers to which the city was to be exposed from the attacks of the Northmen, he planned and directed the strengthening of the defences, though he also relied for security on the merits of the relics of St Germain and St Geneviève. When the attack finally came (885), the defence of the city was entrusted to him and to Odo, count of Paris, and Hugh, abbot of St Germain l'Auxerrois. The city was attacked on the 26th of November, and the struggle for the possession of the bridge (now the Pont-au-Change) lasted for two days, but Goslin repaired the destruction of the wooden tower overnight, and the Normans were obliged to give up the attempt to take the city by storm. The siege lasted for about a year longer, while the emperor Charles the Fat was in Italy. Goslin died soon after the preliminaries of the peace had been agreed on, worn out by his exertions, or killed by a pestilence which raged in the city.

See Amaury Duval, *L'Evêque Goslin ou le siège de Paris par les Normands, chronique du IX^e siècle* (2 vols., Paris, 1832, 3rd ed. ib. 1835).

GOSNOLD, BARTHOLOMEW (d. 1607), English navigator. Nothing is known of his birth, parentage or early life. In 1602, in command of the "Concord," chartered by Sir Walter Raleigh and others, he crossed the Atlantic; coasted from what is now Maine to Martha's Vineyard, landing at and naming Cape Cod and Elizabeth Island (now Cuttyhunk) and giving the name Martha's Vineyard to the island now called No Man's Land; and returned to England with a cargo of furs, sassafras and other commodities obtained in trade with the Indians about Buzard's Bay. In London he actively promoted the colonization of the regions he had visited and, by arousing the interest of Sir Ferdinando Gorges and other influential persons, contributed toward securing the grants of the charters to the London and Plymouth Companies in 1606. In 1606-1607 he was associated with Christopher Newport in command of the three vessels by which the first Jamestown colonists were carried to Virginia.

As a member of the council he took an active share in the affairs of the colony, ably seconding the efforts of John Smith to introduce order, industry and system among the motley array of adventurers and idle "gentlemen" of which the little band was composed. He died from swamp fever on the 22nd of August 1607.

See *The Works of John Smith* (Arber's Edition, London, 1884); and J. M. Brexeton, *Brief and True Relation of the North Part of Virginia* (reprinted by B. F. Stevens, London, 1901), an account of Gosnold's voyage of 1602.

GOSPATRIC (fl. 1067), earl of Northumberland, belonged to a family which had connections with the royal houses both of Wessex and Scotland. Before the Conquest he accompanied Tostig on a pilgrimage to Rome (1061); and at that time was a landholder in Cumberland. About 1067 he bought the earldom of Northumberland from William the Conqueror; but, repenting of his submission, fled with other Englishmen to the court of Scotland (1068). He joined the Danish army of invasion in the next year; but was afterwards able, from his possession of Bamburgh castle, to make terms with the conqueror, who left him undisturbed till 1072. The peace concluded in that year with Scotland left him at William's mercy. He lost his earldom and took refuge in Scotland, where Malcolm seems to have provided for him.

See E. A. Freeman, *Norman Conquest*, vol. i. (Oxford, 1877), and the *English Hist. Review*, vol. xix. (London, 1904).

GOSPEL (O. Eng. *godspel*, i. e. good news, a translation of Lat. *bona annuntiatio*, or *evangelium*, Gr. εὐαγγέλιον; cf. Goth. *is spillon*, "to announce good news," Ulfilas' translation of the Greek, from *eu*, that which is good, and *spellen* to announce), primarily the "glad tidings" announced to the world by Jesus Christ. The word thus came to be applied to the whole body of doctrine taught by Christ and his disciples, and so to the Christian revelation generally (see CHRISTIANITY); by analogy the term "gospel" is also used in other connexions as equivalent to "authoritative teaching." In a narrower sense each of the records of the life and teaching of Christ preserved in the writings of the four "evangelists" is described as a Gospel. The many more or less imaginative lives of Christ which are not accepted by the Christian Church as canonical are known as "apocryphal gospels" (see APOCRYPHAL LITERATURE). The present article is concerned solely with general considerations affecting the four canonical Gospels; see for details of each, the articles under MATTHEW, MARK, LUKE and JOHN.

The Four Gospels.—The disciples of Jesus proclaimed the Gospel that He was the Christ. Those to whom this message was first delivered in Jerusalem and Palestine had seen and heard Jesus, or had heard much about Him. They did not require to be told who He was. But more and more as the work of preaching and teaching extended to such as had not this knowledge, it became necessary to include in the Gospel delivered some account of the ministry of Jesus. Moreover, alike those who had followed Him during His life on earth, and all who joined themselves to them, must have felt the need of dwelling on His precepts, so that these must have been often repeated, and also in all probability from an early time grouped together according to their subjects, and so taught. For some time, probably for upwards of thirty years, both the facts of the life of Jesus and His words were only related orally. This would be in accordance with the habits of mind of the early preachers of the Gospel. Moreover, they were so absorbed in the expectation of the speedy return of Christ that they did not feel called to make provision for the instruction of subsequent generations. The Epistles of the New Testament contain no indications of the existence of any written record of the life and teaching of Christ. Tradition indicates A.D. 60-70 as the period when written accounts of the life and teaching of Jesus began to be made (see MARK, GOSPEL OF, and MATTHEW, GOSPEL OF). This may be accepted as highly probable. We cannot but suppose that at a time when the number of the original band of disciples of Jesus who survived must have been becoming noticeably smaller, and all these were advanced in life, the importance of writing down that which had been orally delivered concerning the Gospel-history must have been realized. We also

gather from Luke's preface (l. 1-4) that the work of writing was undertaken in these circumstances and under the influence of this feeling, and that various records had already in consequence been made.

But do our Gospels, or any of them, in the form in which we actually have them, belong to the number of those earliest records? Or, if not, what are the relations in which they severally stand to them? These are questions which in modern criticism have been greatly debated. With a view to obtaining answers to them, it is necessary to consider the reception of the Gospels in the early Church, and also to examine and compare the Gospels themselves. Some account of the evidence supplied in these two ways must be given in the present article, so far as it is common to all four Gospels, or to three or two of them, and in the articles on the several Gospels so far as it is especial to each.

1. *The Reception of the Gospels in the Early Church.*—The question of the use of the Gospels and of the manner in which they were regarded during the period extending from the latter years of the 1st century to the beginning of the last quarter of the 2nd is a difficult one. There is a lack of explicit references to the Gospels;¹ and many of the quotations which may be taken from them are not exact. At the same time these facts can be more or less satisfactorily accounted for by various circumstances. In the first place, it would be natural that the habits of thought of the period when the Gospel was delivered orally should have continued to exert influence even after the tradition had been committed to writing. Although documents might be known and used, they would not be regarded as the authorities for that which was independently remembered, and would not, therefore, necessarily be mentioned. Consequently, it is not strange that citations of sayings of Christ—and these are the only express citations in writings of the Subapostolic Age—should be made without the source whence they were derived being named, and (with a single exception) without any clear indication that the source was a document. The exception is in the little treatise commonly called the Epistle of Barnabas, probably composed about A.D. 130, where (c. iv. 14) the words "many are called but few chosen" are introduced by the formula "as it is written."

For the identification, therefore, of the source or sources used we have to rely upon the amount of correspondence with our Gospels in the quotations made, and in respect to other parallelisms of statement and of expression, in these early Christian writers. The correspondence is in the main full and true as regards spirit and substance, but it is rarely complete in form. The existence of some differences of language may, however, be too readily taken to disprove derivation. Various forms of the same saying occurring in different documents, or remembered from oral tradition and through catechetical instruction, would sometimes be purposely combined. Or, again, the memory might be confused by this variety, and the verification of quotations, especially of brief ones, was difficult, not only from the comparative scarcity of the copies of books, but also because ancient books were not provided with ready means of reference to particular passages. On the whole there is clearly a presumption that where we have striking expressions which are known to us besides only in one of our Gospel-records, that particular record has been the source of it. And where there are several such coincidences the ground for the supposition that the writing in question has been used may become very strong. There is evidence of this kind, more or less clear in the several cases, that all the four Gospels were known in the first two or three decades of the 2nd century. It is fullest as to our first Gospel and, next to this one, as to our third.

After this time it becomes manifest that, as we should expect, documents were the recognized authorities for the Gospel history; but there is still some uncertainty as to the documents upon which reliance was placed, and the precise estimation in which

¹ For the only two that can be held to be such in the first half of the 2nd century, and the doubts whether they refer to our present Gospels, see MARK, GOSPEL OF, and MATTHEW, GOSPEL OF.

they were severally held. This is in part at least due to the circumstance that nearly all the writings which have remained of the Christian literature belonging to the period *circa* A.D. 130-180 are addressed to non-Christians, and that for the most part they give only summaries of the teaching of Christ and of the facts of the Gospel, while terms that would not be understood by, and names that would not carry weight with, others than Christians are to a large extent avoided. The most important of the writings now in question are two by Justin Martyr (*circa* A.D. 145-160), viz. his *Apology* and his *Dialogue with Trypho*. In the former of these works he shows plainly his intention of adapting his language and reasoning to Gentile, and in the latter to Jewish, readers. In both his name for the Gospel-records is "Memoirs of the Apostles." After a great deal of controversy there has come to be very wide agreement that he reckoned the first three Gospels among these Memoirs. In the case of the second and third there are indications, though slight ones, that he held the view of their composition and authorship which was common from the last quarter of the century onwards (see MARK, GOSPEL OF, and LUKE, GOSPEL OF), but he has made the largest use of our first Gospel. It is also generally allowed that he was acquainted with the fourth Gospel, though some think that he used it with a certain reserve. Evidence may, however, be adduced which goes far to show that he regarded it, also, as of apostolic authority. There is a good deal of difference of opinion still as to whether Justin reckoned other sources for the Gospel-history besides our Gospels among the Apostolic Memoirs. In this connexion, however, as well as on other grounds, it is a significant fact that within twenty years or so after the death of Justin, which probably occurred *circa* A.D. 160, Tatian, who had been a hearer of Justin, produced a continuous narrative of the Gospel-history which received the name *Diatessaron* ("through four"), in the main a compilation from our four Gospels.¹

Before the close of the 2nd century the four Gospels had attained a position of unique authority throughout the greater part of the Church, not different from that which they have held since, as is evident from the treatise of Irenaeus *Against Heresies* (c. A.D. 180; see esp. iii. i. f. and x., xi.) and from other evidence only a few years later. The struggle against Gnosticism, which had been going on during the middle part of the century, had compelled the Church both to define her creed and to draw a sharper line of demarcation than heretofore between those writings whose authority she regarded as absolute and all others. The effect of this was no doubt to enhance the sense generally entertained of the value of the four Gospels. At the same time in the formal statements now made it is plainly implied that the belief expressed is no new one. And it is, indeed, difficult to suppose that agreement on this subject between different portions of the Church could have manifested itself at this time in the spontaneous manner that it does, except as the consequence of traditional feelings and convictions, which went back to the early part of the century, and which could hardly have arisen without good foundation, with respect to the special value of these works as embodiments of apostolic testimony, although all that came to be supposed in regard to their actual authorship cannot be considered proved.

2. *The Internal Criticism of the Gospels.*—In the middle of the 19th century an able school of critics, known as the Tübingen school, sought to show from indications in the several Gospels that they were composed well on in the 2nd century in the interests of various strongly marked parties into which the Church was supposed to have been divided by differences in regard to the Judaic and Pauline forms of Christianity. These theories are now discredited. It may on the contrary be confidently asserted with regard to the first three Gospels that the local colouring in them is predominantly Palestinian, and that they

¹ The character of Tatian's *Diatessaron* has been much disputed in the past, but there can no longer be any reasonable doubt on the subject after recent discoveries and investigations. (An account of these may be seen most conveniently in *The Diatessaron of Tatian*, by S. Hemphill; see under TATIAN.)

show no signs of acquaintance with the questions and the circumstances of the 2nd century; and that the character even of the Fourth Gospel is not such as to justify its being placed, at furthest, much after the beginning of that century.

We turn to the literary criticism of the Gospels, where solid results have been obtained. The first three Gospels have in consequence of the large amount of similarity between them in contents, arrangement, and even in words and the forms of sentences and paragraphs, been called Synoptic Gospels. It has long been seen that, to account for this similarity, relations of interdependence between them, or of common derivation, must be supposed. And the question as to the true theory of these relations is known as the *Synoptic Problem*. Reference has already been made to the fact that during the greater part of the Apostolic age the Gospel history was taught orally. Now some have held that the form of this oral teaching was to a great extent a fixed one, and that it was the common source of our first three Gospels. This oral theory was for a long time the favourite one in England; it was never widely held in Germany, and in recent years the majority of English students of the Synoptic Problem have come to feel that it does not satisfactorily explain the phenomena. Not only are the resemblances too close, and their character in part not of a kind, to be thus accounted for, but even many of the differences between parallel contexts are rather such as would arise through the revision of a document than through the freedom of oral delivery.

It is now and has for many years been widely held that a document which is most nearly represented by the Gospel of Mark, or which (as some would say) was virtually identical with it, has been used in the composition of our first and third Gospels. This source has supplied the Synoptic Outline, and in the main also the narratives common to all three. Questions connected with the history of this document are treated in the article on **MARK, GOSPEL OF**.

There is also a considerable amount of matter common to Matthew and Luke, but not found in Mark. It is introduced into the Synoptic Outline very differently in those two Gospels, which clearly suggests that it existed in a separate form, and was independently combined by the first and third evangelists with their other document. This common matter has also a character of its own; it consists mainly of pieces of discourse. The form in which it is given in the two Gospels is in several passages so nearly identical that we must suppose these pieces at least to have been derived immediately or ultimately from the same Greek document. In other cases there is more divergence, but in some of them this is accounted for by the consideration that in Matthew passages from the source now in question have been interwoven with parallels in the other chief common source before mentioned. There are, however, instances in which no such explanation will serve, and it is possible that our first and third evangelists may have used two documents which were not in all respects identical, but which corresponded very closely on the whole. The ultimate source of the subject matter in question, or of the most distinctive and larger part of it, was in all probability an Aramaic one, and in some parts different translations may have been used.

This second source used in the composition of Matthew and Luke has frequently been called "The Logia" in order to signify that it was a collection of the sayings and discourses of Jesus. This name has been suggested by Schleiermacher's interpretation of Papias' fragment on Matthew (see **MATTHEW, GOSPEL OF**). But some have maintained that the source in question also contained a good many narratives, and in order to avoid any premature assumption as to its contents and character several recent critics have named it "Q." It may, however, fairly be called "the Logian document," as a convenient way of indicating the character of the greater part of the matter which our first and third evangelists have taken from it, and this designation is used in the articles on the Gospels of Luke and Matthew. The reconstruction of this document has been attempted by several critics. The arrangement of its contents can, it seems, best be learned from Luke.

3. One or two remarks may here be added as to the bearing of the results of literary criticism upon the use of the Gospels. Their effect is to lead us, especially when engaged in historical inquiries, to look beyond our Gospels to their sources, instead of treating the testimony of the Gospels severally as independent and ultimate. Nevertheless it will still appear that each Gospel has its distinct value, both historically and in regard to the moral and spiritual instruction afforded. And the fruits of much of that older study of the Gospels, which was largely employed in pointing out the special characteristics of each, will still prove serviceable.

AUTHORITIES.—1. German Books: *Introductions to the New Testament*—H. J. Holtzmann (3rd ed., 1892), B. Weiss (Eng. trans., 1887), Th. Zahn (2nd ed., 1900), G. A. Jülicher (6th ed., 1906; Eng. trans., 1904); H. v. Soden, *Urchristliche Literaturgeschichte*, vol. i. (1905; Eng. trans., 1906). Books on the Synoptic Gospels, especially the Synoptic Problem: H. J. Holtzmann, *Die synoptischen Evangelien* (1863); Weizsäcker, *Untersuchungen über die evangelische Geschichte* (1864); B. Weiss, *Das Marcus-Evangelium und seine synoptischen Parallelen* (1872); *Das Matthäus-Evangelium und seine Lucas-Parallelen* (1876); H. H. Wendt, *Die Lehre Jesu* (1886); A. Resch, *Agrapha* (1889), &c.; P. Wernle, *Die synoptische Frage* (1899); W. Soltau, *Unsere Evangelien, ihre Quellen und ihr Quellenwert* (1901); H. J. Holtzmann, *Hand-Commentar zum N.T.*, vol. i. (1889); J. Wellhausen, *Das Evangelium Marci, Das Evangelium Matthäi, Das Evangelium Lucas* (1904), *Einführung in die drei ersten Evangelien* (1905); A. Harnack, *Sprüche und Reden Jesu, die zweite Quelle des Matthäus und Lukas* (1907).

2. French Books: A. Loisy, *Les Évangiles synoptiques* (1907-1908). 3. English Books: G. Salmon, *Introduction to the New Testament* (1st ed., 1885; 9th ed., 1904); W. Sanday, *Inspiration* (Lect. vi., 2d ed., 1903); B. F. Westcott, *An Introduction to the Study of the Gospels* (1st ed., 1851; 8th ed., 1895); A. Wright, *The Composition of the Four Gospels* (1890); J. E. Carpenter, *The First Three Gospels, their Origin and Relations* (1890); A. J. Jolley, *The Synoptic Problem* (1893); J. C. Hawkins, *Haræ synopticae* (1899); W. Alexander, *Leading Ideas of the Gospels* (new ed., 1892); E. A. Abbott, *Clue* (1900); J. A. Robinson, *The Study of the Gospels* (1902); F. C. Burkitt, *The Gospel History and its Transmission* (1906); G. Salmon, *The Human Element in the Gospels* (1907); V. H. Stanton, *The Gospels as Historical Documents: Pt. I., The Early Use of the Gospels* (1903); Pt. II., *The Synoptic Gospels* (1908).

4. Synopses.—W. G. Rushbrooke, *Synopticon, An Exposition of the Common Matter of the Synoptic Gospels* (1880); A. Wright, *The Synopsis of the Gospels in Greek* (2nd ed., 1903).

See also the articles on each Gospel, and the article **BIBLE**, section **New Testament**. (V. H. S.)

GOSPORT, a seaport in the Fareham parliamentary division of Hampshire, England, facing Portsmouth across Portsmouth harbour, 8½ m. S.W. from London by the London & South-Western railway. Pop. of urban district of Gosport and Alverstoke (1907), 28,884. A ferry and a floating bridge connect it with Portsmouth. It is enclosed within a double line of fortifications, consisting of the old Gosport lines, and, about 3000 yds. to the east, a series of forts connected by strong lines with occasional batteries, forming part of the defence works of Portsmouth harbour. The principal buildings are the town hall and market hall, and the church of Holy Trinity, erected in the time of William III. To the south at Haslar there is a magnificent naval hospital, capable of containing 2000 patients, and adjoining it a gunboat slipway and large barracks. To the north is the Royal Clarence victualling yard, with brewery, cooperage, powder magazines, biscuit-making establishment, and storehouses for various kinds of provisions for the royal navy.

Gosport (Goseporte, Gozport, Gosberg, Godspört) was originally included in Alverstoke manor, held in 1086 by the bishop and monks of Winchester under whom villains farmed the land. In 1284 the monks agreed to give up Alverstoke with Gosport to the bishop, whose successors continued to hold them until the lands were taken over by the ecclesiastical commissioners. After the confiscation of the bishop's lands in 1641, however, the manor of Alverstoke with Gosport was granted to George Withers, but reverted to the bishop at the Restoration. In the 16th century Gosport was "a little village of fishermen." It was called a borough in 1461, when there are also traces of burghage tenure. From 1462 one bailiff was elected annually in the borough court, and government by a balliff continued until 1682, when Gosport was included in Portsmouth borough

under the charter of Charles II. to that town. This was annulled in 1688, since which time there is no evidence of the election of bailiffs. With this exception no charter of incorporation is known, although by the 16th century the inhabitants held common property in the shape of tolls of the ferry. The importance of Gosport increased during the 16th and 17th centuries owing to its position at the mouth of Portsmouth harbour, and its convenience as a victualling station. For this reason also the town was particularly prosperous during the American and Peninsular Wars. About 1540 fortifications were built there for the defence of the harbour, and in the 17th century it was a garrison town under a lord-lieutenant.

GOSS, SIR JOHN (1800-1880), English composer, was born at Fareham, Hampshire, on the 27th of December 1800. He was elected a chorister of the Chapel Royal in 1811, and in 1816, on the breaking of his voice, became a pupil of Attwood. A few early compositions, some for the theatre, exist, and some glees were published before 1825. He was appointed organist of St Luke's, Chelsea, in 1824, and in 1838 became organist of St Paul's in succession to Attwood; he kept the post until 1872, when he resigned and was knighted. His position in the London musical world of the time was an influential one, and he did much by his teaching and criticism to encourage the study and appreciation of good music. In 1876 he was given the degree of Mus.D. at Cambridge. Though his few orchestral works have very small importance, his church music includes some fine compositions, such as the anthems "O taste and see," "O Saviour of the world" and others. He was the last of the great English school of church composers who devoted themselves almost exclusively to church music; and in the history of the glee his is an honoured name, if only on account of his finest work in that form, the five-part glee, Ossian's "Hymn to the sun." He died at Brixton, London, on the 10th of May 1880.

GOSSAMER, a fine, thread like and filmy substance spun by small spiders, which is seen covering stubble fields and gorse bushes, and floating in the air in clear weather; especially in the autumn. By transference anything light, unsubstantial or flimsy is known as "gossamer." A thin gauzy material used for trimming and millinery, resembling the "chiffon" of to-day, was formerly known as gossamer; and in the early Victorian period it was a term used in the hat trade for silk hats of very light weight.

The word is obscure in origin, it is found in numerous forms in English, and is apparently taken from *gese*, goose and *somere*, summer. The Germans have *Mädchensommer*, maidens' summer, and *Altwaisersommer*, old women's summer, as well as *Sommerfäden*, summer-threads, as equivalent to the English gossamer, the connexion apparently being that gossamer is seen most frequently in the warm days of late autumn (St Martin's summer) when geese are also in season. Another suggestion is that the word is a corruption of *gaze à Marie* (gauze of Mary) through the legend that gossamer was originally the threads which fell away from the Virgin's shroud on her assumption.

GOSSÉ, EDMUND (1840-), English poet and critic, was born in London on the 21st of September 1840, son of the zoologist P. H. Gosse. In 1867 he became an assistant in the department of printed books in the British Museum, where he remained until he became in 1875 translator to the Board of Trade. In 1904 he was appointed librarian to the House of Lords. In 1884-1890 he was Clark Lecturer in English literature at Trinity College, Cambridge. Himself a writer of literary verse of much grace, and master of a prose style admirably expressive of a wide and appreciative culture, he was conspicuous for his valuable work in bringing foreign literature home to English readers. *Northern Studies* (1879), a collection of essays on the literature of Holland and Scandinavia, was the outcome of a prolonged visit to those countries, and was followed by later work in the same direction. He translated Ibsen's *Hedda Gabler* (1891), and, with W. Archer, *The Master-BUILDER* (1893), and in 1907 he wrote a life of Ibsen for the "Literary Lives" series. He also edited the English translation of the works of Björnson.

His services to Scandinavian letters were acknowledged in 1901, when he was made a knight of the Norwegian order of St Olaf of the first class. Mr Gosse's published volumes of verse include *On Viol and Flute* (1873), *King Erik* (1876), *New Poems* (1879), *Firdausi in Exile* (1885), *In Russel and Silver* (1894), *Collected Poems* (1896). *Hypolympia, or the Gods on the Island* (1901), an "ironic phantasy," the scene of which is laid in the 20th century, though the personages are Greek gods, is written in prose, with some blank verse. His *Seventeenth Century Studies* (1883), *Life of William Congreve* (1888), *The Jacobean Poets* (1894), *Life and Letters of Dr John Donne, Dean of St Paul's* (1899), *Jeremy Taylor* (1904, "English Men of Letters"), and *Life of Sir Thomas Browne* (1905) form a very considerable body of critical work on the English 17th-century writers. He also wrote a life of Thomas Gray, whose works he edited (4 vols., 1884); *A History of Eighteenth Century Literature* (1889); *A History of Modern English Literature* (1897), and vols. iii. and iv. of an *Illustrated Record of English Literature* (1903-1904) undertaken in connexion with Dr Richard Garnett. Mr Gosse was always a sympathetic student of the younger school of French and Belgian writers, some of his papers on the subject being collected as *French Profiles* (1905). *Critical K&Kats* (1896) contains an admirable criticism of J. M. de Heredia, reminiscences of Lord de Tabley and others. He edited Heinemann's series of "Literature of the World" and the same publisher's "International Library." To the 9th edition of the *Encyclopædia Britannica* he contributed numerous articles, and his services as chief literary adviser in the preparation of the 10th and 11th editions incidentally testify to the high position held by him in the contemporary world of letters. In 1905 he was entertained in Paris by the leading *littérateurs* as a representative of English literary culture. In 1907 Mr Gosse published anonymously *Father and Son*, an intimate study of his own early family life. He married Ellen, daughter of Dr G. W. Epos, and had a son and two daughters.

GOSSE, PHILIP HENRY (1810-1888), English naturalist, was born at Worcester on the 6th of April 1810, his father, Thomas Gosse (1765-1844) being a miniature painter. In his youth the family settled at Poole, where Gosse's turn for natural history was noticed and encouraged by his aunt, Mrs Bell, the mother of the zoologist, Thomas Bell (1799-1880). He had, however, little opportunity for developing it until, in 1827, he found himself clerk in a whaler's office at Carbonear, in Newfoundland, where he beguiled the tedium of his life by observations, chiefly with the microscope. After a brief and unsuccessful interlude of farming in Canada, during which he wrote an unpublished work on the entomology of Newfoundland, he travelled in the United States, was received and noticed by men of science; was employed as a teacher for some time in Alabama, and returned to England in 1839. His *Canadian Naturalist* (1840), written on the voyage home, was followed in 1843 by his *Introduction to Zoology*. His first widely popular book was *The Ocean* (1844). In 1844 Gosse, who had meanwhile been teaching in London, was sent by the British Museum to collect specimens of natural history in Jamaica. He spent nearly two years on that island, and after his return published his *Birds of Jamaica* (1847) and his *Naturalist's Sojourn in Jamaica* (1851). He also wrote about this time several zoological works for the S.P.C.K., and laboured to such an extent as to impair his health. While recovering at Ilfracombe, he was attracted by the forms of marine life so abundant on that shore, and in 1853 published *A Naturalist's Rambles on the Devonshire Coast*, accompanied by a description of the marine aquarium invented by him, by means of which he succeeded in preserving zoophytes and other marine animals of the humbler grades alive and in good condition away from the sea. This arrangement was more fully set forth and illustrated in his *Aquarium* (1854), succeeded in 1855-1856 by *A Manual of Marine Zoology*, in two volumes, illustrated by nearly 700 wood engravings after the author's drawings. A volume on the marine fauna of Tenby succeeded in 1856. In June of the same year he was elected F.R.S. Gosse, who was a most careful observer, but who

lacked the philosophical spirit, was now tempted to essay work of a more ambitious order, publishing in 1857 two books, *Life and Omphalos*, embodying his speculations on the appearance of life on the earth, which he considered to have been instantaneous, at least as regarded its higher forms. His views met with no favour from scientific men, and he returned to the field of observation, which he was better qualified to cultivate. Taking up his residence at St Marychurch, in South Devon, he produced from 1858 to 1860 his standard work on sea-anemones, the *Actinologia Britannica*. The *Romance of Natural History* and other popular works followed. In 1865 he abandoned authorship, and chiefly devoted himself to the cultivation of orchids. Study of the Rotifera, however, also engaged his attention, and his results were embodied in a monograph by Dr C. T. Hudson (1886). He died at St Marychurch on the 23rd of August 1888.

His life was written by his son, Edmund Gosse.

GOSSEC, FRANÇOIS JOSEPH (1734-1829), French musical composer, son of a small farmer, was born at the village of Vergnies, in Belgian Hainaut, and showing early a taste for music became a choir-boy at Antwerp. He went to Paris in 1751 and was taken up by Rameau. He became conductor of a private band kept by La Popelinière, a wealthy amateur, and gradually determined to do something to revive the study of instrumental music in France. He had his own first symphony performed in 1754, and as conductor to the Prince de Condé's orchestra he produced several operas and other compositions of his own. He imposed his influence upon French music with remarkable success, founded the Concert des Amateurs in 1770, organized the École de Chant in 1784, was conductor of the band of the Garde Nationale at the Revolution, and was appointed (with Méhul and Cherubini) inspector of the Conservatoire de Musique when this institution was created in 1795. He was an original member of the Institute and a chevalier of the legion of honour. Outside France he was but little known, and his own numerous compositions, sacred and secular, were thrown into the shade by those of men of greater genius; but he has a place in history as the inspirer of others, and as having powerfully stimulated the revival of instrumental music. He died at Passy on the 16th of February 1829.

See the *Lives* by P. Hérouin (1852) and E. G. J. Gregoir (1878).

GOSSEP (from the O.E. *godsibb*, i.e. God, and *sib*, akin, standing in relation to), originally a god-parent, i.e. one who by taking a sponsor's vows at a baptism stands in a spiritual relationship to the child baptized. The common modern meaning is of light personal or social conversation, or, with an invidious sense, of idle tale-bearing. "Gossip" was early used with the sense of a friend or acquaintance, either of the parent of the child baptized or of the other god-parents, and thus came to be used, with little reference to the position of sponsor, for women friends of the mother present at a birth; the transition of meaning to an idle chatterer or talker for talking's sake is easy. The application to the idle talk of such persons does not appear to be an early one.

GOSSENER, JOHANNES EVANGELISTA (1773-1858), German divine and philanthropist, was born at Hausen near Augsburg on the 14th of December 1773, and educated at the university of Dillingen. Here like Martin Boos and others he came under the spell of the Evangelical movement promoted by Johann Michael Sailer, the professor of pastoral theology. After taking priest's orders, GosseNER held livings at Dirlwang (1804-1811) and Munich (1811-1817), but his evangelical tendencies brought about his dismissal and in 1826 he formally left the Roman Catholic for the Protestant communion. As minister of the Bethlehem church in Berlin (1829-1846) he was conspicuous not only for practical and effective preaching, but for the founding of schools, asylums and missionary agencies. He died on the 20th of March 1858.

Lives by Bethmann-Hollweg (Berlin, 1858) and H. Dalton (Berlin, 1878).

GOSSON, STEPHEN (1554-1624), English satirist, was baptized at St George's, Canterbury, on the 17th of April 1554.

He entered Corpus Christi College, Oxford, 1572, and on leaving the university in 1576 he went to London. In 1598 Francis Meres in his *Palladis Tamia* mentions him with Sidney, Spenser, Abraham Fraunce and others among the "best for pastorall," but no pastorals of his are extant. He is said to have been an actor, and by his own confession he wrote plays, for he speaks of *Catiline's Conspiracies* as a "Pig of mine own Sowe." To this play and some others, on account of their moral intention, he extends indulgence in the general condemnation of stage plays contained in his *Schoole of Abuse*, containing a pleasant invective against Poets, Pipers, Players, Jestors and such like Caterpillars of the Commonwealth (1579). The euphuistic style of this pamphlet and its ostentatious display of learning were in the taste of the time, and do not necessarily imply insincerity. Gosson justified his attack by considerations of the disorder which the love of melodrama and of vulgar comedy was introducing into the social life of London. It was not only by extremists like Gosson that these abuses were recognized. Spenser, in his *Tears of the Muses* (1591), laments the same evils, although only in general terms. The tract was dedicated to Sir Philip Sidney, who seems not unnaturally to have resented being connected with a pamphlet which opened with a comprehensive denunciation of poets, for Spenser, writing to Gabriel Harvey (Oct. 16, 1579) of the dedication, says the author "was for hys labor scorned." He dedicated, however, a second tract, *The Ephemerides of Phialo . . . and A Short Apologie of the Schoole of Abuse*, to Sidney on Oct. 28th, 1579. Gosson's abuse of poets seems to have had a large share in inducing Sidney to write his *Apologie for Poetrie*, which probably dates from 1581. After the publication of the *Schoole of Abuse* Gosson retired into the country, where he acted as tutor to the sons of a gentleman (*Plays Confuted*. "To the Reader," 1582). Anthony à Wood places this earlier and assigns the termination of his tutorship indirectly to his animosity against the stage, which apparently wearied his patron of his company. The publication of his polemic provoked many retorts, the most formidable of which was Thomas Lodge's *Defence of Playes* (1580). The players themselves retaliated by reviving Gosson's own plays. Gosson replied to his various opponents in 1582 by his *Plays Confuted in Five Actions*, dedicated to Sir Francis Walsingham. Meanwhile he had taken orders, was made lecturer of the parish church at Stepney (1585), and was presented by the queen to the rectory of Great Wigborough, Essex, which he exchanged in 1600 for St Botolph's, Bishopsgate. He died on the 13th of February 1624. *Pleasant Quippes for Upstart New-fangled Gentlewomen* (1595), a coarse satiric poem, is also ascribed to Gosson.

The *Schoole of Abuse* and *Apologie* were edited (1868) by Prof. E. Arber in his *English Reprints*. Two poems of Gosson's are included.

GOT, FRANÇOIS JULES EDMOND (1822-1901), French actor, was born at Lignerolles on the 1st of October 1822, and entered the Conservatoire in 1841, winning the second prize for comedy that year and the first in 1842. After a year of military service he made his début at the Comédie Française on the 17th of July 1844, as Alexis in *Les Héritiers* and Mascarelles in *Les Précieuses ridicules*. He was immediately admitted *pensionnaire*, and became *sociétaire* in 1850. By special permission of the emperor in 1866 he played at the Odéon in Émile Augier's *Contagion*. His golden jubilee at the Théâtre Français was celebrated in 1894, and he made his final appearance the year after. Got was a fine representative of the grand style of French acting, and was much admired in England as well as in Paris. He wrote the libretto of the opera *François Villon* (1857) and also of *L'Esclave* (1874). In 1881 he was decorated with the cross of the Legion of Honour.

GÖTA, a river of Sweden, draining the great Lake Vener. The name, however, is more familiar in its application to the canal which affords communication between Gothenburg and Stockholm. The river flows out of the southern extremity of the lake almost due south to the Cattegat, which it enters by two arms enclosing the island of Hisingen, the eastern forming the harbour and bearing the heavy sea-traffic of the port of

Gothenburg. The Göta river is 50 m. in length, and is navigable for large vessels, a series of locks surmounting the famous falls of Trollhättan (q.v.). Passing the abrupt wooded Halleberg and Hunneberg (royal shooting preserves) Lake Vener is reached at Venersborg. Several important ports lie on the north, east and south shores (see VENER). From Sjötorp, midway on the eastern shore, the western Göta canal leads S.E. to Karlsborg. Its course necessitates over twenty locks to raise it from the Vener level (144 ft.) to its extreme height of 300 ft., and lower it over the subsequent fall through the small lakes Viken and Botten to Lake Vetter (q.v.; 289 ft.), which the route crosses to Motala. The eastern canal continues eastward from this point, and a descent is followed through five locks to Lake Boren, after which the canal, carried still at a considerable elevation, overlooks a rich and beautiful plain. The picturesque Lake Roxen with its ruined castle of Stjernarp is next traversed. At Norsholm a branch canal connects Lake Glan to the north, giving access to the important manufacturing centre of Norrköping. Passing Lake Asplängen, the canal follows a cut through steep rocks, and then resumes an elevated course to the old town of Söderköping, after which the Baltic is reached at Mem. Vessels plying to Stockholm run N.E. among the coastal island-fringe (*skärgränd*), and then follow the Södertelge canal into Lake Mälaren. The whole distance from Gothenburg to Stockholm is about 360 m., and the voyage takes about 2½ days. The length of artificial work on the Göta canal proper is 54 m., and there are 58 locks. The scenery is not such as will bear adverse weather conditions; that of the western canal is without any interest save in the remarkable engineering work. The idea of a canal dates from 1516, but the construction was organized by Baron von Platten and engineered by Thomas Telford in 1810-1832. The falls of Trollhättan had already been locked successfully in 1800.

GOTARZES, or **GOTERZES**, king of Parthia (c. A.D. 42-51). In an inscription at the foot of the rock of Behistun¹ he is called Γωτάρης Γετόρρος, i.e. "son of Gēw," and seems to be designated as "satrap of satrap." This inscription therefore probably dates from the reign of Artabanus II. (A.D. 10-40), to whose family Gotarzes must have belonged. From a very barbarous coin of Gotarzes with the inscription βασιλεως βασιλευσιν Αρσασος υς κεκαουμενος Αρταβανου Γωτάρης (Wroth, *Catalogue of the Coins of Parthia*, p. 165; *Numism. Chron.*, 1900, p. 95; the earlier readings of this inscription are wrong), which must be translated "king of kings Arsakes, named son of Artabanus, Gotarzes," it appears that he was adopted by Artabanus. When the troublesome reign of Artabanus II. ended in A.D. 39 or 40, he was succeeded by Vardanes, probably his son; but against him in 41 rose Gotarzes (the dates are fixed by the coins). He soon made himself detested by his cruelty—among many other murders he even slew his brother Artabanus and his whole family (*Tac. Ann.* xi. 8)—and Vardanes regained the throne in 42; Gotarzes fled to Hyrcania and gathered an army from the Dahian nomads. The war between the two kings was at last ended by a treaty, as both were afraid of the conspiracies of their nobles. Gotarzes returned to Hyrcania. But when Vardanes was assassinated in 45, Gotarzes was acknowledged in the whole empire (*Tac. Ann.* xi. 9 ff.; *Joseph. Antiq.* xx. 3, 4, where Gotarzes is called Kotardes). He now takes on his coins the usual Parthian titles, "king of kings Arsakes the benefactor, the just, the illustrious (*Epiphanes*), the friend of the Greeks (*Philhellén*)," without mentioning his proper name. The discontent excited by his cruelty and luxury induced the hostile party to apply to the emperor Claudius and fetch from Rome an Arsacid prince Meherdates (i.e. Mithradates), who lived there as hostage. He crossed the Euphrates in 49, but was beaten and taken prisoner by Gotarzes, who cut off his ears (*Tac. Ann.* xii. 10 ff.). Soon after Gotarzes died, according to Tacitus, of an illness; Josephus says that he was murdered. His last coin is dated from June 51.

¹ Rawlinson, *Journ. Roy. Geog. Soc.* ix. 114; Flandin and Coste, *La Perse ancienne*, i. tab. 19; Dittenberger, *Orientalis Graeci inscr.* 431.

An earlier "Arsakes with the name Gotarzes," mentioned on some astronomical tablets from Babylon (Strassmaier in *Zeitschr. für Assyriologie*, vi. 216; Mahler in *Wiener Zeitschr. für Kunde des Morgenlands*, xv. 63 ff.), appears to have reigned for some time in Babylonia about 87 B.C. (Ed. M.)

GOTHA, a town of Germany, alternately with Coburg the residence of the dukes of Saxe-Coburg-Gotha, in a pleasant situation on the Leine canal, 6 m. N. of the slope of the Thuringian forest, 17 m. W. from Erfurt, on the railway to Bebra-Cassel. Pop. (1905) 36,906. It consists of an old inner town and encircling suburbs, and is dominated by the castle of Friedenstein, lying on the Schlossberg at an elevation of 1100 ft. With the exception of those in the older portion of the town, the streets are handsome and spacious, and the beautiful gardens and promenades between the suburbs and the castle add greatly to the town's attractiveness. To the south of the castle there is an extensive and finely adorned park. To the north-west of the town the Galberg—on which there is a public pleasure garden—and to the south-west the Seeberg rise to a height of over 1300 ft. and afford extensive views. The castle of Friedenstein, begun by Ernest the Pious, duke of Saxe-Coburg-Gotha, in 1643 and completed in 1654, occupies the site of the old fortress of Grimmenstein. It is a huge square building flanked with two wings, having towers rising to the height of about 140 ft. It contains the ducal cabinet of coins and the ducal library of nearly 200,000 volumes, among which are several rare editions and about 6900 manuscripts. The picture gallery, the cabinet of engravings, the natural history museum, the Chinese museum, and the cabinet of art, which includes a collection of Egyptian, Etruscan, Roman and German antiquities, are now included in the new museum, completed in 1878, which stands on a terrace to the south of the castle. The principal other public buildings are the church of St Margaret with a beautiful portal and a lofty tower, founded in the 12th century, twice burnt down, and rebuilt in its present form in 1652; the church of the Augustinian convent, with an altar-piece by the painter Simon Jacobs; the theatre; the fire insurance bank and the life insurance bank; the ducal palace, in the Italian villa style, with a winter garden and picture gallery; the buildings of the ducal legislature; the hospital; the old town-hall, dating from the 11th century; the old residence of the painter Lucas Cranach, now used as a girls' school; the ducal stable; and the Friedrichsthal palace, now used as public offices. The educational establishments include a gymnasium (founded in 1524, one of the most famous in Germany), two training schools for teachers, conservatoires of music and several scientific institutions. Gotha is remarkable for its insurance societies and for the support it has given to cremation. The crematorium was long regarded as a model for such establishments.

Gotha is one of the most active commercial towns of Thuringia, its manufactures including sausages, for which it has a great reputation, porcelain, tobacco, sugar, machinery, mechanical and surgical instruments, musical instruments, shoes, lamps and toys. There are also a number of nurseries and market gardens. The book trade is represented by about a dozen firms, including that of the great geographical house of Justus Perthes, founded in 1785.

Gotha (in old chronicles called *Gotgewe* and later *Gotake*) existed as a village in the time of Charlemagne. In 930 its lord Gothard abbot of Hersfeld surrounded it with walls. It was known as a town as early as 1200, about which time it came into the possession of the landgraves of Thuringia. On the extinction of that line Gotha came into the possession of the electors of Saxony, and it fell later to the Ernestine line of dukes. After the battle of Mühlberg in 1547 the castle of Grimmenstein was partly destroyed, but it was again restored in 1554. In 1567 the town was taken from Duke John Frederick by the elector Augustus of Saxony. After the death of John Frederick's sons, it came into the possession of Duke Ernest the Pious, the founder of the line of the dukes of Gotha; and on the extinction of this family it was united in 1825 along with the dukedom to Coburg.

See *Götha und seine Umgebung* (Götha, 1851); Kühne, *Beiträge zur Geschichte der Entwicklung der sozialen Zustände der Stadt und des Herzogtums Götha* (Götha, 1862); Humbert, *Les Villes de la Thuringe* (Paris, 1869), and Beck, *Geschichte der Stadt Götha* (Götha, 1870).

GOTHAM, WISE MEN OF, the early name given to the people of the village of Gotham, Nottingham, in allusion to their reputed simplicity. But if tradition is to be believed the Gothamites were not so very simple. The story is that King John intended to live in the neighbourhood, but that the villagers, foreseeing ruin as the cost of supporting the court, feigned imbecility when the royal messengers arrived. Wherever the latter went they saw the rustics engaged in some absurd task. John, on this report, determined to have his hunting lodge elsewhere, and the "wise men" boasted, "we were there are more fools pass through Gotham than remain in it." The "foes of Gotham" are mentioned as early as the 15th century in the *Towneley Mysteries*; and a collection of their "jests" was published in the 16th century under the title *Merris Tales of the Mad Men of Gotham, gathered together by A.B., of Phisicke Doctour*. The "A.B." was supposed to represent Andrew Borde or Boorde (1497-1549), famous among other things for his wit, but he probably had nothing to do with the compilation. As typical of the Gothamite folly is usually quoted the story of the villagers joining hands round a thornbush to shut in a cuckoo so that it would sing all the year. The localizing of fools is common to most countries, and there are many other reputed "imbecile" centres in England besides Gotham. Thus there are the people of Coggeshall, Essex, the "carles of Austwick," Yorkshire, "the gowks of Gordon," Berwickshire, and for many centuries the charge of folly has been made against "silly" Suffolk and Norfolk (*Descriptio Norfolkensium* about 12th century, printed in Wright's *Early Mysteries and other Latin Poems*). In Germany there are the *Schildburgers*, in Holland the people of Kampen. Among the ancient Greeks Boeotia was the home of fools; among the Thracians, Abdera; among the ancient Jews, Nazareth.

See W. A. Clouston, *Book of Noodles* (London, 1888); R. H. Cunningham, *Amusing Prose Chap-books* (1889).

GOTHENBURG (Swed. *Göteborg*), a city and seaport of Sweden, on the river Göta, 5 m. above its mouth in the Cattegat, 285 m. S.W. of Stockholm by rail, and 360 by the Göta canal-route. Pop. (1900) 130,619. It is the chief town of the district (*län*) of Göteborg och Bohus, and the seat of a bishop. It lies on the east or left bank of the river, which is here lined with quays on both sides, those on the west belonging to the large island of Hisingen, contained between arms of the Göta. On this island are situated the considerable suburbs of Lindholmen and Lundsby.

The city itself stretches east and south from the river, with extensive and pleasant residential suburbs, over a wooded plain enclosed by low hills. The inner city, including the business quarter, is contained almost entirely between the river and the Rosenlunds canal, continued in the Vallgraf, the moat of the old fortifications; and is crossed by the Storahamn, Östrahamn and Vestrahamn canals. The Storahamn is flanked by the handsome tree-planted quays, Norra and Södra Hamngatan. The first of these, starting from the Stora Bommenshamn, where the sea-going passenger-steamers lie, leads past the museum to the Gustaf-Adolfs-Torg. The museum, in the old East India Company's house, has fine collections in natural history, entomology, botany, anatomy, archaeology and ethnography, a picture and sculpture gallery, and exhibits of coins and industrial art. Gustaf-Adolfs-Torg is the business centre, and contains the town-hall (1679) and exchange (1849). Here are statues by B. E. Fogelberg of Gustavus Adolphus and of Odin, and of Oscar I. by J. P. Mölin. Among several churches in this quarter of the city is the cathedral (*Gustavii Domkyrka*), a cruciform church founded in 1633 and rebuilt after fires in 1742 and 1815. Here are also the customs-house and residence of the governor of the *län*. On the north side, closely adjacent, are the Lilla Bommenshamn, where the Göta canal steamers lie, and the two principal railway stations, Statens and Bergslafs

Bangård. Above the Rosenlunds canal rises a low, rocky eminence, Lilla Otterhällberg. The inner city is girdled on the south and east by the Kungspark, which contains Molin's famous group of statuary, the Belt-bucklers (*Bältespännare*), and by the beautiful gardens of the Horticultural Society (*Trädgårdssällskapet*). These grounds are traversed by the broad Nya Allé, a favourite promenade, and beyond them lies the best residential quarter, the first houses facing Vasa Street, Vasa Park and Kungspark Avenue. At the north end of the last are the university and the New theatre. At the west end of Vasa Street is the city library, the most important in the country except the royal library at Stockholm and the university libraries at Upsala and Lund. The suburbs are extensive. To the south-west are Majorna and Masthugget, with numerous factories. Beyond these lie the fine Slottskog Park, planted with oaks, and picturesquely broken by rocky hills commanding views of the busy river and the city. The suburb of Annedal is the workmen's quarter; others are Landala, Garda and Stampen. All are connected with the city by electric tramways. Six railways leave the city from four stations. The principal lines, from the Statens and Bergslafs stations, run N. to Trollhättan, and into Norway (Christiania); N.E. between Lakes Vener and Vetter to Stockholm, Falun and the north; E. to Borås and beyond, and S. by the coast to Helsingborg, &c. From the Vestgöta station a narrow-gauge line runs N.E. to Skara and the southern shores of Vener, and from Sarö station near Slottskog Park a line serves Sarö, a seaside watering-place on an island 20 m. S. of Gothenburg.

The city has numerous important educational establishments. The university (*Högskola*) was a private foundation (1801), but is governed by a board, the members of which are nominated by the state, the town council, Royal Society of Science and Literature, directors of the museum, and the staffs of the various local colleges. There are several boys' schools, a college for girls, a scientific college, a commercial college (1826), a school of navigation, and Chalmers' Polytechnical College, founded by William Chalmers (1748-1811), a native of Gothenburg of English parentage. He bequeathed half his fortune to this institution, and the remainder to the Sahlgrenska hospital. A people's library was founded by members of the family of Dickson, several of whom have taken a prominent part in philanthropic works in the city. The connexion of the family with Gothenburg dates from 1802, when Robert Dickson, a native of Montrose in Scotland, founded the business in which he was joined in 1807 by his brother James.

In respect of industry and commerce as a whole Gothenburg ranks as second to Stockholm in the kingdom; but it is actually the principal centre of export trade and port of register; and as a manufacturing town it is slightly inferior to Malmö. Its principal industrial establishments are mechanical works (both in the city and at Lundsby), saw-mills, dealing with the timber which is brought down the Göta, flour-mills, margarine factories, breweries and distilleries, tobacco works, cotton mills, dyeing and bleaching works (at Levanten in the vicinity), furniture factories, paper and leather works, and shipbuilding yards. The vessels registered at the port in 1901 were 247 of 120,488 tons. There are about 3 m. of quays approachable by vessels drawing 20 ft., and slips for the accommodation of large vessels. Gothenburg is the principal port of embarkation of Swedish emigrants for America.

The city is governed by a council including two mayors, and returns nine members to the second chamber of the Riksdag (parliament).

Founded by Gustavus Adolphus in 1679, Gothenburg was from the first designed to be fortified, a town of the same name founded on Hisingen in 1603 having been destroyed by the Danes during the Calmar war. From 1621, when it was first chartered, it steadily increased, though it suffered greatly in the Danish wars of the last half of the 17th and the beginning of the 18th centuries, and from several extensive conflagrations (the last in 1813), which have destroyed important records of its history. The great development of its herring fishery in the latter part

of the 12th century gave a new impulse to the city's trade, which was kept up by the influence of the "Continental System," under which Gothenburg became a depot for the colonial merchandise of England. After the fall of Napoleon it began to decline, but after its closer connexion with the interior of the country by the Göta canal (opened 1832) and Western railway it rapidly advanced both in population and trade. Since the demolition of its fortifications in 1807, it has been defended only by some small forts. Gothenburg was the birthplace of the poet Bengt Lidner (1757-1793) and two of Sweden's greatest sculptors, Bengt Erland Fogelberg (1786-1854) and Johann Peter Molin (1814-1873). After the French Revolution Gothenburg was for a time the residence of the Bourbon family. The name of this city is associated with the municipal licensing system known as the Gothenburg System (see LIQUOR LAWS).

See W. Berg, *Samlingar till Göteborgs historia* (Gothenburg, 1893); Lagerberg, *Göteborg i äldre och nyare tid* (Gothenburg, 1902); Fröding, *Det forna Göteborg* (Stockholm, 1903).

GOTHIC, the term generally applied to medieval architecture, and more especially to that in which the pointed arch appears. The style was at one time supposed to have originated with the warlike people known as the Goths, some of whom (the East Goths, or Ostrogoths) settled in the eastern portion of Europe, and others (the West Goths, or Visigoths) in the Asturias of Spain; but as no buildings or remains of any description have ever been found, in which there are any traces of an independent construction in either brick or stone, the title is misleading; since, however, it is now so generally accepted it would be difficult to change it. The term when first employed was one of reproach, as Evelyn (1702) when speaking of the faultless building (*i.e.* classic) says, "they were demolished by the Goths or Vandals, who introduced their own licentious style now called modern or Gothic." The employment of the pointed arch in Syria, Egypt and Sicily from the 8th century onwards by the Mahomedans for their mosques and gateways, some four centuries before it made its appearance in Europe, also makes it advisable to adhere to the old term Gothic in preference to Pointed Architecture. (See ARCHITECTURE)

GÖTHITE, or **GOETHITE**, a mineral composed of an iron hydrate, $Fe_2O_3 \cdot H_2O$, crystallizing in the orthorhombic system and isomorphous with diaspore and manganite (*q.v.*). It was first noticed in 1789, and in 1806 was named after the poet Goethe. Crystals are prismatic, acicular or scaly in habit; they have a perfect cleavage parallel to the brachypinacoid (*M* in the figure). Reniform and stalactitic masses with a radiated fibrous structure also occur. The colour varies from yellowish or reddish to blackish-brown, and by transmitted light it is often blood-red; the streak is brownish-yellow; hardness, 5; specific gravity, 4.3. The best crystals are the brilliant, blackish-brown prisms with terminal pyramidal planes (fig.) from the Restormel iron mines at Lostwithiel, and the Botallack mine at St Just in Cornwall. A variety occurring as thin red scales at Siegen in Westphalia is known as Rubinglimmer or pyrrhosiderite (from Gr. *pyrrhos*, flame-coloured, and *sideros*, iron); a scaly-fibrous variety from the same locality is called lepidocrocite (from *lepis*, scale, and *crocus*, fibre). Sammetblende or prizbramite is a variety, from Prábram in Bohemia, consisting of delicate acicular or capillary crystals arranged in radiating groups with a velvety surface and yellow colour.

Göthite occurs with other iron oxides, especially limonite and hematite, and when found in sufficient quantity is mined with these as an ore of iron. It often occurs also as an enclosure in other minerals. Acicular crystals, resembling rutile in appearance, sometimes penetrate crystals of pale-coloured amethyst, for instance, at Wolf's Island in Lake Onega in Russia: this form of the mineral has long been known as onegite, and the crystals enclosing it are cut for ornamental purposes under the name of "Cupid's darts" (*fiches d'amour*). The metallic glitter

of aventurine or sun-stone (*q.v.*) is due to the enclosed scales of göthite and certain other minerals. (L. J. S.)

GOTHS (*Golones*, later *Gothis*), a Teutonic people who in the 1st century of the Christian era appear to have inhabited the middle part of the basin of the Vistula. They were probably the easternmost of the Teutonic peoples. Early History. According to their own traditions as recorded by Jordanes, they had come originally from the island Scandza, *i.e.* Skåne or Sweden, under the leadership of a king named Berig, and landed first in a region called Gothiscandza. Thence they invaded the territories of the Ulmerugi (the Holmryge of Anglo-Saxon tradition), probably in the neighbourhood of Rügenwalde in eastern Pomerania, and conquered both them and the neighbouring Vandals. Under their sixth king Filimer they migrated into Scythia and settled in a district which they called Oium. The rest of their early history, as it is given by Jordanes following Cassiodorus, is due to an erroneous identification of the Goths with the Getae, and ancient Thracian people.

The credibility of the story of the migration from Sweden has been much discussed by modern authors. The legend was not peculiar to the Goths, similar traditions being current among the Langobardi, the Burgundians, and apparently several other Teutonic nations. It has been observed with truth that so many populous nations can hardly have sprung from the Scandinavian peninsula; on the other hand, the existence of these traditions certainly requires some explanation. Possibly, however, many of the royal families may have contained an element of Scandinavian blood, a hypothesis which would well accord with the social conditions of the migration period, as illustrated, *e.g.*, in *Völsunga Saga* and in *Herwarar Saga ok Heiðreks Konungs*. In the case of the Goths a connexion with Gotland is not unlikely, since it is clear from archaeological evidence that this island had an extensive trade with the coasts about the mouth of the Vistula in early times. If, however, there was any migration at all, one would rather have expected it to have taken place in the reverse direction. For the origin of the Goths can hardly be separated from that of the Vandals, whom according to Procopius they resembled in language and in all other respects. Moreover the Gepidae, another Teutonic people, who are said to have formerly inhabited the delta of the Vistula, also appear to have been closely connected with the Goths. According to Jordanes they participated in the migration from Scandza.

Apart from a doubtful reference by Pliny to a statement of the early traveller Pytheas, the first notices we have of the Goths go back to the first years of the Christian era, at which time they seem to have been subject to the Marcomannic king Maroboduus. They do not enter into Roman history, however, until after the beginning of the 3rd century, at which time they appear to have come in conflict with the emperor Caracalla. During this century their frontier seems to have been advanced considerably farther south, and the whole country as far as the lower Danube was frequently ravaged by them. The emperor Gordianus is called "victor Gothorum" by Capitolinus, though we have no record of the ground for the claim, and further conflicts are recorded with his successors, one of whom, Decius, was slain by the Goths in Moesia. According to Jordanes the kings of the Goths during these campaigns were Ostrogotha and afterwards Cniva, the former of whom is praised also in the Anglo-Saxon poem *Widsið*. The emperor Gallus was forced to pay tribute to the Goths. By this time they had reached the coasts of the Black Sea, and during the next twenty years they frequently ravaged the maritime regions of Asia Minor and Greece. Aurelian is said to have won a victory over them, but the province of Dacia had to be given up. In the time of Constantine the Great Thrace and Moesia were again plundered by the Goths, A.D. 321. Constantine drove them back and concluded peace with their king Ariaric in 336. From the end of the 3rd century we hear of subdivisions of the nation called Greutungi, Terungi, Austrogothi (Ostrogothi), Visigothi, Taifali, though it is not clear whether these were all distinct.

Though by this time the Goths had extended their territories

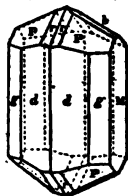

far to the south and east, it must not be assumed that they had evacuated their old lands on the Vistula. Jordanes records several traditions of their conflicts with other Teutonic tribes, in particular a victory won by Ostrogoths over Fastida, king of the Gepidae, and another by Geberic over Visimar, king of the Vandals, about the end of Constantine's reign, in consequence of which the Vandals sought and obtained permission to settle in Pannonia. Geberic was succeeded by the most famous of the Gothic kings, Hermanaric (Eormentric, Iörmunrekr), whose deeds are recorded in the traditions of all Teutonic nations. According to Jordanes he conquered the Heruli, the Aestii, the Venedi, and a number of other tribes who seem to have been settled in the southern part of Russia. From Anglo-Saxon sources it seems probable that his supremacy reached westwards as far as Holstein. He was of a cruel disposition, and is said to have killed his nephews Embrica (Emerca) and Fritla (Fridla) in order to obtain the great treasure which they possessed. Still more famous is the story of Svanhilda (Svanhildr), who according to Northern tradition was his wife and was cruelly put to death on a false charge of unfaithfulness. An attempt to avenge her death was made by her brothers Amnius (Hamſir) and Sarus (Söri) by whom Hermanaric was severely wounded. To his time belong a number of other heroes whose exploits are recorded in English and Northern tradition, amongst whom we may mention Wudga (Vidigota), Hama and several others, who in *Waldsið* are represented as defending their country against the Huns in the forest of the Vistula. Hermanaric committed suicide in his distress at an invasion of the Huns about A.D. 370, and the portion of the nation called Ostrogoths then came under Hunnish supremacy. The Visigoths obtained permission to cross the Danube and settle in Moesia. A large part of the nation became Christian about this time (see below). The exactions of the Roman governors, however, soon led to a quarrel, which ended in the total defeat and death of Valens at Adrianople in the year 378. (F. G. M. B.)

From about 370 the history of the East and West Goths parts asunder, to be joined together again only incidentally and for a season. The great mass of the East Goths stayed north of the Danube, and passed under the overlordship of the Hun. They do not for the present play any important part in the affairs of the Empire. The great mass of the West Goths crossed the Danube into the Roman provinces, and there played a most important part in various characters of alliance and enmity. The great migration was in 376, when they were allowed to pass as peaceful settlers under their chief Frithigern. His rival Athanaric seems to have tried to maintain his party for a while north of the Danube in defiance of the Huns; but he had presently to follow the example of the great mass of the nation. The peaceful designs of Frithigern were meanwhile thwarted by the ill-treatment which the Goths suffered from the Roman officials, which led first to disputes and then to open war. In 378 the Goths won the great battle of Adrianople, and after this Theodosius the Great, the successor of Valens, made terms with them in 381, and the mass of the Gothic warriors entered the Roman service as *foederati*. Many of their chiefs were in high favour; but it seems that the orthodox Theodosius showed more favour to the still remaining heathen party among the Goths than to the larger part of them who had embraced Arian Christianity. Athanaric himself came to Constantinople in 381; he was received with high honours, and had a solemn funeral when he died. His saying is worth recording, as an example of the effect which Roman civilization had on the Teutonic mind. "The emperor," he said, "was a god upon earth, and he who resisted him would have his blood on his own head."

The death of Theodosius in 395 broke up the union between the West Goths and the Empire. Dissensions arose between them and the ministers of Avodius; the Goths threw off their allegiance, and chose Alaric as their king. This was a restoration alike of national unity and of national independence. The royal title had not been borne by their leaders in the Roman service. Alaric's position is quite different from that of several

Goths in the Roman service, who appear as simple rebels. He was of the great West Gothic house of the Balthi, or Bold-men, a house second in nobility only to that of the Amali. His whole career was taken up with marchings to and fro within the lands, first of the Eastern, then of the Western empire. The Goths are under him an independent people under a national king; their independence is in no way interfered with if the Gothic king, in a moment of peace, accepts the office and titles of a Roman general. But under Alaric the Goths make no lasting settlement. In the long tale of intrigue and warfare between the Goths and the two imperial courts which fills up this whole time; cessions of territory are offered to the Goths, provinces are occupied by them, but as yet they do not take root anywhere; no Western land as yet becomes *Gothia*. Alaric's designs of settlement seem in his first stage to have still kept east of the Adriatic, in Illyricum, possibly in Greece. Towards the end of his career his eyes seem fixed on Africa.

Greece was the scene of his great campaign in 395-96, the second Gothic invasion of that country. In this campaign the religious position of the Goths is strongly marked. The Arian appeared as an enemy alike to the pagan majority and the Catholic minority; but he came surrounded by monks, and his chief wrath was directed against the heathen temples (*vide* G. F. Hertzberg, *Geschichte Griechenlands*, iii. 301). His Italian campaigns fall into two great divisions, that of 402-3, when he was driven back by Stilicho, and that of 408-10, after Stilicho's death. In this second war he thrice besieged Rome (408, 409, 410). The second time it suited a momentary policy to set up a puppet emperor of his own, and even to accept a military commission from him. The third time he sacked the city, the first time since Brennus that Rome had been taken by an army of utter foreigners. The intricate political and military details of these campaigns are of less importance in the history of the Gothic nation than the stage which Alaric's reign marks in the history of that nation. It stands between two periods of settlement within the Empire and of service under the Empire. Under Alaric there is no settlement, and service is quite secondary and precarious; after his death in 410 the two begin again in new shapes.

Contemporary with the campaigns of Alaric was a barbarian invasion of Italy, which, according to one view, again brings the East and West Goths together. The great mass of the East Goths, as has been already said, became one of the many nations which were under vassalage to the Huns; but their relation was one merely of vassalage. They remained a distinct people under kings of their own, kings of the house of the Amali and of the kindred of Ermanaric (Jordanes, 48). They had to follow the lead of the Huns in war, but they were also able to carry on wars of their own; and it has been held that among these separate East Gothic enterprises we are to place the invasion of Italy in 405 by Radagaisus (whom R. Fallmann¹ writes Ratiger, and takes him for the chief of the heathen part of the East Goths). One chronicler, Prosper, makes this invasion preceded by another in 400, in which Alaric and Radagaisus appear as partners. The paganism of Radagaisus is certain. The presence of Goths in his army is certain, but it seems dangerous to infer that his invasion was a national Gothic enterprise.

Under Ataulphus, the brother-in-law and successor of Alaric, another era opens, the beginning of enterprises which did in the end lead to the establishment of a settled Gothic monarchy in the West. The position of Ataulphus is well marked by the speech put into his mouth by Orosius. He had at one time dreamed of destroying the Roman power, of turning *Romania* into *Gothia*, and putting Ataulphus in the stead of Augustus; but he had learned that the world could be governed only by the laws of Rome and he had determined to use the Gothic arms for the support of the Roman power. And in the confused and contradictory accounts of his actions (for the story in Jordanes cannot be reconciled with the accounts in Olympiodorus and the chroniclers), we can see something of this principle at work throughout. Gaul and Spain were overrun both by barbarian

¹ *Geschichte der Völkerwanderung* (Gotha, 1863-1864).

invaders and by rival emperors. The sword of the Goth was to win back the lost lands for Rome. And, amid many shiftings of allegiance, Ataulphus seems never to have wholly given up the position of an ally of the Empire. His marriage with Placidia, the daughter of the great Theodosius, was taken as the seal of the union between Goth and Roman, and, had their son Theodosius lived, a dynasty might have arisen uniting both claims. But the career of Ataulphus was cut short at Barcelona in 415, by his murder at the hands of another faction of the Goths. The reign of Sigeric was momentary. Under Wallia in 418 a more settled state of things was established. The Empire received again, as the prize of Gothic victories, the Tarraconensis in Spain, and Novempopulana and the Narbonensis in Gaul. The "second Aquitaine," with the sea-coast from the mouth of the Garonne to the mouth of the Loire, became the West Gothic kingdom of Toulouse. The dominion of the Goths was now strictly Gaulish; their lasting Spanish dominion does not yet begin.

The reign of the first West Gothic Theodoric (419-451) shows a shifting state of relations between the Roman and Gothic powers; but, after defeats and successes both ways, the older relation of alliance against common enemies was again established. At last Goth and Roman had to join together against the common enemy of Europe and Christendom, Attila the Hun. But they met Gothic warriors in his army. By the terms of their subjection to the Huns, the East Goths came to fight for Attila against Christendom at Châlons, just as the Servians came to fight for Bajazet against Christendom at Nicopolis. Theodoric fell in the battle (451). After this momentary meeting, the history of the East and West Goths again separates for a while. The kingdom of Toulouse grew within Gaul at the expense of the Empire, and in Spain at the expense of the Suevi. Under Euric (466-485) the West Gothic power again became largely a Spanish power. The kingdom of Toulouse took in nearly all Gaul south of the Loire and west of the Rhone, with all Spain, except the north-west corner, which was still held by the Suevi. Provence alone remained to the Empire. The West Gothic kings largely adopted Roman manners and culture; but, as they still kept to their original Arian creed, their rule never became thoroughly acceptable to their Catholic subjects. They stood, therefore, at a great disadvantage when a new and aggressive Catholic power appeared in Gaul through the conversion of the Frank Clovis or Chlodwig. Toulouse was, as in days long after, the seat of an heretical power, against which the forces of northern Gaul marched as on a crusade. In 507 the West Gothic king Alaric II. fell before the Frankish arms at Campus Vogladensis, near Poitiers, and his kingdom, as a great power north of the Alps, fell with him. That Spain and a fragment of Gaul still remained to form a West Gothic kingdom was owing to the intervention of the East Goths under the rule of the greatest man in Gothic history.

When the Hunnish power broke in pieces on the death of Attila, the East Goths recovered their full independence. They now entered into relations with the Empire, and were settled on lands in Pannonia. During the greater part of the latter half of the 5th century, the East Goths play in south-eastern Europe nearly the same part which the West Goths played in the century before. They are seen going to and fro, in every conceivable relation of friendship and enmity with the Eastern Roman power, till, just as the West Goths had done before them, they pass from the East to the West. They are still ruled by kings of the house of the Amali, and from that house there now steps forward a great figure, famous alike in history and in romance, in the person of Theodoric, son of Theodemir. Born about 454, his childhood was spent at Constantinople as a hostage, where he was carefully educated. The early part of his life is taken up with various disputes, intrigues and wars within the Eastern empire, in which he has as his rival another Theodoric, son of Triarius, and surnamed Strabo. This older but lesser Theodoric seems to have been the chief, not the king, of that branch of the East Goths which had settled within the Empire at an earlier time. Theodoric the Great, as he is some-

times distinguished, is sometimes the friend, sometimes the enemy, of the Empire. In the former case he is clothed with various Roman titles and offices, as patrician and consul; but in all cases alike he remains the national East Gothic king. It was in both characters together that he set out in 488, by commission from the emperor Zeno, to recover Italy from Odoacer. By 493 Ravenna was taken; Odoacer was killed by Theodoric's own hand; and the East Gothic power was fully established over Italy, Sicily, Dalmatia and the lands to the north of Italy. In this war the history of the East and West Goths begins again to unite, if we may accept the witness of one writer that Theodoric was helped by West Gothic auxiliaries. The two branches of the nation were soon brought much more closely together, when, through the overthrow of the West Gothic kingdom of Toulouse, the power of Theodoric was practically extended over a large part of Gaul and over nearly the whole of Spain. A time of confusion followed the fall of Alaric II., and, as that prince was the son-in-law of Theodoric, the East Gothic king stepped in as the guardian of his grandson Amalasic, and preserved for him all his Spanish and a fragment of his Gaulish dominion. Toulouse passed away to the Frank; but the Goth kept Narbonne and its district, the land of Septimania—the land which, as the last part of Gaul held by the Goths, kept the name of *Gothia* for many ages. While Theodoric lived, the West Gothic kingdom was practically united to his own dominion. He seems also to have claimed a kind of protectorate over the Teutonic powers generally, and indeed to have practically exercised it, except in the case of the Franks.

The East Gothic dominion was now again as great in extent and far more splendid than it could have been in the time of Ermanaric. But it was now of a wholly different character. The dominion of Theodoric was not a barbarian but a civilized power. His twofold position ran through everything. He was at once national king of the Goths, and successor, though without any imperial titles, of the Roman emperors of the West. The two nations, differing in manners, language and religion, lived side by side on the soil of Italy; each was ruled according to its own law, by the prince who was, in his two separate characters, the common sovereign of both. The picture of Theodoric's rule is drawn for us in the state papers drawn up in his name and in the names of his successors by his Roman minister Cassiodorus. The Goths seem to have been thick on the ground in northern Italy; in the south they formed little more than garrisons. In Theodoric's theory the Goth was the armed protector of the peaceful Roman; the Gothic king had the toil of government, while the Roman consul had the honour. All the forms of the Roman administration went on, and the Roman polity and Roman culture had great influence on the Goths themselves. The rule of the prince over two distinct nations in the same land was necessarily despotic; the old Teutonic freedom was necessarily lost. Such a system as that which Theodoric established needed a Theodoric to carry it on. It broke in pieces after his death.

On the death of Theodoric (526) the East and West Goths were again separated. The few instances in which they are found acting together after this time are as scattered and incidental as they were before. Amalric succeeded to the West Gothic kingdom in Spain and Septimania. Provence was added to the dominion of the new East Gothic king Athalaric, the grandson of Theodoric through his daughter Amalasintha. The weakness of the East Gothic position in Italy now showed itself. The long wars of Justinian's reign (535-555) recovered Italy for the Empire, and the Gothic name died out on Italian soil. The chance of forming a national state in Italy by the union of Roman and Teutonic elements, such as those which arose in Gaul, in Spain, and in parts of Italy under Lombard rule, was thus lost. The East Gothic kingdom was destroyed before Goths and Italians had at all mingled together. The war of course made the distinction stronger; under the kings who were chosen for the purposes of the war national Gothic feeling had revived. The Goths were now again, if not a wandering people, yet an armed host, no longer the protectors but the

enemies of the Roman people of Italy. The East Gothic dominion and the East Gothic name wholly passed away. The nation had followed Theodoric. It is only once or twice after his expedition that we hear of Goths, or even of Gothic leaders, in the eastern provinces. From the soil of Italy the nation passed away almost without a trace, while the next Teutonic conquerors stamped their name on the two ends of the land, one of which keeps it to this day.

The West Gothic kingdom lasted much longer, and came much nearer to establishing itself as a national power in the lands which it took in. But the difference of race and faith between the Arian Goths and the Catholic Romans of Gaul and Spain influenced the history of the West Gothic kingdom for a long time. The Arian Goths ruled over Catholic subjects, and were surrounded by Catholic neighbours. The Franks were Catholics from their first conversion; the Suevi became Catholics much earlier than the Goths. The African conquests of Belisarius gave the Goths of Spain, instead of the Arian Vandals, another Catholic neighbour in the form of the restored Roman power. The Catholics everywhere preferred either Roman, Suevian or Frankish rule to that of the heretical Goths; even the unconquerable mountaineers of Cantabria seem for a while to have received a Frankish governor. In some other mountain districts the Roman inhabitants long maintained their independence, and in 534 a large part of the south of Spain, including the great cities of Cadix, Cordova, Seville and New Carthage, was, with the good will of its Roman inhabitants, reunited to the Empire, which kept some points on the coast as late as 624. That is to say, the same work which the Empire was carrying on in Italy against the East Goths was at the same moment carried on in Spain against the West Goths. But in Italy the whole land was for a while won back, and the Gothic power passed away for ever. In Spain the Gothic power outlived the Roman power, but it outlived it only by itself becoming in some measure Roman. The greatest period of the Gothic power as such was in the reign of Leovigild (568-586). He reunited the Gaulish and Spanish parts of the kingdom which had been parted for a moment; he united the Suevian dominion to his own; he overcame some of the independent districts, and won back part of the recovered Roman province in southern Spain. He further established the power of the crown over the Gothic nobles, who were beginning to grow into territorial lords. The next reign, that of his son Recared (586-601), was marked by a change which took away the great hindrance which had thus far stood in the way of any national union between Goths and Romans. The king and the greater part of the Gothic people embraced the Catholic faith. A vast degree of influence now fell into the hands of the Catholic bishops; the two nations began to unite; the Goths were gradually romanized and the Gothic language began to go out of use. In short, the Romance nation and the Romance speech of Spain began to be formed. The Goths supplied the Teutonic infusion into the Roman mass. The kingdom, however, still remained a Gothic kingdom. "Gothic," not "Roman" or "Spanish," is its formal title; only a single late instance of the use of the formula "regnum Hispaniae" is known. In the first half of the 7th century that name became for the first time geographically applicable by the conquest of the still Roman coast of southern Spain. The Empire was then engaged in the great struggle with the Avars and Persians; and, now that the Gothic kings were Catholic, the great objection to their rule on the part of the Roman inhabitants was taken away. The Gothic nobility still remained a distinct class, and held, along with the Catholic prelate, the right of choosing the king. Union with the Catholic Church was accompanied by the introduction of the ecclesiastical ceremony of anointing, a change decidedly favourable to elective rule. The growth of those later ideas which tended again to favour the hereditary doctrine had not time to grow up in Spain before the Mohammedan conquest (711). The West Gothic crown therefore remained elective till the end. The modern Spanish nation is the growth of the long struggle with the Mussulmans; but it has a direct connexion with the West

Gothic kingdom. We see at once that the Goths hold altogether a different place in Spanish memory from that which they hold in Italian memory. In Italy the Goth was but a momentary invader and ruler; the Teutonic element in Italy comes from other sources. In Spain the Goth supplies an important element in the modern nation. And that element has been neither forgotten nor despised. Part of the unconquered region of northern Spain, the land of Asturias, kept for a while the name of Gothia, as did the Gothic possessions in Gaul and in Crim. The name of the people who played so great a part in all southern Europe, and who actually ruled over so large a part of it has now wholly passed away; but it is in Spain that its historical impress is to be looked for.

Of Gothic literature in the Gothic language we have the Bible of Ulfilas, and some other religious writings and fragments (see *Gothic Language* below). Of Gothic legislation in Latin we have the edict of Theodoric of the year 500, edited by F. Bluhme in the *Monumenta Germaniae historica*; and the books of *Variae* of Cassiodorus may pass as a collection of the state papers of Theodoric and his immediate successors. Among the West Goths written laws had already been put forth by Euric. The second Alaric (484-507) put forth a *Breviarium* of Roman law for his Roman subjects; but the great collection of West Gothic laws dates from the later days of the monarchy, being put forth by King Recceswinth about 654. This code gave occasion to some well-known comments by Montesquieu and Gibbon, and has been discussed by Savigny (*Geschichte des römischen Rechts*, ii. 65) and various other writers. They are printed in the *Monumenta Germaniae, leges*, tome i. (1902). Of special Gothic histories, besides that of Jordanes, already so often quoted, there is the Gothic history of Isidore, archbishop of Seville, a special source of the history of the West Gothic kings down to Svinthala (621-631). But all the Latin and Greek writers contemporary with the days of Gothic predominance make their constant contributions. Not for special facts, but for a general estimate, no writer is more instructive than Salvian of Marseilles in the 5th century, whose work *De Gubernatione Dei* is full of passages contrasting the vices of the Romans with the virtues of the barbarians, especially of the Goths. In all such pictures we must allow a good deal for exaggeration both ways, but there must be a ground-work of truth. The chief virtues which the Catholic presbyter praises in the Arian Goths are their chastity, their piety according to their own creed, their tolerance towards the Catholics under their rule, and their general good treatment of their Roman subjects. He even ventures to hope that such good people may be saved, notwithstanding their heresy. All this must have had some ground-work of truth in the 5th century, but it is not very wonderful if the later West Goths of Spain had a good deal fallen away from the doubtless somewhat ideal picture of Salvian. (E. A. F.)

There is now an extensive literature on the Goths, and among the principal works may be mentioned: T. Hodgkin, *Italy and her Invaders* (Oxford, 1880-1890); J. Aschbach, *Geschichte der Westgoten* (Frankfurt, 1827); F. Dahn, *Die Könige der Germanen* (1861-1890); E. von Wietersheim, *Geschichte der Völkerwanderung* (1880-1881); R. Pallmann, *Die Geschichte der Völkerwanderung* (Gotha, 1863-1864); B. Rappaport, *Die Einfälle der Goten in das römische Reich* (Leipzig, 1899), and K. Zeuss, *Die Deutschen und die Nachbarstämme* (Munich, 1837). Other works which may be consulted are: E. Gibbon, *Decline and Fall of the Roman Empire*, edited by J. B. Bury (1896-1900); H. H. Milman, *History of Latin Christianity* (1867); J. B. Bury, *History of the Later Roman Empire* (1889); P. Villari, *Le Invasioni barbariche in Italia* (Milan, 1901); and F. Martroye, *L'Occident à l'époque byzantine. Goths et Vandales* (Paris, 1903). There is a popular history of the Goths by H. Bradley in the "Story of the Nations" series (London, 1888). For the laws see the *Leges* in Band I of the *Monumenta Germaniae historica, leges* (1902). A Helfferich, *Entstehung und Geschichte des Westgotenrechts* (Berlin, 1858); F. Bluhme, *Zur Textkritik des Westgotenrechts* (1872); F. Dahn, *Lex Visigothorum. Westgotische Studien* (Würzburg, 1874); C. Rinaudo, *Leggi dei Visigoti. studio* (Turin, 1878), and K. Zeumer, "Geschichte der westgotischen Gesetzgebung" in the *Neues Archiv der Gesellschaft für ältere deutsche Geschichtskunde*. See also the article on THEODORIC.

Gothic Language.—Our knowledge of the Gothic language is derived almost entirely from the fragments of a translation

of the Bible which is believed to have been made by the Arian bishop Wulfila or Ulfilas (d. 383) for the Goths who dwelt on the lower Danube. The MSS. which have come down to us and which date from the period of Ostrogothic rule in Italy (489-555) contain the Second Epistle to the Corinthians complete, together with more or less considerable fragments of the four Gospels and of all the other Pauline Epistles. The only remains of the Old Testament are three short fragments of Ezra and Nehemiah. There is also an incomplete commentary (*skreivins*) on St John's Gospel, a fragment of a calendar, and two charters (from Naples and Arezzo, the latter now lost) which contain some Gothic sentences. All these texts are written in a special character, which is said to have been invented by Wulfila. It is based chiefly on the uncial Greek alphabet, from which indeed most of the letters are obviously derived, and several orthographical peculiarities, e.g. the use of *ai* for *e* and *ei* for *i* reflect the Greek pronunciation of the period. Other letters, however, have been taken over from the Runic and Latin alphabets. Apart from the texts mentioned above, the only remains of the Gothic language are the proper names and occasional words which occur in Greek and Latin writings, together with some notes, including the Gothic alphabet, in a Salzburg MS. of the 10th century, and two short inscriptions on a torque and a spear-head, discovered at Buzeo (Walachia) and Kovel (Volhynia) respectively. The language itself, as might be expected from the date of Wulfila's translation, is of a much more archaic type than that of any other Teutonic writings which we possess, except a few of the earliest Northern inscriptions. This may be seen, e.g. in the better preservation of final and unaccented syllables and in the retention of the dual and the middle (passive) voice in verbs. It would be quite erroneous, however, to regard the Gothic fragments as representing a type of language common to all Teutonic nations in the 4th century. Indeed the distinctive characteristics of the language are very marked, and there is good reason for believing that it differed considerably from the various northern and western languages, whereas the differences among the latter at this time were probably comparatively slight (see TEUTONIC LANGUAGES). On the other hand, it must not be supposed that the language of the Goths stood quite isolated. Procopius (*Vand.* i. 2) states distinctly that the Gothic language was spoken not only by the Ostrogoths and Visigoths but also by the Vandals and the Gepidae; and in the former case there is sufficient evidence, chiefly from proper names, to prove that his statement is not far from the truth. With regard to the Gepidae we have less information, but since the Goths, according to Jordanes (cap. 17), believed them to have been originally a branch of their own nation, it is highly probable that the two languages were at least closely related. Procopius elsewhere (*Vand.* i. 3; *Goth.* i. 1, iii. 2) speaks of the Rugii, Sciri and Alani as Gothic nations. The fact that the two former were sprung from the north-east of Germany renders it probable that they had Gothic affinities, while the Alani, though non-Teutonic in origin, may have become gothitized in the course of the migration period. Some modern writers have included in the same class the Burgundians, a nation which had apparently come from the basin of the Oder, but the evidence at our disposal on the whole hardly justifies the supposition that their language retained a close affinity with Gothic.

In the 4th and 5th centuries the Gothic language—using the term in its widest sense—must have spread over the greater part of Europe together with the north coast of Africa. It disappeared, however, with surprising rapidity. There is no evidence for its survival in Italy or Africa after the fall of the Ostrogothic and Vandal kingdoms, while in Spain it is doubtful whether the Visigoths retained their language until the Arabic conquest. In central Europe it may have lingered somewhat longer in view of the evidence of the Salzburg MS. mentioned above. Possibly the information there given was derived from southern Hungary or Transylvania where remains of the Gepidae were to be found shortly before the Magyar invasion (889). According to Walafridus Strabo (*de Reb. Eccles.* cap. 7) also

Gothic was still used in his time (the 9th century) in some churches in the region of the lower Danube. Thenceforth the language seems to have survived only among the Goths (*Goti Tetraxiæ*) of the Crimea, who are mentioned for the last time by Ogier Ghislain de Busbecq, an imperial envoy at Constantinople about the middle of the 16th century. He collected a number of words and phrases in use among them which show clearly that their language, though not unaffected by Iranian influence, was still essentially a form of Gothic.

See H. C. von der Gabelentz and J. Loebe, *Ulfilas (Altenburg and Leipzig, 1836-1846)*; E. Bernhardt, *Ulfila oder die gotische Bibel (Halle, 1875)*. For other works on the Gothic language see J. Wright, *A Primer of the Gothic Language (Oxford, 1892)*, p. 14, back. To the references there given should be added: C. C. Uhlenbeck, *Eymalajisches Wörterbuch d. got. Sprache (Amsterdam, 2nd ed. 1901)*; F. Kluge, "Geschichte d. got. Sprache" in H. Paul's *Grundriss d. germ. Philologie* (2nd ed., vol. i, Strassburg, 1897); W. Streitberg, *Gotisches Elementarbuch (Heidelberg, 1897)*; Th. von Grienberger, *Beiträge zur Geschichte d. deutschen Sprache u. Literatur*, xxi. 185 ff.; L. F. A. Wimmer, *Die Runenschrift (Berlin, 1887)*, p. 61 ff.; G. Stephens, *Handbook to the Runic Monuments (London, 1884)*, p. 203; F. Wrede, *Über die Sprache der Wandalen (Strassburg, 1886)*. For further references see K. Zeuss, *Die Deutschen*, p. 432 f. (where earlier references to the Crimean Goths are also given); F. Kluge, *op. cit.*, p. 515 ff.; and O. Bremer, *ib.* vol. iii., p. 822. (H. M. C.)

GOTLAND, an island in the Baltic Sea belonging to Sweden, lying between 57° and 58° N., and having a length from S.S.W. to N.N.E. of 75 m., a breadth not exceeding 30 m., and an area of 1142 sq. m. The nearest point on the mainland is 50 m. from the westernmost point of the island. With the island Fårö, off the northern extremity, the Karlsö, off the west coast, and Götiska Sandö, 25 m. N. by E., Gotland forms the administrative district (*län*) of Gotland. The island is a level plateau of Silurian limestone, rising gently eastward, of an average height of 80 to 100 ft., with steep coasts fringed with tapering, free-standing columns of limestone (*rauhkar*). A few low isolated hills rise inland. The climate is temperate, and the soil, although in parts dry and sterile, is mostly fertile. Former marshy moors have been largely drained and cultivated. There are extensive sand-dunes in the north. As usual in a limestone formation, some of the streams have their courses partly below the surface, and caverns are not infrequent. Less than half the total area is under forest, the extent of which was formerly much greater. Barley, rye, wheat and oats are grown, especially the first, which is exported to the breweries on the mainland. The sugar-beet is also produced and exported, and there are beet-sugar works on the island. Sheep and cattle are kept; there is a government sheep farm at Roma, and the cattle may be noted as belonging principally to an old native breed, yellow and horned. Some lime-burning, cement-making and sea-fishing are carried on. The capital of the island is Visby, on the west coast. There are over 80 m. of railways. Lines run from Visby N.E. to Tingstade and S. to Hofdhem, with branches from Roma to Klintehama, a small watering-place on the west coast, and to Slitehamn on the east. Excepting along the coast the island has no scenic attraction, but it is of the highest archaeological interest. Nearly every village has its ruined church, and others occur where no villages remain. The shrunken walled town of Visby was one of the richest commercial centres of the Baltic from the 11th to the 14th century, and its prosperity was shared by the whole island. It retains ten churches besides the cathedral. The massive towers of the village churches are often detached, and doubtless served purposes of defence. The churches of Roma, Hemse, with remarkable mural paintings, Othen and Lårö may be specially noted. Some contain fine stained glass, as at Dalhem near Visby. The natives of Gotland speak a dialect distinguished from that of any part of the Swedish mainland. Pop. of *län* (1900) 52,781.

Gotland was subject to Sweden before 890, and in 1030 was christianized by St Olaf, king of Norway, when returning from his exile at Kiev. He dedicated the first church in the island to St Peter at Visby. At that time Visby had long been one of the most important trading towns in the Baltic, and the chief distributing centre of the oriental commerce which came to Europe along the rivers of Russia. In the early years of the

Hanseatic League, or about the middle of the 13th century, it became the chief depôt for the produce of the eastern Baltic countries, including, in a commercial sense, its daughter colony (11th century or earlier) of Novgorod the Great. Although Visby was an independent member of the Hanseatic League, the influence of Lübeck was paramount in the city, and half its governing body were men of German descent. Indeed, Björkander endeavours to prove that the city was a German (Hanseatic) foundation, dating principally from the middle of the 13th century. However that may be, the importance of Visby in the sea trade of the North is conclusively attested by the famous code of maritime law which bears its name. This *Waterrecht dat de Koopliede en de Schippers gemacht hebben to Visby* ("sea-law which the merchants and seamen have made at Visby") was a compilation based upon the Lübeck code, the Oléron code and the Amsterdam code, and was first printed in Low German in 1505, but in all probability had its origin about 1240, or not much later (see SEA LAWS). By the middle of the 14th century the reputation of the wealth of the city was so great that, according to an old ballad, "the Gotlanders weighed out gold with stone weights and played with the choicest jewels. The swine ate out of silver troughs, and the women spun with distaffs of gold." This fabled wealth was too strong a temptation for the energetic Valdemar Atterdag of Denmark. In 1361 he invaded the island, routed the defenders of Visby under the city walls (a monolithic cross marks the burial-place of the islanders who fell) and plundered the city. From this blow it never recovered, its decay being, however, materially helped by the fact that for the greater part of the next 150 years it was the stronghold of successive freebooters or sea-rovers—first, of the Hanseatic privateers called *Vitalienbrödre* or *Viktuallensbrödre*, who made it their stronghold during the last eight years of the 14th century; then of the Teutonic Knights, whose Grand Master drove out the "Victuals Brothers," and kept the island until it was redeemed by Queen Margaret. There too Erik XIII. (the Pomeranian), after being driven out of Denmark by his own subjects, established himself in 1437, and for a dozen years waged piracy upon Danes and Swedes alike. After him came Olaf and Ivar Thott, two Danish lords, who down to the year 1487 terrorized the seas from their pirates' stronghold of Visby. Lastly, the Danish admiral Sören Norrby, the last supporter of Christian I. of Denmark, when his master's cause was lost, waged a guerrilla war upon the Danish merchant ships and others from the same convenient base. But this led to an expedition by the men of Lübeck, who partly destroyed Visby in 1525. By the peace of Stettin (1570) Gotland was confirmed to the Danish crown, to which it had been given by Queen Margaret. But at the peace of Brömsebro in 1645 it was at length restored to Sweden, to which it has since belonged, except for the three years 1676-1679, when it was forcibly occupied by the Danes, and a few weeks in 1808, when the Russians landed a force.

The extreme wealth of the Gotlanders naturally fostered a spirit of independence, and their relations with Sweden were curious. The island at one period paid an annual tribute of 60 marks of silver to Sweden, but it was clearly recognized that it was paid by the desire of the Gotlanders, and not enforced by Sweden. The pope recognized their independence, and it was by their own free will that they came under the spiritual charge of the bishop of Linköping. Their local government was republican in form, and a popular assembly is indicated in the written *Gotland Law*, which dates not later than the middle of the 13th century. Sweden had no rights of objection to the measures adopted by this body, and there was no Swedish judge or other official in the island. Visby had a system of government and rights independent of, and in some measure opposed to, that of the rest of the island. It seems clear that there were at one time two separate corporations, for the native Gotlanders and the foreign traders respectively, and that these were subsequently fused. The rights and status of native Gotlanders were not enjoyed by foreigners as a whole—even intermarriage was illegal—but Germans, on account of their commercial pre-eminence in the island, were excepted.

See C. H. Bergman, *Gotlands geograf och historis* (Stockholm, 1898) and *Gotlandska skildringar och minnen* (Visby, 1902); A. T. Snöbohm, *Gotlands land och folk* (Visby, 1897 et seq.); W. Moler, *Bidrag till en Gotländsk bibliografi* (Stockholm, 1890); Hans Hildebrand, *Visby och dess Minnesmärken* (Stockholm, 1892 et seq.); A. Björkander, *Till Visby Stads Aeldsta Historia* (1898), where most of the literature dealing with the subject is mentioned; but some of the author's arguments require criticism. For local government and rights see K. Hegel, *Städter und Gülden im Mittelalter* (book iii. ch. iii., Leipzig, 1891).

GOTO ISLANDS [GOTO RETTO, GOTTO], a group of islands belonging to Japan, lying west of Kiushiu, in 33° N., 129° E. The southern of the two principal islands, Fukae-shima, measures 17 m. by 13½; the northern, Nakaori-shima, measures 23 m. by 7½. These islands lie almost in the direct route of steamers plying between Nagasaki and Shanghai, and are distant some 50 m. from Nagasaki. Some dome-shaped hills command the old castle-town of Fukae. The islands are highly cultivated; deer and other game abound, and trout are plentiful in the mountain streams. A majority of the inhabitants are Christians.

GOTTER, FRIEDRICH WILHELM (1746-1797), German poet and dramatist, was born on the 3rd of September 1746, at Gotha. After the completion of his university career at Göttingen, he was appointed second director of the Archive of his native town, and subsequently went to Wetzlar, the seat of the imperial law courts, as secretary to the Saxe-Coburg-Gotha legation. In 1768 he returned to Gotha as tutor to two young noblemen, and here, together with H. C. Boie, he founded the famous *Göttinger Musenalmanach*. In 1770 he was once more in Wetzlar, where he belonged to Goethe's circle of acquaintances. Four years later he took up his permanent abode in Gotha, where he died on the 18th of March 1797. Gotter was the chief representative of French taste in the German literary life of his time. His own poetry is elegant and polished, and in great measure free from the trivialities of the Anacreontic lyric of the earlier generation of imitators of French literature; but he was lacking in the imaginative depth that characterizes the German poetic temperament. His plays, of which *Merope* (1774), an adaptation in admirable blank verse of the tragedies of Maffei and Voltaire, and *Medea* (1775), a *melodrame*, are best known, were mostly based on French originals and had considerable influence in counteracting the formlessness and irregularity of the *Sturm und Drang* drama. Gotter's collected *Gedichte* appeared in 2 vols. in 1787 and 1788; a third volume (1802) contains his *Literarischer Nachlass*. See B. Litzmann, *Schröder und Gotter* (1887), and R. Schlösser, *F. W. Gotter, sein Leben und seine Werke* (1894).

GOTTFRIED VON STRASSBURG, one of the chief German poets of the middle ages. The dates of his birth and death are alike unknown, but he was the contemporary of Hartmann von Aue, Wolfram von Eschenbach and Walther von der Vogelweide, and his epic *Tristan* was written about the year 1210. In all probability he did not belong to the nobility, as he is entitled *Meister*, never *Herr*, by his contemporaries; his poem—the only work that can with any certainty be attributed to him—bears witness to a learned education. The story of *Tristan* had been evolved from its shadowy Celtic origins by the French *brothers* of the early 12th century, and had already found its way into Germany before the close of that century, in the crude, unpolished version of Eilhart von Oberg. It was Gottfried, however, who gave it its final form. His version is based not on that of Chrétien de Troyes, but on that of a *brother* Thomas, who seems to have been more popular with contemporaries. A comparison of the German epic with the French original is, however, impossible, as Chrétien's *Tristan* is entirely lost, and of Thomas's only a few fragments have come down to us. The story centres in the fatal voyage which Tristan, a vassal to the court of his uncle King Marke of Cornwall, makes to Ireland to bring back Isolde as the king's bride. On the return voyage Tristan and Isolde drink by mistake a love potion, which binds them irrevocably to each other. The epic resolves itself into a series of love intrigues in which the two lovers ingeniously outwit the trusting king. They are ultimately discovered, and Tristan flees to Normandy where he marries another Isolde—"Isolde with the white hands"—

without being able to forget the blond Isolde of Ireland. At this point Gottfried's narrative breaks off and to learn the close of the story we have to turn to two minor poets of the time, Ulrich von Türlheim and Heinrich von Freiberg—the latter much the superior—who have supplied the conclusion. After further love adventures Tristan is fatally wounded by a poisoned spear in Normandy; the "blond Isolde," as the only person who has power to cure him, is summoned from Cornwall. The ship that brings her is to bear a white sail if she is on board, a black one if not. Tristan's wife, however, deceives him, announcing that the sail is black, and when Isolde arrives, she finds her lover dead. Marke at last learns the truth concerning the love potion, and has the two lovers buried side by side in Kurnewal.

It is difficult to form an estimate of Gottfried's independence of his French source; but it seems clear that he followed closely the narrative of events he found in Thomas. He has, however, introduced into the story an astounding fineness of psychological motive, which, to judge from a general comparison of the Arthurian epic in both lands, is German rather than French; he has spiritualized and deepened the narrative; he has, above all, depicted with a variety and insight, unusual in medieval literature, the effects of an overpowering passion. Yet, glowing and seductive as Gottfried's love-scenes are, they are never for a moment disfigured by frivolous hints or innuendo; the tragedy is unrolled with an earnestness that admits of no touch of humour, and also, it may be added, with a freedom from moralizing which was easier to attain in the 13th than in later centuries. The mastery of style is no less conspicuous. Gottfried had learned his best lessons from Hartmann von Aue, but he was a more original and daring artificer of rhymes and rhythms than that master; he delighted in the sheer music of words, and indulged in antitheses and allegorical conceits to an extent that proved fatal to his imitators. As far as beauty of expression is concerned, Gottfried's *Tristan* is the masterpiece of the German court epic.

Gottfried's *Tristan* has been frequently edited: by H. F. Massman (Leipzig, 1843); by R. Bechstein (2 vols., 3rd ed., Leipzig, 1890-1891); by W. Golther (2 vols., Stuttgart, 1899); by K. Marold (1906). Translations into modern German have been made by H. Kurz (Stuttgart, 1844); by K. Simrock (Leipzig, 1855); and, best of all, by W. Hertz (Stuttgart, 1877). There is also an abbreviated English translation by Jessie L. Weston (London, 1899). The continuation of Ulrich von Türlheim will be found in Massman's edition; that by Heinrich von Freiberg has been separately edited by R. Bechstein (Leipzig, 1877). See also R. Heinzel, "Gottfrieds von Strassburg *Tristan* und seine Quelle" in the *Zeits. für deut. Alt.* xiv. (1869), pp. 272 ff.; W. Golther, *Die Sage von Tristan und Isolde* (Munich, 1887); F. Piquet, *L'Originalité de Gottfried de Strassbourg dans son poème de Tristan et Isolde* (Lille, 1905). K. Immermann (q.v.) has written an epic of *Tristan und Isolde* (1840), R. Wagner (q.v.) a musical drama (1865). Cp. R. Bechstein, *Tristan und Isolde in der deutschen Dichtung der Neuzeit* (Leipzig, 1877).

GÖTTINGEN, a town of Germany, in the Prussian province of Hanover, pleasantly situated at the west foot of the Hainberg (1200 ft.), in the broad and fertile valley of the Leine, 67 m. S. from Hanover, on the railway to Cassel. Pop. (1875) 17,057, (1905) 34,030. It is traversed by the Leine canal, which separates the Altstadt from the Neustadt and from Masch, and is surrounded by ramparts, which are planted with lime-trees and form an agreeable promenade. The streets in the older part of the town are for the most part crooked and narrow, but the newer portions are spacious and regularly built. Apart from the Protestant churches of St John, with twin towers, and of St James, with a high tower (290 ft.), the medieval town hall, built in the 14th century and restored in 1880, and the numerous university buildings, Göttingen possesses few structures of any public importance. There are several thriving industries, including, besides the various branches of the publishing trade, the manufacture of cloth and woollens and of mathematical and other scientific instruments.

The university, the famous Georgia Augusta, founded by George II. in 1734 and opened in 1737, rapidly attained a leading position, and in 1823 its students numbered 1547. Political disturbances, in which both professors and students were im-

plicated, lowered the attendance to 860 in 1834. The expulsion in 1837 of the famous seven professors—*Die Göttinger Sieben*—viz. the Germanist, Wilhelm Eduard Albrecht (1800-1876); the historian, Friedrich Christoph Dahlmann (1785-1866); the orientalist, Georg Heinrich August Ewald (1803-1875); the historian, Georg Gottfried Gervinus (1805-1875); the physicist, Wilhelm Eduard Weber (1804-1891); and the philologists, the brothers Jacob Ludwig Karl Grimm (1785-1863), and Wilhelm Karl Grimm (1786-1859),—for protesting against the revocation by King Ernest Augustus of Hanover of the liberal constitution of 1833, further reduced the prosperity of the university. The events of 1848, on the other hand, told somewhat in its favour; and, since the annexation of Hanover in 1866, it has been carefully fostered by the Prussian government. In 1903 its teaching staff numbered 121 and its students 1529. The main university building lies on the Wilhelmsplatz, and, adjoining, is the famous library of 500,000 vols. and 5300 MSS., the richest collection of modern literature in Germany. There is a good chemical laboratory as well as adequate zoological, ethnographical and mineralogical collections, the most remarkable being Blumenbach's famous collection of skulls in the anatomical institute. There are also a celebrated observatory, long under the direction of Wilhelm Klinkerfues (1827-1884), a botanical garden, an agricultural institute and various hospitals, all connected with the university. Of the scientific societies the most noted is the Royal Society of Sciences (*Königliche Societät der Wissenschaften*) founded by Albrecht von Haller, which is divided into three classes, the physical, the mathematical and the historical-philological. It numbers about 80 members and publishes the well-known *Göttingische gelehrte Anzeigen*. There are monuments in the town to the mathematicians K. F. Gauss and W. E. Weber, and also to the poet G. A. Bürger.

The earliest mention of a village of Goding or Guting occurs in documents of about 950 A.D. The place received municipal rights from the German king Otto IV. about 1220, and from 1286 to 1463 it was the seat of the princely house of Brunswick-Göttingen. During the 14th century it held a high place among the towns of the Hanseatic League. In 1531 it joined the Reformation movement, and in the following century it suffered considerably in the Thirty Years' War, being taken by Tilly in 1626, after a siege of 25 days, and recaptured by the Saxons in 1632. After a century of decay, it was anew brought into importance by the establishment of its university; and a marked increase in its industrial and commercial prosperity has again taken place in recent years. Towards the end of the 18th century Göttingen was the centre of a society of young poets of the *Sturm und Drang* period of German literature, known as the *Göttingen Dichterbund* or *Hainbund* (see GERMANY: *Literature*).

See Freusdorff, *Göttingen in Vergangenheit und Gegenwart* (Göttingen, 1887); the *Urkundenbuch der Stadt Göttingen*, edited by G. Schmidt, A. Haselblatt and G. Kästner; Unger, *Göttingen und die Georgia Augusta* (1861); and *Göttinger Professoren* (Gotha, 1872); and O. Mejer, *Kulturgeschichtliche Bilder aus Göttinger* (1889).

GÖTTLING, CARL WILHELM (1793-1869), German classical scholar, was born at Jena on the 19th of January 1793. He studied at the universities of Jena and Berlin, took part in the war against France in 1814, and finally settled down in 1822 as professor at the university of his native town, where he continued to reside till his death on the 20th of January 1869. In his early years Götting devoted himself to German literature, and published two works on the Nibelungen: *Über das Geschichtliche im Nibelungenliede* (1814) and *Nibelungen und Gibelinen* (1817). The greater part of his life, however, was devoted to the study of classical literature, especially the elucidation of Greek authors. The contents of his *Gesammelte Abhandlungen aus dem klassischen Altertum* (1851-1863) and *Opuscula Academica* (published in 1866 after his death) sufficiently indicate the varied nature of his studies. He edited the *Τέχνη* (grammatical manual) of Theodosius of Alexandria (1822), Aristotle's *Politics* (1824), and *Economics* (1830) and Hesiod (1831; 3rd ed. by J. Flach, 1878). Mention may also be made of his *Allgemeine Lehre vom Accent der griechischen Sprache* (1835), enlarged from a

smaller work, which was translated into English (1831) as the *Elements of Greek Accentuation*; and of his *Correspondence with Goethe* (published 1880).

See memoirs by C. Nipperdey, his colleague at Jena (1869), G. Lohholz (Stargard, 1876), K. Fischer (preface to the *Opuscula Academica*), and C. Burian in *Allgemeine deutsche Biographie*, ix.

GOTTSCHALK [GODESCALUS, GOTTSCHALE], (c. 808-867?), German theologian, was born near Mainz, and was devoted (*oblatus*) from infancy by his parents,—his father was a Saxon, Count Bern,—to the monastic life. He was trained at the monastery of Fulda, then under the abbot Hrabanus Maurus, and became the friend of Walafrid Strabo and Loup of Ferrières. In June 829, at the synod of Mainz, on the pretext that he had been unduly constrained by his abbot, he sought and obtained his liberty, withdrew first to Corbie, where he met Ratramnus, and then to the monastery of Orbais in the diocese of Soissons. There he studied St Augustine, with the result that he became an enthusiastic believer in the doctrine of absolute predestination, in one point going beyond his master—Gottschalk believing in a predestination to condemnation as well as in a predestination to salvation, while Augustine had contented himself with the doctrine of preterition as complementary to the doctrine of election. Between 835 and 840 Gottschalk was ordained priest, without the knowledge of his bishop, by Rigbold, *chorepiscopus* of Reims. Before 840, deserting his monastery, he went to Italy, preached there his doctrine of double predestination, and entered into relations with Notting, bishop of Verona, and Eberhard, count of Friuli. Driven from Italy through the influence of Hrabanus Maurus, now archbishop of Mainz, who wrote two violent letters to Notting and Eberhard, he travelled through Dalmatia, Pannonia and Norica, but continued preaching and writing. In October 848 he presented to the synod at Mainz a profession of faith and a refutation of the ideas expressed by Hrabanus Maurus in his letter to Notting. He was convicted, however, of heresy, beaten, obliged to swear that he would never again enter the territory of Louis the German, and handed over to Hincmar, archbishop of Reims, who sent him back to his monastery at Orbais. The next year at a provincial council at Quierzy, presided over by Charles the Bald, he attempted to justify his ideas, but was again condemned as a heretic and disturber of the public peace, was degraded from the priesthood, whipped, obliged to burn his declaration of faith, and shut up in the monastery of Hautvillers. There Hincmar tried again to induce him to retract. Gottschalk however continued to defend his doctrine, writing to his friends and to the most eminent theologians of France and Germany. A great controversy resulted. Prudentius, bishop of Troyes, Wenilo of Sens, Ratramnus of Corbie, Loup of Ferrières and Florus of Lyons wrote in his favour. Hincmar wrote *De predestinatione* and *De una non trina deitate* against his views, but gained little aid from Johannes Scotus Erigena, whom he had called in as an authority. The question was discussed at the councils of Kiersy (853), of Valence (855) and of Savonnières (859). Finally the pope Nicolas I. took up the case, and summoned Hincmar to the council of Metz (863). Hincmar either could not or would not appear, but declared that Gottschalk might go to defend himself before the pope. Nothing came of this, however, and when Hincmar learned that Gottschalk had fallen ill, he forbade him the sacraments or burial in consecrated ground unless he would recant. This Gottschalk refused to do. He died on the 30th of October between 866 and 870.

Gottschalk was a vigorous and original thinker, but also of a violent temperament, incapable of discipline or moderation in his ideas as in his conduct. He was less an innovator than a reactionary. Of his many works we have only the two professions of faith (cf. Migne, *Patrologia Latina*, cxxi. c. 347 et seq.), and some poems, edited by L. Traube in *Monumenta Germaniae historica: Poetae Latini aevi Carolini* (t. iii. 707-738). Some fragments of his theological treatises have been preserved in the writings of Hincmar, Erigena, Ratramnus and Loup of Ferrières.

From the 17th century, when the Jansenists exalted Gottschalk, much has been written on him. Mention may be made of two recent studies, F. Picavet, "Les Discussions sur la liberté au temps

de Gottschalk, de Raban Maur, d'Hincmar, et de Jean Scot" in *Comptes rendus de l'acad. des sciences morales et politiques* (Paris, 1896); and A. Freystedt, "Studien zu Gottschalks Leben und Lehre," in *Zeitschrift für Kirchengeschichte* (1897), vol. xviii.

GOTTSCHALL, RUDOLF VON (1823-1909), German man of letters, was born at Breslau on the 30th of September 1823, the son of a Prussian artillery officer. He received his early education at the gymnasia in Mainz and Coburg, and subsequently at Rastenburg in East Prussia. In 1841 he entered the university of Königsberg as a student of law, but, in consequence of his pronounced liberal opinions, was expelled. The academic authorities at Breslau and Leipzig were not more tolerant towards the young fire-eater, and it was only in Berlin that he eventually found himself free to prosecute his studies. During this period of unrest he issued *Lieder der Gegenwart* (1842) and *Zensurflüchtlinge* (1843)—the poetical fruits of his political enthusiasm. He completed his studies in Berlin, took the degree of *doctor juris* in Königsberg, and endeavoured to obtain there the *venia legendi*. His political views again stood in the way, and forsaking the legal career, Gottschall now devoted himself entirely to literature. He met with immediate success, and beginning as dramaturge in Königsberg with *Der Blinden Alcala* (1846) and *Lord Byron in Italien* (1847) proceeded to Hamburg where he occupied a similar position. In 1852 he married Marie, baroness von Seherr-Thoos, and for the next few years lived in Silesia. In 1862 he took over the editorship of a Posen newspaper, but in 1864 removed to Leipzig. Gottschall was raised, in 1877, by the king of Prussia to the hereditary nobility with the prefix "von," having been previously made a *Gehheimer Hofrat* by the grand duke of Weimar. Down to 1887 Gottschall edited the *Brockhaus'sche Blätter für literarische Unterhaltung* and the monthly periodical *Unsere Zeit*. He died at Leipzig on the 21st of March 1909.

Gottschall's prolific literary productions cover the fields of poetry, novel-writing and literary criticism. Among his volumes of lyric poetry are *Sebastopol* (1856), *Janus* (1873), *Bunte Blüten* (1891). Among his epics, *Carlo Zeno* (1854), *Maja* (1864), dealing with an episode in the Indian Mutiny, and *Merlins Wanderungen* (1887). The comedy *Pill und Foz* (1854), first produced on the stage in Breslau, was never surpassed by the other lighter pieces of the author, among which may be mentioned *Die Welt des Schwindels* and *Der Spion von Rheinsberg*. The tragedies, *Masappa*, *Catharine Howard*, *Amy Robart* and *Der Gäss von Venedig*, were very successful; and the historical novels, *Im Banne des schwarzen Adlers* (1875; 4th ed., 1884), *Die Erbschaft des Blutes* (1881), *Die Tochter Rübenahls* (1889), and *Verkümmerte Existenzen* (1892), enjoyed a high degree of popularity. As a critic and historian of literature Gottschall has also done excellent work. His *Die deutsche Nationalliteratur des 19. Jahrhunderts* (1855; 7th ed., 1901-1902), and *Poetik* (1858; 6th ed., 1903) command the respect of all students of literature.

Gottschall's collected *Dramatische Werke* appeared in 12 vols. in 1880 (2nd ed., 1884); he has also, in recent years, published many volumes of collected essays and criticisms. See his autobiography, *Aus meiner Jugend* (1898).

GOTTSCHED, JOHANN CHRISTOPH (1700-1766), German author and critic, was born on the 2nd of February 1700, at Judithenkirch near Königsberg, the son of a Lutheran clergyman. He studied philosophy and history at the university of his native town, but immediately on taking the degree of *Magister* in 1723, fled to Leipzig in order to evade impressment in the Prussian military service. Here he enjoyed the protection of J. B. Mencke (1674-1732), who, under the name of "Philander von der Linde," was a well-known poet and also president of the *Deutschübende poetische Gesellschaft* in Leipzig. Of this society Gottsched was elected "Senior" in 1726, and in the next year reorganized it under the title of the *Deutsche Gesellschaft*. In 1730 he was appointed extraordinary professor of poetry, and, in 1734, ordinary professor of logic and metaphysics in the university. He died at Leipzig on the 12th of December 1766.

Gottsched's chief work was his *Versuch einer kritischen Dichtkunst für die Deutschen* (1730), the first systematic treatise in German on the art of poetry from the standpoint of Boileau. His *Ausführliche Redekunst* (1728) and his *Grundlegung einer*

deutschen Sprachkunst (1748) were of importance for the development of German style and the purification of the language. He wrote several plays, of which *Der sterbende Calo* (1732), an adaptation of Addison's tragedy and a French play on the same theme, was long popular on the stage. In his *Deutsche Schaubühne* (6 vols., 1740-1745), which contained mainly translations from the French, he provided the German stage with a classical repertory, and his bibliography of the German drama, *Nötiger Vorrat zur Geschichte der deutschen dramatischen Dichtkunst* (1757-1765), is still valuable. He was also the editor of several journals devoted to literary criticism. As a critic, Gottsched insisted on German literature being subordinated to the laws of French classicism; he enunciated rules by which the playwright must be bound, and abolished bombast and buffoonery from the serious stage. While such reforms obviously afforded a healthy corrective to the extravagance and want of taste which were rampant in the German literature of the time, Gottsched went too far. In 1740 he came into conflict with the Swiss writers Johann Jakob Bodmer (q.v.) and Johann Jakob Breitinger (1701-1776), who, under the influence of Addison and contemporary Italian critics, demanded that the poetic imagination should not be hampered by artificial rules; they pointed to the great English poets, and especially to Milton. Gottsched, although not blind to the beauties of the English writers, clung the more tenaciously to his principle that poetry must be the product of rules, and, in the fierce controversy which for a time raged between Leipzig and Zürich, he was inevitably defeated. His influence speedily declined, and before his death his name became proverbial for pedantic folly.

His wife, Luise Adelgunde Victorie, née Kulmus (1713-1762), in some respects her husband's intellectual superior, was an author of some reputation. She wrote several popular comedies, of which *Das Testament* is the best, and translated the *Spectator* (9 vols., 1739-1743), Pope's *Rape of the Lock* (1744) and other English and French works. After her death her husband edited her *Sämmtliche kleinere Gedichte* with a memoir (1763).

See T. W. Danzel, *Gottsched und seine Zeit* (Leipzig, 1848); J. Crüger, *Gottsched, Bodmer, und Breitinger* (with selections from their writings) (Stuttgart, 1884); F. Servaes, *Die Poetik Gottscheds und der Schweizer* (Strassburg, 1887); E. Wolff, *Gottscheds Stellung im deutschen Bildungsleben* (2 vols., Kiel, 1895-1897), and G. Waniek, *Gottsched und die deutsche Literatur seiner Zeit* (Leipzig, 1897). On Frau Gottsched, see P. Schlenker, *Frau Gottsched und die bürgerliche Komödie* (Berlin, 1886).

GÖTZ, JOHANN NIKOLAUS (1721-1781), German poet, was born at Worms on the 9th of July 1721. He studied theology at Halle (1739-1742), where he became intimate with the poets Johann W. L. Gleim and Johann Peter Uz, acted for some years as military chaplain, and afterwards filled various other ecclesiastical offices. He died at Winterburg on the 4th of November 1781. The writings of Götz consist of a number of short lyrics and several translations, of which the best is a rendering of Anacreon. His original compositions are light, lively and sparkling, and are animated rather by French wit than by German depth of sentiment. The best known of his poems is *Die Mädcheninsel*, an elegy which met with the warm approval of Frederick the Great.

Götz's *Vermischte Gedichte* were published with biography by K. W. Ramler (Mannheim, 1785; new ed., 1807), and a collection of his poems, dating from the years 1745-1765, has been edited by C. Schüddekopf in the *Deutsche Literaturdenkmale des 18. und 19. Jahrhunderts* (1893). See also *Briefe von und an J. N. Götz*, edited by C. Schüddekopf (1893).

GOUACHE, a French word adapted from the Ital. *guazzo* (probably in origin connected with "wash"), meaning literally a "ford," but used also for a method of painting in opaque water-colour. The colours are mixed with or painted in a vehicle of gum or honey, and whereas in true water-colours the high lights are obtained by leaving blank the surface of the paper or other material used, or by allowing it to show through a translucent wash in "gouache," these are obtained by white or other light colour. "Gouache" is frequently used in miniature painting.

GOUDA (or **TEE GOUWE**), a town of Holland, in the province of South Holland, on the north side of the Gouwe at its confluence with the Ysel, and a junction station 12½ m. by rail N.E. of Rotterdam. Pop. (1900) 22,303. Tramways connect it with Bodegraven (5½ m. N.) on the old Rhine and with Oudewater (8 m. E.) on the Ysel; and there is a regular steamboat service in various directions, Amsterdam being reached by the canalized Gouwe; Aar, Drecht and Amstel. The town of Gouda is laid out in a fine open manner and, like other Dutch towns, is intersected by numerous canals. On its outskirts pleasant walks and fine trees have replaced the old fortifications. The Groote Markt is the largest market-square in Holland. Among the numerous churches belonging to various denominations, the first place must be given to the Groote Kerk of St John. It was founded in 1485, but rebuilt after a fire in 1552, and is remarkable for its dimensions (345 ft. long and 150 ft. broad), for a large and celebrated organ, and a splendid series of over forty stained-glass windows presented by cities and princes and executed by various well-known artists, including the brothers Dirk (d. c. 1577) and Wouter (d. c. 1590) Crabeth, between the years 1555 and 1603 (see *Explanations of the Famous and Renowned Glass Works, &c.*, Gouda, 1876, reprinted from an older volume, 1718). Other noteworthy buildings are the Gothic town hall, founded in 1449 and rebuilt in 1690, and the weigh-house built by Pieter Post of Haarlem (1608-1669) and adorned with a fine relief by Barth. Eggers (d. c. 1690). The museum of antiquities (1874) contains an exquisite chalice of the year 1425 and some pictures and portraits by Wouter Crabeth the younger, Corn. Ketel (a native of Gouda, 1548-1616) and Ferdinand Bol (1616-1680). Other buildings are the orphanage, the hospital, a house of correction for women and a music hall.

In the time of the counts the wealth of Gouda was mainly derived from brewing and cloth-weaving; but at a later date the making of clay tobacco pipes became the staple trade, and, although this industry has somewhat declined, the churchwarden pipes of Gouda are still well known and largely manufactured. In winter-time it is considered a feat to skate hither from Rotterdam and elsewhere to buy such a pipe and return with it in one's mouth without its being broken. The mud from the Ysel furnishes the material for large brick-works and potteries; there are also a celebrated manufactory of stearine candles, a yarn factory, an oil refinery and cigar factories. The transit and shipping trade is considerable, and as one of the principal markets of South Holland, the round, white Gouda cheeses are known throughout Europe. Boskoop, 5 m. N. by W. of Gouda on the Gouwe, is famous for its nursery gardens; and the little old-world town of Oudewater as the birthplace of the famous theologian Arminius in 1560. The town hall (1588) of Oudewater contains a picture by Dirk Stoop (d. 1686), commemorating the capture of the town by the Spaniards in 1575 and the subsequent sack and massacre.

GOUDIMEL, CLAUDE, musical composer of the 16th century, was born about 1510. The French and the Belgians claim him as their countryman. In all probability he was born at Besançon, for in his edition of the songs of Arcadelt, as well as in the mass of 1554, he calls himself "natif de Besançon" and "Claudius Godimellus Vescontinus." This discountenances the theory of Ambros that he was born at Vaison near Avignon. As to his early education we know little or nothing, but the excellent Latin in which some of his letters were written proves that, in addition to his musical knowledge, he also acquired a good classical training. It is supposed that he was in Rome in 1540 at the head of a music-school, and that besides many other celebrated musicians, Palestrina was amongst his pupils. About the middle of the century he seems to have left Rome for Paris, where, in conjunction with Jean Duchemin, he published, in 1555, a musical setting of Horace's Odes. Infinitely more important is another collection of vocal pieces, a setting of the celebrated French version of the Psalms by Marot and Bera published in 1565. It is written in four parts, the melody being assigned to the tenor. The invention of the melodies was long ascribed to Goudimel, but they have now definitely been proved

to have originated in popular tunes found in the collections of this period. Some of these tunes are still used by the French Protestant Church. Others were adopted by the German Lutherans, a German imitation of the French versions of the Psalms in the same metres having been published at an early date. Although the French version of the Psalms was at first used by Catholics as well as Protestants, there is little doubt that Goudimel had embraced the new faith. In Michel Brenet's *Biographie (Annales franco-cantaises, Besançon, 1898, P. Jacquin)* it is established that in Metz, where he was living in 1565, Goudimel moved in Huguenot circles, and even figured as godfather to the daughter of the president of Senneton. Seven years later he fell a victim to religious fanaticism during the St Bartholomew massacres at Lyons from the 27th to the 28th of August 1572, his death, it is stated, being due to "les ennemis de la gloire de Dieu et quelques méchants envieux de l'honneur qu'il avait acquis." Masses and motets belonging to his Roman period are found in the Vatican library, and in the archives of various churches in Rome; others were published. Thus the work entitled *Missae tres a Claudio Goudimel præstantissimo musico auctore, nunc primum in lucem editæ*, contains one mass by the learned editor himself, the other two being by Claudius Sermisy and Jean Maillard respectively. Another collection, *La Fleur des chansons des deux plus excellens musiciens de nostre temps*, consists of part songs by Goudimel and Orlando di Lasso. Burney gives in his history a motet of Goudimel's *Domine quid multiplicati sunt*.

GOUFFIER, the name of a great French family, which owned the estate of Bonnavet in Poitou from the 14th century. **GUILLAUME GOUFFIER**, chamberlain to Charles VII., was an inveterate enemy of Jacques Cœur, obtaining his condemnation and afterwards receiving his property (1491). He had a great number of children, several of whom played a part in history. **ARTUS**, seigneur de Boisy (c. 1475-1520) was entrusted with the education of the young count of Angoulême (Francis I.), and on the accession of this prince to the throne as Francis I. became grand master of the royal household, playing an important part in the government; to him was given the task of negotiating the treaty of Noyon in 1516; and shortly before his death the king raised the estates of Roanne and Boisy to the rank of a duchy, that of Roannais, in his favour. **ADRIEN GOUFFIER** (d. 1523) was bishop of Coutances and Albi, and grand almoner of France. **GUILLAUME GOUFFIER**, seigneur de Bonnavet, became admiral of France (see **BONNIVET**). **CLAUDE GOUFFIER**, son of Artus, was created comte de Maulevrier (1542) and marquis de Boisy (1564).

There were many branches of this family, the chief of them being the dukes of Roannais, the counts of Caravas, the lords of Crèvecœur and of Bonnavet, the marquises of Thoix, of Brazeux, and of Espagny. The name of Gouffier was adopted in the 18th century by a branch of the house of Choiseul. (M. P.)

GOUGE, MARTIN (c. 1360-1444), surnamed **DE CHARPAGNE**, French chancellor, was born at Bourges about 1360. A canon of Bourges, in 1402 he became treasurer to John, duke of Berry, and in 1406 bishop of Chartres. He was arrested by John the Fearless, duke of Burgundy, with the hapless Jean de Montaigu (1349-1409) in 1409, but was soon released and then banished. Attaching himself to the dauphin Louis, duke of Guienne, he became his chancellor, the king's ambassador in Brittany, and a member of the grand council; and on the 13th of May 1415, he was transferred from the see of Chartres to that of Clermont-Ferrand. In May 1418, when the Burgundians re-entered Paris, he only escaped death at their hands by taking refuge in the Bastille. He then left Paris, but only to fall into the hands of his enemy, the duke of la Trémoille, who imprisoned him in the castle of Sully. Rescued by the dauphin Charles, he was appointed chancellor of France on the 3rd of February 1422. He endeavoured to reconcile Burgundy and France, was a party to the selection of Arthur, earl of Richmond, as constable, but had to resign his chancellorship in favour of Regnault of Chartres; first from March 25th to August 6th 1425, and again when La Trémoille had supplanted Richmond. After the fall of La

Trémoille in 1433 he returned to court, and exercised a powerful influence over affairs of state almost till his death, which took place at the castle of Beaulieu (Puy-de-Dôme) on the 25th or 26th of November 1444.

See Hiver's account in the *Mémoires de la Société des Antiquaires du Centre*, p. 267 (1869); and the *Nouvelle Biographie générale*, vol. xxi.

GOUGE (adopted from the Fr. *gouge*, derived from the Late Lat. *gubia* or *gubia*, in Ducange *gubium*, an implement *ad hortum excolendum*, and also *instrumentum ferreum in usu fabrorum*; according to the *New English Dictionary* the word is probably of Celtic origin, *gyff*, a beak, appearing in Welsh, and *güb*, a boring tool, in Cornish), a tool of the chisel type with a curved blade, used for scooping a groove or channel in wood, stone, &c. (see **TOOL**). A similar instrument is used in surgery for operations involving the excision of portions of bone. "Gouge" is also used as the name of a bookbinder's tool, for impressing a curved line on the leather, and for the line so impressed. In mining, a "gouge" is the layer of soft rock or earth sometimes found in each side of a vein of coal or ore, which the miner can scoop out with his pick, and thus attack the vein more easily from the side. The verb "to gouge" is used in the sense of scooping or forcing out.

GOUGH, HUGH GOUGH, VISCOUNT (1779-1869), British field-marshal, a descendant of Francis Gough who was made bishop of Limerick in 1626, was born at Woodstown, Limerick, on the 3rd of November 1779. Having obtained a commission in the army in August 1794, he served with the 78th Highlanders at the Cape of Good Hope, taking part in the capture of Cape Town and of the Dutch fleet in Saldanha Bay in 1796. His next service was in the West Indies, where, with the 87th (Royal Irish Fusiliers), he shared in the attack on Porto Rico, the capture of Surinam, and the brigand war in St Lucia. In 1809 he was called to take part in the Peninsular War, and, joining the army under Wellington, commanded his regiment as major in the operations before Oporto, by which the town was taken from the French. At Talavera he was severely wounded, and had his horse shot under him. For his conduct on this occasion he was afterwards promoted lieutenant-colonel, his commission, on the recommendation of Wellington, being antedated from the day of the duke's despatch. He was thus the first officer who ever received brevet rank for services performed in the field at the head of a regiment. He was next engaged at the battle of Barrosa, at which his regiment captured a French eagle. At the defence of Tarifa the post of danger was assigned to him, and he compelled the enemy to raise the siege. At Vitoria, where Gough again distinguished himself, his regiment captured the baton of Marshal Jourdan. He was again severely wounded at Nivelle, and was soon after created a knight of St Charles by the king of Spain. At the close of the war he returned home and enjoyed a respite of some years from active service. He next took command of a regiment stationed in the south of Ireland, discharging at the same time the duties of a magistrate during a period of agitation. Gough was promoted major-general in 1830. Seven years later he was sent to India to take command of the Mysore division of the army. But not long after his arrival in India the difficulties which led to the first Chinese war made the presence of an energetic general on the scene indispensable, and Gough was appointed commander-in-chief of the British forces in China. This post he held during all the operations of the war; and by his great achievements and numerous victories in the face of immense difficulties, he at length enabled the English plenipotentiary, Sir H. Pottinger, to dictate peace on his own terms. After the conclusion of the treaty of Nanking in August 1842 the British forces were withdrawn; and before the close of the year Gough, who had been made a G.C.B. in the previous year for his services in the capture of the Canton forts, was created a baronet. In August 1843 he was appointed commander-in-chief of the British forces in India, and in December he took the command in person against the Mahrattas, and defeated them at Maharajpur, capturing more than fifty guns. In 1845 occurred the rupture with the Sikhs,

who crossed the Sutlej in large numbers, and Sir Hugh Gough conducted the operations against them, being well supported by Lord Hardinge, the governor-general, who volunteered to serve under him. Successes in the hard-fought battles of Mudki and Ferozshah were succeeded by the victory of Sobraon, and shortly afterwards the Sikhs sued for peace at Lahore. The services of Sir Hugh Gough were rewarded by his elevation to the peerage of the United Kingdom as Baron Gough (April 1846). The war broke out again in 1848, and again Lord Gough took the field; but the result of the battle of Chillianwalla being equivocal, he was superseded by the home authorities in favour of Sir Charles Napier; before the news of the supersession arrived Lord Gough had finally crushed the Sikhs in the battle of Gujarat (February 1849). His tactics during the Sikh wars were the subject of an embittered controversy (see SIKH WARS). Lord Gough now returned to England, was raised to a viscounty, and for the third time received the thanks of both Houses of Parliament. A pension of £2000 per annum was granted to him by parliament, and an equal pension by the East India Company. He did not again see active service. In 1854 he was appointed colonel of the Royal Horse Guards, and two years later he was sent to the Crimea to invest Marshal Pélissier and other officers with the insignia of the Bath. Honours were multiplied upon him during his latter years. He was made a knight of St Patrick, being the first knight of the order who did not hold an Irish peerage, was sworn a privy councillor, was named a G.C.S.I., and in November 1862 was made field-marshal. He was twice married, and left children by both his wives. He died on the 2nd of March 1866.

See R. S. Rait, *Lord Gough* (1903); and Sir W. Lee Warner, *Lord Dalhousie* (1904).

GOUGH, JOHN BARTHOLOMEW (1817-1886), American temperance orator, was born at Sandgate, Kent, England, on the 22nd of August 1817. He was educated by his mother, a schoolmistress, and at the age of twelve was sent to the United States to seek his fortune. He lived for two years with family friends on a farm in western New York, and then entered a book-binding in New York City to learn the trade. There in 1833 his mother joined him, but after her death in 1835 he fell in with dissolute companions, and became a confirmed drunkard. He lost his position, and for several years supported himself as a ballad singer and story-teller in the cheap theatres and concert-halls of New York and other eastern cities. Even this means of livelihood was being closed to him, when in Worcester, Massachusetts, in 1842 he was induced to sign a temperance pledge. After several lapses and a terrific struggle, he determined to devote his life to lecturing in behalf of temperance reform. Gifted with remarkable powers of pathos and of description, he was successful from the start, and was soon known and sought after throughout the entire country, his appeals, which were directly personal and emotional, being attended with extraordinary responses. He continued his work until the end of his life, made several tours of England, where his American success was repeated, and died at his work, being stricken with apoplexy on the lecture platform at Frankford, Pennsylvania, where he passed away two days later, on the 18th of February 1886. He published an *Autobiography* (1846); *Orations* (1854); *Temperance Addresses* (1870); *Temperance Lectures* (1879); and *Sunlight and Shadow, or Gleanings from My Life Work* (1880).

GOUGH, RICHARD (1735-1809), English antiquary, was born in London on the 21st of October 1735. His father was a wealthy M.P. and director of the East India Company. Gough was a precocious child, and at twelve had translated from the French a history of the Bible, which his mother printed for private circulation. When fifteen he translated Abbé Fleury's work on the Israelites; and at sixteen he published an elaborate work entitled *Atlas Renovatus, or Geography modernised*. In 1752 he entered Corpus Christi College, Cambridge, where he began his work on British topography, published in 1768. Leaving Cambridge in 1756, he began a series of antiquarian excursions in various parts of Great Britain. In 1773 he began an edition in English of Camden's *Britannia*, which appeared in 1789.

Meantime he published, in 1786, the first volume of his splendid work, the *Sepulchral Monuments of Great Britain*, applied to illustrate the history of families, manners, habits, and arts at the different periods from the Norman Conquest to the Seventeenth Century. This volume, which contained the first four centuries, was followed in 1796 by a second volume containing the 15th century, and an introduction to the second volume appeared in 1799. Gough was chosen a fellow of the Society of Antiquaries of London in 1767, and from 1771 to 1791 he was its director. He was elected F.R.S. in 1775. He died at Enfield on the 20th of February 1809. His books and manuscripts relating to Anglo-Saxon and northern literature, all his collections in the department of British topography, and a large number of his drawings and engravings of other archaeological remains, were bequeathed to the university of Oxford.

Among the minor works of Gough are *An Account of the Bedford Missal* (in MS.); *A Catalogue of the Coins of Canute, King of Denmark* (1777); *History of Pleshy in Essex* (1803); *An Account of the Coins of the Seleucidae, Kings of Syria* (1804); and *History of the Society of Antiquaries of London*, prefixed to their *Archæologia*.

GOUJET, CLAUDE PIERRE (1697-1767), French abbé and littérateur, was born in Paris on the 10th of October 1697. He studied at the College of the Jesuits, and at the Collège Mazarin, but he nevertheless became a strong Jansenist. In 1705 he assumed the ecclesiastical habit, in 1719 entered the order of Oratorians, and soon afterwards was named canon of St Jacques l'Hôpital. On account of his extreme Jansenist opinions he suffered considerable persecution from the Jesuits, and several of his works were suppressed at their instigation. In his latter years his health began to fail, and he lost his eyesight. Poverty compelled him to sell his library, a sacrifice which hastened his death, which took place at Paris on the 1st of February 1767.

He is the author of *Supplément au dictionnaire de Moréri* (1735), and a *Nouveau Supplément* to a subsequent edition of the work; he collaborated in *Bibliothèque française, ou histoire littéraire de la France* (18 vols., Paris, 1740-1759); and in the *Vies des saints* (7 vols., 1730); he also wrote *Mémoires historiques et littéraires sur le collège royal de France* (1758); *Histoire des Inquisitions* (Paris, 1752); and supervised an edition of Richetel's *Dictionnaire*, of which he has also given an abridgment. He helped the abbé Fabre in his continuation of Fleury's *Histoire ecclésiastique*.

See *Mémoires hist. et litt. de l'abbé Goujet* (1767).

GOUJON, JEAN (c. 1520-c. 1566), French sculptor of the 16th century. Although some evidence has been offered in favour of the date 1520 (*Archives de l'art français*, iii. 350), the time and place of his birth are still uncertain. The first mention of his name occurs in the accounts of the church of St Maclou at Rouen in the year 1540, and in the following year he was employed at the cathedral of the same town, where he added to the tomb of Cardinal d'Amboise a statue of his nephew Georges, afterwards removed, and possibly carved portions of the tomb of Louis de Brezé, executed some time after 1545. On leaving Rouen, Goujon was employed by Pierre Lescot, the celebrated architect of the Louvre, on the restorations of St-Germain l'Auxerrois; the building accounts—some of which for the years 1542-1544 were discovered by M. de Laborde on a piece of parchment binding—specify as his work, not only the carvings of the pulpit (Louvre), but also a Notre Dame de Piété, now lost. In 1547 appeared Martin's French translation of Vitruvius, the illustrations of which were due, the translator tells us in his "Dedication to the King," to Goujon, "naguères architecte de Monseigneur le Connétable, et maintenant un des vôtres." We learn from this statement not only that Goujon had been taken into the royal service on the accession of Henry II., but also that he had been previously employed under Bullant on the château of Écouen. Between 1547 and 1549 he was employed in the decoration of the Loggia ordered from Lescot for the entry of Henry II. into Paris, which took place on the 16th of June 1549. Lescot's edifice was reconstructed at the end of the 18th century by Bernard Poyet into the Fontaine des Innocents, this being a considerable variation of the original design. At the Louvre, Goujon, under the direction of Lescot, executed the carvings of the south-west angle of the court, the

reliefs of the Escalier Henri II., and the Tribune des Caryatides, for which he received 737 livres on the 5th of September 1550. Between 1548 and 1554 rose the château d'Anet, in the embellishment of which Goujon was associated with Philibert Delorme in the service of Diana of Poitiers. Unfortunately the building accounts of Anet have disappeared, but Goujon executed a vast number of other works of equal importance, destroyed or lost in the great Revolution. In 1555 his name appears again in the Louvre accounts, and continues to do so every succeeding year up to 1562, when all trace of him is lost. In the course of this year an attempt was made to turn out of the royal employment all those who were suspected of Huguenot tendencies. Goujon has always been claimed as a Reformer; it is consequently possible that he was one of the victims of this attack. We should therefore probably ascribe the work attributed to him in the Hôtel Carnavalet (*in situ*), together with much else executed in various parts of Paris—but now dispersed or destroyed—to a period intervening between the date of his dismissal from the Louvre and his death, which is computed to have taken place between 1564 and 1568, probably at Bologna. The researches of M. Tomaso Sandonni (see *Gazette des Beaux Arts*, 2^e période, vol. xxxi.) have finally disposed of the supposition, long entertained, that Goujon died during the St Bartholomew massacre in 1572.

List of authentic works of Jean Goujon: Two marble columns supporting the organ of the church of St Maclou (Rouen) on right and left of porch on entering; left-hand gate of the church of St Maclou; bas-reliefs for decoration of screen of St Germain l'Auxerrois (now in Louvre); "Victory" over chimney-piece of Salle des Gardes at Écouen; altar at Chantilly; illustrations for Jean Martin's translation of Vitruvius; bas-reliefs and sculptural decoration of Fontaine des Innocents; bas-reliefs adorning entrance of Hôtel Carnavalet, also series of satyrs' heads on keystones of arcade of courtyard; fountain of Diana from Anet (now in Louvre); internal decoration of chapel at Anet; portico of Anet (now in courtyard of École des Beaux Arts); bust of Diane de Poitiers (now at Versailles); Tribune of Caryatides in the Louvre; decoration of "Escalier Henri II.," Louvre; *œils de bœuf* and decoration of Henri II. façade, Louvre; groups for pediments of façade now placed over entrance to Egyptian and Assyrian collections, Louvre.

See A. A. Pottier, *Œuvres de Goujon* (1844); Reginald Lister, *Jean Goujon* (London, 1903).

GOUJON, JEAN MARIE CLAUDE ALEXANDRE (1766–1795), French publicist and statesman, was born at Bourg on the 13th of April 1766, the son of a postmaster. The boy went early to sea, and saw fighting when he was twelve years old; in 1790 he settled at Meudon, and began to make good his lack of education. As procureur-général-syndic of the department of Seine-et-Oise, in August, 1792, he had to supply the inhabitants with food, and fulfilled his difficult functions with energy and tact. In the Convention, which he entered on the death of Hérald de Séchelles, he took his seat on the benches of the Mountain. He conducted a mission to the armies of the Rhine and the Moselle with creditable moderation, and was a consistent advocate of peace within the republic. Nevertheless, he was a determined opponent of the counter-revolution, which he denounced in the Jacobin Club and from the Mountain after his recall to Paris, following on the revolution of the 9th Thermidor (July 27, 1794). He was one of those who protested against the readmission of Louvet and other survivors of the Girondin party to the Convention in March 1795; and, when the populace invaded the legislature on the 1st Prairial (May 20, 1795) and compelled the deputies to legislate in accordance with their desires, he proposed the immediate establishment of a special commission which should assure the execution of the proposed changes and assume the functions of the various committees. The failure of the insurrection involved the fall of those deputies who had supported the demands of the populace. Before the close of the sitting, Goujon, with Romme, Duroi, Duquesnoy, Bourbotte, Soubrany and others were put under arrest by their colleagues, and on their way to the château

of Taureau in Brittany had a narrow escape from a mob at Avranches. They were brought back to Paris for trial before a military commission on the 17th of June, and, though no proof of their complicity in organizing the insurrection could be found—they were, in fact, with the exception of Goujon and Bourbotte, strangers to one another—they were condemned. In accordance with a pre-arranged plan, they attempted suicide on the staircase leading from the court-room with a knife which Goujon had successfully concealed. Romme, Goujon and Duquesnoy succeeded, but the other three merely inflicted wounds which did not prevent their being taken immediately to the guillotine. With their deaths the Mountain ceased to exist as a party.

See J. Claretie, *Les Derniers Montagnards, histoire de l'insurrection de Prairial an III d'après les documents* (1867); *Défense du représentant du peuple Goujon* (Paris, no date), with the letters and a hymn written by Goujon during his imprisonment. For other documents see Maurice Tourneux (Paris, 1890, vol. 1., pp. 422–425).

GOULBURN, EDWARD MEYRICK (1818–1897), English churchman, son of Mr Serjeant Goulburn, M.P., recorder of Leicester, and nephew of the Right Hon. Henry Goulburn, chancellor of the exchequer in the ministries of Sir Robert Peel and the duke of Wellington, was born in London on the 11th of February 1818, and was educated at Eton and at Balliol College, Oxford. In 1839 he became fellow and tutor of Merton, and in 1841 and 1843 was ordained deacon and priest respectively. For some years he held the living of Holywell, Oxford, and was chaplain to Samuel Wilberforce, bishop of the diocese. In 1849 he succeeded Tait as headmaster of Rugby, but in 1857 he resigned, and accepted the charge of Quebec Chapel, Marylebone. In 1858 he became a prebendary of St Paul's, and in 1859 vicar of St John's, Paddington. In 1866 he was made dean of Norwich, and in that office exercised a long and marked influence on church life. A strong Conservative and a churchman of traditional orthodoxy, he was a keen antagonist of "higher criticism" and of all forms of rationalism. His *Thoughts on Personal Religion* (1862) and *The Pursuit of Holiness* were well received; and he wrote the *Life* (1892) of his friend Dean Burgon, with whose doctrinal views he was substantially in agreement. He resigned the deanery in 1889, and died at Tunbridge Wells on the 3rd of May 1897.

See *Life* by B. Compton (1899).

GOULBURN, HENRY (1784–1856), English statesman, was born in London on the 19th of March 1784 and was educated at Trinity College, Cambridge. In 1808 he became member of parliament for Horsham; in 1810 he was appointed under-secretary for home affairs and two and a half years later he was made under-secretary for war and the colonies. Still retaining office in the Tory government he became a privy councillor in 1821, and just afterwards was appointed chief secretary to the lord-lieutenant of Ireland, a position which he held until April 1827. Here although frequently denounced as an Orangeman, his period of office was on the whole a successful one, and in 1823 he managed to pass the Irish Tithe Composition Bill. In January 1828 he was made chancellor of the exchequer under the duke of Wellington; like his leader he disliked Roman Catholic emancipation, which he voted against in 1828. In the domain of finance Goulburn's chief achievements were to reduce the rate of interest on part of the national debt, and to allow any one to sell beer upon payment of a small annual fee, a complete change of policy with regard to the drink traffic. Leaving office with Wellington in November 1830, Goulburn was home secretary under Sir Robert Peel for four months in 1835, and when this statesman returned to office in September 1841 he became chancellor of the exchequer for the second time. Although Peel himself did some of the chancellor's work, Goulburn was responsible for a further reduction in the rate of interest on the national debt, and he aided his chief in the struggle which ended in the repeal of the corn laws. With his colleagues he left office in June 1846. After representing Horsham in the House of Commons for over four years Goulburn was successively member for St Germans, for West Lobe, and for the city of Armagh. In May 1831 he was elected for Cambridge University, and he retained this seat until his death on the 12th of January 1856.

at Betchworth House, Dorking. Goulburn was one of Peel's firmest supporters and most intimate friends. His eldest son, Henry (1813-1843), was senior classic and second wrangler at Cambridge in 1835.

See S. Walpole, *History of England* (1878-1886).

GOULBURN, a city of Argyle county, New South Wales, Australia, 134 m. S.W. of Sydney by the Great Southern railway. Pop. (1901) 10,618. It lies in a productive agricultural district, at an altitude of 2120 ft., and is a place of great importance, being the chief depot of the inland trade of the southern part of the state. There are Anglican and Roman Catholic cathedrals. Manufactures of boots and shoes, flour and beer, and tanning are important. The municipality was created in 1859; and Goulburn became a city in 1864.

GOULD, AUGUSTUS ADDISON (1805-1866), American conchologist, was born at New Ipswich, New Hampshire, on the 23rd of April 1805, graduated at Harvard College in 1825, and took his degree of doctor of medicine in 1830. Thrown from boyhood on his own exertions, it was only by industry, perseverance and self-denial that he obtained the means to pursue his studies. Establishing himself in Boston, he devoted himself to the practice of medicine, and finally rose to high professional rank and social position. He became president of the Massachusetts Medical Society, and was employed in editing the vital statistics of the state. As a conchologist his reputation is worldwide, and he was one of the pioneers of the science in America. His writings fill many pages of the publications of the Boston Society of Natural History (see vol. xi. p. 107 for a list) and other periodicals. He published with L. Agassiz the *Principles of Zoology* (2nd ed. 1851); he edited the *Terrestrial and Air-breathing Mollusks* (1851-1855) of Amos Binney (1803-1847); he translated Lamarck's *Genera of Shells*. The two most important monuments to his scientific work, however, are *Mollusca and Shells* (vol. xii., 1852) of the United States exploring expedition (1838-1842) under Lieutenant Charles Wilkes (1833), published by the government, and the *Report on the Invertebrata* published by order of the legislature of Massachusetts in 1841. A second edition of the latter work was authorized in 1865, and published in 1870 after the author's death, which took place at Boston on the 15th of September 1866. Gould was a corresponding member of all the prominent American scientific societies, and of many of those of Europe, including the London Royal Society.

GOULD, BENJAMIN APTHORP (1824-1896), American astronomer, a son of Benjamin Apthorp Gould (1787-1859), principal of the Boston Latin school, was born at Boston, Massachusetts, on the 27th of September 1824. Having graduated at Harvard College in 1844, he studied mathematics and astronomy under C. F. Gauss at Göttingen, and returned to America in 1848. From 1852 to 1867 he was in charge of the longitude department of the United States coast survey; he developed and organized the service, was one of the first to determine longitudes by telegraphic means, and employed the Atlantic cable in 1866 to establish longitude-relations between Europe and America. The *Astronomical Journal* was founded by Gould in 1849; and its publication, suspended in 1861, was resumed by him in 1885. From 1855 to 1859 he acted as director of the Dudley observatory at Albany, New York; and published in 1859 a discussion of the places and proper motions of circumpolar stars to be used as standards by the United States coast survey. Appointed in 1862 actuary to the United States sanitary commission, he issued in 1869 an important volume of *Military and Anthropological Statistics*. He fitted up in 1864 a private observatory at Cambridge, Mass.; but undertook in 1868, on behalf of the Argentine republic, to organize a national observatory at Cordoba; began to observe there with four assistants in 1870, and completed in 1874 his *Uranometria Argentina* (published 1879) for which he received in 1883 the gold medal of the Royal Astronomical Society. This was followed by a zone-catalogue of 73,160 stars (1884), and a general catalogue (1885) compiled from meridian observations of 32,448 stars. Gould's measurements of L. M. Rutherford's photographs of the Pleiades in 1866 entitle him to rank as a

pioneer in the use of the camera as an instrument of precision; and he secured at Cordoba 1400 negatives of southern star-clusters, the reduction of which occupied the closing years of his life. He returned in 1885 to his home at Cambridge, where he died on the 26th of November 1896.

See *Astronomical Journal*, No. 389; *Observatory*, xx. 70 (same notice abridged); *Science* (Dec. 18, 1896, S. C. Chandler); *Astronomical Journal*, v. 50; *Monthly Notices Roy. Astr. Society*, lvii. 218

GOULD, SIR FRANCIS GARRUTHERS (1844-), English caricaturist and politician; was born in Barnstaple on the 2nd of December 1844. Although in early youth he showed great love of drawing, he began life in a bank and then joined the London Stock Exchange, where he constantly sketched the members and illustrated important events in the financial world; many of these drawings were reproduced by lithography and published for private circulation. In 1879 he began the regular illustration of the Christmas numbers of *Truth*, and in 1887 he became a contributor to the *Pall Mall Gazette*, transferring his allegiance to the *Westminster Gazette* on its foundation and subsequently acting as assistant editor. Among his independent publications are *Who killed Cock Robin?* (1897), *Tales told in the Zoo* (1900), two volumes of *Froissart's Modern Chronicles, told and pictured* by F. C. Gould (1902 and 1903), and *Picture Politics*—a periodical reprint of his *Westminster Gazette* cartoons, one of the most noteworthy implements of political warfare in the armoury of the Liberal party. Frequently grafting his ideas on to subjects taken freely from *Uncle Remus*, *Alice in Wonderland*, and the works of Dickens and Shakespeare, Sir F. C. Gould used these literary vehicles with extraordinary dexterity and point, but with a satire that was not unkind and with a vigour from which bitterness, virulence and cynicism were notably absent. He was knighted in 1906.

GOULD, JAY (1836-1892), American financier, was born in Roxbury, Delaware county, New York, on the 27th of May 1836. He was brought up on his father's farm, studied at Hobart Academy, and though he left school in his sixteenth year, devoted himself assiduously thereafter to private study, chiefly of mathematics and surveying, at the same time keeping books for a blacksmith for his board. For a short time he worked for his father in the hardware business; in 1852-1856 he worked as a surveyor in preparing maps of Ulster, Albany and Delaware counties in New York, of Lake and Geauga counties in Ohio, and of Oakland county in Michigan, and of a projected railway line between Newburgh and Syracuse, N.Y. An ardent anti-renter in his boyhood and youth, he wrote *A History of Delaware County and the Border Wars of New York, containing a Sketch of the Early Settlements in the County, and a History of the Late Anti-Rent Difficulties in Delaware* (Roxbury, 1856). He then engaged in the lumber and tanning business in western New York, and in banking at Stroudsburg, Pennsylvania. In 1863 he married Miss Helen Day Miller, and through her father, Daniel S. Miller, he was appointed manager of the Rensselaer & Saratoga railway, which he bought up when it was in a very bad condition, and skilfully reorganized; in the same way he bought and reorganized the Rutland & Washington railway, from which he ultimately realized a large profit. In 1859 he removed to New York City, where he became a broker in railway stocks, and in 1868 he was elected president of the Erie railway, of which by shrewd strategy he and James Fisk, Jr. (q.v.), had gained control in July of that year. The management of the road under his control, and especially the sale of \$5,000,000 of fraudulent stock in 1868-1870, led to litigation begun by English bondholders, and Gould was forced out of the company in March 1872 and compelled to restore securities valued at about \$7,500,000. It was during his control of the Erie that he and Fisk entered into a league with the Tweed Ring, they admitted Tweed to the directorate of the Erie, and Tweed in turn arranged favourable legislation for them at Albany. With Tweed, Gould was cartooned by Nast in 1869. In October 1871 Gould was the chief bondsman of Tweed when the latter was held in \$1,000,000 bail. With Fisk in August 1869 he began to buy gold in a daring

attempt to "corner" the market, his hope being that, with the advance in price of gold, wheat would advance to such a price that western farmers would sell, and there would be a consequent great movement of breadstuffs from West to East, which would result in increased freight business for the Erie road. His speculations in gold, during which he attempted through President Grant's brother-in-law, A. H. Corbin, to influence the president and his secretary General Horace Porter, culminated in the panic of "Black Friday," on the 24th of September 1869, when the price of gold fell from 162 to 135.

Gould gained control of the Union Pacific, from which in 1883 he withdrew after realizing a large profit. Buying up the stock of the Missouri Pacific he built up, by means of consolidations, reorganizations, and the construction of branch lines, the "Gould System" of railways in the south-western states. In 1880 he was in virtual control of 10,000 miles of railway, about one-ninth of the railway mileage of the United States at that time. Besides, he obtained a controlling interest in the Western Union Telegraph Company, and after 1881 in the elevated railways in New York City, and was intimately connected with many of the largest railway financial operations in the United States for the twenty years following 1868. He died of consumption and of mental strain on the 2nd of December 1892, his fortune at that time being estimated at \$72,000,000; all of this he left to his own family.

His eldest son, GEORGE JAY GOULD (b. 1864), was prominent also as an owner and manager of railways, and became president of the Little Rock & Fort Smith railway (1888); the St. Louis, Iron Mountain & Southern railway (1893), the International & Great Northern railway (1893), the Missouri Pacific railway (1893), the Texas & Pacific railway (1893), and the Manhattan Railway Company (1892); he was also vice-president and director of the Western Union Telegraph Company. It was under his control that the Wabash system became transcontinental and secured an Atlantic port at Baltimore; and it was he who brought about a friendly alliance between the Gould and the Rockefeller interests.

The eldest daughter, HELEN MILLER GOULD (b. 1868), became widely known as a philanthropist, and particularly for her generous gifts to American army hospitals in the war with Spain in 1898 and for her many contributions to New York University, to which she gave \$250,000 for a library in 1895 and \$700,000 for a Hall of Fame in 1900.

GOUNOD, CHARLES FRANÇOIS (1818-1893), French composer, was born in Paris on the 17th of June 1818, the son of F. L. Gounod, a talented painter. He entered the Paris Conservatoire in 1836, studied under Reicha, Halévy and Lesueur, and won the "Grand Prix de Rome" in 1839. While residing in the Eternal City he devoted much of his time to the study of sacred music, notably to the works of Palestrina and Bach. In 1843 he went to Vienna, where a "requiem" of his composition was performed. On his return to Paris he tried in vain to find a publisher for some songs he had written in Rome. Having become organist to the chapel of the "Missions Étrangères," he turned his thoughts and mind to religious music. At that time he even contemplated the idea of entering into holy orders. His thoughts were, however, turned to more mundane matters when, through the intervention of Madame Viardot, the celebrated singer, he received a commission to compose an opera on a text by Émile Augier for the Académie Nationale de Musique. *Sapho*, the work in question, was produced in 1851, and if its success was not very great, it at least sufficed to bring the composer's name to the fore. Some critics appeared to consider this work as evidence of a fresh departure in the style of dramatic music, and Adolphe Adam, the composer, who was also a musical critic, attributed to Gounod the wish to revive the system of musical declamation invented by Gluck. The fact was that *Sapho* differed in some respects from the operatic works of the period, and was to a certain extent in advance of the times. When it was revived at the Paris Opéra in 1884, several additions were made by the composer to the original score, not altogether to its advantage, and *Sapho* once

more failed to attract the public. Gounod's second dramatic attempt was again in connexion with a classical subject, and consisted in some choruses written for *Ulysse*, a tragedy by Ponsard, played at the Théâtre Français in 1852, when the orchestra was conducted by Offenbach. The composer's next opera, *La Nonne sanglante*, given at the Paris Opéra in 1854, was a failure.

Goethe's *Faust* had for years exercised a strong fascination over Gounod, and he at last determined to turn it to operatic account. The performance at a Paris theatre of a drama on the same subject delayed the production of his opera for a time. In the meanwhile he wrote in a few months the music for an operatic version of Molière's comedy, *Le Médecin malgré lui*, which was produced at the Théâtre Lyrique in 1858. Berlioz well described this charming little work when he wrote of it, "Everything is pretty, piquant, fluent, in this 'opéra comique'; there is nothing superfluous and nothing wanting." The first performance of *Faust* took place at the Théâtre Lyrique on the 19th of March 1859. Goethe's masterpiece had already been utilized for operatic purposes by various composers, the most celebrated of whom was Spohr. The subject had also inspired Schumann, Berlioz, Liszt, Wagner, to mention only a few, and the enormous success of Gounod's opera did not deter Boito from writing his *Mefistofele*. *Faust* is without doubt the most popular French opera of the second half of the 19th century. Its success has been universal, and nowhere has it achieved greater vogue than in the land of Goethe. For years it remained the recognized type of modern French opera. At the time of its production in Paris it was scarcely appreciated according to its merits. Its style was too novel, and its luscious harmonies did not altogether suit the palates of those dilettanti who still looked upon Rossini as the incarnation of music. Times have indeed changed, and French composers have followed the road opened by Gounod, and have further developed the form of the lyrical drama, adopting the theories of Wagner in a manner suitable to their national temperament. Although in its original version *Faust* contained spoken dialogue, and was divided into set pieces according to custom, yet it differed greatly from the operas of the past. Gounod had not studied the works of German masters such as Mendelssohn and Schumann in vain, and although his own style is eminently Gallic, yet it cannot be denied that much of its charm emanates from a certain poetic sentimentality which seems to have a Teutonic origin. Certainly no music such as his had previously been produced by any French composer. Auber was a gay trifler, scattering his bright effusions with absolute *insouciance*, teeming with melodious ideas, but lacking depth. Berlioz, a musical Titan, wrestled against fate with a superhuman energy, and, Jove-like, subjugated his hearers with his thunderbolts. It was, however, reserved for Gounod to introduce *la note tendre*, to sing the tender passion in accents soft and languorous. The musical language employed in *Faust* was new and fascinating, and it was soon to be adopted by many other French composers, certain of its idioms thereby becoming hackneyed. Gounod's opera was given in London in 1863, when its success, at first doubtful, became enormous, and it was heard concurrently at Covent Garden and Her Majesty's theatres. Since then it has never lost its popularity.

Although the success of *Faust* in Paris was at first not so great as might have been expected, yet it gradually increased and set the seal on Gounod's fame. The fortunate composer now experienced no difficulty in finding an outlet for his works, and the succeeding decade is a specially important one in his career. The opera from his pen which came after *Faust* was *Philémon et Baucis*, a setting of the mythological tale in which the composer followed the traditions of the Opéra Comique, employing spoken dialogue, while not abdicating the individuality of his own style. This work was produced at the Théâtre Lyrique in 1860. It has repeatedly been heard in London. *La Reine de Saba*, a four-act opera, produced at the Grand Opéra on the 28th of February 1862, was altogether a far more ambitious work. For some reason it did not meet

with success, although the score contains some of Gounod's choicest inspirations, notably the well-known air, "Lend me your aid." *La Reine de Saba* was adapted for the English stage under the name of *Irene*. The non-success of this work proved a great disappointment to Gounod, who, however, set to work again, and this time with better results, *Mireille*, the fruit of his labours, being given for the first time at the Théâtre Lyrique on the 19th of March 1864. Founded upon the *Mireio* of the Provençal poet Mistral, *Mireille* contains much charming and characteristic music. The libretto seems to have militated against its success, and although several revivals have taken place and various modifications and alterations have been made in the score, yet *Mireille* has never enjoyed a very great vogue. Certain portions of this opera have, however, been popularized in the concert-room. *La Colombe*, a little opera in two acts without pretension, deserves mention here. It was originally heard at Baden in 1860, and subsequently at the Opéra Comique. A suavely melodious *entr'acte* from this little work has survived and been repeatedly performed.

Animated with the desire to give a pendant to his *Faust*, Gounod now sought for inspiration from Shakespeare, and turned his attention to *Romeo and Juliet*. Here, indeed, was a subject particularly well calculated to appeal to a composer who had so eminently qualified himself to be considered the musician of the tender passion. The operatic version of the Shakespearean tragedy was produced at the Théâtre Lyrique on the 27th of April 1867. It is generally considered as being the composer's second best opera. Some people have even placed it on the same level as *Faust*, but this verdict has not found general acceptance. Gounod himself is stated to have expressed his opinion of the relative value of the two operas enigmatically by saying, "*Faust* is the oldest, but I was younger; *Roméo* is the youngest, but I was older." The luscious strains wedded to the love scenes, if at times somewhat cloying, are generally in accord with the situations, often irresistibly fascinating, while always absolutely individual. The success of *Roméo* in Paris was great from the outset, and eventually this work was transferred to the Grand Opéra, after having for some time formed part of the repertoire of the Opéra Comique. In London it was not until the part of Romeo was sung by Jean de Reszke that this opera obtained any real hold upon the English public.

After having so successfully sought for inspiration from Molière, Goethe and Shakespeare, Gounod now turned to another famous dramatist, and selected Pierre Corneille's *Polyeucte* as the subject of his next opera. Some years were, however, to elapse before this work was given to the public. The Franco-German War had broken out, and Gounod was compelled to take refuge in London, where he composed the "biblical elegy" *Gallia* for the inauguration of the Royal Albert Hall. During his stay in London Gounod composed a great deal and wrote a number of songs to English words, many of which have attained an enduring popularity, such as "Maid of Athens," "There is a green hill far away," "Oh that we two were maying," "The fountain mingles with the river." His sojourn in London was not altogether pleasant, as he was embroiled in lawsuits with publishers. On Gounod's return to Paris he hurriedly set to music an operatic version of Alfred de Vigny's *Cinq-Mars*, which was given at the Opéra Comique on the 5th of April 1877 (and in London in 1900), without obtaining much success. *Polyeucte*, his much-cherished work, appeared at the Grand Opéra the following year on the 7th of October, and did not meet with a better fate. Neither was Gounod more fortunate with *Le Tribut de Zamora*, his last opera, which, given on the same stage in 1881, speedily vanished, never to reappear. In his later dramatic works he had, unfortunately, made no attempt to keep up with the times, preferring to revert to old-fashioned methods.

The genius of the great composer was, however, destined to assert itself in another field—that of sacred music. His friend Camille Saint-Saëns, in a volume entitled *Portraits of Contemporaries*, writes:

Gounod did not cease all his life to write for the church, to accumulate masses and motetts; but it was at the commencement of his career, in the *Messe de Sainte Cécile*, and at the end, in the oratorio *The Redemption* and *Mors et vita*, that he rose highest.

Saint-Saëns, indeed, has formulated the opinion that the three above-mentioned works will survive all the master's operas. Among the many masses composed by Gounod at the outset of his career, the best is the *Messe de Sainte Cécile*, written in 1855. He also wrote the *Messe du Sacré Cœur* (1876) and the *Messe à la mémoire de Jeanne d'Arc* (1887). This last work offers certain peculiarities, being written for solos, chorus, organ, eight trumpets, three trombones, and harps. In style it has a certain affinity with Palestrina. *The Redemption*, which seems to have acquired a permanent footing in Great Britain, was produced at the Birmingham Festival of 1882. It was styled a sacred trilogy, and was dedicated to Queen Victoria. The score is prefaced by a commentary written by the composer, in which the scope of the oratorio is explained. It cannot be said that Gounod has altogether risen to the magnitude of his task. The music of *The Redemption* bears the unmistakable imprint of the composer's hand, and contains many beautiful thoughts, but the work in its entirety is not exempt from monotony. *Mors et vita*, a sacred trilogy dedicated to Pope Leo XIII., was also produced for the first time in Birmingham at the Festival of 1885. This work is divided into three parts, "Mors," "Judicium," "Vita." The first consists of a Requiem, the second depicts the Judgment, the third Eternal Life. Although quite equal, if not superior to *The Redemption*, *Mors et vita* has not obtained similar success.

Gounod was a great worker, an indefatigable writer, and it would occupy too much space to attempt even an incomplete catalogue of his compositions. Besides the works already mentioned may be named two symphonies which were played during the 'fifties, but have long since fallen into neglect. Symphonic music was not Gounod's forte, and the French master evidently recognized the fact, for he made no further attempts in this style. The incidental music he wrote to the dramas *Les Deux Reines* and *Jeanne d'Arc* must not be forgotten. He also attempted to set Molière's comedy, *Georges Dandin*, to music, keeping to the original prose. This work has never been brought out. Gounod composed a large number of songs, many of which are very beautiful. One of the vocal pieces that have contributed most to his popularity is the celebrated *Méditation on the First Prelude of Bach*, more widely known as *Ave Maria*. The idea of fitting a melody to the Prelude of Bach was original, and it must be admitted that in this case the experiment was successful.

Gounod died at St Cloud on the 18th of October 1893. His influence on French music was immense, though during the last years of the 19th century it was rather counterbalanced by that of Wagner. Whatever may be the verdict of posterity, it is unlikely that the quality of individuality will be denied to Gounod. To be the composer of *Faust* is alone a sufficient title to lasting fame. (A. HZ.)

GOURD, a name given to various plants of the order *Cucurbitaceae*, especially those belonging to the genus *Cucurbita*, monoecious trailing herbs of annual duration, with long succulent stems furnished with tendrils, and large, rough, palmately-lobed leaves; the flowers are generally large and of a bright yellow or orange colour, the barren ones with the stamens united; the fertile are followed by the large succulent fruit that gives the gourds their chief economic value. Many varieties of *Cucurbita* are under cultivation in tropical and temperate climates, especially in southern Asia; but it is extremely difficult to refer them to definite specific groups, on account of the facility with which they hybridize; while it is very doubtful whether any of the original forms now exist in the wild state. Charles Naudin, who made a careful and interesting series of observations upon this genus, came to the conclusion that all varieties known in European gardens might be referred to six original species; probably three, or at most four, have furnished the edible kinds in ordinary cultivation. Adopting the specific

names usually given to the more familiar forms, the most important of the gourds, from an economic point of view, is perhaps *C. maxima*, the *Potérons Jaune* of the French, the red and yellow gourd of British gardeners (fig. 6), the spheroidal fruit of which is remarkable for its enormous size: the colour of the somewhat rough rind varies from white to bright yellow, while in some kinds it remains green; the fleshy interior is of a deep yellow or orange tint. This valuable gourd is grown extensively in southern Asia and Europe. In Turkey and Asia Minor it yields, at some periods of the year, an important article of diet to the people; immense quantities are sold in the markets of Constantinople, where in the winter the heaps of one variety with a white rind are described as resembling mounds of snowballs. The yellow kind attains occasionally a weight of upwards of 240 lb. It grows well in Central Europe and the United States, while in the south of England it will produce its gigantic fruit in perfection in hot summers. The yellow flesh of this gourd and its numerous varieties yields a considerable amount of nutriment, and is the more valuable as the fruit can be kept, even in warm climates, for a long time. In France and in the East it is much used in soups and ragouts, while simply boiled it forms a substitute for other table vegetables; the taste has been compared to that of a young carrot. In some countries the larger kinds are employed as cattle food. The seeds yield by expression a large quantity of a bland oil, which is used for the same purposes as that of the poppy and olive. The "mammoth" gourds of English and American gardeners (known in America as squashes) belong to this species. The pumpkin (summer squash of America) is *Cucurbita Pepo*. Some of the varieties of *C. maxima* and *Pepo* contain a considerable quantity of sugar, amounting in the sweetest kinds to 4 or 5%, and in the hot plains of Hungary efforts have been made to make use of them as a commercial source of sugar. The young shoots of both these large gourds may be given to cattle, and admit of being eaten as a green vegetable when boiled. The vegetable marrow is a variety (*marjara*) of *C. Pepo*. Many smaller gourds are cultivated in India and other hot climates, and some have been introduced into English gardens, rather for the beauty of their fruit and

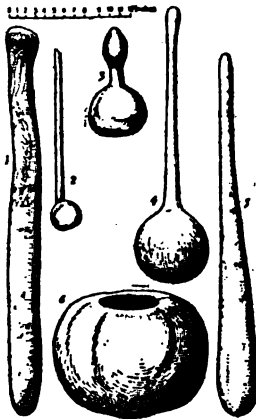

Photographed from specimens in the British Museum.

Group of Gourds.

- 1-5. Various forms of bottle gourd, *Lagenaria vulgaris*.
 6. Giant gourd, *Cucurbita maxima*.
- The bottle-gourds are placed in a separate genus, *Lagenaria*, chiefly differing from *Cucurbita* in the anthers being free instead of adherent. The bottle-gourd properly so-called, *L. vulgaris*, is a climbing plant with downy, heart-shaped leaves and beautiful white flowers: the remarkable fruit (figs. 1-5) first begins to grow in the form of an elongated cylinder, but gradually widens towards the extremity, until, when ripe, it resembles a flask with a narrow neck and large rounded bulb; it sometimes attains a length of 7 ft. When ripe, the pulp is removed from

the neck, and the interior cleared by leaving water standing in it; the woody rind that remains is used as a bottle: or the lower part is cut off and cleared out, forming a basin-like vessel applied to the same domestic purposes as the calabash (*Crescentia*) of the West Indies; the smaller varieties, divided lengthwise, form spoons. The ripe fruit is apt to be bitter and cathartic, but while immature it is eaten by the Arabs and Turks. When about the size of a small cucumber, it is stuffed with rice and minced meat, flavoured with pepper, onions, &c., and then boiled, forming a favourite dish with Eastern epicures. The elongated snake-gourds of India and China (*Trichosanthes*) are used in curries and stews.

All the true gourds have a tendency to secrete the cathartic principle *colocynthis*, and in many varieties of *Cucurbita* and the allied genera it is often elaborated to such an extent as to render them unwholesome, or even poisonous. The seeds of several species therefore possess some anthelmintic properties; those of the common pumpkin are frequently administered in America as a vermifuge.

The cultivation of gourds began far beyond the dawn of history, and the esculent species have become so modified by culture that the original plants from which they have descended can no longer be traced. The abundance of varieties in India would seem to indicate that part of Asia as the birthplace of the present edible forms; but some appear to have been cultivated in all the hotter regions of that continent, and in North Africa, from the earliest ages, while the Romans were familiar with at least certain kinds of *Cucurbita*, and with the bottle-gourd. *Cucurbita Pepo*, the source of many of the American forms, is probably a native of that continent.

Most of the annual gourds may be grown successfully in Britain. They are usually raised in hotbeds or under frames, and planted out in rich soil in the early summer as soon as the nights become warm. The more ornamental kinds may be trained over trellis-work, a favourite mode of displaying them in the East; but the situation must be sheltered and sunny. Even *Lagenaria* will sometimes produce fine fruit when so treated in the southern counties.

For an account of these cultivations in England see paper by Mr J. W. Odell, "Gourds and Cucurbits," in *Journ. Royal Hort. Soc.* xxix. 450 (1904).

GOURGAUD, GASPARD, BARON (1783-1852), French soldier, was born at Versailles on the 14th of September 1783; his father was a musician of the royal chapel. At school he showed talent in mathematical studies and accordingly entered the artillery. In 1802 he became junior lieutenant, and thereafter served with credit in the campaigns of 1803-1805, being wounded at Austerlitz. He was present at the siege of Saragossa in 1808, but returned to service in Central Europe and took part in nearly all the battles of the Danubian campaign of 1809. In 1811 he was chosen to inspect and report on the fortifications of Danzig. Thereafter he became one of the ordnance officers attached to the emperor, whom he followed closely through the Russian campaign of 1812; he was one of the first to enter the Kremlin and discovered there a quantity of gunpowder which might have been used for the destruction of Napoleon. For his services in this campaign he received the title of baron, and became first ordnance officer. In the campaign of 1813 in Saxony he further evinced his courage and prowess, especially at Leipzig and Hanau; but it was in the first battle of 1814, near to Brienne, that he rendered the most signal service by killing the leader of a small band of Cossacks who were riding furiously towards Napoleon's tent. Wounded at the battle of Montmirail, he yet recovered in time to share in several of the conflicts which followed, distinguishing himself especially at Laon and Reims. Though enrolled among the royal guards of Louis XVIII. in the summer of 1814, he yet embraced the cause of Napoleon during the Hundred Days (1815), was named general and aide-de-camp by the emperor, and fought at Waterloo.

After the second abdication of the emperor (June 22nd, 1815) Gourgauud retired with him and a few other companions to Rochefort. It was to him that Napoleon entrusted the letter of appeal to the prince regent for an asylum in England. Gourgauud set off in H.M.S. "Slancy," but was not allowed to land

in England. He determined to share Napoleon's exile and sailed with him on H.M.S. "Northumberland" to St Helena. The ship's secretary, John R. Glover, has left an entertaining account of some of Gourgaud's gasconades at table. His extreme sensitiveness and vanity soon brought him into collision with Las Cases and Montholon at Longwood. The former he styles in his journal a "Jesuit" and a scribbler who went thither in order to become famous. With Montholon, his senior in rank, the friction became so acute that he challenged him to a duel, for which he suffered a sharp rebuke from Napoleon. Tiring of the life at Longwood and the many slights which he suffered from Napoleon, he desired to depart, but before he could sail he spent two months with Colonel Basil Jackson, whose account of him throws much light on his character, as also on the "policy" adopted by the exiles at Longwood. In England he was gained over by members of the Opposition and thereafter made common cause with O'Meara and other detractors of Sir Hudson Lowe, for whose character he had expressed high esteem to Basil Jackson. He soon published his *Campagne de 1815*, in the preparation of which he had had some help from Napoleon; but Gourgaud's *Journal de Ste-Hélène* was not destined to be published till the year 1890. Entering the arena of letters, he wrote, or collaborated in, two well-known critiques. The first was a censure of Count P. de Ségur's work on the campaign of 1812, with the result that he fought a duel with that officer and wounded him. He also sharply criticized Sir Walter Scott's *Life of Napoleon*. He returned to active service in the army in 1830; and in 1840 proceeded with others to St Helena to bring back the remains of Napoleon to France. He became a deputy to the Legislative Assembly in 1849; he died in 1852.

Gourgaud's works are *La Campagne de 1815* (London and Paris, 1818); *Napoleon et la Grande Armée en Russie: examen critique de l'ouvrage de M. le comte P. de Ségur* (Paris, 1824); *Réfutation de la vie de Napoleon par Sir Walter Scott* (Paris, 1827). He collaborated with Montholon in the work entitled *Mémoires pour servir à l'histoire de France sous Napoleon* (Paris, 1822-1823), and with Belliard and others in the work entitled *Bourrienne et ses erreurs* (2 vols., Paris, 1830); but his most important work is the *Journal inédit de Ste-Hélène* (2 vols., Paris, 1899), which is a remarkably naïf and lifelike record of the life at Longwood. See, too, *Notes and Reminiscences of a Staff Officer*, by Basil Jackson (London, 1904), and the bibliography to the article *LOWE, SIR HUDSON*. (J. H. L. R.)

GOURKO, JOSEPH VLADIMIROVICH, COUNT (1828-1901), Russian general, was born, of Lithuanian extraction, on the 15th of November 1828. He was educated in the imperial corps of pages, entered the hussars of the imperial bodyguard as sub-lieutenant in 1846, became captain in 1857, adjutant to the emperor in 1860, colonel in 1861, commander of the 4th Hussar regiment of Mariupol in 1866, and major-general of the emperor's suite in 1867. He subsequently commanded the grenadier regiment, and in 1873 the 1st brigade, 2nd division, of the cavalry of the guard. Although he took part in the Crimean War, being stationed at Belbek, his claim to distinction is due to his services in the Turkish war of 1877. He led the van of the Russian invasion, took Trnovo on the 7th July, crossed the Balkans by the Hain Bogaz pass, debouching near Hainkioi, and, notwithstanding considerable resistance, captured Uflani, Maglish and Kazanlyk; on the 18th of July he attacked Shipka, which was evacuated by the Turks on the following day. Thus within sixteen days of crossing the Danube Gourko had secured three Balkan passes and created a panic at Constantinople. He then made a series of successful reconnaissances of the Tunja valley, cut the railway in two places, occupied Stara Zagora (Turkish, Eaki Zagra) and Nova Zagora (Yeni Zagra), checked the advance of Suleiman's army, and returned again over the Balkans. In October he was appointed commander of the allied cavalry, and attacked the Plevna line of communication to Orkhanie with a large mixed force, captured Gorni-Dubnik, Telische and Vratsa, and, in the middle of November, Orkhanie itself. Plevna was isolated, and after its fall in December Gourko led the way amidst snow and ice over the Balkans to the fertile valley beyond, totally defeated Sulciman, and occupied Sophia, Philippopolis and Adrianople, the armistice at the end of January 1878 stopping further operations (see *RUSO-*

TURKISH WARS). Gourko was made a count, and decorated with the 2nd class of St George and other orders. In 1879-1880 he was governor of St Petersburg, and from 1883 to 1894 governor-general of Poland. He died on the 29th of January 1901.

GOURMET, a French term for one who takes a refined and critical, or even merely theoretical pleasure in good cooking and the delights of the table. The word has not the disparaging sense attached to the Fr. *gourmand*, to whom the practical pleasure of good eating is the chief end. The O. Fr. *gromet* or *gromel* meant a servant, or shop-boy, especially one employed in a wine-seller's shop, hence an expert taster of wines, from which the modern usage has developed. The etymology of *gourmet* is obscure; it may be ultimately connected with the English "groom" (q.v.). The origin of *gourmand* is unknown. In English, in the form "grummet," the word was early applied to a cabin or ship's boy. Ships of the Cinque Ports were obliged to carry one "grummet"; thus in a charter of 1229 (quoted in the *New English Dictionary*) it is laid down *servitia inde debita Domino Regi, xxi. naves, et in qualibet nave xxi. homines, cum uno gartione qui dicitur gromel*.

GOUROCK, a police burgh and watering-place of Renfrewshire, Scotland, on the southern shore of the Firth of Clyde, 3½ m. W. by N. of Greenock by the Caledonian railway. Pop. (1901) 5261. It is partly situated on a fine bay affording good anchorage, for which it is largely resorted to by the numerous yacht clubs of the Clyde. The extension of the railway from Greenock (in 1889) to the commodious pier, with a tunnel 1½ m. long, the longest in Scotland, affords great facilities for travel to the ports of the Firth, the sea lochs on the southern Highland coast and the Crinan Canal. The eminence called Barhill (480 ft. high) divides the town into two parts, the eastern known as Kempech, the western as Ashton. Near Kempech point is a monolith of mica-schist, 6 ft. high, called "Granny Kempech," which the superstitious of other days regarded as possessing influence over the winds, and which was the scene, in 1662, of certain rites that led to the celebrants being burned as witches. Gamble Institute (named after the founder) contains halls, recreation rooms, a public library and baths. It is said that Gourouck was the first place on the Clyde where herrings were cured. There is tramway communication with Greenock and Ashton. About 3 m. S.W. there stands on the shore the familiar beacon of the Cloch. Gourouck became a burgh of barony in 1694.

GOURVILLE, JEAN HERAULD (1625-1703), French adventurer, was born at La Rochefoucauld. At the age of eighteen he entered the house of La Rochefoucauld as a servant, and in 1646 became secretary to François de la Rochefoucauld, author of the *Maximes*. Resourceful and quick-witted, he rendered services to his master during the Fronde, in his intrigues with the parliament, the court or the princes. In these negotiations he made the acquaintance of Condé, whom he wished to help to escape from the château of Vincennes; of Mazarin, for whom he negotiated the reconciliation with the princes; and of Nicolas Fouquet. After the Fronde he engaged in financial affairs, thanks to Fouquet. In 1658 he farmed the *taille* in Guienne. He bought depreciated *rentes* and had them raised to their nominal value by the treasury; he extorted gifts from the financiers for his protection, being Fouquet's confidant in many operations of which he shared the profits. In three years he accumulated an enormous fortune, still further increased by his unflinching good fortune at cards, playing even with the king. He was involved in the trial of Fouquet, and in April 1663 was condemned to death for peculation and embezzlement of public funds; but escaping, was executed in effigy. He sent a valet one night to take the effigy down from the gallows in the court of the Palais de Justice, and then fled the country. He remained five years abroad, being excepted in 1665 from the amnesty accorded by Louis XIV. to the condemned financiers. Having returned secretly to France, he continued the service of Condé, who, unable to meet his creditors, had need of a clever manager to put his affairs in order. In this way he was able to reappear at court, to assist at the campaigns of the war with Holland, and to offer himself for all the delicate negotiations

for his master or the king. He received diplomatic missions in Germany, in Holland, and especially in Spain, though it was only in 1694, that he was freed from the condemnation pronounced against him by the chamber of justice. From 1696 he fell ill and withdrew to his estate, where he dictated to his secretary, in four months and a half, his *Mémoires*, an important source for the history of his time. In spite of several errors, introduced purposely, they give a clear idea of the life and morals of a financier of the age of Fouquet, and throw light on certain points of the diplomatic history. They were first published in 1724.

There is a modern edition, with notes, an introduction and appendix, by Lecestre (Paris, 1894-1895, 2 vols.).

GOUT, the name rather vaguely given, in medicine, to a constitutional disorder which manifests itself by inflammation of the joints, with sometimes deposition of urates of soda, and also by morbid changes in various important organs. The term gout, which was first used about the end of the 13th century, is derived through the Fr. *goutte* from the Lat. *gutta*, a drop, in allusion to the old pathological doctrine of the dropping of a morbid material from the blood within the joints. The disease was known and described by the ancient Greek physicians under various terms, which, however, appear to have been applied by them alike to rheumatism and gout. The general term *arthritís* (*ἀρθρίτις*, a joint) was employed when many joints were the seat of inflammation; while in those instances where the disease was limited to one part the terms used bore reference to such locality; hence *podagra* (*ποδάγρα*, from *podé*, the foot, and *agra*, a seizure), *chiragra* (*χείρα*, the hand), *gonagra* (*γόνυ*, the knee), &c.

Hippocrates in his *Aphorisms* speaks of gout as occurring most commonly in spring and autumn, and mentions the fact that women are less liable to it than men. He also gives directions as to treatment. Celsus gives a similar account of the disease. Galen regarded gout as an unnatural accumulation of humours in a part, and the chalk-stones as the concretions of these, and he attributed the disease to over-indulgence and luxury. Gout is alluded to in the works of Ovid and Pliny, and Seneca, in his 95th epistle, mentions the prevalence of gout among the Roman ladies of his day as one of the results of their high living and debauchery. Lucian, in his *Tragopodagra*, gives an amusing account of the remedies employed for the cure of gout.

In all times this disease has engaged a large share of the attention of physicians, from its wide prevalence and from the amount of suffering which it entails. Sydenham, the famous English physician of the 17th century, wrote an important treatise on the subject, and his description of the gouty paroxysm, all the more vivid from his having himself been afflicted with the disease for thirty-four years, is still quoted by writers as the most graphic and exhaustive account of the symptomatology of gout. Subsequently Cullen, recognizing gout as capable of manifesting itself in various ways, divided the disease into *regular gout*, which affects the joints only, and *irregular gout*, where the gouty disposition exhibits itself in other forms; and the latter variety he subdivided into *atonic gout*, where the most prominent symptoms are throughout referable to the stomach and alimentary canal; *retrocedent gout*, where the inflammatory attack suddenly disappears from an affected joint and serious disturbance takes place in some internal organ, generally the stomach or heart; and *misplaced gout*, where from the first the disease does not appear externally, but reveals itself by an inflammatory attack of some internal part. Dr Garrod, one of the most eminent authorities on gout, adopted a division somewhat similar to, though simpler than that of Cullen, namely, *regular gout*, which affects the joints alone, and is either acute or chronic, and *irregular gout*, affecting non-articular tissues, or disturbing the functions of various organs.

It is often stated that the attack of gout comes on without any previous warning; but, while this is true in many instances, the reverse is probably as frequently the case, and the premonitory symptoms, especially in those who have previously suffered from the disease, may be sufficiently precise to indicate

the impending seizure. Among the more common of these may be mentioned marked disorders of the digestive organs, with a feeble and capricious appetite, flatulence and pain after eating, and uneasiness in the right side in the region of the liver. A remarkable tendency to gnashing of the teeth is sometimes observed. This symptom was first noticed by Dr Graves, who connected it with irritation in the urinary organs, which also is present as one of the premonitory indications of the gouty attack. Various forms of nervous disturbance also present themselves in the form of general discomfort, extreme irritability of temper, and various perverted sensations, such as that of numbness and coldness in the limbs. These symptoms may persist for many days and then undergo amelioration immediately before the impending paroxysm. On the night of the attack the patient retires to rest apparently well, but about two or three o'clock in the morning awakes with a painful feeling in the foot, most commonly in the ball of the great toe, but it may be in the instep or heel, or in the thumb. With the pain there often occurs a distinct shivering followed by feverishness. The pain soon becomes of the most agonizing character: in the words of Sydenham, "now it is a violent stretching and tearing of the ligaments, now it is a gnawing pain, and now a pressure and tightening; so exquisite and lively meanwhile is the part affected that it cannot bear the weight of the bedclothes, nor the jar of a person walking in the room."

When the affected part is examined it is found to be swollen and of a deep red hue. The superjacent skin is tense and glistening, and the surrounding veins are more or less distended. After a few hours there is a remission of the pain, slight perspiration takes place, and the patient may fall asleep. The pain may continue moderate during the day but returns as night advances, and the patient goes through a similar experience of suffering to that of the previous night, followed with a like abatement towards morning. These nocturnal exacerbations occur with greater or less severity during the continuance of the attack, which generally lasts for a week or ten days. As the symptoms decline the swelling and tenderness of the affected joint abate, but the skin over it pits on pressure for a time, and with this there is often associated slight desquamation of the cuticle. During the attacks there is much constitutional disturbance. The patient is restless and extremely irritable, and suffers from cramp in the limbs and from dyspepsia, thirst and constipation. The urine is scanty and high-coloured, with a copious deposit, consisting chiefly of urates. During the continuance of the symptoms the inflammation may leave the one foot and affect the other, or both may suffer at the same time. After the attack is over the patient feels quite well and fancies himself better than he had been for a long time before; hence the once popular notion that a fit of the gout was capable of removing all other ailments. Any such idea, however, is sadly belied in the experience of most sufferers from this disease. It is rare that the first is the only attack of gout, and another is apt to occur within a year, although by care and treatment it may be warded off. The disease, however, undoubtedly tends to take a firmer hold on the constitution and to return. In the earlier recurrences the same joints as were formerly the seat of the gouty inflammation suffer again, but in course of time others become implicated, until in advanced cases scarcely any articulation escapes, and the disease thus becomes chronic. It is to be noticed that when gout assumes this form the frequently recurring attacks are usually attended with less pain than the earlier ones, but their disastrous effects are evidenced alike by the disturbance of various important organs, especially the stomach, liver, kidneys and heart, and by the remarkable changes which take place in the joints from the formation of the so-called chalk-stones or tophi. These deposits, which are highly characteristic of gout, appear at first to take place in the form of a semifluid material, consisting for the most part of urate of soda, which gradually becomes more dense, and ultimately quite hard. When any quantity of this is deposited in the structures of a joint the effect is to produce stiffening, and, as deposits appear to take place to a greater or less amount in connexion with every

attack, permanent thickening and deformity of the parts is apt to be the consequence. The extent of this depends, of course, on the amount of the deposits, which, however, would seem to be in no necessary relation to the severity of the attack, being in some cases even of chronic gout so slight as to be barely appreciable externally, but on the other hand occasionally causing great enlargement of the joints, and fixing them in a flexed or extended position which renders them entirely useless. Dr Garrod describes the appearance of a hand in an extreme case of this kind, and likens its shape to a bundle of French carrots with their heads forward, the nails corresponding to the stalks. Any of the joints may be thus affected, but most commonly those of the hands and feet. The deposits take place in other structures besides those of joints, such as along the course of tendons, underneath the skin and periosteum, in the sclerotic coat of the eye, and especially on the cartilages of the external ear. When largely deposited in joints an abscess sometimes forms, the skin gives way, and the concretion is exposed. Sir Thomas Watson quotes a case of this kind where the patient when playing at cards was accustomed to chalk the score of the game upon the table with his gouty knuckles.

The recognition of what is termed irregular gout is less easy than that form above described, where the disease gives abundant external evidence of its presence; but that other parts than joints suffer from gouty attacks is beyond question. The diagnosis may often be made in cases where in an attack of ordinary gout the disease suddenly leaves the affected joints and some new series of symptoms arises. It has been often observed when cold has been applied to an inflamed joint that the pain and inflammation in the part ceased, but that some sudden and alarming seizure referable to the stomach, brain, heart or lungs supervened. Such attacks, which correspond to what is termed by Cullen retrocedent gout, often terminate favourably, more especially if the disease again returns to the joints. Further, the gouty nature of some long-continued internal or cutaneous disorder may be rendered apparent by its disappearance on the outbreak of the paroxysm in the joints. Gout, when of long standing, is often found associated with degenerative changes in the heart and large arteries, the liver, and especially the kidneys, which are apt to assume the contracted granular condition characteristic of one of the forms of Bright's disease. A variety of urinary calculus—the uric acid—formed by concretions of this substance in the kidneys is a not unfrequent occurrence in connexion with gout; hence the well-known association of this disease and gravel.

The pathology of gout is discussed in the article on METABOLIC DISEASES. Many points, however, still remain unexplained. As remarked by Trousseau, "the production in excess of uric acid and urates is a pathological phenomenon inherent like all others in the disease; and like all the others it is dominated by a specific cause, which we know only by its effects, and which we term the gouty diathesis." This subject of diathesis (habit, or organic predisposition of individuals), which is regarded as an essential element in the pathology of gout, naturally suggests the question as to whether, besides being inherited, such a peculiarity may also be acquired, and this leads to a consideration of the causes which are recognized as influential in favouring the occurrence of this disease.

It is beyond dispute that gout is in a marked degree hereditary, fully more than half the number of cases being, according to Sir C. Scudamore and Dr Garrod, of this character. But it is no less certain that there are habits and modes of life the observance of which may induce the disease even where no hereditary tendencies can be traced, and the avoidance of which may, on the other hand, go far towards weakening or neutralizing the influence of inherited liability. Gout is said to affect the sedentary more readily than the active. If, however, inadequate exercise be combined with a luxurious manner of living, with habitual over-indulgence in animal food and rich dishes, and especially in alcoholic beverages, then undoubtedly the chief factors in the production of the disease are present.

Much has been written upon the relative influence of various

forms of alcoholic drinks in promoting the development of gout. It is generally stated that fermented are more injurious than distilled liquors, and that, in particular, the stronger wines, such as port, sherry and madeira, are much more potent in their gout-producing action than the lighter class of wines, such as hock, moselle, &c., while malt liquors are fully as hurtful as strong wines. It seems quite as probable, however, that over-indulgence in any form of alcohol, when associated with the other conditions already adverted to, will have very much the same effect in developing gout. The comparative absence of gout in countries where spirituous liquors are chiefly used, such as Scotland, is cited as showing their relatively slight effect, in encouraging that disease; but it is to be noticed that in such countries there is on the whole a less marked tendency to excess in the other pleasures of the table, which in no degree less than alcohol are chargeable with inducing the gouty habit. Gout is not a common disease among the poor and labouring classes, and when it does occur may often be connected even in them with errors in living. It is not very rare to meet gout in butlers, coachmen, &c., who are apt to live luxuriously while leading comparatively easy lives.

Gout, it must ever be borne in mind, may also affect persons who observe the strictest temperance in living, and whose only excesses are in the direction of over-work, either physical or intellectual. Many of the great names in history in all times have had their existence embittered by this malady, and have died from its effects. The influence of hereditary tendency may often be traced in such instances, and is doubtless called into activity by the depressing consequences of over-work: It may, notwithstanding, be affirmed as generally true that those who lead regular lives, and are moderate in the use of animal food and alcoholic drinks, or still better abstain from the latter altogether, are less likely to be the victims of gout even where an undoubted inherited tendency exists.

Gout is more common in mature age than in the earlier years of life, the greatest number of cases in one decennial period being between the ages of thirty and forty, next between twenty and thirty, and thirdly between forty and fifty. It may occasionally affect very young persons; such cases are generally regarded as hereditary, but, so far as diet is concerned, it has to be remembered that their home life has probably been a predisposing cause. After middle life gout rarely appears for the first time. Women are much less the subjects of gout than men, apparently from their less exposure to the influences (excepting, of course, that of heredity) which tend to develop the disease, and doubtless also from the differing circumstances of their physical constitution. It most frequently appears in females after the cessation of the menses. Persons exposed to the influence of lead poisoning, such as plumbers, painters, &c., are apt to suffer from gout; and it would seem that impregnation of the system with this metal markedly interferes with the uric acid excreting function of the kidneys.

Attacks of gout are readily excited in those predisposed to the disease. Exposure to cold, disorders of digestion, fatigue, and irritation or injuries of particular joints will often precipitate the gouty paroxysm.

With respect to the treatment of gout the greatest variety of opinion has prevailed and practice been pursued, from the numerous quaint nostrums detailed by Lucian to the "expectant" or do-nothing system recommended by Sydenham. But gout, although, as has been shown, a malady of a most severe and intractable character, may nevertheless be successfully dealt with by appropriate medicinal and hygienic measures. The general plan of treatment can be here only briefly indicated. During the acute attack the affected part should be kept at perfect rest, and have applied to it warm opiate fomentations or poultices, or, what answers quite as well, be enveloped in cotton wool covered in with oil silk. The diet of the patient should be light, without animal food or stimulants. The administration of some simple laxative will be of service, as well as the free use of alkaline diuretics, such as the bicarbonate or acetate of potash. The medicinal agent most relied on for the relief of pain is colchicum, which manifestly exercises a powerful

action on the disease. This drug (*Colchicum autumnale*), which is believed to correspond to the hermodactyl of the ancients, has proved of such efficacy in modifying the attacks that, as observed by Dr Garrod, "we may safely assert that colchicum possesses as specific a control over the gouty inflammation as cinchona barks or their alkaloids over intermittent fever." It is usually administered in the form of the wine in doses of 10 to 30 drops every four or six hours, or in pill as the acetous extract (gr. ½-gr. i.). The effect of colchicum in subduing the pain of gout is generally so prompt and marked that it is unnecessary to have recourse to opiates; but its action requires to be carefully watched by the physician from its well-known nauseating and depressing consequences, which, should they appear, render the suspension of the drug necessary. Otherwise the remedy may be continued in gradually diminishing doses for some days after the disappearance of the gouty inflammation. Should gout give evidence of its presence in an irregular form by attacking internal organs, besides the medicinal treatment above mentioned, the use of frictions and mustard applications to the joints is indicated with the view of exciting its appearance there. When gout has become chronic, colchicum, although of less service than in acute gout, is yet valuable, particularly when the inflammatory attacks recur. More benefit, however, appears to be derived from potassium iodide, guaiacum, the alkali potash and lithia, and from the administration of aspirin and sodium salicylate. Salicylate of menthol is an effective local application, painted on and covered with a gutta-percha bandage. Lithia was strongly recommended by Dr Garrod from its solvent action upon the urates. It is usually administered in the form of the carbonate (gr. v., freely diluted).

The treatment and regimen to be employed in the intervals of the gouty attacks are of the highest importance. These bear reference for the most part to the habits and mode of life of the patient. Restriction must be laid upon the amount and quality of the food, and equally, or still more, upon the alcoholic stimulants. "The instances," says Sir Thomas Watson, "are not few of men of good sense, and masters of themselves, who, being warned by one visitation of the gout, have thenceforward resolutely abstained from rich living and from wine and strong drinks of all kinds, and who have been rewarded for their prudence and self-denial by complete immunity from any return of the disease, or upon whom, at any rate, its future assaults have been few and feeble." The same eminent authority adds: "I am sure it is worth any young man's while, who has had the gout, to become a teetotaler." By those more advanced in life who, from long continued habit, are unable entirely to relinquish the use of stimulants, the strictest possible temperance must be observed. Regular but moderate exercise in the form of walking or riding, in the case of those who lead sedentary lives, is of great advantage, and all over-work, either physical or mental, should be avoided. *Fatigue la bête, et repose la tête* is the maxim of an experienced French doctor (Dr Debout d'Estrées of Contrexéville). Unfortunately the complete carrying out of such directions, even by those who feel their importance, is too often rendered difficult or impossible by circumstances of occupation and otherwise, and at most only an approximation can be made. Certain mineral waters and baths (such as those of Vichy, Royat, Contrexéville, &c.) are of undoubted value in cases of gout and arthritis. The particular place must in each case be determined by the physician, and special caution must be observed in recommending this plan of treatment in persons whose gout is complicated by organic disease of any kind.

Dr Alexander Haig's "uric acid free diet" has found many adherents. His view as regards the pathology is that in gouty persons the blood is less alkaline than in normal, and therefore less able to hold in solution uric acid or its salts, which are retained in the joints. Assuming gout to be a poisoning by animal food (meat, fish, eggs), and by tea, coffee, cocoa and other vegetable alkaloid-containing substances, he recommends an average daily diet excluding these, and containing 24 oz. of breadstuffs (toast, bread, biscuits and puddings) together with 24 oz. of fruit and vegetables (excluding peas, beans, truffles, mushrooms and asparagus); 8 oz. of the breadstuffs may be replaced by 21 oz. of milk or 2 oz. of cheese, butter and oil being taken as required, so that it is not strictly a vegetarian diet.

Precisely the opposite view as to diet has recently been put forward by Professor A. Robin of the Hôpital Beaujon, who says serious mistakes are made in ordering patients to abstain from red meats and take light food, fish, eggs, &c. The common object in view is the diminished output of uric acid. This output is chiefly obtained from food rich in nucleins and in collagenous matters, i.e. young white meats, eggs, &c. Consequently the gouty subject ought to restrict himself to the consumption of red meat, beef and mutton, and leave out of his dietary all white meat and internal organs. He should take little hydrocarbons and sugars, and be moderate in fats. Vegetarian diet he regards as a mistake, likewise milk diet, as they tend to weaken the patient. To prevent the formation of uric acid Robin prescribes quinic acid combined with formic or urotropine.

GOUTHIÈRE, PIERRE (1740-1806), French metal worker, was born at Troyes and went to Paris at an early age as the pupil of Martin Cour. During his brilliant career he executed a vast quantity of metal work of the utmost variety, the best of which was unsurpassed by any of his rivals in that great art period. It was long believed that he received many commissions for furniture from the court of Louis XVI., and especially from Marie Antoinette, but recent searches suggest that his work for the queen was confined to bronzes. Gouthière can, however, well bear this loss, nor will his reputation suffer should those critics ultimately be justified who believe that many of the furniture mounts attributed to him were from the hand of Thomire. But if he did not work for the court he unquestionably produced many of the most splendid belongings of the duc d'Aumont, the duchesse de Mazarin and Mme du Barry. Indeed the custom of the beautiful mistress of Louis XV. brought about the financial ruin of the great artist, who accomplished more than any other man for the fame of her château of Louveciennes. When the collection of the duc d'Aumont was sold by auction in Paris in 1782 so many objects mounted by Gouthière were bought for Louis XVI. and Marie Antoinette that it is not difficult to perceive the basis of the belief that they were actually made for the court. The duc's sale catalogue is, however, in existence, with the names of the purchasers and the prices realized. The auction was almost an apotheosis of Gouthière. The precious lacquer cabinets, the chandeliers and candelabra, the tables and cabinets in marquetry, the columns and vases in porphyry, jasper and choice marbles, the porcelains of China and Japan were nearly all mounted in bronze by him. More than fifty of these pieces bore Gouthière's signature. The duc d'Aumont's cabinet represented the high-water mark of the chaser's art, and the great prices which were paid for Gouthière's work at this sale are the most conclusive criterion of the value set upon his achievement in his own day. Thus Marie Antoinette paid 12,000 livres for a red jasper bowl or *brûle-parfums* mounted by him, which was then already famous. Curiously enough it commanded only one-tenth of that price at the Fournier sale in 1831; but in 1865, when the marquis of Hertford bought it at the prince de Beauvais's sale, it fetched 31,000 francs. It is now in the Wallace Collection, which contains the finest and most representative gathering of Gouthière's undoubted work. The mounts of gilt bronze, cast and elaborately chased, show satyrs' heads, from which hang festoons of vine leaves, while within the feet a serpent is coiled to spring. A smaller cup is one of the treasures of the Louvre. There too is a bronze clock, signed by "Gouthière, *cinileur et dorure du Roy à Paris*," dated 1771, with a river god, a water nymph symbolizing the Rhône and its tributary the Durance, and a female figure typifying the city of Avignon. Not all of Gouthière's work is of the highest quality, and much of what he executed was from the designs of others. At his best his delicacy, refinement and finish are exceedingly delightful—in his great moments he ranks with the highest alike as artist and as craftsman. The tone of soft dead gold which is found on some of his mounts he is believed to have invented, but indeed the gilding of all his superlative work possesses a remarkable quality. This charm of tone is admirably seen in the bronzes and candelabra which he executed for the chimney-piece of Marie Antoinette's boudoir at Fontainebleau. He continued to embellish Louveciennes for Madame du Barry until the Revolution, and then the guillotine came for her and absolute ruin for him. When her property was seized

she owed him 756,000 livres, of which he never received a sol, despite repeated applications to the administrators. "*Résist à solliciter une place à l'hospice, il mourut dans la misère.*" So it was stated in a lawsuit brought by his sons against du Barry's heirs.

GOUVION SAINT-CYR, LAURENT, MARQUIS DE (1764-1830), French marshal, was born at Toul on the 13th of April 1764. At the age of eighteen he went to Rome with the view of prosecuting the study of painting, but although he continued his artistic studies after his return to Paris in 1784 he never definitely adopted the profession of a painter. In 1792 he was chosen a captain in a volunteer battalion, and served on the staff of General Custine. Promotion rapidly followed, and in the course of two years he had become a general of division. In 1796 he commanded the centre division of Moreau's army in the campaign of the Rhine, and by coolness and sagacity greatly aided him in the celebrated retreat from Bavaria to the Rhine. In 1798 he succeeded Masséna in the command of the army of Italy. In the following year he commanded the left wing of Jourdan's army in Germany; but when Jourdan was succeeded by Masséna, he joined the army of Moreau in Italy, where he distinguished himself in face of the great difficulties that followed the defeat of Novi. When Moreau, in 1800, was appointed to the command of the army of the Rhine, Gouvion St-Cyr was named his principal lieutenant, and on the 9th of May gained a victory over General Kray at Biberach. He was not, however, on good terms with his commander and retired to France after the first operations of the campaign. In 1801 he was sent to Spain to command the army intended for the invasion of Portugal, and was named grand officer of the Legion of Honour. When a treaty of peace was shortly afterwards concluded with Portugal, he succeeded Lucien Bonaparte as ambassador at Madrid. In 1803 he was appointed to the command of an army corps in Italy, in 1805 he served with distinction under Masséna, and in 1806 was engaged in the campaign in southern Italy. He took part in the Prussian and Polish campaigns of 1807, and in 1808, in which year he was made a count, he commanded an army corps in Catalonia; but, not wishing to comply with certain orders he received from Paris (for which see Oman, *Peninsular War*, vol. iii.), he resigned his command and remained in disgrace till 1811. He was still a general of division, having been excluded from the first list of marshals owing to his action in refusing to influence the troops in favour of the establishment of the Empire. On the opening of the Russian campaign he received command of an army corps, and on the 18th of August 1812 obtained a victory over the Russians at Polotak, in recognition of which he was created a marshal of France. He received a severe wound in one of the actions during the general retreat. St-Cyr distinguished himself at the battle of Dresden (August 26-27, 1813), and in the defence of that place against the Allies after the battle of Leipzig, capitulating only on the 11th of November, when Napoleon had retreated to the Rhine. On the restoration of the Bourbons he was created a peer of France, and in July 1815 was appointed war minister, but resigned his office in the November following. In June 1817 he was appointed minister of marine, and in September following again resumed the duties of war minister, which he continued to discharge till November 1819. During this time he effected many reforms, particularly in respect of measures tending to make the army a national rather than a dynastic force. He exerted himself also to safeguard the rights of the old soldiers of the Empire, organized the general staff and revised the code of military law and the pension regulations. He was made a marquis in 1817. He died at Hyères (Var) on the 17th of March 1830. Gouvion St-Cyr would doubtless have obtained better opportunities of acquiring distinction had he shown himself more blindly devoted to the interests of Napoleon, but Napoleon paid him the high compliment of referring to his "military genius," and entrusted him with independent commands in secondary theatres of war. It is doubtful, however, if he possessed energy commensurate with his skill, and in Napoleon's modern conception of war, as three parts moral to one technical, there was more need for

the services of a bold leader of troops whose "doctrine"—to use the modern phrase—predisposed him to self-sacrificing and vigorous action, than for a *savant* in the art of war of the type of St-Cyr. Contemporary opinion, as reflected by Marbot, did justice to his "commanding talents," but remarked the indolence which was the outward sign of the vague complexity of a mind that had passed beyond the simplicity of mediocrity without attaining the simplicity of genius.

He was the author of the following works, all of the highest value: *Journal des opérations de l'armée de Catalogne en 1808 et 1809* (Paris, 1821); *Mémoires sur les campagnes des armées de Rhin et de Rhin-et-Moselle de 1794 à 1797* (Paris, 1829); and *Mémoires pour servir à l'histoire militaire sous le Directoire, le Consulat, et l'Empire* (1831).

See Gay de Vernon's *Vie de Gouvion Saint-Cyr* (1857).

GOVAN, a municipal and police burgh of Lanarkshire, Scotland. It lies on the south bank of the Clyde in actual contact with Glasgow, and in a parish of the same name which includes a large part of the city on both sides of the river. Pop. (1891) 61,589; (1901) 76,532. Govan remained little more than a village till 1860, when the growth of shipbuilding and allied trades gave its development an enormous impetus. Among its public buildings are the municipal chambers, combination fever hospital, Samaritan hospital and reception houses for the poor. Elder Park (40 acres) presented to the burgh in 1885 contains a statue of John Elder (1824-1869), the pioneer shipbuilder, the husband of the donor. A statue of Sir William Pearce (1833-1888), another well-known Govan shipbuilder, once M.P. for the burgh, stands at Govan Cross. The Govan lunacy board opened in 1896 an asylum near Paisley. Govan is supplied with Glasgow gas and water, and its tramways are leased by the Glasgow corporation; but it has an electric light installation of its own, and performs all other municipal functions quite independently of the city, annexation to which it has always strenuously resisted. Prince's Dock lies within its bounds and the shipbuilding yards have turned out many famous ironclads and liners. Besides shipbuilding its other industries are match-making, silk-weaving, hair-working, copper-working, tube-making, weaving, and the manufacture of locomotives and electrical apparatus. The town forms the greater part of the Govan division of Lanarkshire, which returns one member to parliament.

GOVERNMENT (O. Fr. *gouvernement*, mod. *gouvernement*, O. Fr. *gouverner*, mod. *gouverner*, from Lat. *gubernare*, to steer a ship, guide, rule; cf. Gr. *κυβερνᾶν*), in its widest sense, the ruling power in a political society. In every society of men there is a determinate body (whether consisting of one individual or a few or many individuals) whose commands the rest of the community are bound to obey. This sovereign body is what in more popular phrase is termed the government of the country, and the varieties which may exist in its constitution are known as forms of government. For the opposite theory of a community with "no government," see ANARCHISM.

How did government come into existence? Various answers to this question have at times been given, which may be distinguished broadly into three classes. The first class would comprehend the legendary accounts which nations have given in primitive times of their own forms of government. These are always attributed to the mind of a single lawgiver. The government of Sparta was the invention of Lycurgus. Solon, Moses, Numa and Alfred in like manner shaped the government of their respective nations. There was no curiosity about the institutions of other nations—about the origin of governments in general; and each nation was perfectly ready to accept the traditional *romances* of any other.

The second may be called the logical or metaphysical account of the origin of government. It contained no overt reference to any particular form of government, whatever its covert references may have been. It answered the question, how government in general came into existence; and it answered it by a logical analysis of the elements of society. The phenomenon to be accounted for being government and laws, it abstracted government and laws, and contemplated mankind as existing

without them. The characteristic feature of this kind of speculation is that it reflects how contemporary men would behave if all government were removed, and infers that men must have behaved so before government came into existence. Society without government resolves itself into a number of individuals each following his own aims, and therefore, in the days before government, each man followed his own aims. It is easy to see how this kind of reasoning should lead to very different views of the nature of the supposed original state. With Hobbes, it is a state of war, and government is the result of an agreement among men to keep the peace. With Locke, it is a state of liberty and equality,—it is not a state of war; it is governed by its own law,—the law of nature, which is the same thing as the law of reason. The state of nature is brought to an end by the voluntary agreement of individuals to surrender their natural liberty and submit themselves to one supreme government. In the words of Locke, "Men being by nature all free, equal and independent, no one can be put out of this estate and subjected to the political power of another without his own consent. The only way whereby any one divests himself of his natural liberty, and puts on the bonds of civil society, is by agreeing with other men to join and unite into a community" (*On Civil Government*, c. viii.). Locke boldly defends his theory as founded on historical fact, and it is amusing to compare his demonstration of the baselessness of Sir R. Filmer's speculations with the scanty and doubtful examples which he accepts as the foundation of his own. But in general the various forms of the hypothesis eliminate the question of time altogether. The original contract from which government sprang is likewise the subsisting contract on which civil society continues to be based. The historical weakness of the theory was probably always recognized. Its logical inadequacy was conclusively demonstrated by John Austin. But it still clings to speculations on the principles of government.

The "social compact" (see ROUSSEAU) is the most famous of the metaphysical explanations of government. It has had the largest history, the widest influence and the most complete development. To the same class belong the various forms of the theory that governments exist by divine appointment. Of all that has been written about the divine right of kings, a great deal must be set down to the mere flatteries of courtiers and ecclesiastics. But there remains a genuine belief that men are bound to obey their rulers because their rulers have been appointed by God. Like the social compact, the theory of divine appointment avoided the question of historical fact.

The application of the historical method to the phenomena of society has changed the aspect of the question and robbed it of its political interest. The student of the history of society has no formula to express the law by which government is born. All that he can do is to trace governmental forms through various stages of social development. The more complex and the larger the society, the more distinct is the separation between the governing part and the rest, and the more elaborate is the subdivision of functions in the government. The primitive type of ruler is king, judge, priest and general. At the same time, his way of life differs little from that of his followers and subjects. The metaphysical theories were so far right in imputing greater equality of social conditions to more primitive times. Increase of bulk brings with it a more complex social organization. War tends to develop the strength of the governmental organization; peace relaxes it. All societies of men exhibit the germs of government; but there would appear to be races of men so low that they cannot be said to live together in society at all. Modern investigations have illustrated very fully the importance of the family (*q.v.*) in primitive societies, and the belief in a common descent has much to do with the social cohesion of a tribe. The government of a tribe resembles the government of a household; the head of the family is the ruler. But we cannot affirm that political government has its origin in family government, or that there may not have been states of society in which government of some sort existed while the family did not.

I. FORMS OF GOVERNMENT

Three Standard Forms.—Political writers from the time of Aristotle have been singularly unanimous in their classification of the forms of government. There are three ways in which states may be governed. They may be governed by one man, or by a number of men, small in proportion to the whole number of men in the state, or by a number large in proportion to the whole number of men in the state. The government may be a monarchy, an aristocracy or a democracy. The same terms are used by John Austin as were used by Aristotle, and in very nearly the same sense. The determining quality in governments in both writers, and it may safely be said in all intermediate writers, is the numerical relation between the constituent members of the government and the population of the state. There were, of course, enormous differences between the state-systems present to the mind of the Greek philosopher and the English jurist. Aristotle was thinking of the small independent states of Greece, Austin of the great peoples of modern Europe. The unit of government in the one case was a city, in the other a nation. This difference is of itself enough to invalidate all generalization founded on the common terminology. But on one point there is a complete parallel between the politics of Aristotle and the politics of Austin. The Greek cities were to the rest of the world very much what European nations and European colonies are to the rest of the world now. They were the only communities in which the governed visibly took some share in the work of government. Outside the European system, as outside the Greek system, we have only the stereotyped uniformity of despotism, whether savage or civilized. The question of forms of government, therefore, belongs characteristically to the European races. The virtues and defects of monarchy, aristocracy and democracy are the virtues and defects manifested by the historical governments of Europe. The generality of the language used by political writers must not blind us to the fact that they are thinking only of a comparatively small portion of mankind.

Greek Politics.—Aristotle divides governments according to two principles. In all states the governing power seeks either its own advantage or the advantage of the whole state, and the government is bad or good accordingly. In all states the governing power is one man, or a few men or many men. Hence six varieties of government, three of which are bad and three good. Each excellent form has a corresponding depraved form, thus:—

The good government of one (Monarchy) corresponds to the depraved form (Tyranny).

The good government of few (Aristocracy) corresponds to the depraved form (Oligarchy).

The good government of many (Commonwealth) corresponds to the depraved form (Democracy).

The fault of the depraved forms is that the governors act unjustly where their own interests are concerned. The worst of the depraved forms is tyranny, the next oligarchy and the least bad democracy.¹ Each of the three leading types exhibits a number of varieties. Thus in monarchy we have the heroic, the barbaric, the elective dictatorship, the Lacedæmonian (hereditary generalship, *στρατηγία*), and absolute monarchy. So democracy and oligarchy exhibit four corresponding varieties. The best type of democracy is that of a community mainly agricultural, whose citizens, therefore, have not leisure for political affairs, and allow the law to rule. The best oligarchy is that in which a considerable number of small proprietors have the power; here, too, the laws prevail. The worst democracy consists of a larger citizen-class having leisure for politics; and the worst oligarchy is that of a small number of very rich and influential men. In both the sphere of law is reduced to a minimum. A good government is one in which as much as possible is left to the laws, and as little as possible to the will of the governor.

¹ Aristotle elsewhere speaks of the error of those who think that any one of the depraved forms is better than any other.

The *Politics* of Aristotle, from which these principles are taken, presents a striking picture of the variety and activity of political life in the free communities of Greece. The king and council of heroic times had disappeared, and self-government in some form or other was the general rule. It is to be noticed, however, that the governments of Greece were essentially unstable. The political philosophers could lay down the law of development by which one form of government gives birth to another. Aristotle devotes a large portion of his work to the consideration of the causes of revolutions. The dread of tyranny was kept alive by the facility with which an over-powerful and unscrupulous citizen could seize the whole machinery of government. Communities oscillated between some form of oligarchy and some form of democracy. The security of each was constantly imperilled by the conspiracies of the opposing factions. Hence, although political life exhibits that exuberant variety of form and expression which characterizes all the intellectual products of Greece, it lacks the quality of persistent progress. Then there was no approximation to a national government, even of the federal type. The varying confederacies and hegemonies are the nearest approach to anything of the kind. What kind of national government would ultimately have arisen if Greece had not been crushed it is needless to conjecture; the true interest of Greek politics lies in the fact that the free citizens were, in the strictest sense of the word, self-governed. Each citizen took his turn at the common business of the state. He spoke his own views in the agora, and from time to time in his own person acted as magistrate or judge. Citizenship in Athens was a liberal education, such as it never can be made under any representative system.

The Government of Rome.—During the whole period of freedom the government of Rome was, in theory at least, municipal self-government. Each citizen had a right to vote laws in his own person in the comitia of the centuries or the tribes. The administrative powers of government were, however, in the hands of a bureaucratic assembly, recruited from the holders of high public office. The senate represented capacity and experience rather than rank and wealth. Without some such instrument the city government of Rome could never have made the conquest of the world. The gradual extension of the citizenship to other Italians changed the character of Roman government. The distant citizens could not come to the voting booths; the device of representation was not discovered; and the comitia fell into the power of the town voters. In the last stage of the Roman republic, the inhabitants of one town wielded the resources of a world-wide empire. We can imagine what would be the effect of leaving to the people of London or Paris the supreme control of the British empire or of France,—irresistible temptation, inevitable corruption. The rabble of the capital learn to live on the rest of the empire.¹ The favour of the effeminate masters of the world is purchased by *panem et circenses*. That capable officers and victorious armies should long be content to serve such masters was impossible. A conspiracy of generals placed itself at the head of affairs, and the most capable of them made himself sole master. Under Caesar, Augustus and Tiberius, the Roman people became habituated to a new form of government, which is best described by the name of Caesarism. The outward forms of republican government remained, but one man united in his own person all the leading offices, and used them to give a seemingly legal title to what was essentially military despotism. There is no more interesting constitutional study than the chapters in which Tacitus traces the growth of the new system under the subtle and dissimulating intellect of Tiberius. The new Roman empire was as full of fictions as the English constitution of the present day. The master of the world posed as the humble servant of a menial senate. Depre-

¹ None of the free states of Greece ever made extensive or permanent conquests; but the tribute sometimes paid by one state to another (as by the Aeginetans to the Athenians) was a manifest source of corruption. Compare the remarks of Hume (*Essays*, part i. 3, *That Politics may be reduced to a Science*), "free governments are the most ruinous and oppressive for their provinces."

cating the outward symbols of sovereignty, he was satisfied with the modest powers of a consul or a tribunus plebis. The reign of Tiberius, little capable as he was by personal character of captivating the favour of the multitude, did more for imperialism than was done by his more famous predecessors. Henceforward free government all over the world lay crushed beneath the military despotism of Rome. Caesarism remained true to the character imposed upon it by its origin. The Caesar was an elective not an hereditary king. The real foundation of his power was the army, and the army in course of time openly assumed the right of nominating the sovereign. The characteristic weakness of the Roman empire was the uncertainty of the succession. The nomination of a Caesar in the lifetime of the emperor was an ineffective remedy. Rival emperors were elected by different armies; and nothing less than the force of arms could decide the question between them.

Modern Governments.—Feudalism.—The Roman empire bequeathed to modern Europe the theory of universal dominion. The nationalities which grew up after its fall arranged themselves on the basis of territorial sovereignty. Leaving out of account the free municipalities of the middle ages, the problem of government had now to be solved, not for small urban communities, but for large territorial nations. The medieval form of government was feudal. One common type pervaded all the relations of life. The relation of king and lord was like the relation between lord and vassal (see FEUDALISM). The bond between them was the tenure of land. In England there had been, before the Norman Conquest, an approximation to a feudal system. In the earlier English constitution, the most striking features were the power of the witan, and the common property of the nation in a large portion of the soil. The steady development of the power of the king kept pace with the aggregation of the English tribes under one king. The conception that the land belonged primarily to the people gave way to the conception that everything belonged primarily to the king.² The Norman Conquest imposed on England the already highly developed feudalism of France, and out of this feudalism the free governments of modern Europe have grown. One or two of the leading steps in this process may be indicated here. The first, and perhaps the most important, was the device of representation. For an account of its origin, and for instances of its use in England before its application to politics, we must be content to refer to Stubbs's *Constitutional History*, vol. II. The problem of combining a large area of sovereignty with some degree of self-government, which had proved fatal to ancient commonwealths, was henceforward solved. From that time some form of representation has been deemed essential to every constitution professing, however remotely, to be free.

The connexion between representation and the feudal system of estates must be shortly noticed. The feudal theory gave the king a limited right to military service and to certain aids, both of which were utterly inadequate to meet the expenses of the government, especially in time of war. The king therefore had to get contributions from his people, and he consulted them in their respective orders. The three estates were simply the three natural divisions of the people, and Stubbs has pointed out that, in the occasional treaties between a necessitous king and the order of merchants or lawyers, we have examples of inchoate estates or sub-estates of the realm. The right of representation was thus in its origin a right to consent to taxation. The pure theory of feudalism had from the beginning been broken by William the Conqueror causing all free-holders to take an oath of direct allegiance to himself. The institution of parliaments, and the association of the king's smaller tenants *in capite* with other commoners, still further removed the

² Ultimately, in the theory of English law, the king may be said to have become the universal successor of the people. Some of the peculiarities of the prerogative rights seem to be explainable only on this view, e.g. the curious distinction between wrecks come to land and wrecks still on water. The common right to wreckage was no doubt the origin of the prerogative right to the former. Every ancient common right has come to be a right of the crown or a right held of the crown by a vassal.

government from the purely feudal type in which the meane lord stands between the inferior vassal and the king.

Parliamentary Government.—The English System.—The right of the commons to share the power of the king and lords in legislation, the exclusive right of the commons to impose taxes, the disappearance of the clergy as a separate order, were all important steps in the movement towards popular government. The extinction of the old feudal nobility in the dynastic wars of the 15th century simplified the question by leaving the crown face to face with parliament. The immediate result was no doubt an increase in the power of the crown, which probably never stood higher than it did in the reigns of Henry VIII. and Elizabeth; but even these powerful monarchs were studious in their regard for parliamentary conventionalities. After a long period of speculative controversy and civil war, the settlement of 1688 established limited monarchy as the government of England. Since that time the external form of government has remained unchanged, and, so far as legal description goes, the constitution of William III. might be taken for the same system as that which still exists. The silent changes have, however, been enormous. The most striking of these, and that which has produced the most salient features of the English system, is the growth of cabinet government. Intimately connected with this is the rise of the two great historical parties of English politics. The normal state of government in England is that the cabinet of the day shall represent that which is, for the time, the stronger of the two. Before the Revolution the king's ministers had begun to act as a united body; but even after the Revolution the union was still feeble and fluctuating, and each individual minister was bound to the others only by the tie of common service to the king. Under the Hanoverian sovereigns the ministry became consolidated, the position of the cabinet became definite, and its dependence on parliament, and more particularly on the House of Commons, was established. Ministers were chosen exclusively from one house or the other, and they assumed complete responsibility for every act done in the name of the crown. The simplicity of English politics has divided parliament into the representatives of two parties, and the party in opposition has been steadied by the consciousness that it, too, has constitutional functions of high importance, because at any moment it may be called to provide a ministry. Criticism is sobered by being made responsible. Along with this movement went the withdrawal of the personal action of the sovereign in politics. No king has attempted to veto a bill since the Scottish Militia Bill was vetoed by Queen Anne. No ministry has been dismissed by the sovereign since 1834. Whatever the power of the sovereign may be, it is unquestionably limited to his personal influence over his ministers. And it must be remembered that since the Reform Act of 1832 ministers have become, in practice, responsible ultimately, not to parliament, but to the House of Commons. Apart, therefore, from democratic changes due to a wider suffrage, we find that the House of Commons, as a body, gradually made itself the centre of the government. Since the area of the constitution has been enlarged, it may be doubted whether the orthodox descriptions of the government any longer apply. The earlier constitutional writers, such as Blackstone and J. L. Delolme, regard it as a wonderful compound of the three standard forms,—monarchy, aristocracy and democracy. Each has its place, and each acts as a check upon the others. Hume, discussing the question "Whether the British government inclines more to absolute monarchy or to a republic," decides in favour of the former alternative. "The tide has run long and with some rapidity to the side of popular government, and is just beginning to turn toward monarchy." And he gives it as his own opinion that absolute monarchy would be the easiest death, the true euthanasia of the British constitution. These views of the English government in the 18th century may be contrasted with Bagebot's sketch of the modern government as a working instrument.¹

¹ See Bagebot's *English Constitution*; or, for a more recent analysis, Sidney Low's *Governance of England*.

Leading Features of Parliamentary Government.—The parliamentary government developed by England out of feudal materials has been deliberately accepted as the type of constitutional government all over the world. Its leading features are popular representation more or less extensive, a bicameral legislature, and a cabinet or consolidated ministry. In connexion with all of these, numberless questions of the highest practical importance have arisen, the bare enumeration of which would surpass the limits of our space. We shall confine ourselves to a few very general considerations.

The Two Chambers.—First, as to the double chamber. This, which is perhaps more accidental than any other portion of the British system, has been the most widely imitated. In most European countries, in the British colonies, in the United States Congress, and in the separate states of the Union,² there are two houses of legislature. This result has been brought about partly by natural imitation of the accepted type of free government, partly from a conviction that the second chamber will moderate the democratic tendencies of the first. But the elements of the British original cannot be reproduced to order under different conditions. There have, indeed, been a few attempts to imitate the special character of hereditary nobility attaching to the British House of Lords. In some countries, where the feudal tradition is still strong (e.g. Prussia, Austria, Hungary), the hereditary element in the upper chambers has survived as truly representative of actual social and economic relations. But where these social conditions do not obtain (e.g. in France after the Revolution) the attempt to establish an hereditary peerage on the British model has always failed. For the peculiar solidarity between the British nobility and the general mass of the people, the outcome of special conditions and tendencies, is a result beyond the power of constitution-makers to attain. The British system too, after its own way, has for a long period worked without any serious collision between the Houses,—the standing and obvious danger of the bicameral system. The actual ministers of the day must possess the confidence of the House of Commons; they need not—in fact³ they often do not—possess the confidence of the House of Lords. It is only in legislation that the Lower House really shares its powers with the Upper; and (apart from any such change in the constitution as was suggested in 1907 by Sir H. Campbell-Bannerman) the constitution possesses, in the unlimited power of nominating peers, a well-understood last resource should the House of Lords persist in refusing important measures demanded by the representatives of the people. In the United Kingdom it is well understood that the real sovereignty lies with the people (the electorate), and the House of Lords recognizes the principle that it must accept a measure when the popular will has been clearly expressed. In all but measures of first-class importance, however, the House of Lords is a real second chamber, and in these there is little danger of a collision between the Houses. There is the widest possible difference between the British and any other second chamber. In the United States the Senate (constituted on the system of equal representation of states) is the more important of the two Houses, and the only one whose control of the executive can be compared to that exercised by the British House of Commons.

The real strength of popular government in England lies in the ultimate supremacy of the House of Commons. That supremacy had been acquired, perhaps to its full extent, before the extension of the suffrage made the constituencies democratic. Foreign imitators, it may be observed, have been more ready to accept a wide basis of representation than to confer real power on the representative body. In all the monarchical countries of Europe, however unrestricted the right of suffrage may be, the real victory of constitutional government has yet to be won. Where the suffrage means little or nothing, there is little or no reason for guarding it against abuse. The independence of the executive in the United States brings that country, from one

² For an account of the double chamber system in the state legislatures see UNITED STATES: *Constitution and Government*, and also S. G. Fisher, *The Evolution of the Constitution* (Philadelphia, 1897).

point of view, more near to the state system of the continent of Europe than to that of the United Kingdom. The people make a more complete surrender of power to the government (State or Federal) than is done in England.

Cabinet Government.—The peculiar functions of the English cabinet are not easily matched in any foreign system. They are a mystery even to most educated Englishmen. The cabinet (*q.v.*) is much more than a body consisting of chiefs of departments. It is the inner council of the empire, the arbiter of national policy, foreign or domestic, the sovereign in commission. The whole power of the House of Commons is concentrated in its hands. At the same time, it has no place whatever in the legal constitution. Its numbers and its constitution are not fixed even by any rule of practice. It keeps no record of its proceedings. The relations of an individual minister to the cabinet, and of the cabinet to its head and creator, the premier, are things known only to the initiated. With the doubtful exception of France, no other system of government presents us with anything like its equivalent. In the United States, as in the European monarchies, we have a council of ministers surrounding the chief of the state.

Change of Power in the English System.—One of the most difficult problems of government is how to provide for the devolution of political power, and perhaps no other question is so generally and justly applied as the test of a working constitution! If the transmission works smoothly, the constitution, whatever may be its other defects, may at least be pronounced stable. It would be tedious to enumerate all the contrivances which this problem has suggested to political societies. Here, as usual, oriental despotism stands at the bottom of the scale. When sovereign power is imputed to one family, and the law of succession fails to designate exclusively the individual entitled to succeed, assassination becomes almost a necessary measure of precaution. The prince whom chance or intrigue has promoted to the throne of a father or an uncle must make himself safe from his relatives and competitors. Hence the scenes which shock the European conscience when "Amurath an Amurath succeeds." The strong monarchical governments of Europe have been saved from this evil by an indisputable law of succession, which marks out from his infancy the next successor to the throne. The king names his ministers, and the law names the king. In popular or constitutional governments far more elaborate precautions are required. It is one of the real merits of the English constitution that it has solved this problem—in a roundabout way perhaps, after its fashion—but with perfect success. The ostensible seat of power is the throne, and down to a time not long distant the demise of the crown suspended all the other powers of the state. In point of fact, however, the real change of power occurs on a change of ministry. The constitutional practice of the 19th century settled, beyond the reach of controversy, the occasions on which a ministry is bound to retire. It must resign or dissolve when it is defeated¹ in the House of Commons, and if after a dissolution it is beaten again, it must resign without alternative. It may resign if it thinks its majority in the House of Commons not sufficiently large. The dormant functions of the crown now come into existence. It receives back political power from the old ministry in order to transmit it to the new. When the new ministry is to be formed, and how it is to be formed, is also clearly settled by established practice. The outgoing premier names his successor by recommending the king to consult him; and that successor must be the recognized leader of his successful rivals. All this is a matter of custom, not of law; and it is doubtful if any two authorities could agree in describing the custom in language of precision. In theory the monarch may send for any one he pleases, and charge him with the formation of a government; but the ability to form a government restricts this liberty to the recognized head of a party, subject to there being such an individual. It is certain that the intervention of the crown

¹ A government "defeat" may, of course, not really represent a hostile vote in exceptional cases, and in some instances a government has obtained a reversal of the vote and has *not* resigned.

facilitates the transfer of power from one party to another by giving it the appearance of a mere change of servants. The real disturbance is that caused by the appeal to the electors. A general election is always a struggle between the great political parties for the possession of the powers of government. It may be noted that modern practice goes far to establish the rule that a ministry beaten at the hustings should resign at once without waiting for a formal defeat in the House of Commons.

The English custom makes the ministry dependent on the will of the House of Commons; and, on the other hand, the House of Commons itself is dependent on the will of the ministry. In the last result both depend on the will of the constituencies, as expressed at the general election. There is no fixity in either direction in the tenure of a ministry. It may be challenged at any moment, and it lasts until it is challenged and beaten. And that there should be a ministry and a House of Commons in harmony with each other but out of harmony with the people is rendered all but impossible by the law and the practice as to the duration of parliaments.

Change of Power in the United States.—The United States offers a very different solution of the problem. The American president is at once king and prime minister; and there is no titular superior to act as a conduit-pipe between him and his successor. His crown is rigidly fixed; he can be removed only by the difficult method of impeachment. No hostile vote on matters of legislation can affect his position. But the end of his term is known from the first day of his government; and almost before he begins to reign the political forces of the country are shaping out a new struggle for the succession. Further, a change of government in America means a considerable change in the administrative staff (see *CIVIL SERVICE*). The commotion caused by a presidential election in the United States is thus infinitely greater and more prolonged than that caused by a general election in England. A change of power in England affects comparatively few personal interests, and absorbs the attention of the country for a comparatively short space of time. In the United States it is long foreseen and elaborately prepared for, and when it comes it involves the personal fortunes of large numbers of citizens. And yet the British constitution is more democratic than the American, in the sense that the popular will can more speedily be brought to bear upon the government.

Change of Power in France.—The established practice of England and America may be compared with the constitutionalism of France. Here the problem presents different conditions. The head of the state is neither a premier of the English, nor a president of the American type. He is served by a prime minister and a cabinet, who, like an English ministry, hold office on the condition of parliamentary confidence; but he holds office himself on the same terms, and is, in fact, a minister like the others. So far as the transmission of power from cabinet to cabinet is concerned, he discharges the functions of an English king. But the transmission of power between himself and his successor is protected by no constitutional devices whatever, and experience would seem to show that no such devices are really necessary. Other European countries professing constitutional government appear to follow the English practice. The Swiss republic is so peculiarly situated that it is hardly fair to compare it with any other. But it is interesting to note that, while the rulers of the states are elected annually, the same persons are generally re-elected.

The Relation between Government and Laws.—It might be supposed that, if any general proposition could be established about government, it would be one establishing some constant relation between the form of a government and the character of the laws which it enforces. The technical language of the English school of jurists is certainly of a kind to encourage such a supposition. The entire body of law in force in a country at any moment is regarded as existing solely by the fiat of the governing power. There is no maxim more entirely in the spirit of this jurisprudence than the following:—"The real legislator is not he by whom the law was first ordained, but he by whose will it continues to be law." The whole of the vast repertory

of rules which make up the law of England—the rules of practice in the courts, the local customs of a county or a manor, the principles formulated by the sagacity of generations of judges, equally with the statutes for the year, are conceived of by the school of Austin as created by the will of the sovereign and the two Houses of Parliament, or so much of them as would now satisfy the definition of sovereignty. It would be out of place to examine here the difficulties which embarrass this definition, but the statement we have made carries on its face a demonstration of its own falsity in fact. There is probably no government in the world of which it could be said that it might change at will the substantive laws of the country and still remain a government. However well it may suit the purposes of analytical jurisprudence to define a law as a command set by sovereign to subject, we must not forget that this is only a definition, and that the assumption it rests upon is, to the student of society, anything but a universal fact. From his point of view the cause of a particular law is not one but many, and of the many the deliberate will of a legislator may not be one. Sir Henry Maine has illustrated this point by the case of the great tax-gathering empires of the east, in which the absolute master of millions of men never dreams of making anything in the nature of a law at all. This view is no doubt as strange to the English statesman as to the English jurist. The most conspicuous work of government in his view is that of parliamentary legislation. For a large portion of the year the attention of the whole people is bent on the operations of a body of men who are constantly engaged in making new laws. It is natural, therefore, to think of law as a factitious thing, made and unmade by the people who happen for the time being to constitute parliament. It is forgotten how small a proportion the laws actually devised by parliament are of the law actually prevailing in the land. No European country has undergone so many changes in the form of government as France. It is surprising how little effect these political revolutions have had on the body of French law. The change from empire to republic is not marked by greater legislative effects than the change from a Conservative to a Liberal ministry in England would be.

These reflections should make us cautious in accepting any general proposition about forms of government and the spirit of their laws. We must remember, also, that the classification of governments according to the numerical proportion between governors and governed supplies but a small basis for generalization. What parallel can be drawn between a small town, in which half the population are slaves, and every freeman has a direct voice in the government, and a great modern state, in which there is not a single slave, while freemen exercise their sovereign powers at long intervals, and through the action of delegates and representatives? Propositions as vague as those of Montesquieu may indeed be asserted with more or less plausibility. But to take any leading head of positive law, and to say that monarchies treat it in one way, aristocracies and democracies in another, is a different matter.

II. SPHERE OF GOVERNMENT

The action of the state, or sovereign power, or government in a civilized community shapes itself into the threefold functions of legislation, judicature and administration. The two first are perfectly well-defined, and the last includes all the kinds of state action not included in the other two. It is with reference to legislation and administration that the line of permissible state-action requires to be drawn. There is no doubt about the province of the judicature, and that function of government may therefore be dismissed with a very few observations.

The complete separation of the three functions marks a high point of social organization. In simple societies the same officers discharge all the duties which we divide between the legislator, the administrator and the judge. The acts themselves are not consciously recognized as being of different kinds. The evolution of all the parts of a highly complex government from one original is illustrated in a striking way by the history of English institutions. All the conspicuous parts of the modern

government, however little they may resemble each other now, can be followed back without a break to their common origin. Parliament, the cabinet, the privy council, the courts of law, all carry us back to the same *status* in the council of the feudal king.

Judicature.—The business of judicature, requiring as it does the possession of a high degree of technical skill and knowledge, is generally entrusted by the sovereign body or people to a separate and independent class of functionaries. In England the appellate jurisdiction of the House of Lords still maintains in theory the connexion between the supreme legislative and the supreme judicial functions. In some states of the American Union certain judicial functions of the upper house were for a time maintained after the example of the English constitution as it existed when the states were founded. In England there is also still a considerable amount of judicial work in which the people takes its share. The inferior magistracies, except in populous places, are in the hands of private persons. And by the jury system the ascertainment of fact has been committed in very large measure to persons selected indiscriminately from the mass of the people, subject to a small property qualification. But the higher functions of the judicature are exercised by persons whom the law has jealously fenced off from external interference and control. The independence of the bench distinguishes the English system from every other. It was established in principle as a barrier against monarchical power, and hence has become one of the traditional ensigns of popular government. In many of the American states the spirit of democracy has demanded the subjection of the judiciary to popular control. The judges are elected directly by the people, and hold office for a short term, instead of being appointed, as in England, by the responsible executive, and removable only by a vote of the two Houses. At the same time the constitution of the United States has assigned to the supreme court of the Union a perfectly unique position. The supreme court is the guardian of the constitution (as are the state courts of the constitution of the states; see UNITED STATES). It has to judge whether a measure passed by the legislative powers is not void by reason of being unconstitutional, and it may therefore have to veto the deliberate resolutions of both Houses of Congress and the president. It is admitted that this singular experiment in government has been completely justified by its success.

Limits of State Interference in Legislation and Administration.—The question of the limits of state action does not arise with reference to the judiciary. The enforcement of the laws is a duty which the sovereign power must of absolute necessity take upon itself. But to what conduct of the citizens the laws shall extend is the most perplexing of all political questions. The correlative question with regard to the executive would be what works of public convenience should the state undertake through its own servants. The whole question of the sphere of government may be stated in these two questions: What should the state do for its citizens? and How far should the state interfere with the action of its citizens? These questions are the direct outcome of modern popular government; they are equally unknown to the small democracies of ancient times and to despotic governments at all times. Accordingly ancient political philosophy, rich as it is in all kinds of suggestions, has very little to say that has any bearing on the sphere of government. The conception that the power of the state can be and ought to be limited belongs to the times of "government by discussion," to use Bagehot's expression,—to the time when the sovereign number is divided by class interests, and when the action of the majority has to be carried out in the face of strong minorities, capable of making themselves heard. Aristotle does indeed dwell on one aspect of the question. He would limit the action of the government in the sense of leaving as little as possible to the personal will of the governors, whether one or many. His maxim is that the law should reign. But that the sphere of law itself should be restricted, otherwise than by general principles of morality, is a consideration wholly foreign to ancient philosophy. The state is conceived as acting like

a just man, and justice in the state is the same thing as justice in the individual. The Greek institutions which the philosophers are unanimous in commending are precisely those which the most state-ridden nations of modern times would agree in repudiating. The exhaustive discussion of all political measures, which for over two centuries has been a fixed habit of English public life, has of itself established the principle that there are assignable limits to the action of the state. Not that the limits ever have been assigned in terms, but popular sentiment has more or less vaguely fenced off departments of conduct as sacred from the interference of the law. Phrases like "the liberty of the subject," the "sanctity of private property," an Englishman's house is his castle," "the rights of conscience," are the commonplaces of political discussion, and tell the state, "Thus far shalt thou go and no further."

The two contrasting policies are those of *laissez-faire* (let alone) and Protection, or individualism and state-socialism, the one a policy of non-interference with the free play of social forces, the other their regulation for the benefit of the community. The *laissez-faire* theory was prominently upheld by John Stuart Mill, whose essay on *Liberty*, together with the concluding chapters of his treatise on *Political Economy*, gives a tolerably complete view of the principles of government. There is a general presumption against the interference of government, which is only to be overcome by very strong evidence of necessity. Governmental action is generally less effective than voluntary action. The necessary duties of government are so burdensome, that to increase them destroys its efficiency. Its powers are already so great that individual freedom is constantly in danger. As a general rule, nothing which can be done by the voluntary agency of individuals should be left to the state. Each man is the best judge of his own interests. But, on the other hand, when the thing itself is admitted to be useful or necessary, and it cannot be effected by voluntary agency, or when it is of such a nature that the consumer cannot be considered capable of judging of the quality supplied, then Mill would allow the state to interpose. Thus the education of children, and even of adults, would fairly come within the province of the state. Mill even goes so far as to admit that, where a restriction of the hours of labour, or the establishment of a periodical holiday, is proved to be beneficial to labourers as a class, but cannot be carried out voluntarily on account of the refusal of individuals to co-operate, government may justifiably compel them to co-operate. Still further, Mill would desire to see some control exercised by the government over the operations of those voluntary associations which, consisting of large numbers of shareholders, necessarily leave their affairs in the hands of one or a few persons. In short, Mill's general rule against state action admits of many important exceptions, founded on no principle less vague than that of public expediency. The essay on *Liberty* is mainly concerned with freedom of individual character, and its arguments apply to control exercised, not only by the state, but by society in the form of public opinion. The leading principle is that of Humboldt, "the absolute and essential importance of human development in its richest diversity." Humboldt broadly excluded education, religion and morals from the action, direct and indirect, of the state. Mill, as we have seen, conceives education to be within the province of the state, but he would confine its action to compelling parents to educate their children.

The most thoroughgoing opponent of state action, however, is Herbert Spencer. In his *Social Statics*, published in 1850, he holds it to be the essential duty of government to *protect*—to maintain men's rights to life, to personal liberty and to property; and the theory that the government ought to undertake other offices besides that of protector he regards as an untenable theory. Each man has a right to the fullest exercise of all his faculties, compatible with the same right in others. This is the fundamental law of equal freedom, which it is the duty and the only duty of the state to enforce. If the state goes beyond this duty, it becomes, not a protector, but an aggressor. Thus all state regulations of commerce, all religious

establishments, all government relief of the poor, all state systems of education and of sanitary superintendence, even the state currency and the post-office, stand condemned, not only as ineffective for their respective purposes, but as involving violations of man's natural liberty.

The tendency of modern legislation is more a question of political practice than of political theory. In some cases state interference has been abolished or greatly limited. These cases are mainly two—in matters of opinion (especially religious opinion), and in matters of contract.

The mere enumeration of the individual instances would occupy a formidable amount of space. The reader is referred to such articles as ENGLAND, CHURCH OF; ESTABLISHMENT; MARRIAGE; OATH; ROMAN CATHOLIC CHURCH, &c., and COMPANY; CONTRACT; PARTNERSHIP, &c. In other cases the state has interfered for the protection and assistance of definite classes of persons. For example, the education and protection of children (see CHILDREN, LAW RELATING TO; EDUCATION; TECHNICAL EDUCATION); the regulation of factory labour and dangerous employment (see LABOUR LEGISLATION); improved conditions of health (see ADULTERATION; HOUSING; PUBLIC HEALTH, LAW OF, &c.); coercion for moral purposes (see BET AND BETTING; CRIMINAL LAW; GAMING AND WAGGING; LIQUOR LAWS; LOTTERIES, &c.). Under numerous other headings in this work the evolution of existing forms of government is discussed; see also the bibliographical note to the article CONSTITUTION AND CONSTITUTIONAL LAW.

GOVERNOR (from the Fr. *gouverneur*, from *gouverner*, O. Fr. *governer*, Lat. *gubernare*, to steer a ship, to direct, guide), in general, one who governs or exercises authority; specifically, an official appointed to govern a district, province, town, &c. In British colonies or dependencies the representative of the crown is termed a governor. Colonial governors are classed as governors-general, governors and lieutenant-governors, according to the status of the colony or group of colonies over which they preside. Their powers vary according to the position which they occupy. In all cases they represent the authority of the crown. In the United States (*q.v.*) the official at the head of every state government is called a governor.

GOW, NIEL (1727-1807), Scottish musician of humble parentage, famous as a violinist and player of reeds, but more so for the part he played in preserving the old melodies of Scotland. His compositions, and those of his four sons, Nathaniel, the most famous (1763-1831), William (1751-1791), Andrew (1760-1803), and John (1764-1826), formed the "Gow Collection," comprising various volumes edited by Niel and his sons, a valuable repository of Scottish traditional airs. The most important of Niel's sons was Nathaniel, who is remembered as the author of the well-known "Caller Herrin," taken from the fishwives' cry, a tune to which words were afterwards written by Lady Nairne. Nathaniel's son, NIEL GOW junior (1795-1823), was the author of the famous songs "Flora Macdonald's Lament" and "Cam' ye by Athol."

GOWER, JOHN (d. 1408), English poet, died at an advanced age in 1408, so that he may be presumed to have been born about 1330. He belonged to a good Kentish family, but the suggestion of Sir Harris Nicolas that the poet is to be identified with a John Gower who was at one time possessed of the manor of Kentwell is open to serious objections. There is no evidence that he ever lived as a country gentleman, but he was undoubtedly possessed of some wealth, and we know that he was the owner of the manors of Felthw in Suffolk and Moulton in Norfolk. In a document of 1382 he is called an "Esquier de Kent," and he was certainly not in holy orders. That he was acquainted with Chaucer we know, first because Chaucer in leaving England for Italy in 1378 appointed Gower and another to represent him in his absence, secondly because Chaucer addressed his *Troilus and Criseide* to Gower and Strode (whom he addresses as "moral Gower" and "philosophical Strode") for criticism and correction, and thirdly because of the lines in the first edition of Gower's *Confessio amantis*, "And gret wel Chaucer whan ye mete," &c. There is no sufficient ground for the suggestion, based partly on the subsequent omission of these lines and partly on the humorous reference of Chaucer to Gower's *Confessio amantis* in the Introduction to the *Man of Law's Tale*, that the friendship was broken by a quarrel. From his Latin poem

Vox clamantis we know that he was deeply and painfully interested in the peasants' rising of 1381; and by the alterations which the author made in successive revisions of this work we can trace a gradually increasing sense of disappointment in the youthful king, whom he at first acquits of all responsibility for the state of the kingdom on account of his tender age. That he became personally known to the king we learn from his own statement in the first edition of the *Confessio amantis*, where he says that he met the king upon the river, was invited to enter the royal barge, and in the conversation which followed received the suggestion which led him to write his principal English poem. At the same time we know, especially from the later revisions of the *Confessio amantis*, that he was a great admirer of the king's brilliant cousin, Henry of Lancaster, afterwards Henry IV., whom he came eventually to regard as a possible saviour of society from the misgovernment of Richard II. We have a record that in 1393 he received a collar from his favourite political hero, and it is to be observed that the effigy upon Gower's tomb is wearing a collar of SS. with the swan badge which was used by Henry.

The first edition of the *Confessio amantis* is dated 1390, and this contains, at least in some copies, a secondary dedication to the then earl of Derby. The later form, in which Henry became the sole object of the dedication, is of the year 1393. Gower's political opinions are still more strongly expressed in the *Cronica tripartita*.

In 1398 he was married to Agnes Groundolf, and from the special licence granted by the bishop of Winchester for the celebration of this marriage in John Gower's private oratory we gather that he was then living in lodgings assigned to him within the priory of St Mary Overy, and perhaps also that he was too infirm to be married in the parish church. It is probable that this was not his first marriage, for there are indications in his early French poem that he had a wife at the time when that was written. His will is dated the 15th of August 1408, and his death took place very soon after this. He had been blind for some years before his death. A magnificent tomb with a recumbent effigy was erected over his grave in the chapel of St John the Baptist within the church of the priory, now St Saviour's, Southwark, and this is still to be seen, though not quite in its original state or place. From the inscription on the tomb, as well as from other indications, it appears that he was a considerable benefactor of the priory and contributed largely to the rebuilding of the church.

The effigy on Gower's tomb rests its head upon a pile of three folio volumes entitled *Speculum meditantis*, *Vox clamantis* and *Confessio amantis*. These are his three principal works. The first of these was long supposed to have perished, but a copy of it was discovered in the year 1895 under the title *Miroir de l'homme*. It is a French poem of about 30,000 lines in twelve-line stanzas, and under the form of an allegory of the human soul describes the seven deadly sins and their opposing virtues, and then the various estates of man and the vices incident to each, concluding with a narrative of the life of the Virgin Mary, and with praise of her as the means of reconciliation between God and man. The work is extremely tedious for the most part, but shows considerable command over the language and a great facility in metrical expression.

Gower's next work was the *Vox clamantis* in Latin elegiac verse, in which the author takes occasion from the peasants' insurrection of 1381 to deal again with the faults of the various classes of society. In the earlier portion the insurrection itself is described in a rather vivid manner, though under the form of an allegory: the remainder contains much the same material as we have already seen in that part of the French poem where the classes of society are described. Gower's Latin verse is very fair, as judged by the medieval standard, but in this book he has borrowed very freely from Ovid, Alexander Neckam, Peter de Riga and others.

Gower's chief claim, however, to reputation as a poet rests upon his English work, the *Confessio amantis*, in which he displays in his native language a real gift as a story-teller. He

is himself the lover of his poem, in spite of his advancing years, and he makes his confession to Genius, the priest of Venus, under the usual headings supplied by the seven deadly sins. These with their several branches are successively described, and the nature of them illustrated by tales, which are directed to the illustration both of the general nature of the sin, and of the particular form which it may take in a lover. Finally he receives at once his absolution, and his dismissal from the service of Venus, for which his age renders him unfit. The idea is ingenious, and there is often much quaintness of fancy in the application of moral ideas to the relations of the lover and his mistress. The tales are drawn from very various sources and are often extremely well told. The metre is the short couplet, and it is extremely smooth and regular. The great fault of the *Confessio amantis* is the extent of its digressions, especially in the fifth and seventh books.

Gower also wrote in 1397 a short series of French ballades on the virtue of the married state (*Traditio pour essayer les amants mariés*), and after the accession of Henry IV. he produced the *Cronica tripartita*, a partisan account in Latin leonine hexameters of the events of the last twelve years of the reign of Richard II. About the same time he addressed an English poem in seven-line stanzas to Henry IV. (*In Praise of Peace*), and dedicated to the king a series of French ballades (*Cinquante Balades*), which deal with the conventional topics of love, but are often graceful and even poetical in expression. Several occasional Latin pieces also belong to the later years of his life.

On the whole Gower must be admitted to have had considerable literary powers; and though not a man of genius, and by no means to be compared with Chaucer, yet he did good service in helping to establish the standard literary language, which at the end of the 14th century took the place of the Middle English dialects. The *Confessio amantis* was long regarded as a classic of the language, and Gower and Chaucer were often mentioned side by side as the fathers of English poetry.

A complete edition of Gower's works in four volumes, edited by G. C. Macaulay, was published in 1899-1902, the first volume containing the French works, the second and third the English, and the fourth the Latin, with a biography. Before this the *Confessio amantis* had been published in the following editions: Caxton (1483); Berthelette (1532 and 1554); Chalmers, *British Poets* (1810); Reinhold Pauli (1857); H. Morley (1889, incomplete). The two series of French ballades and the *Praise of Peace* were printed for the Roxburghe Club in 1818, and the *Vox clamantis* and *Cronica tripartita* were edited by H. O. Coxe for the Roxburghe Club in 1850. The *Cronica tripartita*, the *Praise of Peace* and some of the minor Latin poems were printed in Wright's *Political Poems* (Rolls series, 14). The *Praise of Peace* appeared in the early folio editions of Chaucer, and has been edited also by Dr Skeat in his *Chaucerian and other Pieces*. Reference may be made to Todd's *Illustrations of the Lives and Writings of Gower and Chaucer*; the article (by Sir H. Nicolas) in the *Retrospective Review* for 1828; *Observations on the Language of Chaucer and Gower*, by F. J. Child; H. Morley's *English Writers*, iv.; Ten Brink's *History of Early English Literature*, ii.; and Courthope's *History of English Poetry*, i. (G. C. M.)

GOWER, a seigniory and district in the county of Glamorgan, lying between the rivers Tawe and Loughor and between Breconshire and the sea, its length from the Breconshire border to Worm's Head being 28 m., and its breadth about 8 m. It corresponds to the ancient commote of Gower (in Welsh *Gwyr*) which in early Welsh times was grouped with two other commotes stretching westwards to the Towy and so formed part of the principality of Ystrad Tywi. Its early association with the country to the west instead of with Glamorgan is perpetuated by its continued inclusion in the diocese of St David's, its two rural deaneries, West and East Gower, being in the archdeaconry of Carmarthen. What is meant by Gower in modern popular usage, however, is only the peninsular part or "English Gower" (that is the Welsh *Bre-wyr*, as distinct from *Gwyr* proper), roughly corresponding to the hundred of Swansea and lying mainly to the south of a line drawn from Swansea to Loughor.

The numerous limestone caves of the coast are noted for their immense deposits of animal remains, but their traces of man are far scantier, those found in Bacon Hole and in Paviland cave

being the most important. In the Roman period the river Tawe, or the great morass between it and the Neath, probably formed the boundary between the Silures and the Goidelic population to the west. The latter, reinforced perhaps from Ireland, continued to be the dominant race in Gower till their conquest or partial expulsion in the 4th century by the sons of Cunedda who introduced a Brythonic element into the district. Centuries later Scandinavian rovers raided the coasts, leaving traces of their more or less temporary occupation in such place-names as Burry Holms, Worms Head and Swansea, and probably also in some cliff earthworks. About the year 1100 the conquest of Gower was undertaken by Henry de Newburgh, first earl of Warwick, with the assistance of Maurice de Londres and others. His followers, who were mostly Englishmen from the marches and Somersetshire with perhaps a sprinkling of Flemings, settled for the most part on the southern side of the peninsula, leaving the Welsh inhabitants of the northern half of Gower practically undisturbed. These invaders were probably reinforced a little later by a small detachment of the larger colony of Flemings which settled in south Pembrokeshire. Moated mounds, which in some cases developed into castles, were built for the protection of the various manors into which the district was parcelled out, the castles of Swansea and Loughor being ascribed to the earl of Warwick and that of Oystermouth to Maurice de Londres. These were repeatedly attacked and burnt by the Welsh during the 12th and 13th centuries, notably by Griffith ap Rhys in 1113, by his son the Lord Rhys in 1189, by his grandsons acting in concert with Llewelyn the Great in 1215, and by the last Prince Llewelyn in 1257. With the Norman conquest the feudal system was introduced, and the manors were held *in capite* of the lord by the tenure of castle-guard of the castle of Swansea, the *caput baroniae*.

About 1189 the lordship passed from the Warwick family to the crown and was granted in 1203 by King John to William de Braose, in whose family it remained for over 120 years except for three short intervals when it was held for a second time by King John (1211-1215), by Llewelyn the Great (1216-1223), and the Despensers (c. 1323-1326). In 1208 the Welsh and English inhabitants who had frequent cause to complain of their treatment, received each a charter, in similar terms, from King John, who also visited the town of Swansea in 1210 and in 1215 granted its merchants liberal privileges. In 1283 a number of de Braose's tenants— unquestionably Welshmen—left Gower for the royal lordship of Carmarthen, declaring that they would live under the king rather than under a lord marcher. In the following year the king visited de Braose at Oystermouth Castle, which seems to have been made the lord's chief residence, after the destruction of Swansea Castle by Llewelyn. Later on the king's officers of the newly organized county of Carmarthen repeatedly claimed jurisdiction over Gower, thereby endeavouring to reduce its status from that of a lordship marcher with semi-regal jurisdiction, into that of an ordinary constituent of the new county. De Braose resisted the claim and organized the English part of his lordship on the lines of a county palatine, with its own *comitatus* and chancery held in Swansea Castle, the sheriff and chancellor being appointed by himself. The inhabitants, who had no right of appeal to the crown against their lord or the decisions of his court, petitioned the king, who in 1305 appointed a special commission to enquire into their alleged grievances, but in the following year the de Braose of the time, probably in alarm, conceded liberal privileges both to the burgesses of Swansea and to the English and Welsh inhabitants of his "county" of English Gower. He was the last lord seignior to live within the seigniorly, which passed from him to his son-in-law John de Mowbray. Other troubles befell the de Braose barons and their successors in title, for their right to the lordship was contested by the Beauchamps, representatives of the earlier earls of Warwick, in prolonged litigation carried on intermittently from 1278 to 1306, the Beauchamps being actually in possession from 1354, when a decision was given in their favour, till its reversal in 1396. It then reverted to the Mowbrays and was held by them until the 4th duke of

Norfolk exchanged it in 1489, for lands in England, with William Herbert, earl of Pembroke. The latter's granddaughter brought it to her husband Charles Somerset, who in 1506 was granted her father's subtitle of Baron Herbert of Chepstow, Raglan and Gower, and from him the lordship has descended to the present lord, the duke of Beaufort.

Gower was made subject to the ordinary law of England by its inclusion in 1535 in the county of Glamorgan as then reorganized; its chancery, which from about the beginning of the 14th century had been located at Oystermouth Castle, came to an end, but though the Welsh acts of 1535 and 1542 purported to abolish the rights and privileges of the lords marchers as conquerors, yet some of these, possibly from being regarded as private rights, have survived into modern times. For instance, the seignior maintained a franchise gaol in Swansea Castle till 1858, when it was abolished by act of parliament, the appointment of coroner for Gower is still vested in him, all writs are executed by the lord's officers instead of by the officers of the sheriff for the county, and the lord's rights to the foreshore, treasure trove, felon's goods and wrecks are undiminished.

The characteristically English part of Gower lies to the south and south-west of its central ridge of Cefn y Bryn. It was this part that was declared by Professor Freeman to be "more Teutonic than Kent itself." The seaside fringe lying between this area and the town of Swansea, as well as the extreme north-west of the peninsula, also became anglicized at a comparatively early date, though the place-names and the names of the inhabitants are still mainly Welsh. The present line of demarcation between the two languages is one drawn from Swansea in a W.N.W. direction to Llanrhidian on the north coast. It has remained practically the same for several centuries, and is likely to continue so, as it very nearly coincides with the southern outcrop of the coal measures, the industrial population to the north being Welsh-speaking, the agriculturists to the south being English. In 1901 the Gower rural district (which includes the Welsh-speaking industrial parish of Llanrhidian, with about three-sevenths of the total population) had 64.5% of the population above three years of age that spoke English only, 5.2% that spoke Welsh only, the remainder being bilinguals, as compared with 17% speaking English only, 17.7% speaking Welsh only and the rest bilinguals in the Swansea rural district, and 7% speaking English only, 55.2% speaking Welsh only and the rest bilinguals in the Pontardawe rural district, the last two districts constituting Welsh Gower.

More than one-fourth of the whole area of Gower is unenclosed common land, of which in English Gower fully one-half is apparently capable of cultivation. Besides the demesne manors of the lord seignior, six in number, there are some twelve mesne manors and fees belonging to the Penrice estate, and nearly twenty more belonging to various other owners. The tenure is customary freehold, though in some cases described as copyhold, and in the ecclesiastical manor of Bishopston, descent is by borough English. The holdings are on the whole probably smaller in size than in any other area of corresponding extent in Wales, and agriculture is still in a backward state.

In the Arthurian romances Gower appears in the form of Goire as the island home of the dead, a view which probably sprang up among the Celts of Cornwall, to whom the peninsula would appear as an island. It is also surmised by Sir John Rhys that Malory's Brandegore (*i.e.* Brin of Gower) represents the Celtic god of the other world (Rhys, *Arthurian Legend*, 160, 329 et seq.). On Cefn Bryn, almost in the centre of the peninsula, is a cromlech with a large capstone known as Arthur's Stone. The unusually large number of cairns on this hill, given as eighty by Sir Gardner Wilkinson, suggests that this part of Gower was a favourite burial-place in early British times.

See Rev. J. D. Davies, *A History of West Gower* (4 vols., 1877-1894); Col. W. Ll. Morgan, *An Antiquarian Survey of East Gower* (1899); an article (probably by Professor Freeman) entitled "Anglia Trans-Walliana" in the *Saturday Review* for May 20, 1876; "The Signory of Gower" by G. T. Clark in *Archaeologia Cambrensis* for 1893-1894; *The Surveys of Gower and Kidney*, ed. by Baker and Grant-Francis (1861-1870). (D. Ll. T.)

GOWN, properly the term for a loose outer garment formerly worn by either sex but now generally for that worn by women. While "dress" is the usual English word, except in such combinations as "tea-gown," "dressing-gown" and the like, where the original loose flowing nature of the "gown" is referred to, "gown" is the common American word. "Gown" comes from the O. Fr. *gowna* or *gowne*. The word appears in various Romanic languages, cf. Ital. *gonna*. The medieval Lat. *gowna* is used of a garment of skin or fur. A Celtic origin has been usually adopted, but the Irish, Gaelic and Manx words are taken from the English. Outside the ordinary use of the word, "gown" is the name for the distinctive robes worn by holders of particular offices or by members of particular professions or of universities, &c. (see *ROSES*).

GOWRIE, JOHN RUTHVEN, 3RD EARL OF (c. 1577-1600), Scottish conspirator, was the second son of William, 4th Lord Ruthven and 1st earl of Gowrie (cr. 1581), by his wife Dorothea, daughter of Henry Stewart, 2nd Lord Methven. The Ruthven family was of ancient Scottish descent, and had owned extensive estates in the time of William the Lion; the Ruthven peerage dated from the year 1488. The 1st earl of Gowrie (? 1541-1584), and his father, Patrick, 3rd Lord Ruthven (c. 1520-1566), had both been concerned in the murder of Rizzio in 1566; and both took an active part on the side of the Kirk in the constant intrigues and factions among the Scottish nobility of the period. The former had been the custodian of Mary, queen of Scots, during her imprisonment in Loch Leven, where, according to the queen, he had pestered her with amorous attentions; he had also been the chief actor in the plot known as the "raid of Ruthven" when King James VI. was treacherously seized while a guest at the castle of Ruthven in 1582, and kept under restraint for several months while the earl remained at the head of the government. Though pardoned for this conspiracy he continued to plot against the king in conjunction with the earls of Mar and Angus, and he was executed for high treason on the 2nd of May 1584; his friends complaining that the confession on which he was convicted of treason was obtained by a promise of pardon from the king. His eldest son, William, 2nd earl of Gowrie, only survived till 1588, the family dignities and estates, which had been forfeited, having been restored to him in 1586.

When, therefore, John Ruthven succeeded to the earldom while still a child, he inherited along with his vast estates family traditions of treason and intrigue. There was also a popular belief, though without foundation, that there was Tudor blood in his veins; and Burnet afterwards asserted that Gowrie stood next in succession to the crown of England after King James VI. Like his father and grandfather before him, the young earl attached himself to the party of the reforming preachers, who procured his election in 1592 as provost of Perth, a post that was almost hereditary in the Ruthven family. He received an excellent education at the grammar school of Perth and the university of Edinburgh, where he was in the summer of 1593, about the time when his mother, and his sister the countess of Atholl, aided Bothwell in forcing himself sword in hand into the king's bedchamber in Holyrood Palace. A few months later Gowrie joined with Atholl and Montröse in offering to serve Queen Elizabeth, then almost openly hostile to the Scottish king; and it is probable that he had also relations with the rebellious Bothwell. Gowrie had thus been already deeply engaged in treasonable conspiracy when, in August 1594, he proceeded to Italy with his tutor, William Rhynd, to study at the university of Padua. On his way home in 1599 he remained for some months at Geneva with the reformer Theodore Beza; and at Paris he made acquaintance with the English ambassador, who reported him to Cecil as devoted to Elizabeth's service, and a nobleman "of whom there may be exceeding use made." In Paris he may also at this time have had further communication with the exiled Bothwell; in London he was received with marked favour by Queen Elizabeth and her ministers.

These circumstances owe their importance to the light they throw on the obscurity of the celebrated "Gowrie conspiracy,"

which resulted in the slaughter of the earl and his brother by attendants of King James at Gowrie House, Perth, a few weeks after Gowrie's return to Scotland in May 1600. This event ranks among the unsolved enigmas of history.

The mystery is caused by the improbabilities inherent in any of the alternative hypotheses suggested to account for the unquestionable facts of the occurrence; the discrepancies in the evidence produced at the time; the apparent lack of forethought or plan on the part of the chief actors, whichever hypothesis be adopted, as well as the thoughtless folly of their actual procedure; and the insufficiency of motive, whoever the guilty parties may have been. The solutions of the mystery that have been suggested are three in number: first, that Gowrie and his brother had concocted a plot to murder, or more probably to kidnap King James, and that they lured him to Gowrie House for this purpose; secondly, that James paid a surprise visit to Gowrie House with the intention, which he carried out, of slaughtering the two Ruthvens; and thirdly, that the tragedy was the outcome of an unpremeditated brawl following high words between the king and the earl, or his brother. To understand the relative probabilities of these hypotheses regard must be had to the condition of Scotland in the year 1600 (see *SCOTLAND: History*). Here it can only be recalled that plots to capture the person of the sovereign for the purpose of coercing his actions were of frequent occurrence, more than one of which had been successful, and in several of which the Ruthven family had themselves taken an active part; that the relations between England and Scotland were at this time more than usually strained, and that the young earl of Gowrie was reckoned in London among the adherents of Elizabeth; that the Kirk party, being at variance with James, looked upon Gowrie as an hereditary partisan of their cause, and had recently sent an agent to Paris to recall him to Scotland as their leader; that Gowrie was believed to be James's rival for the succession to the English crown. Moreover, as regards the question of motive it is to be observed, on the one hand, that the Ruthvens believed Gowrie's father to have been treacherously done to death, and his widow insulted by the king's favourite minister; while, on the other, James was indebted in a large sum of money to the earl of Gowrie's estate, and popular gossip credited either Gowrie or his brother, Alexander Ruthven, with being the lover of the queen. Although the evidence on these points, and on every minute circumstance connected with the tragedy itself, has been exhaustively examined by historians of the Gowrie conspiracy, it cannot be asserted that the mystery has been entirely dispelled; but, while it is improbable that complete certainty will ever be arrived at as to whether the guilt lay with James or with the Ruthven brothers, the most modern research in the light of materials inaccessible or overlooked till the 20th century, points pretty clearly to the conclusion that there was a genuine conspiracy by Gowrie and his brother to kidnap the king. If this be the true solution, it follows that King James was innocent of the blood of the Ruthvens; and it raises the presumption that his own account of the occurrence was, in spite of the glaring improbabilities which it involved, substantially true.

The facts as related by James and other witnesses were, in outline, as follows. On the 5th of August 1600 the king rose early to hunt in the neighbourhood of Falkland Palace, about 14 m. from Perth. Just as he was setting forth in company with the duke of Lennox, the earl of Mar, Sir Thomas Erskine and others, he was accosted by Alexander Ruthven (known as the master of Ruthven), a younger brother of the earl of Gowrie, who had ridden from Perth that morning to inform the king that he had met on the previous day a man in possession of a pitcher full of foreign gold coins, whom he had secretly locked up in a room at Gowrie House. Ruthven urged the king to ride to Perth to examine this man for himself and to take possession of the treasure. After some hesitation James gave credit to the story, suspecting that the possessor of the coins was one of the numerous Catholic agents at that time moving about Scotland in disguise. Without giving a positive reply to

The
Gowrie
conspiracy.

Alexander Ruthven, James started to hunt; but later in the morning he called Ruthven to him and said he would ride to Perth when the hunting was over. Ruthven then despatched a servant, Henderson, by whom he had been accompanied from Perth in the early morning, to tell Gowrie that the king was coming to Gowrie House. This messenger gave the information to Gowrie about ten o'clock in the morning. Meanwhile Alexander Ruthven was urging the king to lose no time, requesting him to keep the matter secret from his courtiers, and to bring to Gowrie House as small a retinue as possible. James, with a train of some fifteen persons, arrived at Gowrie House about one o'clock, Alexander Ruthven having spurred forward for a mile or so to announce the king's approach. But notwithstanding Henderson's warning some three hours earlier, Gowrie had made no preparations for the king's entertainment, thus giving the impression of having been taken by surprise. After a meagre repast, for which he was kept waiting an hour, James, forbidding his retainers to follow him, went with Alexander Ruthven up the main staircase and passed through two chambers and two doors, both of which Ruthven locked behind them, into a turret-room at the angle of the house, with windows looking on the courtyard and the street. Here James expected to find the mysterious prisoner with the foreign gold. He found instead an armed man, who, as appeared later, was none other than Gowrie's servant, Henderson. Alexander Ruthven immediately put on his hat, and drawing Henderson's dagger, presented it to the king's breast with threats of instant death if James opened a window or called for help. An allusion by Ruthven to the execution of his father, the 1st earl of Gowrie, drew from James a reproof of Ruthven's ingratitude for various benefits conferred on his family. Ruthven then uncovered his head, declaring that James's life should be safe if he remained quiet; then, committing the king to the custody of Henderson, he left the turret—ostensibly to consult Gowrie—and locked the door behind him. While Ruthven was absent the king questioned Henderson, who professed ignorance of any plot and of the purpose for which he had been placed in the turret; he also at James's request opened one of the windows, and was about to open the other when Ruthven returned. Whether or not Alexander had seen his brother is uncertain. But Gowrie had meantime spread the report below that the king had taken horse and had ridden away; and the royal retinue were seeking their horses to follow him. Alexander, on re-entering the turret, attempted to bind James's hands; a struggle ensued, in the course of which the king was seen at the window by some of his followers below in the street, who also heard him cry "treason" and call for help to the earl of Mar. Gowrie affected not to hear these cries, but kept asking what was the matter. Lennox, Mar and most of the other lords and gentlemen ran up the main staircase to the king's help, but were stopped by the locked door, which they spent some time in trying to batter down. John Ramsay (afterwards earl of Holderness), noticing a small dark stairway leading directly to the inner chamber adjoining the turret, ran up it and found the king struggling at grips with Ruthven. Drawing his dagger, Ramsay wounded Ruthven, who was then pushed down the stairway by the king. Sir Thomas Erskine, summoned by Ramsay, now followed up the small stairs with Dr Hugh Herries, and these two coming upon the wounded Ruthven despatched him with their swords. Gowrie, entering the courtyard with his stabler Thomas Cranstoun and seeing his brother's body, rushed up the staircase after Erskine and Herries, followed by Cranstoun and others of his retainers; and in the mêlée Gowrie was killed. Some commotion was caused in the town by the noise of these proceedings; but it quickly subsided, though the king did not deem it safe to return to Falkland for some hours.

The tragedy caused intense excitement throughout Scotland, and the investigation of the circumstances was followed with much interest in England also, where all the details were reported to Elizabeth's ministers. The preachers of the Kirk, whose influence in Scotland was too extensive for the king to neglect,

were only with the greatest difficulty persuaded to accept James's account of the occurrence, although he voluntarily submitted himself to cross-examination by one of their number. Their belief, and that of their partisans, influenced no doubt by political hostility to James, was that the king had invented the story of a conspiracy by Gowrie to cover his own design to extirpate the Ruthven family. James gave some colour to this belief, which has not been entirely abandoned, by the relentless severity with which he pursued the two younger, and unquestionably innocent, brothers of the earl. Great efforts were made by the government to prove the complicity of others in the plot. One noted and dissolute conspirator, Sir Robert Logan of Restalrig, was posthumously convicted of having been privy to the Gowrie conspiracy on the evidence of certain letters produced by a notary, George Sprot, who swore they had been written by Logan to Gowrie and others. These letters, which are still in existence, were in fact forged by Sprot in imitation of Logan's handwriting; but the researches of Andrew Lang have shown cause for suspecting that the most important of them was either copied by Sprot from a genuine original by Logan, or that it embodied the substance of such a letter. If this be correct, it would appear that the conveyance of the king to Fast Castle, Logan's impregnable fortress on the coast of Berwickshire, was part of the plot; and it supplies, at all events, an additional piece of evidence to prove the genuineness of the Gowrie conspiracy.

Gowrie's two younger brothers, William and Patrick Ruthven, fled to England; and after the accession of James to the English throne William escaped abroad, but Patrick was taken and imprisoned for nineteen years in the Tower of London. Released in 1622, Patrick Ruthven resided first at Cambridge and afterwards in Somersetshire, being granted a small pension by the crown. He married Elizabeth Woodford, widow of the 1st Lord Gerrard, by whom he had two sons and a daughter, Mary; the latter entered the service of Queen Henrietta Maria, and married the famous painter van Dyck, who painted several portraits of her. Patrick died in poverty in a cell in the King's Bench in 1652, being buried as "Lord Ruthven." His son, Patrick, presented a petition to Oliver Cromwell in 1656, in which, after reciting that the parliament of Scotland in 1641 had restored his father to the barony of Ruthven, he prayed that his "extreme poverty" might be relieved by the bounty of the Protector.

See Andrew Lang, *James VI. and the Gowrie Mystery* (London, 1902), and the authorities there cited: Robert Picairn, *Criminal Trials in Scotland* (3 vols., Edinburgh, 1833); David Moysie, *Memoirs of the Affairs of Scotland, 1577-1603* (Edinburgh, 1836); Louis A. Barbé, *The Tragedy of Gowrie House* (London, 1887); Andrew Bisset, *Essays on Historical Truth* (London, 1871); David Calderwood, *History of the Kirk of Scotland* (8 vols., Edinburgh, 1842-1849); P. F. Tytler, *History of Scotland* (9 vols., Edinburgh, 1828-1843); John Hill Burton, *History of Scotland* (7 vols., Edinburgh, 1867-1870). W. A. Craigie has edited as *Skottlands Rimur* some Icelandic ballads relating to the Gowrie conspiracy. He has also printed the Danish translation of the official account of the conspiracy, which was published at Copenhagen in 1601. (R. J. M.)

GOWRIE, a belt of fertile alluvial land (*Scottic*, "carse") of Perthshire, Scotland. Occupying the northern shore of the Firth of Tay, it has a generally north-easterly trend and extends from the eastern boundaries of Perth city to the confines of Dundee. It measures 15 m. in length, its breadth from the river towards the base of the Sidlaw Hills varying from 2 to 4 m. Probably it is a raised beach, submerged until a comparatively recent period. Although it contained much bog land and stagnant water as late as the 18th century, it has since been drained and cultivated, and is now one of the most productive tracts in Perthshire. The district is noteworthy for the number of its castles and mansions, almost wholly independent, among which may be mentioned Kinfauns Castle, Inchyra House, Pitfour Castle, Errol Park, Megginch Castle, dating from 1575; Fingask Castle, Kinnaird Castle, erected in the 15th century and occupied by James VI. in 1617; Rossie Priory, the seat of Lord Kinnaird; and Huntly Castle, built by the 3rd earl of Kinghorne.

GOYA, a river town and port of Corrientes, Argentine Republic, the commercial centre of the south-western departments of the province and chief town of a department of the same name, on a *riacho* or side channel of the Paraná about 5 m. from the main channel and about 120 m. S. of the city of Corrientes. Pop. (1905, est.) 7000. The town is built on low ground which is subject to inundations in very wet weather, but its streets are broad and the general appearance of its edifices is good. Among its public buildings is a handsome parish church and a national normal school. The productions of the neighbourhood are chiefly pastoral, and its exports include cattle, hides, wool and oranges. Goya had an export of crudely-made cheese long before the modern cheese factories of the Argentine Republic came into existence. The place dates from 1807, and had its origin, it is said, in the trade established there by a ship captain and his wife Gregoria or Goyana, who supplied passing vessels with beef.

GOYANNA, or **GOIANA**, a city of Brazil in the N.E. angle of the state of Pernambuco, about 65 m. N. of the city of Pernambuco. Pop. (1890) 15,436. It is built on a fertile plain between the rivers Tracunhaem and Capibaribe-mirim near their junction to form the Goyanna river, and is 15 m. from the coast. It is surrounded by, and is the commercial centre for, one of the richest agricultural districts of the state, which produces sugar, rum, coffee, tobacco, cotton, cattle, hides and castor oil. The Goyanna river is navigable for small vessels nearly up to the city, but its entrance is partly obstructed and difficult. Goyanna is one of the oldest towns of the state, and was occupied by the Dutch from 1636 to 1654. It has several old-style churches, an orphans' asylum, hospital and some small industries.

GOYA Y LUCIENTES, FRANCISCO (1746-1828), Spanish painter, was born in 1746 at Fuendetodos, a small Aragonese village near Saragossa. At an early age he commenced his artistic career under the direction of José Luzan Martínez, who had studied painting at Naples under Mastroleo. It is clear that the accuracy in drawing Luzan is said to have acquired by diligent study of the best Italian masters did not much influence his erratic pupil. Goya, a true son of his province, was bold, capricious, headstrong and obstinate. He took a prominent part on more than one occasion in those rival religious processions at Saragossa which often ended in unseemly frays; and his friends were led in consequence to despatch him in his nineteenth year to Madrid, where, prior to his departure for Rome, his mode of life appears to have been anything but that of a quiet orderly citizen. Being a good musician, and gifted with a voice, he sallied forth nightly, serenading the caged beauties of the capital, with whom he seems to have been a very general favourite.

Lacking the necessary royal patronage, and probably scandalized by his mode of life the sedate court officials, he did not receive—perhaps did not seek—the usual honorarium accorded to those students who visited Rome for the purpose of study. Finding in convenient to retire for a time from Madrid, he decided to visit Rome at his own cost; and being without resources he joined a "quadrilla" of bull-fighters, passing from town to town until he reached the shores of the Mediterranean. We next hear of him reaching Rome, broken in health and financially bankrupt. In 1772 he was awarded the second prize in a competition initiated by the academy of Parma, styling himself "pupil to Bayeu, painter to the king of Spain." Compelled to quit Rome somewhat suddenly, he appears again in Madrid in 1775: the husband of Bayeu's daughter, and father of a son. About this time he appears to have visited his parents at Fuendetodos, no doubt noting much which later on he utilized in his genre works. On returning to Madrid he commenced painting canvases for the tapestry factory of Santa Barbara, in which the king took much interest. Between 1776 and 1780 he appears to have supplied thirty examples, receiving about £1200 for them. Soon after the revolution of 1808, an official was appointed to take an inventory of all works of art belonging to the nation, and in one of the cellars of the Madrid palace were discovered forty-three of these works of Goya on rolls forgotten and neglected (see *Los Tapices de Goya; por Cruzado Villuamín*, Madrid, 1870).

His originality and talent were soon recognized by Mengs,

the king's painter, and royal favour naturally followed. His career now becomes intimately connected with the court life of his time. He was commissioned by the king to design a series of frescoes for the church of St. Anthony of Florida, Madrid, and he also produced works for Saragossa, Valencia and Toledo. Ecclesiastical art was not his forte, and although he cannot be said to have failed in any of his work, his fame was not enhanced by his religious subjects.

In portraiture, without doubt, Goya excelled: his portraits are evidently life-like and unexaggerated, and he disdained flattery. He worked rapidly, and during his long stay at Madrid painted, amongst many others, the portraits of four sovereigns of Spain—Charles III. and IV., Ferdinand VII. and "King Joseph." The duke of Wellington also sat to him; but on his making some remark which raised the artist's cholera, Goya seized a plaster cast and hurled it at the head of the duke. There are extant two pencil sketches of Wellington, one in the British Museum, the other in a private collection. One of his best portraits is that of the lovely Andalusian duchess of Alva. He now became the spoiled child of fortune, and acquired, at any rate externally, much of the polish of court manners. He still worked industriously upon his own lines, and, while there is a stiffness almost ungainly in the pose of some of his portraits, the stern individuality is always preserved.

Including the designs for tapestry, Goya's genre works are numerous and varied, both in style and feeling, from his Watteau-like "Al Fresco Breakfast," "Romeria de San Isidro," to the "Curate feeding the Devil's Lamp," the "Meson del Gallo" and the painfully realistic massacre of the "Dos de Mayo" (1808). Goya's versatility is proverbial; in his hands the pencil, brush and graver are equally powerful. Some of his crayon sketches of scenes in the bull ring are full of force and character, slight but full of meaning. He was in his thirty-second year when he commenced his etchings from Velasquez, whose influence may, however, be traced in his work at an earlier date. A careful examination of some of the drawings made for these etchings indicates a steadiness of purpose not usually discovered in Goya's craft as draughtsman. He is much more widely known by his etchings than his oils; the latter necessarily must be sought in public and private collections, principally in Spain, while the former are known and prized in every capital of Europe. The etched collections by which Goya is best known include "Los Caprichos," which have a satirical meaning known only to the few; they are bold, weird and full of force. "Los Proverbios" are also supposed to have some hidden intention. "Los Desastres de la Guerra" may fairly claim to depict Spain during the French invasion. In the bull-fight series Goya is evidently at home; he was a skilled master of the barbarous art, and no doubt every sketch is true to nature, and from life.

Goya retired from Madrid, desiring probably during his latter years to escape the trying climate of that capital. He died at Bordeaux on the 16th of April 1828, and a monument has been erected there over his remains. From the deaths of Velasquez and Murillo to the advent of Fortuny, Goya's name is the only important one found in the history of Spanish art.

See also the lives by Paul Lefort (1877), and Yriarte (1867).

GOYÁZ, an inland state of Brazil, bounded by Matto Grosso and Pará on the W., Maranhão, Bahia and Minas Geraes on the E., and Minas Geraes and Matto Grosso on the S. Pop. (1890) 227,572; (1900) 255,284, including many half-civilized Indians and many half-breeds. Area, 288,549 sq. m. The outline of the state is that of a roughly-shaped wedge with the thin edge extending northward between and up to the junction of the rivers Araguaya and Upper Tocantins, and its length is nearly 15° of latitude. The state lies wholly within the great Brazilian plateau region, but its surface is much broken towards the N. by the deeply eroded valleys of the Araguaya and Upper Tocantins rivers and their tributaries. The general slope of the plateau is toward the N., and the drainage of the state is chiefly through the above-named rivers—the principal tributaries of the Araguaya being the Grande and Vermelho, and of the Upper Tocantins, the Manoel Alves Grande, Somao, Paranã

and Maranhão. A considerable part of southern Goyás, however, slopes southward and the drainage is through numerous small streams flowing into the Paranahyba, a large tributary of the Paraná. The general elevation of the plateau is estimated to be about 2700 ft., and the highest elevation was reported in 1892 to be the Serra dos Pyreneos (5250 ft.). Crossing the state N.N.E. to S.S.W. there is a well-defined chain of mountains, of which the Pyreneos, Santa Rita and Santa Martha ranges form parts, but their elevation above the plateau is not great. The surface of the plateau is generally open campo and scrubby arboreal growth called *caatingas*, but the streams are generally bordered with forest, especially in the deeper valleys. Towards the N. the forest becomes denser and of the character of the Amazon Valley. The climate of the plateau is usually described as temperate, but it is essentially sub-tropical. The valley regions are tropical, and malarial fevers are common. The cultivation of the soil is limited to local needs, except in the production of tobacco, which is exported to neighbouring states. The open campos afford good pasturage, and live stock is largely exported. Gold-mining has been carried on in a primitive manner for more than two centuries, but the output has never been large and no very rich mines have been discovered. Diamonds have been found, but only to a very limited extent. There is a considerable export of quartz crystal, commercially known as "Brazilian pebbles," used in optical work. Although the northern and southern extremities of Goyás lie within two great river systems—the Tocantins and Paraná—the upper courses of which are navigable, both of them are obstructed by falls. The only outlet for the state has been by means of mule trains to the railway termini of São Paulo and Minas Geraes, pending the extension of railways from both of those states, one entering Goyás by way of Catalão, near the southern boundary, and the other at some point further N.

The capital of the state is Goyás, or Villa-Boa de Goyás, a mining town on the Rio Vermelho, a tributary of the Araguaya rising on the northern slopes of the Serra de Santa Rita. Pop. (1890) 6807. Gold was discovered here in 1682 by Bartholomew Bueno, the first European explorer of this region, and the settlement founded by him was called Santa Anna, which is still the name of the parish. The site of the town is a barren, rocky mountain valley, 1900 ft. above sea-level, in which the heat is most oppressive at times and the nights are unpleasantly cold. Goyás is the see of a bishopric founded in 1826, and possesses a small cathedral and some churches.

GOYEM, JAN JOSEPHSZOON VAN (1596-1656), Dutch painter, was born at Leiden on the 13th of January 1596, learned painting under several masters at Leiden and Haarlem, married in 1618 and settled at the Hague about 1631. He was one of the first to emancipate himself from the traditions of minute imitation embodied in the works of Breughel and Savery. Though he preserved the dun scale of tone peculiar to those painters, he studied atmospheric effects in black and white with considerable skill. He had much influence on Dutch art. He formed Solomon Ruysdael and Pieter Potter, forced attention from Rembrandt, and bequeathed some of his precepts to Pieter de Molyne, Coelenbier, Saffleven, van der Kabel and even Berghem. His life at the Hague for twenty-five years was very prosperous, and he rose in 1640 to be president of his guild. A friend of van Dyck and Bartholomew van der Helst, he sat to both these artists for his likeness. His daughter Margaret married Jan Steen, and he had steady patrons in the stadtholder Frederick Henry, and the chiefs of the municipality of the Hague. He died at the Hague in 1656, possessed of land and houses to the amount of 15,000 florins.

Between 1610 and 1616 van Goyen wandered from one school to the other. He was first apprenticed to Isaak Swanenburgh; he then passed through the workshops of de Man, Klok and de Hoorn. In 1616 he took a decisive step and joined Esaias van der Velde at Haarlem; amongst his earlier pictures, some of 1621 (Berlin Museum) and 1623 (Brunswick Gallery) show the influence of Esaias very perceptibly. The landscape is minute. Details of branching and foliage are given, and the

figures are important in relation to the distances. After 1625 these peculiarities gradually disappear. Atmospheric effect in landscapes of cool tints varying from grey green to pearl or brown and yellow dun is the principal object which van Goyen holds in view, and he succeeds admirably in light skies with drifting misty cloud, and downs with cottages and scanty shrubbery or stunted trees. Neglecting all detail of foliage he now works in a thin diluted medium, laying on rubbings as of sepia or Indian ink, and finishing without loss of transparency or lucidity. Throwing his foreground into darkness, he casts alternate light and shade upon the more distant planes, and realizes most pleasing views of large expanse. In buildings and water, with shipping near the banks, he sometimes has the strength if not the colour of Albert Cuyp. The defect of his work is chiefly want of solidity. But even this had its charm for van Goyen's contemporaries, and some time elapsed before Cuyp, who imitated him, restricted his method of transparent tinting to the foliage of foreground trees.

Van Goyen's pictures are comparatively rare in English collections, but his work is seen to advantage abroad, and chiefly at the Louvre, and in Berlin, Gotha, Vienna, Munich and Augsburg. Twenty-eight of his works were exhibited together at Vienna in 1873. Though he visited France once or twice, van Goyen chiefly confined himself to the scenery of Holland and the Rhine. Nine times from 1633 to 1655 he painted views of Dordrecht. Nimeguen was one of his favourite resorts. But he was also fond of Haarlem and Amsterdam, and he did not neglect Arnheim or Utrecht. One of his largest pieces is a view of the Hague, executed in 1651 for the municipality, and now in the town collection of that city. Most of his panels represent reaches of the Rhine, the Waal and the Maese. But he sometimes sketched the downs of Scheveningen, or the sea at the mouth of the Rhine and Scheldt; and he liked to depict the calm inshore, and rarely ventured upon seas stirred by more than a curling breeze or the swell of a coming squall. He often painted winter scenes, with ice and skaters and sledges, in the style familiar to Isaac van Ostade. There are numerous varieties of these subjects in the master's works from 1621 to 1653. One historical picture has been assigned to van Goyen—the "Embarkation of Charles II." in the Bute collection. But this canvas was executed after van Goyen's death. When he tried this form of art he properly mistrusted his own powers. But he produced little in partnership with his contemporaries, and we can only except the "Watering-place" in the gallery of Vienna, where the landscape is enlivened with horses and cattle by Philip Wouwermans. Even Jan Steen, who was his son-in-law, only painted figures for one of his pictures, and it is probable that this piece was completed after van Goyen's death. More than 250 of van Goyen's pictures are known and accessible. Of this number little more than 70 are undated. None exist without the full name or monogram, and yet there is no painter whose hand it is easier to trace without the help of these adjuncts. An etcher, but a poor one, van Goyen has only bequeathed to us two very rare plates.

GOZLAN, LÉON (1806-1866), French novelist and playwright, was born on the 1st of September 1806, at Marseilles. When he was still a boy, his father, who had made a large fortune as a ship-broker, met with a series of misfortunes, and Léon, before completing his education, had to go to sea in order to earn a living. In 1828 we find him in Paris, determined to run the risks of literary life. His townsman, Joseph Méry, who was then making himself famous by his political satires, introduced him to several newspapers, and Gozlan's brilliant articles in the *Figaro* did much harm to the already tottering government of Charles X. His first novel was *Les Mémoires d'un apothicaire* (1828), and this was followed by numberless others, among which may be mentioned *Washington Levert et Socrate Leblanc* (1838), *Le Notaire de Chantilly* (1836), *Aristide Froissart* (1843) (one of the most curious and celebrated of his productions), *Les Nuits du Père Lechaize* (1846), *Le Tapis vert* (1855), *La Folle du logis* (1857), *Les Émotions de Polydore Marasquin* (1857), &c. His best-known works for the theatre are—

La Pluie et le beau temps (1861), and *Une Tempête dans un verre d'eau* (1850), two curtain-raisers which have kept the stage; *Le Lion empaillé* (1848), *La Queue du chien d'Alcibiade* (1849), *Louise de Nanteuil* (1854), *Le Château des roines* (1855), *Les Papiers de la comtesse* (1852); and he adapted several of his own novels to the stage. Gozlan also wrote a romantic and picturesque description of the old manors and mansions of his country entitled *Les Châteaux de France* (2 vols., 1844), originally published (1836) as *Les Tournelles*, which has some archaeological value, and a biographical essay on Balzac (*Balzac chez lui*, 1862). He was made a member of the Legion of Honour in 1846, and in 1859 an officer of that order. Gozlan died on the 14th of September 1866, in Paris.

See also P. Audebrand, *Léon Gozlan* (1887).

GOZO (Gozzo), an island of the Maltese group in the Mediterranean Sea, second in size to Malta. It lies N.W. and 3½ m. from the nearest point of Malta, is of oval form, 8½ m. in length and 4½ m. in extreme breadth, and has an area of nearly 25 m. Its chief town, Victoria, formerly called Rabato (pop. in 1901, 5057) stands near the middle of the island on one of a cluster of steep conical hills, 3½ m. from the port of Migiarro Bay, on the south-east shore, below Fort Chambray. The character of the island is similar to that of Malta. The estimated population in 1907 was 21,911.

GOZZI, CARLO, COUNT (1722-1806), Italian dramatist, was descended from an old Venetian family, and was born at Venice in March 1722. Compelled by the embarrassed condition of his father's affairs to procure the means of self-support, he, at the age of sixteen, joined the army in Dalmatia; but three years afterwards he returned to Venice, where he soon made a reputation for himself as the wittiest member of the Granelleschi society, to which the publication of several satirical pieces had gained him admission. This society, nominally devoted to conviviality and wit, had also serious literary aims, and was especially zealous to preserve the Tuscan literature pure and untainted by foreign influences. The displacement of the old Italian comedy by the dramas of Pietro Chiari (1700-1788) and Goldoni, founded on French models, threatened defeat to all their efforts; and in 1757 Gozzi came to the rescue by publishing a satirical poem, *Tarlana degli infussi per l'anno bisestile*, and in 1761 by his comedy, *Fiaba dell'amore delle tre melarancie*, a parody of the manner of the two obnoxious poets, founded on a fairy tale. For its representation he obtained the services of the Sacchi company of players, who, on account of the popularity of the comedies of Chiari and Goldoni—which afforded no scope for the display of their peculiar talents—had been left without employment; and as their satirical powers were thus sharpened by personal enmity, the play met with extraordinary success. Struck by the effect produced on the audience by the introduction of the supernatural or mythical element, which he had merely used as a convenient medium for his satirical purposes, Gozzi now produced a series of dramatic pieces based on fairy tales, which for a period obtained great popularity, but after the breaking up of the Sacchi company were completely disregarded. They have, however, obtained high praise from Goethe, Schlegel, Madame de Staël and Sismondi; and one of them, *Re Turandote*, was translated by Schiller. In his later years Gozzi set himself to the production of tragedies in which the comic element was largely introduced; but as this innovation proved unacceptable to the critics he had recourse to the Spanish drama, from which he obtained models for various pieces, which, however, met with only equivocal success. He died on the 4th of April 1806.

His collected works were published under his own superintendence, at Venice, in 1792, in 10 volumes; and his dramatic works, translated into German by Werthes, were published at Bern in 1795. See Gozzi's work, *Memoria inutili della vita di Carlo Gozzi* (3 vols., Venice, 1797), translated into French by Paul de Musset (1848), and into English by J. A. Symonds (1889); F. Horn, *Über Gozzis dramatische Poesie* (Venice, 1803); Gherardini, *Vita di Gasp. Gozzi* (1821); "Charles Gozzi," by Paul de Musset, in the *Revue des deux mondes* for 15th November 1844; Magrini, *Carlo Gozzi e la fiaba: saggi storici, biografici, e critici* (Cremona, 1876), and the same author's book on Gozzi's life and times (Benevento, 1883).

XL. 6

GOZZI, GASPARO, COUNT (1713-1786), eldest brother of Carlo Gozzi, was born on the 4th of December 1713. In 1739 he married the poetess Luise Bergalli, and she undertook the management of the theatre of Sant' Angelo, Venice, he supplying the performers with dramas chiefly translated from the French. The speculation proved unfortunate, but meantime he had attained a high reputation for his contributions to the *Gazzetta Veneta*, and he soon came to be known as one of the ablest critics and purest and most elegant stylists in Italy. For a considerable period he was censor of the press in Venice, and in 1774 he was appointed to reorganize the university system at Padua. He died at Padua on the 26th of December 1786.

His principal writings are *Osservatore Veneto periodico* (1761), on the model of the English *Spectator*, and distinguished by its high moral tone and its light and pleasant satire; *Lettere famigliari* (1755), a collection of short racy pieces in prose and verse, on subjects of general interest; *Sermoni*, poems in blank verse after the manner of Horace; *Il Mondo morale* (1760), a personification of human passions with inwoven dialogues in the style of Lucian; and *Giudizio degli antichi poeti sopra la moderna censura di Dante* (1755), a defence of the great poet against the attacks of Bettinelli. He also translated various works from the French and English, including Marmontel's *Tales* and Pope's *Essay on Criticism*. His collected works were published at Venice, 1794-1798, in 12 volumes, and several editions have appeared since.

GOZZOLI, BENOZZO, Italian painter, was born in Florence in 1424, or perhaps 1420, and in the early part of his career assisted Fra Angelico, whom he followed to Rome and worked with at Orvieto. In Rome he executed in Santa Maria in Aracoeli a fresco of "St Anthony and Two Angels." In 1449 he left Angelico, and went to Montefalco, near Foligno in Umbria. In S. Fortunato, near Montefalco, he painted a "Madonna and Child with Saints and Angels," and three other works. One of these, the altar-piece representing "St Thomas receiving the Girdle of the Virgin," is now in the Lateran Museum, and shows the affinity of Gozzoli's early style to Angelico's. He next painted in the monastery of S. Francesco, Montefalco, filling the choir with a triple course of subjects from the life of the saint, with various accessories, including heads of Dante, Petrarch and Giotto. This work was completed in 1452, and is still marked by the style of Angelico, crossed here and there with a more distinctly Giottesque influence. In the same church, in the chapel of St Jerome, is a fresco by Gozzoli of the Virgin and Saints, the Crucifixion and other subjects. He remained at Montefalco (with an interval at Viterbo) probably till 1456, employing Mesastris as assistant. Thence he went to Perugia, and painted in a church a "Virgin and Saints," now in the local academy, and soon afterwards to his native Florence, the headquarters of art. By the end of 1459 he had nearly finished his important labour in the chapel of the Palazzo Riccardi, the "Journey of the Magi to Bethlehem," and, in the tribune of this chapel, a composition of "Angels in a Paradise." His picture in the National Gallery, London, a "Virgin and Child with Saints," 1461, belongs also to the period of his Florentine sojourn. Another small picture in the same gallery, the "Rape of Helen," is of dubious authenticity. In 1464 Gozzoli left Florence for S. Gimignano, where he executed some extensive works; in the church of S. Agostino, a composition of St Sebastian protecting the City from the Plague of this same year, 1464; over the entire choir of the church, a triple course of scenes from the legends of St Augustine, from the time of his entering the school of Tegate on to his burial, seventeen chief subjects, with some accessories; in the Pieve di S. Gimignano, the "Martyrdom of Sebastian," and other subjects, and some further works in the city and its vicinity. Here his style combined something of Lippo Lippi with its original elements, and he received co-operation from Giusto d'Andrea. He stayed in this city till 1467, and then began, in the Campo Santo of Pisa, from 1469, the vast series of mural paintings with which his name is specially identified. There are twenty-four subjects from the Old Testament, from the "Invention of Wine by Noah" to the "Visit of the Queen of Sheba to Solomon." He contracted to paint three subjects per year for about ten ducats each—a sum which may be regarded as equivalent to

2a

£100 at the present day. It appears, however, that this contract was not strictly adhered to, for the actual rate of painting was only three pictures in two years. Perhaps the great multitude of figures and accessories was accepted as a set-off against the slower rate of production. By January 1470 he had executed the fresco of "Noah and his Family,"—followed by the "Curse of Ham," the "Building of the Tower of Babel" (which contains portraits of Cosmo de' Medici, the young Lorenzo Politian and others), the "Destruction of Sodom," the "Victory of Abraham," the "Marriages of Rebecca and of Rachel," the "Life of Moses," &c. In the Cappella Ammannati, facing a gate of the Campo Santo, he painted also an "Adoration of the Magi" wherein appears a portrait of himself. All this enormous mass of work, in which Gozzoli was probably assisted by Zanobi Macchiavelli, was performed, in addition to several other pictures during his stay in Pisa (we need only specify the "Glory of St Thomas Aquinas," now in the Louvre), in sixteen years, lasting up to 1485. This is the latest date which can with certainty be assigned to any work from his hand, although he is known to have been alive up to 1498. In 1478 the Pisan authorities had given him, as a token of their regard, a tomb in the Campo Santo. He had likewise a house of his own in Pisa, and houses and land in Florence. In rectitude of life he is said to have been worthy of his first master, Fra Angelico.

The art of Gozzoli does not rival that of his greatest contemporaries either in elevation or in strength, but is pre-eminently attractive by its sense of what is rich, winning, lively and abundant in the aspects of men and things. His landscapes, thronged with birds and quadrupeds, especially dogs, are more varied, circumstantial and alluring than those of any predecessor; his compositions are crowded with figures, more characteristically true when happily and gracefully occupied than when the demands of the subject require tragic or dramatic intensity, or turmoil of action; his colour is bright, vivacious and festive. Gozzoli's genius was, on the whole, more versatile and assimilative than vigorously original; his drawing not free from considerable imperfections, especially in the extremities and articulations, and in the perspective of his gorgeously-schemed buildings. In fresco-painting he used the methods of tempera, and the decay of his works has been severe in proportion. Of his untiring industry the recital of his labours and the number of works produced are the most forcible attestation.

Vasari, Crowe and Cavalcaelle, and the other ordinary authorities, can be consulted as to the career of Gozzoli. A separate life of him, by H. Stokes, was published in 1903 in *Newnes's Art Library*. (W. M. R.)

GRAAFF REINET, a town of South Africa, 185 m. by rail N.W. by N. of Port Elizabeth. Pop. (1904) 10,083, of whom 4055 were whites. The town lies 2463 ft. above the sea and is built on the banks of the Sunday river, which rises a little farther north on the southern slopes of the Sneeuwberg, and here ramifies into several channels. The Dutch church is a handsome stone building with seating accommodation for 1500 people. The college is an educational centre of some importance; it was rebuilt in 1906. Graaff Reinet is a flourishing market for agricultural produce, the district being noted for its mohair industry, its orchards and vineyards.

The town was founded by the Cape Dutch in 1786, being named after the then governor of Cape Colony, C. J. van de Graaff, and his wife. In 1795 the burghers, smarting under the exactions of the Dutch East India Company proclaimed a republic. Similar action was taken by the burghers of Swellendam. Before the authorities at Cape Town could take decisive measures against the rebels, they were themselves compelled to capitulate to the British. The burghers having endeavoured, unsuccessfully, to get aid from a French warship at Algoa Bay surrendered to Colonel (afterwards General Sir) J. O. Vandeleur. In January 1799 Marthinus Prinsloo, the leader of the republicans in 1795, again rebelled, but surrendered in April following. Prinsloo and nineteen others were imprisoned in Cape Town castle. After trial, Prinsloo and another commandant were sentenced to death and others to banishment. The sentences were not

carried out and the prisoners were released; March 1803, on the retrocession of the Cape to Holland. In 1801 there had been another revolt in Graaff Reinet, but owing to the conciliatory measures of General F. Dundas (acting governor of the Cape) peace was soon restored. It was this district, where a republican government in South Africa was first proclaimed, which furnished large numbers of the voortrekkers in 1835-1842. It remains a strong Dutch centre.

See J. C. Voight, *Fifty Years of the History of the Republic in South Africa 1795-1845*, vol. i. (London, 1899).

GRABBE, CHRISTIAN DIETRICH (1801-1836), German dramatist, was born at Detmold on the 11th of December 1801. Entering the university of Leipzig in 1819 as a student of law, he continued the reckless habits which he had begun at Detmold, and neglected his studies. Being introduced into literary circles, he conceived the idea of becoming an actor and wrote the drama *Herzog Theodor von Gothland* (1822). This, though showing considerable literary talent, lacks artistic form, and is morally repulsive. Ludwig Tieck, while encouraging the young author, pointed out its faults, and tried to reform Grabbe himself. In 1822 Grabbe removed to Berlin University, and in 1824 passed his advocate's examination. He now settled in his native town as a lawyer and in 1827 was appointed a *Militär-auditeur*. In 1833 he married, but in consequence of his drunken habits was dismissed from his office, and, separating from his wife, visited Düsseldorf, where he was kindly received by Karl Immermann. After a serious quarrel with the latter, he returned to Detmold, where, as a result of his excesses, he died on the 12th of September 1836.

Grabbe had real poetical gifts, and many of his dramas contain fine passages and a wealth of original ideas. They largely reflect his own life and character, and are characterized by cynicism and indelicacy. Their construction also is defective and little suited to the requirements of the stage. The boldly conceived *Don Juan und Faust* (1829) and the historical dramas *Friedrich Barbarossa* (1829), *Heinrich VI.* (1830), and *Napolcon oder die Hunder Tage* (1831), the last of which places the battle of Waterloo upon the stage, are his best works. Among others are the unfinished tragedies *Marius and Sulla* (continued by Erich Korn, Berlin, 1890); and *Hannibal* (1835, supplemented and edited by C. Spielmann, Halle, 1901); and the patriotic *Hermannsschlacht* or the battle between Arminius and Varus (posthumously published with a biographical notice, by E. Duller, 1838).

Grabbe's works have been edited by O. Blumenthal (4 vols., 1875), and E. Grisebach (4 vols., 1902). For further notices of his life, see K. Ziegler, *Grabbes Leben und Charakter* (1858); O. Blumenthal, *Beiträge zur Kenntnis Grabbes* (1875); C. A. Piper, *Grabbe* (1898), and A. Ploch, *Grabbes Stellung in der deutschen Literatur* (1905).

GRABE, JOHN ERNEST (1666-1711), Anglican divine, was born on the 10th of July 1666, at Königsberg, where his father, Martin Sylvester Grabe, was professor of theology and history. In his theological studies Grabe succeeded in persuading himself of the schismatical character of the Reformation, and accordingly he presented to the consistory of Samland in Prussia a memorial in which he compared the position of the evangelical Protestant churches with that of the Novatians and other ancient schismatics. He had resolved to join the Church of Rome when a commission of Lutheran divines pointed out flaws in his written argument and called his attention to the English Church as apparently possessing that apostolic succession and manifesting that fidelity to ancient institutions which he desired. He came to England, settled in Oxford, was ordained in 1700, and became chaplain of Christ Church. His inclination was towards the party of the nonjurors. The learned labours to which the remainder of his life was devoted were rewarded with an Oxford degree and a royal pension. He died on the 3rd of November 1711, and in 1726 a monument was erected to him by Edward Harley, earl of Oxford, in Westminster Abbey. He was buried in St Pancras Church, London.

Some account of Grabe's life is given in R. Nelson's *Life of George Bull*, and by George Hicetes in a discourse prefixed to the pamphlet against W. Whiston's *Collection of Testimonies against the True*

Deity of the Son and of the Holy Ghost. His works, which show him to have been learned and laborious but somewhat deficient in critical acumen, include a *Spicilegium SS. Patrum et hæreticorum* (1608-1609), which was designed to cover the first three centuries of the Christian church, but was not continued beyond the close of the second. A second edition of this work was published in 1714. He brought out an edition of Justin Martyr's *Apologia prima* (1700), of Irenæus, *Adversus omnes hæreses* (1702), of the Septuagint, and of Bishop Bull's Latin works (1703). His edition of the Septuagint was based on the *Codex Alexandrinus*; it appeared in 4 volumes (1707-1720), and was completed by Francis Lee and by George Wigan.

GRACCHUS, in ancient Rome, the name of a plebeian family of the Sempronian gens. Its most distinguished representatives were the famous tribunes of the people, Tiberius and Gaius Sempronius Gracchus, (4) and (5) below, usually called simply "the Gracchi."

1. **TIBERIUS SEMPRONIUS GRACCHUS**, consul in 238 B.C., carried on successful operations against the Ligurian mountaineers, and, at the conclusion of the Carthaginian mercenary war, was in command of the fleet which at the invitation of the insurgents took possession of the island of Sardinia.

2. **TIBERIUS SEMPRONIUS GRACCHUS**, probably the son of (1), distinguished himself during the second Punic war. Consul in 215, he defeated the Capuans who had entered into an alliance with Hannibal, and in 214 gained a signal success over Hanno near Beneventum, chiefly owing to the *volones* (slave-volunteers), to whom he had promised freedom in the event of victory. In 213 Gracchus was consul a second time and carried on the war in Lucania; in the following year, while advancing northward to reinforce the consuls in their attack on Capua, he was betrayed into the hands of the Carthaginian Mago by a Lucanian of rank, who had formerly supported the Roman cause and was connected with Gracchus himself by ties of hospitality. Gracchus fell fighting bravely; his body was sent to Hannibal, who accorded him a splendid burial.

3. **TIBERIUS SEMPRONIUS GRACCHUS** (c. 210-151 B.C.), father of the tribunes, and husband of Cornelia, the daughter of the elder Scipio Africanus, was possibly the son of a Publius Sempronius Gracchus who was tribune in 189. Although a determined political opponent of the two Scipios (Asiaticus and Africanus), as tribune in 187 he interfered on their behalf when they were accused of having accepted bribes from the king of Syria after the war. In 185 he was a member of the commission sent to Macedonia to investigate the complaints made by Eumenes II. of Pergamum against Philip V. of Macedon. In his curule aedileship (182) he celebrated the games on so magnificent a scale that the burdens imposed upon the Italian and extra-Italian communities led to the official interference of the senate. In 181 he went as praetor to Hither Spain, and, after gaining signal successes in the field, applied himself to the pacification of the country. His strict sense of justice and sympathetic attitude won the respect and affection of the inhabitants; the land had rest for a quarter of a century. When consul in 177, he was occupied in putting down a revolt in Sardinia, and brought back so many prisoners that *Sardi venales* (Sardinians for sale) became a proverbial expression for a drug in the market. In 169 Gracchus was censor, and both he and his colleague (C. Claudius Pulcher) showed themselves determined opponents of the capitalists. They deeply offended the equestrian order by forbidding any contractor who had obtained contracts under the previous censors to make fresh offers. Gracchus stringently enforced the limitation of the freedmen to the four city tribes, which completely destroyed their influence in the comitia. In 165 and 161 he went as ambassador to several Asiatic princes, with whom he established friendly relations. Amongst the places visited by him was Rhodes, where he delivered a speech in Greek, which he afterwards published. In 163 he was again consul.

4. **TIBERIUS SEMPRONIUS GRACCHUS** (163-133 B.C.), son of (3), was the elder of the two great reformers. He and his brother were brought up by their mother Cornelia, assisted by the rhetorician Diophanes of Mytilene and the Stoic Blossius of Cumae. In 147 he served under his brother-in-law the younger

Scipio in Africa during the last Punic war, and was the first to mount the walls in the attack on Carthage. When quaestor in 137, he accompanied the consul C. Hostilius Mancinus to Spain. During the Numantine war the Roman army was saved from annihilation only by the efforts of Tiberius, with whom alone the Numantines consented to treat, out of respect for the memory of his father. The senate refused to ratify the agreement; Mancinus was handed over to the enemy as a sign that it was annulled, and only personal popularity saved Tiberius himself from punishment. In 133 he was tribune, and championed the impoverished farmer class and the lower orders. His proposals (see **AGRARIAN LAWS**) met with violent opposition, and were not carried until he had, illegally and unconstitutionally, secured the deposition of his fellow-tribune, M. Octavius, who had been persuaded by the optimates to veto them. The senate put every obstacle in the way of the three commissioners appointed to carry out the provisions of the law, and Tiberius, in view of the bitter enmity he had aroused, saw that it was necessary to strengthen his hold on the popular favour. The legacy to the Roman people of the kingdom and treasures of Attalus III. of Pergamum gave him an opportunity. He proposed that the money realized by the sale of the treasures should be divided, for the purchase of implements and stock, amongst those to whom assignments of land had been made under the new law. He is also said to have brought forward measures for shortening the period of military service, for extending the right of appeal from the *judices* to the people, for abolishing the exclusive privilege of the senators to act as jurors, and even for admitting the Italian allies to citizenship. To strengthen his position further, Tiberius offered himself for re-election as tribune for the following year. The senate declared that it was illegal to hold this office for two consecutive years; but Tiberius treated this objection with contempt. To win the sympathy of the people, he appeared in mourning, and appealed for protection for his wife and children, and whenever he left his house he was accompanied by a bodyguard of 3000 men, chiefly consisting of the city rabble. The meeting of the tribes for the election of tribunes broke up in disorder on two successive days, without any result being attained, although on both occasions the first divisions voted in favour of Tiberius. A rumour reached the senate that he was aiming at supreme power, that he had touched his head with his hand, a sign that he was asking for a crown. An appeal to the consul P. Mucius Scaevola to order him to be put to death at once having failed, P. Scipio Nasica exclaimed that Scaevola was acting treacherously towards the state, and called upon those who agreed with him to take up arms and follow him. During the riot that followed, Tiberius attempted to escape, but stumbled on the slope of the Capitol and was beaten to death with the end of a bench. At night his body, with those of 300 others, was thrown into the Tiber. The aristocracy boldly assumed the responsibility for what had occurred, and set up a commission to inquire into the case of the partisans of Tiberius, many of whom were banished and others put to death. Even the moderate Scaevola subsequently maintained that Nasica was justified in his action; and it was reported that Scipio, when he heard at Numantia of his brother-in-law's death, repeated the line of Homer—"So perish all who do the like again."

See Livy, *Epit.* 58; Appian, *Bell. civ.* i. 9-17; Plutarch, *Tiberius Gracchus*; Vell. Pat. ii. 2, 3.

5. **GAIUS SEMPRONIUS GRACCHUS** (153-121 B.C.), younger brother of (4), was a man of greater abilities, bolder and more passionate, although possessed of considerable powers of self-control, and a vigorous and impressive orator. When twenty years of age he was appointed one of the commissioners to carry out the distribution of land under the provisions of his brother's agrarian law. At the time of Tiberius's death, Gaius was serving under his brother-in-law Scipio in Spain, but probably returned to Rome in the following year (133). In 131 he supported the bill of C. Papirius Carbo, the object of which was to make it legal for a tribune to offer himself as candidate for the office in two consecutive years, and thus to remove

one of the chief obstacles that had hampered Tiberius. The bill was then rejected, but appears to have subsequently passed in a modified form, as Gaius himself was re-elected without any disturbance. Possibly, however, his re-election was illegal, and he had only succeeded where his brother had failed. For the next few years nothing is heard of Gaius. Public opinion pointed him out as the man to avenge his brother's death and carry out his plans, and the aristocratic party, warned by the example of Tiberius, were anxious to keep him away from Rome. In 126 Gaius accompanied the consul L. Aurelius Orestes as quaestor to Sardinia, then in a state of revolt. Here he made himself so popular that the senate in alarm prolonged the command of Orestes, in order that Gaius might be obliged to remain there in his capacity of quaestor. But he returned to Rome without the permission of the senate, and, when called to account by the censors, defended himself so successfully that he was acquitted of having acted illegally. The disappointed aristocrats then brought him to trial on the charge of being implicated in the revolt of Fregellae, and in other ways unsuccessfully endeavoured to undermine his influence. Gaius then decided to act; against the wishes of his mother he became a candidate for the tribuneship, and, in spite of the determined opposition of the aristocracy, he was elected for the year 123, although only fourth on the list. The legislative proposals¹ brought forward by him had for their object:—the punishment of his brother's enemies; the relief of distress and the attachment to himself of the city populace; the diminution of the power of the senate and the increase of that of the *equites*; the amelioration of the political status of the Italians and provincials.

A law was passed that no Roman citizen should be tried in a matter affecting his life or political status unless the people had previously given its assent. This was specially aimed at Popilius Laenas, who had taken an active part in the prosecution of the adherents of Tiberius. Another law enacted that any magistrate who had been deprived of office by decree of the people should be incapacitated from holding office again. This was directed against M. Octavius, who had been illegally deprived of his tribunate through Tiberius. This unfair and vindictive measure was withdrawn at the earnest request of Cornelia.

He revived his brother's agrarian law, which, although it had not been repealed, had fallen into abeyance. By his *Lex Frumentaria* every citizen resident in Rome was entitled to a certain amount of corn at about half the usual price; as the distribution only applied to those living in the capital, the natural result was that the poorer country citizens flocked into Rome and swelled the number of Gaius's supporters. No citizen was to be obliged to serve in the army before the commencement of his eighteenth year, and his military outfit was to be supplied by the state, instead of being deducted from his pay. Gaius also proposed the establishment of colonies in Italy (at Tarentum and Capua), and sent out to the site of Carthage 6000 colonists to found the new city of Junonia, the inhabitants of which were to possess the rights of Roman citizens; this was the first attempt at over-sea colonization. A new system of roads was constructed which afforded easier access to Rome. Having thus gained over the city proletariat, in order to secure a majority in the *comitia* by its aid, Gaius did away with the system of voting in the *comitia centuriata*, whereby the five property classes in each tribe gave their votes one after another, and introduced promiscuous voting in an order fixed by lot.

The *judices* in the standing commissions for the trial of particular offences (the most important of which was that dealing with the trial of provincial magistrates for extortion, *de repetundis*) were in future to be chosen from the *equites* (*q.v.*), not as hitherto from the senate. The taxes of the new province of Asia were to be let out by the censors to Roman *publicani* (who belonged to the equestrian order), who paid down a lump sum for the right of collecting them. It is obvious that this afforded the *equites* extensive opportunities for money-making and extortion, while the alteration in the appointment of the *judices* gave them the same practical immunity and perpetuated the old abuses, with the difference that it was no longer senators, but *equites*, who could look forward with confidence to being leniently dealt with by men belonging to their own order; Gaius also expected that this moneyed aristocracy, which had taken the part of the senate against Tiberius, would now support him against it. It was enacted that the provinces to be assigned to the consuls, should be determined before,

¹ These measures cannot be arranged in any definite chronological order, nor can it be decided which belong to his first, which to his second tribuneship. See W. Warde Fowler in *Eng. Hist. Review*, 1905, pp. 209 sqq., 417 sqq.

instead of after their election; and the consuls themselves had to settle, by lot or other arrangement, which province each of them would take.²

These measures raised Gaius to the height of his popularity, and during the year of his first tribuneship he may be considered the absolute ruler of Rome. He was chosen tribune for the second time for the year 122. To this period is probably to be assigned his proposal that the franchise should be given to all the Latin communities and that the status of the Latins should be conferred upon the Italian allies. In 125 M. Fulvius Flaccus had brought forward a similar measure, but he was got out of the way by the senate, who sent him to fight in Gaul. This proposal, more statesmanlike than any of the others, was naturally opposed by the aristocratic party, and lessened Gaius's popularity amongst his own supporters, who viewed with disfavour the prospect of an increase in the number of Roman citizens. The senate put up M. Livius Drusus to outbid him, and his absence from Rome while superintending the organization of the newly-founded colony, Junonia-Carthago, was taken advantage of by his enemies to weaken his influence. On his return he found his popularity diminished. He failed to secure the tribuneship for the third time, and his bitter enemy L. Opimius was elected consul. The latter at once decided to propose the abandonment of the new colony, which was to occupy the site cursed by Scipio, while its foundation had been attended by unmistakable manifestations of the wrath of the gods. On the day when the matter was to be put to the vote, a lictor named Antyllus, who had insulted the supporters of Gaius, was stabbed to death. This gave his opponents the desired opportunity. Gaius was declared a public enemy, and the consuls were invested with dictatorial powers. The Gracchans, who had taken up their position in the temple of Diana on the Aventine, offered little resistance to the attack ordered by Opimius. Gaius managed to escape across the Tiber, where his dead body was found on the following day in the grove of Furrina by the side of that of a slave, who had probably slain his master and then himself. The property of the Gracchans was confiscated, and a temple of Concord erected in the Forum from the proceeds. Beneath the inscription recording the occasion on which the temple had been built some one during the night wrote the words: "The work of Discord makes the temple of Concord."

BIBLIOGRAPHY.—See Livy, *Epit.* 60; Appian, *Bell. Civ.* i. 21; Plutarch, *Gaius Gracchus*; Orosius v. 12; Aulus Gellius x. 3, xi. 10. For an account of the two tribunes see Mommsen, *Hist. of Rome* (Eng. trans.), bk. iv, chs. 2 and 3; C. Neumann, *Geschichte Roms während des Verfalles der Republik* (1881); A. H. J. Greenidge, *History of Rome* (1904); E. Meyer, *Untersuchungen zur Geschichte der Gracchen* (1894); G. E. Underhill, *Plutarch's Lives of the Gracchi* (1892); W. Warde Fowler in *English Historical Review* (1905), pp. 209 and 417; Long, *Decline of the Roman Republic*, chs. 10-13, 17-19, containing a careful examination of the ancient authorities; G. F. Hertberg in Ersch and Gruber's *Allgemeine Encyclopädie*; C. W. Oman, *Seven Roman Statesmen of the later Republic* (1902); T. Lau, *Die Gracchen und ihre Zeit* (1854). The exhaustive monograph by C. W. Nitzsch, *Die Gracchen und ihre nächsten Vorgänger* (1847), also contains an account of the other members of the family, with full references to ancient authorities in the notes. (J. H. F.)

GRACE, WILLIAM GILBERT (1848—), English cricketer, was born at Downend, Gloucestershire, on the 18th of July 1848. He found himself in an atmosphere charged with cricket, his father (Henry Mills Grace) and his uncle (Alfred Pocock) being as enthusiastic over the game as his elder brothers, Henry, Alfred and Edward Mills; indeed, in E. M. Grace the family name first became famous. A younger brother, George Frederick, also added to the cricket reputation of the family. "W. G." witnessed his first great match when he was hardly six years old, the occasion being a game between W. Clarke's All-England Eleven and twenty-two of West Gloucestershire. He was endowed by nature with a splendid physique as well as with powers of self-restraint and determination. At the acme of his career he stood full 6 ft. 2 in., being powerfully proportioned, loose yet strong of limb. A non-smoker, and very moderate

² It is suggested by W. Warde Fowler that Gracchus proposed to add a certain number of *equites* to the senate, thereby increasing it to 900, but the plan was never carried out.

in all matters, he kept himself in condition all the year round, shooting, hunting or running with the beagles as soon as the cricket season was over. He was also a fine runner, 440 yds. over 20 hurdles being his best distance; and it may be quoted as proof of his stamina that on the 30th of July 1866 he scored 224 not out for England v. Surrey, and two days later won a race in the National and Olympian Association meeting at the Crystal Palace. The title of "champion" was well earned by one who for thirty-six years (1865-1900 inclusive) was actively engaged in first-class cricket. In each of these years he was invited to represent the Gentlemen in their matches against the Players, and, when an Australian eleven visited England, to play for the mother country. As late as 1899 he played in the first of the five international contests; in 1900 he played against the players at the Oval, scoring 58 and 3. At fifty-three he scored nearly 1300 runs in first-class cricket, made 100 runs and over on three different occasions and could claim an average of 42 runs. Moreover, his greatest triumphs were achieved when only the very best cricket grounds received serious attention; when, as some consider, bowling was maintained at a higher standard and when all hits had to be run out. He, with his two brothers, E. M. and G. F., assisted by some fine amateurs, made Gloucestershire in one season a first-class county; and it was he who first enabled the amateurs of England to meet the paid players on equal terms and to beat them. There was hardly a "record" connected with the game which did not stand to his credit. Grace was one of the finest fieldmen in England, in his earlier days generally taking long-leg and cover-point, in later times generally standing point. He was, at his best, a fine thrower, fast runner and safe "catch." As a bowler he was long in the first flight, originally bowling fast, but in later times adopting a slower and more tricky style, frequently very effective. By profession he was a medical man. In later years he became secretary and manager of the London County Cricket Club. He was married in 1873 to Miss Agnes Day, and one of his sons played for two years in the Cambridge eleven. He was the recipient of two national testimonials: the first, amounting to £1500, being presented to him in the form of a clock and a cheque at Lord's ground by Lord Charles Russell on the 22nd of July 1879; the second, collected by the M.C.C., the county of Gloucestershire, the *Daily Telegraph* and the *Sportsman*, amounted to about £10,000, and was presented to him in 1896. He visited Australia in 1873-1874 (captain), and in 1891-1892 with Lord Sheffield's Eleven (captain); the United States and Canada in 1872, with R. A. Fitzgerald's team.

Dr Grace played his first great match in 1863, when, being only fifteen years of age, he scored 32 against the All-England Eleven and the bowling of Jackson, Tarrant and Tinley; but the scores which first made his name prominent were made in 1864, viz. 170 and 56 not out for the South Wales Club against the Gentlemen of Sussex. It was in 1865 that he first took an active part in first-class cricket, being then 6 ft. in height, and 11 stone in weight, and playing twice for the Gentlemen v. the Players, but his selection was mainly due to his bowling powers, the best exposition of which was his aggregate of 13 wickets for 84 runs for the Gentlemen of the South v. the Players of the South. His highest score was 400 not out, made in July 1876 against twenty-two of Grimsby; but on three occasions he was twice dismissed without scoring in matches against odds, a fate that never befell him in important cricket. In first-class matches his highest score was 344, made for the M.C.C. v. Kent at Canterbury, in August 1876; two days later he made 177 for Gloucestershire v. Notts, and two days after this 318 not out for Gloucestershire v. Yorkshire, the two last-named opposing counties being possessed of exceptionally strong bowling; thus in three consecutive innings Grace scored 839 runs, and was only got out twice. His 344 was the third highest individual score made in a big match in England up to the end of 1901. He also scored 301 for Gloucestershire v. Sussex at Bristol, in August 1896. He made over 200 runs on ten occasions, the most notable perhaps being in 1871, when he performed the feat twice, each time in benefit matches, and each time in the second innings, having been each time got out in the first over of the first innings. He scored over 100 runs on 221 occasions, the hundredth score being 288, made at Bristol for Gloucestershire v. Somersetshire in 1895. He made every figure from 0 to 100, on one occasion "closing" the innings when he had made 93, the only total he had never made between these limits. In 1871 he made ten "centuries," ranging from 268 to 116. In the matches between the Gentlemen and Players he scored "three

figures" fifteen times, and at every place where these matches have been played. He made over 100 in each of his "first appearances" at Oxford and Cambridge. Three times he made over 100 in each innings of the same match, viz. at Canterbury, in 1868, for South v. North of the Thames, 130 and 102 not out; at Clifton, in 1887, for Gloucestershire v. Kent, 101 and 103 not out; and at Clifton, in 1888, for Gloucestershire v. Yorkshire, 148 and 153. In 1869, playing at the Oval for the Gentlemen of the South v. the Players of the South, Grace and B. B. Cooper put on 283 runs for the first wicket, Grace scoring 180 and Cooper 101. In 1886 Grace and Scotton put on 170 runs for the first wicket of England v. Australia; this occurred at the Oval in August, and Grace's total score was 170. In consecutive innings against the Players from 1871 to 1873 he scored 217, 77 and 112, 117, 163, 158 and 70. He only twice scored over 100 in a big match in Australia, nor did he ever make 200 at Lord's, his highest being 106 for the M.C.C. v. Cambridge University in 1894. His highest aggregates were 2739 (1871), 2622 (1876), 2346 (1895), 2139 (1873), 2135 (1896) and 2062 (1887). He scored three successive centuries in first-class cricket in 1871; 1872, 1873, 1874 and 1876. Playing against Kent at Gravesend in 1895, he was batting, bowling or fielding during the whole time the game was in progress, his scores being 257 and 73 not out. He scored over 1000 runs and took over 100 wickets in seven different seasons, viz. in 1874, 1665 runs and 129 wickets; in 1875, 1498 runs, 192 wickets; in 1876, 2622 runs, 124 wickets; in 1877, 1474 runs, 179 wickets; in 1878, 1151 runs, 153 wickets; in 1885, 1688 runs, 118 wickets; in 1886, 1846 runs, 122 wickets. He never captured 200 wickets in a season, his highest record being 192 in 1875. Playing against Oxford University in 1886, he took all the wickets in the first innings, at a cost of 49 runs. In 1895 he not only made his hundredth century, but actually scored 1000 runs in the month of May alone, his chief scores in that month being 103, 288, 256, 73 and 169, he being then forty-seven years old. He also made during that year scores of 125, 119, 118, 104 and 103 not out, his aggregate for the year being 2346 and his average 51; his innings of 118 was made against the Players (at Lord's), the chief bowlers being Richardson, Mold, Peel and Attewell; he scored level with his partner, A. E. Stoddart (his junior by fifteen years), the pair making 151 before a wicket fell, Grace making in all 118 out of 241. This may fairly be considered one of his most wonderful years. In 1898 the match between Gentlemen v. Players was, as a special compliment, arranged by the M.C.C. committee to take place on his birthday, and he celebrated the event by scoring 43 and 31 not out, though handicapped by lameness and an injured hand. In twenty-six different seasons he scored over 1000 runs, in three of these years being the only man to do so and five times being one out of two.

During the thirty-six years up to and including 1900 he scored nearly 51,000 runs, with an average of 43; and in bowling he took more than 2800 wickets, at an average cost of about 20 runs per wicket. He made his highest aggregate (2739 runs) and had his highest average (78) in 1871; his average for the decade 1868-1877 was 57 runs. His style as a batsman was more commanding than graceful, but as to its soundness and efficacy there were never two opinions; the severest criticism ever passed upon his powers was to the effect that he did not play slow bowling quite as well as fast. (W. J. F.)

GRACE (Fr. *grâce*, Lat. *gratia*, from *gratus*, beloved, pleasing; formed from the root *gra-*, Gr. *χρᾶ*, cf. *χαίρω*, *χάρμα*, *χάρις*), a word of many shades of meaning, but always connoting the idea of favour, whether that in which one stands to others or that which one shows to others. The *New English Dictionary* groups the meanings of the word under three main heads: (1) Pleasing quality, gracefulness, (2) favour, goodwill, (3) gratitude, thanks.

It is in the second general sense of "favour bestowed" that the word has its most important connotations. In this sense it means something given by superior authority as a concession made of favour and goodwill, not as an obligation or of right. Thus, a concession may be made by a sovereign or other public authority "by way of grace." Previous to the Revolution of 1688 such concessions on the part of the crown were known in constitutional law as "Graces." "Letters of Grace" (*gratiae*, *gratiosa rescripta*) is the name given to papal rescripts granting special privileges, indulgences, exemptions and the like. In the language of the universities the word still survives in a shadow of this sense. The word "grace" was originally a dispensation granted by the congregation of the university, or by one of the faculties, from some statutable conditions required for a degree. In the English universities these conditions ceased to be enforced, and the "grace" thus became an essential preliminary to any degree; so that the word has acquired the meaning of (a) the licence granted by congregation to take a

degree, (b) other decrees of the governing body (originally dispensations from statutes), all such decrees being called "graces" at Cambridge, (c) the permission which a candidate for a degree must obtain from his college or hall.

To this general sense of exceptional favour belong the uses of the word in such phrases as "do me this grace," "to be in some one's good graces" and certain meanings of "the grace of God." The style "by the grace of God," borne by the king of Great Britain and Ireland among other sovereigns, though, as implying the principle of "legitimacy," it has been since the Revolution sometimes qualified on the continent by the addition of "and the will of the people," means in effect no more than the "by Divine Providence," which is the style borne by archbishops. To the same general sense of exceptional favour belong the phrases implying the concession of a right to delay in fulfilling certain obligations, e.g. "a fortnight's grace." In law the "days of grace" are the period allowed for the payment of a bill of exchange, after the term for which it has been drawn (in England three days), or for the payment of an insurance premium, &c. In religious language the "Day of Grace" is the period still open to the sinner in which to repent. In the sense of clemency or mercy, too, "grace" is still, though rarely used: "an Act of Grace" is a formal pardon or a free and general pardon granted by act of parliament. Since to grant favours is the prerogative of the great, "Your Grace," "His Grace," &c., became dutiful paraphrases for the simple "you" and "he." Formerly used in the royal address ("the King's Grace," &c.), the style is in England now confined to dukes and archbishops, though the style of "his most gracious majesty" is still used. In Germany the equivalent, *Euer Gnaden*, is the style of princes who are not *Durchlaucht* (i.e. Serene Highness), and is often used as a polite address to any superior.

In the language of theology, though in the English Bible the word is used in several of the above senses, "grace" (Gr. χάρις) has special meanings. Above all, it signifies the spontaneous, unmerited activity of the Divine Love in the salvation of sinners, and the Divine influence operating in man for his regeneration and sanctification. Those thus regenerated and sanctified are said to be in a "state of grace." In the New Testament grace is the forgiving mercy of God, as opposed to any human merit (Rom. xi. 6; Eph. ii. 5; Col. i. 6, &c.); it is applied also to certain gifts of God freely bestowed, e.g. miracles, tongues, &c. (Rom. xv. 15; 1 Cor. xv. 10; Eph. iii. 8, &c.), to the Christian virtues, gifts of God also, e.g. charity, holiness, &c. (2 Cor. viii. 7; 2 Pet. iii. 18). It is also used of the Gospel generally, as opposed to the Law (John i. 17; Rom. vi. 14; 1 Pet. v. 12, &c.); connected with this is the use of the term "year of grace" for a year of the Christian era.

The word "grace" is the central subject of three great theological controversies: (1) that of the nature of human depravity and regeneration (see PELAGIUS), (2) that of the relation between grace and free-will (see CALVIN, JOHN, and ARMINIUS, JACOBUS), (3) that of the "means of grace" between Catholics and Protestants, i.e. whether the efficacy of the sacraments as channels of the Divine grace is *ex opere operato* or dependent on the faith of the recipient.

In the third general sense, of thanks for favours bestowed, "grace" survives as the name for the thanksgiving before or after meals. The word was originally used in the plural, and "to do, give, render, yield graces" was said, in the general sense of the French *rendre grâces* or Latin *gratias agere*, of any giving thanks. The close, and finally exclusive, association of the phrase "to say grace" with thanksgiving at meals was possibly due to the formula "Gratias Deo agamus" ("let us give thanks to God") with which the ceremony began in monastic refectories. The custom of saying grace, which obtained in pre-Christian times among the Jews, Greeks and Romans, and was adopted universally by Christian peoples, is probably less widespread in private houses than it used to be. It is, however, still maintained at public dinners and also in schools, colleges and institutions generally. Such graces are generally in Latin and of great antiquity: they are sometimes short, e.g. "Laus

Deo," "Benedictus benedicta," and sometimes, as at the Oxford and Cambridge colleges, of considerable length. In some countries grace has sunk to a polite formula; in Germany, e.g. it is usual before and after meals to bow to one's neighbours and say "Gesegnete Malzeit!" (May your meal be blessed), a phrase often reduced in practice to "Malzeit" simply.

GRACES, THE, (Gr. Χάριτες, Lat. *Gratiae*), in Greek mythology, the personification of grace and charm, both in nature and in moral action. The transition from a single goddess, Charis, to a number or group of Charites, is marked in Homer. In the *Iliad* one Charis is the wife of Hephaestus, another the promised wife of Sleep, while the plural Charites often occurs. The Charites are usually described as three in number—Aglaiā (brightness), Euphrosyne (joyfulness), Thaliā (bloom)—daughters of Zeus and Hera (or Eurynome, daughter of Oceanus), or of Helios and Aegle; in Sparta, however, only two were known, Cieta (noise) and Phaenna (light), as at Athens Auxo (increase) and Hegemone (queen). They are the friends of the Muses, with whom they live on Mount Olympus, and the companions of Aphrodite, of Peitho, the goddess of persuasion, and of Hermes, the god of eloquence, to each of whom charm is an indispensable adjunct. The need of their assistance to the artist is indicated by the union of Hephaestus and Charis. The most ancient seat of their cult was Orchomenus in Boeotia, where their oldest images, in the form of stones fallen from heaven, were set up in their temple. Their worship was said to have been instituted by Ercoleus, whose three daughters fell into a well while dancing in their honour. At Orchomenus nightly dances took place, and the festival Charitesia, accompanied by musical contests, was celebrated; in Paros their worship was celebrated without music or garlands, since it was there that Minos, while sacrificing to the Charites, received the news of the death of his son Androgeus; at Messene they were revered together with the Eumenides; at Athens, their rites, kept secret from the profane, were held at the entrance to the Acropolis. It was by Auxo, Hegemone and Agraules, the daughter of Cecrops, that young Athenians, on first receiving their spear and shield, took the oath to defend their country. In works of art the Charites were represented in early times as beautiful maidens of slender form, hand in hand or embracing one another and wearing drapery; later, the conception predominated of three naked figures gracefully intertwined. Their attributes were the myrtle, the rose and musical instruments. In Rome the Graces were never the objects of special religious reverence, but were described and represented by poets and artists in accordance with Greek models.

See F. H. Krause, *Musen, Gratien, Horen, und Nymphen* (1871), and the articles by Stoll and Furtwängler in Roscher's *Lexikon der Mythologie*, and by S. Geell in Daremberg and Saglio's *Dictionnaire des antiquités*, with the bibliography.

GRACIÁN Y MORALES, BALTASAR (1601-1658), Spanish prose writer, was born at Calatayud (Aragon) on the 8th of January 1601. Little is known of his personal history except that on May 14, 1619, he entered the Society of Jesus, and that ultimately he became rector of the Jesuit college at Tarazona, where he died on the 6th of December, 1658. His principal works are *El Héroe* (1630), which describes in apophthegmatic phrases the qualities of the ideal man; the *Arte de ingenio, tratado de la Agudeza* (1642), republished six years afterwards under the title of *Agudeza, y arte de ingenio* (1648), a system of rhetoric in which the principles of *conceptismo* as opposed to *cullerianismo* are inculcated; *El Discreto* (1645), a delineation of the typical courtier; *El Oráculo manual y arte de prudencia* (1647), a system of rules for the conduct of life; and *El Criticón* (1651-1653-1657), an ingenious philosophical allegory of human existence. The only publication which bears Gracián's name is *El Comulgatorio* (1655); his more important books were issued under the pseudonym of Lorenzo Gracián (possibly a brother of the writer) or under the anagram of Gracian de Marlones. Gracián was punished for publishing without his superior's permission *El Criticón* (in which Deíoe is alleged to have found the germ of *Robinson Crusoe*); but no objection was taken to

its substance. He has been excessively praised by Schopenhauer, whose appreciation of the author induced him to translate the *Oráculo manual*, and he has been unduly depreciated by Ticknor and others. He is an acute thinker and observer, misled by his systematic misanthropy and by his fantastic literary theories.

See Karl Borinski, *Baltasar Gracián und die Hofliteratur in Deutschland* (Halle, 1894); Benedetto Croce, *I Trattatisti italiani del "consigliismo" e Baltasar Gracián* (Napoli, 1899); Narciso José Liñán y Heredia, *Baltasar Gracián* (Madrid, 1902). Schopenhauer and Joseph Jacobs have respectively translated the *Oráculo manual* into German and English.

GRACKLE (Lat. *Graculus* or *Graculus*), a word much used in ornithology, generally in a vague sense, though restricted to members of the families *Sturnidae* belonging to the Old World and *Icteridae* belonging to the New. Of the former those to which it has been most commonly applied are the species known as mynas, mainas, and minors of India and the adjacent countries, and especially the *Gracula religiosa* of Linnaeus, who, according to Jerdon and others, was probably led to confer this epithet upon it by confounding it with the *Sturnus* or *Acridotheres tristis*,¹ which is regarded by the Hindus as sacred to Ram Deo, one of their deities, while the true *Gracula religiosa* does not seem to be anywhere held in veneration. This last is about 10 in.

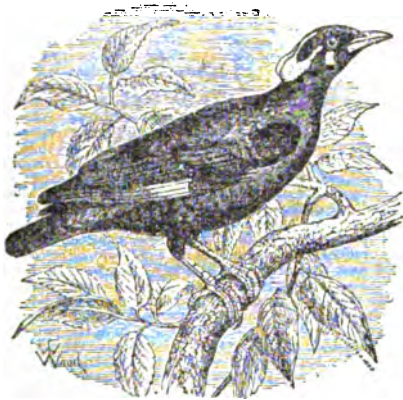

Gracula religiosa.

in length, clothed in a plumage of glossy black, with purple and green reflections, and a conspicuous patch of white on the quill-feathers of the wings. The bill is orange and the legs yellow, but the bird's most characteristic feature is afforded by the curious wattles of bright yellow, which, beginning behind the eyes, run backwards in form of a lappet on each side, and then return in a narrow stripe to the top of the head. Beneath each eye also is a bare patch of the same colour. This species is common in southern India, and is represented farther to the north, in Ceylon, Burma, and some of the Malay Islands by cognate forms. They are all frugivorous, and, being easily tamed and learning to pronounce words very distinctly, are favourite cage-birds.²

In America the name Grackle has been applied to several species of the genera *Scolecophagus* and *Quiscalus*, though these are more commonly called in the United States and Canada "blackbirds," and some of them "boat-tails." They all belong to the family *Icteridae*. The best known of these are the rusty grackle, *S. ferrugineus*, which is found in almost the whole of North America, and *Q. purpureus*, the purple grackle or crow-

¹ By some writers the birds of the genera *Acridotheres* and *Temnuchus* are considered to be the true mynas, and the species of *Gracula* are called "hill mynas" by way of distinction.

² For a valuable monograph on the various species of *Gracula* and its allies see Professor Schlegel's "Bijdrage tot de Kennis van het Geslacht Beo" (*Nederlandsch Tijdschrift voor de Dierkunde* i. 1-9).

blackbird, of more limited range, for though abundant in most parts to the east of the Rocky Mountains, it seems not to appear on the Pacific side. There is also Brewer's or the blue-headed grackle, *S. cyanocephalus*, which has a more western range, not occurring to the eastward of Kansas and Minnesota. A fourth species, *Q. major*, inhabits the Atlantic States as far north as North Carolina. All these birds are of exceedingly omnivorous habit, and though destroying large numbers of pernicious insects are in many places held in bad repute from the mischief they do to the corn-crops. (A. N.)

GRADISCA, a town of Austria, in the province of Görz and Gradisca, 10 m. S.W. of Görz by rail. Pop. (1900) 3843, mostly Italians. It is situated on the right bank of the Isonzo and was formerly a strongly fortified place. Its principal industry is silk spinning. Gradisca originally formed part of the margraviate of Friuli, came under the patriarchate of Aquileia in 1028, and in 1420 to Venice. Between 1471 and 1481 Gradisca was fortified by the Venetians, but in 1511 they surrendered it to the emperor Maximilian I. In 1647 Gradisca and its territory, including Aquileia and forty-three smaller places, were erected into a separate countship in favour of Johann Anton von Eggenberg, duke of Krumau. On the extinction of his line in 1717, it reverted to Austria, and was completely incorporated with Görz in 1754. The name was revived by the constitution of 1861, which established the crownland of Görz and Gradisca.

GRADO, a town of northern Spain, in the province of Oviedo; 11 m. W. by N. of the city of Oviedo, on the river Cubia, a left-hand tributary of the Nalon. Pop. (1900) 17,125. Grado is built in the midst of a mountainous, well-wooded and fertile region. It has some trade in timber, live stock, cider and agricultural produce. The nearest railway station is that of the Fabrica de Trubia, a royal cannon-foundry and small-arms factory, 5 m. S.E.

GRADUAL (Med. Lat. *gradualis*, of or belonging to steps or degrees; *gradus*, step), advancing or taking place by degrees or step by step; hence used of a slow progress or a gentle declivity or slope, opposed to steep or precipitous. As a substantive, "gradual" (Med. Lat. *graduale* or *gradale*) is used of a service book or antiphonal of the Roman Catholic Church containing certain antiphons, called "graduals," sung at the service of the Mass after the reading or singing of the Epistle. This antiphon received the name either because it was sung on the steps of the altar or while the deacon was mounting the steps of the ambo for the reading or singing of the Gospel. For the so-called Gradual Psalms, cxx-cxxiv., the "songs of degrees," LXX. *שִׁיר אֲדָמָה בַּשֹּׁמַיִם*, see PSALMS, BOOK OF.

GRADUATE (Med. Lat. *graduare*, to admit to an academical degree, *gradus*), in Great Britain a verb now only used in the academical sense intransitively, *i.e.* "to take or proceed to a university degree," and figuratively of acquiring knowledge of, or proficiency in, anything. The original transitive sense of "to confer or admit to a degree" is, however, still preserved in America, where the word is, moreover, not strictly confined to university degrees, but is used also of those successfully completing a course of study at any educational establishment. As a substantive, a "graduate" (Med. Lat. *graduatus*) is one who has taken a degree in a university. Those who have matriculated at a university, but not yet taken a degree, are known as "undergraduates." The word "student," used of undergraduates *e.g.* in Scottish universities, is never applied generally to those of the English and Irish universities. At Oxford the only "students" are the "senior students" (*i.e.* fellows) and "junior students" (*i.e.* undergraduates on the foundation, or "scholars") of Christ Church. The verb "to graduate" is also used of dividing anything into degrees or parts in accordance with a given scale. For the scientific application see GRADUATION below. It may also mean "to arrange in gradations" or "to adjust or apportion according to a given scale." Thus by "a graduated income-tax" is meant the system by which the percentage paid differs according to the amount of income on a pre-arranged scale.

GRADUATION (see also **GRADUATE**), the art of dividing straight scales, circular arcs or whole circumferences into any required number of equal parts. It is the most important and difficult part of the work of the mathematical instrument maker, and is required in the construction of most physical, astronomical, nautical and surveying instruments.

The art was first practised by clockmakers for cutting the teeth of their wheels at regular intervals; but so long as it was confined to them no particular delicacy or accurate nicety in its performance was required. This only arose when astronomy began to be seriously studied, and the exact position of the heavenly bodies to be determined, which created the necessity for strictly accurate means of measuring linear and angular magnitudes. Then it was seen that graduation was an art which required special talents and training, and the best artists gave great attention to the perfecting of astronomical instruments. Of these may be named Abraham Sharp (1651-1742), John Bird (1709-1776), John Smeaton (1724-1792), Jesse Ramsden (1735-1800), John Troughton, Edward Troughton (1753-1835), William Simms (1793-1860) and Andrew Ross.

The first graduated instrument must have been done by the hand and eye alone, whether it was in the form of a straight-edge with equal divisions, or a screw or a divided plate; but, once in the possession of one such divided instrument, it was a comparatively easy matter to employ it as a standard. Hence graduation divides itself into two distinct branches, *original graduation* and *copying*, which latter may be done either by the hand or by a machine called a dividing engine. Graduation may therefore be treated under the three heads of *original graduation*, *copying* and *machine graduation*.

Original Graduation.—In regard to the graduation of straight scales elementary geometry provides the means of dividing a straight line into any number of equal parts by the method of continual bisection; but the practical realization of the geometrical construction is so difficult as to render the method untrustworthy. This method, which employs the common diagonal scale, was used in dividing a quadrant of 3 ft. radius, which belonged to Napier of Merchiston, and which only read to minutes—a result, according to Thomson and Tait (*Nat. Phil.*), "giving no greater accuracy than is now attainable by the pocket sextants of Troughton and Simms, the radius of whose arc is little more than an inch."

The original graduation of a straight line is done either by the method of continual bisection or by stepping. In continual bisection the entire length of the line is first laid down. Then, as nearly as possible, half that distance is taken in the beam-compass and marked off by faint arcs from each end of the line. Should these marks coincide the exact middle point of the line is obtained. If not, as will almost always be the case, the distance between the marks is carefully bisected by hand with the aid of a magnifying glass. The same process is again applied to the halves thus obtained, and so on in succession, dividing the line into parts represented by 2, 4, 8, 16, &c. till the desired divisions are reached. In the method of stepping the smallest division required is first taken, as accurately as possible, by spring dividers, and that distance is then laid off, by successive steps, from one end of the line. In this method, any error at starting will be multiplied at each division by the number of that division. Errors so made are usually adjusted by the dots being put either back or forward a little by means of the dividing punch guided by a magnifying glass. This is an extremely tedious process, as the dots, when so altered several times, are apt to get insufferably large and shapeless.

The division of circular arcs is essentially the same in principle as the graduation of straight lines.

The first example of note is the 8-ft. mural circle which was graduated by George Graham (1673-1751) for Greenwich Observatory in 1725. In this two concentric arcs of radii 96.85 and 95.8 in. respectively were first described by the beam-compass. On the inner of these the arc of 90° was to be divided into degrees and 12th parts of a degree, while the same on the outer was to be divided into 96 equal parts and these again into 16th parts. The reason for adopting the latter was that, 96 and 16 being both powers of 2, the divisions could be got at by continual bisection alone, which, in Graham's opinion, who first employed it, is the only accurate method, and would thus serve as a check upon the accuracy of the divisions of the outer arc. With the same distance on the beam-compass as was used to describe the inner arc, laid off from 0°, the point 60° was at once determined. With the points 0° and 60°

as centres successively, and a distance on the beam-compass very nearly bisecting the arc of 60°, two slight marks were made on the arc; the distance between these marks was divided by the hand aided by a lens, and this gave the point 30°. The chord of 60° laid off from the point 30° gave the point 90°, and the quadrant was now divided into three equal parts. Each of these parts was similarly bisected, and the resulting divisions again trisected, giving 18 parts of 5° each. Each of these quinquesections gave degrees, the 12th parts of which were arrived at by bisecting and trisecting as before. The outer arc was divided by continual bisection alone, and a table was constructed by which the readings of the one arc could be converted into those of the other. After the dots indicating the required divisions were obtained, either straight strokes all directed towards the centre were drawn through them by the dividing knife, or sometimes small arcs were drawn through them by the beam-compass having its fixed point somewhere on the line which was a tangent to the quadrantal arc at the point where a division was to be marked.

The next important example of graduation was done by Bird in 1767. His quadrant, which was also 8-ft. radius, was divided into degrees and 12th parts of a degree. He employed the method of continual bisection aided by chords taken from an exact scale of equal parts, which could read to .001 of an inch, and which he had previously graduated by continual bisections. With the beam-compass an arc of radius 95.938 in. was first drawn. From this radius the chords of 30°, 15°, 10°, 20°, 4°, 40° and 42° 40' were computed, and each of them by means of the scale of equal parts laid off on a separate beam-compass to be ready. The radius laid off from 0° gave the point 60°; by the chord of 30° the arc of 60° was bisected; from the point 30° the radius laid off gave the point 90°; the chord of 15° laid off backwards from 90° gave the point 75°; from 75° was laid off forwards the chord of 10° 20'; and from 90° was laid off backwards the chord of 4° 40'; and these were found to coincide in the point 85° 20'. Now 85° 20' being $5^\circ \times 1024 = 5^\circ \times 2^{10}$, the final divisions of 85° 20' were found by continual bisections. For the remainder of the quadrant beyond 85° 20', containing 56 divisions of 5' each, the chord of 64 such divisions was laid off from the point 85° 40', and the corresponding arc divided by continual bisections as before. There was thus a severe check upon the accuracy of the points already found, viz. 15°, 30°, 60°, 75°, 90°, which, however, were found to coincide with the corresponding points obtained by continual bisections. The short lines through the dots were drawn in the way already mentioned.

The next eminent artists in original graduation are the brothers John and Edward Troughton. The former was the first to devise a means of graduating the quadrant by continual bisection without the aid of such a scale of equal parts as was used by Bird. His method was as follows: The radius of the quadrant laid off from 0° gave the point 60°. This arc bisected and the half laid off from 60° gave the point 90°. The arc between 60° and 90° bisected gave 75°; the arc between 75° and 90° bisected gave the point 82° 30'; and the arc between 82° 30' and 90° bisected gave the point 86° 15'. Further, the arc between 82° 30' and 86° 15' trisected, and two-thirds of it taken beyond 82° 30' gave the point 85°, while the arc between 85° and 86° 15' also trisected, and one-third part laid off beyond 85°, gave the point 85° 25'. Lastly, the arc between 85° and 85° 25' being quinquesectioned, and four-fifths taken beyond 85°, gave 85° 20', which as before is $5^\circ \times 2^{10}$, and so can be finally divided by continual bisection.

The method of original graduation discovered by Edward Troughton is fully described in the *Philosophical Transactions* for 1809, as employed by himself to divide a meridian circle of 4 ft. radius. The circle was first accurately turned both on its face and its inner and outer edges. A roller was next provided, of such diameter that it revolved 16 times on its own axis while made to roll once round the outer edge of the circle. This roller, made movable on pivots, was attached to a frame-work, which could be slid freely, yet tightly, along the circle, the roller meanwhile revolving, by means of frictional contact, on the outer edge. The roller was also, after having been properly adjusted as to size, divided as accurately as possible into 16 equal parts by lines parallel to its axis. While the frame carrying the roller was moved once round along the circle, the points of contact of the roller-divisions with the circle were accurately observed by two microscopes attached to the frame, one of which (which we shall call H) commanded the ring on the circle near its edge, which was to receive the divisions and the other viewed the roller-divisions. The points of contact thus ascertained were marked with faint dots, and the meridian circle thereby divided into 256 very nearly equal parts.

The next part of the operation was to find out and tabulate the errors of these dots, which are called *apparent* errors, in consequence of the error of each dot being ascertained on the supposition that its neighbours are all correct. For this purpose two microscopes (which we shall call A and B) were taken, with cross wires and micrometer adjustments, consisting of a screw and head divided into 100 divisions, 50 of which read in the one and 50 in the opposite direction. These microscopes were fixed so that their cross-wires respectively bisected the dots 0 and 128, which were supposed to be diametrically opposite. The circle was now turned half-way round on its axis, so that dot 128 coincided with the wire of A,

and, should dot 0 be found to coincide with B, then the two dots were 180° apart. If not, the cross wire of B was moved till it coincided with dot 0, and the number of divisions of the micrometer head noted. Half this number gave clearly the error of dot 128, and it was tabulated + or - according as the arcual distance between 0 and 128 was found to exceed or fall short of the remaining part of the circumference. The microscope B was now shifted, A remaining opposite dot 0 as before, till its wire bisected dot 64, and, by giving the circle one quarter of a turn on its axis, the difference of the arcs between dots 0 and 64, and between 64 and 128 was obtained. The half of this difference gave the apparent error of dot 64, which was tabulated with its proper sign. With the microscope A still in the same position the error of dot 192 was obtained, and in the same way by shifting B to dot 32 the errors of dots 32, 96, 160 and 224 were successively ascertained. In this way the apparent errors of all the 256 dots were tabulated.

From this table of apparent errors a table of real errors was drawn up by employing the following formula:—

$$\frac{1}{2}(x_1 + x_2) + s = \text{the real error of dot } b,$$

where x_1 is the real error of dot a , x_2 the real error of dot c , and s the apparent error of dot b midway between a and c . Having got the real errors of any two dots, the table of apparent errors gives the means of finding the real errors of all the other dots.

The last part of Troughton's process was to employ them to cut the final divisions of the circle, which were to be spaces of 5' each. Now the mean interval between any two dots is $360^\circ/256 = 1^\circ 16'$, and hence, in the final division, this interval must be divided into 16 equal parts. To accomplish this a small instrument, called a subdividing sector, was provided. It was formed of thin brass and had a radius about four times that of the roller, but made adjustable as to length. The sector was placed concentrically on the axis, and rested on the upper end of the roller. It turned by frictional adhesion along with the roller, but was sufficiently loose to allow of its being moved back by hand to any position without affecting the roller. While the roller passes over an angular space equal to the mean interval between two dots, any point of the sector must pass over 16 times that interval, that is to say, over an angle represented by $360^\circ \times 16/256 = 22^\circ 30'$. This interval was therefore divided by 16, and a space equal to 16 of the parts taken. This was laid off on the arc of the sector and divided into 16 equal parts, each equal to $1^\circ 20'$; and, to provide for the necessary $\frac{1}{16}$ ths of a division, there was laid off at each end of the sector, and beyond the 16 equal parts, two of these parts each subdivided into 8 equal parts. A microscope with cross wires, which we shall call I, was placed on the main frame, so as to command a view of the sector divisions, just as the microscope H viewed the final divisions of the circle. Before the first or zero mark was cut, the zero of the sector was brought under I and then the division cut at the point on the circle indicated by H, which also coincided with the dot 0. The frame was then slipped along the circle by the slow screw motion provided for the purpose, till the first sector-division, by the action of the roller, was brought under I. The second mark was then cut on the circle at the point indicated by H. That the marks thus obtained are 5' apart is evident when we reflect that the distance between them must be $\frac{1}{16}$ th of a division on the sector which by construction is $1^\circ 20'$. In this way the first 16 divisions were cut; but before cutting the 17th it was necessary to adjust the micrometer-wires of H to the real error of dot 1, as indicated by the table, and bring back the sector, not to zero, but to $\frac{1}{16}$ th short of zero. Starting from this position the divisions between dots 1 and 2 were filled in, and then H was adjusted to the real error of dot 2, and the sector brought back to its proper division before commencing the third course. Proceeding in this manner through the whole circle, the microscope H was finally found with its wire at zero, and the sector with its 16th division under its microscope indicating that the circle had been accurately divided.

Copying.—In graduation by copying the pattern must be either an accurately divided straight scale, or an accurately divided circle, commonly called a *dividing plate*.

In copying a straight scale the pattern and scale to be divided, usually called the work, are first fixed side by side, with their upper faces in the same plane. The dividing square, which closely resembles an ordinary joiner's square, is then laid across both, and the point of the dividing knife dropped into the zero division of the pattern. The square is now moved up close to the point of the knife; and, while it is held firmly in this position by the left hand, the first division on the work is made by drawing the knife along the edge of the square with the right hand.

It frequently happens that the divisions required on a scale are either greater or less than those on the pattern. To meet this case, and still use the same pattern, the work must be fixed at a certain angle of inclination with the pattern. This angle is found in the following way. Take the exact ratio of a division on the pattern to the required division on the scale. Call this

ratio a . Then, if the required divisions are longer than those of the pattern, the angle is $\cos^{-1}a$, but, if shorter, the angle is $\sec^{-1}a$. In the former case two operations are required before the divisions are cut: first, the square is laid on the pattern, and the corresponding divisions merely notched very faintly on the edge of the work; and, secondly, the square is applied to the work and the final divisions drawn opposite each faint notch. In the second case, that is, when the angle is $\sec^{-1}a$, the dividing square is applied to the work, and the divisions cut when the edge of the square coincides with the end of each division on the pattern.

In copying circles use is made of the dividing plate. This is a circular plate of brass, of 36 in. or more in diameter, carefully graduated near its outer edge. It is turned quite flat, and has a steel pin fixed in its centre, and at right angles to its plane. For guiding the dividing knife an instrument called an index is employed. This is a straight bar of thin steel of length equal to the radius of the plate. A piece of metal, having a V notch with its angle a right angle, is riveted to one end of the bar in such a position that the vertex of the notch is exactly in a line with the edge of the steel bar. In this way, when the index is laid on the plate, with the notch grasping the central pin, the straight edge of the steel bar lies exactly along a radius. The work to be graduated is laid flat on the dividing plate, and fixed by two clamps in a position exactly concentric with it. The index is now laid on, with its edge coinciding with any required division on the dividing plate, and the corresponding division on the work is cut by drawing the dividing knife along the straight edge of the index.

Machine Graduation.—The first dividing engine was probably that of Henry Hindley of York, constructed in 1740, and chiefly used by him for cutting the teeth of clock wheels. This was followed shortly after by an engine devised by the duc de Chaulnes; but the first notable engine was that made by Ramsden, of which an account was published by the Board of Longitude in 1777. He was rewarded by that board with a sum of £300, and a further sum of £315 was given to him on condition that he would divide, at a certain fixed rate, the instruments of other makers. The essential principles of Ramsden's machine have been repeated in almost all succeeding engines for dividing circles.

Ramsden's machine consisted of a large brass plate 45 in. in diameter, carefully turned and movable on a vertical axis. The edge of the plate was matched with 2160 teeth, into which a tangent screw worked, by means of which the plate could be made to turn through any required angle. Thus six turns of the screw moved the plate through 1° , and $\frac{1}{16}$ th of a turn through $\frac{1}{16}$ th of a degree. On the axis of the tangent screw was placed a cylinder having a spiral groove cut on its surface. A ratchet-wheel containing 60 teeth was attached to this cylinder, and was so arranged that, when the cylinder moved in one direction, it carried the tangent screw with it, and so turned the plate, but when it moved in the opposite direction, it left the tangent screw, and with it the plate, stationary. Round the spiral groove of the cylinder a catgut band was wound, one end of which was attached to a treadle and the other to a counterpoise weight. When the treadle was depressed the tangent screw turned round, and when the pressure was removed it returned, in obedience to the weight, to its former position without affecting the screw. Provision was also made whereby certain stops could be placed in the way of the screw, which only allowed it the requisite amount of turning. The work to be divided was firmly fixed on the plate, and made concentric with it. The divisions were cut, while the screw was stationary, by means of a dividing knife attached to a swing frame, which allowed it to have only a radial motion. In this way the artist could divide very rapidly by alternately depressing the treadle and working the dividing knife.

Ramsden also constructed a linear dividing engine on essentially the same principle. If we imagine the rim of the circular plate with its notches stretched out into a straight line and made movable in a straight slot, the screw, treadle, &c., remaining as before, we get a very good idea of the linear engine.

In 1793 Edward Troughton finished a circular dividing engine, of which the plate was smaller than in Ramsden's, and which differed considerably in simplifying matters of detail. The plate was originally divided by Troughton's own method, already described, and the divisions so obtained were employed

to ratchet the edge of the plate for receiving the tangent screw with great accuracy. Andrew Ross (*Trans. Soc. Arts*, 1830-1831) constructed a dividing machine which differs considerably from those of Ramsden and Troughton.

The essential point of difference is that, in Ross's engine, the tangent screw does not turn the engine plate; that is done by an independent apparatus, and the function of the tangent screw is only to stop the plate after it has passed through the required angular interval between two divisions on the work to be graduated. Round the circumference of the plate are fixed 48 projections which just look as if the circumference had been divided into as many deep and somewhat peculiarly shaped notches or teeth. Through each of these teeth a hole is bored parallel to the plane of the plate and also a tangent to its circumference. Into these holes are screwed steel screws with capstan heads and flat ends. The tangent screw consists only of a single turn of a large square thread which works in the teeth or notches of the plate. This thread is pierced by 90 equally distant holes, all parallel to the axis of the screw, and at the same distance from it. Into each of these holes is inserted a steel screw exactly similar to those in the teeth, but with its end rounded. It is the rounded and flat ends of these sets of screws coming together that stop the engine plate at the desired position, and the exact point can be nicely adjusted by suitably turning the screws.

A description is given of a dividing engine made by William Simms in the *Memoirs of the Astronomical Society*, 1843. Simms

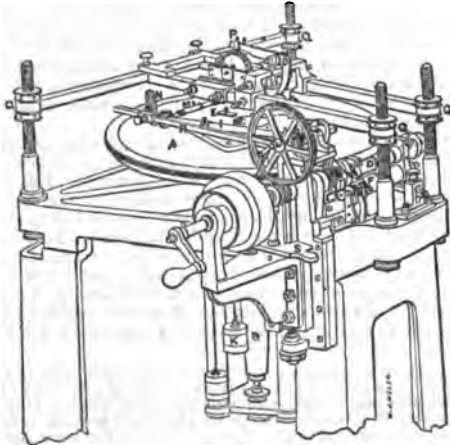

Dividing Engine.

became convinced that to copy upon smaller circles the divisions which had been put upon a large plate with very great accuracy was not only more expeditious but more exact than original graduation. His machine involved essentially the same principle as Troughton's. The accompanying figure is taken by permission.

The plate A is 46 in. in diameter, and is composed of gun-metal cast in one solid piece. It has two sets of 5' divisions—one very faint on an inlaid ring of silver, and the other stronger on the gun-metal. These were put on by original graduation, mainly on the plan of Edward Troughton. One very great improvement in this engine is that the axis B is tubular, as seen at C. The object of this hollow is to receive the axis of the circle to be divided, so that it can be fixed flat to the plate by the clamps E, without having first to be detached from the axis and other parts to which it has already been carefully fitted. This obviates the necessity for resetting, which can hardly be done without some error. D is the tangent screw, and F the frame carrying it, which turns on carefully polished steel pivots. The screw is pressed against the edge of the plate by a spiral spring acting under the end of the lever G, and by screwing the lever down the screw can be altogether removed from contact with the plate. The edge of the plate is ratched by 4320 teeth which were cut opposite the original division by a circular cutter attached to the screw frame. H is the spiral barrel round which the cutgut band is wound, one end of which is attached to the crank L on the end of the axis J and the other to a counterpoise weight not seen. On the other end of J is another crank inclined to L and carrying a band and counterpoise weight seen at K. The object of this weight is to balance the former and give steadiness to the motion. On the

axis J is seen a pair of bevelled wheels which move the rod I, which, by another pair of bevelled wheels attached to the box N, gives motion to the axis M, on the end of which is an eccentric for moving the bent lever O, which actuates the bar carrying the cutter. Between the eccentric and the point of the screw P is an undulating plate by which long divisions can be cut. The cutting apparatus is supported upon the two parallel rails which can be elevated or depressed at pleasure by the nuts Q. Also the cutting apparatus can be moved forward or backward upon these rails to suit circles of different diameters. The box N is movable upon the bar R, and the rod I is adjustable as to length by having a kind of telescope joint. The engine is self-acting, and can be driven either by hand or by a steam-engine or other motive power. It can be thrown in or out of gear at once by a handle seen at S.

Mention may be made of Donkin's linear dividing engine; in which a compensating arrangement is employed whereby great accuracy is obtained notwithstanding the inequalities of the screw used to advance the cutting tool. Dividing engines have also been made by Reichenbach, Repsold and others in Germany, Gamby in Paris and by several other astronomical instrument-makers. A machine constructed by E. R. Watts & Sons is described by G. T. McCaw, in the *Monthly Not. R. A. S.*, January 1909.

REFERENCES.—Bird, *Method of dividing Astronomical Instruments* (London, 1767); Duc de Chaulnes, *Nouvelle Méthode pour diviser les instruments de mathématique et d'astronomie* (1768); Ramsden, *Description of an Engine for dividing Mathematical Instruments* (London, 1777); Troughton's memoir, *Phil. Trans.* (1809); *Memoirs of the Royal Astronomical Society*, v. 325, viii. 141, ix. 17, 35. See also J. E. Watkins, "On the Ramsden Machine," *Smithsonian Rep.* (1890), p. 721; and L. Ambron, *Astronomische Instrumentenkunde* (1899). (J. Bl.)

GRADUS, or **GRADUS AD PARNASSUM** (a step to Parnassus), a Latin (or Greek) dictionary, in which the quantities of the vowels of the words are marked. Synonyms, epithets and poetical expressions and extracts are also included under the more important headings, the whole being intended as an aid for students in Greek and Latin verse composition. The first Latin gradus was compiled in 1702 by the Jesuit Paul Aler (1656-1727), a famous schoolmaster. There is a Latin gradus by C. D. Yonge (1850); English-Latin by A. C. Ainger and H. G. Wintle (1890); Greek by J. Brasse (1828) and E. Maltby (1815), bishop of Durham.

GRAETZ, HEINRICH (1817-1891), the foremost Jewish historian of modern times, was born in Posen in 1817 and died at Munich in 1891. He received a desultory education, and was largely self-taught. An important stage in his development was the period of three years that he spent at Oldenburg as assistant and pupil of S. R. Hirsch, whose enlightened orthodoxy was for a time very attractive to Graetz. Later on Graetz proceeded to Breslau, where he matriculated in 1842. Breslau was then becoming the headquarters of Abraham Geiger, the leader of Jewish reform. Graetz was repelled by Geiger's attitude, and though he subsequently took radical views of the Bible and tradition (which made him an opponent of Hirsch), Graetz remained a life-long foe to reform. He contended for freedom of thought; he had no desire to fight for freedom of ritual practice. He momentarily thought of entering the rabbinate, but he was unsuited to that career. For some years he supported himself as a tutor. He had previously won repute by his published essays, but in 1853 the publication of the fourth volume of his history of the Jews made him famous. This fourth volume (the first to be published) dealt with the Talmud. It was a brilliant resuscitation of the past. Graetz's skill in piecing together detached fragments of information, his vast learning and extraordinary critical acumen, were equalled by his vivid power of presenting personalities. No Jewish book of the 19th century produced such a sensation as this, and Graetz won at a bound the position he still occupies as recognized master of Jewish history. His *Geschichte der Juden*, begun in 1853, was completed in 1875; new editions of the several volumes were frequent. The work has been translated into many languages; it appeared in English in five volumes in 1891-1895. The *History* is defective in its lack of objectivity; Graetz's judgments are sometimes biased, and in particular he lacks sympathy with mysticism. But the history is a work

of genba. Simultaneously with the publication of vol. iv. Graetz was appointed on the staff of the new Breslau Seminary, of which the first director was Z. Frankel. Graetz passed the remainder of his life in this office; in 1869 he was created professor by the government, and also lectured at the Breslau University. Graetz attained considerable reputation as a biblical critic. He was the author of many bold conjectures as to the date of Ruth, Ecclesiastes, Esther and other biblical books. His critical edition of the Psalms (1882-1883) was his chief contribution to biblical exegesis, but after his death Professor Bacher edited Graetz's *Emendationes* to many parts of the Hebrew scriptures.

A full bibliography of Graetz's works is given in the *Jewish Quarterly Review*, iv. 194; a memoir of Graetz is also to be found there. Another full memoir was prefixed to the "index" volume of the *History* in the American re-issue of the English translation in six volumes (Philadelphia, 1898).

GRAEVIUS (properly **GRÄVE** or **GREFFE**), **JOHANN GEORG** (1632-1703), German classical scholar and critic, was born at Naumburg, Saxony, on the 20th of January 1632. He was originally intended for the law, but having made the acquaintance of J. F. Gronovius during a casual visit to Deventer, under his influence he abandoned jurisprudence for philology. He completed his studies under D. Heinsius at Leiden, and under the Protestant theologians A. Morus and D. Blondel at Amsterdam. During his residence in Amsterdam, under Blondel's influence he abandoned Lutheranism and joined the Reformed Church; and in 1656 he was called by the elector of Brandenburg to the chair of rhetoric in the university of Duisburg. Two years afterwards, on the recommendation of Gronovius, he was chosen to succeed that scholar at Deventer; in 1662 he was translated to the university of Utrecht, where he occupied first the chair of rhetoric, and from 1667 until his death (January 11th, 1703) that of history and politics. Graevius enjoyed a very high reputation as a teacher, and his lecture-room was crowded by pupils, many of them of distinguished rank, from all parts of the civilized world. He was honoured with special recognition by Louis XIV., and was a particular favourite of William III. of England, who made him historiographer royal.

His two most important works are the *Thesaurus antiquitatum Romanarum* (1694-1699, in 12 volumes), and the *Thesaurus antiquitatum et historiarum Italiae* published after his death, and continued by the elder Burmann (1704-1725). His editions of the classics, although they marked a distinct advance in scholarship, are now for the most part superseded. They include Hesiod (1667), Lucian, *Pseudosophista* (1668), Justin, *Historiae Philippicae* (1669), Suetonius (1672), Catullus, Tibullus et Propertius (1680), and several of the works of Cicero (his best production). He also edited many of the writings of contemporary scholars. The *Oratio funebris* by P. Burmann (1703) contains an exhaustive list of the works of this scholar; see also P. H. Külb in Ersch and Gruber's *Allgemeine Encyclopädie*, and J. E. Sandys, *History of Classical Scholarship*, ii. (1908).

GRAF, ARTURO (1848-), Italian poet, of German extraction, was born at Athens. He was educated at Naples University and became a lecturer on Italian literature in Rome, till in 1882 he was appointed professor at Turin. He was one of the founders of the *Giornale della letteratura italiana*, and his publications include valuable prose criticism; but he is best known as a poet. His various volumes of verse—*Poesie e sonette* (1874), *Dopo il tramonto versi* (1893), &c.—give him a high place among the recent lyrical writers of his country.

GRAF KARL HEINRICH (1815-1869), German Old Testament scholar and orientalist, was born at Mülhausen in Alsace on the 28th of February 1815. He studied Biblical exegesis and oriental languages at the university of Strassburg under E. Reuss, and, after holding various teaching posts, was made instructor in French and Hebrew at the Landesschule of Meissen, receiving in 1852 the title of professor. He died on the 16th of July 1869. Graf was one of the chief founders of Old Testament criticism. In his principal work, *Die geschichtlichen Bücher des Alten Testaments* (1866), he sought to show that the priestly legislation of Exodus, Leviticus and Numbers is of later origin than the book of Deuteronomy. He still, however, held the accepted view, that the Elohist narratives formed part of the

Grundschrift and therefore belonged to the oldest portions of the Pentateuch. The reasons urged against the contention that the priestly legislation and the Elohist narratives were separated by a space of 500 years were so strong as to induce Graf, in an essay, "Die sogenannte Grundschrift des Pentateuchs," published shortly before his death, to regard the whole *Grundschrift* as post-exilic and as the latest portion of the Pentateuch. The idea had already been expressed by E. Reuss, but since Graf was the first to introduce it into Germany, the theory, as developed by Julius Wellhausen, has been called the Graf-Wellhausen hypothesis.

Graf also wrote, *Der Segen Moses Dent.* 33 (1857) and *Der Prophet Jeremia erklärt* (1862). See T. K. Cheyne, *Founders of Old Testament Criticism* (1893); and Otto Pfeiderer's book translated into English by J. F. Smith as *Development of Theology* (1890).

GRÄFE, ALBRECHT VON (1828-1870), German oculist, son of Karl Ferdinand von Gräfe, was born at Berlin on the 22nd of May 1828. At an early age he manifested a preference for the study of mathematics, but this was gradually superseded by an interest in natural science, which led him ultimately to the study of medicine. After prosecuting his studies at Berlin, Vienna, Prague, Paris, London, Dublin and Edinburgh, and devoting special attention to ophthalmology he, in 1850, began practice as an oculist in Berlin, where he founded a private institution for the treatment of the eyes, which became the model of many similar ones in Germany and Switzerland. In 1853 he was appointed teacher of ophthalmology in Berlin university; in 1858 he became extraordinary professor, and in 1866 ordinary professor. Gräfe contributed largely to the progress of the science of ophthalmology, especially by the establishment in 1855 of his *Archiv für Ophthalmologie*, in which he had Ferdinand Arlt (1812-1887) and F. C. Donders (1818-1880) as collaborators. Perhaps his two most important discoveries were his method of treating glaucoma and his new operation for cataract. He was also regarded as an authority in diseases of the nerves and brain. He died at Berlin on the 20th of July 1870.

See *Ein Wort der Erinnerung an Albrecht von Gräfe* (Halle, 1870) by his cousin, Alfred Gräfe (1830-1890), also a distinguished ophthalmologist, and the author of *Das Sehen der Schielenden* (Wiesbaden, 1897); and E. Michaelis, *Albrecht von Gräfe. Sein Leben und Wirken* (Berlin, 1877).

GRÄFE, HEINRICH (1802-1866), German educationist, was born at Buttstädt in Saxe-Weimar on the 3rd of May 1802. He studied mathematics and theology at Jena, and in 1823 obtained a curacy in the town church of Weimar. He was transferred to Jena as rector of the town school in 1825; in 1840 he was also appointed extraordinary professor of the science of education (Pädagogik) in that university; and in 1842 he became head of the *Bürgerschule* (middle class school) in Cassel. After reorganizing the schools of the town, he became director of the new *Realschule* in 1843; and, devoting himself to the interests of educational reform in electoral Hesse, he became in 1849 a member of the school commission, and also entered the house of representatives, where he made himself somewhat formidable as an agitator. In 1852 for having been implicated in the September riots and in the movement against the unpopular minister Hassempfung, who had dissolved the school commission, he was condemned to three years' imprisonment, a sentence afterwards reduced to one of twelve months. On his release he withdrew to Geneva, where he engaged in educational work till 1855, when he was appointed director of the school of industry at Bremen. He died in that city on the 21st of July 1862.

Besides being the author of many text-books and occasional papers on educational subjects, he wrote *Das Rechtsverhältnis der Volksschule von innen und aussen* (1829); *Die Schulreform* (1834); *Schule und Unterricht* (1839); *Allgemeine Pädagogik* (1845); *Die deutsche Volksschule* (1847). Together with Naumann, he also edited the *Archiv für das praktische Volksschulwesen* (1828-1835).

GRÄFE, KARL FERDINAND VON (1787-1840), German surgeon, was born at Warsaw on the 8th of March 1787. He studied medicine at Halle and Leipzig, and after obtaining licence from the Leipzig university, he was in 1807 appointed private physician to Duke Alexis of Anhalt-Bernburg. In 1812 he became professor of surgery and director of the surgical

clinic at Berlin, and during the war with Napoleon he was superintendent of the military hospitals. When peace was concluded in 1815, he resumed his professional duties. He was also appointed physician to the general staff of the army, and he became a director of the Friedrich Wilhelm Institute and of the Medico-Chirurgical Academy. He died suddenly on the 4th of July 1840 at Hanover, whither he had been called to operate on the eyes of the crown prince. Gräfe did much to advance the practice of surgery in Germany, especially in the treatment of wounds. He improved the rhinoplastic process, and its revival was chiefly due to him. His lectures at the university of Berlin attracted students from all parts of Europe.

The following are his principal works: *Normen für die Ablösung grosser Gliedmassen* (Berlin, 1812); *Rhinoplastik* (1818); *Neue Beiträge zur Kunst Theile des Angesichts organisch zu ersetzen* (1821); *Die epidemisch-contagiöse Augenblennorrhöe Aegyptens in den europäischen Befreiungskriegen* (1824); and *Jahresberichte über das klinisch-chirurgisch-äugenärztliche Institut der Universität zu Berlin* (1817-1834). He also edited, with Ph. von Walther, the *Journal für Chirurgie und Augenheilkunde*. See E. Michaelis, *Karl Ferdinand von Gräfe in seiner 30jährigen Wirken für Staat und Wissenschaft* (Berlin, 1840).

GRAFFITO, plural *graffiti*, the Italian word meaning "scribbling" or "scratchings" (*graffiare*, to scribble, Gr. γράφειν), adopted by archaeologists as a general term for the casual writings, rude drawings and markings on ancient buildings, in distinction from the more formal or deliberate writings known as "inscriptions." These "graffiti," either scratched on stone or plaster by a sharp instrument such as a nail, or, more rarely, written in red chalk or black charcoal, are found in great abundance, e.g. on the monuments of ancient Egypt. The best-known "graffiti" are those in Pompeii and in the catacombs and elsewhere in Rome. They have been collected by R. Garrucci (*Graffiti di Pompei*, Paris, 1856), and L. Correria (*"Graffiti di Roma"* in *Bollettino della commissione municipale archaeologica*, Rome, 1893; see also *Corp. Ins. Lat.* iv., Berlin, 1871). The subject matter of these scribbles is much the same as that of the similar scrawls made to-day by boys, street idlers and the casual "tripper." The schoolboy of Pompeii wrote out lists of nouns and verbs, alphabets and lines from Virgil for memorizing, lovers wrote the names of their beloved, "sportsmen" scribbled the names of horses they had been "tipped," and wrote those of their favourite gladiators. Personal abuse is frequent, and rude caricatures are found, such as that of one Peregrinus with an enormous nose, or of Naso with hardly any. Aulus Vettius Firmus writes up his election address and appeals to the *pluricrepi* or ball-players for their votes for him as aedile. Lines of poetry, chiefly suited for lovers in dejection or triumph, are popular, and Ovid and Propertius appear to be favourites. Apparently private owners of property felt the nuisance of the defacement of their walls, and at Rome near the *Porta Portuensis* has been found an inscription begging people not to scribble (*scariaphare*) on the walls.

Graffiti are of some importance to the palaeographer and to the philologist as illustrating the forms and corruptions of the various alphabets and languages used by the people, and occasionally guide the archaeologist to the date of the building on which they appear, but they are chiefly valuable for the light they throw on the everyday life of the "man in the street" of the period, and for the intimate details of customs and institutions which no literature or formal inscriptions can give. The graffiti dealing with the gladiatorial shows at Pompeii are in this respect particularly noteworthy; the rude drawings such as that of the *secutor* caught in the net of the *retarius* and lying entirely at his mercy, give a more vivid picture of what the incidents of these shows were like than any account in words (see Garrucci, *op. cit.*, Pla. x.-xiv.; A. Mau, *Pompeii in Leben und Kunst*, 2nd ed., 1908, ch. xxx.). In 1866 in the Trastevere quarter of Rome, near the church of S. Crisogono, was discovered the guard-house (*excubitorium*) of the seventh cohort of the city police (*vigiles*), the walls being covered by the scribbles of the guards, illustrating in detail the daily routine, the hardships and dangers, and the feelings of the men towards their officers (W. Hensen,

"L' Excubitorio della Settima coorte dei Vigili" in *Bull. Inst.* 1867, and *Annali Inst.*, 1874; see also R. Lanciani, *Ancient Rome in the Light of Recent Discoveries*, 230, and *Ruins and Excavations of Ancient Rome*, 1897, 548). The most famous graffito yet discovered is that generally accepted as representing a caricature of Christ upon the cross, found on the walls of the Domus Gelotiana on the Palatine in 1857, and now preserved in the Kircherian Museum of the Collegio Romano. Deeply scratched in the wall is a figure of a man clad in the short *tunica* with one hand upraised in salutation to another figure, with the head of an ass, or possibly a horse, hanging on a cross; beneath is written in rude Greek letters "Anaxamenos worships (his) god." It has been suggested that this represents an adherent of some Gnostic sect worshipping one of the animal-headed deities of Egypt (see Ferd. Becker, *Das Spöttercristus der römischen Kaiserpaläste*, Breslau, 1866; F. X. Kraus, *Das Spöttercristus vom Palatin*, Freiburg in Breisgau, 1879; and Visconti and Lanciani, *Guida del Palatino*).

There is an interesting article, with many quotations of graffiti, in the *Edinburgh Review*, October 1859, vol. cx. (C. Wz.)

GRAFLY, CHARLES (1862-), American sculptor, was born at Philadelphia, Pennsylvania, on the 3rd of December 1862. He was a pupil of the schools of the Pennsylvania Academy of the Fine Arts, Philadelphia, and of Henri M. Chapu and Jean Dampé, and the École des Beaux Arts, Paris. He received an Honorable Mention in the Paris Salon of 1891 for his "Mauvais Présage," now at the Detroit Museum of Fine Arts, a gold medal at the Paris Exposition, in 1900, and medals at Chicago, 1893, Atlanta, 1895, and Philadelphia (the gold Medal of Honor, Pennsylvania Academy of the Fine Arts), 1899. In 1892 he became instructor in sculpture at the Pennsylvania Academy of the Fine Arts, also filling the same chair at the Drexel Institute, Philadelphia. He was elected a full member of the National Academy of Design in 1905. His better-known works include: "General Reynolds," Fairmount Park, Philadelphia; "Fountain of Man" (made for the Pan-American Exposition at Buffalo); "From Generation to Generation"; "Symbol of Life"; "Vulture of War," and many portrait busts.

GRÄFRATH, a town in Rhenish Prussia, on the Itterbach, 14 m. E. of Düsseldorf on the railway Hilden-Vohwinkel. Pop. (1905) 9030. It has a Roman Catholic and two Evangelical churches, and there was an abbey here from 1185 to 1803. The principal industries are iron and steel, while weaving is carried on in the town.

GRAFT (a modified form of the earlier "graff," through the French from the Late Lat. *graphium*, a stylus or pencil), a small branch, shoot or "scion," transferred from one plant or tree to another, the "stock," and inserted in it so that the two unite (see **HORTICULTURE**). The name was adopted from the resemblance in shape of the "graft" to a pencil. The transfer of living tissue from one portion of an organism to another part of the same or different organism where it adheres and grows is also known as "grafting," and is frequently practised in modern surgery. The word is applied, in carpentry, to an attachment of the ends of timbers, and, as a nautical term, to the "whipping" or "pointing" of a rope's end with fine twine to prevent unravelling. "Graft" is used as a slang term, in England, for a "piece of hard work." In American usage Webster's *Dictionary* (ed. 1904) defines the word as "the act of any one, especially an official or public employé, by which he procures money surreptitiously by virtue of his office or position; also the surreptitious gain thus procured." It is thus a word embracing blackmail and illicit commission. The origin of the English use of the word is probably an obsolete word "graft," a portion of earth thrown up by a spade, from the Teutonic root meaning "to dig," seen in German *graben*, and English "grave."

GRAFTON, DUKES OF. The English dukess of Grafton are descended from HENRY FITZROY (1663-1690), the natural son of Charles II. by Barbara Villiers (countess of Castlemaine and duchess of Cleveland). In 1672 he was married to the daughter and heiress of the earl of Arlington and created earl of Euston; in 1675 he was created duke of Grafton. He was brought

up as a sailor, and saw military service at the siege of Luxembourg in 1684. At James II.'s coronation he was lord high constable. In the rebellion of the duke of Monmouth he commanded the royal troops in Somersetshire; but later he acted with Churchill (duke of Marlborough), and joined William of Orange against the king. He died of a wound received at the storming of Cork, while leading William's forces, being succeeded as 2nd duke by his son Charles (1682-1757).

AUGUSTUS HENRY FITZROY, 3rd duke of Grafton (1735-1811), one of the leading politicians of his time, was the grandson of the 2nd duke, and was educated at Westminster and Cambridge. He first became known in politics as an opponent of Lord Bute; in 1765 he was secretary of state under the marquis of Rockingham; but he retired next year, and Pitt (becoming earl of Chatham) formed a ministry in which Grafton was first lord of the treasury (1766) but only nominally prime minister. Chatham's illness at the end of 1767 resulted in Grafton becoming the effective leader, but political differences and the attacks of "Junius" led to his resignation in January 1770. He became lord privy seal in Lord North's ministry (1771) but resigned in 1775, being in favour of conciliatory action towards the American colonists. In the Rockingham ministry of 1782 he was again lord privy seal. In later years he was a prominent Unitarian.

Besides his successor, the 4th duke (1760-1844), and numerous other children, he was the father of General Lord Charles Fitzroy (1764-1829), whose sons Sir Charles Fitzroy (1798-1858), governor of New South Wales, and Robert Fitzroy (q.v.), the hydrographer, were notable men. The 4th duke's son, who succeeded as 5th duke, was father of the 6th and 7th duke.

The 3rd duke left in manuscript a *Memoir* of his public career, of which extracts have been printed in Stanhope's *History*, Walpole's *Memoirs of George III.* (Appendix, vol. iv.), and Campbell's *Lives of the Chancellors*.

GRAFTON, RICHARD (d. 1572), English printer and chronicler, was probably born about 1513. He received the freedom of the Grocers' Company in 1534. Miles Coverdale's version of the Bible had first been printed in 1535. Grafton was early brought into touch with the leaders of religious reform, and in 1537 he undertook, in conjunction with Edward Whitchurch, to produce a modified version of Coverdale's text, generally known as Matthew's Bible (Antwerp, 1537). He went to Paris to reprint Coverdale's revised edition (1538). There Whitchurch and he began to print the folio known as the Great Bible by special licence obtained by Henry VIII. from the French government. Suddenly, however, the work was officially stopped and the presses seized. Grafton fled, but Thomas Cromwell eventually bought the presses and type, and the printing was completed in England. The Great Bible was reprinted several times under his direction, the last occasion being 1553. In 1544 Grafton and Whitchurch secured the exclusive right of printing church service books, and on the accession of Edward VI. he was appointed king's printer, an office which he retained throughout the reign. In this capacity he produced *The Booke of the Common Praier and Administration of the Sacramentes, and other Rites and Ceremonies of the Church: after the Use of the Church of Englande* (1549 fol.), and *Actes of Parliament* (1552 and 1553). In 1553 he printed Lady Jane Grey's proclamation and signed himself the queen's printer. For this he was imprisoned for a short time, and he seems thereafter to have retired from active business. His historical works include a continuation (1543) of Hardyng's *Chronicle* from the beginning of the reign of Edward IV. down to Grafton's own times. He is said to have taken considerable liberties with the original, and may practically be regarded as responsible for the whole work. He printed in 1548 Edward Hall's *Union of the . . . Families of Lancaster and Yorke*, adding the history of the years from 1532 to 1547. After he retired from the printing business he published *An Abridgement of the Chronicles of England* (1562), *Manuell of the Chronicles of England* (1565), *Chronicle at large and meere Historie of the Affayres of England* (1568). In these books he chiefly adapted the work of his predecessors, but in some cases he gives detailed accounts of contemporary events. His name frequently appears

in the records of St Bartholemew's and Christ's hospitals, and in 1553 he was treasurer-general of the hospitals of King Edward's foundation. In 1553-1554 and 1556-1557 he represented the City in Parliament, and in 1562-1563 he sat for Coventry.

An elaborate account of Grafton was written in 1901 by Mr J. A. Kingdon under the auspices of the Grocers' Company, with the title *Richard Grafton, Citizen and Grocer of London, &c.*, in continuation of *Incidents in the Lives of T. Poynts and R. Grafton* (1895). His *Chronicle at large* was reprinted by Sir Henry Ellis in 1809.

GRAFTON, a city of Clarence county, New South Wales, lying on both sides of the Clarence river, at a distance of 45 m. from its mouth, 342 m. N.E. of Sydney by sea. Pop. (1901) 4174, South Grafton, 976. The two sections, North Grafton and South Grafton, form separate municipalities. The river is navigable from the sea to the town for ships of moderate burden, and for small vessels to a point 35 m. beyond it. The entrance to the river has been artificially improved. Grafton is the seat of the Anglican joint-bishopric of Grafton and Armidale, and of a Roman Catholic bishopric created in 1888, both of which have fine cathedrals. Dairy-farming and sugar-growing are important industries, and there are several sugar-mills in the neighbourhood; great numbers of horses, also, are bred for the Indian and colonial markets. Tobacco, cereals and fruits are also grown. Grafton has a large shipping trade with Sydney. There is rail-connexion with Brisbane, &c. The city became a municipality in 1859.

GRAFTON, a township in the S.E. part of Worcester county, Massachusetts, U.S.A. Pop. (1905) 9052; (1910) 5705. It is served by the New York, New Haven & Hartford, and the Boston & Albany railways, and by interurban electric lines. The township contains several villages (including Grafton, North Grafton, Saundersville, Fisherville and Farnumville); the principal village, Grafton, is about 7 m. S.E. of Worcester. The villages are residential suburbs of Worcester, and attract many summer residents. In the village of Grafton there is a public library. There is ample water-power, from the Blackstone river and its tributaries, and among the manufactures of Grafton are cotton-goods, boots, and shoes, &c. Within what is now Grafton stood the Nipmuck Indian village of Hassanamait. John Eliot, the "apostle to the Indians," visited it soon after 1651, and organized the third of his bands of "praying Indians" there; in 1671 he established a church for them, the second of the kind in New England, and also a school. In 1654 the Massachusetts General Court granted to the Indians, for their exclusive use, a tract of about 4 sq. m., of which they remained the sole proprietors until 1718, when they sold a small farm to Elisha Johnson, the first permanent white settler in the neighbourhood. In 1728 a group of residents of Marlboro, Sudbury, Concord and Stowe, with the permission of the General Court, bought from the Indians 7500 acres of their lands, and agreed to establish forty English families on the tract within three years, and to maintain a church and school of which the Indians should have free use. The township was incorporated in 1735, and was named in honour of the 2nd duke of Grafton. The last of the pure-blooded Indians died about 1825.

GRAFTON, a city and the county-seat of Taylor county, West Virginia, U.S.A., on Tygart river, about 100 m. by rail S.E. of Wheeling. Pop. (1890) 3159; (1900) 5650, including 226 foreign-born and 162 negroes; (1910) 7563. It is served by four divisions of the Baltimore & Ohio railway, which maintains extensive car shops here. The city is about 1000 ft. above sea-level. It has a small national cemetery, and about 4 m. W., at Pruntytown, is the West Virginia Reform School. Grafton is situated near large coal-fields, and is supplied with natural gas. Among its manufactures are machine-shop and foundry products, window glass and pressed glass ware, and grist mill and planing-mill products. The first settlement was made about 1852, and Grafton was incorporated in 1856 and chartered as a city in 1899. In 1903 the population and area of the city were increased by the annexation of the town of Fetterman (pop. in 1900, 796), of Braumont (unincorporated), and of other territory.

GRAHAM, SIR GERALD (1831-1899), British general, was born on the 27th of June 1831 at Acton, Middlesex. He was

educated at Dresden and Woolwich Academy, and entered the Royal Engineers in 1850. He served with distinction through the Russian War of 1854 to 1856, was present at the battles of the Alma and Inkerman, was twice wounded in the trenches before Sevastopol, and was awarded the Victoria Cross for gallantry at the attack on the Redan and for devoted heroism on numerous occasions. He also received the Legion of Honour, and was promoted to a brevet majority. In the China War of 1860 he took part in the actions of Sin-ho and Tang-ku, the storming of the Taku Forts, where he was severely wounded, and the entry into Peking (brevet lieutenant-colonelcy and C.B.). Promoted colonel in 1860, he was employed in routine duties until 1877, when he was appointed assistant-director of works for barracks at the war office, a position he held until his promotion to major-general in 1881. In command of the advanced force in Egypt in 1882, he bore the brunt of the fighting, was present at the action of Magfar, commanded at the first battle of Kassassin, took part in the second, and led his brigade at Tell-el-Kebir. For his services in the campaign he received the K.C.B. and thanks of parliament. In 1884 he commanded the expedition to the eastern Sudan, and fought the successful battles of El Teb and Tamai. On his return home he received the thanks of parliament and was made a lieutenant-general for distinguished service in the field. In 1885 he commanded the Suakin expedition, defeated the Arabs at Hashin and Tamai, and advanced the railway from Suakin to Otao, when the expedition was withdrawn (thanks of parliament and G.C.M.G.). In 1896 he was made G.C.B., and in 1899 colonel-commandant Royal Engineers. He died on the 17th of December 1899. He published in 1875 a translation of Goetz's *Operations of the German Engineers in 1870-1871*, and in 1887 *Last Words with Gordon*.

GRAHAM, SIR JAMES ROBERT GEORGE, Bart. (1792-1861), British statesman, son of a baronet, was born at Naworth, Cumberland, on the 1st of June 1792, and was educated at Westminster and Oxford. Shortly after quitting the university, while making the "grand tour" abroad, he became private secretary to the British minister in Sicily. Returning to England in 1818 he was elected to parliament as member for Hull in the Whig interest; but he was unseated at the election of 1820. In 1824 he succeeded to the baronetcy; and in 1826 he re-entered parliament as representative for Carlisle, a seat which he soon exchanged for the county of Cumberland. In the same year he published a pamphlet entitled "Corn and Currency," which brought him into prominence as a man of advanced Liberal opinions; and he became one of the most energetic advocates in parliament of the Reform Bill. On the formation of Earl Grey's administration he received the post of first lord of the admiralty, with a seat in the cabinet. From 1832 to 1837 he sat for the eastern division of the county of Cumberland. Disensions on the Irish Church question led to his withdrawal from the ministry in 1834, and ultimately to his joining the Conservative party. Rejected by his former constituents in 1837, he was in 1838 elected for Pembroke, and in 1841 for Dorchester. In the latter year he took office under Sir Robert Peel as secretary of state for the home department, a post he retained until 1846. As home secretary he incurred considerable odium in Scotland, by his unconciliating policy on the church question prior to the "disruption" of 1843; and in 1844 the detention and opening of letters at the post-office by his warrant raised a storm of public indignation, which was hardly allayed by the favourable report of a parliamentary committee of investigation. From 1846 to 1852 he was out of office; but in the latter year he joined Lord Aberdeen's cabinet as first lord of the admiralty, in which capacity he acted also for a short time in the Palmerston ministry of 1855. The appointment of a select committee of inquiry into the conduct of the Russian war ultimately led to his withdrawal from official life. He continued as a private member to exercise a considerable influence on parliamentary opinion. He died at Netherby, Cumberland, on the 25th of October 1861.

His *Life*, by C. S. Parker, was published in 1907.

GRAHAM, SYLVESTER (1794-1851), American dietician, was born in Suffield, Connecticut, in 1794. He studied at Amherst College, and was ordained to the Presbyterian ministry in 1826, but he seems to have preached but little. He became an ardent advocate of temperance reform and of vegetarianism, having persuaded himself that a flesh diet was the cause of abnormal cravings. His last years were spent in retirement and he died at Northampton, Massachusetts, on the 11th of September 1851. His name is now remembered because of his advocacy of unbolted (Graham) flour, and as the originator of "Graham bread." But his reform was much broader than this. He urged, primarily, physiological education, and in his *Science of Human Life* (1836; republished, with biographical memoir, 1858) furnished an exhaustive text-book on the subject. He had carefully planned a complete regimen including many details besides a strict diet. A Temperance (or Graham) Boarding House was opened in New York City about 1832 by Mrs Asenath Nicholson, who published *Nature's Own Book* (2nd ed., 1835) giving Graham's rules for boarders; and in Boston a Graham House was opened in 1837 at 23 Brattle Street.

There were many Grahamites at Brook Farm, and the American Physiological Society published in Boston in 1837 and 1838 a weekly called *The Graham Journal of Health and Longevity*, designed to illustrate by facts and sustain by reason and principles the science of human life as taught by Sylvester Graham, edited by David Campbell. Graham wrote *Essay on Cholera* (1832); *The Esculapian Tablets of the Nineteenth Century* (1834); *Lectures to Young Men on Chastity* (2nd ed., 1837); and *Bread and Bread Making*; and projected a work designed to show that his system was not counter to the Holy Scriptures.

GRAHAM, THOMAS (1805-1869), British chemist, born at Glasgow on the 20th of December 1805, was the son of a merchant of that city. In 1819 he entered the university of Glasgow with the intention of becoming a minister of the Established Church. But under the influence of Thomas Thomson (1773-1852), the professor of chemistry, he developed a taste for experimental science and especially for molecular physics, a subject which formed his main preoccupation throughout his life. After graduating in 1824, he spent two years in the laboratory of Professor T. C. Hope at Edinburgh, and on returning to Glasgow gave lessons in mathematics, and subsequently chemistry, until the year 1829, when he was appointed lecturer in the Mechanics' Institute. In 1830 he succeeded Dr Andrew Ure (1778-1857) as professor of chemistry in the Andersonian Institution, and in 1837, on the death of Dr Edward Turner, he was transferred to the chair of chemistry in University College, London. There he remained till 1855, when he succeeded Sir John Herschel as Master of the Mint, a post he held until his death on the 16th of September 1869. The onerous duties his work at the Mint entailed severely tried his energies, and in quitting a purely scientific career he was subjected to the cares of official life, for which he was not fitted by temperament. The researches, however, which he conducted between 1861 and 1869 were as brilliant as any of those in which he engaged. Graham was elected a fellow of the Royal Society in 1836, and a corresponding member of the Institute of France in 1847, while Oxford made him a D. C. L. in 1855. He took a leading part in the foundation of the London Chemical and the Cavendish societies, and served as first president of both, in 1841 and 1846. Towards the close of his life the presidency of the Royal Society was offered him, but his failing health caused him to decline the honour.

Graham's work is remarkable at once for its originality and for the simplicity of the methods employed in obtaining most important results. He communicated papers to the Philosophical Society of Glasgow before the work of that society was recorded in *Transactions*, but his first published paper, "On the Absorption of Gases by Liquids," appeared in the *Annals of Philosophy* for 1826. The subject with which his name is most prominently associated is the diffusion of gases. In his first paper on this subject (1829) he thus summarizes the knowledge experiment had afforded as to the laws which regulate the movement of gases. "Fruitful as the miscibility of gases has been in interesting speculations, the experimental information we possess

on the subject amounts to little more than the well-established fact that gases of a different nature when brought into contact do not arrange themselves according to their density, but they spontaneously diffuse through each other so as to remain in an intimate state of mixture for any length of time." For the fissured jar of J. W. Döbereiner he substituted a glass tube closed by a plug of plaster of Paris, and with this simple appliance he developed the law now known by his name "that the diffusion rate of gases is inversely as the square root of their density." (See DIFFUSION.) He further studied the passage of gases by transpiration through fine tubes, and by effusion through a minute hole in a platinum disk, and was enabled to show that gas may enter a vacuum in three different ways: (1) by the molecular movement of diffusion, in virtue of which a gas penetrates through the pores of a disk of compressed graphite; (2) by effusion through an orifice of sensible dimensions in a platinum disk the relative times of the effusion of gases in mass being similar to those of the molecular diffusion, although a gas is usually carried by the former kind of impulse with a velocity many thousand times as great as is demonstrable by the latter; and (3) by the peculiar rate of passage due to transpiration through fine tubes, in which the ratios appear to be in direct relation with no other known property of the same gases—thus hydrogen has exactly double the transpiration rate of nitrogen, the relation of those gases as to density being as 1:14. He subsequently examined the passage of gases through septa or partitions of india-rubber, unglazed earthenware and plates of metals such as palladium, and proved that gases pass through these septa neither by diffusion nor effusion nor by transpiration, but in virtue of a selective absorption which the septa appear to exert on the gases in contact with them. By this means ("atmolytic") he was enabled partially to separate oxygen from air.

His early work on the movements of gases led him to examine the spontaneous movements of liquids, and as a result of the experiments he divided bodies into two classes—crystalloids, such as common salt, and colloids, of which gum-arabic is a type—the former having high and the latter low diffusibility. He also proved that the process of liquid diffusion causes partial decomposition of certain chemical compounds, the potassium sulphate, for instance, being separated from the aluminium sulphate in alum by the higher diffusibility of the former salt. He also extended his work on the transpiration of gases to liquids, adopting the method of manipulation devised by J. L. M. Poiseuille. He found that dilution with water does not effect proportionate alteration in the transpiration velocities of different liquids, and a certain determinable degree of dilution retards the transpiration velocity.

With regard to Graham's more purely chemical work, in 1833 he showed that phosphoric anhydride and water form three distinct acids, and he thus established the existence of polybasic acids, in each of which one or more equivalents of hydrogen are replaceable by certain metals (see ACID). In 1835 he published the results of an examination of the properties of water of crystallization as a constituent of salts. Not the least interesting part of this inquiry was the discovery of certain definite salts with alcohol analogous to hydrates, to which the name of alcoholates was given. A brief paper entitled "Speculative Ideas on the Constitution of Matter" (1863) possesses special interest in connexion with work done since his death, because in it he expressed the view that the various kinds of matter now recognized as different elementary substances may possess one and the same ultimate or atomic molecule in different conditions of movement.

Graham's *Elements of Chemistry*, first published in 1833, went through several editions, and appeared also in German, remodelled under J. Otto's direction. His *Chemical and Physical Researches* were collected by Dr James Young and Dr Angus Smith, and printed "for presentation only" at Edinburgh in 1876, Dr Smith contributing to the volume a valuable preface and analysis of its contents. See also T. E. Thorpe, *Essays in Historical Chemistry* (1902).

GRAHAME, JAMES (1765-1811), Scottish poet, was born in Glasgow on the 22nd of April 1765, the son of a successful lawyer. After completing his literary course at Glasgow univer-

sity, Grahame went in 1784 to Edinburgh, where he qualified as writer to the signet, and subsequently for the Scottish bar, of which he was elected a member in 1795. But his preferences had always been for the Church, and when he was forty-four he took Anglican orders, and became a curate first at Shipton, Gloucestershire, and then at Sedgfield, Durham. His works include a dramatic poem, *Mary Queen of Scots* (1801), *The Sabbath* (1804), *British Georgics* (1804), *The Birds of Scotland* (1806), and *Poems on the Abolition of the Slave Trade* (1810). His principal work, *The Sabbath*, a sacred and descriptive poem in blank verse, is characterized by devotional feeling and by happy delineation of Scottish scenery. In the notes to his poems he expresses enlightened views on popular education, the criminal law and other public questions. He was emphatically a friend of humanity—a philanthropist as well as a poet. He died in Glasgow on the 14th of September 1811.

GRAHAM'S DYKE (or *SÆUGH*—trench), a local name for the Roman fortified frontier, consisting of rampart, forts and road, which ran across the narrow isthmus of Scotland from the Forth to the Clyde (about 36 m.), and formed from A.D. 140 till about 185 the northern frontier of Roman Britain. The name is locally explained as recording a victorious assault on the defences by one Robert Graham and his men; it has also been connected with the Grampian Hills and the Latin surveying term *groma*. But, as is shown by its earliest recorded spelling, *Grymsdyke* (Fordun, A.D. 1385), it is the same as the term *Grim's Ditch* which occurs several times in England in connexion with early ramparts—for example, near Wallingford in south Oxfordshire or between Berkhamstead (Herts) and Bradenham (Bucks). Grim seems to be a Teutonic god or devil, who might be credited with the wish to build earthworks in unreasonably short periods of time. By antiquaries the Graham's Dyke is usually styled the Wall of Pius or the Antonine Vallum, after the emperor Antoninus Pius, in whose reign it was constructed. See further **BRITAIN: Roman**. (F. J. H.)

GRAHAM'S TOWN, a city of South Africa, the administrative centre for the eastern part of the Cape province, 106 m. by rail N.E. of Port Elizabeth and 43 m. by rail N.N.W. of Port Alfred. Pop. (1904) 13,887, of whom 7283 were whites and 1837 were electors. The town is built in a basin of the grassy hills forming the spurs of the Zuurberg, 1760 ft. above sea-level. It is a pleasant place of residence, has a remarkably healthy climate, and is regarded as the most English-like town in the Cape. The streets are broad, and most of them lined with trees. In the High Street are the law courts, the Anglican cathedral of St George, built from designs by Sir Gilbert Scott, and Commemoration Chapel, the chief place of worship of the Wesleyans, erected by the British emigrants of 1820. The Roman Catholic cathedral of St Patrick, a Gothic building, is to the left of the High Street. The town hall, also in the Gothic style, has a square clock tower built on arches over the pavement. Graham's Town is one of the chief educational centres in the Cape province. Besides the public schools and the Rhodes University College (which in 1904 took over part of the work carried on since 1855 by St Andrew's College), scholastic institutions are maintained by religious bodies. The town possesses two large hospitals, which receive patients from all parts of South Africa, and the government bacteriological institute. It is the centre of trade for an extensive pastoral and agricultural district. Owing to the sour quality of the herbage in the surrounding *suurveld*, stock-breeding and wool-growing have been, however, to some extent replaced by ostrich-farming, for which industry Graham's Town is the most important entrepôt. Dairy farming is much practised in the neighbourhood.

In 1812 the site of the town was chosen as the headquarters of the British troops engaged in protecting the frontier of Cape Colony from the inroads of the Kaffirs, and it was named after Colonel John Graham (1778-1821), then commanding the forces. (Graham had commanded the light infantry battalion at the taking of the Cape by the British in the action of the 6th of January 1806. He also took part in campaigns in Italy and Holland during the Napoleonic wars.) In 1819 an attempt was

made by the Kafirs to surprise Graham's Town, and 10,000 men attacked it, but they were repulsed by the garrison, which numbered not more than 320 men, infantry and artillery, under Lieut.-Colonel (afterwards General Sir) Thomas Willshire. In 1822 the town was chosen as the headquarters of the 4000 British immigrants who had reached Cape Colony in 1820. It has maintained its position as the most important inland town of the eastern part of the Cape province. In 1864 the Cape parliament met in Graham's Town, the only instance of the legislature sitting elsewhere than in Cape Town. It is governed by a municipality. The rateable value in 1906 was £891,536 and the rate levied 2½d. in the pound.

See T. Sheffield, *The Story of the Settlement . . .* (2nd ed., Graham's Town, 1884); C. T. Campbell, *British South Africa . . . with notices of some of the British Settlers of 1820* (London, 1897).

GRAIL, THE HOLY, the famous talisman of Arthurian romance, the object of quest on the part of the knights of the Round Table. It is mainly, if not wholly, known to English readers through the medium of Malory's translation of the French *Quête du Saint Graal*, where it is the cup or chalice of the Last Supper, in which the blood which flowed from the wounds of the crucified Saviour has been miraculously preserved. Students of the original romances are aware that there is in these texts an extraordinary diversity of statement as to the nature and origin of the Grail, and that it is extremely difficult to determine the precise value of these differing versions.¹ Broadly speaking the Grail romances have been divided into two main classes: (1) those dealing with the search for the Grail, the *Quest*, and (2) those relating to its early history. These latter appear to be dependent on the former, for whereas we may have a *Quest* romance without any insistence on the previous history of the Grail, that history is never found without some allusion to the hero who is destined to bring the quest to its successful termination. The *Quest* versions again fall into three distinct classes, differentiated by the personality of the hero who is respectively Gawain, Perceval or Galahad. The most important and interesting group is that connected with Perceval, and he was regarded as the original Grail hero, Gawain being, as it were, his understudy. Recent discoveries, however, point to a different conclusion, and indicate that the *Gawain* stories represent an early tradition, and that we must seek in them rather than in the *Perceval* versions for indications as to the ultimate origin of the Grail.

The character of this talisman or relic varies greatly, as will be seen from the following summary.

1. **GAWAIN**, included in the continuation to Chrétien's *Perceval* by Wauchier de Denain, and attributed to Bleheris the Welshman, who is probably identical with the Bledhericus of Giraldus Cambrensis, and considerably earlier than Chrétien de Troyes. Here the Grail is a food-providing, self-acting talisman, the precise nature of which is not specified; it is designated as the "rich" Grail, and serves the king and his court *sans serjant et sans seneschal*, the butlers providing the guests with wine. In another version, given at an earlier point of the same continuation, but apparently deriving from a later source, the Grail is borne in procession by a weeping maiden, and is called the "holy" Grail, but no details as to its history or character are given. In a third version, that of *Dieu Crône*, a long and confused romance, the origin of which has not been determined, the Grail appears as a reliquary, in which the Host is presented to the king, who once a year partakes alike of it and of the blood which flows from the lance. Another account is given in the prose *Lancelot*, but here Gawain has been deposed from his post as first hero of the court, and, as is to be expected from the treatment meted out to him in this romance, the visit ends in his complete discomfiture. The Grail is here surrounded with the atmosphere of awe and reverence familiar to us through the

¹ The etymology of the O. Fr. *grail* or *grail*, of which "grail" is an adaptation, has been much discussed. The Low Lat. original, *gradale* or *grasale*, a flat dish or platter, has generally been taken to represent a diminutive *cratella* of *crater*, bowl, or a lost *cratale*, formed from the same word (see W. W. Skeat, Preface to *Joseph of Arimathea*, Early Eng. Text Soc.).—Ed.

Quête, and is regarded as the chalice of the Last Supper. These are the *Gawain* versions.

2. **PERCEVAL**.—The most important *Perceval* text is the *Conte del Graal*, or *Perceval le Galois* of Chrétien de Troyes. Here the Grail is wrought of gold richly set with precious stones; it is carried in solemn procession, and the light issuing from it extinguishes that of the candles. What it is is not explained, but inasmuch as it is the vehicle in which is conveyed the Host on which the father of the Fisher king depends for nutriment, it seems not improbable that here, as in *Dieu Crône*, it is to be understood as a reliquary. In the *Parzival* of Wolfram von Eschenbach, the ultimate source of which is identical with that of Chrétien, on the contrary, the Grail is represented as a precious stone, brought to earth by angels, and committed to the guardianship of the Grail king and his descendants. It is guarded by a body of chosen knights, or templars, and acts alike as a life and youth preserving talisman—no man may die within eight days of beholding it, and the maiden who bears it retains perennial youth—and an oracle choosing its own servants, and indicating whom the Grail king shall wed. The sole link with the Christian tradition is the statement that its virtue is renewed every Good Friday by the agency of a dove from heaven. The discrepancy between this and the other Grail romances is most startling.

In the short prose romance known as the "Didot" *Perceval* we have, for the first time, the whole history of the relic logically set forth. The *Perceval* forms the third and concluding section of a group of short romances, the two preceding being the *Joseph of Arimathea* and the *Merlin*. In the first we have the precise history of the Grail, how it was the dish of the Last Supper, confided by our Lord to the care of Joseph, whom he miraculously visited in the prison to which he had been committed by the Jews. It was subsequently given by Joseph to his brother-in-law Brons, whose grandson Perceval is destined to be the final winner and guardian of the relic. The *Merlin* forms the connecting thread between this definitely ecclesiastical romance and the chivalric atmosphere of Arthur's court; and finally, in the *Perceval*, the hero, son of Alain and grandson to Brons, is warned by Merlin of the quest which awaits him and which he achieves after various adventures.

In the *Perlesvaus* the Grail is the same, but the working out of the scheme is much more complex; a son of Joseph of Arimathea, Joseph, is introduced, and we find a spiritual knighthood similar to that used so effectively in the *Parzival*.

3. **GALAHAD**.—The *Quête du Saint Graal*, the only romance of which Galahad is the hero, is dependent on and a completion of the *Lancelot* development of the Arthurian cycle. Lancelot, as lover of Guinevere, could not be permitted to achieve so spiritual an emprise, yet as leading knight of Arthur's court it was impossible to allow him to be surpassed by another. Hence the invention of Galahad, son to Lancelot by the Grail king's daughter, predestined by his lineage to achieve the quest, foredoomed, the quest achieved, to vanish, a sacrifice to his father's fame, which, enhanced by connexion with the Grail-winner, could not risk eclipse by his presence. Here the Grail, the chalice of the Last Supper, is at the same time, as in the *Gawain* stories, self-acting and food-supplying.

The last three romances unite, it will be seen, the quest and the early history. Introductory to the Galahad quest, and dealing only with the early history, is the *Grand Saint Graal*, a work of interminable length, based upon the *Joseph of Arimathea*, which has undergone numerous revisions and amplifications: its precise relation to the *Lancelot*, with which it has now much matter in common, is not easy to determine.

To be classed also under the head of early history are certain interpolations in the MSS. of the *Perceval*, where we find the *Joseph* tradition, but in a somewhat different form, e.g. he is said to have caused the Grail to be made for the purpose of receiving the holy blood. With this account is also connected the legend of the *Volto Santo* of Lucca, a crucifix said to have been carved by Nicodemus. In the conclusion to Chrétien's poem, composed by Manessier some fifty years later, the Grail is said to have followed Joseph to Britain, how, is not explained.

Another continuation by Gerbert, interpolated between those of Wauchier and Manessier, relates how the Grail was brought to Britain by Perceval's mother in the companionship of Joseph.

It will be seen that with the exception of the *Grand Saint Graal*, which has now been practically converted into an introduction to the *Quête*, no two versions agree with each other; indeed, with the exception of the oldest *Gawain-Grail* visit, that due to Bleheris, they do not agree with themselves, but all show, more or less, the influence of different and discordant versions. Why should the vessel of the Last Supper, jealously guarded at Castle Corbenic, visit Arthur's court independently? Why does a sacred relic provide purely material food? What connexion can there be between a precious stone, a *baetylus*, as Dr Hagen has convincingly shown, and Good Friday? These, and such questions as these, suggest themselves at every turn.

Numerous attempts have been made to solve these problems, and to construct a theory of the origin of the Grail story, but so far the difficulty has been to find an hypothesis which would admit of the practically simultaneous existence of apparently contradictory features. At one time considered as an introduction from the East, the theory of the Grail as an Oriental talisman has now been discarded, and the expert opinion of the day may be said to fall into two groups: (1) those who hold the Grail to have been from the first a purely Christian vessel which has accidentally, and in a manner never clearly explained, acquired certain folk-lore characteristics; and (2) those who hold, on the contrary, that the Grail is *aborigine* folk-lore and Celtic, and that the Christian development is a later and accidental rather than an essential feature of the story. The first view is set forth in the work of Professor Birch-Hirschfeld, the second in that of Mr Alfred Nutt, the two constituting the only *travaux d'ensemble* which have yet appeared on the subject. It now seems probable that both are in a measure correct, and that the ultimate solution will be recognized to lie in a blending of two originally independent streams of tradition. The researches of Professor Mannhardt in Germany and of J. G. Frazer in England have amply demonstrated the enduring influence exercised on popular thought and custom by certain primitive forms of vegetation worship, of which the most noteworthy example is the so-called mysteries of Adonis. Here the ordinary processes of nature and progression of the seasons were symbolized under the figure of the death and resuscitation of the god. These rites are found all over the world, and in his monumental work, *The Golden Bough*, Dr Frazer has traced a host of extant beliefs and practices to this source. The earliest form of the Grail story, the *Gawain-Bleheris* version, exhibits a marked affinity with the characteristic features of the Adonis or Tammuz worship; we have a castle on the sea-shore, a dead body on a bier, the identity of which is never revealed, mourned over with solemn rites; a wasted country, whose desolation is mysteriously connected with the dead man, and which is restored to fruitfulness when the quester asks the meaning of the marvels he beholds (the two features of the weeping women and the wasted land being retained in versions where they have no significance); finally the mysterious food-providing, self-acting talisman of a common feast—one and all of these features may be explained as survivals of the Adonis ritual. Professor Martin long since suggested that a key to the problems of the Arthurian cycle was to be found in a nature myth: Professor Rhys regards Arthur as an agricultural hero; Dr Lewis Mott has pointed out the correspondence between the so-called Round Table sites and the ritual of nature worship; but it is only with the discovery of the existence of Bleheris as reputed authority for Arthurian tradition, and the consequent recognition that the Grail story connected with his name is the earliest form of the legend, that we have secured a solid basis for such theories.

With regard to the religious form of the story, recent research has again aided us—we know now that a legend similar in all respects to the Joseph of Arimathea Grail story was widely current at least a century before our earliest Grail texts. The story with Nicodemus as protagonist is told of the *Saint-Sang* relic at Fécamp; and, as stated already, a similar origin is

ascribed to the *Volto Santo* at Lucca. In this latter case the legend professes to date from the 8th century, and scholars who have examined the texts in their present form consider that there may be solid ground for this attribution. It is thus demonstrable that the material for our Grail legend, in its present form, existed long anterior to any extant text, and there is no improbability in holding that a confused tradition of pagan mysteries which had assumed the form of a popular folk-tale, became finally Christianized by combination with an equally popular ecclesiastical legend, the point of contact being the vessel of the common ritual feast. Nor can there be much doubt that in this process of combination the Fécamp legend played an important rôle. The best and fullest of the *Perceval* MSS. refer to a book written at Fécamp as source for certain *Perceval* adventures. What this book was we do not know, but in face of the fact that certain special Fécamp relics, silver knives, appear in the Grail procession of the *Parzival*, it seems most probable that it was a *Perceval-Grail* story. The relations between the famous Benedictine abbey and the English court both before and after the Conquest were of an intimate character. Legends of the part played by Joseph of Arimathea in the conversion of Britain are closely connected with Glastonbury, the monks of which foundation showed, in the 12th century, considerable literary activity, and it seems a by no means improbable hypothesis that the present form of the Grail legend may be due to a monk of Glastonbury elaborating ideas borrowed from Fécamp. This much is certain, that between the *Saint-Sang* of Fécamp, the *Volto Santo* of Lucca, and the Grail tradition, there exists a connecting link, the precise nature of which has yet to be determined. The two former were popular objects of pilgrimage; was the third originally intended to serve the same purpose by attracting attention to the reputed burial-place of the apostle of the Grail, Joseph of Arimathea?

BIBLIOGRAPHY.—For the Gawain Grail visits see the Potvin edition of the *Perceval*, which, however, only gives the Bleheris version; the second visit is found in the best and most complete MSS., such as 12,576 and 12,577 (*Fonds français*) of the Paris library. *Diu Crône*, edited by Scholl (Stuttgart, 1852), vol. vi. of *Arthurian Romances* (Nutt), gives a translation of the Bleheris, *Diu Crône* and *Prose Lancelot* visits.

The *Conte del Graal*, or *Perceval*, is only accessible in the edition of M. Potvin (6 vols., 1866-1871). The Mons MS., from which this has been printed, has proved to be an exceedingly poor and untrustworthy text. *Parzival*, by Wolfram von Eschenbach, has been frequently and well edited; the edition by Bartsch (1875-1877), in *Deutsche Classiker des Mittelalters*, contains full notes and a glossary. Suitable for the more advanced student are those by K. Lachmann (1891), Leitzmann (1902-1903) and E. Martin (1903). There are modern German translations by Simrock (very close to the original) and Hertz (excellent notes). English translation with notes and appendices by J. L. Weston. "Didot" *Perceval*, ed. Hucher, *Le Saint Graal* (1875-1878), vol. 1. *Perlesvaas* was printed by Potvin, under the title of *Perceval le Gallois*, in vol. 1. of the edition above referred to; a Welsh version from the Hengwrt MS. was published with translation by Canon R. Williams (2 vols., 1876-1892). Under the title of *The High History of the Holy Grail* a fine version was published by Dr Sebastian Evans in the Temple Classics (2 vols., 1898). The *Grand Saint Graal* was published by Hucher as given above; this edition includes the *Joseph of Arimathea*. A 15th century metrical English adaptation by one Henry Lovelich, was printed by Dr Furnivall for the Roxburghe Club 1861-1863; a new edition was undertaken for the Early English Text Society. *Quête du Saint Graal* can best be studied in Malory's somewhat abridged translation, books xiii.-xviii. of the *Morte Arthur*. It has also been printed by Dr Furnivall for the Roxburghe Club, from a MS. in the British Museum. Neither of these texts is, however, very good, and the student who can decipher old Dutch would do well to read it in the metrical translation published by Joenekbloet, *Roman van Lancelot*, as the original here was considerably fuller.

For general treatment of the subject see *Legend of Sir Perceval*, by J. L. Weston, Grimm Library, vol. xvii. (1906); *Studies on the Legend of the Holy Grail*, by A. Nutt (1888), and a more concise treatment of the subject by the same writer in No. 14 of *Popular Studies* (1902); Professor Birch-Hirschfeld's *Die Sage vom Graal* (1877). The late Professor Heintzel's *Die all-französischen Grail-Romane* contains a mass of valuable matter, but is very confused and ill-arranged. For the Fécamp legend see Leroux de Lincey's *Essai sur l'abbaye de Fécamp* (1840); for the *Volto Santo* a. d. kindred legends, Ernest von Dobschütz, *Christus-Bilder* (Leipzig, 1899). (J. L. W.)

GRAIN (derived through the French from Lat. *granum*, seed, from an Aryan root meaning "to wear down," which also appears in the common Teutonic word "corn"), a word particularly applied to the seed, in botanical language the "fruit," of cereals, and hence applied, as a collective term to cereal plants generally, to which, in English, the term "corn" is also applied (see **GRAIN TRADE**). Apart from this, the chief meaning, the word is used of the malt refuse of brewing and distilling, and of many hard rounded small particles, resembling the seeds of plants, such as "grains" of sand, salt, gold, gunpowder, &c. "Grain" is also the name of the smallest unit of weight, both in the United Kingdom and the United States of America. Its origin is supposed to be the weight of a grain of wheat, dried and gathered from the middle of the ear. The troy grain = $\frac{1}{5760}$ of a lb, the avoirdupois grain = $\frac{1}{7000}$ of a lb. In diamond weighing the grain = $\frac{1}{4}$ of the carat, = $\cdot 7025$ of the troy grain. The word "grains" was early used, as also in French, of the small seed-like insects supposed formerly to be the berries of trees, from which a scarlet dye was extracted (see **COCHINEAL** and **KERMES**). From the Fr. *en grain*, literally in dye, comes the French verb *engrainer*, Eng. "engrain" or "ingrain," meaning to dye in any fast colour. From the further use of "grain" for the texture of substances, such as wood, meat, &c., "engrained" or "ingrained" means ineradicable, impregnated, dyed through and through. The "grain" of leather is the side of a skin showing the fibre after the hair has been removed. The imitating in paint of the grain of different kinds of woods is known as "graining" (see **PAINTER-WORK**). "Grain," or more commonly in the plural "grains," construed as a singular, is the name of an instrument with two or more barbed prongs, used for spearing fish. This word is Scandinavian in origin, and is connected with Dan. *græn*, Swed. *gren*, branch, and means the fork of a tree, of the body, or the prongs of a fork, &c. It is not connected with "groin," the inguinal parts of the body, which in its earliest forms appears as *grynde*.

GRAINS OF PARADISE, GUINEA GRAINS, or MELEGUETA PEPPER (Ger. *Paradieskörner*, Fr. *graines de Paradis, maniguette*), the seeds of *Amomum Melegueta*, a reed-like plant of the natural order *Zingiberaceae*. It is a native of tropical western Africa, and of Prince's and St Thomas's islands in the Gulf of Guinea, is cultivated in other tropical countries, and may with ease be grown in hothouses in temperate climates. The plant has a branched horizontal rhizome; smooth, nearly sessile, narrowly lanceolate-oblong alternate leaves; large, white, pale pink or purplish flowers; and an ovate-oblong fruit, ensheathed in bracts, which is of a scarlet colour when fresh, and reaches under cultivation a length of 5 in. The seeds are contained in the acid pulp of the fruit, are commonly wedge-shaped and bluntly angular, are about $1\frac{1}{2}$ lines in diameter and have a glossy dark-brown husk, with a conical light-coloured membranous aruncule at the base and a white kernel. They contain, according to Flückiger and Hanbury, 0.3% of a faintly yellowish neutral essential oil, having an aromatic, not acrid taste, and a specific gravity at 15.5° C. of 0.825, and giving on analysis the formula $C_{20}H_{22}O$, or $C_{12}H_{14} + C_{12}H_{14}O$; also 5.83% of an intensely pungent, viscid, brown resin.

Grains of paradise were formerly official in British pharmacopoeias, and in the 13th and succeeding centuries were used as a drug and a spice, the wine known as *hippocras* being flavoured with them and with ginger and cinnamon. In 1629 they were employed among the ingredients of the twenty-four herring pies which were the ancient fee-favour of the city of Norwich, ordained to be carried to court by the lord of the manor of Carleton (Johnston and Church, *Chem. of Common Life*, p. 355, 1879). Grains of paradise were anciently brought overland from West Africa to the Mediterranean ports of the Barbary states, to be shipped for Italy. They are now exported almost exclusively from the Gold Coast. Grains of paradise are to some extent used illegally to give a fictitious strength to malt liquors, gin and cordials. By 56 Geo. III. c. 58, no brewer or dealer in beer shall have in his possession or use grains of paradise, under a penalty of £200 for each offence; and no druggist shall

sell the same to a brewer under a penalty of £500. They are, however, devoid of any injurious physiological action, and are much esteemed as a spice by the natives of Guinea.

See Bentley and Trimen, *Medicinal Plants*, tab. 268; Lanessan, *Hist. des Drogues*, pp. 456-460 (1878).

GRAIN TRADE. The complexity of the conditions of life in the 20th century may be well illustrated from the grain trade of the world. The ordinary bread sold in Great Britain represents, for example, produce of nearly every country in the world outside the tropics.

Wheat has been cultivated from remote antiquity. In a wild state it is practically unknown. It is alleged to have been found growing wild between the Euphrates and the Tigris; but the discovery has never been authenticated, and, unless the plant be sedulously cared for, the species dies out in a surprisingly short space of time. Modern experiments in cross-fertilization in Lancashire by the Garton Brothers have evolved the most extraordinary "sports," showing, it is claimed, that the plant has probably passed through stages of which until the present day there had been no conception. The tales that grains of wheat found in the cerements of Egyptian mummies have been planted and come to maturity are no longer credited, for the vital principle in the wheat berry is extremely evanescent; indeed, it is doubtful whether wheat twenty years old is capable of reproduction. The Garton artificial fertilization experiments have shown endless deviations from the ordinary type, ranging from minute seeds with a closely adhering husk to big berries almost as large as sloes and about as worthless. It is conjectured that the wheat plant, as now known, is a degenerate form of something much finer which flourished thousands of years ago, and that possibly it may be restored to its pristine excellence, yielding an increase twice or thrice as large as it now does, thus postponing to a distant period the famine doom prophesied by Sir W. Crookes in his presidential address to the British Association in 1898. Wheat well repays careful attention; contrast the produce of a carelessly tilled Russian or Indian field and the bountiful yield on a good Lincolnshire farm, the former with its average yield of 8 bushels, the latter with its 50 bushels per acre; or compare the quality, as regards the quantity and flavour of the flour from a fine sample of British wheat, such as is on sale at almost every agricultural show in Great Britain, with the produce of an Egyptian or Syrian field; the difference is so great as to cause one to doubt whether the berries are of the same species.

It may be stated roundly that an average quarter loaf in Great Britain is made from wheat grown in the following countries in the proportions named:—

U.S.A.	U.K.	Russia	Argentina.	British India.	Canada	Russia-Bulgaria	Australia	Other Countries.
Oz. 26	Oz. 13	Oz. 9	Oz. 5	Oz. 4	Oz. 3	Oz. 2	Oz. 1	Oz. 1
40	Or 20	expressed in 14	in 8	percent 6	ages as 5	follows 3	— 2	— 2

For details connected with grain and its handling see **AGRICULTURE, CORN LAWS, GRANARIES, FLOUR, BAKING, WHEAT, &c.**

Wheat occupies of all cereals the widest region of any food-stuff. Rice, which shares with millet the distinction of being the principal food-stuff of the greatest number of human beings, is not grown nearly as widely as is wheat, the staple food of the white races. Wheat grows as far south as Patagonia, and as far north as the edge of the Arctic Circle; it flourishes throughout Europe, and across the whole of northern Asia and in Japan; it is cultivated in Persia, and raised largely in India, as far south as the Nizam's dominions. It is grown over nearly the whole of North America. In Canada a very fine wheat crop was raised in the autumn of 1898 as far north as the mission at Fort Providence, on the Mackenzie river, in a latitude above 62°—or less than 200 m. south of the latitude of Dawson City—the period between seed-time and harvest having been ninety-one

days. In Africa it was an article of commerce in the days of Jacob, whose son Joseph may be said to have run the first and only successful "corner" in wheat. For many centuries Egypt was famous as a wheat raiser; it was a cargo of wheat from Alexandria which St Paul helped to jettison on one of his shipwrecks, as was also, in all probability, that of the "ship of Alexandria, whose sign was Castor and Pollux," named in the same narrative. General Gordon is quoted as having stated that the Sudan if properly settled would be capable of feeding the whole of Europe. Along the north coast of Africa are areas which, if properly irrigated, as was done in the days of Carthage, could produce enough wheat to feed half of the Caucasian race. For instance, the vilayet of Tripoli, with an area of 400,000sq. m., or three times the extent of Great Britain and Ireland, according to the opinion of a British consul, could raise millions of acres of wheat. The cereal flourishes on all the high plateaus of South Africa, from Cape Town to the Zambesi. Land is being extensively put under wheat in the pampas of South America and in the prairies of Siberia.

In the raising of the standard of farming to an English level the volume of the world's crop would be trebled, another fact which Sir William Crookes seems to have overlooked. The experiments of the late Sir J. B. Lawes in Hertfordshire have proved that the natural fruitfulness of the wheat plant can be increased threefold by the application of the proper fertilizer. The results of these experiments will be found in a compendium issued from the Rothamsted Agricultural Experimental Station.

It is by no means, however, the wheat which yields the greatest number of bushels per acre which is the most valuable from a miller's standpoint, for the thinness of the bran and the fineness and strength of the flour are with him important considerations, too often overlooked by the farmer when buying his seed. Nevertheless it is the deficient quantity of the wheat raised in the British Islands, and not the quality of the grain, which has been the cause of so much anxiety to economists and statesmen.

Sir J. Caird, writing in the year 1880, expressed the opinion that arable land in Great Britain would always command a substantial rent of at least 30s. per acre. His figures

Freight rates. were based on the assumption that wheat was imported abroad duty free. He calculated that the cost of carriage from abroad of wheat, or the equivalent of the product of an acre of good wheat land in Great Britain, would not be less than 30s. per ton. But freights had come down by 1900 to half the rates predicated by Caird; indeed, during a portion of the interval they ruled very close to zero, as far as steamer freights from America were concerned. In 1900 an all-round freight rate for wheat might be taken at 15s. *per ton* (a ton representing approximately the produce of an acre of good wheat land in England), say from 10s. for Atlantic American and Russian, to 30s. for Pacific American and Australian; about midway between these two extremes we find Indian and Argentine, the greatest bulk coming at about the 15s. rate. Inferior land bearing less than 4½ quarters per acre would not be protected to the same extent, and moreover, seeing that a portion of the British wheat crop has to stand a charge as heavy for land carriage across a county as that borne by foreign wheat across a continent or an ocean, the protection is not nearly so substantial as Caird would make out. The compilation showing the changes in the rates of charges for the railway and other transportation services issued by the Division of Statistics, Department of Agriculture, U.S.A. (Miscellaneous series, Bulletin No. 15, 1898), is a valuable reference book. From its pages are culled the following facts relating to the changes in the rates of freight up to the year 1897.¹ In Table 3 the average rates per ton per mile in cents are shown since 1846. For the Fitchburg Railroad the rate for that year was 4.523 cents per ton per mile, since when a great and almost continuous fall has been taking place, until in 1897,

the latest year given, the rate had declined to .870 of a cent per ton per mile. The railway which shows the greatest fall is the Chesapeake & Ohio, for the charge has fallen from over 7 cents in 1862 and 1863 to .419 of a cent in 1897, whereas the Erie rates have fallen only from 1.948 in 1852 to .609 in 1897. Putting the rates of the twelve returning railways together, we find the average freight in the two years 1859-1860 was 3.006 cents per ton per mile, and that in 1896-1897 the average rate had fallen to .797 of a cent per ton per mile. This difference is very large compared with the smallness of the unit. Coming to the rates on grain, we find (in Table 23) a record for the forty years 1858-1897 of the charge on wheat from Chicago to New York, via all rail from 1858, and via lake and rail since 1868, the authority being the secretary of the Chicago Board of Trade. From 1858 to 1862 the rate varied between 42.37 and 34.80 cents per bushel for the whole trip of roundly 1000 m., the average rate in the quinquennium being 38.43. In the five years immediately prior to the time at which Sir J. Caird expressed the opinion that the cost of carriage from abroad would always protect the British grower, the average all-rail freight from Chicago to New York was 17.76 cents, while the summer rate (partly by water) was 13.17 cents. These rates in 1897, the last year shown on the table, had fallen to 12.50 and 7.42 respectively. The rates have been as follows in quinquennial periods, via all rail:—

Chicago to New York in Cents per Bushel.

1858-1862.	1863-1867.	1868-1872.	1873-1877.	1878-1882.	1883-1887.	1888-1892.	1893-1897.
38.43	31.42	27.91	21.29	16.77	14.67	14.52	12.88

Calculating roundly a cent as equal to a halfpenny, and eight bushels to the quarter, the above would appear in English currency as follows:—

Chicago to New York in Shillings and Pence per Quarter.

1858-1862.	1863-1867.	1868-1872.	1873-1877.	1878-1882.	1883-1887.	1888-1892.	1893-1897.
s. d. 12 8	s. d. 10 6	s. d. 9 3	s. d. 7 1	s. d. 5 7	s. d. 4 10½	s. d. 4 10	s. d. 4 3

Another table (No. 38) shows the average rates from Chicago to New York by lakes, canal and river. These in their quinquennial periods are given for the season as follows:—

In Cents per Bushel of 60 lb.

1857-1861.	1876-1880.	1893-1897.
22.15	10.47	4.92

In Shillings and Pence per Quarter of 480 lb.

1857-1861.	1876-1880.	1893-1897.
s. d. 7 4	s. d. 3 6	s. d. 1 7

In Shillings and Pence per Ton of 2240 lb.

1857-1861.	1876-1880.	1893-1897.
s. d. 34 6	s. d. 16 6	s. d. 7 6

This latter mode is the cheapest by which grain can be carried to the eastern seaboard from the American prairies, and it can now be done at a cost of 7s. 6d. per ton. The ocean freight has to be added before the grain can be delivered free on the quay at Liverpool. A rate from New York to Liverpool of 2½d. per bushel, or 7s. 10d. per ton, a low rate, reached in Dec. 1900, is yet sufficiently high, it is claimed, to leave a profit; indeed, there have frequently been times when the rate was as low as 1d. per bushel, or 3s. 1d. per ton; and in periods of great trade depression wheat is carried from New York to Liverpool as ballast, being paid for by the ship-owner. Another route worked more cheaply than formerly is that by river, from the centre of the winter wheat belt, say at St Louis, to New Orleans, and thence by steamer to Liverpool. The river rate has fallen below five

¹ Valuable information will also be found in Bulletin No. 38 (1903), "Crop Export Movement and Port Facilities on the Atlantic and Gulf Coasts"; in Bulletin No. 49 (1907), "Cost of Hauling Crops from Farms to Shipping Points"; and in Bulletin No. 69 (1908), "European Grain Trade."

GRAIN TRADE

cents per bushel, or 7s. per ton, 2240 lb. In Table No. 71 the cost of transportation is compared year by year with the export price of the two leading cereals in the States as follows:—

Wheat and Corn—Export Prices and Transportation Rates compared.

Year.	Wheat			Corn.		
	Export Price per Bushel.	Rate, Chicago to New York by Lake and Canal, per Bushel.	Number of Bushels carried for Price of One Bushel.	Export Price per Bushel.	Rate, Chicago to New York by Lake and Canal, per Bushel.	Number of Bushels carried for Price of One Bushel.
1867	\$0-02	15-95	5-77	\$0-72	14-58	4-94
1868	1-36	16-23	8-38	84-1	13-57	6-20
1869	1-05	17-20	6-10	72-8	14-98	4-86
1870	1-12	14-85	7-54	80-5	13-78	5-84
1871	1-18	17-75	6-65	67-9	16-53	4-11
1872	1-31	21-55	6-08	61-8	19-62	3-15
1873	1-15	16-89	6-81	54-3	15-39	3-53
1874	1-29	12-75	10-12	64-7	11-29	5-73
1875	97	9-90	9-80	73-8	8-93	8-26
1876	1-11	8-63	12-86	60-3	7-93	7-60
1877	1-12	10-76	10-41	56-0	9-41	5-95
1878	1-33	9-10	14-62	55-8	8-27	6-75
1879	1-07	11-60	9-22	47-1	10-43	4-52
1880	1-25	12-27	10-19	54-3	11-14	4-87
1881	1-11	8-19	13-55	55-2	7-26	7-60
1882	1-19	7-89	15-08	66-8	7-23	9-24
1883	1-13	8-37	13-50	68-4	7-66	8-93
1884	1-07	6-31	16-96	61-1	5-64	10-83
1885	86	5-87	14-65	54-0	5-38	10-04
1886	87	8-71	9-99	49-8	7-98	6-24
1887	89	8-51	10-46	47-9	7-88	6-08
1888	85	5-93	14-33	55-0	5-41	10-17
1889	90	6-89	13-06	47-4	6-19	7-66
1890	83	5-86	14-16	41-8	5-10	8-20
1891	93	5-96	15-60	57-4	5-36	10-71
1892	1-03	5-61	18-36	55	5-03	10-93
1893	80	6-31	12-68	53	5-71	9-28
1894	67	4-44	15-09	46	3-99	11-53
1895	58	4-11	14-11	53	3-71	14-29
1896	65	5-38	12-08	38	4-94	7-69
1897	75	4-35	17-24	31	3-79	8-18

The farmers of the United States have now to meet a greatly increased output from Canada—the cost of transport from that country to England being much the same as from the United States. So much improved is the position of the farmer in North America compared with what it was about 1870, that the transport companies in 1901 carried 17½ bushels of his grain to the seaboard in exchange for the value of one bushel, whereas in 1867 he had to give up one bushel in every six in return for the service. As regards the British farmer, it does not appear as if he had improved his position; for he has to send his wheat to greater distances, owing to the collapse of many country millers or their removal to the seaboard, while railway rates have fallen only to a very small extent; again the farmer's wheat is worth only half of what it was formerly; it may be said that the British farmer has to give up one bushel in nine to the railway company for the purpose of transportation, whereas in the 'seventies he gave up one in eighteen only. Enough has been said to prove that the advantage of position claimed for the British farmer by Caird was somewhat illusory. Speaking broadly, the Kansas or Minnesota farmer's wheat does not have to pay for carriage to Liverpool more than 2s. 6d. to 7s. 6d. per ton in excess of the rate paid by a Yorkshire farmer; this, it will be admitted, does not go very far towards enabling the latter to pay rent, tithes and rates and taxes.

The subject of the rates of ocean carriage at different periods requires consideration if a proper understanding of the working of the foreign grain trade is to be obtained. Only a very small proportion of the decline in the price of wheat since 1880 is due to cheapened transport rates; for while the mileage rate has been falling, the length of haulage has been extending, until in 1900 the principal wheat fields of America were 2000 m. farther from the eastern seaboard than was the case in 1870, and consequently, notwithstanding the fall in the mileage rate of 50 to 75%, it still costs the United Kingdom nearly as much to have its quota of foreign wheat fetched from abroad as it did

then. The difference in the cost of the operation is shown in the following tabular statement, both the cost in the aggregate on a year's imports and the cost per quarter:—

Quantity of Wheat and Wheat Flour (as wheat) imported into the United Kingdom from various sources during the calendar year 1900, together with the average rate of freight.

Countries of Origin.	1900.		
	Quantities. Qrs. 480 lb.	Ocean Freight to United Kingdom. Per 480 lb.	Total Cost of Ocean Carriage.
Atlantic America . . .	11,171,100	s. d.	£
South Russia . . .	569,000	2 3	1,257,100
Pacific America . . .	2,389,900	2 2	62,000
Canada . . .	1,877,100	8 1	966,000
Rumania . . .	9,176,400	2 8	250,000
Argentina and Uruguay . . .	4,322,300	2 6	21,000
France . . .	251,900	4 10	1,045,000
Bulgaria and Rumelia . . .	30,600	1 3	16,000
India . . .	2,200	2 6	4,000
Austria-Hungary . . .	389,300	2 0	400
Chile . . .	600	1 9	34,000
North Russia . . .	462,700	600	..
Germany . . .	438,700	1 6	35,000
Australasia . . .	883,900	1 6	33,000
Minor Countries . . .	225,100	6 5	284,000
Minor Countries . . .	225,100	2 6	28,000
Total . . .	23,190,800	Average 3s. 6d.	£4,036,500

Comparing these figures with a similar statement for the year 1872, the most remote year for which similar facts are available, it will be found that the actual total cost per quarter for ocean carriage has not much decreased.

Quantity of Wheat and Wheat Flour (as wheat) imported into the United Kingdom from various sources during the calendar year 1872, together with the average rate of freight.

Countries of Origin.	1872.		
	Quantities. Qrs.	Ocean Freight to United Kingdom. Per qr.	Total Cost of Carriage
South Russia . . .	3,678,000	s. d.	£
United States . . .	2,030,000	8 6	1,563,000
Germany . . .	910,000	6 6	659,000
France . . .	660,000	2 0	91,000
Egypt . . .	536,000	3 0	99,000
North Russia . . .	490,000	4 6	120,000
Canada . . .	400,000	2 0	49,000
Chile . . .	330,000	7 6	150,000
Turkey . . .	195,000	12 0	198,000
Spain . . .	130,000	7 6	72,000
Scandinavia . . .	160,000	3 6	23,000
Scandinavia . . .	160,000	2 0	16,000
Total, Chief Countries	9,519,000	Average 6s. 5d.	£3,040,000

N.B.—A trifling quantity of Californian and Australian wheat was imported in the period in question, but the Board of Trade records do not distinguish the quantities, therefore they cannot be given. The freight in that year from those countries averaged about 13s. per quarter.

The exact difference between the average freight for the years 1872 and 1900 amounts to about 2s. 11d. per quarter (480 lb), a trifle in comparison with the actual fall in the price of wheat during the same years.

The following data bearing upon the subject, for selected periods, are partly taken from the *Corn Trade Year-Book*:—

Year.	United Kingdom Annual Imports. Wheat and Flour. Qrs.	Ocean Freight to United Kingdom. Per qr.	Aggregate Cost of Carriage.
1872	9,469,000	s. d.	£
1882	14,850,000	6 5	3,040,000
1894	16,229,000	7 4	5,420,000
1895	25,197,000	3 9	3,041,000
1896	23,431,000	3 0	3,825,000
1897	23,431,000	2 9	3,258,000
1900	23,196,000	3 6	4,036,000

In passing, it may be pointed out that for a period of four years, from 1871 to 1874, the price of wheat averaged 56s. per quarter (or 7s. per bushel), with the charge for ocean carriage at 6s. 5d. per quarter, whereas in 1901 wheat was sold in England at 28s. (or 3s. 6d. per bushel), and the charge for ocean carriage was 3s. 6d. per quarter; the ocean transport companies carried eight bushels of wheat across the seas in 1901 for the value of one bushel, or exactly at the same ratio as in 1872.

The contrast between the case of railway freight and ocean freight is to be explained by the greater length of the present ocean voyage, which now extends to 10,000 miles in the case of Europe's importation of white wheat from the Pacific Coast of the United States and Australia, in contrast with the short voyage from the Black Sea or across the English Channel or German Ocean. It is largely due to the overlooking of this phase of the question that an American statistician has fallen into the error of stating that about 16s. per quarter of the fall in the price of wheat, which happened between 1880 and 1894, is attributable to the lessened cost of transport.

Thus, whatever the cause of the decline in the price of wheat may be, it cannot be attributed solely to the fall in the rate of

WHEAT PRICES

The following figures show the fluctuations from year to year of English wheat, chiefly according to a record published by Mr T. Smith, Melford, the period covered being from 1656 to 1905:

Price per Quarter

	s. d.	s. d.	s. d.	s. d.	s. d.	s. d.	s. d.	s. d.	s. d.		
1656	38	2	1706	23	1	1756	40	1	1806	79	1
1657	41	5	1707	25	4	1757	53	4	1807	75	4
1658	57	8	1708	36	10	1758	44	5	1808	84	4
1659	58	8	1709	29	7	1759	35	3	1809	97	4
1660	62	2	1710	69	4	1760	32	5	1810	106	3
1661	62	2	1711	48	0	1761	26	0	1811	95	3
1662	65	9	1712	41	2	1762	34	8	1812	126	6
1663	50	8	1713	45	4	1763	36	1	1813	109	9
1664	36	0	1714	44	9	1764	41	5	1814	74	4
1665	43	10	1715	38	2	1765	48	0	1815	65	7
1666	32	0	1716	42	8	1766	43	1	1816	78	6
1667	32	0	1717	40	7	1767	57	4	1817	96	11
1668	35	6	1718	34	6	1768	53	9	1818	86	3
1669	39	5	1719	31	1	1769	40	7	1819	74	6
1670	37	0	1720	32	10	1770	43	6	1820	67	10
1671	37	4	1721	33	4	1771	47	2	1821	56	1
1672	36	5	1722	32	0	1772	50	8	1822	44	7
1673	41	5	1723	30	10	1773	51	0	1823	53	4
1674	61	0	1724	32	10	1774	52	8	1824	63	11
1675	57	5	1725	43	1	1775	48	4	1825	68	6
1676	33	9	1726	40	10	1776	38	2	1826	58	8
1677	47	4	1727	37	4	1777	45	6	1827	58	6
1678	52	5	1728	38	5	1778	42	4	1828	60	5
1679	53	4	1729	31	7	1779	42	8	1829	66	3
1680	40	0	1730	32	5	1780	35	8	1830	64	3
1681	41	5	1731	29	2	1781	44	8	1831	66	4
1682	39	1	1732	23	8	1782	47	10	1832	58	3
1683	35	6	1733	25	2	1783	52	8	1833	52	11
1684	39	1	1734	34	6	1784	40	10	1834	46	2
1685	41	5	1735	38	2	1785	51	10	1835	39	4
1686	30	2	1736	35	10	1786	38	10	1836	48	6
1687	22	4	1737	33	9	1787	41	2	1837	55	0
1688	40	10	1738	31	6	1788	45	0	1838	64	7
1689	26	8	1739	34	2	1789	51	2	1839	70	8
1690	30	9	1740	45	1	1790	54	9	1840	66	4
1691	30	2	1741	41	5	1791	47	7	1841	64	4
1692	41	5	1742	30	2	1792	43	0	1842	57	3
1693	60	1	1743	22	1	1793	49	3	1843	50	1
1694	56	10	1744	22	1	1794	52	3	1844	51	3
1695	47	1	1745	24	5	1795	75	2	1845	50	10
1696	63	1	1746	34	8	1796	78	7	1846	54	8
1697	53	4	1747	30	11	1797	53	9	1847	59	9
1698	60	9	1748	32	10	1798	51	10	1848	50	6
1699	56	10	1749	32	10	1799	69	0	1849	44	3
1700	35	6	1750	28	10	1800	113	10	1850	40	3
1701	33	5	1751	34	2	1801	119	6	1851	38	6
1702	26	2	1752	37	2	1802	69	10	1852	40	9
1703	32	0	1753	39	8	1803	58	10	1853	53	3
1704	41	4	1754	30	9	1804	62	3	1854	72	5
1705	26	8	1755	30	1	1805	89	9	1855	74	8
Average for 46 years only.	42	10	36	0	51	9	65	10	142	7	

1 Average for 46 years only.

rail or ocean freights. Incidental charges are lower than they were in 1870; handling charges, brokers' commissions and insurance premiums have been in many instances reduced, but all these economies when combined only amount to about 2s. per quarter. Now if we add together all these savings in the rate of rail and ocean freights and incidental expenses, we arrive at an aggregate economy of 8s. per quarter, or not one-third of the actual difference between the average price of wheat in 1872 and 1900. To what the remaining difference was due it is difficult to say with certitude; there are some who argue that the tendency of prices to fall is inherent, and that the constant whittling away of intermediaries' profits is sufficient explanation, while bi-metallists have maintained that the phenomenon is clearly to be traced to the action of the German government in demonetizing silver in 1872.

GRAM, or CHICK-PEA, called also Egyptian pea, or Bengal gram (from Port. *grão*, formerly *gram*, Lat. *grammum*, Hindi *Chand*, Bengali *Chhola*, Ital. *cece*, Span. *garbanzo*), the *Cicer aridinum* of Linnaeus, so named from the resemblance of its seed to a ram's head. It is a member of the natural order Leguminosae, largely cultivated as a pulse-food in the south of Europe, Egypt and western Asia as far as India, but is not known undoubtedly wild. The plant is an annual herb with flexuose branches, and alternately arranged pinnately compound leaves, with small, oval, serrated leaflets and small eared stipules. The flowers are borne singly in the leaf-axils on a stalk about half the length of the leaf and jointed and bent in the middle; the corolla is blue-purple. The inflated pod, 1 to 1½ in. long, contains two roundish seeds. It was cultivated by the Greeks in Homer's time under the name *erebinthos*, and is also referred to by Dioscorides as *krios* from the resemblance of the pea to the head of a ram. The Romans called it *cicer*, from which is derived the modern names given to it in the south of Europe. Names, more or less allied to one another, are in vogue among the peoples of the Caucasus, the Caspian Sea, Armenia and Persia, and there is a Sanskrit name and several others analogous or different in modern Indian languages. The plant has been cultivated in Egypt from the beginning of the Christian era, but there is no proof that it was known to the ancient Egyptians. Alphonse de Candolle (*Origin of Cultivated Plants*, p. 325) suggests that the plant originally grew wild in the countries to the south of the Caucasus and to the north of Persia. "The western Aryans (Pelasgians, Hellenes) perhaps introduced the plant into southern Europe, where, however, there is some probability that it was also indigenous. The western Aryans carried it to India." Gram is largely cultivated in the East, where the seeds are eaten raw or cooked in various ways, both in their ripe and unripe condition, and when roasted and ground subserved the same purposes as ordinary flour. In Europe the seeds are used as an ingredient in soups. They contain, in 100 parts without husks, nitrogenous substances 22.7, fat 3.76, starch 63.18, mineral matters 2.6 parts, with water (Forbes Watson, quoted in Parkes's *Hygiene*). The liquid which exudes from the glandular hairs clothing the leaves and stems of the plant, more especially during the cold season when the seeds ripen, contains a notable proportion of oxalic acid. In Mysore the dew containing it is collected by means of cloths spread on the plant over night, and is used in domestic medicine. The steam of water in which the fresh plant is immersed is in the Deccan resorted to by the Portuguese for the treatment of dysmenorrhoea. The seed of *Phaseolus Mungo*, or green gram (Hind. and Beng. *moong*), a form of which plant with black seeds (*P. Max* of Roxburgh) is termed black gram, is an important article of diet among the labouring classes in India. The meal is an excellent substitute for soap, and is stated by Elliot to be an invariable concomitant of the Hindu bath. A variety, var. *radiatus* (*P. Roxburghii*, W. and Arn., or *P. radiatus*, Roxb.) (vern. *wrid*, *mashkhalai*), also known as green gram, is perhaps the most esteemed of the leguminous plants of India, where the meal of its seed enters into the composition of the more delicate cakes and dishes. Horse gram, *Dolichos biflorus* (vern. *kulthi*), which supplies in Madras the place of the chick-pea, affords seed which, when boiled, is

extensively employed as a food for horses and cattle in South India, where also it is eaten in curries.

See W. Elliot, "On the Farinaceous Grains and the various kinds of Pulses used in Southern India," *Edin. New Phil. Journ.* xvi. (1862) 16 sq.; H. Drury, *The Useful Plants of India* (1873); U. C. Dutt, *Materia Medica of the Hindus* (Calcutta, 1877); G. Watt, *Dictionary of the Economic Products of India* (1890).

GRAMMAR (from Lat. *grammatica*, sc. *ars*; Gr. γράμμα, letter, from γράφω, to write). By the grammar of a language is meant either the relations borne by the words of a sentence and by sentences themselves one to another, or the systematized exposition of these. The exposition may be, and frequently is, incorrect; but it always presupposes the existence of certain customary uses of words when in combination. In what follows, therefore, grammar will be generally employed in its primary sense, as denoting the mode in which words are connected in order to express a complete thought, or, as it is termed in logic, a proposition.

The object of language is to convey thought, and so long as this object is attained the machinery for attaining it is of comparatively slight importance. The way in which we combine our words and sentences matters little, provided that our meaning is clear to others. The expressions "horseflesh" and "flesh of a horse" are equally intelligible to an Englishman and therefore are equally recognized by English grammar. The Chinese manner of denoting a genitive is by placing the defining word before that which it defines, as in *hōwe jīn*, "man of the kingdom," literally "kingdom man," and the only reason why it would be incorrect in French or Italian is that such a combination would be unintelligible to a Frenchman or an Italian. Hence it is evident that the grammatical correctness or incorrectness of an expression depends upon its intelligibility, that is to say, upon the ordinary use and custom of a particular language. Whatever is so unfamiliar as not to be generally understood is also ungrammatical. In other words, it is contrary to the habit of a language, as determined by common usage and consent.

In this way we can explain how it happens that the grammar of a cultivated dialect and that of a local dialect in the same country so frequently disagree. Thus, in the dialect of West Somerset, *thee* is the nominative of the second personal pronoun, while in cultivated English the plural accusative *you* (A.-S. *ew*) has come to represent a nominative singular. Both are grammatically correct within the sphere of their respective dialects, but no further. *You* would be as ungrammatical in West Somerset as *thee* is in classical English; and both *you* and *thee*, as nominatives singular, would have been equally ungrammatical in Early English. Grammatical propriety is nothing more than the established usage of a particular body of speakers at a particular time in their history.

It follows from this that the grammar of a people changes, like its pronunciation, from age to age. Anglo-Saxon or Early English grammar is not the grammar of Modern English, any more than Latin grammar is the grammar of modern Italian; and to defend an unusual construction or inflexion on the ground that it once existed in literary Anglo-Saxon is as wrong as to import a peculiarity of some local dialect into the grammar of the cultivated speech. It further follows that different languages will have different grammars, and that the differences will be more or less according to the nearer or remoter relationship of the languages themselves and the modes of thought of those who speak them. Consequently, to force the grammatical framework of one language upon another is to misconceive the whole nature of the latter and seriously to mislead the learner. Chinese grammar, for instance, can never be understood until we discard, not only the terminology of European grammar, but the very conceptions which underlie it, while the polysynthetic idioms of America defy all attempts to discover in them "the parts of speech" and the various grammatical ideas which occupy so large a place in our school-grammars. The endeavour to find the distinctions of Latin grammar in that of English has only resulted in grotesque errors, and a total misapprehension of the usage of the English language.

It is to the Latin grammarians—or, more correctly, to the Greek grammarians, upon whose labours those of the Latin writers were based—that we owe the classification of the subjects with which grammar is commonly supposed to deal. The grammar of Dionysius Thrax, which he wrote for Roman schoolboys in the time of Pompey, has formed the starting-point for the innumerable school-grammars which have since seen the light, and suggested that division of the matter treated of which they have followed. He defines grammar as a practical acquaintance with the language of literary men, and as divided into six parts—accentuation and phonology, explanation of figurative expressions, definition, etymology, general rules of flexion and critical canons. Of these, phonology and accentuation, or prosody, can properly be included in grammar only in so far as the construction of a sentence and the grammatical meaning of a word are determined by accent or letter-change; the accentual difference in English, for example, between *incense* and *incense* belongs to the province of grammar, since it indicates a difference between noun and verb; and the changes of vowel in the Semitic languages, by which various nominal and verbal forms are distinguished from one another, constitute a very important part of their grammatical machinery. But where accent and pronunciation do not serve to express the relations of words in a sentence, they fall into the domain of phonology, not of grammar. The explanation of figurative expressions, again, must be left to the rhetorician, and definition to the lexicographer; the grammarian has no more to do with them than he has with the canons of criticism.

In fact, the old subdivision of grammar, inherited from the grammarians of Rome and Alexandria, must be given up and a new one put in its place. What grammar really deals with are all those contrivances whereby the relations of words and sentences are pointed out. Sometimes it is position, sometimes phonetic symbolization, sometimes composition, sometimes flexion, sometimes the use of auxiliaries, which enables the speaker to combine his words in such a way that they shall be intelligible to another. Grammar may accordingly be divided into the three departments of composition or "word-building," syntax and accidence, by which is meant an exposition of the means adopted by language for expressing the relations of grammar when recourse is not had to composition or simple position.

A systematized exposition of grammar may be intended for the purely practical purpose of teaching the mechanism of a foreign language. In this case all that is necessary is a correct and complete statement of the facts. But a correct and complete statement of the facts is by no means so easy a matter as might appear at first sight. The facts will be distorted by a false theory in regard to them, while they will certainly not be presented in a complete form if the grammarian is ignorant of the true theory they presuppose. The Semitic verb, for example, remains unintelligible so long as the explanation of its forms is sought in the conjugation of the Aryan verb, since it has no tenses in the Aryan sense of the word, but denotes relation and not time.

A good practical grammar of a language, therefore, should be based on a correct appreciation of the facts which it expounds, and a correct appreciation of the facts is only possible where they are examined and co-ordinated in accordance with the scientific method. A practical grammar ought, wherever it is possible, to be preceded by a scientific grammar.

Comparison is the instrument with which science works, and a scientific grammar, accordingly, is one in which the comparative method has been applied to the relations of speech. If we would understand the origin and real nature of grammatical forms, and of the relations which they represent, we must compare them with similar forms in kindred dialects and languages, as well as with the forms under which they appeared themselves at an earlier period of their history. We shall thus have a comparative grammar and an historical grammar, the latter being devoted to tracing the history of grammatical forms and usages in the

same language. Of course, an historical grammar is only possible where a succession of written records exists; where a language possesses no older literature we must be content with a comparative grammar only, and look to cognate idioms to throw light upon its grammatical peculiarities. In this case we have frequently to leave whole forms unexplained, or at most conjecturally interpreted, since the machinery by means of which the relations of grammar are symbolized is often changed so completely during the growth of a language as to cause its earlier shape and character to be unrecognizable. Moreover, our area of comparison must be as wide as possible; where we have but two or three languages to compare, we are in danger of building up conclusions on insufficient evidence. The grammatical errors of the classical philologists of the 18th century were in great measure due to the fact that their area of comparison was confined to Latin and Greek.

The historical grammar of a single language or dialect, which traces the grammatical forms and usages of the language as far back as documentary evidence allows, affords material to the comparative grammarian, whose task it is to compare the grammatical forms and usages of an allied group of tongues and thereby reduce them to their earliest forms and senses. The work thus carried out by the comparative grammarian within a particular family of languages is made use of by universal grammar, the object of which is to determine the ideas that underlie all grammar whatsoever, as distinct from those that are peculiar to special families of speech. Universal grammar is sometimes known as "the metaphysics of language," and it has to decide such questions as the nature of gender or of the verb, the true purport of the genitive relation, or the origin of grammar itself. Such questions, it is clear, can only be answered by comparing the results gained by the comparative treatment of the grammars of various groups of language. What historical grammar is to comparative grammar, comparative grammar is to universal grammar.

Universal grammar, as founded on the results of the scientific study of speech, is thus essentially different from that "universal grammar" so much in vogue at the beginning of the 19th century, which consisted of a series of a priori assumptions based on the peculiarities of European grammar and illustrated from the same source. But universal grammar, as conceived by modern science, is as yet in its infancy; its materials are still in the process of being collected. The comparative grammar of the Indo-European languages is alone in an advanced state, those of the Semitic idioms, of the Finno-Ugrian tongues and of the Bantu dialects of southern Africa are still in a backward condition; and the other families of speech existing in the world, with the exception of the Malayo-Polynesian and the Sonorian of North America, have not as yet been treated scientifically. Chinese, it is true, possesses an historical grammar, and Vau Eys, in his comparative grammar of Basque, endeavoured to solve the problems of that interesting language by a comparison of its various dialects; but in both cases the area of comparison is too small for more than a limited success to be attainable. Instead of attempting the questions of universal grammar, therefore, it will be better to confine our attention to three points—the fundamental differences in the grammatical conceptions of different groups of languages, the main results of a scientific investigation of Indo-European grammar, and the light thrown by comparative philology upon the grammar of our own tongue.

The proposition or sentence is the unit and starting-point of speech, and grammar, as we have seen, consists in the relations of its several parts one to another, together with the expression of them. These relations may be regarded from various points of view. In the polysynthetic languages of America the sentence is conceived as a whole, not composed of independent words, but, like the thought which it expresses, one and indivisible. What we should denote by a series of words is consequently denoted by a single long compound—*kwigatchis* in Delaware, for instance, signifying "give me your pretty little paw," and *aglekhiqtartor-*

eswaripok in Eakimo, "he goes away hastily and exerts himself to write." Individual words can be, and often are, extracted from the sentence; but in this case they stand, as it were, outside it, being represented by a pronoun within the sentence itself. Thus, in Mexican, we can say not only *ni-satri-temoa*, "I look for flowers," but also *ni-k-temoa satsii*, where the interpolated guttural is the objective pronoun. As a necessary result of this conception of the sentence the American languages possess no true verb, each act being expressed as a whole by a single word. In Cherokee, for example, while there is no verb signifying "to wash" in the abstract, no less than thirteen words are used to signify every conceivable mode and object of washing. In the incorporating languages, again, of which Basque may be taken as a type, the object cannot be conceived except as contained in the verbal action. Hence every verbal form embodies an objective pronoun, even though the object may be separately expressed. If we pass to an isolating language like Chinese, we find the exact converse of that which meets us in the polysynthetic tongues. Here each proposition or thought is analyzed into its several elements, and these are set over against one another as so many independent words. The relations of grammar are consequently denoted by position, the particular position of two or more words determining the relation they bear to each other. The analysis of the sentence has not been carried so far in agglutinative languages like Turkish. In these the relations of grammar are represented by individual words, which, however, are subordinated to the words expressing the main ideas intended to be in relation to one another. The defining words, or indices of grammatical relations, are, in a large number of instances, placed after the words which they define; in some cases, however, as, for example, in the Bantu languages of southern Africa, the relation is conceived from the opposite point of view, the defining words being prefixed. The inflexional languages call in the aid of a new principle. The relations of grammar are denoted symbolically either by a change of vowel or by a change of termination, more rarely by a change at the beginning of a word. Each idea, together with the relation which it bears to the other ideas of a proposition, is thus represented by a single word; that is to say, the ideas which make up the elements of a sentence are not conceived severally and independently, as in Chinese, but as always having a certain connexion with one another. Inflexional languages, however, tend to become analytical by the logical separation of the flexion from the idea to which it is attached, though the primitive point of view is never altogether discarded, and traces of flexion remain even in English and Persian. In fact, there is no example of a language which has wholly forsaken the conception of the sentence and the relation of its elements with which it started, although each class of languages occasionally trespasses on the grammatical usages of the others. In language, as elsewhere in nature, there are no sharp lines of division, no sudden leaps; species passes insensibly into species, class into class. At the same time the several types of speech—polysynthetic, isolating, agglutinative and inflexional—remain clear and fixed; and even where two languages belong to the same general type, as, for instance, an Indo-European and a Semitic language in the inflexional group, or a Bantu and a Turkish language in the agglutinative group, we find no certain example of grammatical interchange. A mixed grammar, in which the grammatical procedure of two distinct families of speech is intermingled, is almost, if not altogether, unknown.

It is obvious, therefore, that grammar constitutes the surest and most important basis for a classification of languages. Words may be borrowed freely by one dialect from another, or, though originally unrelated, may, by the action of phonetic decay, come to assume the same forms, while the limited number of articulate sounds and conceptions out of which language was first developed, and the similarity of the circumstances by which the first speakers were everywhere surrounded, naturally produce a resemblance between the roots of many unconnected tongues. Where, however, the fundamental conceptions of grammar and

Differences in grammar of small languages.

the machinery by which they are expressed are the same, we may have no hesitation in inferring a common origin.

The main results of scientific inquiry into the origin and primitive meaning of the forms of Indo-European grammar may be summed up as follows. We start with stems or themes, by which are meant words of two or more syllables which terminate in a limited number of sounds. These stems can be classed in groups of two kinds, one in which the groups consist of stems of similar meanings and similar initial syllables, and another in which the final syllables alone coincide. In the first case we have what are termed roots, the simplest elements into which words can be decomposed; in the second case stems proper, which may be described as consisting of suffixes attached to roots. Roots, therefore, are merely the materials out of which speech can be made, the embodiments of isolated conceptions with which the lexicographer alone has to deal, whereas stems present us with words already combined in a sentence and embodying the relations of grammar. If we would rightly understand primitive Indo-European grammar, we must conceive it as having been expressed or implied in the suffixes of the stems, and in the order according to which the stems were arranged in a sentence. In other words, the relations of grammar were denoted partly by juxtaposition or syntax, partly by the suffixes of stems.

These suffixes were probably at first unmeaning, or rather clothed with vague significations, which changed according to the place occupied in the sentence by the stem to which they were joined. Gradually this vagueness of signification disappeared, and particular suffixes came to be set apart to represent particular relations of grammar. What had hitherto been expressed by mere position now attached itself to the terminations or suffixes of stems, which accordingly became full-grown words. Some of the suffixes denoted purely grammatical ideas, that is to say, were flexions; others were classificatory, serving to distinguish nouns from verbs, presents from aorists, objects from agents and the like; while others, again, remained unmeaning adjuncts of the root. This origin of the flexions explains the otherwise strange fact that the same suffix may symbolize wholly different grammatical relations. In Latin, for instance, the context and dictionary will alone tell us that *mus-as* is the accusative plural of a noun, and *am-as* the second person singular of a verb, or that *mus-a* is the nominative singular of a feminine substantive, *bon-a* the accusative plural of a neuter adjective. In short, the flexions were originally merely the terminations of stems which were adapted to express the various relations of words to each other in a sentence, as these gradually presented themselves to the consciousness and were extracted from what had been previously implied by position. Necessarily, the same suffix might be used sometimes in a classificatory, sometimes in a flexional sense, and sometimes without any definite sense at all. In the Greek dative-locative *πῶς-εσσι*, for example, the suffix *-εσσι* is classificatory; in the nominative *πῶς-εσσι* it is flexional.

When a particular termination or suffix once acquired a special sense, it would be separated in thought from the stem to which it belonged, and attached in the same sense to other stems and other terminations. Thus in modern English we can attach the suffix *-ess* to almost any word whatsoever, in order to give the latter a transitive meaning, and the Gr. *πῶς-εσσι*, quoted above, really contains no less than three suffixes, *-εσσι*, *-εσσι* and *-εσσι*, the last two both denoting the locative, and coalescing, through *εσσι*, into a single syllable *-εσσι*. The latter instance shows us how two or more suffixes denoting exactly the same idea may be tacked on one to another, if the original force and signification of the first of them comes to be forgotten. Thus, in O. Eng. *sang-estre* was the feminine of *sang-ere*, "singer," but the meaning of the termination has so entirely died out of the memory that we have to add the Romanic *-ess* to it if we would still distinguish it from the masculine *singer*. A familiar example of the way in which the full sense of the exponent of a grammatical idea fades from the mind and has to be supplied by a new exponent is afforded by the use of expletives in conversational English

to denote the superlative. "Very warm" expresses little more than the positive, and to represent the intensity of his feelings the Englishman has recourse to such expressions as "awfully warm" like the Ger. "schrecklich warm."

Such words as "very," "awfully," "schrecklich," illustrate a second mode in which Indo-European grammar has found means of expression. Words may lose their true signification and become the mere exponents of grammatical ideas. Professor Earle divides all words into *presentive* and *symbolic*, the former denoting objects and conceptions, the latter the relations which exist between these. Symbolic words, therefore, are what the Chinese grammarians call "empty words"—words, that is, which have been divested of their proper signification and serve a grammatical purpose only. Many of the classificatory and some of the flexional suffixes of Indo-European speech can be shown to have had this origin. Thus the suffix *tar*, which denotes names of kinship and agency, seems to come from the same root as the Lat. *terminus* and *trans*, our *through*, the Sans *tar-āmi*, "I pass over," and to have primarily signified "one that goes through" a thing. Thus, too, the Eng. *head* or *hood*, in words like *godhead* and *brotherhood*, is the A.-S. *hād*, "character" or "rank"; *dom*, in kingdom, the A.-S. *dōm*, "judgment"; and *lock* or *ledge*, in *wedlock* and *knowledge*, the A.-S. *lōc*, "sport" or "gift." In all these cases the "empty words," after first losing every trace of their original significance, have followed the general analogy of the language and assumed the form and functions of the suffixes with which they had been confused.

A third mode of representing the relations of grammar is by the symbolic use of vowels and diphthongs. In Greek, for instance, the distinction between the reduplicated present *λύωμ* and the reduplicated perfect *λύωσα* is indicated by a distinction of vowel, and in primitive Aryan grammar the vowel *ā* seems to have been set apart to denote the subjunctive mood just as *ya* or *i* was set apart to denote the potential. So, too, according to M. Hovelacque, the change of *a* into *i* or *u* in the parent Indo-European symbolized a change of meaning from passive to active. This symbolic use of the vowels, which is the purest application of the principle of flexion, is far less extensively carried out in the Indo-European than in the Semitic languages. The Semitic family of speech is therefore a much more characteristic type of the inflexional languages than is the Indo-European.

The primitive Indo-European noun possessed at least eight cases—nominative, accusative, vocative, instrumental, dative, genitive, ablative and locative. M. Bergaigne has attempted to show that the first three of these, the "strong cases" as they are termed, are really abstracts formed by the suffixes *-as* (*-s*), *-an*, *-m*, *-t*, *-i*, *-d* and *-us* (*-i*), the plural being nothing more than an abstract singular, as may be readily seen by comparing words like the Gr. *ἔρω-ε*, and *ἔρω-εσσι*, which mean precisely the same. The remaining "weak" cases, formed by the suffixes *-ama*, *-ya*, *-yā*, *-yā*, *-i*, *-an*, *-i*, *-hī*, *-su*, *-i*, *-o* and *-d*, are really adjectives and adverbs. No distinction, for example, can be drawn between "a cup of gold" and "a golden cup," and the instrumental, the dative, the ablative and the locative are, when closely examined, merely adverbs attached to a verb. The terminations of the strong cases do not displace the accent of the stem to which they are suffixed; the suffixes of the weak cases, on the other hand, generally draw the accent upon themselves.

According to Hübschmann, the nominative, accusative and genitive cases are purely grammatical, distinguished from one another through the exigencies of the sentence only, whereas the locative, ablative and instrumental have a logical origin and determine the logical relation which the three other cases bear to each other and the verb. The nature of the dative is left undecided. The locative primarily denotes rest in a place, the ablative motion from a place, and the instrumental the means or concomitance of an action. The dative Hübschmann regards as "the case of the participant object." Like Hübschmann, Holzweissig divides the cases into two classes—the one grammatical and the other logical; and his analysis of their primitive meaning is the same as that of Hübschmann, except as regards

the dative, the primary sense of which he thinks to have been motion towards a place. This is also the view of Delbrück, who makes it denote tendency towards an object. Delbrück, however, holds that the primary sense of the ablative was that of separation, the instrumental originally indicating concomitance, while there was a double locative, one used like the ablative absolute in Latin, the other being a locative of the object.

The dual was older than the plural, and after the development of the latter survived as a merely useless encumbrance, of which most of the Indo-European languages contrived in time to get rid. There are still many savage idioms in which the conception of plurality has not advanced beyond that of duality. In the Bushman dialects, for instance, the plural, or rather that which is more than one, is expressed by repeating the word; thus *tu* is "mouth," *tu tu* "mouths." It may be shown that most of the suffixes of the Indo-European dual are the longer and more primitive forms of those of the plural which have grown out of them by the help of phonetic decay. The plural of the weak cases, on the other hand (the accusative alone excepted), was identical with the singular of abstract nouns; so far as both form and meaning are concerned, no distinction can be drawn between *dues* and *eros*. Similarly, *humanity* and *men* signify one and the same thing, and the use of English words like *sheep* or *fish* for both singular and plural shows to what an extent our appreciation of number is determined by the context rather than by the form of the noun. The so-called "broken plurals" of Arabic and Ethiopic are really singular collectives employed to denote the plural.

Gender is the product partly of analogy, partly of phonetic decay. In many languages, such as Eskimo and Choctaw, its place is taken by a division of objects into animate and inanimate, while in other languages they are separated into rational and irrational. There are many indications that the parent Indo-European in an early stage of its existence had no signs of gender at all. The terminations of the names of *father* and *mother*, *pater* and *mater*, for example, are exactly the same, and in Latin and Greek many diphthongal stems, as well as stems in *i* or *ya* and *u* (like *vaüs* and *véus*, *πόλυς* and *λίς*), may be indifferently masculine and feminine. Even stems in *o* and *a* (of the second and first declensions), though the first are generally masculine and the second generally feminine, by *no* means invariably maintain the rule; and feminines like *húmus* and *ódös*, or masculines like *ádvena* and *ροδίαρς*, show that there was a time when these stems also indicated no particular gender, but owed their subsequent adaptation, the one to mark the masculine and the other to mark the feminine, to the influence of analogy. The idea of gender was first suggested by the difference between man and woman, male and female, and, as in so many languages at the present day, was represented not by any outward sign but by the meaning of the words themselves. When once arrived at, the conception of gender was extended to other objects besides those to which it properly belonged. The primitive Indo-European did not distinguish between subject and object, but personified objects by ascribing to them the motives and powers of living beings. Accordingly they were referred to by different pronouns, one class denoting the masculine and another class the feminine, and the distinction that existed between these two classes of pronouns was after a time transferred to the nouns. As soon as the preponderant number of stems in *o* in daily use had come to be regarded as masculine on account of their meaning, other stems in *o*, whatever might be their signification, were made to follow the general analogy and were similarly classed as masculines. In the same way, the suffix *i* or *ya* acquired a feminine sense, and was set apart to represent the feminine gender. Unlike the Semites, the Indo-Europeans were not satisfied with these two genders, masculine and feminine. As soon as object and subject, patient and agent, were clearly distinguished from each other, there arose a need for a third gender, which should be neither masculine nor feminine, but denote things without life. This third gender was fittingly expressed either by the objective case used as a nominative (e.g. *regnum*), or by a stem without any case ending at all (e.g. *virus*).

The adverbial meaning of so many of the cases explains the readiness with which they became crystallized into adverbs and prepositions. An adverb is the attribute of an attribute—"the rose smells sweetly," for example, being resolvable into "the rose has the attribute of scent with the further attribute of sweetness." In our own language *once*, *twice*, *needs*, are all genitives; *seldom* is a dative. The Latin and Greek *humi* and *χαμαί* are locatives, *facillime* (*facillimed*) and *εβρυχώς* ablatives, *πάρρη* and *έμα* instrumentals, *πάρος*, *έξής* and *τηλοῦ* genitives. The frequency with which particular cases of particular nouns were used in a specifically attributive sense caused them to become, as it were, petrified, the other cases of the nouns in question passing out of use, and the original force of those that were retained being gradually forgotten. Prepositions are adverbs employed to define nouns instead of verbs and adjectives. Their appearance in the Indo-European languages is comparatively late, and the Homeric poems allow us to trace their growth in Greek. The adverb, originally intended to define the verb, came to be construed with the noun, and the government of the case with which it was construed was accordingly transferred from the verb to the noun. Thus when we read in the *Odyssey* (iv. 43), *αἰσῶς δ' εὐσπῆρον θεῖον ἔδμον*, we see that *ds* is still an adverb, and that the accusative is governed by the verb; it is quite otherwise, however, with a line like *Ἀρτείδης δὲ γέροντας δούλλας ἔγγεν' Ἀχαιῶν ἐς ἀδυστήρ (Il. i. 89)* where the adverb has passed into a preposition. The same process of transformation is still going on in English, where we can say indifferently, "What are you looking at?" using "at" as an adverb, and governing the pronoun by the verb, and "At what are you looking?" where "at" has become a preposition. With the growth and increase of prepositions the need of the case-endings diminished, and in some languages the latter disappeared altogether.

Like prepositions, conjunctions also are primarily adverbs used in a demonstrative and relative sense. Hence most of the conjunctions are petrified cases of pronouns. The relation between two sentences was originally expressed by simply setting them side by side, afterwards by employing a demonstrative at the beginning of the second clause to refer to the whole preceding one. The relative pronoun can be shown to have been in the first instance a demonstrative; indeed, we can still use *that* in English in a relative sense. Since the demonstrative at the beginning of the second clause represented the first clause, and was consequently an attribute of the second, it had to stand in some case, and this case became a conjunction. How closely allied the adverb and the conjunction are may be seen from Greek and Latin, where *ὡς* or *quum* can be used as either the one or the other. Our own *and*, it may be observed, has probably the same root as the Greek locative adverb *ἐπι*, and originally signified "going further."

Another form of adverb is the infinitive, the adverbial force of which appears clearly in such a phrase as "A wonderful thing to see." Various cases, such as the locative, the dative or the instrumental, are employed in Vedic Sanskrit in the sense of the infinitive, besides the bare stem or neuter formed by the suffixes *man* and *van*. In Greek the neuter stem and the dative case were alone retained for the purpose. The first is found in infinitives like *δδμεν* and *φάμεν* (for an earlier *φάρε-φω*), the second in the infinitives in *-αι*. Thus the Gr. *δοῖναι* answers letter for letter to the Vedic dative *dāśāne*, "to give," and the form *ψαίθεσθαι* is explained by the Vedic *psyodhai*, for *psayds-dhai*, literally "to do living," *dhai* being the dative of a noun from the root *dha*, "to place" or "do." When the form *ψαίθεσθαι* had once come into existence, analogy was ready to create such false imitations as *γράφασθαι* or *γραφοθήσασθαι*. The Latin infinitive in *-re* for *-se* has the same origin, *amare*, for instance, being the dative of an old stem *amas*. In *feri* for *feres* or *fesct*, from the same root as our English *be*, the original length of the final syllable is preserved. The suffix in *-um* is an accusative, like the corresponding infinitive of classical Sanskrit. This origin of the infinitive explains the Latin construction of the accusative and infinitive. When the Roman said, "Miror te ad me nihil

scribere," all that he meant at first was, "I wonder at you for writing nothing to me," where the infinitive was merely a dative case used adverbially.

The history of the infinitive makes it clear how little distinction must have been felt at the outset between the noun and the verb. Indeed, the growth of the verb was a slow process. There was a time in the history of Indo-European speech when it had not as yet risen to the consciousness of the speaker, and in the period when the noun did not possess a plural there was as yet also no verb. The attachment of the first and second personal pronouns, or of suffixes resembling them, to certain stems, was the first stage in the development of the latter. Like the Semitic verb, the Indo-European verb seems primarily to have denoted relation only, and to have been attached as an attribute to the subject. The idea of time, however, was soon put into it, and two tenses were created, the one expressing a present or continuous action, the other an aoristic or momentary one. The distinction of sense was symbolized by a distinction of pronunciation, the root-syllable of the aorist being an abbreviated form of that of the present. This abbreviation was due to a change in the position of the accent (which was shifted from the stem-syllable to the termination), and this change again was probably occasioned by the prefixing of the so-called augment to the aorist, which survived into historical times only in Sanskrit, Zend and Greek, and the origin of which is still a mystery. The weight of the first syllable in the aorist further caused the person-endings to be shortened, and so two sets of person-endings, usually termed primary and secondary, sprang into existence. By reduplicating the root-syllable of the present tense a perfect was formed; but originally no distinction was made between present and perfect, and Greek verbs like *τίκωμι* and *ἔκωμι* are memorials of a time when the difference between "I am come" and "I have come" was not yet felt. Reduplication was further adapted to the expression of intensity and desire (in the so-called intensive and desiderative forms). By the side of the aorist stood the imperfect, which differed from the aorist, so far as outward form was concerned, only in possessing the longer and more original stem of the present. Indeed, as Benfey first saw, the aorist itself was primitively an imperfect, and the distinction between aorist and imperfect is not older than the period when the stem-syllables of certain imperfects were shortened through the influence of the accent, and this differentiation of forms appropriated to denote a difference between the sense of the aorist and the imperfect which was beginning to be felt. After the analogy of the imperfect, a pluperfect was created out of the perfect by prefixing the augment (of which the Greek *ἐπέμηνον* is an illustration); though the pluperfect, too, was originally an imperfect formed from the reduplicated present.

Besides time, mood was also expressed by the primitive Indo-European verb, recourse being had to symbolization for the purpose. The Imperative was represented by the bare stem, like the vocative, the accent being drawn back to the first syllable, though other modes of denoting it soon came into vogue. Possibility was symbolized by the attachment of the suffix *-ys* to the stem, probably by the attachment of *-s* and *-d*, and in this way the optative and conjunctive moods first arose. The creation of a future by the help of the suffix *-ys* seems to belong to the same period in the history of the verb. This suffix is probably identical with that used to form a large class of adjectives and genitives (like the Greek *ἰσχυρο* for *ἰσχυρός*); in this case future time will have been regarded as an attribute of the subject, no distinction being drawn, for instance, between "rising sun" and "the sun will rise." It is possible, however, that the auxiliary verb *as*, "to be," enters into the composition of the future; if so, the future will be the product of the second stage in the development of the Indo-European verb when new forms were created by means of composition. The sigmatic or first aorist is in favour of this view, as it certainly belongs to the age of Indo-European unity, and may be a compound of the verbal stem with the auxiliary *as*.

After the separation of the Indo-European languages, composition was largely employed in the formation of new tenses.

Thus in Latin we have perfects like *scrip-si* and *ama-si*, formed by the help of the auxiliaries *as* (*sum*) and *fu*, while such forms as *amaveram* (*amavi-eram*) or *amarem* (*ama-rem*) bear their origin on their face. So, too, the future in Latin and Old Celtic (*amabo*, Irish *carub*) is based upon the substantive verb *fu*, "to be," and the English preterite in *-ed* goes back to a suffixed *did*, the reduplicated perfect of *do*. New tenses and moods, however, were created by the aid of suffixes as well as by the aid of composition; or rather were formed from nouns whose stems terminated in the suffixes in question. Thus in Greek we have aorists and perfects in *-sa*, and the characteristics of the two passive aorists, *ye* and *the*, are more probably the suffixes of nominal stems than the roots of the two verbs *ye*, "to go," and *dhe*, "to place," as Bopp supposed. How late some of these new formations were may be seen in Greek, where the Homeric poems are still ignorant of the weak future passive, the optative future, and the aspirated perfect, and where the strong future passive occurs but once and the desiderative but twice. On the other hand, many of the older tenses were disused and lost. In classical Sanskrit, for instance, of the modal aorist forms the precativ and benedictive almost alone remain, while the pluperfect, of which Delbrück has found traces in the Veda, has wholly disappeared.

The passive voice did not exist in the parent Indo-European speech. No need for it had arisen, since such a sentence as "I am pleased" could be as well represented by "This pleases me," or "I please myself." It was long before the speaker was able to imagine an action without an object, and when he did so, it was a neuter or substantival rather than a passive verb that he formed. The passive, in fact, grew out of the middle or reflexive, and, except in the two aorists, continued to be represented by the middle in Greek. So, too, in Latin the second person plural is really the middle participle with *estis* understood, and the whole class of deponent or reflexive verbs proves that the characteristic *r* which Latin shares with Celtic could have had at the outset no passive force.

Much light has been thrown on the character and construction of the primitive Indo-European sentence by comparative syntax. In contradistinction to Semitic, where the defining word follows that which is defined, the Indo-European languages place that which is defined after that which defines it; and Bergaigne has made it clear that the original order of the sentence was (1) object, (2) verb, and (3) subject. Greater complication of thought and its expression, the connexion of sentences by the aid of conjunctions, and rhetorical inversion caused that dislocation of the original order of the sentence which reaches its culminating point in the involved periods of Latin literature. Our own language still remains true, however, to the syntax of the parent Indo-European when it sets both adjective and genitive before the nouns which they define. In course of time a distinction came to be made between an attribute used as a mere qualificative and an attribute used predicatively, and this distinction was expressed by placing the predicate in opposition to the subject and accordingly after it. The opposition was of itself sufficient to indicate the logical copula or substantive verb; indeed, the word which afterwards commonly stood for the latter at first signified "existence," and it was only through the wear and tear of time that a phrase like *Deus bonus est*, "God exists as good," came to mean simply "God is good." It is needless to observe that neither of the two articles was known to the parent Indo-European; indeed, the definite article, which is merely a decayed demonstrative pronoun, has not yet been developed in several of the languages of the Indo-European family.

We must now glance briefly at the results of a scientific investigation of English grammar and the modifications they necessitate in our conception of it. The idea that the free use of speech is tied down by the rules of the grammarian must first be given up; all that the grammarian can do is to formulate the current uses of his time, which are determined by habit and custom, and are accordingly in a perpetual state of flux. We must next

get rid of the notion that English grammar should be modelled after that of ancient Rome; until we do so we shall never understand even the elementary principles upon which it is based. We cannot speak of declensions, since English has no genders except in the pronouns of the third person, and no cases except the genitive and a few faint traces of an old dative. Its verbal conjugation is essentially different from that of an inflexional language like Latin, and cannot be compressed into the same categories. In English the syntax has been enlarged at the expense of the accidence; position has taken the place of forms. To speak of an adjective "agreeing" with its substantive is as misleading as to speak of a verb "governing" a case. In fact, the distinction between noun and adjective is inapplicable to English grammar, and should be replaced by a distinction between objective and attributive words. In a phrase like "this is a cannon," *cannon* is objective; in a phrase like "a cannon-ball," it is attributive; and to call it a substantive in the one case and an adjective in the other is only to introduce confusion. With the exception of the nominative, the various forms of the noun are all attributive; there is no difference, for example, between "doing a thing" and "doing badly." Apart from the personal pronouns, the accusative of the classical languages can be represented only by position; but if we were to say that a noun which follows a verb is in the accusative case we should have to define "king" as an accusative in such sentences as "he became king" or "he is king." In conversational English "it is me" is as correct as "c'est moi" in French, or "det er mig" in Danish; the literary "it is I" is due to the influence of classical grammar. The combination of noun or pronoun and preposition results in a compound attribute. As for the verb, Sweet has well said that "the really characteristic feature of the English finite verb is its inability to stand alone without a pronominal prefix." Thus "dream" by itself is a noun; "I dream" is a verb. The place of the pronominal prefix may be taken by a noun, though both poetry and vulgar English frequently insert the pronoun even when the noun precedes. The number of inflected verbal forms is but small, being confined to the third person singular and the special forms of the preterite and past participle, though the latter may with more justice be regarded as belonging to the province of the lexicographer rather than to that of the grammarian. The inflected subjunctive (*be, were, same* in "God save the King," &c.) is rapidly disappearing. New inflected forms, however, are coming into existence; at all events, we have as good a right to consider *wont, shant, cant* new inflected forms as the French *aimerai (amare habeo), aimerai (amare habebam)*. If the ordinary grammars are correct in treating forms like "I am loving," "I was loving," "I did love," as separate tenses, they are strangely inconsistent in omitting to notice the equally important emphatic form "I do love" or the negative form "I do not love" ("I don't love"), as well as the semi-inflexional "I'll love," "he's loving." It is true that these latter contracted forms are heard only in conversation and not seen in books; but the grammar of a language, it must be remembered, is made by those who speak it and not by the printers.

Our school grammars are the inheritance we have received from Greece and Rome. The necessities of rhetoric obliged the Sophists to investigate the structure of the Greek language, and to them was accordingly due the first analysis of Greek grammar. Protagoras distinguished the three genders and the verbal moods, while Prodicus busied himself with the definition of synonyms. Aristotle, taking the side of Democritus, who had held that the meaning of words is put into them by the speaker, and that there is no necessary connexion between sound and sense, laid down that words "symbolize" objects according to the will of those who use them, and added to the *ὄνομα* or "noun," and the *ῥῆμα* or "verb," the *σύνθετος* or "particle." He also introduced the term *πρόσθετος*, "case," to denote any flexion whatsoever. He further divided nouns into simple and compound, invented for the neuter another name than that given by Protagoras, and

starting from the termination of the nominative singular, endeavoured to ascertain the rules for indicating a difference of gender. Aristotle was followed by the Stoics, who separated the *ἄρθρον* or "article" from the particles, determined a fifth part of speech, the *ὑποκείμενον* or "adverb," confined the term "case" to the flexions of the nouns, distinguishing the four principal cases by names, and divided the verb into its tenses, moods and classes. Meanwhile the Alexandrian critics were studying the language of Homer and the Attic writers, and comparing it with the language of their own day, the result being a minute examination of the facts and rules of grammar. Two schools of grammarians sprang up—the Analogists, headed by Aristarchus, who held that a strict law of analogy existed between idea and word, and refused to admit exceptions to the grammatical rules they laid down, and the Anomalists, who denied general rules of any kind, except in so far as they were consecrated by custom. Foremost among the Anomalists was Crates of Mallos, the leader of the Pergamian school, to whom we owe the first formal Greek grammar and collection of the grammatical facts obtained by the labours of the Alexandrian critics, as well as an attempt to reform Greek orthography. The immediate cause of this grammar seems to have been a comparison of Latin with Greek, Crates having lectured on the subject while ambassador of Attalus at Rome in 159 B.C. The zeal with which the Romans threw themselves into the study of Greek resulted in the school grammar of Dionysius Thrax, a pupil of Aristarchus, which he published at Rome in the time of Pompey and which is still in existence. Latin grammars were soon modelled upon it, and the attempt to translate the technical terms of the Greek grammarians into Latin was productive of numerous blunders which have been perpetuated to our own day. Thus *tenses* is a mistranslation of the Greek *ῥησις*, "unspirated"; *genetivus* of *γενετή*, the case "of the genus"; *accusativus* of *ἀντικείμενη*, the case "of the object"; *inflexivus* of *ἐπαρμύφατος*, "without a secondary meaning" of tense or person. New names were coined to denote forms possessed by Latin and not by Greek; *oblique*, for instance, was invented by Julius Caesar, who also wrote a treatise *De analogia*. By the 2nd century of the Christian era the dispute between the Anomalists and the Analogists was finally settled, analogy being recognized as the principle that underlies language, though every rule admits of exceptions. Two eminent grammarians of Alexandria, Apollonius Dyscolus and his son Herodian, summed up the labours and contrivances of their predecessors, and upon their works were based the Latin grammar composed by Aelius Donatus in the 4th century, and the eighteen books on grammar compiled by Priscian in the age of Justinian. The grammar of Donatus dominated the schools of the middle ages, and, along with the productions of Priscian, formed the type and source of the Latin and Greek school-grammars of modern Europe.

A few words remain to be said, in conclusion, on the bearing of a scientific study of grammar upon the practical task of teaching and learning foreign languages. The grammar of a language is not to be confined within the rules laid down by grammarians, much less is it the creation of grammarians, and consequently the usual mode of making the pupil learn by heart certain fixed rules and paradigms not only gives a false idea of what grammar really is, but also throws obstacles in the way of acquiring it. The unit of speech is the sentence; and it is with the sentence therefore, and not with lists of words and forms, that the pupil should begin. When once a sufficient number of sentences has been, so to speak, assimilated, it will be easy to analyse them into their component parts, to show the relations that these bear to one another, and to indicate the nature and varieties of the latter. In this way the learner will be prevented from regarding grammar as a piece of dead mechanism or a Chinese puzzle, of which the parts must be fitted together in accordance with certain artificial rules, and will realize that it is a living organism which has a history and a reason of its own. The method of nature and science alike is analytic; and if we would learn a foreign language properly we must learn it as we did

our mother-tongue, by first mastering the expression of a complete thought and then breaking up this expression into its several elements. (A. H. S.)

See PHILOLOGY, and articles on the various languages. Also Steinthal, *Charakteristik der hauptsächlichsten Typen des Sprachbaues* (Berlin, 1860); Schleicher, *Compendium of the Comparative Grammar of the Indo-European Languages*, translated by H. Bendall (London, 1874); Pezzi, *Aryan Philology according to the most recent Researches*, translated by E. S. Roberts (London, 1879); Sayce, *Introduction to the Science of Language* (London, 1879); Lersch, *Die Sprachphilosophie der Alten* (Bonn, 1838-1841); Steinthal, *Geschichte der Sprachwissenschaft bei den Griechen und Römern mit besonderer Rücksicht auf die Logik* (Berlin, 1863, 2nd ed. 1890); Delbrück, *Ablatio localis instrumentalis im Altindischen, Lateinischen, Griechischen, und Deutschen* (Berlin, 1864); Jolly, *Ein Kapitel vergleichender Syntax* (Munich, 1873); Hübschmann, *Zur Casuslehre* (Munich, 1875); Holzweissig, *Wahrheit und Irrthum der localistischen Casustheorie* (Leipzig, 1877); Draeger, *Historische Syntax der lateinischen Sprache* (Leipzig, 1874-1876); Sweet, *Words, Logic, and Grammar* (London, 1876); P. Giles, *Manual of Comp. Philology* (1901); C. Abel, *Agypt.-indo-eur. Sprachverwandtschaft* (1903); Brugmann and Delbrück, *Grundriss d. vergl. Gram. d. indogerm. Spr.* (1886-1900); Fritz Mauthner, *Beiträge zur einer Kritik der Sprache* vol. iii. (1902); T. G. Tucker, *Introd. to a Nat. Hist. of Language* (1908).

GRAMMICHELE, a town of Sicily, in the province of Catania, 55 m. S.W. of it by rail and 31 m. direct. Pop. (1901) 15,075. It was built in 1693, after the destruction by an earthquake of the old town of Occhialà to the north; the latter, on account of the similarity of name, is generally identified with Echella, a frontier city between Syracusan and Carthaginian territory in the time of Hiero II., which appears to have been originally a Sicel city in which Greek civilization prevailed from the 5th century onwards. To the east of Grammichele a cave shrine of Demeter, with fine votive terra-cottas, has been discovered. See *Mon. Lincei*, vii. (1897), 201; *Not. degli scavi* (1902), 223.

GRAMMONT (the Flemish name *Gheeraardsbergen* more clearly reveals its etymology *Gerardi-mons*), a town in East Flanders, Belgium, near the meeting point with the provinces of Brabant and Hainaut. It is on the Dender almost due south of Alost, and is chiefly famous because the charter of Grammont given by Baldwin VI., count of Flanders, in A.D. 1068 was the first of its kind. This charter has been styled "the most ancient written monument of civil and criminal laws in Flanders." The modern town is a busy industrial centre. Pop. (1904) 12,835.

GRAMONT, ANTOINE AGÉNOR ALFRED, DUC DE, DUC DE GUICHE, PRINCE DE BIDACHE (1819-1880), French diplomatist and statesman, was born at Paris on the 14th of August 1819, of one of the most illustrious families of the old noblesse, a cadet branch of the viscounts of Aure, which took its name from the seignory of Gramont in Navarre. His grandfather, Antoine Louis Marie, duc de Gramont (1755-1836), had emigrated during the Revolution, and his father, Antoine Héraclius Geneviève Agénor (1789-1855), duc de Gramont and de Guiche, fought under the British flag in the Peninsular War, became a lieutenant-general in the French army in 1823, and in 1830 accompanied Charles X. to Scotland. The younger generation, however, were Bonapartists in sympathy; Gramont's cousin Antoine Louis Raymond, comte de Gramont (1787-1825), though also the son of an *émigré*, served with distinction in Napoleon's armies, while Antoine Agénor, duc de Gramont, owed his career to his early friendship for Louis Napoleon.

Educated at the École Polytechnique, Gramont early gave up the army for diplomacy. It was not, however, till after the *coup d'état* of the 2nd of December 1851, which made Louis Napoleon supreme in France, that he became conspicuous as a diplomat. He was successively minister plenipotentiary at Cassel and Stuttgart (1852), at Turin (1853), ambassador at Rome (1857) and at Vienna (1861). On the 15th of May 1870 he was appointed minister of foreign affairs in the Ollivier cabinet, and was thus largely, though not entirely, responsible for the bungling of the negotiations between France and Prussia arising out of the candidature of Prince Leopold of Hohenzollern for the throne of Spain, which led to the disastrous war of 1870-71. The exact share of Gramont in this responsibility has been the subject of much controversy. The last word may be

said to have been uttered by M. Émile Ollivier himself in his *L'Empire libéral* (tome xii., 1909, *passim*). The famous declaration read by Gramont in the Chamber on the 6th of July, the "threat with the hand on the sword-hilt," as Bismarck called it, was the joint work of the whole cabinet; the original draft presented by Gramont was judged to be too "elliptical" in its conclusion and not sufficiently vigorous; the reference to a revival of the empire of Charles V. was suggested by Ollivier; the paragraph asserting that France would not allow a foreign power to disturb to her own detriment the actual equilibrium of Europe was inserted by the emperor. So far, then, as this declaration is concerned, it is clear that Gramont's responsibility must be shared with his sovereign and his colleagues (Ollivier *op. cit.* xii. 107; see also the two *projets de déclaration* given on p. 570). It is clear, however, that he did not share the "passion" of his colleagues for "peace with honour," clear also that he wholly misread the intentions of the European powers in the event of war. That he reckoned upon the active alliance of Austria was due, according to M. Ollivier, to the fact that for nine years he had been a *persona grata* in the aristocratic society of Vienna, where the necessity for revenging the humiliation of 1866 was an article of faith. This confidence made him less disposed than many of his colleagues to make the best of the renunciation of the candidature made, on behalf of his son, by the prince of Hohenzollern-Sigmaringen. It was Gramont who pointed out to the emperor, on the evening of the 12th, the dubious circumstances of the act of renunciation, and on the same night, without informing M. Ollivier, despatched to Benedetti at Ems the fatal telegram demanding the king of Prussia's guarantee that the candidature would not be revived. The supreme responsibility for this act must rest with the emperor, "who imposed it by an exercise of personal power on the only one of his ministers who could have lent himself to such a forgetfulness of the safeguards of a parliamentary régime." As for Gramont, he had "no conception of the exigencies of this régime; he remained an ambassador accustomed to obey the orders of his sovereign; in all good faith he had no idea that this was not correct, and that, himself a parliamentary minister, he had associated himself with an act destructive of the authority of parliament."¹ "On his part," adds M. Ollivier, "it was the result only of obedience, not of wilful premeditation" (*op. cit.* p. 262). The apology may be taken for what it is worth. To France and to the world Gramont was responsible for the policy which put his country definitely into the wrong in the eyes of Europe, and enabled Bismarck to administer to her the "slap in the face" (*soufflet*)—as Gramont called it in the Chamber—by means of the mutilated "Ems telegram," which was the immediate cause of the French declaration of war on the 15th.

After the defeat of Weissenburg (August 4) Gramont resigned office with the rest of the Ollivier ministry (August 9), and after the revolution of September he went to England, returning after the war to Paris, where he died on the 18th of January 1880. His marriage in 1848 with Miss Mackinnon, a Scottish lady, remained without issue. During his retirement he published various apologies for his policy in 1870, notably *La France et la Prusse avant la guerre* (Paris, 1872).

Besides M. Ollivier's work quoted in the text, see L. Thouvenel, *Le Secrétaire de l'empereur, correspondance . . . échangée entre M. Thouvenel, le duc de Gramont, et le général comte de Flahaut 1860-1863* (2nd ed., 2 vols., 1889). A small pamphlet containing his *Souvenirs 1848-1850* was published in 1901 by his brother Antoine Léon Philibert Auguste de Gramont, duc de Lesparre.

GRAMONT, PHILIBERT, COMTE DE (1621-1707), the subject of the famous *Memoirs*, came of a noble Gascon family, said to have been of Basque origin. His grandmother, Diane d'Andouins, comtesse de Gramont, was "la belle Corisande," one of the mistresses of Henry IV. The grandson assumed that

¹ Compare with this Bismarck's remarks to Hohenlohe (Hohenlohe, *Denkwürdigkeiten*, ii. 71): "When Gramont was made minister, Bismarck said to Benedetti that this indicated that the emperor was meditating something evil, otherwise he would not have made so stupid a person minister. Benedetti replied that the emperor knew too little of him, whereupon Bismarck said that the emperor had once described Gramont to him as 'un ancien bellâtre.'" 11-2

his father Antoine II. de Gramont, viceroy of Navarre, was the son of Henry IV., and regretted that he had not claimed the privileges of royal birth. Philibert de Gramont was the son of Antoine II. by his second marriage with Claude de Montmorency, and was born in 1621, probably at the family seat of Bidache. He was destined for the church, and was educated at the *collège* of Pau, in Béarn. He refused the ecclesiastical life, however, and joined the army of Prince Thomas of Savoy, then besieging Trino in Piedmont. He afterwards served under his elder half-brother, Antoine, marshal de Gramont, and the prince of Condé. He was present at Fribourg and Nordlingen, and also served with distinction in Spain and Flanders in 1647 and 1648. He favoured Condé's party at the beginning of the Fronde, but changed sides before he was too severely compromised. In spite of his record in the army he never received any important commission either military or diplomatic, perhaps because of an incurable levity in his outlook. He was, however, made a governor of the Pays d'Aunis and lieutenant of Béarn. During the Commonwealth he visited England, and in 1662 he was exiled from Paris for paying court to Mademoiselle de la Motte Houdancourt, one of the king's mistresses. He went to London, where he found at the court of Charles II. an atmosphere congenial to his talents for intrigue, gallantry and pleasure. He married in London, under pressure from her two brothers, Elizabeth Hamilton, the sister of his future biographer. She was one of the great beauties of the English court, and was, according to her brother's optimistic account, able to fix the count's affections. She was a woman of considerable wit, and held her own at the court of Louis XIV., but her husband pursued his gallant exploits to the close of a long life, being, said Ninon de l'Enclos, the only old man who could affect the follies of youth without being ridiculous. In 1664 he was allowed to return to France. He revisited England in 1670 in connexion with the sale of Dunkirk, and again in 1671 and 1676. In 1688 he was sent by Louis XIV. to congratulate James II. on the birth of an heir. From all these small diplomatic missions he succeeded in obtaining considerable profits, being destitute of scruples whenever money was in question. At the age of seventy-five he had a dangerous illness, during which he became reconciled to the church. His penitence does not seem to have survived his recovery. He was eighty years old when he supplied his brother-in-law, Anthony Hamilton (*q.v.*), with the materials for his *Mémoires*. Hamilton said that they had been dictated to him, but there is no doubt that he was the real author. The account of Gramont's early career was doubtless provided by himself, but Hamilton was probably more familiar with the history of the court of Charles II., which forms the most interesting section of the book. Moreover Gramont, though he had a reputation for wit, was no writer, and there is no reason to suppose that he was capable of producing a work which remains a masterpiece of style and of witty portraiture. When the *Mémoires* were finished it is said that Gramont sold the MS. for 1500 francs, and kept most of the money himself. Fontenelle, then censor of the press, refused to license the book from considerations of respect to the strange old man, whose gambling, cheating and meanness were so ruthlessly exposed. But Gramont himself appealed to the chancellor and the prohibition was removed. He died on the 10th of January 1707, and the *Mémoires* appeared six years later.

Hamilton was far superior to the comte de Gramont, but he relates the story of his hero without comment, and no condemnation of the prevalent code of morals is allowed to appear, unless in an occasional touch of irony. The portrait is drawn with such skill that the count, in spite of his biographer's candour, imposes by his grand air on the reader much as he appears to have done on his contemporaries. The book is the most entertaining of contemporary memoirs, and in no other book is there a description so vivid, truthful, and graceful of the licentious court of Charles II. There are other and less flattering accounts of the count. His scandalous tongue knew no restraint, and he was a privileged person who was allowed to state even the most unpleasing truths to Louis XIV. Saint-Simon in his memoirs

describes the relief that was felt at court when the old man's death was announced.

Mémoires de la vie du comte de Gramont contenant particulièrement l'histoire amoureuse de la cour d'Angleterre sous le règne de Charles II was printed in Holland with the inscription Cologne, 1713. Other editions followed in 1715 and 1716. *Memoirs of the Life of Count de Gramont . . . translated out of the French by Mr. [Abd.] Bower* (1714), was supplemented by a "complete key" in 1719. The *Mémoires* "augmentées de notes et d'éclaircissements" was edited by Horace Walpole in 1772. In 1793 appeared in London an edition adorned with portraits engraved after originals in the royal collection. An English edition by Sir Walter Scott was published by H. G. Bohn (1846), and this with additions was reprinted in 1889, 1890, 1896, &c. Among other modern editions are an excellent one in the *Bibliothèque Charpentier* edited by M. Gustave Brunet (1859); *Mémoires . . .* (Paris, 1888) with etchings by L. Boisson after C. Delort and an introduction by H. Gausseron; *Mémoires . . .* (1889), edited by Mr H. Vizetelly; and *Memoirs . . .* (1903), edited by Mr Gordon Goodwin.

GRAMOPHONE (an invented word, formed on an inversion of "phonogram"; φωνή, sound, γράμμα, letter), an instrument for recording and reproducing sounds. It depends on the same general principles as the phonograph (*q.v.*), but it differs in certain details of construction, especially in having the sound-record cut spirally on a flat disk instead of round a cylinder.

GRAMPIANS, THE, a mass of mountains in central Scotland. Owing to the number of ramifications and ridges it is difficult to assign their precise limits, but they may be described as occupying the area between a line drawn from Dumbartonshire to the North Sea at Stonehaven, and the valley of the Spey or even Glenmore (the Caledonian Canal). Their trend is from south-west to north-east, the southern face forming the natural division between the Lowlands and Highlands. They lie in the shires of Argyll, Dumbarton, Stirling, Perth, Forfar, Kincardine, Aberdeen, Banff and Inverness. Among the highest summits are Ben Nevis, Ben Macdui, and Cairngorms, Ben Lawers, Ben More, Ben Alder, Ben Cruachan and Ben Lomond. The principal rivers flowing from the watershed northward are the Findhorn, Spey, Don, Dee and their tributaries, and southward the South Esk, Tay and Forth with their affluents. On the north the mass is wild and rugged; on the south the slope is often gentle, affording excellent pasture in many places, but both sections contain some of the finest deer-forests in Scotland. They are crossed by the Highland, West Highland and Callander to Oban railways, and present some of the finest scenery in the kingdom. The rocks consist chiefly of granite, gneiss, schists, quartzite, porphyry and diorite. Their fastnesses were originally inhabited by the northern Picts, the Caledonians who, under Galgacus, were defeated by Agricola in A.D. 84 at Mons Graupius—the false reading of which, Grampius, has been perpetuated in the name of the mountains—the site of which has not been ascertained. Some authorities place it at Ardoch; others near the junction of the Tay and Isla, or at Dalginross near Comrie; while some, contending for a position nearer the east coast, refer it to a site in west Forfarshire or to Raedykes near Stonehaven.

GRAMPOUND, a small market town in the mid-parliamentary division of Cornwall, England, 9 m. E.N.E. of Truro, and 2 m. from its station (Grampond Road) on the Great Western railway. It is situated on the river Fal, and has some industry in tanning. It retains an ancient town hall; there is a good market cross; and in the neighbourhood, along the Fal, are several early earthworks.

Grampond (Ponsmure, Graundpont, Grauntpoint, Graund-pond) and the hundred, manor and vill of Tibeste were formerly so closely associated that in 1400 the former is found styled the vill of Grauntpond called Tibeste. At the time of the Domesday Survey Tibeste was amongst the most valuable of the manors granted to the count of Mortain. The burgensic character of Ponsmure first appears in 1299. Thirty-five years later John of Eltham granted to the burgesses the whole town of Grauntpoint. This grant was confirmed in 1378 when its extent and jurisdiction were defined. It was provided that the hundred court of Powdershire should always be held there and two fairs at the feasts of St Peter in Cathedra and St Barnabas, both of which are still held, and a Tuesday market (now held on Friday)

and that it should be a free borough rendering a yearly rent to the earl of Cornwall. Two members were summoned to parliament by Edward VI. in 1553. The electors consisted of an indefinite number of freemen, about 50 in all, indirectly nominated by the mayor and corporation, which existed by prescription. The venality of the electors became notorious. In 1780 £3000 was paid for a seat; in 1812 each supporter of one of the candidates received £100. The defeat of this candidate in 1818 led to a parliamentary inquiry which disclosed a system of wholesale corruption, and in 1821 the borough was disfranchised. A former woollen trade is extinct.

GRAMPUS (*Orca gladiator*, or *Orca orca*), a cetacean belonging to the *Delphinidae* or dolphin family, characterized by its rounded head without distinct beak, high dorsal fin and large conical teeth. The upper parts are nearly uniform glossy black, and the under parts white, with a strip of the same colour over each eye. The O. Fr. word was *grapis*, *graspeis* or *craspeis*, from Med. Lat. *crassus piscis*, fat fish. This was adapted into English as *grapeys*, *graspeys*, &c., and in the 16th century becomes *grande pose* as if from *grand poisson*. The final corruption to "grampus" appears in the 18th century and was probably nautical in origin. The animal is also known as the "killer," in allusion to its ferocity in attacking its prey, which consists largely of seals, porpoises and the smaller dolphins. Its fierceness is only equalled by its voracity, which is such that in a specimen measuring 21 ft. in length, the remains of thirteen seals and thirteen porpoises were found, in a more or less digested state, while the animal appeared to have been choked in the endeavour to swallow another seal, the skin of which was found entangled in its teeth. These cetaceans sometimes hunt in packs or schools, and commit great havoc among the belugas or white whales, which occasionally throw themselves ashore to escape their persecutors. The grampus is an inhabitant of northern seas, occurring on the shores of Greenland, and having been caught, although rarely, as far south as the Mediterranean. There are numerous instances of its capture on the British coasts. (See CETACEA.)

GRANADA, LUIS DE (1504-1588), Spanish preacher and ascetic writer, born of poor parents named Sarría at Granada. He lost his father at an early age and his widowed mother was supported by the charity of the Dominicans. A child of the Alhambra, he entered the service of the alcaide as page, and, his ability being discovered, received his education with the sons of the house. When nineteen he entered the Dominican convent and in 1525 took the vows; and, with the leave of his prior, shared his daily allowance of food with his mother. He was sent to Valladolid to continue his studies and then was appointed procurator at Granada. Seven years after he was elected prior of the convent of Scala Caeli in the mountains of Cordova, which after eight years he succeeded in restoring from its ruinous state, and there he began his work as a zealous reformer. His preaching gifts were developed by the orator Juan de Avila, and he became one of the most famous of Spanish preachers. He was invited to Portugal in 1555 and became provincial of his order, declining the offer of the archbishopric of Braga but accepting the position of confessor and counsellor to Catherine, the queen regent. At the expiration of his tenure of the provincialship, he retired to the Dominican convent at Lisbon, where he lived till his death on the last day of 1588. Aiming, both in his sermons and ascetical writings, at development of the religious view, the danger of the times as he saw it was not so much in the Protestant reformation, which was an outside influence, but in the direction that religion had taken among the masses. He held that in Spain the Catholic faith was not understood by the people, and that their ignorance was the pressing danger. He fell under the suspicion of the Inquisition; his mystical teaching was said to be heretical, and his most famous book, the *Guia de Peccadores*, still a favourite treatise and one that has been translated into nearly every European tongue, was put on the Index of the Spanish Inquisition, together with his book on prayer, in 1559. His great opponent was the restless and ambitious Melchior Cano, who

stigmatized the second book as containing grave errors smacking of the heresy of the Alumbrados and manifestly contradicting Catholic faith and teaching. But in 1576 the prohibition was removed and the works of Luis de Granada, so prized by St Francis de Sales, have never lost their value. The friend of St Teresa, St Peter of Alcantara, and of all the noble minds of Spain of his day, no one among the three hundred Spanish mystics excels Luis de Granada in the beauty of a didactic style, variety of illustration and soberness of statement.

The last collected edition of his works is that published in 9 vols. at Antwerp in 1578. A biography by L. Monoz, *La Vida y virtudes de Luis de Granada* (Madrid, 1639); a study of his system by P. Rousselot in *Mystiques espagnoles* (Paris, 1867); Ticknor, *History of Spanish Literature* (vol. iii.), and Fitzmaurice Kelly, *History of Spanish Literature*, pp. 200-202 (London, 1898), may also be consulted.

GRANADA, the capital of the department of Granada, Nicaragua; 32 m. by rail S.E. of Managua, the capital of the republic. Pop. (1900) about 25,000. Granada is built on the north-western shore of Lake Nicaragua, of which it is the principal port. Its houses are of the usual central American type, constructed of adobe, rarely more than one storey high, and surrounded by courtyards with ornamental gateways. The suburbs, scattered over a large area, consist chiefly of cane huts occupied by Indians and half-castes. There are several ancient churches and convents, in one of which the interior of the chancel roof is inlaid with mother-of-pearl. An electric tramway connects the railway station and the adjacent wharves with the market, about 1 m. distant. Ice, cigars, hats, boots and shoes are manufactured, but the characteristic local industry is the production of "Panama chains," ornaments made of thin gold wire. In the neighbourhood there are large cocoa plantations; and the city has a thriving trade in cocoa, coffee, hides, cotton, native tobacco and indigo.

Granada was founded in 1523 by Francisco Fernandez de Córdoba. It became one of the wealthiest of central American cities, although it had always a keen commercial rival in Leon, which now surpasses it in size and importance. In the 17th century it was often raided by buccannercs, notably in 1606, when it was completely sacked. In 1855 it was captured and partly burned by the adventurer William Walker (see CENTRAL AMERICA: History).

GRANADA, a maritime province of southern Spain, formed in 1833 of districts belonging to Andalusia, and coinciding with the central parts of the ancient kingdom of Granada. Pop. (1900) 492,460; area, 4928 sq. m. Granada is bounded on the N. by Cordova, Jaen and Albacete, E. by Murcia and Almería, S. by the Mediterranean Sea, and W. by Malaga. It includes the western and loftier portion of the Sierra Nevada (q.v.), a vast ridge rising parallel to the sea and attaining its greatest altitudes in the Cerro de Mulhacen (11,421 ft.) and Picacho de la Veleta (11,148), which overlook the city of Granada. Lesser ranges, such as the Sierras of Parapanda, Alhama, Almirajara or Harana, adjoin the main ridge. From this central watershed the three principal rivers of the province take their rise, viz.: the Guadiana Menor, which, flowing past Guadix in a northerly direction, falls into the Guadalquivir in the neighbourhood of Ubeda; the Genil which, after traversing the Vega, or Plain of Granada, leaves the province a little to the westward of Loja and joins the Guadalquivir between Cordova and Seville; and the Rio Grande or Guadalfeo, which falls into the Mediterranean at Motril. The coast is little indented and none of its three harbours, Almuñécar, Albuñol and Motril, ranks high in commercial importance. The climate in the lower valleys and the narrow fringe along the coast is warm, but on the higher grounds of the interior is somewhat severe; and the vegetation varies accordingly from the subtropical to the alpine. The soil of the plains is very productive, and that of the Vega of Granada is considered the richest in the whole peninsula; from the days of the Moors it has been systematically irrigated, and it continues to yield in great abundance and in good quality wheat, barley, maize, wine, oil, sugar, flax, cotton, silk and almost every variety of fruit. In the mountains immediately surrounding the city of Granada

occur many kinds of alabaster, some very fine; there are also quantities of jasper and other precious stones. Mineral waters chiefly chalybeate and sulphurous, are abundant, the most important springs being those of Alhama, which have a temperature of 112° F. There are valuable iron mines, and small quantities of zinc, lead and mercury are obtained. The cane and beet sugar industries, for which there are factories at Loja, at Motril, and in the Vega, developed rapidly after the loss of the Spanish West Indies and the Philippine Islands in 1898, with the consequent decrease in competition. There are also tanneries, foundries and manufactories of woollen, linen, cotton, and rough frieze stuffs, cards, soap, spirits, gunpowder and machinery. Apart from the great highways traversing the province, which are excellent, the roads are few and ill-kept. The railway from Madrid enters the province on the north and bifurcates north-west of Guadix; one branch going eastward to Almería, the other westward to Loja, Malaga and Algeciras. Baza is the terminus of a railway from Lorca. The chief towns include Granada, the capital (pop. 1900, 75,900) with Alhama de Granada (7697), Baza (12,770), Guadix (12,652), Loja (19,143), Montefrío (10,725), and Motril (18,528). These are described in separate articles. Other towns with upwards of 7000 inhabitants are Albuñol (8646), Almuñécar (8022), Cúllar de Baza (8007), Huéscar (7763), Illora (9496) and Puebla de Don Fadrique (7420). The history of the ancient kingdom is inseparable from that of the city of Granada (*q.v.*).

GRANADA, the capital of the province, and formerly of the kingdom of Granada, in southern Spain; on the Madrid-Granada-Algeciras railway. Pop. (1900) 75,900. Granada is magnificently situated, 2195 ft. above the sea, on the north-western slope of the Sierra Nevada, overlooking the fertile lowlands known as the Vega de Granada on the west and overshadowed by the peaks of Veleta (11,148 ft.) and Mulhacen (11,421 ft.) on the south-east. The southern limit of the city is the river Genil, the Roman *Singilis* and Moorish *Shenil*, a swift stream flowing westward from the Sierra Nevada, with a considerable volume of water in summer, when the snows have thawed. Its tributary the Darro, the Roman *Salon* and Moorish *Hadaro*, enters Granada on the east, flows for upwards of a mile from east to west, and then turns sharply southward to join the main river, which is spanned by a bridge just above the point of confluence. The waters of the Darro are much reduced by irrigation works along its lower course, and within the city it has been canalized and partly covered with a roof.

Granada comprises three main divisions, the Antequeruela, the Albaicín (or Albaycín), and Granada properly so-called. The first division, founded by refugees from Antequera in 1410, consists of the districts enclosed by the Darro, besides a small area on its right, or western bank. It is bounded on the east by the gardens and hill of the Alhambra (*q.v.*), the most celebrated of all the monuments left by the Moors. The Albaicín (Moorish *Rabad al Bayazin*, "Falconers' Quarter") lies north-west of the Antequeruela. Its name is sometimes associated with that of Baeza, since, according to one tradition, it was colonized by citizens of Baeza, who fled hither in 1246, after the capture of their town by the Christians. It was long the favourite abode of the Moorish nobles, but is now mainly inhabited by gipsies and artisans. Granada, properly so-called, is north of the Antequeruela, and west of the Albaicín. The origin of its name is obscure; it has been sometimes, though with little probability, derived from *granada*, a pomegranate, in allusion to the abundance of pomegranate trees in the neighbourhood. A pomegranate appears on the city arms. The Moors, however, called Granada *Karnallah* or *Karnallah-al-Yahud*, and possibly the name is composed of the Arabic words *kurn*, "a hill," and *nallah*, "stranger,"—the "city" or "hill of strangers."

Although the city has been to some extent modernized, the architecture of its more ancient quarters has many Moorish characteristics. The streets are, as a rule, ill-lighted, ill-paved and irregular; but there are several fine squares and avenues, such as the Bibarrambra, where tournaments were held by the Moors; the spacious Plaza del Trionfo, adjoining the bull-ring,

on the north; the Alameda, planted with plane trees, and the Paseo del Salon. The business centre of the city is the Puerta Real, a square named after a gate now demolished.

Granada is the see of an archbishop. Its cathedral, which commemorates the reconquest of southern Spain from the Moors, is a somewhat heavy classical building, begun in 1529 by Diego de Siloe, and only finished in 1703. It is profusely ornamented with jasper and coloured marbles, and surmounted by a dome. The interior contains many paintings and sculptures by Alonso Cano (1601-1667), the architect of the fine west façade, and other artists. In one of the numerous chapels, known as the Chapel Royal (*Capilla Real*), is the monument of Philip I. of Castile (1478-1506), and his queen Joanna; with the tomb of Ferdinand and Isabella, the first rulers of united Spain (1452-1516). The church of Santa Maria (1705-1759), which may be regarded as an annex of the cathedral, occupies the site of the chief mosque of Granada. This was used as a church until 1661. Santa Ana (1541) also replaced a mosque; Nuestra Señora de las Angustias (1664-1671) is noteworthy for its fine towers, and the rich decoration of its high altar. The convent of San Geronimo (or Jeronimo), founded in 1492 by Ferdinand and Isabella, was converted into barracks in 1810; its church contains the tomb of the famous captain Gonsalvo or Gonzalo de Cordova (1453-1515). The Cartuja, or Carthusian monastery north of the city, was built in 1516 on Gonzalo's estate, and in his memory. It contains several fine paintings, and an interesting church of the 17th and 18th centuries.

After the Alhambra, and such adjacent buildings as the Generalife and Torres Bermejas, which are more fully described in connexion with it, the principal Moorish antiquities of Granada are the 13th-century villa known as the Cuarto Real de San Domingo, admirably preserved, and surrounded by beautiful gardens; the Alcázar de Genil, built in the middle of the 14th century as a palace for the Moorish queens; and the Casa del Cabildo, a university of the same period, converted into a warehouse in the 19th century. Few Spanish cities possess a greater number of educational and charitable establishments. The university was founded by Charles V. in 1537, and transferred to its present buildings in 1769. It is attended by about 600 students. In 1900, the primary schools of Granada numbered 22, in addition to an ecclesiastical seminary, a training-school for teachers, schools of art and jurisprudence, and museums of art and archaeology. There were twelve hospitals and orphanages for both sexes, including a leper hospital in one of the convents. Granada has an active trade in the agricultural produce of the Vega, and manufactures liqueurs, soap, paper and coarse linen and woollen fabrics. Silk-weaving was once extensively carried on, and large quantities of silk were exported to Italy, France, Germany and even America, but this industry died during the 19th century.

History.—The identity of Granada with the Iberian city of *Iliberris* or *Iliberris*, which afterwards became a flourishing Roman colony, has never been fully established; but Roman tombs, coins, inscriptions, &c., have been discovered in the neighbourhood. With the rest of Andalusia, as a result of the great invasion from the north in the 5th century, Granada fell to the lot of the Vandals. Under the caliphs of Cordova, onwards from the 8th century, it rapidly gained in importance, and ultimately became the seat of a provincial government, which, after the fall of the Omaiyad dynasty in 1031, or, according to some authorities, 1038, ranked with Seville, Jaen and others as an independent principality. The family of the Zeri, Ziri or Zeiri maintained itself as the ruling dynasty until 1090; it was then displaced by the Almohades, who were in turn overthrown by the Almoravides, in 1154. The dominion of the Almoravides continued unbroken, save for an interval of one year (1160-1161), until 1229. From 1229 to 1238 Granada formed part of the kingdom of Murcia; but in the last-named year it passed into the hands of Abu Abdullah Mahommed Ibn Al Ahmar, prince of Jaen and founder of the dynasty of the Nasrides. Al Ahmar was deprived of Jaen in 1246, but united Granada, Almería and Malaga under his sceptre, and, as the

fervour of the Christian crusade against the Moors had temporarily abated, he made peace with Castile, and even aided the Christians to vanquish the Moslem princes of Seville. At the same time he offered asylum to refugees from Valencia, Murcia and other territories in which the Moors had been overcome. Al Ahmar and his successors ruled over Granada until 1492, in an unbroken line of twenty-five sovereigns who maintained their independence partly by force, and partly by payment of tribute to their stronger neighbours. Their encouragement of commerce—notably the silk trade with Italy—rendered Granada the wealthiest of Spanish cities; their patronage of art, literature and science attracted many learned Moslems, such as the historian Ibn Khaldun and the geographer Ibn Batuta, to their court, and resulted in a brilliant civilization, of which the Alhambra is the supreme monument.

The kingdom of Granada, which outlasted all the other Moorish states in Spain, fell at last through dynastic rivalries and a barem intrigue. The two noble families of the Zegri and the Beni Serraj (better known in history and legend as the *Abencerrages*) encroached greatly upon the royal prerogatives during the middle years of the 15th century. A crisis arose in 1462, when an endeavour to control the Abencerrages resulted in the dethronement of Abu Nasr Saad, and the accession of his son, Muley Abu'l Hassan, whose name is preserved in that of Mulhacen, the loftiest peak of the Sierra Nevada, and in a score of legends. Muley Hassan weakened his position by resigning Malaga to his brother Ez Zagal, and incurred the enmity of his first wife Aisha by marrying a beautiful Spanish slave, Isabella de Solis, who had adopted the creed of Islam and taken the name of Zorayah, "morning star." Aisha or Ayesha, who thus saw her sons Abu Abdullah Mahommed (Boabdil) and Yusuf in danger of being supplanted, appealed to the Abencerrages, whose leaders, according to tradition, paid for their sympathy with their lives (see ALHAMBRA). In 1482 Boabdil succeeded in deposing his father, who fled to Malaga, but the gradual advance of the Christians under Ferdinand and Isabella forced him to resign the task of defence into the more warlike hands of Muley Hassan and Ez Zagal (1483-1486). In 1491 after the loss of these leaders, the Moors were decisively beaten; Boabdil, who had already been twice captured and liberated by the Spaniards, was compelled to sign away his kingdom; and on the 2nd of January 1492 the Spanish army entered Granada, and the Moorish power in Spain was ended. The campaign had aroused intense interest throughout Christendom; when the news reached London a special thanksgiving service was held in St Paul's Cathedral by order of Henry VII.

GRANADILLA, the name applied to *Passiflora quadrangularis*, Linn., a plant of the natural order *Passifloraceae*, a native of tropical America, having smooth, cordate, ovate or acuminate leaves; petioles bearing from 4 to 6 glands; an emetic and narcotic root; scented flowers; and a large, oblong fruit, containing numerous seeds, imbedded in a subacid edible pulp. The granadilla is sometimes grown in British hothouses. The fruits of several other species of *Passiflora* are eaten. *P. laurifolia* is the "water lemon," and *P. maliformis* the "sweet calabash" of the West Indies.

GRANARIES. From ancient times grain has been stored in greater or lesser bulk. The ancient Egyptians made a practice of preserving grain in years of plenty against years of scarcity, and probably Joseph only carried out on a large scale an habitual practice. The climate of Egypt being very dry, grain could be stored in pits for a long time without sensible loss of quality. The silo pit, as it has been termed, has been a favourite way of storing grain from time immemorial in all oriental lands. In Turkey and Persia users used to buy up wheat or barley when comparatively cheap, and store it in hidden pits against seasons of dearth. Probably that custom is not yet dead. In Malta a relatively large stock of wheat is always preserved in some hundreds of pits (silos) cut in the rock. A single silo will store from 60 to 80 tons of wheat, which, with proper precautions, will keep in good condition for four years or more. The silos are shaped like a cylinder resting on a truncated cone, and

surmounted by the same figure. The mouth of the pit is round and small and covered by a stone slab, and the inside is lined with barley straw and kept very dry. Samples are occasionally taken from the wheat as from the hold of a ship, and at any signs of fermentation the granary is cleared and the wheat turned over, but such is the dryness of these silos that little trouble of this kind is experienced.

Towards the close of the 19th century warehouses specially intended for holding grain began to multiply in Great Britain, but America is the home of great granaries, known there as elevators. There are climatic difficulties in the way of storing grain in Great Britain on a large scale, but these difficulties have been largely overcome. To preserve grain in good condition it must be kept as much as possible from moisture and heat. New grain when brought into a warehouse has a tendency to sweat, and in this condition will easily heat. If the heating is allowed to continue the quality of the grain suffers. An effectual remedy is to turn out the grain in layers, not too thick, on a floor, and to keep turning it over so as to aerate it thoroughly. Grain can thus be conditioned for storage in silos. There is reason to think that grain in a sound and dry condition can be better stored in bins or dry pits than in the open air; from a series of experiments carried out on behalf of the French government it would seem that grain exposed to the air is decomposed at $\frac{3}{4}$ times the rate of grain stored in silo or other bins.

In comparing the grain-storage system of Great Britain with that of North America it must be borne in mind that whereas Great Britain raises a comparatively small amount of grain, which is more or less rapidly consumed, grain-growing is one of the greatest industries of the United States and of Canada. The enormous surplus of wheat and maize produced in America can only be profitably dealt with by such a system of storage as has grown up there since the middle of the 19th century. The American farmer can store his wheat or maize at a moderate rate, and can get an advance on his warrant if he is in need of money. A holder of wheat in Chicago can withdraw a similar grade of wheat from a New York elevator.

Modern granaries are all built on much the same plan. The mechanical equipment for receiving and discharging grain is very similar in all modern warehouses. A granary is usually erected on a quay at which large vessels can lie and discharge. On the land side railway sidings connect the warehouse with the chief lines in its district; accessibility to a canal is an advantage. Ships are usually cleared by bucket elevators which are dipped into the cargo, though in some cases pneumatic elevators are substituted (see CONVEYORS). A travelling band with throw-off carriage will speedily distribute a heavy load of grain. Band conveyors serve equally well for charging or discharging the bins. Bins are invariably provided with hopper bottoms, and any bin can be effectively cleared by the band, which runs underneath, either in a cellar or in a specially constructed tunnel. All granaries should be provided with a sufficient plant of cleaning machinery to take from the grain impurities as would be likely to be detrimental to its storing qualities. Chief among such machines are the warehouse separators which work by sieves and air currents (see FLOUR AND FLOUR MANUFACTURE).

The typical grain warehouse is furnished with a number of chambers for grain storage which are known as silos, and may be built of wood, brick, iron or ferro-concrete. Wood silos are usually square, made of flat strips of wood nailed one on top of the other, and so overlapping each other at the corners that alternately a longitudinal and a transverse batten extends past the corner. The gaps are filled by short pieces of timber securely nailed, and the whole silo wall is thus solid. This type of bin was formerly in great favour, but it has certain drawbacks, such as the possibility of dry rot, while weevils are apt to harbour in the interstices unless lime washing is practised. Bricks and cement are good materials for constructing silos of hexagonal form, but necessitate deep foundations and substantial walls. Iron silos of circular form are used to some extent in Great Britain, but are more common in North and

South America. In their case the walls are much thinner than with any other material, but the condensation against the inner wall in wet weather is a drawback in damp climates. Cylindrical tank silos have also been made of fire-proof tiles. Ferro-concrete silos have been built on both the Monier and the Hennebique systems. In the earlier type the bin was made of an iron or steel framework filled in with concrete, but more recent structures are composed entirely of steel rods embedded in cement. Granaries built of this material have the great advantage, if properly constructed, of being free from any risk of failure even in case of uneven expansion of the material. With brick silos collapses through pressure of the stored material are not unknown.

One of the largest and most complete grain elevators or warehouses in the world belongs to the Canadian Northern Railway Company, and was erected at Port Arthur, Canada, in 1901-1904. It has a total storage capacity of 7,000,000 bushels, or 875,000 qrs. of 480 lb. The range of buildings and bins forms an oblong, and consists of two storage houses, B and C, placed between two working or receiving houses A and D (Fig. 1). The receiving houses are fed by railway sidings. House A, for example, has two sidings, one running through it and

Part
Arthur,
Canada.

repaired since they can be removed and replaced without affecting the main bin walls. It is claimed that these facers constitute the best possible protection against fire. A steel framework, covered with tiles, crowns these circular bins and contains the conveyors and spouts which are used to fill the bins. Five tunnels in the concrete bedding that supports the bins carry the belt conveyors which bring back the grain to the working house for cleaning or shipment. There are altogether in each of the storage houses 80 circular bins, each 21 ft. in diameter, and so grouped as to form 63 smaller interspace bins, or 143 bins in all. Each bin will store grain in a column 85 ft. deep, and the whole group has a capacity of 2,500,000 bushels. These bins were all constructed by the Barnett & Record Company of Minneapolis, Minnesota, U.S.A., in accordance with the Johnson & Record patent system of fire-proof tile grain storage construction. In case one of the working houses is attacked by fire the fire-proof storage houses protect not only their own contents but also the other working house, and in the event of its disablement or destruction the remaining one can be easily connected with both the storage houses and handle their contents.

Circular tank silos have not been extensively adopted in Great Britain, but a typical silo tank installation exists at the Walmsley & Smith flour mills which stand beside the Devonshire dock at Barrow-in-Furness. There four circular bins, built of riveted steel

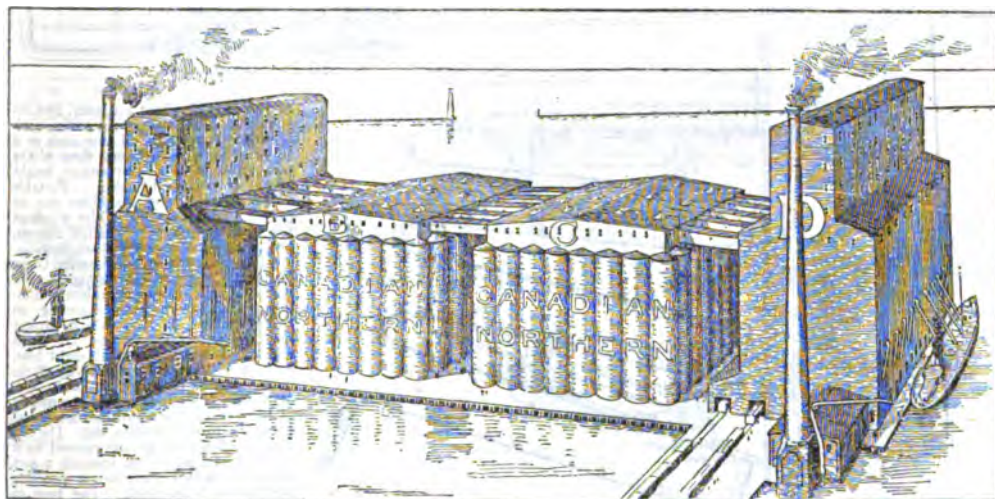

FIG. 1.

the other beside it. Each siding serves five receiving pits, and a receiving elevator of 10,000 lb capacity per minute, or 60,000 bushels per hour, can draw grain from either of two pits. Five elevators of 12,000 bushels per hour on the other side of the house serve five warehouse separators, and all the grain received or discharged is weighed, there being ten sets of automatic scales in the upper part of the house, known as the cupola. The hopper of each weigher can take a charge of 1400 bushels (84,000 lb). Grain can be conveyed either vertically or horizontally to any part of the house, into any of the bins in the annex B, or into any truck or lake steamer. This house is constructed of timber and roofed with corrugated iron. The conveyor belts are 36 in. wide; those at the top of the house are provided with throw-off carriages. The dust from the cleaning machinery is carefully collected and spouted to the furnace under the boiler house, where it is consumed. The cylindrical silo bins in the storage houses consist of hollow tiles of burned clay which, it is claimed, are fire-proof. The tiles are laid on end and are about 12 in. by 12 in. and from 4 in. to 6 in. in thickness according to the size of the bin. Each alternate course consists of grooved blocks of channel tile forming a continuous groove or belt round the bin. This groove receives a steel band acting as a tension member and resisting the lateral pressure of the grain. The steel bands once in position, the groove is completely filled with cement grout by which the steel is encased and protected. Usually the bottoms of the bins are furnished with self-discharging hoppers of weak clinker or gravel concrete finished with cement mortar. For the foundation or supporting floor reinforced concrete is frequently used. The tiles already described are faced with tiles $\frac{1}{2}$ to 1 in. thick, which are laid solid in cement mortar covering the whole exterior of the bin. Any damage to the facing tiles can easily be

plates, stand in a group on a quadrangle close to the mill warehouse. A covered gantry, through which passes a band conveyor, runs from the mill warehouse to the working silo house which stands in the central space amid the four steel tanks. The tanks are 70 ft. high, with a diameter of 45 ft., and rest on foundations of concrete and steel. Each has a separate conical roof and they are flat-bottomed, the grain resting directly on the steel and concrete foundation bed. As the load of the full tank is very heavy its even distribution on the bed is considered a point of importance. Each tank can hold about 2500 tons of wheat, which gives a total storage capacity for the four bins of over 45,000 qrs. of 480 lb. Attached to the mill warehouse is a skip elevator with a discharging capacity of 75 tons an hour. The grain is cleared by this elevator from the hold or holds of the vessel to be unloaded, and is delivered to the basement of the warehouse. Thence it is elevated to an upper storey and passed through an automatic weigher capable of taking a charge of 1 ton. From the weighing machine it can be taken, with or without a preliminary cleaning, to any floor of the warehouse, which has a total storing capacity of 8000 tons, or it can be carried by the band conveyor through the gantry to the working house of the silo installation and distributed to any one of the four tank silos. There is also a connexion by a band conveyor running through a covered gantry into the mill, which stands immediately in the rear. It is perfectly easy to turn over the contents of any tank into any other tank. The whole intake and wheat handling plant is moved by two electro-motors of 35 H.P. each, one installed in the warehouse and the other in the silo working house. Steel silo tanks have the advantage of storing a heavy stock of wheat at comparatively small capital outlay. On an average an ordinary silo bin will not hold more than 500 to

1000 qrs., but each of the bins at Barrow will contain 2500 tons or over 1100 qrs. The steel construction also reduces the risk of fire and consequently lessens the fire premium.

The important granaries at the Liverpool docks date from 1868, but have since been brought up to modern requirements. The Liverpool warehouses on the Waterloo docks have an aggregate storage area of 11½ acres, while the sister warehouses on the Birkenhead side, which stand on the margin of the great float, have an area of 11 acres. The total capacity of these warehouses is about 200,000 qrs.

The grain warehouse of the Manchester docks at Trafford wharf is locally known as the grain elevator, because it was built to a great extent on the model of an American elevator. Some of the mechanical equipment was supplied by a Manchester firm. The total capacity is 1,500,000 bushels or 40,000 tons of grain, which is stored in 226 separate bins. The granary proper stands about 340 ft. from the side of the dock, but is directly connected with the receiving tower, which rises at the

per hour; weighing in the tower; conveying grain into the warehouse and distributing it into any of the 226 bins; moving grain from bin to bin either for aerating or delivery, and simultaneously weighing in bulk at the rate of 500 tons per hour; sacking grain, weighing and loading the sacks into 40 railway trucks and 10 carts simultaneously; loading grain from the warehouse into barges or coasting craft at the rate of 150 tons per hour in bulk or of 250 sacks per hour. This warehouse is equipped with a dryer of American construction, which can deal with 50 tons of damp grain at one time, and is connected with the whole bin system so that grain can be readily moved from any bin to the dryer or conversely.

A grain warehouse at the Victoria docks, London, belonging to the London and India Docks Company (fig. 2) has a storing capacity of about 25,000 qrs. or 200,000 bushels. It is over 100 ft. high, and is built on the American plan of interlaced timbers resting on iron columns. The walls are externally cased with steel plates. The grain is stored in 56 silos, most of which are about 10 ft. square by 50 ft. deep. The intake plant has a capacity

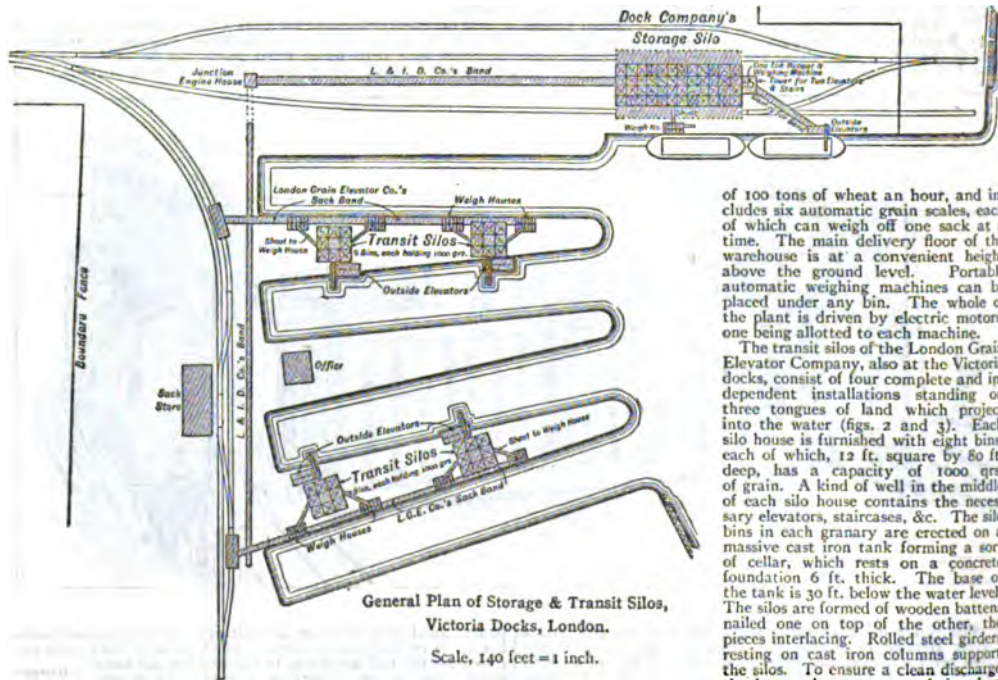

FIG. 2.

water's edge, by a band conveyor protected by a gantry. The main building is 448 ft. long by 80 ft. wide; the whole of the superstructure was constructed of wood with an external casing of brickwork and tiles. The receiving tower is fitted with a bucket elevator capable, within fairly wide limits, of adjustment to the level of the hold to be unloaded. The elevator has the large unloading capacity of 350 tons per hour, assuming it to be working in a full hold. It is supplemented by a pneumatic elevator (Duckham system) which can raise 200 tons per hour and is used chiefly in dealing with parcels of grain or in clearing grain out of holds which the ordinary elevator cannot reach. The power required to work the large elevator as well as the various band conveyors is supplied by two sets of horizontal Corliss compound engines of 500 H.P. jointly, which are fed by two Galloway boilers working at 100 lb pressure. The pneumatic elevator is driven by two sets of triple expansion vertical engines of 600 H.P. fed by three boilers working at a pressure of 160 lb. The grain received in the tower is automatically weighed. From the receiving tower the grain is conveyed into the warehouse where it is at once elevated to the top of a central tower, and is thence distributed to any of the bins by band conveyors in the usual way. The mechanical equipment of this warehouse is very complete, and the following several operations can be simultaneously effected: discharging grain from vessels in the dock at the rate of 350 tons

of 100 tons of wheat an hour, and includes six automatic grain scales, each of which can weigh off one sack at a time. The main delivery floor of the warehouse is at a convenient height above the ground level. Portable automatic weighing machines can be placed under any bin. The whole of the plant is driven by electric motors, one being allotted to each machine.

The transit silos of the London Grain Elevator Company, also at the Victoria docks, consist of four complete and independent installations standing on three tongues of land which project into the water (figs. 2 and 3). Each silo house is furnished with eight bins, each of which, 12 ft. square by 50 ft. deep, has a capacity of 1000 qrs. of grain. A kind of well in the middle of each silo house contains the necessary elevators, staircases, &c. The silo bins in each granary are erected on a massive cast iron tank forming a sort of cellar, which rests on a concrete foundation 6 ft. thick. The base of the tank is 30 ft. below the water level. The silos are formed of wooden battens nailed one on top of the other, the pieces interlacing. Rolled steel girders resting on cast iron columns support the silos. To ensure a clean discharge the hopper bottoms were designed so as to avoid joints and thus to be free from rivets or similar protuberances. The exterior of each silo house is covered with corrugated iron, and the same material is used for the roofing. No conveyors serve the silo bins, as the elevators which rise above the tops of the silos can feed any one of them by gravity. There are three delivery elevators to each granary, one with a capacity of 120 tons and the other two of 100 tons each an hour. Each silo house is served by a large elevator with a capacity of 120 tons per hour, which discharges into the elevator well inside the house. The delivery elevators discharge into a receiving shed in which there is a large hopper feeding six automatic weighing machines. Each charge as it is weighed empties itself automatically into sacks, which are then ready for loading. Each pair of warehouses is provided with a conveyor band 308 ft. long, used either for carrying sacks from the weighing sheds to railway trucks or for carrying grain in bulk to barges or trucks. Each silo house has an identical mechanical equipment apart from the delivery band it shares with its fellow warehouse. All operations in connexion with the silo houses are effected under cover. The silos are normally fed by a fleet of twenty-six of Philip's patent self-discharging lighters. These craft are hopper-bottomed and fitted with band conveyors of the ordinary type, running between the double keelson of the lighter and delivering into an elevator erected at the stern of the lighter. By this means little trimming is required after the barge, which holds

about 200 tons of grain, has been cleared. Ocean steamers of such draft as to preclude their entry into any of the up river docks are cleared at Tilbury by these lighters. It is said that grain loaded at Tilbury into these lighters can be delivered from the transit silos to railway trucks or barges in about six hours. The total storage capacity of the silos amounts to 32,000 qrs. The motive power is furnished by 14 gas engines of a total capacity of 366 H.P.

Two of the largest granaries on the continent of Europe are situated at the mouth of the Danube, at Braila and Galatz, in Rumania, and serve for both the reception and discharge of grain. At the edge of the quay on which these warehouses are built there are rails with a gauge of 11½ ft., upon which run two mechanical loading and unloading appliances. The first consists of a telescopic elevator which raises the grain and delivers it to one of the two band conveyors at the head of the apparatus. Each of these bands feeds automatic weighing machines with an hourly capacity of 75 tons. From these weighers the grain is either discharged through a manhole in the ground to a band conveyor running in a tunnel parallel to the quay wall, or it is raised by a second elevator (part of the same unloading apparatus), set at an inclined angle, which delivers at a sufficient height to load railway trucks on the siding running parallel to the quay. A turning gear is provided so as to reverse, if required, the operation of the whole apparatus, that the portion overhanging the water can be turned to the land side. The unloading capacity is 150 tons of grain per hour. If it be desired to load a ship the telescopic elevator has only to be turned round and dipped into any one of 15 wells, which

capacity of the elevators and conveyors is 100 tons of grain per hour. The mechanical equipment is so complete that four distinct operations are claimed as possible. A ship may be unloaded into silos or into the granary floors, and may simultaneously be loaded either from silos or floors with different kinds of grain. Again, a cargo may be discharged either into silos or upon the floors, and simultaneously the grain may be cleaned. Grain may also be cleared from a vessel, mixed with other grain already received, and then distributed to any desired point. With equal facility grain may be cleaned, blended with other varieties, re-stored in any section of the granary, and transferred from one ship to another.

A granary with special features of interest, erected on the quay at Dortmund, Germany, by a co-operative society, is built of brick on a base of hewn stone, with beams and supports of *Dortmund* timber. It is 78 ft. high and consists of seven floors, including basement and attic. Here again there are two sections, the larger being devoted to the storage of grain in low bins, while the smaller section consists of an ordinary silo house. Grain in sacks may be stored in the basement of the larger section which has a capacity of 1675 tons as compared with 825 tons in the silo department. Thus the total storage capacity is 2500 tons. In the silo house the bins, constructed of planks nailed one over the other, are of varying size and are capable of storing grain to a depth of 42 to 47 ft. Some of the bins have been specially adapted for receiving damp grain by being provided internally with transverse wooden arms which form square or lozenge-shaped sections. The object of this arrangement is to break up and aerate the stored grain. The



Longitudinal Elevation looking towards Barge Elevators.

Cross Section through Transit Silos.

FIG. 3.

can be filled up with grain from the land side. The capacity of each granary is 233,333 qrs.

Many large granaries have been built, in which grain is stored on open floors, in bulk or in sacks. A notable instance is the warehouse of the city of Stuttgart. This is a structure of seven floors, including a basement and entresol. An engine house accommodates two gas engines as well as a hydraulic installation for the lifts. The grain is received by an elevator from which it is carried by a second elevator to the top storey, where it is fed to a band running the length of the building. A system of pipes runs from floor to floor, and by means of the band conveyor with its movable throw-off carriage can be shot to any floor. A second band conveyor is installed in the entresol floor, and serves to convey grain either to the elevator, if it is desired to elevate it to the top floor, or to the loading shed. A second elevator runs through the centre of the building, and is provided with a spout by means of which grain can be delivered into the hopper feeding the cleaning machine, whence the grain passes into a second hopper under which is an automatic weigher; directly under this weigher the grain is sacked.

A good example of a grain warehouse on the combined silo bin and floor storage system is afforded by the granary at Mannheim on the Rhine, which has the storage capacity of 2100 tons. The building is 370 ft. in length, 78 ft. wide and 78 ft. high, and by means of transverse walls it is divided into three sections; of these one contains silos, in another section grain is stored on open floors, while the third, which is situated between the other two, is the grain-cleaning department. This granary stands by the quay side, and a ship elevator of great capacity, which serves the cleaning department, can rapidly clear any ship or barge beneath. The central or screening house section contains machinery specially designed for cleaning barley as well as wheat. The barley plant has a capacity of 5 tons per hour. There are four main elevators in this warehouse, while two more serve the screen house. The usual band conveyors fitted with throw-off carriages are provided, and are supplemented by an elaborate system of pipes which receive grain from the elevators and bands and distribute it at any required point. The plant is operated by electric motors. If desired the floors of the non-silo section can be utilized for storing other goods than grain, and to this end a lift with a capacity of 1 ton runs from the basement to the top storey. The combined

arms are of triangular section and are slightly hollowed at the base so as to bring a current of air into direct contact with the grain. The air can be warmed if necessary. The other and larger section of the granary is provided with 105 bins of moderate height arranged in groups of 21 on the five floors between the basement and attic. On the intermediate floors and the bottom floor each bin lies exactly under the bin above. Grain is not stored in these bins to a greater depth than 5 ft. The bins are fitted with removable side walls, and damp grain is only stored in certain bins aerated for half the area of their side walls through a wire mesh. The arrangements for distributing grain in this warehouse are very complete. The uncleaned grain is taken by the receiving elevator, with a lifting capacity of 20 tons per hour, to a warehouse separator, whence it is passed through an automatic weigher and is then either sacked or spouted to the main elevator (capacity 25 tons per hour) and elevated to the attic. From the head of this main elevator the grain can either be fed to a bin in one or other of the main granary floors, or shot to one of the bins in the silo house. In the attic the grain is carried by a spout and belt conveyor to one or other of the turntables, as the appliances may be termed, which serve to distribute through spouts the grain to any one of the floor or silo bins. Alternatively, the grain may be shot into the basement and there fed back into the main elevator by a band conveyor. In this way the grain may be turned over as often as it is deemed necessary. At the bottom of each bin are four apertures connected by spouts, both with the bin below and with the central vertical pipe which passes down through the centre of each group of bins. To regulate the course of the grain from bin to bin or from bin to central pipe, the connecting spouts are fitted with valves of ingenious yet simple construction which deflect the grain in any desired direction, so that the contents of two or more bins may be blended, or grain may be transferred from a bin on one floor to a bin on a lower floor, missing the bin on the floor between. The valves are controlled by chains from the basement.

With reference to the floor bins used at Dortmund, it may be observed that there are granaries built on a similar principle in the United Kingdom. It is probable that bins of moderate height are more suitable for storing grain containing a considerable amount of moisture than deep silos, whether made of wood, ferro-concrete or other material. For one thing floor bins of the Dortmund pattern can be more effectually aerated than deep silos. German wheat has many characteristics in common with British, and, especially

in north Germany, is not infrequently harvested in a more or less damp condition. In the United Kingdom, Messrs Spencer & Co., of Melksham, have erected several granaries on the floor-bin principle, and have adopted an ingenious system of "telescopic" spouting, by means of which grain may be discharged from one bin to another or at any desired point. This spouting can be applied to bins either with level floors or with hoppers bottoms, if they are arranged one above the other on the different floors, and is so constructed that an opening can be effected at certain points by simply sliding upwards a section of the spout.

National Granaries.—Wheat forms the staple food of a large proportion of the population of the British Isles, and of the total amount consumed about four-fifths is sea-borne. The stocks normally held in the country being limited, serious consequences might result from any interruption of the supply, such as might occur were Great Britain involved in war with a power or powers commanding a strong fleet. To meet this contingency it has been suggested that the State should establish granaries containing a national reserve of wheat for use in emergency, or should adopt measures calculated to induce merchants, millers, &c., to hold larger stocks than at present and to stimulate the production of home-grown wheat.

Stocks of wheat (and of flour expressed in its equivalent weight of wheat) are held by merchants, millers and farmers. Merchants' stocks are kept in granaries at ports of importation and are known as first-hand stocks. Stocks of wheat and flour in the hands of millers and of flour held by bakers are termed second-hand stocks, while farmers' stocks only consist of native wheat. Periodical returns are generally made of first-hand or port stocks, nor should a wide margin of error be possible in the case of farmers' stocks, but second-hand stocks are more difficult to gauge. Since the last decade of the 19th century the storage capacity of British mills has considerably increased. As the number of small mills has diminished the capacity of the bigger ones has increased, and proportionately their warehousing accommodation has been enlarged. At the present time first-hand stocks tend to diminish because a larger proportion of millers' holdings are in mill granaries and silo houses. The immense preponderance of steamers over sailing vessels in the grain trade has also had the effect of greatly diminishing stocks. With his cargo or parcel on a steamer a corn merchant can tell almost to a day when it will be due. In fact foreign wheat owned by British merchants is to a great extent stored in foreign granaries in preference to British warehouses. The merchant's risk is thereby lessened to a certain extent. When his wheat has been brought into a British port, to send it farther afield means extra expense. But wheat in an American or Argentine elevator may be ordered wherever the best price can be obtained for it. Options or "futures" too, have helped to restrict the size of wheat stocks in the United Kingdom. A merchant buys a cargo of wheat on passage for arrival at a definite time, and, lest the market value of grain should have depreciated by the time it arrives, he sells an option against it. In this way he hedges his deal, the option serving as insurance against loss. This is why the British corn trade finds it less risky to limit purchases to bare needs, protecting itself by option deals, than to store large quantities which may depreciate and involve their owners in loss.

Varying estimates have been made of the number of weeks' supply of breadstuffs (wheat and flour) held by millers at various seasons of the year. A table compiled by the secretary of the National Association of British and Irish Millers from returns for 1902 made by 170 milling firms showed 4.7, 4.9, 4.9 and 5 weeks' supply at the end of March, June, September and December respectively. These 170 mills were said to represent 46% of the milling capacity of the United Kingdom, and claimed to have ground 12,000,000 qrs. out of 25,349,000 qrs. milled in 1902. These were obviously large mills; it is probable that the other mills would not have shown anything like such a proportion of stock of either raw or finished material. A fair estimate of the stocks normally held by millers and bakers throughout the United Kingdom would be about four weeks' supply. First-hand stocks vary considerably, but the limits are definite, ranging from 1,000,000 to 3,500,000 qrs., the latter being a high figure. The

tendency is for first-hand stocks to decline, but two weeks' supply must be a minimum. Farmers' stocks necessarily vary with the size of the crop and the period of the year; they will range from 9 or 10 weeks on the 1st of September to a half week on the 1st of August. Taking all the stocks together, it is very exceptional for the stock of breadstuffs to fall below 7 weeks' supply. Between the cereal years 1893-1894 and 1903-1904, a period of 570 weeks, the stocks of all kinds fell below 7 weeks' supply in only 9 weeks; of these 9 weeks 7 were between the beginning of June and the end of August 1898. This was immediately after the Leiter collapse. In seven of these eleven years there is no instance of stocks falling below 8 weeks' supply. In 21 out of these 570 weeks and in 39 weeks during the same period stocks dropped below 7½ and 8 weeks' supply respectively. Roughly speaking the stock of wheat available for bread-making varies from a two to four months' supply and is at times well above the latter figure.

The formation of a national reserve of wheat, to be held at the disposal of the state in case of urgent need during war, is beset by many practical difficulties. The father of the scheme was probably *The Miller*, a well-known trade journal. In March and April 1886 two articles appeared in that paper under the heading "Years of Plenty and State Granaries," in which it was urged that to meet the risk of hostile cruisers interrupting the supplies it would be desirable to lay up in granaries on British soil and under government control a stock of wheat sufficient for 12 or alternatively 6 months' consumption. This was to be national property, not to be touched except when the fortune of war sent up the price of wheat to a famine level or caused severe distress. The State holding this large stock—a year's supply of foreign grain would have meant at least 15,000,000 qrs., and have cost about £25,000,000 exclusive of warehousing—was in peace time to sell no wheat except when it became necessary to part with stock as a precautionary measure. In that case the wheat sold was to be replaced by the same amount of new grain. The idea was to provide the country with a supply of wheat until sufficient wheat-growing soil could be broken up to make it practically self-sufficing in respect of wheat. The original suggestion fell quite flat. Two years later Captain Warren, R.N., read a paper on "Great Britain's Corn Supplies in War," before the London Chamber of Commerce, and accepted national granaries as the only practicable safeguard against what appeared to him a great peril. The representatives of the shipping interest opposed the scheme, probably because it appeared to them likely to divert the public from insisting on an all-powerful navy. The corn trade opposed the project on account of its great practical difficulties. But constant contraction of the British wheat acreage kept the question alive, and during the earlier half of the 'nineties it was a favourite theme with agriculturists. Some influential members of parliament pressed the matter on the government, who, acting, no doubt, on the advice of their military and naval experts, refused either a royal commission or a departmental committee. While the then technical advisers of the government were divided on the advisability of establishing national granaries as a defensive measure, the balance of expert opinion was adverse to the scheme. Lord Wolseley, then commander-in-chief, publicly stigmatized the theory that Great Britain might in war be starved into submission as "unmitigated humbug."

In spite of official discouragement the agitation continued, and early in 1897 the council of the Central and Associated Chambers of Agriculture, at the suggestion to a great extent of Mr R. A. Yerburgh, M.P., nominated a committee to examine the question of national wheat stores. This committee held thirteen sittings and examined fifty-four witnesses. Its report, which was published (L. G. Newman & Co., 12 Finsbury Square, London, E.C.) with minutes of the evidence taken, practically recommended that a national reserve of wheat on the lines already sketched should be formed and administered by the State, and that the government should be strongly urged to obtain the

*National
reserve.*

*Yerburgh
com-
mittee.*

appointment of a royal commission, comprising representatives of agriculture, the corn trade, shipping, and the army and navy, to conduct an exhaustive inquiry into the whole subject of the national food-supply in case of war. This recommendation was ultimately carried into effect, but not till nearly five years had elapsed. Of two schemes for national granaries put before the Yerburgh committee, one was formulated by Mr Seth Taylor, a London miller and corn merchant, who reckoned that a store of 10,000,000 qrs. of wheat might be accumulated at an average cost of 40s. per qr.—this was in the latter year of high prices—and distributed in six specially constructed granaries to be erected at London, Liverpool, Hull, Bristol, Glasgow and Dublin. The cost of the granaries was put at £7,500,000. Mr Taylor's scheme, all charges included, such as 2½% interest on capital, cost of storage (at 6d. per qr.), and 2s. per qr. for cost of replacing wheat, involved an annual expenditure of £1,250,000. The Yerburgh committee also considered a proposal to stimulate the home supply of wheat by offering a bounty to farmers for every quarter of wheat grown. This proposal has taken different shapes; some have suggested that a bounty should be given on every acre of land covered with wheat, while others would only allow the bounty on wheat raised and kept in good condition up to a certain date, say the beginning of the following harvest. It is obvious that a bounty on the area of land covered by wheat, irrespective of yield, would be a premium on poor farming, and might divert to wheat-growing land unsuitable for that purpose. The suggestion to pay a bounty of say 3s. to 5s. per qr. for all wheat grown and stacked for a certain time stands on a different basis; it is conceivable that a bounty of 5s. might expand the British production of wheat from say 7,000,000 to 9,000,000 qrs., which would mean that a bounty of £2,250,000 per annum, plus costs of administration, had secured an extra home production of 2,000,000 qrs. Whether such a price would be worth paying is another matter; the Yerburgh-committee's conclusion was decidedly in the negative. It has also been suggested that the State might subsidize millers to the extent of 2s. 6d. per sack of 280 lb. per annum on condition that each maintained a minimum supply of two months' flour. This may be taken to mean that for keeping a special stock of flour over and above his usual output a miller would be entitled to an annual subsidy of 2s. 6d. per sack. An extra stock of 10,000,000 sacks might be thus kept up at an annual cost of £1,250,000, plus the expenditure of administration, which would probably be heavy. With regard to this suggestion, it is very probable that a few large mills which have plenty of warehouse accommodation and depots all over the country would be ready to keep up a permanent extra stock of 100,000 sacks. Thus a mill of 10,000 sacks' capacity per week, which habitually maintains a total stock of 50,000 sacks, might bring up its stock to 150,000 sacks. Such a mill, being a good customer to railways, could get from them the storage it required for little or nothing. But the bulk of the mills have no such advantages. They have little or no spare warehousing room, and are not accustomed to keep any stock, sending their flour out almost as fast as it is milled. It is doubtful therefore if a bounty of 2s. 6d. per sack would have the desired effect of keeping up a stock of 10,000,000 sacks, sufficient for two to three months' bread consumption.

The controversy reached a climax in the royal commission appointed in 1903, to which was also referred the importation of raw material in war time. Its report appeared in 1905. To the question whether the unquestioned dependence of the United Kingdom on an uninterrupted supply of sea-borne breadstuffs renders it advisable or not to maintain at all times a six months' stock of wheat and flour, it returned no decided answer, or perhaps it would be more correct to say that the commission was hopelessly divided. The main report was distinctly optimistic so far as the liability of the country to harass and distress at the hands of a hostile naval power or combination of powers was concerned. But there were several dissentients, and there was hardly any portion of the report in chief which did not provoke some reservation or another. That a maritime war would cause

freights and insurance to rise in a high degree was freely admitted, and it was also admitted that the price of bread must also rise very appreciably. But, provided the navy did not break-down, the risk of starvation was dismissed. Therefore all the proposals for providing national granaries or inducing merchants and millers to carry bigger stocks were put aside as unpractical and unnecessary. The commission was, however, inclined to consider more favourably a suggestion for providing free storage for wheat at the expense of the State. The idea was that if the State would subsidize any large granary company to the extent of 6d. or 5d. per qr., grain now warehoused in foreign lands would be attracted to the British Isles. But on the whole the commission held that the main effect of the scheme would be to saddle the government with the rent of all grain stored in public warehouses in the United Kingdom without materially increasing stocks. The proposal to offer bounties to farmers to hold stocks for a longer period and to grow more wheat met with equally little favour.

To sum up the advantages of national granaries, assuming any sort of disaster to the navy, the possession of a reserve of even six months' wheat-supply in addition to ordinary stocks would prevent panic prices. On the other hand, the difficulties in the way of forming and administering such a reserve are very great. The world grows no great surplus of wheat, and to form a six months', much more a twelve months', stock would be the work of years. The government in buying up the wheat would have to go carefully if they would avoid sending up prices with a rush. They would have to buy dearly, and when they let go a certain amount of stock they would be bound to sell cheaply. A stock once formed might be held by the State with little or no disturbance of the corn market, although the existence of such an emergency stock would hardly encourage British farmers to grow more wheat. The cost of erecting, equipping and keeping in good order the necessary warehouses would be, probably, much heavier than the most liberal estimate hitherto made by advocates of national granaries. (G. F. Z.)

GRANBY, JOHN MANNERS, MARQUESS OF (1721-1770), British soldier, was the eldest son of the third duke of Rutland. He was born in 1721 and educated at Eton and Trinity College, Cambridge, and was returned as member of parliament for Grantham in 1741. Four years later he received a commission as colonel of a regiment raised by the Rutland interest in and about Leicester to assist in quelling the Highland revolt of 1745. This corps never got beyond Newcastle, but young Granby went to the front as a volunteer on the duke of Cumberland's staff, and saw active service in the last stages of the insurrection. Very soon his regiment was disbanded. He continued in parliament, combining with it military duties, making the campaign of Flanders (1747). Promoted major-general in 1755, three years later he was appointed colonel of the Royal Horse Guards (Blues). Meanwhile he had married the daughter of the duke of Somerset, and in 1754 had begun his parliamentary connexion with Cambridgeshire, for which county he sat until his death. The same year that saw Granby made colonel of the Blues, saw also the despatch of a considerable British contingent to Germany. Minden was Granby's first great battle. At the head of the Blues he was one of the cavalry leaders halted at the critical moment by Sackville, and when in consequence that officer was sent home in disgrace, Lieut.-General Lord Granby succeeded to the command of the British contingent in Ferdinand's army, having 32,000 men under his orders at the beginning of 1760. In the remaining campaigns of the Seven Years' War the English contingent was more conspicuous by its conduct than the Prussians themselves. On the 31st of July 1760 Granby brilliantly stormed Warburg at the head of the British cavalry, capturing 1500 men and ten pieces of artillery. A year later (15th of July 1761) the British defended the heights of Vellinghausen with what Ferdinand himself styled "incredible bravery." In the last campaign, at Gravenstein und Wilhelmsthal, Homburg and Cassel, Granby's men bore the brunt of the fighting and earned the greatest share of the glory.

Returning to England in 1763 the marquess found himself

the popular hero of the war. It is said that couriers awaited his arrival at all the home ports to offer him the choice of the Ordnance or the Horse Guards. His appointment to the Ordnance bore the date of the 1st of July 1763, and three years later he became commander-in-chief. In this position he was attacked by "Junius," and a heated discussion arose, as the writer had taken the greatest pains in assailing the most popular member of the Grafton ministry. In 1770 Granby, worn out by political and financial trouble, resigned all his offices, except the colonelcy of the Blues. He died at Scarborough on the 18th of October 1770. He had been made a privy councillor in 1760, lord lieutenant of Derbyshire in 1762, and LL.D. of Cambridge in 1769.

Two portraits of Granby were painted by Sir Joshua Reynolds, one of which is now in the National Gallery. His contemporary popularity is indicated by the number of inns and public-houses which took his name, and had his portrait as sign-board.

GRAN CHACO, an extensive region in the heart of South America belonging to the La Plata basin, stretching from 20° to 29° S. lat., and divided between the republics of Argentine, Bolivia and Paraguay, with a small district of south-western Matto Grosso (Brazil). Its area is estimated at from 250,000 to 425,000 sq. m., but the true Chaco region probably does not exceed 300,000 sq. m. The greater part is covered with marshes, lagoons and dense tropical jungle and forest, and is still unexplored. On its southern and western borders there are extensive tracts of open woodland, intermingled with grassy plains, while on the northern side in Bolivia are large areas of open country subject to inundations in the rainy season. In general terms the Gran Chaco may be described as a great plain sloping gently to the S.E., traversed in the same direction by two great rivers, the Pilcomayo and Bermejo, whose sluggish courses are not navigable because of sand-banks, barriers of overturned trees and floating vegetation, and confusing channels. This excludes that part of eastern Bolivia belonging to the Amazon basin, which is sometimes described as part of the Chaco. The greater part of its territory is occupied by nomadic tribes of Indians, some of whom are still unsubdued, while others, like the Matacos, are sometimes to be found on neighbouring sugar estates and estancias as labourers during the busy season. The forest wealth of the Chaco region is incalculable and apparently inexhaustible, consisting of a great variety of palms and valuable cabinet woods, building timber, &c. Its extensive tracts of "*quebracho colorado*" (*Loxopterygium Lorenzii*) are of very great value because of its use in tanning leather. Both the wood and its extract are largely exported. Civilization is slowly gaining footholds in this region along the southern and eastern borders.

GRAND ALLIANCE, WAR OF THE (alternatively called the War of the League of Augsburg), the third¹ of the great aggressive wars waged by Louis XIV. of France against Spain, the Empire, Great Britain, Holland and other states. The two earlier wars, which are redeemed from oblivion by the fact that in them three great captains, Turenne, Condé and Montecucculi, played leading parts, are described in the article **DUTCH WARS**. In the third war the leading figures are: Henri de Montmorency-Boutteville, duke of Luxemburg, the former aide-de-camp of Condé and heir to his daring method of warfare; William of Orange, who had fought against both Condé and Luxemburg in the earlier wars, and was now king of England; Vauban, the founder of the sciences of fortification and siegecraft, and Catinat, the follower of Turenne's cautious and systematic strategy, who was the first commander to receive high command in the army of Louis XIV. But as soldiers, these men—except Vauban—are overshadowed by the great figures of the preceding generation, and except for a half-dozen outstanding episodes, the war of 1689-97 was an affair of positions and manoeuvres.

It was within these years that the art and practice of war began to crystallize into the form called "linear" in its strategic

¹ The name "Grand Alliance" is applied to the coalition against Louis XIV. begun by the League of Augsburg. This coalition not only waged the war dealt with in the present article, but (with only slight modifications and with practically unbroken continuity) the war of the **SPANISH SUCCESSION** (q.v.) that followed.

and tactical aspect, and "cabinet-war" in its political and moral aspect. In the Dutch wars, and in the minor wars that preceded the formation of the League of Augsburg, there were still survivals of the loose organization, violence and wasteful barbarity typical of the Thirty Years' War; and even in the War of the Grand Alliance (in its earlier years) occasional brutalities and devastations showed that the old spirit died hard. But outrages that would have been borne in dumb misery in the old days now provoked loud indignation, and when the fierce Louvois disappeared from the scene it became generally understood that barbarity was impolitic, not only as alienating popular sympathies, but also as rendering operations a physical impossibility for want of supplies.

Thus in 1700, so far from terrorizing the country people into submission, armies systematically conciliated them by paying cash and bringing trade into the country. Formerly, wars had been fought to compel a people to abjure their faith or to change sides in some personal or dynastic quarrel. But since 1648 this had no longer been the case. The Peace of Westphalia established the general relationship of kings, priests and peoples on a basis that was not really shaken until the French Revolution, and in the intervening hundred and forty years the peoples at large, except at the highest and gravest moments (as in Germany in 1689, France in 1799 and Prussia in 1757) held aloof from active participation in politics and war. This was the beginning of the theory that war was an affair of the regular forces only, and that intervention in it by the civil population was a punishable offence. Thus wars became the business of the professional soldiers in the king's own service, and the scarcity and costliness of these soldiers combined with the purely political character of the quarrels that arose to reduce a campaign from an "intense and passionate drama" to a humdrum affair, to which only rarely a few men of genius imparted some degree of vigour, and which in the main was an attempt to gain small ends by a small expenditure of force and with the minimum of risk. As between a prince and his subjects there were still quarrels that stirred the average man—the Dragoonades, for instance, or the English Revolution—but foreign wars were "a stronger form of diplomatic notes" as Clausewitz called them, and were waged with the object of adding a codicil to the treaty of peace that had closed the last incident.

Other causes contributed to stifle the former ardour of war. Campaigns were no longer conducted by armies of ten to thirty thousand men. Large regular armies had come into fashion, and, as Guibert points out, instead of small armies charged with grand operations we find grand armies charged with small operations. The average general, under the prevailing conditions of supply and armament, was not equal to the task of commanding such armies. Any real concentration of the great forces that Louis XIV. had created was therefore out of the question, and the field armies split into six or eight independent fractions, each charged with operations on a particular theatre of war. From such a policy nothing remotely resembling the crushing of a great power could be expected to be gained. The one tangible asset, in view of future peace negotiations, was therefore a fortress, and it was on the preservation or capture of fortresses that operations in all these wars chiefly turned. The idea of the decisive battle for its own sake, as a settlement of the quarrel, was far distant; for, strictly speaking, there was no quarrel, and to use up highly trained and exceedingly expensive soldiers in gaining by brute force an advantage that might equally well be obtained by chicanery was regarded as foolish.

The fortress was, moreover, of immediate as well as contingent value to a state at war. A century of constant warfare had impoverished middle Europe, and armies had to spread over a large area if they desired to "live on the country." This was dangerous in the face of the enemy (cf. the Peninsular War), and it was also uneconomical. The only way to prevent the country people from sending their produce into the fortresses for safety was to announce beforehand that cash would be paid, at a high rate, for whatever the army needed. But even promises

rarely brought this about, and to live at all, whether on supplies brought up from the home country and stored in magazines (which had to be guarded) or on local resources, an army had as a rule to maintain or to capture a large fortress. Sieges, therefore, and manœuvres are the features of this form of war, wherein armies progressed not with the giant strides of modern war, but in a succession of short hops from one foothold to the next. This was the procedure of the average commander, and even when a more intense spirit of conflict was evoked by the Luxemburgs and Marlboroughs it was but momentary and spasmodic.

The general character of the war being borne in mind, nine-tenths of its marches and manœuvres can be almost "taken as read"; the remaining tenth, the exceptional and abnormal part of it, alone possesses an interest for modern readers.

In pursuance of a new aggressive policy in Germany Louis XIV. sent his troops, as a diplomatic menace rather than for conquest, into that country in the autumn of 1688. Some of their raiding parties plundered the country as far south as Augsburg, for the political intent of their advance suggested terrorism rather than conciliation as the best method. The league of Augsburg at once took up the challenge, and the addition of new members (Treaty of Vienna, May 1689) converted it into the "Grand Alliance" of Spain, Holland, Sweden, Savoy and certain Italian states, Great Britain, the emperor, the elector of Brandenburg, &c.

"Those who condemned the king for raising up so many enemies, admired him for having so fully prepared to defend himself and even to forestall them," says Voltaire. Louvois had in fact completed the work of organizing the French army on a regular and permanent basis, and had made it not merely the best, but also by far the most numerous in Europe, for Louis disposed in 1688 of no fewer than 375,000 soldiers and 60,000 sailors. The infantry was uniformed and drilled, and the socket bayonet and the flint-lock musket had been introduced. The only relic of the old armament was the pike, which was retained for one-quarter of the foot, though it had been discarded by the Imperialists in the course of the Turkish wars described below. The first artillery regiment was created in 1684, to replace the former semi-civilian organization by a body of artillerymen susceptible of uniform training and amenable to discipline and orders.

In 1689 Louis had six armies on foot. That in Germany, which had executed the raid of the previous autumn, was not in a position to resist the principal army of the coalition so far from support. Louvois therefore ordered it to lay waste the Palatinate, and the devastation of the country around Heidelberg, Mannheim, Spire, Oppenheim and Worms was pitilessly and methodically carried into effect in January and February. There had been devastations in previous wars, even the high-minded Turenne had used the argument of fire and sword to terrify a population or a prince, while the whole story of the last ten years of the great war had been one of incendiary armies leaving traces of their passage that it took a century to remove. But here the devastation was a purely military measure, executed systematically over a given strategic front for no other purpose than to delay the advance of the enemy's army. It differed from the method of Turenne or Cromwell in that the sufferers were not those people whom it was the purpose of the war to reduce to submission, but others who had no interest in the quarrel. It differed from Wellington's laying waste of Portugal in 1810 in that it was not done for the defence of the Palatinate against a national enemy, but because the Palatinate was where it was. The feudal theory that every subject of a prince at war was an armed vassal, and therefore an enemy of the prince's enemy, had in practice been obsolete for two centuries past; by 1690 the organization of war, its causes, its methods and its instruments had passed out of touch with the people at large, and it had become thoroughly understood that the army alone was concerned with the army's business. Thus it was that this devastation excited universal reprobation, and that, in the words

of a modern French writer, the "idea of Germany came to birth in the flames of the Palatinate."

As a military measure this crime was, moreover, quite unprofitable; for it became impossible for Marshal Duras, the French commander, to hold out on the east side of the middle Rhine, and he could think of nothing better to do than to go farther south and to ravage Baden and the Breisgau, which was not even a military necessity. The grand army of the Allies, coming farther north, was practically unopposed. Charles of Lorraine and the elector of Bavaria—lately comrades in the Turkish war (see below)—invested Mainz, the elector of Brandenburg Bonn. The latter, following the evil precedent of his enemies, shelled the town uselessly instead of making a breach in its walls and overpowering its French garrison, an incident not calculated to advance the nascent idea of German unity. Mainz, valiantly defended by Nicolas du Blé, marquis d'Uxelles, had to surrender on the 8th of September. The governor of Bonn, baron d'Asfeld, not in the least intimidated by the bombardment, held out till the army that had taken Mainz reinforced the elector of Brandenburg, and then, rejecting the hard terms of surrender offered him by the latter, he fell in resisting a last assault on the 12th of October. Only 850 men out of his 6000 were left to surrender on the 16th, and the duke of Lorraine, less truculent than the elector, escorted them safely to Thionville. Bouffiers, with another of Louis's armies, operated from Luxemburg (captured by the French in 1684 and since held) and Trarbach towards the Rhine, but in spite of a minor victory at Kochheim on the 21st of August, he was unable to relieve either Mainz or Bonn.

In the Low Countries the French marshal d'Humières, being in superior force, had obtained *special permission* to offer battle to the Allies. Leaving the garrison of Lille and Tournay to amuse the Spaniards, he hurried from Maubeuge to oppose the Dutch, who from Namur had advanced slowly on Philippeville. Coming upon their army (which was commanded by the prince of Waldeck) in position behind the river Heure, with an advanced post in the little walled town of Walcourt, he flung his advanced guard against the bridge and fortifications of this place to clear the way for his deployment beyond the river Heure (27th August). After wasting a thousand brave men in this attempt, he drew back. For a few days the two armies remained face to face, cannonading one another at intervals, but no further fighting occurred. Humières returned to the region of the Scheldt fortresses, and Waldeck to Brussels. For the others of Louis' six armies the year's campaign passed off quite uneventfully.

Simultaneously with these operations, the Jacobite cause was being fought to an issue in Ireland. War began early in 1689 with desultory engagements between the Orangemen of the north and the Irish regular army, most of which the earl of Tyrconnel had induced to declare for King James. The northern struggle after a time condensed itself into the defence of Derry and Enniskillen. The siege of the former place, begun by James himself and carried on by the French general Rosen, lasted 105 days. In marked contrast to the sieges of the continent, this was resisted by the townsmen themselves, under the leadership of the clergyman George Walker. But the relieving force (consisting of two frigates, a supply ship and a force under Major-general Percy Kirke) was dilatory, and it was not until the defenders were in the last extremity that Kirke actually broke through the blockade (July 31st). Enniskillen was less closely invested, and its inhabitants, organized by Colonel Wolsley and other officers sent by Kirke, actually kept the open field and defeated the Jacobites at Newtown Butler (July 31st). A few days later the Jacobite army withdrew from the north. But it was long before an adequate army could be sent over from England to deal with it. Marshal Schomberg (g.v.), one of the most distinguished soldiers of the time, who had been expelled from the French service as a Huguenot, was indeed sent over in August, but the army he brought, some 10,000 strong, was composed of raw recruits, and when it was assembled in camp at Dundalk to be trained for its work, it was quickly ruined by an epidemic of fever. But James failed to take advantage of his opportunity to renew the war in the north, and the relics of Schomberg's army wintered in security, covered by the Enniskillen troops. In the spring of 1690, however, more troops, this time experienced regiments from Holland, Denmark and Brandenburg, were sent, and in June, Schomberg in Ireland and Major-general Scrammore in Chester having thoroughly organized and equipped the field army, King William assumed the command

The war in Ireland, 1689-1691.

himself. Five days after his arrival he began his advance from Loughbrickland near Newry, and on the 1st of July he engaged James's main army on the river Boyne, close to Drogheda. Schoenberg was killed and William himself wounded, but the Irish army was routed.

No stand was made by the defeated party either in the Dublin or in the Waterford district. Lauzun, the commander of the French auxiliary corps in James's army, and Tyrconnel both disavowed any attempt to defend Limerick, where the Jacobite forces had reassembled; but Patrick Sarsfield (earl of Lucan), as the spokesman of the younger and more ardent of the Irish officers, pleaded for its retention. He was left, therefore, to hold Limerick, while Tyrconnel and Lauzun moved northward into Galway. Here, as in the north, the quarrel enlisted the active sympathies of the people against the invader, and Sarsfield not only surprised and destroyed the artillery train of William's army, but repulsed every assault made on the walls that Lauzun had said "could be battered down by rotten apples." William gave up the siege on the 30th of August. The failure was, however, compensated in a measure by the arrival in Ireland of an expedition under Lord Marlborough, which captured Cork and Kinsale, and next year (1691) the Jacobite cause was finally crushed by William's general Ginckell (afterwards earl of Athlone) in the battle of Aughrim in Galway (July 12th), in which St Ruth, the French commander, was killed and the Jacobite army dissipated. Ginckell, following up his victory, besieged Limerick afresh. Tyrconnel died of apoplexy while organizing the defence, and this time the town was invested by sea as well as by land. After six weeks' resistance the defenders offered to capitulate, and with the signing of the treaty of Limerick on the 1st of October the Irish war came to an end. Sarsfield and the most energetic of King James's supporters retired to France and were there formed into the famous "Irish brigade." Sarsfield was killed at the battle of Neerwinden two years later.

The campaign of 1690 on the continent of Europe is marked by two battles, one of which, Luxemburg's victory of Fleurus, belongs to the category of the world's great battles. It is described under *FLEURUS*, and the present article only deals summarily with the conditions in which it was fought. These, though they in fact led to an encounter that could, in itself, fairly be called decisive, were in closer accord with the general spirit of the war than was the decision that arose out of them.

Luxemburg had a powerful enemy in Louvois, and he had consequently been allotted only an insignificant part in the first campaign. But after the disasters of 1689 Louis re-arranged the commands on the north-east frontier so as to allow Humières, Luxemburg and Boufflers to combine for united action. "I will take care that Louvois plays fair," Louis said to the duke when he gave him his letters of service. Though apparently Luxemburg was not authorized to order such a combination himself, as senior officer he would automatically take command if it came about. The whole force available was probably close on 100,000, but not half of these were present at the decisive battle, though Luxemburg certainly practised the utmost "economy of force" as this was understood in those days (see also *NEERWINDEN*). On the remaining theatres of war, the dauphin, assisted by the duc de Lorge, held the middle Rhine, and Catinat the Alps, while other forces were in Roussillon, &c., as before. Catinat's operations are briefly described below. Those of the others need no description, for though the Allies formed a plan for a grand concentric advance on Paris, the preliminaries to this advance were so numerous and so closely interdependent that on the most favourable estimate the winter would necessarily find the Allied armies many leagues short of Paris. In fact, the Rhine offensive collapsed when Charles of Lorraine died (17th April), and the reconquest of his lost duchy ceased to be a direct object of the war.

Luxemburg began operations by drawing in from the Sambre country, where he had hitherto been stationed, to the Scheldt and "eating up" the country between Oudenarde and Ghent in the face of a Spanish army concentrated at the latter place (15th May—12th June). He then left Humières with a containing force in the Scheldt region and hurried back to the Sambre to interpose between the Allied army under Waldeck and the fortress of Dinant which Waldeck was credited with the intention of besieging. His march from Tournay to Gerpinnes was counted a model of skill—the *locus classicus* for the maxim that ruled till the advent of Napoleon—"march always in the order in which you encamp, or purpose

to encamp, or fight." For four days the army marched across country in close order, covered in all directions by reconnoitring cavalry and advanced, flank and rear guards. Under these conditions eleven miles a day was practically forced marching, and on arriving at Jeumont-sur-Sambre the army was given three days' rest. Then followed a few leisurely marches in the direction of Charleroi, during which a detachment of Boufflers's army came in, and the cavalry explored the country to the north. On news of the enemy's army being at Trazegnies, Luxemburg hurried across a ford of the Sambre above Charleroi, but this proved to be a detachment only, and soon information came in that Waldeck was encamped near Fleurus. Thereupon Luxemburg, without consulting his subordinate generals, took his army to Velaine. He knew that the enemy was marking time till the troops of Liège and the Brandenburgers from the Rhine were near enough to co-operate in the Dinant enterprise, and he was determined to fight a battle at once. From Velaine, therefore, on the morning of the 1st of July, the army moved forward to Fleurus and there won one of the most brilliant victories in the history of the Royal army. But Luxemburg was not allowed to pursue his advantage. He was ordered to hold his army in readiness to besiege either Namur, Mons, Charleroi or Ath, according as later orders dictated; and to send back the borrowed regiments to Boufflers, who was being pressed back by the Brandenburg and Liège troops. Thus Waldeck reformed his army in peace at Brussels, where William III. of England soon afterwards assumed command of the Allied forces in the Netherlands, and Luxemburg and the other marshals stood fast for the rest of the campaign, being forbidden to advance until Catinat—in Italy—should have won a battle.

In this quarter the armed neutrality of the duke of Savoy had long disquieted the French court. His personal connexions with the imperial family and his resentment against *Staffarda*, Louvois, who had on some occasion treated him with his usual patronizing arrogance, inclined him to join the Allies, while on the other hand he could hope for extensions of his scanty territory only by siding with Louis. In view of this doubtful condition of affairs the French army under Catinat had for some time been maintained on the Alpine frontier, and in the summer of 1690 Louis XIV. sent an ultimatum to Victor Amadeus to compel him to take one side or the other actively and openly. The result was that Victor Emmanuel threw in his lot with the Allies and obtained help from the Spaniards and Austrians in the Milanese. Catinat thereupon advanced into Piedmont, and won, principally by virtue of his own watchfulness and the high efficiency of his troops, the important victory of Staffarda (August 18th, 1690). This did not, however, enable him to overrun Piedmont, and as the duke was soon reinforced, he had to be content with the methodical conquest of a few frontier districts. On the side of Spain, a small French army under the duc de Noailles passed into Catalonia and there lived at the enemy's expense for the duration of the campaign.

In these theatres of war, and on the Rhine, where the disunion of the German princes prevented vigorous action, the following year, 1691, was uneventful. But in the Netherlands there were a siege, a war of manoeuvres and a cavalry combat, each in its way somewhat remarkable. The siege was that of Mons, which was, like many sieges in the former wars, conducted with much pomp by Louis XIV. himself, with Boufflers and Vauban under him. On the surrender of the place, which was hastened by red-hot shot (April 8th), Louis returned to Versailles and divided his army between Boufflers and Luxemburg, the former of whom departed to the Meuse. There he attempted by bombardment to enforce the surrender of Liège, but had to desist when the elector of Brandenburg threatened Dinant. The principal armies on either side faced one another under the command respectively of William III. and of Luxemburg. The Allies were first concentrated to the south of Namur, and Luxemburg hurried thither, but neither party found any tempting opportunity for battle, and when the cavalry had consumed all the forage available in the district, the two armies edged away gradually towards Flanders. The war of manoeuvre continued, with a

Florus,
1690.

slight balance of advantage on Luxemburg's side, until September, when William returned to England, leaving Waldeck in command of the Allied army, with orders to distribute it in winter quarters amongst the garrison towns. This gave the momentary opportunity for which Luxemburg had been watching, and at Leuze (20th Sept.) he fell upon the cavalry of Waldeck's rearguard and drove it back in disorder with heavy losses until the pursuit was checked by the Allied infantry.

In 1692¹ the Rhine campaign was no more decisive than before, although Lorge made a successful raid into Württemberg in September and foraged his cavalry in German territory till the approach of winter. The Spanish campaign was unimportant, but on the Alpine side the Allies under the duke of Savoy drove back Catinat into Dauphiné, which they ravaged with fire and sword. But the French peasantry were quicker to take arms than the Germans, and, inspired by the local gentry—amongst whom figured the heroine, Philis de la Tour du Pin (1645-1708), daughter of the marquis de la Charce—they beset every road with such success that the small regular army of the invaders was powerless. Brought practically to a standstill, the Allies soon consumed the provisions that could be gathered in, and then, fearing lest the snow should close the passes behind them, they retreated.

In the Low Countries the campaign as before began with a great siege. Louis and Vauban invested Namur on the 26th of May. The place was defended by the prince de Barbançon (who had been governor of Luxemburg when that place was besieged in 1684) and Coehoorn (q.v.), Vauban's rival in the science of fortification.

Luxemburg, with a small army, manoeuvred to cover the siege against William III.'s army at Louvain. The place fell on the 5th of June,² after a very few days of Vauban's "regular" attack, but the citadel held out until the 23rd. Then, as before, Louis returned to Versailles, giving injunctions to Luxemburg to "preserve the strong places and the country, while opposing the enemy's enterprises and subsisting the army at his expense." This negative policy, contrary to expectation, led to a hard-fought battle. William, employing a common device, announced his intention of retaking Namur, but set his army in motion for Flanders and the sea-coast fortresses held by the French. Luxemburg, warned in time, hurried towards the Scheldt, and the two armies were soon face to face again, Luxemburg about

Steenkirk, William in front of Hal. William then formed the plan of surprising Luxemburg's right wing before it could be supported by the rest of his army, relying chiefly on false information that a detected spy at his headquarters was forced to send, to mislead the duke. But Luxemburg had the material protection of a widespread net of outposts as well as a secret service, and although ill in bed when William's advance was reported, he shook off his apathy, mounted his horse and, enabled by his outpost reports to divine his opponent's plan, he met it (3rd August) by a swift concentration of his army, against which the Allies, whose advance and deployment had been mismanaged, were powerless (see STEENKIRK). In this almost accidental battle both sides suffered enormous losses, and neither attempted to bring about, or even to risk, a second resultless trial of strength. Bouffiers's army returned to the Sambre and Luxemburg and William established themselves for the rest of the season at Lessines and Ninove respectively, 13 m. apart. After both armies had broken up into their winter quarters, Louis ordered Bouffiers to attempt the capture of Charleroi. But a bombardment failed to intimidate the garrison, and when the Allies began to re-assemble, the attempt was given up (19th-21st Oct.). This failure was, however, compensated by the siege and capture of Furnes (28th Dec. 1692-7th Jan. 1693).

In 1693, the culminating point of the war was reached. It began, as mentioned above, with a winter enterprise that at

least indicated the aggressive spirit of the French generals. The king promoted his admiral, Tourville, and Catinat, the *roturier*, to the marshalship, and founded the military order of St Louis on the 10th of April. The grand army in the Netherlands this year numbered 120,000, to oppose whom William III. had only some 40,000 at hand. But at the very beginning of operations Louis, after reviewing this large force at Gembloux, broke it up, in order to send 30,000 under the dauphin to Germany, where Lorge had captured Heidelberg and seemed able, if reinforced, to overrun south Germany. But the imperial general Prince Louis of Baden took up a position near Heilbronn so strong that the dauphin and Lorge did not venture to attack him. Thus King Louis sacrificed a reality to a dream, and for the third time lost the opportunity, for which he always longed, of commanding in chief in a great battle. He himself, to judge by his letter to Monsieur on the 8th of June, regarded his action as a sacrifice of personal dreams to tangible realities. And, before the event falsified predictions, there was much to be said for the course he took, which accorded better with the prevailing system of war than a Fleurus or a Neerwinden. In this system of war the rival armies, as armies, were almost in a state of equilibrium, and more was to be expected from an army dealing with something dissimilar to itself—a fortress or a patch of land or a convoy—than from its collision with another army of equal force.

Thus Luxemburg obtained his last and greatest opportunity. He was still superior in numbers, but William at Louvain had the advantage of position. The former, authorized by his master this year "*non seulement d'empêcher les ennemis de rien entreprendre, mais d'emporter quelques avantages sur eux,*" threatened Liège, drew William over to its defence and then advanced to attack him. The Allies, however, retired to another position, between the Great and Little Geete rivers, and there, in a strongly entrenched position around Neerwinden, they were attacked by Luxemburg on the 20th of July. The long and doubtful battle, one of the greatest victories ever won by the French army, is briefly described under NEERWINDEN. It ended in a brilliant victory for the assailant, but Luxemburg's exhausted army did not pursue; William was as unshaken and determined as ever; and the campaign closed, not with a treaty of peace, but with a few manoeuvres which, by inducing William to believe in an attack on Ath, enabled Luxemburg to besiege and capture Charleroi (October).

Neerwinden was not the only French victory of the year. Catinat, advancing from Fenestrelle and Susa to the relief of Pinerolo (Pignerol), which the duke of Savoy was besieging, took up a position in formal order of battle north of the village of Marsaglia. Here on the 4th of October the duke of Savoy attacked him with his whole army, front to front. But the greatly superior regimental efficiency of the French, and Catinat's minute attention to details in arraying them, gave the new marshal a victory that was a not unworthy pendant to Neerwinden. The Piedmontese and their allies lost, it is said, 10,000 killed, wounded and prisoners, as against Catinat's 1800. But here, too, the results were trifling, and this year of victory is remembered chiefly as the year in which "people perished of want to the accompaniment of *Ts Deums*."

In 1694 (late in the season owing to the prevailing distress and famine) Louis opened a fresh campaign in the Netherlands. The armies were larger and more ineffective than ever, and William offered no further opportunities to his formidable opponent. In September, after inducing William to desist from his intention of besieging Dunkirk by appearing on his flank with a mass of cavalry,³ which had ridden from the Meuse, 100 m., in 4 days, Luxemburg gave up his command. He died on the 4th of January following, and with him the tradition of the Condé school of warfare disappeared from Europe. In Catalonia the marshal de Noailles won a victory (27th May) over the Spaniards at the ford of the Ter

¹ Marsaglia is, if not the first, at any rate, one of the first, instances of a bayonet charge by a long deployed line of infantry.

¹ Louvois died in July 1691.

² A few days before this the great naval reverse of La Hogue put an end to the projects of invading England hitherto entertained at Versailles.

³ Hussars figured here for the first time in western Europe. A regiment of them had been raised in 1692 from deserters from the Austrian service.

(Torroella, 5 m. above the mouth of the river), and in consequence captured a number of walled towns.

In 1695 William found Marshal Villeroi a far less formidable opponent than Luxembourg had been, and easily succeeded in keeping him in Flanders while a corps of the Allies invested Namur. Coehoorn directed the siege-works, and Boufflers the defence. Gradually, as in 1692, the defenders were dislodged from the town, the citadel outworks and the citadel itself, the last being assaulted with success by the "British grenadiers," as the song commemorates, on the 30th of August. Boufflers was rewarded for his sixty-seven days' defence by the grade of marshal.

By 1696 necessity had compelled Louis to renounce his vague and indefinite offensive policy, and he now frankly restricted his efforts to the maintenance of what he had won in the preceding campaigns. In this new policy he met with much success. Boufflers, Lorge, Noailles and even the incompetent Villeroi held the field in their various spheres of operations without allowing the Allies to inflict any material injury, and also (by having recourse again to the policy of living by plunder) preserving French soil from the burden of their own maintenance. In this, as before, they were powerfully assisted by the disunion and divided counsels of their heterogeneous enemies. In Piedmont, Catinat crowned his work by making peace and alliance with the duke of Savoy, and the two late enemies having joined forces captured one of the fortresses of the Milanese. The last campaign was in 1697. Catinat and Vauban besieged Ath. This siege was perhaps the most regular and methodical of the great engineer's career. It lasted 23 days and cost the assailants only 50 men. King William did not stir from his entrenched position at Brussels, nor did Villeroi dare to attack him there. Lastly, in August 1697 Vendôme, Noailles' successor, captured Barcelona. The peace of Ryswick, signed on the 30th of October, closed this war by practically restoring the *status quo ante*; but neither the ambitions of Louis nor the Grand Alliance that opposed them ceased to have force, and three years later the struggle began anew (see SPANISH SUCCESSION, WAR OF THE).

Concurrently with these campaigns, the emperor had been engaged in a much more serious war on his eastern marches against the old enemy, the Turks. This war arose in 1682 out of internal disturbances in Hungary. The campaign of the following year is memorable for all time as the last great wave of Turkish invasion. Mahommed IV. advanced from Belgrade in May, with 200,000 men, drove back the small imperial army of Prince Charles of Lorraine, and early in July invested Vienna itself. The two months' defence of Vienna by Count Rüdiger Starhemberg (1635-1701) and the brilliant victory of the relieving army led by John Sobieski, king of Poland, and Prince Charles on the 12th of September 1683, were events which, besides their intrinsic importance, possess the romantic interest of an old knightly crusade against the heathen.

But the course of the war, after the tide of invasion had ebbed, differed little from the wars of contemporary western Europe. Turkey figured rather as a factor in the balance of power than as the "infidel," and although the battles and sieges in Hungary were characterized by the bitter personal hostility of Christian to Turk which had no counterpart in the West, the war as a whole was as methodical and tedious as any Rhine or Low Countries campaign. In 1684 Charles of Lorraine gained a victory at Waitzen on the 27th of June and another at Eperies on the 18th of September, and unsuccessfully besieged Budapest.

In 1685 the Germans were uniformly successful, though a victory at Gran (August 16th) and the storming of Neuhausel (August 19th) were the only outstanding incidents. In 1686 Charles, assisted by the elector Max Emanuel of Bavaria, besieged and stormed Budapest (Sept. 2nd). In 1687 they followed up their success by a great victory at Mohacz (Aug. 12th). In 1688 the Austrians advanced still further, took Belgrade, threatened Widin and entered Bosnia. The margrave Louis of Baden, who afterward became one of the most celebrated of the methodical generals of the day, won a victory at Derbent on the 5th of September 1688, and next year, in spite of the outbreak of a general European war, he managed to win another battle at Nisch (Sept. 24th), to capture Widin (Oct. 14th) and to advance to the Balkans, but in 1690, more troops having to be withdrawn for the European war, the imperialist generals lost Nisch, Widin and Belgrade one after the other. There was, however, no repetition of the scenes of 1683, for in 1691 Louis won the battle of Safankamen (Aug. 19th). After two more desultory if successful campaigns he was called to serve in western Europe, and for three years more the war dragged on without result, until in 1697 the young Prince Eugene was appointed to command the imperialists and won a great and decisive victory at Zenta on the Theiss (Sept. 11th). This induced a last general advance of the Germans eastward, which was definitively successful and brought about the peace of Carlowitz (January 1699). (C. F. A.)

NAVAL OPERATIONS

The naval side of the war waged by the powers of western Europe from 1689 to 1697, to reduce the predominance of King

Louis XIV., was not marked by any very conspicuous exhibition of energy or capacity, but it was singularly decisive in its results. At the beginning of the struggle the French fleet kept the sea in face of the united fleets of Great Britain and Holland. It displayed even in 1690 a marked superiority over them. Before the struggle ended it had been fairly driven into port, and though its failure was to a great extent due to the exhaustion of the French finances, yet the inability of the French admirals to make a proper use of their fleets, and the incapacity of the king's ministers to direct the efforts of his naval officers to the most effective aims, were largely responsible for the result.

When the war began in 1689, the British Admiralty was still suffering from the disorders of the reign of King Charles II., which had been only in part corrected during the short reign of James II. The first squadrons were sent out late and in insufficient strength. The Dutch, crushed by the obligation to maintain a great army, found an increasing difficulty in preparing their fleet for action early. Louis XIV., a despotic monarch, with as yet unexhausted resources, had it within his power to strike first. The opportunity offered him was a very tempting one. Ireland was still loyal to King James II., and would therefore have afforded an admirable basis of operations to a French fleet. No serious attempt was made to profit by the advantage thus presented. In March 1689 King James was landed and reinforcements were prepared for him at Brest. A British squadron under the command of Arthur Herbert (afterwards Lord Torrington), sent to intercept them, reached the French port too late, and on returning to the coast of Ireland sighted the convoy off the Old Head of Kinsale on the 10th of May. The French admiral Chateaufort held on to Bantry Bay, and an indecisive encounter took place on the 11th of May. The troops and stores for King James were successfully landed. Then both admirals, the British and the French, returned home, and neither in that nor in the following year was any serious effort made by the French to gain command of the sea between Ireland and England. On the contrary, a great French fleet entered the Channel, and gained a success over the combined British and Dutch fleets on the 10th of July 1690 (see BEACRY HEAD, BATTLE OF), which was not followed up by vigorous action. In the meantime King William III. passed over to Ireland and won the battle of the Boyne. During the following year, while the cause of King James was being finally ruined in Ireland, the main French fleet was cruising in the Bay of Biscay, principally for the purpose of avoiding battle. During the whole of 1689, 1690 and 1691, British squadrons were active on the Irish coast. One raised the siege of Londonderry in July 1689, and another convoyed the first British forces sent over under the duke of Schomberg. Immediately after Beachy Head in 1690, a part of the Channel fleet carried out an expedition under the earl (afterwards duke) of Marlborough, which took Cork and reduced a large part of the south of the island. In 1691 the French did little more than help to carry away the wreckage of their allies and their own detachments. In 1692 a vigorous but tardy attempt was made to employ their fleet to cover an invasion of England (see LA HOGUE, BATTLE OF). It ended in defeat, and the allies remained masters of the Channel. The defeat of La Hogue did not do so much harm to the naval power of King Louis as has sometimes been supposed. In the next year, 1693, he was able to strike a severe blow at the Allies. The important Mediterranean trade of Great Britain and Holland, called for convenience the Smyrna convoy, having been delayed during the previous year, anxious measures were taken to see it safe on its road in 1693. But the arrangements of the allied governments and admirals were not good. They made no effort to blockade Brest, nor did they take effective steps to discover whether or not the French fleet had left the port. The convoy was seen beyond the Scilly Isles by the main fleet. But as the French admiral Tourville had left Brest for the Straits of Gibraltar with a powerful force and had been joined by a squadron from Toulon, the whole convoy was scattered or taken by him, in the latter days of June, near Lagos. But though this success was a very fair equivalent for the defeat at La

Hogue, it was the last serious effort made by the navy of Louis XIV. in this war. Want of money compelled him to lay his fleet up. The allies were now free to make full use of their own, to harass the French coast, to intercept French commerce, and to co-operate with the armies acting against France. Some of the operations undertaken by them were more remarkable for the violence of the effort than for the magnitude of the results. The numerous bombardments of French Channel ports, and the attempts to destroy St. Malo, the great nursery of the active French privateers, by infernal machines, did little harm. A British attack on Brest in June 1694 was beaten off with heavy loss. The scheme had been betrayed by Jacobite correspondents. Yet the inability of the French king to avert these enterprises showed the weakness of his navy and the limitations of his power. The protection of British and Dutch commerce was never complete, for the French privateers were active to the end. But French commerce was wholly ruined.

It was the misfortune of the allies that their co-operation with armies was largely with the forces of a power so languid and so bankrupt as Spain. Yet the series of operations directed by Russel in the Mediterranean throughout 1694 and 1695 demonstrated the superiority of the allied fleet, and checked the advance of the French in Catalonia. Contemporary with the campaigns in Europe was a long series of cruises against the French in the West Indies, undertaken by the British navy, with more or less help from the Dutch and a little feeble assistance from the Spaniards. They began with the cruise of Captain Lawrence Wright in 1690-1691, and ended with that of Admiral Nevil in 1696-1697. It cannot be said that they attained to any very honourable achievement, or even did much to weaken the French hold on their possessions in the West Indies and North America. Some, and notably the attack made on Quebec by Sir William Phips in 1690, with a force raised in the British colonies, ended in defeat. None of them was so triumphant as the plunder of Cartagena in South America by the Frenchman Pointis, in 1697, at the head of a semi-piratical force. Too often there was absolute misconduct. In the buccaneering and piratical atmosphere of the West Indies, the naval officers of the day, who were still infected with the corruption of the reign of Charles II., and who calculated on distance from home to secure their immunity, sank nearly to the level of pirates and buccaneers. The indifference of the age to the laws of health, and its ignorance of them, caused the ravages of disease to be frightful. In the case of Admiral Nevil's squadron, the admiral himself and all his captains except one, died during the cruise, and the ships were unmanned. Yet it was their own vices which caused these expeditions to fail, and not the strength of the French defence. When the war ended, the navy of King Louis XIV. had disappeared from the sea.

See Burchett, *Memoirs of Transactions at Sea during the War with France, 1688-1697* (London, 1703); Lediard, *Naval History* (London, 1735), particularly valuable for the quotations in his notes. For the West Indian voyages, Tronde, *Batailles navales de la France* (Paris, 1867); De Yonghe, *Geschiedenis van het Nederlandsche Zeewesen* (Haarlem, 1860).

GRAND CANARY (Gran Canaria), an island in the Atlantic Ocean, forming part of the Spanish archipelago of the Canary Islands (q.v.). Pop. (1900) 127,471; area 523 sq. m. Grand Canary, the most fertile island of the group, is nearly circular in shape, with a diameter of 24 m. and a circumference of 75 m. The interior is a mass of mountain with ravines radiating to the shore. Its highest peak, Los Pexos, is 6400 ft. Large tracts are covered with native pine (*P. canariensis*). There are several mineral springs on the island. Las Palmas (pop. 44,517), the capital, is described in a separate article. Telde (8978), the second place in the island, stands on a plain, surrounded by palm trees. At Atalaya, a short distance from Las Palmas, the making of earthenware vessels employs some hundreds of people, who inhabit holes made in the tufa.

GRAND CANYON, a profound gorge in the north-west corner of Arizona, in the south-western part of the United States of America, carved in the plateau region by the Colorado river. Of it Captain Dutton says: "Those who have long and carefully

studied the Grand Canyon of the Colorado do not hesitate for a moment to pronounce it by far the most sublime of all earthly spectacles"; and this is also the verdict of many who have only viewed it in one or two of its parts.

The Colorado river is made by the junction of two large streams, the Green and Grand, fed by the rains and snows of the Rocky Mountains. It has a length of about 2000 m. and a drainage area of 255,000 sq. m., emptying into the head of the Gulf of California. In its course the Colorado passes through a mountain section; then a plateau section; and finally a desert lowland section which extends to its mouth. It is in the plateau section that the Grand Canyon is situated. Here the surface of the country lies from 5000 to 9000 ft. above sea-level, being a tableland region of buttes and mesas diversified by lava intrusions, flows and cinder cones. The region consists in the main of stratified rocks bodily uplifted in a nearly horizontal position, though profoundly faulted here and there, and with some moderate folding. For a thousand miles the river has cut a series of canyons, bearing different names, which reach their culmination in the Marble Canyon, 66 m. long, and the contiguous Grand Canyon which extends for a distance of 217 m. farther down stream, making a total length of continuous canyon from 2000 to 6000 ft. in depth, for a distance of 283 m., the longest and deepest canyon in the world. This huge gash in the earth is the work of the Colorado river, with accompanying weathering, through long ages; and the river is still engaged in deepening it as it rushes along the canyon bottom.

The higher parts of the enclosing plateau have sufficient rainfall for forests, whose growth is also made possible in part by the cool climate and consequently retarded evaporation; but the less elevated portions have an arid climate, while the climate in the canyon bottom is that of the true desert. Thus the canyon is really in a desert region, as is shown by the fact that only two living streams enter the river for a distance of 500 m. from the Green river to the lower end of the Grand Canyon; and only one, the Kanab Creek, enters the Grand Canyon itself. This, moreover, is dry during most of the year. In spite of this lack of tributaries, a large volume of water flows through the canyon at all seasons of the year, some coming from the scattered tributaries, some from springs, but most from the rains and snows of the distant mountains about the headwaters. Owing to enclosure between steeply rising canyon walls, evaporation is retarded, thus increasing the possibility of the long journey of the water from the mountains to the sea across a vast stretch of arid land.

The river in the canyon varies from a few feet to an unknown depth, and at times of flood has a greatly increased volume. The river varies in width from 50 ft. in some of the narrow Granite Gorges, where it bathes both rock walls, to 500 or 600 ft. in more open places. In the 283 m. of the Marble and Grand Canyons, the river falls 2330 ft., and at one point has a fall of 210 ft. in 10 m. The current velocity varies from 3 to 20 or more miles per hour, being increased in places by low falls and rapids; but there are no high falls below the junction of the Green and Grand.

Besides the canyons of the main river, there are a multitude of lateral canyons occupied by streams at intervals of heavy rain. As Powell says, the region "is a composite of thousands, and tens of thousands of gorges." There are "thousands of gorges like that below Niagara Falls, and there are a thousand Yosemite." The largest of all, the Grand Canyon, has an average depth of 4000 ft. and a width of 4½ to 12 m. For a long distance, where crossing the Kaibab plateau, the depth is 6000 ft. For much of the distance there is an inner narrower gorge sunk in the bottom of a broad outer canyon. The narrow gorge is in some places no more than 3500 ft. wide at the top. To illustrate the depth of the Grand Canyon, Powell writes: "Pluck up Mount Washington (6203 ft. high) by the roots to the level of the sea, and drop it head first into the Grand Canyon, and the dam will not force its waters over the wall."

While there are notable differences in the Grand Canyon from point to point, the main elements are much alike throughout

its length, and are due to the succession of rock strata revealed in the canyon walls. At the base, for some 800 ft., there is a complex of crystalline rocks of early geological age, consisting of gneiss, schist, slate and other rocks, greatly plicated and traversed by dikes and granite intrusions. This is an ancient mountain mass, which has been greatly denuded. On it rest a series of durable quartzite beds inclined to the horizontal, forming about 800 ft. more of the lower canyon wall. On this come first 300 ft. of greenish sandstones and then 700 ft. of bedded sandstone and limestone strata, some massive and some thin, which on weathering form a series of alcoves. These beds, like those above, are in nearly horizontal position. Above this comes 1600 ft. of limestone—often a beautiful marble, as in the Marble Canyon, but in the Grand Canyon stained a brilliant red by iron oxide washed from overlying beds. Above this "red wall" are 800 ft. of grey and bright red sandstone beds looking "like vast ribbons of landscape." At the top of the canyon is 1000 ft. of limestone with gypsum and chert, noted for the pinnacles and towers which denudation has developed. It is these different rock beds, with their various colours, and the differences in the effect of weathering upon them, that give the great variety and grandeur to the canyon scenery. There are towers and turrets, pinnacles and alcoves, cliffs, ledges, crags and moderate talus slopes, each with its characteristic colour and form according to the set of strata in which it lies. The main river has cleft the plateau in a huge gash; innumerable side gorges have cut it to right and left; and weathering has etched out the cliffs and crags and helped to paint it in the gaudy colour bands that stretch before the eye. There is grandeur here and weirdness in abundance, but beauty is lacking. Powell puts the case graphically when he writes: "A wall of homogeneous granite like that in the Yosemite is but a naked wall, whether it be 1000 or 5000 ft. high. Hundreds and thousands of feet mean nothing to the eye when they stand in a meaningful front. A mountain covered by pure snow 10,000 ft. high has but little more effect on the imagination than a mountain of snow 1000 ft. high—it is but more of the same thing; but a façade of seven systems of rock has its sublimity multiplied sevenfold."

To the ordinary person most of the Grand Canyon is at present inaccessible, for, as Powell states, "a year scarcely suffices to see it all"; and "it is a region more difficult to traverse than the Alps or the Himalayas." But a part of the canyon is now easily accessible to tourists. A trail leads from the Atchison, Topeka & Santa Fé railway at Flagstaff, Arizona; and a branch line of the railway extends from Williams, Arizona, to a hotel on the very brink of the canyon. The plateau, which in places bears an open forest, mainly of pine, varies in elevation, but is for the most part a series of fairly level terrace tops with steep faces, with mesas and buttes here and there, and, especially near the huge extinct volcano of San Francisco mountain, with much evidence of former volcanic activity, including numerous cinder cones. The traveller comes abruptly to the edge of the canyon, at whose bottom, over a mile below, is seen the silvery thread of water where the muddy torrent rushes along on its never-ceasing task of sawing its way into the depths of the earth. Opposite rise the highly coloured and terraced slopes of the other canyon wall, whose crest is fully 12 m. distant.

Down by the river are the folded rocks of an ancient mountain system, formed before vertebrate life appeared on the earth, then worn to an almost level condition through untold ages of slow denudation. Slowly, then, the mountains sank beneath the level of the sea, and in the Carboniferous Period—about the time of the formation of the coal-beds—sediments began to bury the ancient mountains. This lasted through other untold ages until the Tertiary Period—through much of the Palaeozoic and all of the Mesozoic time—and a total of from 12,000 to 16,000 ft. of sediments were deposited. Since then erosion has been dominant, and the river has eaten its way down to, and into, the deeply buried mountains, opening the strata for us to read, like the pages of a book. In some parts of the plateau region as much as 30,000 ft. of rock have been stripped away, and over

an area of 200,000 sq. m. an average of over 6000 ft. has been removed.

The Grand Canyon was probably discovered by G. L. de Cardenas in 1540, but for 329 years the inaccessibility of the region prevented its exploration. Various people visited parts of it or made reports regarding it; and the Ives Expedition of 1858 contains a report upon the canyon written by Prof. J. S. Newberry. But it was not until 1869 that the first real exploration of the Grand Canyon was made. In that year Major J. W. Powell, with five associates (three left the party in the Grand Canyon), made the complete journey by boat from the junction of the Green and Grand rivers to the lower end of the Grand Canyon. This hazardous journey ranks as one of the most daring and remarkable explorations ever undertaken in North America; and Powell's descriptions of the expedition are among the most fascinating accounts of travel relating to the continent. Powell made another expedition in 1871, but did not go the whole length of the canyon. The government survey conducted by Lieut. George M. Wheeler also explored parts of the canyon, and C. E. Dutton carried on extensive studies of the canyon and the contiguous plateau region. In 1890 Robert B. Stanton, with six associates, went through the canyon in boats, making a survey to determine the feasibility of building a railway along its base. Two other parties, one in 1896 (Nat. Galloway and William Richmond) the other in 1897 (George F. Flavel and companion), have made the journey through the canyon. So far as there is record these are the only four parties that have ever made the complete journey through the Grand Canyon. It has sometimes been said that James White made the passage of the canyon before Powell did; but this story rests upon no real basis.

For accounts of the Grand Canyon of the Colorado see J. W. Powell, *Explorations of the Colorado River of the West and its Tributaries* (Washington, 1875); J. W. Powell, *Canyons of the Colorado* (Meadville, Pa., 1895); F. S. Dellenbaugh, *The Romance of the Colorado River* (New York, 1902); Capt. C. E. Dutton, *Tertiary History of the Grand Canyon District, with Atlas* (Washington, 1882), being Monograph No. 2, U.S. Geological Survey. See also the excellent topographic map of the Grand Canyon prepared by F. E. Matthes and published by the U.S. Geological Survey. (R. S. T.)

GRAND-DUKE (Fr. *grand-duc*, Ital. *granduca*, Ger. *Grossherzog*), a title borne by princes ranking between king and duke. The dignity was first bestowed in 1567 by Pope Pius V. on Duke Cosimo I. of Florence, his son Francis obtaining the emperor's confirmation in 1576; and the predicate "Royal Highness" was added in 1699. In 1806 Napoleon created his brother-in-law Joachim Murat, grand-duke of Berg, and in the same year the title was assumed by the landgrave of Hesse-Darmstadt, the elector of Baden, and the new ruler of the secularized bishopric of Würzburg (formerly Ferdinand III., grand-duke of Tuscany) on joining the Confederation of the Rhine. At the present time, according to the decision of the Congress of Vienna, the title is borne by the sovereigns of Luxemburg, Saxe-Weimar (grand-duke of Saxony), Mecklenburg-Schwerin, Mecklenburg-Strelitz, and Oldenburg (since 1829), as well as by those of Hesse-Darmstadt and Baden. The emperor of Austria includes among his titles those of grand-duke of Cracow and Tuscany, and the king of Prussia those of grand-duke of the Lower Rhine and Posen. The title is also retained by the dispossessed Habsburg-Lorraine dynasty of Tuscany.

Grand-duke is also the conventional English equivalent of the Russian *veltkiy knyaz*, more properly "grand-prince" (Ger. *Grossfürst*), at one time the title of the rulers of Russia, who, as the eldest born of the house of Rurik, exercised overlordship over the *udyelniye knyazi* or local princes. On the partition of the inheritance of Rurik, the eldest of each branch assumed the title of grand-prince. Under the domination of the Golden Horde the right to bestow the title *veltkiy knyaz* was reserved by the Tatar Khan, who gave it to the prince of Moscow. In Lithuania this title also symbolized a similar overlordship, and it passed to the kings of Poland on the union of Lithuania with the Polish republic. The style of the emperor of Russia now

includes the titles of grand-duke (*veliki knyaz*) of Smolensk, Lithuania, Volhynia, Podolia and Finland. Until 1886 this title grand-duke or grand-duchess, with the style "Imperial Highness," was borne by all descendants of the imperial house. It is now confined to the sons and daughters, brothers and sisters, and male grandchildren of the emperor. The other members of the imperial house bear the title of prince (*knyaz*) and princess (*knyaginya*, if married, *knyazhna*, if unmarried) with the style of "Highness." The emperor of Austria, as king of Hungary, also bears this title as "grand-duke" of Transylvania, which was erected into a "grand-princedom" (*Grossfürstentum*) in 1765 by Maria Theresa.

GRANDEE (Span. *Grande*), a title of honour borne by the highest class of the Spanish nobility. It would appear to have been originally assumed by the most important nobles to distinguish them from the mass of the *ricos hombres*, or great barons of the realm. It was thus, as Selden points out, not a general term denoting a class, but "an additional dignity not only to all dukes, but to some marquesses and condes also" (*Titles of Honor*, ed. 1672, p. 478). It formerly implied certain privileges, notably that of sitting covered in the royal presence. Until the time of Ferdinand and Isabella, when the power of the territorial nobles was broken, the grantees had also certain more important rights, e.g. freedom from taxation, immunity from arrest save at the king's express command, and even—in certain cases—the right to renounce their allegiance and make war on the king. Their number and privileges were further restricted by Charles I. (the emperor Charles V.), who reserved to the crown the right to bestow the title. The grantees of Spain were further divided into three classes: (1) those who spoke to the king and received his reply with their heads covered; (2) those who addressed him uncovered, but put on their hats to hear his answer; (3) those who awaited the permission of the king before covering themselves. All grantees were addressed by the king as "my cousin" (*mi primo*), whereas ordinary nobles were only qualified as "my kinsman" (*mi pariente*). The title of "grantee," abolished under King Joseph Bonaparte, was revived in 1834, when by the *Realcédulo real* grantees were given precedence in the Chamber of Peers. The designation is now, however, purely titular, and implies neither privilege nor power.

GRAND FORKS, a city in the Boundary district of British Columbia; situated at the junction of the north and south forks of the Kettle river, 2 m. N. of the international boundary. Pop. (1908) about 2500. It is in a good agricultural district, but owes its importance largely to the erection here of the extensive smelting plant of the Granby Consolidated Company, which smelts the ores obtained from the various parts of the Boundary country, but chiefly those from the Knob Hill and Old Ironsides mines. The Canadian Pacific railway, as well as the Great Northern railway, runs to Grand Forks, which thus has excellent railway communication with the south and east.

GRAND FORKS, a city and the county-seat of Grand Forks county, North Dakota, U.S.A., at the junction of the Red river (of the North) and Red Lake river (whence its name), about 80 m. N. of Fargo. Pop. (1900) 7652, of whom 2781 were foreign-born; (1905) 10,127; (1910) 27,888. It is served by the Northern Pacific and the Great Northern railways, and has a considerable river traffic, the Red river (when dredged) having a channel 60 ft. wide and 4 ft. deep at low water below Grand Forks. At University, a small suburb, is the University of North Dakota (co-educational; opened 1884). Affiliated with it is Wesley College (Methodist Episcopal), now at Grand Forks (with a campus adjoining that of the University), but formerly the Red River Valley University at Wahpeton, North Dakota. In 1907-1908 the University had 57 instructors and 861 students; its library had 25,000 bound volumes and 5000 pamphlets. At Grand Forks, also, are St Bernard's Ursuline Academy (Roman Catholic) and Grand Forks College (Lutheran). Among the city's principal buildings are the public library, the Federal building and a Y.M.C.A. building. As the centre of the great wheat valley of the Red river, it has a busy trade in wheat, flour and agricultural machinery and implements, as well as large

jobbing interests. There are railway car-shops here, and among the manufactures are crackers, brooms, bricks and tiles and cement. The municipality owns its water-works and an electric lighting plant for street lighting. In 1801 John Cameron (d. 1804) erected a temporary trading post for the North-West Fur Company on the site of the present city; it afterwards became a trading post of the Hudson's Bay Company. The first permanent settlement was made in 1871, and Grand Forks was reached by the Northern Pacific and chartered as a city in 1881.

GRAND HAVEN, a city, port of entry, and the county-seat of Ottawa county, Michigan, U.S.A., on Lake Michigan, at the mouth of Grand river, 30 m. W. by N. of Grand Rapids and 78 m. E. of Milwaukee. Pop. (1900) 4743, of whom 1277 were foreign-born; (1904) 5239, (1910) 5856. It is served by the Grand Trunk and the Père Marquette railways, and by steamboat lines to Chicago, Milwaukee and other lake ports, and is connected with Grand Rapids and Muskegon by an electric line. The city manufactures pianos, refrigerators, printing presses and leather, is a centre for the shipment of fruit and celery; and has valuable fisheries near—fresh, salt and smoked fish, especially whitefish, are shipped in considerable quantities. Grand Haven is the port of entry for the Customs District of Michigan, and has a small export and import trade. The municipality owns and operates its water-works and electric-lighting plant. A trading post was established here about 1821 by an agent of the American Fur Company, but the permanent settlement of the city did not begin until 1834. Grand Haven was laid out as a town in 1836, and was chartered as a city in 1867.

GRANDIER, URBAN (1590-1634), priest of the church of Sainte Croix at Loudun in the department of Vienne, France, was accused of witchcraft in 1632 by some hysterical novices of the Carmelite convent, where the trial, protracted for two years, was held. Grandier was found guilty and burnt alive at Loudun on the 18th of August 1634.

GRAND ISLAND, a city and the county-seat of Hall county, Nebraska, U.S.A., on the Platte river, about 154 m. W. by S. of Omaha. Pop. (1900) 7554 (1339 foreign-born); (1910) 10,326. It is served by the Union Pacific, the Chicago, Burlington & Quincy, and the St Joseph & Grand Island railways, being the western terminus of the last-named line and a southern terminus of a branch of the Union Pacific. The city is situated on a slope skirting the broad, level bottom-lands of the Platte river, in the midst of a fertile farming region. Grand Island College (Baptist; co-educational) was established in 1892 and the Grand Island Business and Normal College in 1890; and the city is the seat of a state Sailors' and Soldiers' Home, established in 1888. Grand Island has a large wholesale trade in groceries, fruits, &c.; is an important horse-market, and has large stock-yards. There are shops of the Union Pacific in the city, and among its manufactures are beet-sugar—Grand Island is in one of the principal beet-sugar-growing districts of the state—brooms, wire fences, confectionery and canned corn. The most important industry of the county is the raising and feeding of sheep and neat cattle. A "Grand Island" was founded in 1857, and was named from a large island (nearly 50 m. long) in the Platte opposite its site; but the present city was laid out by the Union Pacific in 1866. It was chartered as a city in 1873.

GRANDMONTINES, a religious order founded by St Stephen of Thiers in Auvergne towards the end of the 11th century. St Stephen was so impressed by the lives of the hermits whom he saw in Calabria that he desired to introduce the same manner of life into his native country. He was ordained, and in 1073 obtained the pope's permission to establish an order. He betook himself to Auvergne, and in the desert of Muret, near Limoges, he made himself a hut of branches of trees and lived there for some time in complete solitude. A few disciples gathered round him, and a community was formed. The rule was not reduced to writing until after Stephen's death, 1124. The life was eremitical and very severe in regard to silence, diet and bodily austerities; it was modelled after the rule of the Camaldolese, but various regulations were adopted from the Augustinian canons. The superior was called the "Corrector."

About 1150 the hermits, being compelled to leave Muret, settled in the neighbouring desert of Grandmont, whence the order derived its name. Louis VII. founded a house at Vincennes near Paris, and the order had a great vogue in France, as many as sixty houses being established by 1170, but it seems never to have found favour out of France; it had, however, a couple of cells in England up to the middle of the 15th century. The system of lay brothers was introduced on a large scale, and the management of the temporals was in great measure left in their hands; the arrangement did not work well, and the quarrels between the lay brothers and the choir monks were a constant source of weakness. Later centuries witnessed mitigations and reforms in the life, and at last the order came to an end just before the French Revolution. There were two or three convents of Grandmontine nuns. The order played no great part in history.

See Helyot, *Hist. des ordres religieux* (1714), vii. cc. 54, 55; Max Heimbucher, *Orden und Kongregationen* (1896), i. § 31; and the art. in *Wetzer und Welte, Kirchenlexicon* (ed. 2), and in Herzog, *Realencyclopädie* (ed. 3). (E. C. B.)

GRAND RAPIDS, a city and the county-seat of Kent county, Michigan, U.S.A., at the head of navigation on the Grand river, about 30 m. from Lake Michigan and 145 m. W.N.W. of Detroit. Pop. (1890) 60,278; (1900) 87,565, of whom 23,896 were foreign-born and 604 were negroes; (1910 census) 112,571. Of the foreign-born population in 1900, 11,137 were Hollanders; 3318 English-Canadians; 3253 Germans; 1237 Irish; 1060 from German Poland; and 1026 from England. Grand Rapids is served by the Michigan Central, the Lake Shore & Michigan Southern, the Grand Trunk, the Père Marquette and the Grand Rapids & Indiana railways, and by electric interurban railways. The valley here is about 2 m. wide, with a range of hills on either side, and about midway between these hills the river flows over a limestone bed, falling about 18 ft. in 1 m. Factories and mills line both banks, but the business blocks are nearly all along the foot of the E. range of hills; the finest residences command picturesque views from the hills farther back, the residences on the W. side being less pretentious and standing on bottom-lands. The principal business thoroughfares are Canal, Monroe and Division streets. Among the important buildings are the United States Government building (Grand Rapids is the seat of the southern division of the Federal judicial district of western Michigan), the County Court house, the city hall, the public library (presented by Martin A. Ryerson of Chicago), the Manufacturer's building, the *Evening Press* building, the Michigan Trust building and several handsome churches. The principal charitable institutions are the municipal Tuberculosis Sanatorium; the city hospital; the Union Benevolent Association, which maintains a home and hospital for the indigent, together with a training school for nurses; Saint John's orphan asylum (under the superintendence of the Dominican Sisters); Saint Mary's hospital (in charge of the Sisters of Mercy); Butterworth hospital (with a training school for nurses); the Woman's Home and Hospital, maintained largely by the Woman's Christian Temperance Union; the Aldrich Memorial Deaconess' Home; the D. A. Blodgett Memorial Children's Home, and the Michigan Masonic Home. About 1 m. N. of the city, overlooking the river, is the Michigan Soldiers' Home, with accommodation for 500. On the E. limits of the city is Reed's Lake, a popular resort during the summer season. The city is the see of Roman Catholic and Protestant Episcopal bishops. In 1907-1908, through the efforts of a committee of the Board of Trade, interest was aroused in the improvement of the city, appropriations were made for a "city plan," and flood walls were completed for the protection of the lower parts of the city from inundation. The large quantities of fruit, cereals and vegetables from the surrounding country, and ample facilities for transportation by rail and by the river, which is navigable from below the rapids to its mouth, make the commerce and trade of Grand Rapids very important. The manufacturing interests are greatly promoted by the fine water-power, and as a furniture centre the city has a world-wide reputation—the value of the furniture manufactured within its

limits in 1904 amounted to \$9,409,097, about 5.5% of the value of all furniture manufactured in the United States. Grand Rapids manufactures carpet sweepers—a large proportion of the whole world's product,—flour and grist mill products, foundry and machine-shop products, planing-mill products, school seats, wood-working tools, fly paper, calcined plaster, barrels, kegs, carriages, wagons, agricultural implements and bricks and tile. The total factory product in 1904 was valued at \$31,032,589, an increase of 39.6% in four years.

On the site of Grand Rapids there was for a long time a large Ottawa Indian village, and for the conversion of the Indians a Baptist mission was established in 1824. Two years later a trading post joined the mission, in 1833 a saw mill was built, and for the next few years the growth was rapid. The settlement was organized as a town in 1834, was incorporated as a village in 1838, and was chartered as a city in 1850, the city charter being revised in 1857, 1871, 1877 and 1905.

GRAND RAPIDS, a city and the county-seat of Wood county, Wisconsin, U.S.A., on both sides of the Wisconsin river, about 137 m. N.W. of Milwaukee. Pop. (1900) 4493, of whom 1073 were foreign-born; (1905) 6157; (1910) 6521. It is served by the Minneapolis, St Paul & Sault Ste Marie, the Green Bay & Western, the Chicago & North-Western, and the Chicago, Milwaukee & St Paul railways. It is a railway and distributing centre, and has manufactories of lumber, sash, doors and blinds, hubs and spokes, woodenware, paper, wood-pulp, furniture and flour. The public buildings include a post office, court house, city hall, city hospital and the T. B. Scott Free Public Library (1892). The city owns and operates its water-works; the electric-lighting and telephone companies are co-operative. Grand Rapids was first chartered as a city in 1869. That part of Grand Rapids on the west bank of the Wisconsin river was formerly the city of Centralia (pop. in 1890, 1435); it was annexed in 1900.

GRANDSON (Ger. *Grandsee*), a town in the Swiss canton of Vaud, near the south-western end of the Lake of Neuchâtel, and by rail 20 m. S.W. of Neuchâtel and 3 m. N. of Yverdon. Its population in 1900 was 1771, mainly French-speaking and Protestant. Its ancient castle was long the home of a noted race of barons, while in the very old church (once belonging to a Benedictine monastery) there are a number of Roman columns, &c., from Avenches and Yverdon. It has now a tobacco factory. Its lords were vassals of the house of Savoy, till in 1475 the castle was taken by the Swiss at the beginning of their war with Charles the Bold, duke of Burgundy, whose ally was the duchess of Savoy. It was retaken by Charles in February 1476, and the garrison put to death. The Swiss hastened to revenge this deed, and in a famous battle (2nd March 1476) defeated Charles with great loss, capturing much booty. The scene of the battle was between Concise and Corcelles, north-east of the town, and is marked by several columns, perhaps ancient menhirs. Grandson was thenceforward till 1798 ruled in common by Berne and Fribourg, and then was given to the canton du Léman, which in 1803 became that of Vaud.

See F. Chabloz, *La Bataille de Grandson* (Lausanne, 1897).

GRANET, FRANÇOIS MARIUS (1777-1849), French painter, was born at Aix in Provence, on the 17th of December 1777; his father was a small builder. The boy's strong desires led his parents to place him—after some preliminary teaching from a passing Italian artist—in a free school of art directed by M. Constantin, a landscape painter of some reputation. In 1793 Granet followed the volunteers of Aix to the siege of Toulon, at the close of which he obtained employment as a decorator in the arsenal. Whilst a lad he had, at Aix, made the acquaintance of the young comte de Forbin, and upon his invitation Granet, in the year 1797, went to Paris. De Forbin was one of the pupils of David, and Granet entered the same studio. Later he got possession of a cell in the convent of Capuchins, which, having served for a manufactory of assignats during the Revolution, was afterwards inhabited almost exclusively by artists. In the changing lights and shadows of the corridors of the Capuchins, Granet found the materials for that one picture to the painting of which, with varying success, he devoted his life.

In 1802 he left Paris for Rome, where he remained until 1810, when he returned to Paris, bringing with him besides various other works one of fourteen repetitions of his celebrated *Chorur des Capucins*, executed in 1811. The figures of the monks celebrating mass are taken in this subject as a substantive part of the architectural effect, and this is the case with all Granet's works, even with those in which the figure subject would seem to assert its importance, and its historical or romantic interest. "Stella painting a Madonna on his Prison Wall," 1810 (Leuchtenberg collection); "Sodoma à l'hôpital," 1815 (Louvre); "Basilique basse de St François d'Assise," 1823 (Louvre); "Rachat de prisonniers," 1831 (Louvre); "Mort de Poussin," 1834 (Villa Demidoff, Florence), are among his principal works, all are marked by the same peculiarities, everything is sacrificed to tone. In 1819 Louis Philippe decorated Granet, and afterwards named him Chevalier de l'Ordre St Michel, and Conservateur des tableaux de Versailles (1826). He became member of the institute in 1830; but in spite of these honours, and the ties which bound him to M. de Forbin, then director of the Louvre, Granet constantly returned to Rome. After 1848 he retired to Aix, immediately lost his wife, and died himself on the 21st of November 1849. He bequeathed to his native town the greater part of his fortune and all his collections, now exhibited in the Musée, together with a very fine portrait of the donor painted by Ingres in 1811.

GRANGE (through the A.-Fr. *grange*, from the Med. Lat. *grana*, a place for storing grain, *gronum*), properly a granary or barn. In the middle ages a "grange" was a detached portion of a manor with farm-houses and barns belonging to a lord or to a religious house; in it the crops could be conveniently stored for the purpose of collecting rent or tithe. Thus, such barns are often known as "tithes-barns." In many cases a chapel was included among the buildings or stood apart as a separate edifice. The word is still used as a name for a superior kind of farm-house, or for a country-house which has farm-buildings and agricultural land attached to it.

Architecturally considered, the "grange" was usually a long building with high wooden roof, sometimes divided by posts or columns into a sort of nave and aisles, and with walls strongly buttressed. Sometimes these granges were of very great extent, one at St Leonards, Hampshire, was originally 225 ft. long by 75 ft. wide, and a still larger one (303 ft. long) existed at Chertsey. Ancient granges, or tithes-barns, still exist at Glastonbury, Bradford-on-Avon, St Mary's Abbey, York, and at Corwold. A fine example at Peterborough was pulled down at the end of the 19th century. In France there are many examples in stone of the 12th, 13th and 14th centuries; some divided into a central and two side aisles by arcades in stone. Externally granges are noticeable on account of their great roofs and the slight elevation of the eaves, from 8 to 10 ft. only in height. In the 15th century they were sometimes protected by moats and towers. At Ardennes in Normandy, where the grange was 154 ft. long; Vauclerc near Laon, Picardy, 246 ft. long and in two storeys, at Perrières, St Vigor, near Bayeux, and Ouilly near Falaise, also in Normandy; and at St Martin-au-Bois (Oise) are a series of fine examples. Attached to the abbey of Longchamps, near Paris, is one of the best-preserved granges in France, with walls in stone and internally divided into three aisles in oak timber of extremely fine construction.

In the social economic movement in the United States of America, which began in 1867 and was known as the "Farmers' Movement," "grange" was adopted as the name for a local chapter of the Order of the Patrons of Husbandry, and the movement is thus often known as the "Grangers' Movement" (see *FARMERS' MOVEMENT*). There are a National Grange at Washington, supervising the local divisions, and state granges in most states.

GRANGEMOUTH, a police burgh and seaport of Stirlingshire, Scotland. Pop. (1901) 8386. It is situated on the south shore of the estuary of the Forth, at the mouth of the Carron and also of Grange Burn, a right-hand tributary of the Carron, 3 m. N.E. of Falkirk by the North British and Caledonian railways. It

is the terminus of the Forth and Clyde Canal, from the opening of which (1789) its history may be dated. The principal buildings are the town hall (in the Greek style), public hall, public institute and free library, and there is a public park presented by the marquess of Zetland. Since 1810, when it became a head port, it has gradually attained the position of the chief port of the Forth west of Leith. The first dock (opened in 1846), the second (1859) and the third (1882) cover an area of 28 acres, with timber ponds of 44 acres and a total quayside of 2500 yards. New docks, 93 acres in extent, with an entrance from the firth, were opened in 1905 at a cost of more than £1,000,000. The works rendered it necessary to divert the influx of the Grange from the Carron to the Forth. Timber, pig-iron and iron ore are the leading imports, and coal, produce and iron the chief exports. The industries include shipbuilding, rope and sail making and iron founding. There is regular steamer communication with London, Christiania, Hamburg, Rotterdam and Amsterdam. Experiments in steam navigation were carried out in 1802 with the "Charlotte Dundas" on the Forth and Clyde Canal at Grangemouth. Kerns House adjoining the town on the S.W. is a seat of the marquess of Zetland.

GRANGER, JAMES (1723-1776), English clergyman and print-collector, was born in Dorset in 1723. He went to Oxford, and then entered holy orders, becoming vicar of Shiplake; but apart from his hobby of portrait-collecting, which resulted in the principal work associated with his name, and the publication of some sermons, his life was uneventful. Yet a new word was added to the language—"to grangerize"—on account of him. In 1769 he published in two quarto volumes a *Biographical History of England* "consisting of characters dispersed in different classes, and adapted to a methodical catalogue of engraved British heads"; this was "intended as an essay towards reducing our biography to a system, and a help to the knowledge of portraits." The work was supplemented in later editions by Granger, and still further editions were brought out by the Rev. Mark Noble, with additions from Granger's materials. Blank leaves were left for the filling in of engraved portraits for extra illustration of the text, and it became a favourite pursuit to discover such illustrations and insert them in a *Granger*, so that "grangerizing" became a term for such an extra-illustration of any work, especially with cuts taken from other books. The immediate result of the appearance of Granger's own work was the rise in value of books containing portraits, which were cut out and inserted in collector's copies.

GRANITE (adapted from the Ital. *granito*, grained; Lat. *gratum*, grain), the group designation for a family of igneous rocks whose essential characteristics are that they are of acid composition (containing high percentages of silica), consist principally of quartz and feldspar, with some mica, hornblende or augite, and are of holocrystalline or "granitoid" structure. In popular usage the term is given to almost any crystalline rock which resembles granite in appearance or properties. Thus syenites, diorites, gabbros, diabases, porphyries, gneiss, and even limestones and dolomites, are bought and sold daily as "granites." True granites are common rocks, especially among the older strata of the earth's crust. They have great variety in colour and general appearance, some being white or grey, while others are pink, greenish or yellow: this depends mainly on the state of preservation of their feldspars, which are their most abundant minerals, and partly also on the relative proportion in which they contain biotite and other dark coloured silicates. Many granites have large rounded or angular crystals of feldspar (Sharp granite, many Cornish granites), well seen on polished faces. Others show an elementary foliation or banding (e.g. Aberdeen granite). Rounded or oval dark patches frequently appear in the granitic matrix of many Cornish rocks of this group.

In the field granite usually occurs in great masses, covering wide areas. These are generally elliptical or nearly circular and may be 20 m. in diameter or more. In the same district separate areas or "bosses" of granite may be found, all having much in common in their mineralogical and structural features, and such groups have probably all proceeded from the same

focus or deep-seated source. Towards their margins these granite outcrops often show modifications by which they pass into diorite or syenite, &c.; they may also be finer grained (like porphyries) or rich in tourmaline, or intersected by many veins of pegmatite. From the main granite dikes or veins often run out into the surrounding rocks, thus proving that the granite is intrusive and has forced its way upwards by splitting apart the strata among which it lies. Further evidence of this is afforded by the alteration which the granite has produced through a zone which varies from a few yards to a mile or more in breadth around it. In the vicinity of intrusive granites slates become converted into hornfels containing biotite, chialtolite or andalusite, sillimanite and a variety of other minerals; limestones recrystallize as marbles, and all rocks, according to their composition, are more or less profoundly modified in such a way as to prove that they have been raised to a high temperature by proximity to the molten intrusive mass. Where exposed in cliffs and other natural sections many granites have a rudely columnar appearance. Others weather into large cuboidal blocks which may produce structures resembling cyclopean masonry. The tors of the west of England are of this nature. These differences depend on the disposition of the joint cracks which traverse the rock and are opened up by the action of frost and weathering.

The majority of granites are so coarse in grain that their principal component minerals may be identified in the hand specimens by the unaided eye. The feldspar is pearly, white or pink, with smooth cleaved surfaces; the quartz is usually transparent, glassy with rough irregular fractures; the micas appear as shining black or white flakes. Very coarse granites are called pegmatite or giant granite, while very fine granites are known as microgranites (though the latter term has also been applied to certain porphyries). Many granites show pearly scales of white mica; others contain dark green or black hornblende in small prisms. Reddish grains of spene or of garnet are occasionally visible. In the tourmaline granites prisms of black schorl occur either singly or in stellate groups. The parallel banded structures of many granites, which may be original or due to crushing, connect these rocks with the granite gneisses or orthogneisses.

Under the microscope the feldspar is mainly orthoclase with perthite or microcline, while a small amount of plagioclase (ranging from oligoclase to albite) is practically never absent. These minerals are often clouded by a deposit of fine mica and kaolin, due to weathering. The quartz is transparent, irregular in form, destitute of cleavage, and is filled with very small cavities which contain a fluid, a mobile bubble and sometimes a minute crystal. The micas, brown and white, are often in parallel growth. The hornblende of granites is usually pale green in section, the augite and enstatite nearly colourless. Tourmaline may be brown, yellow or blue, and often the same crystal shows zones of different colours. Apatite, zircon and iron oxides, in small crystals, are always present. Among the less common accessories may be mentioned pinkish garnets; andalusite in small pleochroic crystals; colourless grains of topaz; six-sided compound crystals of cordierite, which weather to dark green pinite, blue-black hornblende (riebeckite), beryl, tinstone, orthite and pyrites.

The sequence of crystallization in the granites is of a normal type, and may be ascertained by observing the perfection with which the different minerals have crystallized and the order in which they enclose one another. Zircon, apatite and iron oxides are the first; their crystals are small, very perfect and nearly free from enclosures; they are followed by hornblende and biotite; if muscovite is present it succeeds the brown mica. Of the feldspars the plagioclase separates first and forms well-shaped crystals of which the central parts may be more basic than the outer zones. Last come orthoclase, quartz, microcline and micropegmatite, which fill up the irregular spaces left between the earlier minerals. Exceptions to this sequence are unusual, sometimes the first of the feldspars have preceded the hornblende or biotite which may envelop them in ophitic manner.

An earlier generation of feldspar, and occasionally also of quartz, may be represented by large and perfect crystals of these minerals giving the rock a porphyritic character.

Many granites have suffered modification by the action of vapours emitted during cooling. Hydrofluoric acid and boric emanations exert a profound influence on granitic rocks; their feldspar is resolved into aggregates of kaolin, muscovite and quartz; tourmaline appears, largely replacing the brown mica; topas also is not uncommon. In this way the rotten granite or china stone, used in pottery, originates; and over considerable areas kaolin replaces the feldspar and forms valuable sources of china clay. Veins of quartz, tourmaline and chlorite may traverse the granite, containing tinstone often in workable quantities. These veins are the principal sources of tin in Cornwall, but the same changes may appear in the body of the granite without being restricted to veins, and tinstone occurs also as an original constituent of some granite pegmatites.

Granites may also be modified by crushing. Their crystals tend to lose their original forms and to break into mosaics of interlocking grains. The latter structure is very well seen in the quartz, which is a brittle mineral under stress. White mica develops in the feldspars. The larger crystals are converted into lenticular or elliptical "augen," which may be shattered throughout or may have a peripheral seam of small detached granules surrounding a still undissolved core. Streaks of "granulitic" or pulverized material wind irregularly through the rock, giving it a roughly foliated character.

The interesting structural variation of granite in which there are spheroidal masses surrounded by a granitic matrix is known as "orbicular granite." The spheroids range from a fraction of an inch to a foot in diameter, and may have a feldspar crystal at the centre. Around this there may be several zones, alternately lighter and darker in colour, consisting of the essential minerals of the rock in different proportions. Radiate arrangement is sometimes visible in the crystals of the whole or part of the spheroid. Spheroidal granites of this sort are found in Sweden, Finland, Ireland, &c. In other cases the spheroids are simply dark rounded lumps of biotite, in fine scales. These are probably due to the adhesion of the biotite crystals to one another as they separated from the rock magma at an early stage in its crystallization. The Rapakivi granites of Finland have many round or ovoidal feldspar crystals scattered through a granitic matrix. These larger feldspars have no crystalline outlines and consist of orthoclase or microcline surrounded by borders of white oligoclase. Often they enclose dark crystals of biotite and hornblende, arranged zonally. Many of these granites contain tourmaline, fluorite and monazite. In most granite masses, especially near their contacts with the surrounding rocks, it is common to find enclosures of altered sedimentary or igneous materials which are more or less dissolved and permeated by the granitic magma.

The chemical composition of a few granites from different parts of the world is given below:—

	SiO ₂	Al ₂ O ₃	Fe ₂ O ₃	FeO	MgO	CaO	Na ₂ O	K ₂ O
I	74.69	16.21	..	1.16	0.48	0.28	1.18	3.64
II	71.33	11.18	3.96	1.45	0.88	2.10	3.51	3.49
III	72.93	13.87	1.94	0.79	0.51	0.74	3.68	3.74
IV	76.12	12.18	1.21	0.72	1.12	1.54	2.55	3.21
V	73.90	13.65	0.28	0.42	0.14	0.23	2.53	7.99
VI	68.87	16.62	0.43	2.72	1.60	0.71	1.80	6.48

I. Carn Brea, Cornwall (Phillips); II. Maszruni, Brit. Guiana (Harrison); III. Rödö, near Ålsö, Västernorrland, Sweden (Holmquist); IV. Abruzzo, a group of hills in the Riesengebirge (Michl); V. Pikea Peak, Colorado (Matthews); VI. Wilson's Creek, near Omeo, Victoria (Howitt).

Only the most important components are shown in the table, but all granites contain also small amounts of zirconia, titanium oxide, phosphoric acid, sulphur, oxides of barium, strontium, manganese and water. These are in all cases less than 1% and usually much less than this, except the water, which may be 2 or 3% in weathered rocks. From the chemical composition it may be computed that granites contain, on an average, 35 to 55% of quartz, 20 to 30% of orthoclase, 20 to 30% of plagioclase feldspar (including the albite of microperthite) and 5 to 10% of ferromagnesian

silicates and minor accessories such as apatite, zircon, sphene and iron oxides. The aplite, pegmatites, graphic granites and muscovite granites are usually richest in silica, while with increase of biotite and hornblende, augite and enstatite the analyses show the presence of more magnesia, iron and lime.

In the weathering of granite the quartz suffers little change; the felspar passes into dull cloudy, soft aggregates of kaolin, muscovite and secondary quartz, while chlorite, quartz and calcite replace the biotite, hornblende and augite. The rock often assumes a rusty brown colour from the liberation of the oxides of iron, and the decomposed mass is friable and can easily be dug with a spade; where the granite has been cut by joint planes not too close together weathering proceeds from their surfaces and large rounded blocks may be left embedded in rotted materials. The amount of water in the rock increases and part of the alkalis is carried away in solution; they form valuable sources of mineral food to plants. The chemical changes are shown by the following analyses:

	H ₂ O.	SiO ₂ .	TiO ₂ .	Al ₂ O ₃ .	FeO.	Fe ₂ O ₃ .	CaO.	MgO.	Na ₂ O.	K ₂ O.	P ₂ O ₅ .
I.	1.22	69.33	n.d.	14.33	3.60	..	3.21	2.44	2.70	2.67	0.10
II.	3.27	66.82	n.d.	15.52	1.69	1.88	3.13	2.76	2.58	2.44	n.d.
III.	4.70	65.69	0.31	15.23	..	4.39	2.63	2.64	2.12	2.00	0.06

Analyses of I, fresh grey granite; II, brown moderately firm granite; III, residual sand, produced by the weathering of the same mass (anal. G. P. Merrill).

The differences are surprisingly small and are principally an increase in the water and a diminution in the amount of alkalis and lime together with the oxidation of the ferrous oxide. (J. S. F.)

GRAN SASSO D'ITALIA ("Great Rock of Italy"), a mountain of the Abruzzi, Italy, the culminating point of the Apennines, 9560 ft. in height. In formation it resembles the limestone Alps of Tirol and there are on its elevated plateaus a number of *doline* or funnel-shaped depressions into which the melted snow and the rain sink. The summit is covered with snow for the greater part of the year. Seen from the Adriatic, Monte Corno, as it is sometimes called, from its resemblance to a horn, affords a magnificent spectacle; the Alpine region beneath its summit is still the home of the wild boar, and here and there are dense woods of beech and pine. The group has numerous other lofty peaks, of which the chief are the Pizzo d'Intermesole (8680 ft.), the Corno Piccolo (8650 ft.), the Pizzo Cefalone (8307 ft.) and the Monte della Portella (7835 ft.). The most convenient starting-point for the ascent is Assergi, 10 m. N.E. of Aquila, at the S. foot of the Gran Sasso. The Italian Alpine Club has erected a hut S.W. of the principal summit, and has published a special guidebook (E. Abbate, *Guida al Gran Sasso d'Italia*, Rome, 1888). The view from the summit extends to the Tyrrhenian Sea on the west and the mountains of Dalmatia on the east in clear weather. The ascent was first made in 1794 by Orazio Delico from the Teramo side. In Assergi is the interesting church of Sta. Maria Assunta, dating from 1150, with later alterations (see Gavini, in *L'Arte*, 1901, 316, 391).

GRANT, SIR ALEXANDER, 8th Bart. (1826-1884), British scholar and educationalist, was born in New York on the 13th of September 1826. After a childhood spent in the West Indies, he was educated at Harrow and Oxford. He entered Oxford as scholar of Balliol, and subsequently held a fellowship at Oriel from 1849 to 1860. He made a special study of the Aristotelian philosophy, and in 1857 published an edition of the *Ethics* (4th ed. 1885) which became a standard text-book at Oxford. In 1855 he was one of the examiners for the Indian Civil Service, and in 1856 a public examiner in classics at Oxford. In the latter year he succeeded to the baronetcy. In 1859 he went to Madras with Sir Charles Trevelyan, and was appointed inspector of schools; the next year he removed to Bombay, to fill the post of Professor of History and Political Economy in the Elphinstone College. Of this he became Principal in 1862; and, a year later, vice-chancellor of Bombay University, a post he held from 1863 to 1865 and again from 1865 to 1868. In 1865 he took upon himself also the duties of Director of Public Instruction for Bombay Presidency. In 1868 he was appointed a member of the Legislative Council. In the same year, upon the death of Sir David Brewster, he was appointed Principal of Edinburgh

University, which had conferred an honorary LL.D. degree upon him in 1865. From that time till his death (which occurred in Edinburgh on the 30th of November 1884) his energies were entirely devoted to the well-being of the University. The institution of the medical school in the University was almost solely due to his initiative; and the Tercentenary Festival, celebrated in 1884, was the result of his wisely directed enthusiasm. In that year he published *The Story of the University of Edinburgh during its First Three Hundred Years*. He was created Hon. D.C.L. of Oxford in 1880, and an honorary fellow of Oriel College in 1882.

GRANT, ANNE (1755-1838), Scottish writer, generally known as Mrs Grant of Laggan, was born in Glasgow, on the 21st of February 1755. Her childhood was spent in America, her father, Duncan MacVicar, being an army officer on service there. In 1768 the family returned to Scotland, and in 1779 Anne married James Grant, an army chaplain, who was also minister of the parish of Laggan, near Fort Augustus, Inverness, where her father

was barrack-master. On her husband's death in 1801 she was left with a large family and a small income. In 1802 she published by subscription a volume of *Original Poems, with some Translations from the Gaelic*, which was favourably received. In 1806 her *Letters from the Mountains*, with their spirited description of Highland scenery and legends, awakened much interest. Her other works are *Memoirs of an American Lady, with Sketches of Manners and Scenery in America as they existed previous to the Revolution* (1808), containing reminiscences of her childhood; *Essays on the Superstitions of the Highlanders of Scotland* (1811); and *Eighteen Hundred and Thirteen, a Poem* (1814). In 1810 she went to live in Edinburgh. For the last twelve years of her life she received a pension from government. She died on the 7th of November 1838.

See *Memoir and Correspondence of Mrs Grant of Laggan, edited by her son J. P. Grant* (3 vols., 1844).

GRANT, CHARLES (1746-1823), British politician, was born at Aldourie, Inverness-shire, on the 16th of April 1746, the day on which his father, Alexander Grant, was killed whilst fighting for the Jacobites at Culloden. When a young man Charles went to India, where he became secretary, and later a member of the board of trade. He returned to Scotland in 1790, and in 1802 was elected to parliament as member for the county of Inverness. In the House of Commons his chief interests were in Indian affairs, and he was especially vigorous in his hostility to the policy of the Marquess Wellesley. In 1805 he was chosen chairman of the directors of the East India Company and he retired from parliament in 1818. A friend of William Wilberforce, Grant was a prominent member of the evangelical party in the Church of England; he was a generous supporter of the church's missionary undertakings. He was largely responsible for the establishment of the East India college, which was afterwards erected at Haileybury. He died in London on the 31st of October 1823. His eldest son, Charles, was created a peer in 1835 as Baron Glenelg.

See Henry Morris, *Life of Charles Grant* (1904).

GRANT, SIR FRANCIS (1803-1878), English portrait-painter, fourth son of Francis Grant of Kilgraston, Perthshire, was born at Edinburgh in 1803. He was educated for the bar, but at the age of twenty-four he began at Edinburgh systematically to study the practice of art. On completing a course of instruction he removed to London, and as early as 1843 exhibited at the Royal Academy. At the beginning of his career he utilized his sporting experiences by painting groups of huntsmen, horses and hounds, such as the "Meet of H.M. Stag-hounds" and the "Melton Hunt"; but his position in society gradually made him a fashionable portrait-painter. In drapery he had the taste of a connoisseur, and rendered the minutest details of costume with felicitous accuracy. In female portraiture he achieved considerable success, although rather in depicting the high-born graces and external characteristics than the true personality. Among his portraits of this class may be mentioned Lady

Glenlyon, the marchioness of Waterford, Lady Rodney and Mrs Beauclerk. In his portraits of generals and sportsmen he proved himself more equal to his subjects than in those of statesmen and men of letters. He painted many of the principal celebrities of the time, including Scott, Macaulay, Lockhart, Disraeli, Hardinge, Gough, Derby, Palmerston and Russell, his brother Sir J. Hope Grant and his friend Sir Edwin Landseer. From the first his career was rapidly prosperous. In 1842 he was elected an associate of the Royal Academy, and in 1851 an Academician; and in 1866 he was chosen to succeed Sir C. Eastlake in the post of president, for which his chief recommendations were his social distinction, tact, urbanity and friendly and liberal consideration of his brother artists. Shortly after his election as president he was knighted, and in 1870 the degree of D.C.L. was conferred upon him by the university of Oxford. He died on the 5th of October 1878.

GRANT, GEORGE MONRO (1835-1902), principal of Queen's University, Kingston, Ontario, was born in Nova Scotia in 1835. He was educated at Glasgow university, where he had a brilliant academic career; and having entered the ministry of the Presbyterian Church, he returned to Canada and obtained a pastoral charge in Halifax, Nova Scotia, which he held from 1863 to 1877. He quickly gained a high reputation as a preacher and as an eloquent speaker on political subjects. When Canada was confederated in 1867 Nova Scotia was the province most strongly opposed to federal union. Grant threw the whole weight of his great influence in favour of confederation, and his oratory played an important part in securing the success of the movement. When the consolidation of the Dominion by means of railway construction was under discussion in 1872, Grant travelled from the Atlantic to the Pacific with the engineers who surveyed the route of the Canadian Pacific railway, and his book *Ocean to Ocean* (1873) was one of the first things that opened the eyes of Canadians to the value of the immense heritage they enjoyed. He never lost an opportunity, whether in the pulpit or on the platform, of pressing on his hearers that the greatest future for Canada lay in unity with the rest of the British Empire; and his broad statesman-like judgment made him an authority which politicians of all parties were glad to consult. In 1877 Grant was appointed principal of Queen's University, Kingston, Ontario, which through his exertions and influence expanded from a small denominational college into a large and influential educational centre; and he attracted to it an exceptionally able body of professors whose influence in speculation and research was widely felt during the quarter of a century that he remained at its head. In 1888 he visited Australia, New Zealand and South Africa, the effect of this experience being to strengthen still further the Imperialism which was the guiding principle of his political opinions. On the outbreak of the South African War in 1899 Grant was at first disposed to be hostile to the policy of Lord Salisbury and Mr Chamberlain; but his eyes were soon opened to the real nature of President Kruger's government, and he enthusiastically welcomed and supported the national feeling which sent men from the outlying portions of the Empire to assist in upholding British supremacy in South Africa. Grant did not live to see the conclusion of peace, his death occurring at Kingston on the 10th of May 1902. At the time of his death *The Times* observed that "It is acknowledged on all hands that in him the Dominion has lost one of the ablest men that it has yet produced." He was the author of a number of works, of which the most notable besides *Ocean to Ocean* are, *Advantages of Imperial Federation* (1889), *Our National Objects and Aims* (1890), *Religions of the World in Relation to Christianity* (1894) and volumes of sermons and lectures. Grant married in 1872 Jessie, daughter of William Lawson of Halifax.

GRANT, JAMES (1822-1887), British novelist, was born in Edinburgh on the 1st of August 1822. His father, John Grant, was a captain in the 92nd Gordon Highlanders and had served through the Peninsular War. For several years James Grant was in Newfoundland with his father, but in 1839 he returned to England, and entered the 62nd Foot as an ensign. In 1843 he resigned his commission and devoted himself to writing, first magazine

articles, but soon a profusion of novels, full of vivacity and incident, and dealing mainly with military scenes and characters. His best stories, perhaps, were *The Romance of War* (his first, 1845), *Bathwell* (1851), *Frank Hilton; or, The Queen's Own* (1855), *The Phantom Regiment* and *Harry Ogilvie* (1856), *Lucy Arden* (1858), *The White Cockade* (1867), *Only an Ensign* (1871), *Shall I Win Her?* (1874), *Playing with Fire* (1887). Grant also wrote *British Battles on Land and Sea* (1873-1875) and valuable books on Scottish history. Permanent value attaches to his great work, in three volumes, on *Old and New Edinburgh* (1880). He was the founder and energetic promoter of the National Association for the Vindication of Scottish Rights. In 1875 he became a Roman Catholic. He died on the 5th of May 1887.

GRANT, JAMES AUGUSTUS (1827-1892), Scottish explorer of eastern equatorial Africa, was born at Nairn, where his father was the parish minister, on the 11th of April 1827. He was educated at the grammar school and Marischal College, Aberdeen, and in 1846 joined the Indian army. He saw active service in the Sikh War (1848-49), served throughout the mutiny of 1857, and was wounded in the operations for the relief of Lucknow. He returned to England in 1858, and in 1860 joined J. H. Speke (*q.v.*) in the memorable expedition which solved the problem of the Nile sources. The expedition left Zanzibar in October 1860 and reached Gondokoro, where the travellers were again in touch with civilization, in February 1863. Speke was the leader, but Grant carried out several investigations independently and made valuable botanical collections. He acted throughout in absolute loyalty to his comrade. In 1864 he published, as supplementary to Speke's account of their journey, *A Walk across Africa*, in which he dealt particularly with "the ordinary life and pursuits, the habits and feelings of the natives" and the economic value of the countries traversed. In 1864 he was awarded the patron's medal of the Royal Geographical Society, and in 1866 given the Companionship of the Bath in recognition of his services in the expedition. He served in the intelligence department of the Abyssinian expedition of 1868; for this he was made C.S.I. and received the Abyssinian medal. At the close of the war he retired from the army with the rank of lieutenant-colonel. He had married in 1865, and he now settled down at Nairn, where he died on the 11th of February 1892. He made contributions to the journals of various learned societies, the most notable being the "Botany of the Speke and Grant Expedition" in vol. xxix. of the *Transactions of the Linnaean Society*.

GRANT, SIR JAMES HOPE (1808-1875), English general, fifth and youngest son of Francis Grant of Kilgraston, Perthshire, and brother of Sir Francis Grant, P.R.A., was born on the 22nd of July 1808. He entered the army in 1826 as cornet in the 9th Lancers, and became lieutenant in 1828 and captain in 1835. In 1842 he was brigade-major to Lord Saltoun in the Chinese War, and specially distinguished himself at the capture of Chin-Kiang, after which he received the rank of major and the C.B. In the first Sikh War of 1845-46 he took part in the battle of Sohraon; and in the Punjab campaign of 1848-49 he commanded the 9th Lancers, and won high reputation in the battles of Chillianwalla and Guzerat (Gujarat). He was promoted brevet lieutenant-colonel and shortly afterwards to the same substantive rank. In 1854 he became brevet-colonel, and in 1856 brigadier of cavalry. He took a leading part in the suppression of the Indian mutiny of 1857, holding for some time the command of the cavalry division, and afterwards of a movable column of horse and foot. After rendering valuable service in the operations before Delhi and in the final assault on the city, he directed the victorious march of the cavalry and horse artillery despatched in the direction of Cawnpore to open up communication with the commander-in-chief Sir Colin Campbell, whom he met near the Alambagh, and who raised him to the rank of brigadier-general, and placed the whole force under his command during what remained of the perilous march to Lucknow for the relief of the residency. After the retirement towards Cawnpore he greatly aided in effecting there the total rout of the rebel troops, by making a detour which threatened their rear; and following in pursuit with a flying column, he defeated them with the loss of

nearly all their guns at Serai Ghat. He also took part in the operations connected with the recapture of Lucknow, shortly after which he was promoted to the rank of major-general, and appointed to the command of the force employed for the final pacification of India, a position in which his unwearied energy, and his vigilance and caution united to high personal daring, rendered very valuable service. Before the work of pacification was quite completed he was created K.C.B. In 1859 he was appointed, with the local rank of lieutenant-general, to the command of the British land forces in the united French and British expedition against China. The object of the campaign was accomplished within three months of the landing of the forces at Pei-tang (1st of August 1860). The Taku Forts had been carried by assault, the Chinese defeated three times in the open and Peking occupied. For his conduct in this, which has been called the "most successful and the best carried out of England's little wars," he received the thanks of parliament and was gazetted G.C.B. In 1861 he was made lieutenant-general and appointed commander-in-chief of the army of Madras; on his return to England in 1865 he was made quartermaster-general at headquarters; and in 1870 he was transferred to the command of the camp at Aldershot, where he took a leading part in the reform of the educational and training systems of the forces, which followed the Franco-German War. The introduction of annual army manoeuvres was largely due to Sir Hope Grant. In 1872 he was gazetted general. He died in London on the 7th of March 1875.

Incidents in the Sepoy War of 1857-58, compiled from the Private Journal of General Sir Hope Grant, K.C.B., together with some explanatory chapters by Capt. H. Knollys, Royal Artillery, was published in 1873, and *Incidents in the China War of 1860* appeared posthumously under the same editorship in 1875.

GRANT, SIR PATRICK (1804-1895), British field marshal, was the second son of Major John Grant, 97th Foot, of Auchterblair, Inverness-shire, where he was born on the 11th of September 1804. He entered the Bengal native infantry as ensign in 1820, and became captain in 1832. He served in Oudh from 1834 to 1838, and raised the Haryana Light Infantry. Employed in the adjutant-general's department of the Bengal army from 1838 until 1854, he became adjutant-general in 1846. He served under Sir Hugh Gough at the battle of Maharajpur in 1843, winning a brevet-majority, was adjutant general of the army at the battles of Moodkee in 1845 (twice severely wounded), and of Ferozshah and Sobraon in 1846, receiving the C.B. and the brevet rank of lieutenant-colonel. He took part in the battles of Chillianwalla and Gujarat in 1849, gaining further promotion, and was appointed aide-de-camp to the queen. He served also in Kohat in 1851 under Sir Charles Napier. Promoted major-general in 1854, he was commander-in-chief of the Madras army from 1856 to 1861. He was made K.C.B. in 1857, and on General Anson's death was summoned to Calcutta to take supreme command of the army in India. From Calcutta he directed the operations against the mutineers, sending forces under Havelock and Outram for the relief of Cawnpore and Lucknow, until the arrival of Sir Colin Campbell from England as commander-in-chief, when he returned to Madras. On leaving India in 1861 he was decorated with the G.C.B. He was promoted lieutenant-general in 1862, was governor of Malta from 1867 to 1872, was made G.C.M.G. in 1868, promoted general in 1870, field marshal in 1883 and colonel of the Royal Horse Guards and gold-stick-in-waiting to the queen in 1885. He married as his second wife, in 1844, Frances Maria, daughter of Sir Hugh (afterwards Lord) Gough. He was governor of the Royal Hospital, Chelsea, from 1874 until his death there on the 28th of March 1895.

GRANT, ROBERT (1814-1892), British astronomer, was born at Grantown, Scotland, on the 17th of June 1814. At the age of thirteen the promise of a brilliant career was clouded by a prolonged illness of such a serious character as to incapacitate him from all school-work for six years. At twenty, however, his health greatly improved, and he set himself resolutely, without assistance, to repair his earlier disadvantages by the diligent study of Greek, Latin, Italian and mathematics. Astronomy

also occupied his attention, and it was stimulated by the return of Halley's comet in 1835, as well as by his success in observing the annular eclipse of the sun of the 15th of May 1836. After a short course at King's College, Aberdeen, he obtained in 1841 employment in his brother's counting-house in London. During this period the idea occurred to him of writing a history of physical astronomy. Before definitely beginning the work he had to search, amongst other records, those of the French Academy, and for that purpose took up his residence in Paris in 1845, supporting himself by giving lessons in English. He returned to London in 1847. *The History of Physical Astronomy from the Earliest Ages to the Middle of the Nineteenth Century* was first published in parts in *The Library of Useful Knowledge*, but after the issue of the ninth part this mode of publication was discontinued, and the work appeared as a whole in 1852. The main object of the work is, in the author's words, "to exhibit a view of the labours of successive inquirers in establishing a knowledge of the mechanical principles which regulate the movements of the celestial bodies, and in explaining the various phenomena relative to their physical constitution which observation with the telescope has disclosed." The lucidity and completeness with which a great variety of abstruse subjects were treated, the extent of research and the maturity of judgment it displayed, were the more remarkable, when it is remembered that this was the first published work of one who enjoyed no special opportunities, either for acquiring materials, or for discussing with others engaged in similar pursuits the subjects it treats of. The book at once took a leading place in astronomical literature, and earned for its author in 1856 the award of the Royal Astronomical Society's gold medal. In 1859 he succeeded John Pringle Nichol as professor of astronomy in the University of Glasgow. From time to time he contributed astronomical papers to the *Monthly Notices, Astronomische Nachrichten, Comptes rendus* and other scientific serials; but his principal work at Glasgow consisted in determining the places of a large number of stars with the Ertel transit-circle of the Observatory. The results of these labours, extending over twenty-one years, are contained in the *Glasgow Catalogue of 6415 Stars*, published in 1883. This was followed in 1892 by the *Second Glasgow Catalogue of 2156 Stars*, published a few weeks after his death, which took place on the 24th of October 1892.

See *Monthly Notices Roy. Astr. Society*, liii., 210 (E. Dunkin); *Nature*, Nov. 10, 1892; *The Times*, Nov. 2, 1892; *Roy. Society's Catalogue of Scient. Papers*.

GRANT, ULYSSES SIMPSON (1822-1885), American soldier, and eighteenth president of the United States, was born at Point Pleasant, Ohio, on the 27th of April 1822. He was a descendant of Matthew Grant, a Scotchman, who settled in Dorchester, Massachusetts, in 1630. His earlier years were spent in helping his father, Jesse R. Grant, upon his farm in Ohio. In 1839 he was appointed to a place in the military academy at West Point, and it was then that his name assumed the form by which it is generally known. He was christened Hiram, after an ancestor, with Ulysses for a middle name. As he was usually called by his middle name, the congressman who recommended him for West Point supposed it to be his first name, and added thereto the name of his mother's family, Simpson. Grant was the best horseman of his class, and took a respectable place in mathematics, but at his graduation in 1843 he only ranked twenty-first in a class of thirty-nine. In September 1845 he went with his regiment to join the forces of General Taylor in Mexico; there he took part in the battles of Palo Alto, Resaca de la Palma and Monterey, and, after his transfer to General Scott's army, which he joined in March 1847, served at Vera Cruz, Cerro Gordo, Churubusco, Molino del Rey and at the storming of Chapultepec. He was breveted first lieutenant for gallantry at Molino del Rey and captain for gallantry at Chapultepec. In August 1848, after the close of the war, he married Julia T. Dent (1826-1902), and was for a while stationed in California and Oregon, but in 1854 he resigned his commission. His reputation in the service had suffered from allegations of intemperate drinking, which, whether well founded or not,

certainly impaired his usefulness as a soldier. For the next six years he lived in St. Louis, Missouri, earning a scanty subsistence by farming and dealings in real estate. In 1860 he removed to Galena, Illinois, and became a clerk in a leather store kept by his father. At that time his earning capacity seems not to have exceeded \$800 a year, and he was regarded by his friends as a broken and disappointed man. He was living at Galena at the outbreak of hostilities between the North and South.

[For the history of the Civil War, and of Grant's battles and campaigns, the reader is referred to the article AMERICAN CIVIL WAR. To the "call to arms" of 1861 Grant promptly

*Grant's
Civil War
career.*

responded. After some delay he was commissioned colonel of the 21st Illinois regiment and soon afterwards brigadier-general. He was shortly assigned to a territorial command on the Mississippi, and first won distinction by his energy in seizing, on his own responsibility, the important point of Paducah, Kentucky, situated at the confluence of the two great waterways of the Tennessee and the Ohio (6th Sept. 1861). On the 7th of November he fought his first battle as a commander, that of Belmont (Missouri), which, if it failed to achieve any material result, certainly showed him to be a capable and skilful leader. Early in 1862 he was entrusted by General H. W. Halleck with the command of a large force to clear the lower reaches of the Cumberland and the Tennessee, and, whatever criticism may be passed on the general strategy of the campaign, Grant himself, by his able and energetic work, thoroughly deserved the credit of his brilliant success of Fort Donelson, where 15,000 Confederates were forced to capitulate. Grant and his division commanders were promoted to the rank of major-general U.S.V. soon afterwards, but Grant's own fortunes suffered a temporary eclipse owing to a disagreement with Halleck. When, after being virtually under arrest, he rejoined his army, it was concentrated about Savannah on the Tennessee, preparing for a campaign towards Corinth, Miss. On the 6th of April 1862 a furious assault on Grant's camps brought on the battle of Shiloh (*q.v.*). After two days' desperate fighting the Confederates withdrew before the combined attack of the Army of the Tennessee under Grant and the Army of the Ohio under Buell. But the Army of the Tennessee had been on the verge of annihilation on the evening of the first day, and Grant's leadership throughout was by no means equal to the emergency, though he displayed his usual personal bravery and resolution. In the grand advance of Halleck's armies which followed Shiloh, Grant was relieved of all important duties by his assignment as second in command of the whole force, and was thought by the army at large to be in disgrace. But Halleck soon went to Washington as general-in-chief, and Grant took command of his old army and of Rosecrans' Army of the Mississippi. Two victories (Iuka and Corinth) were won in the autumn of 1862, but the credit of both fell to Rosecrans, who commanded in the field, and the nadir of Grant's military fortunes was reached when the first advance on Vicksburg (*q.v.*), planned on an unsound basis, and complicated by a series of political intrigues (which had also caused the adoption of the original scheme), collapsed after the minor reverses of Holly Springs and Chickasaw Bayou (December 1862).

It is fair to assume that Grant would have followed other unsuccessful generals into retirement, had he not shown that, whatever his mistakes or failures, and whether he was or was not sober and temperate in his habits, he possessed the iron determination and energy which in the eyes of Lincoln and Stanton,¹ and of the whole Northern people, was the first requisite of their generals. He remained then with his army near Vicks-

burg, trying one plan after another without result, until at last after months of almost hopeless work his perseverance was crowned with success—a success directly consequent upon a strange and bizarre campaign of ten weeks, in which his daring and vigour were more conspicuous than ever before. On the 4th of July 1863 the great fortress surrendered with 29,491 men, this being one of the most important victories won by the Union arms in the whole war. Grant was at once made a major-general in the regular army. A few months later the great reverse of Chickamauga created an alarm in the North commensurate with the elation that had been felt at the double victory of Vicksburg and Gettysburg, and Grant was at once ordered to Chattanooga, to decide the fate of the Army of the Cumberland in a second battle. Four armies were placed under his command, and three of these concentrated at Chattanooga. On the 23rd of November 1863 a great three-days' battle ended with the crushing defeat of the Confederates, who from this day had no foothold in the centre and west.

After this, in preparation for a grand combined effort of all the Union forces, Grant was placed in supreme command, and the rank of lieutenant-general revived for him (March 1864). Grant's headquarters henceforth accompanied the Army of the Potomac, and the lieutenant-general directed the campaign in Virginia. This, with Grant's driving energy infused into the best army that the Union possessed, resolved itself into a series, almost uninterrupted, of terrible battles. Tactically the Confederates were almost always victorious, strategically, Grant, disposing of greatly superior forces, pressed back Lee and the Army of Northern Virginia to the lines of Richmond and Petersburg, while above all, in pursuance of his explicit policy of "attrition," the Federal leader used his men with a merciless energy that has few, if any, parallels in modern history. At Cold Harbor six thousand men fell in one useless assault lasting an hour, and after two months the Union armies lay before Richmond and Petersburg indeed, but had lost no fewer than 72,000 men. But Grant was unshaken in his determination. "I purpose to fight it out on this line, if it takes all summer," was his message from the battlefield of Spotsylvania to the chief of staff at Washington. Through many weary months he never relaxed his hold on Lee's army, and, in spite of repeated partial reverses, that would have been defeats for his predecessors, he gradually wore down his gallant adversary. The terrible cost of these operations did not check him: only on one occasion of grave peril were any troops sent from his lines to serve elsewhere, and he drew to himself the bulk of the men whom the Union government was recruiting by thousands for the final effort. Meanwhile all the other campaigns had been closely supervised by Grant, preoccupied though he was with the operations against his own adversary. At a critical moment he actually left the Virginian armies to their own commanders, and started to take personal command in a threatened quarter, and throughout he was in close touch with Sherman and Thomas, who conducted the campaigns on the south-east and the centre. That he succeeded in the efficient exercise of the chief command of armies of a total strength of over one million men, operating many thousands of miles apart from each other, while at the same time he watched and manoeuvred against a great captain and a veteran army in one field of the war, must be the greatest proof of Grant's powers as a general. In the end complete success rewarded the sacrifices and efforts of the Federals on every theatre of war; in Virginia, where Grant was in personal control, the merciless policy of attrition wore down Lee's army until a mere remnant was left for the final surrender.

¹ President Lincoln was Grant's most unwavering supporter. Many amusing stories are told of his replies to various deputations which waited upon him to ask for Grant's removal. On one occasion he asked the critics to ascertain the brand of whisky favoured by Grant, so that he could send kegs of it to the other generals. The question of Grant's abstemiousness was and is of little importance. The cause at stake over-rode every prejudice and the people of the United States, since the war, have been in general content to leave the question alone, as was evidenced by the outcry raised in 1908, when President Taft reopened it in a speech at Grant's tomb.

Grant had thus brought the great struggle to an end, and was universally regarded as the saviour of the Union. A careful study of the history of the war thoroughly bears out the popular view. There were soldiers more accomplished, as was McClellan, more brilliant, as was Rosecrans, and more exact, as was Buell, but it would be difficult to prove that these generals, or indeed any others in the service, could have accomplished the task which Grant brought to complete success. Nor must it be supposed that Grant learned little from three years' campaigning

in high command. There is less in common than is often supposed between the buoyant energy that led Grant to Shiloh and the grim plodding determination that led him to Vicksburg and to Appomattox. Shiloh revealed to Grant the intensity of the struggle, and after that battle, appreciating to the full the material and moral factors with which he had to deal, he gradually trained his military character on those lines which alone could conduce to ultimate success. Singleness of purpose, and relentless vigour in the execution of the purpose, were the qualities necessary to the conduct of the vast enterprise of subduing the Confederacy. Grant possessed or acquired both to such a degree that he proved fully equal to the emergency. If in technical finesse he was surpassed by many of his predecessors and his subordinates, he had the most important qualities of a great captain, courage that rose higher with each obstacle, and the clear judgment to distinguish the essential from the minor issues in war.—(C. F. A.)]

After the assassination of President Lincoln a disposition was shown by his successor, Andrew Johnson, to deal severely with the Confederate leaders, and it was understood that indictments for treason were to be brought against General Lee and others. Grant, however, insisted that the United States government was bound by the terms accorded to Lee and his army at Appomattox. He went so far as to threaten to resign his commission if the president disregarded his protest. This energetic action on Grant's part saved the United States from a foul stain upon its escutcheon. In July 1866 the grade of general was created, for the first time since the organization of the government, and Grant was promoted to that position. In the following year he became involved in the deadly quarrel between President Johnson and Congress. To tie the president's hands Congress had passed the Tenure of Office Act, forbidding the president to remove any cabinet officer without the consent of the Senate; but in August 1867 President Johnson suspended Secretary Stanton and appointed Grant secretary of war *ad interim* until the pleasure of the Senate should be ascertained. Grant accepted the appointment under protest, and held it until the following January, when the Senate refused to confirm the president's action, and Secretary Stanton resumed his office. President Johnson was much disgusted at the readiness with which Grant turned over the office to Stanton, and a bitter controversy ensued between Johnson and Grant. Hitherto Grant had taken little part in politics. The only vote which he had ever cast for a presidential candidate was in 1856 for James Buchanan; and leading Democrats, so late as the beginning of 1868, hoped to make him their candidate in the election of that year; but the effect of the controversy with President Johnson was to bring Grant forward as the candidate of the Republican party. At the convention in Chicago on the 20th of May 1868 he was unanimously nominated on the first ballot. The Democratic party nominated the one available Democrat who had the smallest chance of beating him—Horatio Seymour, lately governor of New York, an excellent statesman, but at that time hopeless as a candidate because of his attitude during the war. The result of the contest was at no time in doubt; Grant received 214 electoral votes and Seymour 80.

The most important domestic event of Grant's first term as president was the adoption of the fifteenth amendment to the Constitution on the 30th of March 1870, providing that suffrage throughout the United States should not be restricted on account of race, colour or previous condition of servitude. The most important event in foreign policy was the treaty with Great Britain of the 8th of May 1871, commonly known as the Treaty of Washington, whereby several controversies between the United States and Great Britain, including the bitter questions as to damage inflicted upon the United States by the "Alabama" and other Confederate cruisers built and equipped in England, were referred to arbitration. In 1869 the government of Santo Domingo (or the Dominican Republic) expressed a wish for annexation by the United States, and such a step was favoured

by Grant, but a treaty negotiated with this end in view failed to obtain the requisite two-thirds vote in the Senate. In May 1872 something was done towards alleviating the odious Reconstruction laws for dragooning the South, which had been passed by Congress in spite of the vetoes of President Johnson. The Amnesty Bill restored civil rights to all persons in the South, save from 300 to 500 who had held high positions under the Confederacy. As early as 1870 President Grant recommended measures of civil service reform, and succeeded in obtaining an act authorizing him to appoint a Civil Service commission. A commission was created, but owing to the hostility of the politicians in Congress it accomplished little. During the fifty years since Crawford's Tenure of Office Act was passed in 1820, the country had been growing more and more familiar with the spectacle of corruption in high places. The evil rose to alarming proportions during Grant's presidency, partly because of the immense extension of the civil service, partly because of the growing tendency to alliance between spoilsmen and the persons benefited by protective tariffs, and partly because the public attention was still so much absorbed in Southern affairs that little energy was left for curbing rascality in the North. The scandals, indeed, were rife in Washington, and affected persons in close relations with the president. Grant was ill-fitted for coping with the difficulties of such a situation. Along with high intellectual powers in certain directions, he had a simplicity of nature charming in itself, but often calculated to render him the easy prey of sharpers. He found it almost impossible to believe that anything could be wrong in persons to whom he had given his friendship, and on several occasions such friends proved themselves unworthy of him. The feeling was widely prevalent in the spring of 1872 that the interests of pure government in the United States demanded that President Grant should not be elected to a second term. This feeling led a number of high-minded gentlemen to form themselves into an organization under the name of Liberal Republicans. They held a convention at Cincinnati in May with the intention of nominating for the presidency Charles Francis Adams, who had ably represented the United States at the court of St James's during the Civil War. The convention, was, however, captured by politicians who converted the whole affair into a farce by nominating Horace Greeley, editor of the *New York Tribune*, who represented almost anything rather than the object for which the convention had been called together. The Democrats had despaired of electing a candidate of their own, and hoped to achieve success by adopting the Cincinnati nominee, should he prove to be an eligible person. The event showed that while their defeat in 1868 had taught them despondency, it had not taught them wisdom; it was still in their power to make a gallant fight by nominating a person for whom Republican reformers could vote. But with almost incredible fatuity, they adopted Greeley as their candidate. As a natural result Grant was re-elected by an overwhelming majority.

The most important event of his second term was his veto of the Inflation Bill in 1874 followed by the passage of the Resumption Act in the following year. The country was still labouring under the curse of an inconvertible paper currency originating with the Legal Tender Act of 1862. There was a considerable party in favour of debasing the currency indefinitely by inflation, and a bill with that object was passed by Congress in April 1874. It was promptly vetoed by President Grant, and two months later he wrote a very sensible letter to Senator J. P. Jones of Nevada advocating a speedy return to specie payments. The passage of the Resumption Act in January 1875 was largely due to his consistent advocacy, and for these measures he deserves as high credit as for his victories in the field. In spite of these great services, popular dissatisfaction with the Republican party rapidly increased during the years 1874-1876. The causes were twofold: firstly, there was great dissatisfaction with the troubles in the Southern states, owing to the harsh Reconstruction laws and the robberies committed by the carpet-bag governments which those laws kept in power; secondly, the scandals at

Pres-
dency,
1868.

Second
pres-
dency.

Washington, comprising wholesale frauds on the public revenue, awakened lively disgust. In some cases the culprits were so near to President Grant that many persons found it difficult to avoid the suspicion that he was himself implicated, and never perhaps was his hold upon popular favour so slight as in the summer and autumn of 1876.

After the close of his presidency in the spring of 1877 Grant started on a journey round the world, accompanied by his wife and one son. He was received with distinguished honours in England and on the continent of Europe, whence he made his way to India, China and Japan.

After his return to America in September 1880 he went back to his old home in Galena, Illinois. A faction among the managers of the Republican party attempted to secure his nomination for a third term as president, and in the convention at Chicago in June 1880 he received a vote exceeding 300 during 36 consecutive ballots. Nevertheless, his opponents made such effective use of the popular prejudice against third terms that the scheme was defeated, and Garfield was named in his stead. In August 1881 General Grant bought a house in the city of New York. His income was insufficient for the proper support of his family, and accordingly he had become partner in a banking house in which one of his sons was interested along with other persons. The name of the firm was Grant and Ward. The ex-president invested in it all his available property, but paid no attention to the management of the business. His facility in giving his confidence to unworthy people was now to be visited with dire calamity. In 1884 the firm became bankrupt, and it was discovered that two of the partners had been perpetrating systematic and gigantic frauds. This severe blow left General Grant penniless, just at the time when he was beginning to suffer acutely from the disease which finally caused his death. Down to this time he had never made any pretensions to literary skill or talent, but on being approached by the *Century Magazine* with a request for some articles he undertook the work in order to keep the wolf from the door. It proved a congenial task, and led to the writing of his *Personal Memoirs*, a frank, modest and charming book, which ranks among the best standard military biographies. The sales earned for the general and his family something like half a million dollars. The circumstances in which it was written made it an act of heroism comparable with any that Grant ever showed as a soldier. During most of the time he was suffering tortures from cancer in the throat, and it was only four days before his death that he finished the manuscript. In the spring of 1885 Congress passed a bill creating him a general on the retired list; and in the summer he was removed to a cottage at Mount M'Gregor, near Saratoga, where he passed the last five weeks of his life, and where he died on the 23rd of July 1885. His body was placed in a temporary tomb in Riverside Drive, in New York City, overlooking the Hudson river.¹

Grant showed many admirable and lovable traits. There was a charming side to his trustful simplicity, which was at times almost like that of a sailor set ashore. He abounded in kindness and generosity, and if there was anything especially difficult for him to endure, it was the sight of human suffering, as was shown on the night at Shiloh, where he lay out of doors in the icy rain rather than stay in a comfortable room where the surgeons were at work. His good sense was strong, as well as his sense of justice, and these qualities stood him in good service as president, especially in his triumphant fight against the greenback monster. Altogether, in spite of some shortcomings, Grant was a massive, noble and lovable personality, well fit to be remembered as one of the heroes of a great nation. (J. F.)

¹ The permanent tomb is of white granite and white marble and is 150 ft. high, with a circular cupola topping a square building 90 ft. on the side and 72 ft. high; the sarcophagus, in the centre of the building, is of red Wisconsin porphyry. The cornerstone was laid by President Harrison in 1892, and the tomb was dedicated on the 27th of April 1897 with a splendid parade and addresses by President McKinley and General Horace Porter, president of the Grant Monument Association, which from 90,000 contributions raised the funds for the tomb.

General Grant's son, FREDERICK DENT GRANT (b. 1850), graduated at the U.S. Military Academy in 1871, was aide-de-camp to General Philip Sheridan in 1873-1881, and resigned from the army in 1881, after having attained the rank of lieutenant-colonel. He was U.S. minister to Austria in 1889-1893, and police commissioner of New York city in 1894-1898. He served as a brigadier-general of volunteers in the Spanish-American War of 1898, and then in the Philippines, becoming brigadier-general in the regular army in February 1901 and major-general in February 1906.

BIBLIOGRAPHY.—Adam Badeau's *Military History of U. S. Grant* (3 vols., New York, 1867-1881), and *Grant in Peace* (Hartford, 1887), are appreciative but lacking in discrimination. William Conant Church's *Ulysses S. Grant and the Period of National Preservation and Reconstruction* (New York, 1897) is a good succinct account. Hamlin Garland's *Ulysses S. Grant, His Life and Character* (New York, 1898) gives especial attention to the personal traits of Grant and abounds in anecdote. See also Grant's *Personal Memoirs* (2 vols., New York, 1885-1886); J. G. Wilson's *Life and Public Services of U. S. Grant* (New York, 1886); J. R. Young's *Around the World with General Grant* (New York, 1880); Horace Porter's *Campaigning with Grant* (New York, 1897); James Ford Rhodes's *History of the United States* (vols. iii-vii, New York, 1895-1906); James K. Hosmer's *Appeal to Arms and Outcome of the Civil War* (New York, 1907); John Eaton's *Grant, Lincoln, and the Freedmen* (New York, 1907), and various works mentioned in the articles AMERICAN CIVIL WAR, WILDERNESS CAMPAIGN, &c.

GRANT (from A.-Fr. *grawnter*, O. Fr. *grawnter* for *creantur*, popular Lat. *creantare*, for *credentare*, to entrust, Lat. *credere*, to believe, trust), originally permission, acknowledgment, hence the gift of privileges, rights, &c., specifically in law, the transfer of property by an instrument in writing, termed a deed of grant. According to the old rule of common law, the immediate freehold in corporeal hereditaments lay in livery (see FROFFMENT), whereas incorporeal hereditaments, such as a reversion, remainder, advowson, &c., lay in grant, that is, passed by the delivery of the deed of conveyance or grant without further ceremony. The distinction between property lying in livery and in grant is now abolished, the Real Property Act 1845 providing that all corporeal tenements and hereditaments shall be transferable as well by grant as by livery (see CONVEYANCING). A grant of personal property is properly termed an assignment or bill of sale.

GRANTH, the holy scriptures of the Sikhs, containing the spiritual and moral teaching of Sikhism (q.v.). The book is called the *Adi Granth Sahib* by the Sikhs as a title of respect, because it is believed by them to be an embodiment of the gurus. The title is generally applied to the volume compiled by the fifth guru Arjan, which contains the compositions of Guru Nanak, the founder of the Sikh religion; of his successors, Guru Angad, Amar Das, Ram Das and Arjan; hymns of the Hindu bhagats or saints, Jaidev, Namev, Trilochan, Sain, Ramanand, Kabir, Rai Das, Pipa, Bhikhan, Beni, Parmannand Das, Sur Das, Sadhna and Dhanna Jat; verses of the Mahomedan saint called Farid; and panegyrics of the gurus by bards who either attended them or admired their characters. The compositions of the ninth guru, Teg Bahadur, were subsequently added to the *Adi Granth* by Guru Govind Singh. One recension of the sacred volume preserved at Mangat in the Gujrat district contains a hymn composed by Mira Bai, queen of Chitor. The *Adi Granth* contains passages of great picturesqueness and beauty. The original copy is said to be in Kartarpur in the Jullundur district, but the chief copy in use is now in the Har Mandar or Golden Temple at Amritsar, where it is daily read aloud by the attendant Granthis or scripture readers.

There is also a second *Granth* which was compiled by the Sikhs in 1734, and popularly known as the *Granth of the tenth Gurn*, but it has not the same authority as the *Adi Granth*. It contains Guru Govind Singh's *Japji*, the *Akal Ustii* or Praise of the Creator, thirty-three *sawais* (quatrains containing some of the main tenets of the guru and strong reprobation of idolatry and hypocrisy), and the *Vachitar Natak* or wonderful drama, in which the guru gives an account of his parentage, divine mission and the battles in which he was engaged. Then come three abridged translations by different hands of the *Devi Mahatmaya*.

an episode in the *Markandeya Puran*, in praise of Durga, the goddess of war. Then follow the *Gyan Parbodd* or awakening of knowledge, accounts of twenty-four incarnations of the deity, selected because of their warlike character; the *Hasave de Shabd*; the *Shastar Nam Mala*, which is a list of offensive and defensive weapons used in the guru's time, with special reference to the attributes of the Creator; the *Tria Charitar* or tales illustrating the qualities, but principally the deceit of women; the *Kabit*, compositions of a miscellaneous character; the *Zafarnama* containing the tenth guru's epistle to the emperor Aurangzeb, and several metrical tales in the Persian language. This *Granth* is only partially the composition of the tenth guru. The greater portion of it was written by bards in his employ.

The two volumes are written in several different languages and dialects. The *Adi Granth* is largely in old Punjabi and Hindi, but Prakrit, Persian, Mahratti and Gujrati are also represented. The *Granth of the Tenth Guru* is written in the old and very difficult Hindi affected by literary men in the Patna district in the 16th century. In neither of these sacred volumes is there any separation of words. As there is no separation of words in Sanskrit, the *gyanis* or interpreters of the guru's hymns prefer to follow the ancient practice of junction of words. This makes the reading of the Sikh scriptures very difficult, and is one of the causes of the decline of the Sikh religion.

The hymns in the *Adi Granth* are arranged not according to the gurus or bhagats who compose them, but according to *rags* or musical measures. There are thirty-one such measures in the *Adi Granth*, and the hymns are arranged according to the measures to which they are composed. The gurus who composed hymns, namely the first, second, third, fourth, fifth and ninth gurus, all used the name Nanak as their nom-de-plume. Their compositions are distinguished by mahallas or wards. Thus the compositions of Guru Nanak are styled mahalla one, the compositions of Guru Angad are styled mahalla two, and so on. After the hymns of the gurus are found the hymns of the bhagats under their several musical measures. The Sikhs generally dislike any arrangement of the *Adi Granth* by which the compositions of each guru or bhagat should be separately shown.

All the doctrines of the Sikhs are found set forth in the two *Granth*s and in compositions called *Rahit Namas* and *Tanakhwah Namas*, which are believed to have been the utterances of the tenth guru. The cardinal principle of the sacred books is the unity of God, and starting from this premiss the rejection of idolatry and superstition.

Thus Guru Govind Singh writes:

"Some worshipping stones, put them on their heads;
Some suspend lingams from their necks;
Some see the God in the South; some bow their heads to the West.
Some fools worship idols, others busy themselves with worshipping the dead.
The whole world entangled in false ceremonies hath not found God's secret."

Next to the unity of God comes the equality of all men in His sight, and so the abolition of caste distinctions. Guru Nanak says:

"Caste hath no power in the next world; there is a new order of beings,
Those whose accounts are honoured are the good."

The cremation of widows, though practised in later times by Hinduized Sikhs, is forbidden in the *Granth*. Guru Arjan writes:

"She who considereth her beloved as her God,
Is the blessed *sati* who shall be acceptable in God's Court."

It is a common belief that the Sikhs are allowed to drink wine and other intoxicants. This is not the case. Guru Nanak wrote:

"By drinking wine man committeth many sins."

Guru Arjan wrote:

"The fool who drinketh evil wine is involved in sin."

And in the *Rahit Nama* of Bhai Desa Singh there is the following:

"Let a Sikh take no intoxicant; it maketh the body lazy; it diverteth men from their temporal and spiritual duties, and inciteth them to evil deeds."

It is also generally believed that the Sikhs are bound to abstain from the flesh of kine. This, too, is a mistake, arising from the Sikh adoption of Hindu usages. The two *Granth*s of the Sikhs and all their canonical works are absolutely silent on the subject. The Sikhs are not bound to abstain from any flesh, except that which is obviously unfit for human food, or what is killed in the Mahomedan fashion by jugging an animal's throat with a knife. This flesh-eating practice is one of the main sources of their physical strength. Smoking is strictly prohibited by the Sikh religion. Guru Teg Bahadur preached to his host as follows:

"Save the people from the vile drug, and employ thyself in the service of Sikhs and holy men. When the people abandon the degrading smoke and cultivate their lands, their wealth and prosperity shall increase, and they shall want for nothing . . . but when they smoke the vile vegetable, they shall grow poor and lose their wealth."

Guru Govind Singh also said:

"Wine is bad, *bhang* destroyeth one generation, but tobacco destroyeth all generations."

In addition to these prohibitions Sikhism inculcates most of the positive virtues of Christianity, and specially loyalty to rulers, a quality which has made the Sikhs valuable servants of the British crown.

The *Granth* was translated by Dr Trumpp, a German missionary, on behalf of the Punjab government in 1877, but his rendering is in many respects incorrect, owing to insufficient knowledge of the Punjabi dialects. *The Sikh Religion*, &c., in 6 vols. (London, 1909) is an authoritative version prepared by M. Macauliffe, in concert with the modern leaders of the Sikh sect. (M. M.)

GRANTHAM, THOMAS ROBINSON, 1st Baron (c. 1695-1770), English diplomatist and politician, was a younger son of Sir William Robinson, Bart. (1655-1736) of Newby, Yorkshire, who was member of parliament for York from 1697 to 1722. Having been a scholar and minor fellow of Trinity College, Cambridge, Thomas Robinson gained his earliest diplomatic experience in Paris and then went to Vienna, where he was English ambassador from 1730 to 1748. During 1741 he sought to make peace between the empress Maria Theresa and Frederick the Great, but in vain, and in 1748 he represented his country at the congress of Aix-la-Chapelle. Returning to England he sat in parliament for Christchurch from 1749 to 1761. In 1754 Robinson was appointed a secretary of state and leader of the House of Commons by the prime minister, the duke of Newcastle, and it was on this occasion that Pitt made the famous remark to Fox, "the duke might as well have sent us his jackboot to lead us." In November 1755 he resigned, and in April 1761 he was created Baron Grantham. He was master of the wardrobe from 1749 to 1754 and again from 1755 to 1760, and was joint postmaster-general in 1765 and 1766. He died in London on the 30th of September 1770.

Grantham's elder son, **THOMAS ROBINSON** (1738-1786), who became the 2nd baron, was born at Vienna on the 30th of November 1738. Educated at Westminster School and at Christ's College, Cambridge, he entered parliament as member for Christchurch in 1761, and succeeded to the peerage in 1770. In 1771 he was sent as ambassador to Madrid and retained this post until war broke out between England and Spain in 1779. From 1780 to 1782 Grantham was first commissioner of the board of trade and foreign plantations, and from July 1782 to April 1783 secretary for the foreign department under Lord Shelburne. He died on the 20th of July 1786, leaving two sons, Thomas Philip, who became the 3rd baron, and Frederick John afterwards 1st earl of Ripon.

THOMAS PHILIP ROBINSON, 3rd Baron Grantham (1781-1859), in 1803 took the name of Weddell instead of that of Robinson. In May 1833 he became Earl de Grey of Wrest on the death of his maternal aunt, Amabell Hume-Campbell, Countess de Grey (1751-1833), and he now took the name of de Grey. He was first lord of the admiralty under Sir Robert Peel in 1834-1835.

and from 1841 to 1844 lord-lieutenant of Ireland. On his death without male issue his nephew, George Frederick Samuel Robinson, afterwards marquis of Ripon (q.v.), succeeded as Earl de Grey.

GRANTHAM, a municipal and parliamentary borough of Lincolnshire, England; situated in a pleasant undulating country on the river Witham. Pop. (1901) 17,593. It is an important junction of the Great Northern railway, 105 m. N. by W. from London, with branch lines to Nottingham, Lincoln and Boston; while there is communication with Nottingham and the Trent by the Grantham canal. The parish church of St Wulfram is a splendid building, exhibiting all the Gothic styles, but mainly Early English and Decorated. The massive and ornate western tower and spire, about 280 ft. in height, are of early Decorated workmanship. There is a double Decorated crypt beneath the lady chapel. The north and south porches are fine examples of a later period of the same style. The delicately carved font is noteworthy. Two libraries, respectively of the 16th and 17th centuries, are preserved in the church. At the King Edward VI. grammar school Sir Isaac Newton received part of his education. A bronze statue commemorates him. The late Perpendicular building is picturesque, and the school was greatly enlarged in 1904. The Angel Hotel is a hostelry of the 15th century, with a gateway of earlier date. A conduit dating from 1597 stands in the wide market-place. Modern public buildings are a gild hall, exchange hall, and several churches and chapels. The Queen Victoria Memorial home for nurses was erected in 1902-1903. The chief industries are malting and the manufacture of agricultural implements. Grantham returns one member to parliament. The borough falls within the S. Kesteven or Stamford division of the county. Grantham was created a suffragan bishopric in the diocese of Lincoln in 1905. The municipal borough is under a mayor, 4 aldermen and 12 councillors. Area, 1726 acres.

Although there is no authentic evidence of Roman occupation, Grantham (Graham, Granham in Domesday Book) from its situation on the Ermine Street, is supposed to have been a Roman station. It was possibly a borough in the Saxon period, and by the time of the Domesday Survey it was a royal borough with 111 burgesses. Charters of liberties existing now only in the confirmation charter of 1377 were granted by various kings. From the first the town was governed by a bailiff appointed by the lord of the manor, but by the end of the 14th century the office of alderman had come into existence. Finally government under a mayor and alderman was granted by Edward IV. in 1463, and Grantham became a corporate town. Among later charters, that of James II., given in 1685, changed the title to that of government by a mayor and 6 aldermen, but this was afterwards reversed and the old order resumed. Grantham was first represented in parliament in 1467, and returned two members; but by the Redistribution Act of 1885 the number was reduced to one. Richard III. in 1483 granted a Wednesday market and two fairs yearly, namely on the feast of St Nicholas the Bishop, and the two following days, and on Passion Sunday and the day following. At the present day the market is held on Saturday, and fairs are held on the Monday, Tuesday and Wednesday following the fifth Sunday in Lent; a cherry fair on the 11th of July and two stock fairs on the 26th of October and the 17th of December.

GRANTLEY, FLETCHER NORTON, 1ST BARON (1716-1789), English politician, was the eldest son of Thomas Norton of Grantley, Yorkshire, where he was born on the 23rd of June 1716. He became a barrister in 1739, and, after a period of inactivity, obtained a large and profitable practice, becoming a K.C. in 1754, and afterwards attorney-general for the county palatine of Lancaster. In 1756 he was elected member of parliament for Appleby; he represented Wigan from 1761 to 1768, and was appointed solicitor-general for England and knighted in 1762. He took part in the proceedings against John Wilkes, and, having become attorney-general in 1763, prosecuted the 5th Lord Byron for the murder of William Chaworth, losing his office when the marquis of Rockingham came into power in

July 1765. In 1769, being now member of parliament for Guildford, Norton became a privy councillor and chief justice in eyre of the forests south of the Trent, and in 1770 was chosen Speaker of the House of Commons. In 1777, when presenting the bill for the increase of the civil list to the king, he told George III. that parliament has "not only granted to your majesty a large present supply, but also a very great additional revenue; great beyond example; great beyond your majesty's highest expense." This speech aroused general attention and caused some irritation; but the Speaker was supported by Fox and by the city of London, and received the thanks of the House of Commons. George, however, did not forget these plain words, and after the general election of 1780, the prime minister, Lord North, and his followers declined to support the re-election of the retiring Speaker, alleging that his health was not equal to the duties of the office, and he was defeated when the voting took place. In 1782 he was made a peer as Baron Grantley of Markenfield. He died in London on the 1st of January 1789. He was succeeded as Baron Grantley by his eldest son William (1742-1822). Wraxall describes Norton as "a bold, able and eloquent, but not a popular pleader," and as Speaker he was aggressive and indiscreet. Derided by satirists as "Sir Bullface Doublefee," and described by Horace Walpole as one who "rose from obscure infamy to that infamous fame which will long stick to him," his character was also assailed by Junius, and the general impression is that he was a hot-tempered, avaricious and unprincipled man.

See H. Walpole, *Memoirs of the Reign of George III.*, edited by G. F. R. Barker (1894); Sir N. W. Wraxall, *Historical and Political Memoirs*, edited by H. B. Wheatley (1884); and J. A. Manning, *Lives of the Speakers* (1850).

GRANTOWN, the capital of Speyside, Elginshire, Scotland. Pop. (1901) 1568. It lies on the left bank of the Spey, 23½ m. S. of Forres by the Highland railway, with a station on the Great North of Scotland's Speyside line connecting Craigellachie with Boat of Garten. It was founded in 1776 by Sir James Grant of Grant, and became the chief seat of that ancient family, who had lived on their adjoining estate of Freuchie (Gaelic, *fraochach*, "heathery") since the beginning of the 15th century, and hence were usually described as the lairds of Freuchie. The public buildings include the town hall, court house and orphan hospital; and the industries are mainly connected with the cattle trade and the distilling of whisky. The town, built of grey granite, presents a handsome appearance, and being delightfully situated in the midst of the most beautiful pine and birch woods in Scotland, with pure air and a bracing climate, is an attractive resort. Castle Grant, immediately to the north, is the principal mansion of the earl of Seafield, the head of the Clan Grant. In a cave, still called "Lord Huntly's Cave," in a rocky glen in the vicinity, George, marquis of Huntly, lay hid during Montrose's campaign in 1644-45.

GRANULITE (Lat. *granulum*, a little grain), a name used by petrographers to designate two distinct classes of rocks. According to the terminology of the French school it signifies a granite in which both kinds of mica (muscovite and biotite) occur, and corresponds to the German *Granit*, or to the English "muscovite biotite granite." This application has not been accepted generally. To the German petrologists "granulite" means a more or less banded fine-grained metamorphic rock, consisting mainly of quartz and feldspar in very small irregular crystals, and containing usually also a fair number of minute rounded pale-red garnets. Among English and American geologists the term is generally employed in this sense. The granulites are very closely allied to the gneisses, as they consist of nearly the same minerals, but they are finer grained, have usually less perfect foliation, are more frequently garnetiferous, and have some special features of microscopic structure. In the rocks of this group the minerals, as seen in a microscopic slide, occur as small rounded grains forming a mosaic closely fitted together. The individual crystals have never perfect form, and indeed rarely any traces of it. In some granulites they interlock, with irregular borders; in others they have been drawn out and

flattened into tapering lenticles by crushing. In most cases they are somewhat rounded with smaller grains between the larger. This is especially true of the quartz and feldspar which are the predominant minerals; mica always appears as flat scales (irregular or rounded but not hexagonal). Both muscovite and biotite may be present and vary considerably in abundance; very commonly they have their flat sides parallel and give the rock a rudimentary schistosity, and they may be aggregated into bands—in which case the granulites are indistinguishable from certain varieties of gneiss. The garnets are very generally larger than the above-mentioned ingredients, and easily visible with the eye as pink spots on the broken surfaces of the rock. They usually are filled with enclosed grains of the other minerals.

The feldspar of the granulites is mostly orthoclase or cryptoperthite; microcline, oligoclase and albite are also common. Basic feldspars occur only rarely. Among accessory minerals, in addition to apatite, zircon, and iron oxides, the following may be mentioned: hornblende (not common), riebeckite (rare), epidote and zoisite, calcite, sphene, andalusite, sillimanite, kyanite, beryllite (a green spinel), rutile, orthite and tourmaline. Though occasionally we may find larger grains of feldspar, quartz or epidote, it is more characteristic of these rocks that all the minerals are in small, nearly uniform, imperfectly shaped individuals.

On account of the minuteness with which it has been described and the important controversies on points of theoretical geology which have arisen regarding it, the granulite district of Saxony (around Rosswein, Penig, &c.) may be considered the typical region for rocks of this group. It should be remembered that though granulites are probably the commonest rocks of this country, they are mingled with granites, gneisses, gabbros, amphibolites, mica schists and many other petrographical types. All of these rocks show more or less metamorphism either of a thermal character or due to pressure and crushing. The granites pass into gneiss and granulite; the gabbros into flaser gabbro and amphibolite; the slates often contain andalusite or chialotite, and show transitions to mica schists. At one time these rocks were regarded as Archean gneisses of a special type. Johannes Georg Lehmann propounded the hypothesis that their present state was due principally to crushing acting on them in a solid condition, grinding them down and breaking up their minerals, while the pressure to which they were subjected welded them together into coherent rock. It is now believed, however, that they are comparatively recent and include sedimentary rocks, partly of Palaeozoic age, and intrusive masses which may be nearly massive or may have gneissose, flaser or granulitic structures. These have been developed largely by the injection of semi-consolidated highly viscous intrusions, and the varieties of texture are original or were produced very shortly after the crystallisation of the rocks. Meanwhile, however, Lehmann's advocacy of post-consolidation crushing as a factor in the development of granulites has been so successful that the terms granulitization and granulitic structures are widely employed to indicate the results of dynamometamorphism acting on rocks at a period long after their solidification.

The Saxon granulites are apparently for the most part igneous and correspond in composition to granites and porphyries. There are, however, many granulites which undoubtedly were originally sediments (arkoses, grits and sandstones). A large part of the highlands of Scotland consists of paragneulites of this kind, which have received the group name of "Moine gneisses."

Along with the typical acid granulites above described, in Saxony, India, Scotland and other countries there occur dark-coloured basic granulites ("trap granulites"). These are fine-grained rocks, not usually banded, nearly black in colour with small red spots of garnet. Their essential minerals are pyroxene, plagioclase and garnet; chemically they resemble the gabbros. Green augite and hypersthene form a considerable part of these rocks, they may contain also biotite, hornblende and quartz. Around the garnets there is often a radial grouping of small grains of pyroxene and hornblende in a clear matrix of feldspar: these "centric" structures are frequent in granu-

lites. The rocks of this group accompany gabbro and serpentine, but the exact conditions under which they are formed and the significance of their structures is not very clearly understood. (J. S. F.)

GRANVELLA, ANTOINE PERRENOT, CARDINAL DE (1517-1586), one of the ablest and most influential of the princes of the church during the great political and ecclesiastical movements which immediately followed the appearance of Protestantism in Europe, was born on the 20th of August 1517 at Besançon, where his father, Nicolas Perrenot de Granvella (1484-1550), who afterwards became chancellor of the empire under Charles V., was practising as a lawyer. Later Nicolas held an influential position in the Netherlands, and from 1530 until his death he was one of the emperor's most trusted advisers in Germany. On the completion of his studies in law at Padua and in divinity at Louvain, Antoine held a canonry at Besançon, but he was promoted to the bishopric of Arras when barely twenty-three (1540). In his episcopal capacity he attended several diets of the empire, as well as the opening meetings of the council of Trent; and the influence of his father, now chancellor, led to his being entrusted with many difficult and delicate pieces of public business, in the execution of which he developed a rare talent for diplomacy, and at the same time acquired an intimate acquaintance with most of the currents of European politics. One of his specially noteworthy performances was the settlement of the terms of peace after the defeat of the league of Schmalkalden at Mühlberg in 1547, a settlement in which, to say the least, some particularly sharp practice was exhibited. In 1550 he succeeded his father in the office of secretary of state; in this capacity he attended Charles in the war with Maurice, elector of Saxony, accompanied him in the flight from Innsbruck, and afterwards drew up the treaty of Passau (August 1552). In the following year he conducted the negotiations for the marriage of Mary of England and Philip II. of Spain, to whom, in 1555, on the abdication of the emperor, he transferred his services, and by whom he was employed in the Netherlands. In April 1559 Granvella was one of the Spanish commissioners who arranged the peace of Cateau Cambresis, and on Philip's withdrawal from the Netherlands in August of the same year he was appointed prime minister to the regent, Margaret of Parma. The policy of repression which in this capacity he pursued during the next five years secured for him many tangible rewards, in 1560 he was elevated to the archiepiscopal see of Malines, and in 1561 he received the cardinal's hat; but the growing hostility of a people whose religious convictions he had set himself to trample under foot ultimately made it impossible for him to continue in the Low Countries; and by the advice of his royal master he, in March 1564, retired to Franche Comté. Nominally this withdrawal was only of a temporary character, but it proved to be final. The following six years were spent in comparative quiet, broken, however, by a visit to Rome in 1565; but in 1570 Granvella, at the call of Philip, resumed public life by accepting another mission to Rome. Here he helped to arrange the alliance between the Papacy, Venice and Spain against the Turks, an alliance which was responsible for the victory of Lepanto. In the same year he became viceroy of Naples, a post of some difficulty and danger, which for five years he occupied with ability and success. He was summoned to Madrid in 1575 by Philip II. to be president of the council for Italian affairs. Among the more delicate negotiations of his later years were those of 1580, which had for their object the ultimate union of the crowns of Spain and Portugal, and those of 1584, which resulted in a check to France by the marriage of the Spanish infanta Catherine to Charles Emmanuel, duke of Savoy. In the same year he was made archbishop of Besançon, but meanwhile he had been stricken with a lingering disease; he was never enthroned, but died at Madrid on the 21st of September 1586. His body was removed to Besançon, where his father had been buried. Granvella was a man of great learning, which was equalled by his industry, and these qualities made him almost indispensable both to Charles V. and to Philip II.

Numerous letters and memoirs of Granville are preserved in the archives of Besançon. These were to some extent made use of by Prosper Levéque in his *Mémoires pour servir* (1753), as well as by the Abbé Boissot in the *Traité de Granville*. A commission for publishing the whole of the letters and memoirs was appointed by Guizot in 1834, and the result has been the issue of nine volumes of the *Papiers d'Etat du cardinal de Granville*, edited by C. Weiss (Paris, 1841-1852). They form a part of the *Collection de documents inédits sur l'histoire de France*, and were supplemented by the *Correspondance du cardinal de Granville, 1565-1586*, edited by M. E. Pouillet and G. J. C. Piot (12 vols., Brussels, 1878-1896). See also the anonymous *Histoire du cardinal de Granville*, attributed to Courchetet D'Esanans (Paris, 1761); J. L. Motley, *Rise of the Dutch Republic*; M. Philippson, *Ein Ministerium unter Philipp II.* (Berlin, 1895); and the *Cambridge Modern History* (vol. iii. 1904).

GRANVILLE, GRANVILLE GEORGE LEVESON-GOWER, 2ND EARL (1815-1891), English statesman, eldest son of the 1st Earl Granville (1773-1846), by his marriage with Lady Harriet, daughter of the duke of Devonshire, was born in London on the 11th of May 1815. His father, Granville Leveson-Gower, was a younger son of Granville, 2nd Lord Gower and 1st marquess of Stafford (1720-1803), by his third wife; an elder son by the second wife (a daughter of the 1st duke of Bridgewater) became the 2nd marquess of Stafford, and his marriage with the daughter and heiress of the 17th earl of Sutherland (countess of Sutherland in her own right) led to the merging of the Gower and Stafford titles in that of the dukes of Sutherland (created 1833), who represent the elder branch of the family. As Lord Granville Leveson-Gower, the 1st Earl Granville (created viscount in 1815 and earl in 1833) entered the diplomatic service and was ambassador at St Petersburg (1804-1807) and at Paris (1824-1841). He was a Liberal in politics and an intimate friend of Canning. The title of Earl Granville had been previously held in the Carteret family.

After being at Eton and Christ Church, Oxford, young Lord Leveson went to Paris for a short time under his father, and in 1836 was returned to parliament in the Whig interest for Morpeth. For a short time he was under-secretary for foreign affairs in Lord Melbourne's ministry. In 1840 he married Lady Acton (Marie Louise Peline de Dalberg, widow of Sir Richard Acton; see ACTON and DALBERG). From 1841 till his father's death in 1846, when he succeeded to the title, he sat for Lichfield. In the House of Lords he signaled himself as a Free Trader, and Lord John Russell made him master of the buckhounds (1846). He proved a useful member of the party, and his influence and amiable character were valuable in all matters needing diplomacy and good breeding. He became vice-president of the Board of Trade in 1848, and took a prominent part in promoting the great exhibition of 1851. In the latter year, having already been admitted to the cabinet, he succeeded Palmerston at the foreign office until Lord John Russell's defeat in 1852; and when Lord Aberdeen formed his government at the end of the year, he became first president of the council, and then chancellor of the duchy of Lancaster (1854). Under Lord Palmerston (1855) he was president of the council. His interest in education (a subject associated with this office) led to his election (1856) as chancellor of the London University, a post he held for thirty-five years; and he was a prominent champion of the movement for the admission of women, and also of the teaching of modern languages. From 1855 Lord Granville led the Liberals in the Upper House, both in office, and, after Palmerston's resignation in 1858, in opposition. He went in 1856 as head of the British mission to the tsar's coronation in Moscow. In June 1859 the queen, embarrassed by the rival ambitions of Palmerston and Russell, sent for him to form a ministry, but he was unable to do so, and Palmerston again became prime minister, with Lord John as foreign secretary and Granville as president of the council. In 1860 his wife died, and to this heavy loss was shortly added that of his great friends Lord and Lady Canning and of his mother (1862); but he devoted himself to his political work, and retained his office when, on Palmerston's death in 1865, Lord Russell (now a peer) became prime minister and took over the leadership in the House of Lords. He was made Lord Warden of the Cinque

Ports, and in the same year married again, his second wife being Miss Castalia Campbell. From 1866 to 1868 he was in opposition, but in December 1868 he became colonial secretary in Gladstone's first ministry. His tact was invaluable to the government in carrying the Irish Church and Land Bills through the House of Lords. On the 27th of June 1870, on Lord Clarendon's death, he was transferred to the foreign office. Lord Granville's name is mainly associated with his career as foreign secretary (1870-1874 and 1880-1885); but the Liberal foreign policy of that period was not distinguished by enterprise or "backbone." Lord Granville personally was patient and polite, but his courteous and pacific methods were somewhat inadequate in dealing with the new situation then arising in Europe and outside it; and foreign governments had little scruple in creating embarrassments for Great Britain, and relying on the disinclination of the Liberal leaders to take strong measures. The Franco-German War of 1870 broke out within a few days of Lord Granville's quitting in the House of Lords (11th of July) the curiously unpropitious opinion of the permanent under-secretary (Mr Hammond) that "he had never known so great a lull in foreign affairs." Russia took advantage of the situation to denounce the Black Sea clauses of the treaty of Paris, and Lord Granville's protest was ineffectual. In 1871 an intermediate zone between Asiatic Russia and Afghanistan was agreed on between him and Shuvalov; but in 1873 Russia took possession of Khiva, within the neutral zone, and Lord Granville had to accept the aggression. When the Conservatives came into power in 1874, his part for the next six years was to criticize Disraeli's "spirited" foreign policy, and to defend his own more pliant methods. He returned to the foreign office in 1880, only to find an anti-British spirit developing in German policy which the temporizing methods of the Liberal leaders were generally powerless to deal with. Lord Granville failed to realize in time the importance of the Angra Pequena question in 1883-1884, and he was forced, somewhat ignominiously, to yield to Bismarck over it. Whether in Egypt, Afghanistan or equatorial and south-west Africa, British foreign policy was dominated by suavity rather than by the strength which commands respect. Finally, when Gladstone took up Home Rule for Ireland, Lord Granville, whose mind was similarly receptive to new ideas, adhered to his chief (1886), and gracefully gave way to Lord Rosebery when the latter was preferred to the foreign office; the Liberals had now realized that they had lost ground in the country by Lord Granville's occupancy of the post. He went to the Colonial Office for six months, and in July 1886 retired from public life. He died in London on the 31st of March 1891, being succeeded in the title by his son, born in 1872. Lord Granville was a man of much charm and many friendships, and an admirable after-dinner speaker. He spoke French like a Parisian, and was essentially a diplomatist; but he has no place in history as a constructive statesman.

The life of Lord Granville (1905), by Lord Fitzmaurice, is full of interesting material for the history of the period, but being written by a Liberal, himself an under-secretary for foreign affairs, it explains rather than criticizes Lord Granville's work in that department. (H. CH.)

GRANVILLE, JOHN CARTERET, EARL (1690-1763), English statesman, commonly known by his earlier title as Lord Carteret, born on the 22nd of April 1690, was the son of George, 1st Lord Carteret, by his marriage with Grace Granville, daughter of Sir John Granville, 1st earl of Bath, and great grandson of the Elizabethan admiral, Sir Richard Grenville, famous for his death in the "Revenge." The family of Carteret was settled in the Channel Islands, and was of Norman descent. John Carteret was educated at Westminster, and at Christ Church, Oxford. Swift says that "with a singularity scarce to be justified he carried away more Greek, Latin and philosophy than properly became a person of his rank." Throughout life Carteret not only showed a keen love of the classics, but a taste for, and a knowledge of, modern languages and literatures. He was almost the only Englishman of his time who knew German. Harte, the author of the *Life of Gustavus Adolphus*, acknowledged the aid which Carteret had given him. On the

17th of October 1710 he married at Longleat Lady Frances Worsley, grand-daughter of the first Viscount Weymouth. He took his seat in the Lords on the 25th of May 1711. Though his family, on both sides, had been devoted to the house of Stuart, Carteret was a steady adherent of the Hanoverian dynasty. He was a friend of the Whig leaders Stanhope and Sunderland, took a share in defeating the Jacobite conspiracy of Bolingbroke on the death of Queen Anne, and supported the passing of the Septennial Act. Carteret's interests were however in foreign, and not in domestic policy. His serious work in public life began with his appointment, early in 1719, as ambassador to Sweden. During this and the following year he was employed in saving Sweden from the attacks of Peter the Great, and in arranging the pacification of the north. His efforts were finally successful. During this period of diplomatic work he acquired an exceptional knowledge of the affairs of Europe, and in particular of Germany, and displayed great tact and temper in dealing with the Swedish senate, with Queen Ulrica, with the king of Denmark and Frederick William I. of Prussia. But he was not qualified to hold his own in the intrigues of court and parliament in London. Named secretary of state for the southern department on his return home, he soon became helplessly in conflict with the intrigues of Townshend and Sir Robert Walpole. To Walpole, who looked upon every able colleague, or subordinate, as an enemy to be removed, Carteret was exceptionally odious. His capacity to speak German with the king would alone have made Sir Robert detest him. When, therefore, the violent agitation in Ireland against Wood's halfpence (see SWIFT, JONATHAN) made it necessary to replace the duke of Grafton as lord lieutenant, Carteret was sent to Dublin. He landed in Dublin on the 23rd of October 1724, and remained there till 1730. In the first months of his tenure of office he had to deal with the furious opposition to Wood's halfpence, and to counteract the effect of Swift's *Draper's Letters*. The lord lieutenant had a strong personal liking for Swift, who was also a friend of Lady Carteret's family. It is highly doubtful whether Carteret could have reconciled his duty to the crown with his private friendships, if government had persisted in endeavouring to force the detested coinage on the Irish people. Wood's patent was however withdrawn, and Ireland settled down. Carteret was a profuse and popular lord lieutenant who pleased both the "English interest" and the native Irish. He was at all times addicted to lavish hospitality, and according to the testimony of contemporaries was too fond of burgundy. When he returned to London in 1730, Walpole was firmly established as master of the House of Commons, and as the trusted minister of King George II. He had the full confidence of Queen Caroline, whom he prejudiced against Carteret. Till the fall of Walpole in 1742, Carteret could take no share in public affairs except as a leader of opposition of the Lords. His brilliant parts were somewhat obscured by his rather erratic conduct, and a certain contempt, partly aristocratic and partly intellectual, for commonplace men and ways. He endeavoured to please Queen Caroline, who loved literature, and he has the credit, on good grounds, of having paid the expenses of the first handsome edition of *Don Quixote* to please her. But he reluctantly, and most unwisely, allowed himself to be entangled in the scandalous family quarrel between Frederick, prince of Wales, and his parents. Queen Caroline was provoked into classing him and Bolingbroke, as "the two most worthless men of parts in the country." Carteret took the popular side in the outcry against Walpole for not making war on Spain. When the War of the Austrian Succession approached, his sympathies were entirely with Maria Theresa—mainly on the ground that the fall of the house of Austria would dangerously increase the power of France, even if she gained no accession of territory. These views made him welcome to George II., who gladly accepted him as secretary of state in 1742. In 1743 he accompanied the king of Germany, and was present at the battle of Dettingen on the 27th of June. He held the secretaryship till November 1744. He succeeded in promoting an agreement between Maria Theresa and Frederick. He under-

stood the relations of the European states, and the interests of Great Britain among them. But the defects which had rendered him unable to baffle the intrigues of Walpole made him equally unable to contend with the Pelhams. His support of the king's policy was denounced as subservience to Hanover. Pitt called him "an execrable, a sole minister who had renounced the British nation." A few years later Pitt adopted an identical policy, and professed that whatever he knew he had learnt from Carteret. On the 18th of October 1744 Carteret became Earl Granville on the death of his mother. His first wife died in June 1743 at Aschaffenburg, and in April 1744 he married Lady Sophia Fermor, daughter of Lord Pomfret—a fashionable beauty and "reigning toast" of London society, who was younger than his daughters. "The nuptials of our great Quixote and the fair Sophia," and Granville's ostentatious performance of the part of lover, were ridiculed by Horace Walpole. The countess Granville died on the 7th of October 1745, leaving one daughter Sophia, who married Lord Shelburne, 1st marquis of Lansdowne. This marriage may have done something to increase Granville's reputation for eccentricity. In February 1746 he allowed himself to be entrapped by the intrigues of the Pelhams into accepting the secretaryship, but resigned in forty-eight hours. In June 1751 he became president of the council, and was still liked and trusted by the king, but his share in government did not go beyond giving advice, and endeavouring to forward ministerial arrangements. In 1756 he was asked by Newcastle to become prime minister as the alternative to Pitt, but Granville, who perfectly understood why the offer was made, declined and supported Pitt. When in October 1761 Pitt, who had information of the signing of the "Family Compact" wished to declare war on Spain, and declared his intention to resign unless his advice was accepted, Granville replied that "the opinion of the majority (of the Cabinet) must decide." He spoke in complimentary terms of Pitt, but resisted his claim to be considered as a "sole minister" or, in the modern phrase, "a prime minister." Whether he used the words attributed to him in the Annual Register for 1761 is more than doubtful, but the minutes of council show that they express his meaning. Granville remained in office as president till his death. His last act was to listen while on his death-bed to the reading of the preliminaries of the treaty of Paris. He was so weak that the under-secretary, Robert Wood, author of an essay on *The Original Genius of Homer*, would have postponed the business, but Granville said that it "could not prolong his life to neglect his duty," and quoted the speech of Sarpedon from *Iliad* xii. 322-328, repeating the last word (*τοῦτο*) "with a calm and determined resignation." He died in his house in Arlington Street, London, on the 22nd of January 1763. The title of Granville descended to his son Robert, who died without issue in 1776, when the earldom of this creation became extinct.

A somewhat partisan life of Granville was published in 1887, by Archibald Ballantyne, under the title of *Lord Carteret, a Political Biography*.

GRANVILLE, a town of Cumberland county, New South Wales, 13 m. by rail W. of Sydney. Pop. (1901) 5094. It is an important railway junction and manufacturing town, producing agricultural implements, tweed, pipes, tiles and bricks; there are also tanneries, flour-mills, and kerosene and meat export works. It became a municipality in 1885.

GRANVILLE, a fortified sea-port and bathing-resort of north-western France, in the department of Manche, at the mouth of the Bosq, 85 m. S. by W. of Cherbourg by rail. Pop. (1906) 10,530. Granville consists of two quarters, the upper town built on a promontory jutting into the sea and surrounded by ramparts, and the lower town and harbour lying below it. The barracks and the church of Notre-Dame, a low building of granite, partly Romanesque, partly late Gothic in style, are in the upper town. The port consists of a tidal harbour, two floating basins and a dry dock. Its fleets take an active part in deep sea fishing, including the cod-fishing off Newfoundland, and oyster-fishing is carried on. It has regular communication

with Guernsey and Jersey, and with the islands of St Pierre and Miquelon. The principal exports are eggs, vegetables and fish; coal, timber and chemical manures are imported. The industries include ship-building, fish-salting, the manufacture of cod-liver oil, the preserving of vegetables, dyeing, metal-founding, rope-making and the manufacture of chemical manures. Among the public institutions are a tribunal and a chamber of commerce. In the commune are included the Iles Chausey about $7\frac{1}{2}$ m. N.W. of Granville (see CHANNEL ISLANDS). Granville, before an insignificant village, was fortified by the English in 1437, taken by the French in 1441, bombarded and burned by the English in 1695, and unsuccessfully besieged by the Venetian troops in 1793. It was again bombarded by the English in 1803.

GRANVILLE, a village in Licking county, Ohio, U.S.A., in the township of Granville, about 6 m. W. of Newark and 27 m. E. by N. of Columbus. Pop. of the village (1910) 1304; of the township (1910) 2442. Granville is served by the Toledo & Ohio Central and the Ohio Electric railways, the latter reaching Newark (where it connects with the Pittsburg, Cincinnati, Chicago & St. Louis and the Baltimore & Ohio railways), Columbus, Dayton, Zanesville and Springfield. Granville is the seat of Denison University, founded in 1831 by the Ohio Baptist Education Society and opened as a manual labour school, called the Granville Literary and Theological Institution. It was renamed Granville College in 1845, and took its present name in 1854 in honour of William S. Denison of Adamsville, Ohio, who had given \$10,000 to the college. The university comprised in 1907-1908 five departments: Granville College (220 students), the collegiate department for men; Shepardson College (246 students, including 82 in the preparatory department), the collegiate department for women, founded as the Young Ladies' Institute of Granville in 1859, given to the Baptist denomination in 1887 by Dr Daniel Shepardson, its principal and owner, and closely affiliated for scholastic purposes, since 1900, with the university, though legally it is still a distinct institution; Doane Academy (137 students), the preparatory department for boys, established in 1831, named Granville Academy in 1887, and renamed in 1895 in honour of William H. Doane of Cincinnati, who gave to it its building; a conservatory of music (137 students); and a school of art (38 students).

In 1805 the Licking Land Company, organized in the preceding year in Granville, Massachusetts, bought 29,040 acres of land in Ohio, including the site of Granville; the town was laid out, and in the last months of that year settlers from Granville, Mass., began to arrive. By January 1806 the colony numbered 234 persons; the township was incorporated in 1806 and the village was incorporated in 1831. There are several remarkable Indian mounds near Granville, notably one shaped like an alligator.

See Henry Bushnell, *History of Granville, Ohio* (Columbus, O., 1889).

GRAPE, the fruit of the vine (*q.v.*). The word is adopted from the O. Fr. *grape*, mod. *grappe*, bunch or cluster of flowers or fruit, *grappes de raisin*, bunch of grapes. The French word meant properly a hook: cf. M.H.G. *krapsfe*, Eng. "grapnel," and "cramp." The development of meaning seems to be vine-hook, cluster of grapes cut with a hook, and thence in English a single grape of a cluster. The projectile called "grape" or "grape-shot," formerly used with smooth-bore ordnance, took its name from its general resemblance to a bunch of grapes. It consisted of a number of spherical bullets (heavier than those of the contemporary musket) arranged in layers separated by thin iron plates, a bolt passing through the centre of the plates binding the whole together. On being discharged the projectile delivered the bullets in a shower somewhat after the fashion of case-shot.

GRAPHICAL METHODS, devices for representing by geometrical figures the numerical data which result from the quantitative investigation of phenomena. The simplest application is met with in the representation of tabular data such as occur in statistics. Such tables are usually of single entry, *i.e.* to a certain value of one variable there corresponds one, and only one, value of the other variable. To construct the graph, as it is called, of such a table, Cartesian co-ordinates are usually employed.

Two lines or axes at right angles to each other are chosen, intersecting at a point called the origin; the horizontal axis is the axis of abscissae, the vertical one the axis of ordinates. Along one, say the axis of abscissae, distances are taken from the origin corresponding to the values of one of the variables; at these points perpendiculars are erected, and along these ordinates distances are taken corresponding to the related values of the other variable. The curve drawn through these points is the graph. A general inspection of the graph shows in bold relief the essential characters of the table. For example, if the world's production of corn over a number of years be plotted, a poor yield is represented by a depression, a rich one by a peak, a uniform one over several years by a horizontal line and so on. Moreover, such graphs permit a convenient comparison of two or more different phenomena, and the curves render apparent at first sight similarities or differences which can be made out from the tables only after close examination. In making graphs for comparison, the scales chosen must give a similar range of variation, otherwise the correspondence may not be discerned. For example, the scales adopted for the average consumption of tea and sugar must be ounces for the former and pounds for the latter. Cartesian graphs are almost always yielded by automatic recording instruments, such as the barograph, meteorograph, seismometer, &c. The method of polar co-ordinates is more rarely used, being only specially applicable when one of the variables is a direction or recorded as an angle. A simple case is the representation of photometric data, *i.e.* the value of the intensity of the light emitted in different directions from a luminous source (see LIGHTING).

The geometrical solution of arithmetical and algebraical problems is usually termed graphical analysis; the application to problems in mechanics is treated in MECHANICS, § 5, *Graphic Statics*, and DIAGRAM. A special phase is presented in VECTOR ANALYSIS.

GRAPHITE, a mineral species consisting of the element carbon crystallized in the rhombohedral system. Chemically, it is thus identical with the cubic mineral diamond, but between the two there are very wide differences in physical characters. Graphite is black and opaque, whilst diamond is colourless and transparent; it is one of the softest ($H=1$) of minerals, and diamond the hardest of all; it is a good conductor of electricity, whilst diamond is a bad conductor. The specific gravity is 2.2, that of diamond is 3.5. Further, unlike diamond, it never occurs as distinctly developed crystals, but only as imperfect six-sided plates and scales. There is a perfect cleavage parallel to the surface of the scales, and the cleavage flakes are flexible but not elastic. The material is greasy to the touch, and soils everything with which it comes into contact. The lustre is bright and metallic. In its external characters graphite is thus strikingly similar to molybdenite (*q.v.*).

The name graphite, given by A. G. Werner in 1789, is from the Greek *γράφω*, "to write," because the mineral is used for making pencils. Earlier names, still in common use, are plumbago and black-lead, but since the mineral contains no lead these names are singularly inappropriate. Plumbago (Lat. *plumbum*, lead) was originally used for an artificial product obtained from lead ore, and afterwards for the ore (galena) itself; it was confused both with graphite and with molybdenite. The true chemical nature of graphite was determined by K. W. Scheele in 1779.

Graphite occurs mainly in the older crystalline rocks—gneiss, granulate, schist and crystalline limestone—and also sometimes in granite: it is found as isolated scales embedded in these rocks, or as large irregular masses or filling veins. It has also been observed as a product of contact-metamorphism in carbonaceous clay-slates near their contact with granite, and where igneous rocks have been intruded into beds of coal; in these cases the mineral has clearly been derived from organic matter. The graphite found in granite and in veins in gneiss, as well as that contained in meteoric irons, cannot have had such an origin. As an artificial product, graphite is well known as dark lustrous scales in grey pig-iron, and in the "kish" of iron furnaces: it is also produced artificially on a large scale, together with

carborundum, in the electric furnace (see below). The graphite veins in the older crystalline rocks are probably akin to metalliferous veins and the material derived from deep-seated sources; the decomposition of metallic carbides by water and the reduction of hydrocarbon vapours have been suggested as possible modes of origin. Such veins often attain a thickness of several feet, and sometimes possess a columnar structure perpendicular to the enclosing walls; they are met with in the crystalline limestones and other Laurentian rocks of New York and Canada, in the gneisses of the Austrian Alps and the granulites of Ceylon. Other localities which have yielded the mineral in large amount are the Alibert mine in Irkutsk, Siberia and the Borzovale mine in Cumberland. The Santa Maria mines of Sonora, Mexico, probably the richest deposits in the world, supply the American lead pencil manufacturers. The graphite of New York, Pennsylvania and Alabama is "flake" and unsuitable for this purpose.

Graphite is used for the manufacture of pencils, dry lubricants, grate polish, paints, crucibles and for foundry facings. The material as mined usually does not contain more than 20 to 50% of graphite: the ore has therefore to be crushed and the graphite floated off in water from the heavier impurities. Even the purest forms contain a small percentage of volatile matter and ash. The Cumberland graphite, which is especially suitable for pencils, contains about 12% of impurities. (L. J. S.)

Artificial Manufacture.—The alteration of carbon at high temperatures into a material resembling graphite has long been known. In 1803 Girard and Street patented a furnace and a process by which this transformation could be effected. Carbon powder compressed into a rod was slowly passed through a tube in which it was subjected to the action of one or more electric arcs. E. G. Acheson, in 1856, patented an application of his carborundum process to graphite manufacture, and in 1899 the International Acheson Graphite Co. was formed, employing electric current from the Niagara Falls. Two procedures are adopted: (1) graphitization of moulded carbons; (2) graphitization of anthracite *en masse*. The former includes electrodes, lamp carbons, &c. Coke, or some other form of amorphous carbon, is mixed with a little tar, and the required article moulded in a press or by a die. The articles are stacked transversely in a furnace, each being packed in granular coke and covered with carborundum. At first the current is 3000 amperes at 220 volts, increasing to 9000 amperes at 20 volts after 20 hours. In graphitizing *en masse* large lumps of anthracite are treated in the electric furnace. A soft, unctuous form results on treating carbon with ash or silica in special furnaces, and this gives the so-called "deflocculated" variety when treated with gallo-tannic acid. These two modifications are valuable lubricants. The massive graphite is very easily machined and is widely used for electrodes, dynamo brushes, lead pencils and the like.

See "Graphite and its Uses," *Bull. Imperial Institute*, (1906) p. 353, (1907) p. 70; F. Cirkel, *Graphite* (Ottawa, 1907). (W. G. M.)

GRAFTOLITES, an assemblage of extinct zoophytes whose skeletal remains are found in the Palaeozoic rocks, occasionally in great abundance. They are usually preserved as branching or unbranching carbonized bodies, tree-like, leaf-like or rod-like in shape, their edges regularly toothed or denticulated. Most frequently they occur lying on the bedding planes of black shales; less commonly they are met with in many other kinds of sediment, and when in limestone they may retain much of their original relief and admit of a detailed microscopic study.

Each Graftolite represents the common horny or chitinous investment or supporting structure of a colony of zooids, each tooth-like projection marking the position of the sheath or *theca* of an individual zooid. Some of the branching forms have a distinct outward resemblance to the polyparies of *Sertularia* and *Plumularia* among the recent Hydrozoa (*Calyploblastea*); in none of the unbranching forms, however, is the similarity by any means close.

The Graftolite polyparies vary considerably in size: the majority range from 1 in. to about 6 in. in length; few examples have been met with having a length of more than 30 in.

Very different views have been held as to the systematic

place and rank of the Graftolites. Linnaeus included them in his group of false fossils (*Graptolithus* = written stone). At one time they were referred by some to the Polyzoa (Bryozoa), and later, by almost general consent, to the Hydrozoa (Calyploblastea) among the Hydrozoa (Hydromedusae). Of late years an opinion is gaining ground that they may be regarded as constituting collectively an independent phylum of their own (*Graptolithina*).

There are two main groups, or sub-phyla: the *Graptoloidea* or Graftolites proper, and the *Dendroidea* or tree-like Graftolites; the former is typified by the unbranched genus *Monograptus* and the latter by the many-branched genus *Dendrograptus*.

A *Monograptus* makes its first appearance as a minute dagger-like body (the *sicula*), which represents the flattened covering of the primary or embryonic zooid of the colony. This *sicula*, which had originally the shape of a hollow cone, is formed of two portions or regions—an upper and smaller (*apical* or embryonic) portion, marked by delicate longitudinal lines, and having a fine tabular thread (the *nema*) proceeding from its apex; and a lower (*thecal* or *apertural*) portion, marked by transverse lines of growth and widening in the direction of the mouth, the lip or apertural margin of which forms the broad end of the *sicula*. This margin is normally furnished with a perpendicular spine (*virgella*) and occasionally with two shorter lateral spines or lobes.

A bud is given off from the *sicula* at a variable distance along its length. From this bud is developed the first zooid and first serial *theca* of the colony. This *theca* grows in the direction of the apex of the *sicula*, to which it adheres by its dorsal wall. Thus while the mouth of the *sicula* is directed downwards, that of the first serial *theca* is pointed upwards, making a theoretical angle of about 180° with the direction of that of the *sicula*.

From this first *theca* originates a second, opening in the same direction, and from the second a third, and so on, in a continuous linear series until the polyparity is complete. Each zooid buds from the one immediately preceding it in the series, and intercommunication is effected by all the budding orifices (including that in the wall of the *sicula*) remaining permanently open. The *sicula* itself ceases to grow soon after the earliest *theca* have been developed; it remains permanently attached to the dorsal wall of the polyparity, of which it forms the proximal end, its apex rarely reaching beyond the third or fourth *theca*.

A fine cylindrical rod or fibre (the so-called solid axis or *virgula*) becomes developed in a median groove in the dorsal wall of the polyparity, and is sometimes continued distally as a naked rod. It was formerly supposed that a *virgula* was present in all the Graptoloidea; hence the term *Rhabdophora* sometimes employed for the Graptoloidea in general, and *rhabdosome* for the individual polyparity; but while the *virgula* is present in many (*Axonophora*) it is absent as such in others (*Axonolipsa*).

The **GRAFTOLOIDEA** are arranged in eight families, each named after a characteristic genus: (1) *Dichograptidae*; (2) *Leptograptidae*; (3) *Dicranograptidae*; (4) *Diplograptidae*; (5) *Glossograptidae* (sub-family, *Lasiograptidae*); (6) *Retiolitidae*; (7) *Dimorphograptidae*; (8) *Monograptidae*.

In all these families the polyparity originates as in *Monograptus* from a nema-bearing *sicula*, which invariably opens downwards and gives off only a single bud, such branching as may take place occurring at subsequent stages in the growth of the polyparity. In some species young examples have been met with in which the nema ends above in a small membranous disk, which has been interpreted as an organ of attachment to the underside of floating bodies, probably sea weeds, from which the young polyparity hung suspended.

Broadly speaking, these families make their first appearance in time in the order given above, and show a progressive morphological evolution along certain special lines. There is a tendency for the branches to become reduced in number, and for the serial *thecae* to become directed more and more upwards towards the line of the nema. In the oldest family—*Dichograptidae*—in which the branching polyparity is bilaterally symmetrical and the *thecae* uniserial (*monoprionidic*)—there is a gradation from earlier groups with many branches to later groups with only two; and from species in which all the branches and their *thecae* are directed downwards, through species in which the branches become bent back more and more outwards and upwards, until in some the terminal *thecae* open almost vertically. In the genus *Phyllograptus* the branches have become reduced

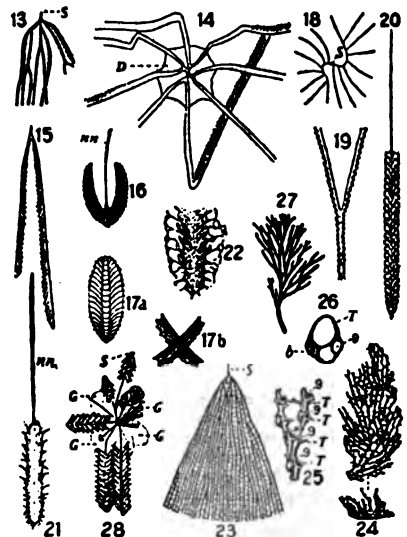
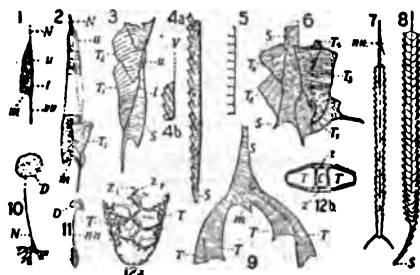

- 1, *Diptograptus*, young sicula.
 - 2, *Monograptus dubius*, sicula and first serial theta (partly restored).
 - 3, Young form (all above after Wiman).
 - 4a, Older form.
 - 4b, Showing virgula (after Holm).
 - 5, *Rastrites distans*.
 - 6, Base of *Diptograptus* (after Wiman).
 - 7, *D. calcaratus*.
 - 8, *Dimorphograptus*.
 - 9, Base of *Didymograptus minus* (after Holm).
 - 10, Young *Dictyograptus*, with primary disk.
 - 11, *Ibid.* *Dictyograptus* (after Ruedemann).
 - 12 a-b, Base and transverse section, *Retiolites Geinitzianns* (after Holm).
 - 13, *Bryograptus Kjerulfs*.
 - 14, *Dichograptus octobrachiatus*, with central disk.
 - 15, *Didymograptus Murchisoni*.
 - 16, *D. gibberulus*.
 - 17 a-b, *Phyllograptus* and transverse section.
 - 18, *Nemagraptus gracilis*.
 - 19, *Dicanograptus ramosus*.
 - 20, *Climacograptus Scharenbergi*.
 - 21, *Glossograptus Hincksii*.
 - 22, *Lasiograptus costatus* (after Elles and Wood).
 - 23, *Dictyonema (-graptus) flabelliforme (-is)*.
 - 24, *Dictyonema (-dendron) petatum* with base of attachment.
 - 25, *D. cervicorne*, branches (after Holm).
 - 26, *D. rarum* (section after Wiman).
 - 27, *Dendrograptus Hallianus*.
 - 28, Synrhadosome of *Diptograptus* (after Ruedemann).
- S, Sicula.
 u, Upper or apical portion.
 l, Lower or apertural.
 m, Mouth.
 N, Nema.
 nn, Nemacaulus or virgular tube.
 V, Virgula.
 v, Virgella.
 sv, Septal strands.
 T, Theca.
 C, Common canal (in *Retiolites*).
 G, Gonangium.
 g, Gonotheca.
 b, Budding theca.

to four and these coalesce by their dorsal walls along the line of the nema, and the sicula becomes embedded in the base of the

polyary. In the family of the *Diplograptidae* the branches are reduced to two; these also coalesce similarly by their dorsal walls, and the polyary thus becomes biserial (*diprionid*), and the nema is taken by a long axial tube-like structure, the *nemacaulus* or virgular tube. Finally, in the latest family, the *Monograptidae*, the branches are theoretically reduced to one, the polyary is uniserial throughout, and all the thecae are directed outwards and upwards.

The thecae in the earliest family—*Dichograptidae*—are so similar in form to the sicula itself that the polyary has been compared to a colony of siculae; there is the greatest variation in shape in those of the latest family—*Monograptidae*—in some species of which the terminal portion of each theca becomes isolated (*Rastrites*) and in some coiled into a rounded lobe. The thecae in several of the families are occasionally provided with spines or lateral processes: the spines are especially conspicuous at the base in some biserial forms: in the *Lasiograptidae* the lateral processes originate a marginal meshwork surrounding the polyary.

Histologically, the periarc or test in the *Graptoloidea* appears to be composed of three layers, a middle layer of variable structure, and an overlying and an underlying layer of remarkable tenacity. The central layer is usually thick and marked by lines of growth; but in *Glossograptus* and *Lasiograptus* it is thinned down to a fine membrane stretched upon a skeleton framework of lists and fibres, and in *Retiolites* this membrane is reduced to a delicate network. The groups typified by these three genera are sometimes referred to, collectively, as the *Retioloidea*, and the structure as *retioid*.

It is the general practice of paleontologists to regard each graptolite polyary (*rhadosome*) developed from a single sicula as an individual of the highest order. Certain American forms, however, which are preserved as stellate groups, have been interpreted as complex umbrella-shaped colonial stocks, individuals of a still higher order (*synrhadosomes*), composed of a number of biserial polyaries (each having a sicula at its outer extremity) attached by their nemacauli to a common centre of origin, which is provided with two disks, a swimming bladder and a ring of capsules.

In the *DENDROIDEA*, as a rule, the polyary is non-symmetrical in shape and tree-like or shrub-like in habit, with numerous branches irregularly disposed, and with a distinct stem-like or short basal portion ending below in root-like fibres or in a membranous disk or sheet of attachment. An exception, however, is constituted by the comprehensive genus *Dictyonema*, which embraces species composed of a large number of divergent and sub-parallel branches, united by transverse dissepiments into a symmetrical cone-like or funnel-shaped polyary, and includes some forms (*Dictyograptus*) which originate from a nema-bearing sicula and have been claimed as belonging to the *Graptoloidea*.

Of the early development of the polyary in the *Dendroidea* little is known, but the more mature stages have been fully worked out. In *Dictyonema* the branches show thecae of two kinds: (1) the ordinary tubular thecae answering to those of the *Graptoloidea* and occupied by the nourishing zooids; and (2) the so-called *bithecae*, birdnest-like cups (regarded by their discoverers as gonothecae) opening alternately right and left of the ordinary thecae. Internally, there existed a third set of thecae, held to have been inhabited by the budding individuals. In the genus *Dendrograptus* the gonothecae open within the walls of the ordinary thecae, and the branches present an outward resemblance to those of the uniserial *Graptoloidea*. But in striking contrast to what obtains among the *Graptoloidea* in general, the budding orifices in the *Dendroidea* become closed, and all the various cells shut off from each other.

The classification of the *Dendroidea* is as yet unsatisfactory: the families most conspicuous are those typified by the genera *Dendrograptus*, *Dictyonema*, *Inocaulis* and *Thamnograptus*.

As regards the modes of reproduction among the *Graptolites* little is known. In the *Dendroidea*, as already pointed out, the bithecae were possibly gonothecae, but they have been interpreted by some as nematophores. In the *Graptoloidea* certain lateral and vesicular appendages of the polyary in the *Lasiograptidae* have been looked upon as connected with the reproductive system, and in the umbrella-shaped *synrhadosomes* already referred to, the common centre is surrounded by a ring of what have been regarded as ovarian capsules. The theory of the gonangial nature of the vesicular bodies in the *Graptoloidea* is, however, disputed by some authorities, and it has been suggested that the zooid of the sicula itself is not the

product of the normal or sexual mode of propagation in the group, but owes its origin to a peculiar type of budding or non-sexual reproduction, in which, as temporary resting or protecting structures, the vesicular bodies may have had a share.

As respects the mode of life of the Graptolites there can be little doubt that the Dendroidea were, with some exceptions, sessile or benthonic animals, their polyparies, like those of the recent Calyptoblastea, growing upwards, their bases remaining attached to the sea floor or to foreign bodies, usually fixed. The Graptoloidea have also been regarded by some as benthonic organisms. A more prevalent view, however, is that the majority were pseudo-planktonic or drifting colonies, hanging from the underside of floating seaweeds; their polyparies being each suspended by the nema in the earliest stages of growth, and, in later stages, some by the nemacaulus, while others became adherent above by means of a central disk or by parts of their dorsal walls. Some of these ancient seaweeds may have remained permanently rooted in the littoral regions, while others may have become broken off and drifted, like the recent Sargassum, at the mercy of the winds and currents, carrying the attached Graptolites into all latitudes. The more complex umbrella-shaped colonies of colonies (synhabdosomes) described as provided with a common swimming bladder (pneumatophore?) may have attained a holo-planktonic or free-swimming mode of existence.

The range of the Graptolites in time extends from the Cambrian to the Carboniferous. The Dendroidea alone, however, have this extended range, the Graptoloidea becoming extinct at the close of Silurian time. Both groups make their first appearance together near the end of the Cambrian; but while in the succeeding Ordovician and Silurian the Dendroidea are comparatively rare, the Graptoloidea become the most characteristic and, locally, the most abundant fossils of these systems.

The species of the Graptoloidea have individually a remarkably short range in geological time; but the geographical distribution of the group as a whole, and that of many of its species, is almost world-wide. This combination of circumstances has given the Graptoloidea a paramount stratigraphical importance as palaeontological indices of the detailed sequence and correlation of the Lower Palaeozoic rocks in general. Many Graptolite zones, showing a constant uniformity of succession, paralleled in this respect only by the longer known Ammonite zones of the Jurassic, have been distinguished in Britain and northern Europe, each marked by a characteristic species. Many British species and associations of genera and species, occurring on corresponding horizons to those on which they are found in Britain, have been met with in the graptolite-bearing Lower Palaeozoic formations of other parts of Europe, in America, Australia, New Zealand and elsewhere.

BIBLIOGRAPHY.—Linnaeus, *Systema naturae* (12th ed. 1768); Hall, *Graptolites of the Quebec Group* (1865); Barrande, *Graptolites de Bohême* (1850); Carruthers, *Revision of the British Graptolites* (1868); H. A. Nicholson, *Monograph of British Graptolites*, pt. 1 (1872); id. and J. E. Marr, *Phylogeny of the Graptolites* (1895); Hopkinson, *On British Graptolites* (1869); Allman, *Monograph of Gynoblastic Hydroids* (1872); Lapworth, *An Improved Classification of the Rhizophora* (1873); *The Geological Distribution of the Rhizophora* (1879, 1880); Walther, *Lebensweise fossiler Meerestiere* (1897); Tullberg, *Skånes Graptoliter* (1882, 1883); Törnquist, *Graptolites Scaniae Rastrites Beds* (1899); Wiman, *Die Graptoliten* (1895); Holm, *Göteborgs Graptoliter* (1890); Perner, *Graptolites de Bohême* (1894-1899); R. Ruedemann, *Development and Mode of Growth of Diplorhynchus* (1895-1896); *Graptolites of New York*, vol. i. (1904), vol. ii. (1908); Frech, *Lithaea palaeozoica, Graptolithiden* (1897); Elles and Wood, *Monograph of British Graptolites* (1901-1909). (C. L. *)

GRASLITZ (Czech, *Kraslice*), a town of Bohemia, on the Zwodau, 145 m. N.W. of Prague by rail. Pop. (1900) 11,803, exclusively German. Graslitz is one of the most important industrial towns of Bohemia, its specialities being the manufacture of musical instruments, carried on both as a factory and a domestic industry, and lace-making. Next in importance are cotton-spinning and weaving, machine embroidery, brewing, and the mother-of-pearl industry.

GRASMERE, a village and lake of Westmorland, in the heart of the English Lake District. The village (pop. of urban district

in 1901, 781) lies near the head of the lake, on the small river Rothay and the Keswick-Ambleside road, 12½ m. from Keswick and 4 from Ambleside. The scenery is very beautiful; the valley about the lakes of Grasmere and Rydal Water is in great part wooded, while on its eastern flank there rises boldly the range of hills which includes Rydal Fell, Fairfield and Seat Sandal, and, farther north, Helvellyn. On the west side are Loughrigg Fell and Silver How. The village has become a favourite centre for tourists, but preserves its picturesque and sequestered appearance. In a house still standing William Wordsworth lived from 1799 to 1808, and it was subsequently occupied by Thomas de Quincey and by Hartley Coleridge. Wordsworth's tomb, and also that of Coleridge, are in the churchyard of the ancient church of St Oswald, which contains a memorial to Wordsworth with an inscription by John Keble. A festival called the Rushbearing takes place on the Saturday within the octave of St Oswald's day (August 5th), when a holiday is observed and the church decorated with rushes, heather and flowers. The festival is of early origin, and has been derived by some from the Roman *Floralia*, but appears also to have been made the occasion for carpeting the floors of churches, unpaved in early times, with rushes. Moreover, in a procession which forms part of the festivities at Grasmere, certain Biblical stories are symbolized, and in this a connexion with the ancient miracle plays may be found (see H. D. Rawnsley, *A Rambler's Note-Book of the English Lakes*, Glasgow, 1902). Grasmere is also noted for an athletic meeting in August.

The lake of Grasmere is just under 1 m. in length, and has an extreme breadth of 766 yds. A ridge divides the basin from north to south, and rises so high as to form an island about the middle. The greatest depth of the lake (75 ft.) lies to the east of this ridge.

GRASS AND GRASSLAND, in agriculture. The natural vegetable covering of the soil in most countries is "grass" (for derivation see GRASSES) of various kinds. Even where dense forest or other growth exists, if a little daylight penetrates to the ground grass of some sort or another will grow. On ordinary farms, or wherever farming of any kind is carried out, the proportion of the land not actually cultivated will either be in grass or will revert naturally to grass in time if left alone, after having been cultivated.

Pasture land has always been an important part of the farm, but since the "era of cheap corn" set in its importance has been increased, and much more attention has been given to the study of the different species of grass, their characteristics, the improvement of a pasture generally, and the "laying down" of arable land into grass where tillage farming has not paid. Most farmers desire a proportion of grass-land on their farms—from a third to a half of the area—and even on wholly arable farms there are usually certain courses in the rotation of crops devoted to grass (or clover). Thus the Norfolk 4-course rotation is corn, roots, corn, clover; the Berwick 5-course is corn, roots, corn, grass, grass; the Ulster 8-course, corn, flax, roots, corn, flax, grass, grass; and so on, to the point where the grass remains down for 5 years, or is left indefinitely.

Permanent grass may be grazed by live-stock and classed as pasture pure and simple, or it may be cut for hay. In the latter case it is usually classed as "meadow" land, and often forms an alluvial tract alongside a stream, but as grass is often grazed and hayed in alternate years, the distinction is not a hard and fast one.

There are two classes of pasturage, temporary and permanent. The latter again consists of two kinds, the permanent grass natural to land that has never been cultivated, and the pasture that has been laid down artificially on land previously arable and allowed to remain and improve itself in the course of time. The existence of ridge and furrow on many old pastures in Great Britain shows that they were cultivated at one time, though perhaps more than a century ago. Often a newly laid down pasture will decline markedly in thickness and quality about the fifth and sixth year, and then begin to thicken and improve year by year afterwards. This is usually attributed

to the fact that the unsuitable varieties die out, and the "naturally" suitable varieties only come in gradually. This trouble can be largely prevented, however, by a judicious selection of seed, and by subsequently manuring with phosphatic manures, with farmyard or other bulky "topdressings," or by feeding sheep with cake and corn over the field.

All the grasses proper belong to the natural order *Gramineae* (see GRASSES), to which order also belong all the "corn" plants cultivated throughout the world, also many others, such as bamboo, sugar-cane, millet, rice, &c. &c., which yield food for mankind. Of the grasses which constitute pastures and hay-fields over a hundred species are classified by botanists in Great Britain, with many varieties in addition, but the majority of these, though often forming a part of natural pastures, are worthless or inferior for farming purposes. The grasses of good quality which should form a "sole" in an old pasture and provide the bulk of the forage on a newly laid down piece of grass are only about a dozen in number (see below), and of these there are only some six species of the very first importance and indispensable in a "prescription" of grass seeds intended for laying away land in temporary or permanent pasture. Dr W. Fream caused a botanical examination to be made of several of the most celebrated pastures of England, and, contrary to expectation, found that their chief constituents were ordinary perennial ryegrass and white clover. Many other grasses and legumes were present, but these two formed an overwhelming proportion of the plants.

In ordinary usage the term grass, pasturage, hay, &c., includes many varieties of clover and other members of the natural order *Leguminosae* as well as other "herbs of the field," which, though not strictly "grasses," are always found in a grass field, and are included in mixtures of seeds for pasture and meadows. The following is a list of the most desirable or valuable agricultural grasses and clovers, which are either actually sown or, in the case of old pastures, encouraged to grow by draining, liming, manuring, and so on:—

Grasses.

- Alopecurus pratensis* . . . Meadow foxtail.
- Anthoxanthum odoratum* . . . Sweet vernal grass.
- Avena elatior* . . . Tall oat-grass.
- Avena flavescens* . . . Golden oat-grass.
- Cynosurus cristatus* . . . Crested dogstail.
- Dactylis glomerata* . . . Cocksfoot.
- Festuca duriuscula* . . . Hard fescue.
- Festuca elatior* . . . Tall fescue.
- Festuca ovina* . . . Sheep's fescue.
- Festuca pratensis* . . . Meadow fescue.
- Lolium italicum* . . . Italian ryegrass.
- Phleum pratense* . . . Timothy or catstail.
- Poa nemoralis* . . . Wood meadow-grass.
- Poa pratensis* . . . Smooth meadow-grass.
- Poa trivialis* . . . Rough meadow-grass.

Clovers, &c.

- Medicago lupulina* . . . Trefoil or "Nonsuch."
- Medicago sativa* . . . Lucerne (Alfalfa).
- Trifolium hybridum* . . . Alsike clover.
- Trifolium pratense* . . . Broad red clover.
- Trifolium perenne* . . . Perennial clover.
- Trifolium incarnatum* . . . Crimson clover or "Trifolium."
- Trifolium procumbens* . . . Yellow Hop-trefoil.
- Trifolium repens* . . . White or Dutch clover.
- Achillea Millefolium* . . . Yarrow or Milfoil.
- Anthyllus vulneraria* . . . Kidney-vetch.
- Lotus major* . . . Greater Birdsfoot Trefoil.
- Lotus corniculatus* . . . Lesser " "
- Carum petroselinum* . . . Field parsley. " "
- Plantago lanceolata* . . . Plantain.
- Cichorium intybus* . . . Chicory.
- Poterium officinale* . . . Burnet.

The predominance of any particular species is largely determined by climatic circumstances, the nature of the soil and the treatment it receives. In limestone regions sheep's fescue has been found to predominate; on wet clay soil the dog's bent (*Agrostis canina*) is common; continuous manuring with nitrogenous manures kills out the leguminous plants and stimulates such grasses as cocksfoot; manuring with phosphates stimulates the clovers and other legumes; and so on. Manuring with

basic slag at the rate of from 5 to 10 cwt. per acre has been found to give excellent results on poor clays and peaty soils. Basic slag is a by-product of the Bessemer steel process, and is rich in a soluble form of phosphate of lime (tetra-phosphate) which specially stimulates the growth of clovers and other legumes, and has reduced many inferior pastures.

In the Rothamsted experiments continuous manuring with "mineral manures" (no nitrogen) on an old meadow has reduced the grasses from 71 to 64% of the whole, while at the same time it has increased the *Leguminosae* from 7% to 24%. On the other hand, continuous use of nitrogenous manure in addition to "minerals" has raised the grasses to 94% of the total and reduced the legumes to less than 1%.

As to the best kinds of grasses, &c., to sow in making a pasture out of arable land, experiments at Cambridge, England, have demonstrated that of the many varieties offered by seedsmen only a very few are of any permanent value. A complex mixture of tested seeds was sown, and after five years an examination of the pasture showed that only a few varieties survived and made the "sole" for either grazing or forage. These varieties in the order of their importance were:—

Cocksfoot	26
Perennial rye grass	16
Meadow fescue	13
Hard fescue	9
Crested dogstail	8
Timothy	6
White clover	4
Meadow foxtail	2

The figures represent approximate percentages.

Before laying down grass it is well to examine the species already growing round the hedges and adjacent fields. An inspection of this sort will show that the Cambridge experiments are very conclusive, and that the above species are the only ones to be depended on. Occasionally some other variety will be prominent, but if so there will be a special local reason for this.

On the other hand, many farmers when sowing down to grass like to have a good bulk of forage for the first year or two, and therefore include several of the clovers, lucerne, Italian ryegrass, evergreen ryegrass, &c., knowing that these will die out in the course of years and leave the ground to the more permanent species.

There are also several mixtures of "seeds" (the technical name given on the farm to grass-seeds) which have been adopted with success in laying down permanent pasture in some localities.

	Young.	De Laune.	Leicester.	Elliot.	Cambridge average.	General purpose mixture.
Cocksfoot	8	4	8	8	4	
Perennial ryegrass	2	2	2	6	10	
Meadow fescue	6	2	2	5	..	
Hard fescue	1	1	2	3	..	
Crested dogstail	3	2	1	3	..	
Timothy	3	1	..	2	2	
Meadow foxtail	10	1	1	
Tall fescue	3	1	3½	..	2	
Tall oat grass	1	3	
Italian ryegrass	2	5	
Smooth meadow grass	1	
Rough meadow grass	1	..	1	
Golden oat grass	1	1	
Sheep's fescue	1	
Broad red clover	1	2	
Perennial red clover	1	..	1½	..	2	
Alsike	1	1½	1	..	8	
Lucerne (Alfalfa)	
White clover	4	1	1	2	2	
Kidney vetch	6	..	2½	
Sheep's parsley	1	
Yarrow	1	1	1	
Burnet	8	..	8	
Chicory	4	..	2½	
Plantain	4	
Total lb per acre	30	40	17	40	30	40

Arthur Young more than 100 years ago made out one to suit chalky hillsides; Mr Faunce de Laune (Sussex) in our days was the first to study grasses and advocated leaving out ryegrass of all kinds; Lord Leicester adopted a cheap mixture suitable for poor land with success; Mr Elliot (Kello) has introduced many deep-rooted "herbs" in his mixture with good results. Typical examples of such mixtures are given on preceding page.

Temporary pastures are commonly resorted to for rotation purposes, and in these the bulky fast-growing and short-lived grasses and clovers are given the preference. Three examples of temporary mixtures are given below.

	One year.	Two years.	Three or four years.
Italian ryegrass	14	10	6
Cocksfoot	2	4	6
Timothy	2	3
Broad red clover	8	5	3
Alsike	3	2	2
Trefoil	3	2	2
Perennial ryegrass	5	10
Meadow fescue	2	2
Perennial red clover	2	2
White clover	1	2
Meadow foxtail	1	2
Total lb per acre	30	36	40

Where only a one-year hay is required, broad red clover is often grown, either alone or mixed with a little Italian ryegrass, while other forage crops, like trefoil and trifolium, are often grown alone.

In Great Britain a heavy clay soil is usually preferred for pasture, both because it takes most kindly to grass and because the expense of cultivating it makes it unprofitable as arable land when the price of corn is low. On light soil the plant frequently suffers from drought in summer, the want of moisture preventing it from obtaining proper root-hold. On such soil the use of a heavy roller is advantageous, and indeed on any soil excepting heavy clay frequent rolling is beneficial to the grass, as it promotes the capillary action of the soil-particles and the consequent ascension of ground-water.

In addition, the grass on the surface helps to keep the moisture from being wasted by the sun's heat.

The graminaceous crops of western Europe generally are similar to those enumerated. Elsewhere in Europe are found certain grasses, such as Hungarian brome, which are suitable for introduction into the British Isles. The grasses of the American prairies also include many plants not met with in Great Britain. Some half-dozen species are common to both countries: Kentucky "blue-grass" is the British *Poa pratensis*; couch grass (*Triticum repens*) grows plentifully without its underground runners; bent (*Agrostis vulgaris*) forms the famous "red-top," and so on. But the American buffalo-grass, the Canadian buffalo-grass, the "bunch" grasses, "squirrel-tail" and many others which have no equivalents in the British Islands, form a large part of the prairie pasturage. There is not a single species of true clover found on the prairies, though cultivated varieties can be introduced. (P. McC.)

GRASSE, FRANÇOIS JOSEPH PAUL, MARQUIS DE GRASSE-TILLY, COMTE DE (1722-1788), French sailor, was born at Bar, in the present department of the Alpes Maritimes. In 1734 he took service on the galleys of the order of Malta, and in 1740 entered the service of France, being promoted to chief of squadron in 1770. He took part in the naval operations of the American War of Independence, and distinguished himself in the battles of Dominica and Saint Lucia (1780), and of Tobago (1781). He was less fortunate at St Kitts, where he was defeated by Admiral Hood. Shortly afterwards, in April 1782, he was defeated and taken prisoner by Admiral Rodney. Some months later he returned to France, published a *Mémoire justificatif*, and was acquitted by a court-martial (1784). He died at Paris in January 1788.

His son Alexandre de Grasse, published a *Notice bibliographique sur l'amiral comte de Grasse d'après les documents inédits* in 1840. See G. Lacour-Gayet, *La Marine militaire de la France sous le règne de Louis XV* (Paris, 1902).

GRASSE, a town in the French department of the Alpes Maritimes (till 1860 in that of the Var), 12½ m. by rail N. of Cannes. Pop. (1906) town, 13,958; commune, 20,305. It is built in a picturesque situation, in the form of an amphitheatre and at a height of 1066 ft. above the sea, on the southern slope of a hill, facing the Mediterranean. In the older (eastern) part of the town the streets are narrow, steep and winding, but the new portion (western) is laid out in accordance with modern French ideas. It possesses a remarkably mild and salubrious climate, and is well supplied with water. That used for the purpose of the factories comes from the fine spring of Foux. But the drinking water used in the higher portions of the town flows, by means of a conduit, from the Foulon stream, one of the sources of the Loup. Grasse was from 1244 (when the see was transferred hither from Antibes) to 1790 an episcopal see, but was then included in the diocese of Fréjus till 1860, when politically as well as ecclesiastically, the region was annexed to the newly-formed department of the Alpes Maritimes. It still possesses a 12th-century cathedral, now a simple parish church; while an ancient tower, of uncertain date, rises close by near the town hall, which was formerly the bishop's palace (13th century). There is a good town library, containing the muniments of the abbey of Lérins, on the island of St Honorat opposite Cannes. In the chapel of the old hospital are three pictures by Rubens. The painter J. H. Fragonard (1732-1806) was a native of Grasse, and some of his best works were formerly to be seen here (now in America). Grasse is particularly celebrated for its perfumery. Oranges and roses are cultivated abundantly in the neighbourhood. It is stated that the preparation of attar of roses (which costs nearly £100 per 2 lb) requires alone nearly 7,000,000 roses a year. The finest quality of olive oil is also manufactured at Grasse. (W. A. B. C.)

GRASSES,¹ a group of plants possessing certain characters in common and constituting a family (Gramineae) of the class Monocotyledons. It is one of the largest and most widespread and, from an economic point of view, the most important family of flowering plants. No plant is correctly termed a grass which is not a member of this family, but the word is in common language also used, generally in combination, for many plants of widely different affinities which possess some resemblance (often slight) in foliage to true grasses; e.g. knot-grass (*Polygonum aviculare*), cotton-grass (*Eriophorum*), rib-grass (*Plantago*), scorpion-grass (*Myosotis*), blue-eyed grass (*Sisyrinchium*), sea-grass (*Zostera*). The grass-tree of Australia (*Xanthorrhoea*) is a remarkable plant, allied to the rushes in the form of its flower, but with a tall, unbranched, soft-woody, palm-like trunk bearing a crown of long, narrow, grass-like leaves and stalked heads of small, densely-crowded flowers. In agriculture the word has an extended signification to include the various fodder-plants, chiefly leguminous, often called "artificial grasses." Indeed, formerly *grass* (also spelt *gurs*, *ges*, *gyrs* in the old herbals) meant any green herbaceous plant of small size.

Yet the first attempts at a classification of plants recognized and separated a group of *Gramina*, and this, though bounded by nothing more definite than habit and general appearance, contained the Gramineae of modern botanists. The older group, however, even with such systematists as Ray (1703), Scheuchzer (1719), and Micheli (1729), embraced in addition the Cyperaceae

¹ The word "grass" (O. Eng. *gers*, *græs*) is common to Teutonic languages, cf. Dutch Ger. Goth. *gras*, Dan. *græs*; the root is the O. Teut. *gra-*, *gro-*, to increase, whence "grow," and "green," the typical colour of growing vegetation. The Indo-European root is seen in Lat. *gramen*. The O. Eng. *grasian*, formed from *græs*, gives "to graze," of cattle feeding on growing herbage, also "grazier," one who grazes or feeds cattle for the market, "so graze," to abrade, to touch lightly in passing, may be a development of this from the idea of close cropping; if it is to be distinguished a possible connexion may be found with "glace" (Fr. *glacer*, glide, slip, Lat. *glacies*, ice), to glance off, the change in form being influenced by "grate," to scrape, scratch (Fr. *gratier*, Ger. *kratzen*).

(Sedge family), Juncaceae (Rush family), and some other monocotyledons with inconspicuous flowers. Singularly enough, the sexual system of Linnaeus (1735) served to mark off more distinctly the true grasses from these allies, since very nearly all of the former then known fell under his Triandria Digynia, whilst the latter found themselves under his other classes and orders.

I. STRUCTURE.—The general type of true grasses is familiar in the cultivated cereals of temperate climates—wheat, barley, rye, oats, and in the smaller plants which make up pastures and meadows and form a principal factor of the turf of natural downs. Less familiar are the grains of warmer climates—rice, maize, millet and sorgho, or the sugar-cane. Still farther removed are the bamboos of the tropics, the columnar stems of which reach to the height of forest trees. All are, however, formed on a common plan.

Root.—Most cereals and many other grasses are annual, and possess a tuft of very numerous slender root-fibres, much branched and of great length. The majority of the members of the family are of longer duration, and have the roots also fibrous, but fewer, thicker and less branched. In such cases they are very generally given off from just above each node (often in a circle) of the lower part of the stem or rhizome, perforating the leaf-sheaths. In some bamboos they are very numerous from the lower nodes of the erect culms, and pass downwards to the soil, whilst those from the upper nodes shrivel up and form circles of spiny fibres.

Stem.—The underground stem or rootstock (rhizome) of perennial grasses is usually well developed, and often forms very



FIG. 1.—Rhizome of Bamboo. A, B, C, D, successive series of axes, the last bearing aerial culms. Much reduced.

long creeping or subterranean rhizomes, with elongated internodes and sheathing scales; the widely-creeping, slender rhizomes in Marram-grass (*Psamma*), *Agropyrum junceum*, *Elymus arenarius*, and other sand-loving plants render them useful as sand-binders. It is also frequently short, with the nodes crowded. The turf-formation, which is characteristic of open situations in cool temperate climates, results from an extensive production of short stolons, the branches and the fibrous roots developed from their nodes forming the dense "sod." The very large rhizome of the bamboos (fig. 1) is also a striking example of "definite" growth; it is much branched, the short, thick, curved branches being given off below the apex of the older ones and at right angles to them, the whole forming a series of connected arched axes, truncate at their ends, which were formerly continued into leafy culms. The rhizome is always solid, and has the usual internal structure of the monocotyledonous stem. In the cases of branching just cited the branches break directly through the sheath of the leaf in connexion with which they arise. In other cases the branches grow upwards through the sheaths which they ultimately split from above, and emerging as aerial shoots give a tufted habit to the plant. Good examples are the oat, cock's-foot (*Dactylis*) and other British grasses. This mode of growth is the cause of the "tillering" of cereals, or the production of a large number of erect growing branches from the lower nodes of the young stem. Isolated tufts or tussocks are also characteristic of steppe—and savanna—vegetation and open places generally in the warmer parts of the earth.

The aerial leaf-bearing branches (culms) are a characteristic feature of grasses. They are generally numerous, erect, cylindrical (rarely flattened) and conspicuously jointed with evident nodes. The nodes are solid, a strong plate of tissue passing across the stem, but the internodes are commonly hollow, although examples of completely solid stems are not uncommon (e.g. maize, many *Andropogons*, sugar-cane). The swollen nodes are a characteristic feature. In wheat, barley and most of the British native grasses they are a development, not of the culm, but of the base of the leaf-sheath. The function of the nodes is to raise again culms which have become bent down; they are composed of highly turgid tissue, the cells of which elongate on the side next the earth when the culm is placed in a horizontal or oblique position, and thus raise the culm again to an erect position. The internodes continue to grow in length, especially the upper ones, for some time; the increase takes place in a zone at the extreme base, just above the node. The exterior of the culms is more or less concealed by the leaf-sheaths; it is usually smooth and often highly polished, the epidermal cells containing an amount of silica sufficient to leave after burning a distinct skeleton of their structure. Tabasheer is a white substance mainly composed of silica, found in the joints of several bamboos. A few of the lower internodes may become enlarged and sub-globular, forming nutrient-stores, and grasses so characterized are termed "bulbous" (*Arrhenatherum*, *Poa bulbosa*, &c.). In internal structure grass-culms, save in being hollow, conform to that usual in monocotyledons; the vascular bundles run parallel in the internodes, but a horizontal interlacement occurs at the nodes. In grasses of temperate climates branching is rare at the upper nodes of the culm, but it is characteristic of the bamboos and many tropical grasses. The branches are strictly distichous. In many bamboos they are long and spreading or drooping and copiously ramified, in others they are reduced to hooked spines. One genus (*Dinochloa*, a native of the Malay archipelago) is scandent, and climbs over trees 100 ft. or more in height, *Olyra latifolia*, a widely-spread tropical species, is also a climber on a humbler scale.

Grass-culms grow with great rapidity, as is most strikingly seen in bamboos, where a height of over 100 ft. is attained in from two to three months, and many species grow two, three or even more feet in twenty-four hours. Silicic hardening does not begin till the full height is nearly attained. The largest bamboo recorded is 170 ft., and the diameter is usually reckoned at about 4 in. to each 50 ft.

Leaves.—These present special characters usually sufficient for ordinal determination. They are solitary at each node and arranged in two rows, the lower often crowded, forming a basal tuft. They consist of two distinct portions, the sheath and the blade. The sheath is often of great length, and generally completely surrounds the culm, forming a firm protection for the internode, the younger basal portion of which, including the zone of growth, remains tender for some time. As a rule it is split down its whole length, thus differing from that of Cyperaceae which is almost invariably (*Eriospora* is an exception) a complete tube; in some grasses, however (species of *Poa*, *Bromus* and others), the edges are united. The sheaths are much dilated in *Alopecurus vaginatus* and in a species of *Potamochoa*, in the latter, an East Indian aquatic grass, serving as floats. At the summit of the sheath, above the origin of the blade, is the *ligule*, a usually membranous process of small size (occasionally reaching 1 in. in length) erect and pressed around the culm. It is rarely quite absent, but may be represented by a tuft of hairs (very conspicuous in *Pariana*). It serves to prevent rain-water, which has run down the blade, from entering the sheath. *Melica uniflora* has in addition to the ligule, a green erect tongue-like process, from the line of junction of the edges of the sheath.

The blade is frequently wanting or small and imperfect in the basal leaves, but in the rest is long and set on to the sheath at an angle. The usual form is familiar—sessile, more or less ribbon-shaped, tapering to a point, and entire at the edge. The chief modifications are the articulation of the deciduous

blade on to the sheath, which occurs in all the Bambuseae (except *Planolia*) and in *Spartina stricta*; and the interposition of a petiole between the sheath and the blade, as in bamboos, *Leptaspis*, *Pharus*, *Pariana*, *Lophatherum* and others. In the latter case the leaf usually becomes oval, ovate or even cordate or sagittate, but these forms are found in sessile leaves also (*Olyra*, *Panicum*). The venation is strictly parallel, the midrib usually strong, and the other ribs more slender. In *Anomochloa* there are several nearly equal ribs and in some broad-leaved grasses (*Bambuseae*, *Pharus*, *Leptaspis*) the venation becomes



FIG. 2.—Magnified transverse section of one-half of a leaf-blade of *Festuca rubra*. The dark portions represent lines in the intervening supporting and conducting tissue; the furrows. The thick prominent veins in *Agropyrum* occupy the whole

upper surface of the leaf. Epidermal appendages are rare, the most frequent being marginal, saw-like, cartilaginous teeth, usually minute, but occasionally (*Danthonia scabra*, *Panicum serratum*) so large as to give the margin a serrate appearance. The leaves are occasionally woolly, as in *Alopecurus lanatus* and one or two *Panicums*. The blade is often twisted, frequently so much so that the upper and under faces become reversed. In dry-country grasses the blades are often folded on the midrib, or rolled up. The rolling is effected by bands of large wedge-shaped cells—motor-cells—between the nerves, the loss of turgescence by which, as the air dries, causes the blade to curl towards the face on which they occur. The rolling up acts as a protection from too great loss of water, the exposed surface being specially protected to this end by a strong cuticle, the majority or all of the stomata occurring on the protected surface. The stiffness of the blade, which becomes very marked in dry-country grasses, is due to the development of girders of thick-walled mechanical tissue which follow the course of all or the principal veins (fig. 2).

Inflorescence.—This possesses an exceptional importance in grasses, since, their floral envelopes being much reduced and the sexual organs of very great uniformity, the characters employed for classification are mainly derived from the arrangement of the flowers and their investing bracts. Various interpretations have been given to these glumaceous organs and different terms employed for them by various writers. It may, however, be



FIG. 3.—One-flowered spikelet of *Agrostis*.
b, Barren glumes; f, flowering glumes. (Both enlarged.)

considered as settled that the whole of the bodies known as glumes and paleae, and distichously arranged externally to the flower, form no part of the floral envelopes, but are of the nature of bracts. These are arranged so as to form spikelets (fig. 3) two, as in *Aira* (fig. 4) three, or a great number of flowers, as in *Brisa* (fig. 5) *Triticum* (fig. 6); in some species of *Eragrostis* there are nearly 60. The flowers are, as a rule, placed laterally on the axis (*rachilla*) of the spikelet, but in one-flowered spikelets they appear to be terminal, and are probably really

so in *Anthoxanthum* (fig. 7) and in two anomalous genera, *Anomochloa* and *Streptochaeta*.

In immediate relation with the flower itself, and often entirely concealing it, is the *palea* or *pale* ("upper pale" of most systematic agrostologists). This organ (fig. 13, 1) is peculiar to grasses

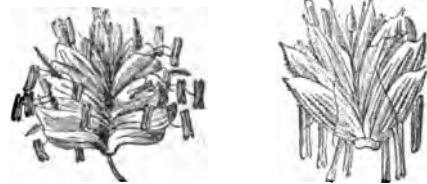

FIG. 5.—Spikelet of *Brisa*. FIG. 6.—Spikelet of *Triticum*.
(Both enlarged.)

among Glumiflorae (the series to which belong the two families Gramineae and Cyperaceae), and is almost always present, certain *Oryzae* and *Phalaridaeae* being the only exceptions. It is of thin membranous consistence, usually obtuse, often bifid, and possesses no central rib or nerve, but has two lateral ones, one on either side; the margins are frequently folded in at the ribs, which thus become placed at the sharp angles. This structure was formerly regarded as pointing to the fusion of two organs, and the pale was considered by Robert Brown to represent two portions soldered together of a trimerous perianth-whorl, the third portion being the "lower pale." The pale is now generally considered to represent the single bracteole, characteristic of Monocotyledons, the binerved



FIG. 7.—Spikelet of *Anthoxanthum* (enlarged) without the two lower barren glumes, showing the two upper awned barren glumes (g) and the flower.

structure being the result of the pressure of the axis of the spikelet during the development of the pale, as in *Iris* and others. The flower with its pale is sessile, and is placed in the axil of another bract in such a way that the pale is exactly opposed to it, though at a slightly higher level. It is this second bract or flowering glume which has been generally called by systematists the "lower pale," and with the "upper pale" was formerly considered to form an outer floral envelope ("calyx," Jussieu; "perianthium," Brown). The two bracts are, however, on different axes, one secondary to the other, and cannot therefore be parts of one whorl of organs. They are usually quite unlike one another, but in some genera (e.g. most *Festuceae*) are very similar in shape and appearance.

The flowering glume has generally a more or less boat-shaped form, is of firm consistence, and possesses a well-marked central midrib and frequently several lateral ones. The midrib in a large proportion of genera extends into an appendage termed the *awn* (fig. 4), and the lateral veins more rarely extend beyond the glume as sharp points (e.g. *Pappophorum*). The form of the flowering glume is very various, this organ being plastic and extensively modified in different genera. It frequently extends downwards a little on the rachilla, forming with the latter a swollen callus, which is separated from the free portion by a furrow. In *Leptaspis* it is formed into a closed cavity by the union of its edges, and encloses the flower, the styles projecting through the pervious summit. Valuable characters for distinguishing genera are obtained from the awn. This presents itself variously developed from a mere subulate point to an organ several inches in length, and when complete (as in *Andropogoneae*, *Aveneae* and *Stipeae*) consists of two well-marked portions, a lower twisted part and a terminal straight portion,

usually set in at an angle with the former, sometimes trifid and occasionally beautifully feathery (fig. 8). The lower part is most often suppressed, and in the large group of the *Panicaceae* awns of any sort are very rarely seen. The awn may be either terminal or may come off from the back of the flowering glume, and Duval Jouve's observations have shown that it represents the

blade of the leaf of which the portion of the flowering glume below its origin is the sheath; the twisted part (so often suppressed) corresponds with the petiole, and the portion of the glume extending beyond the origin of the awn (very long in some species, e.g. of *Danthonia*) with the ligule of the developed foliage-leaf. When terminal the awn has three fibro-vascular bundles, when dorsal only one; it is covered with stomate-bearing epidermis.

The flower with its palea is thus sessile in the axil of a floriferous glume, and in a few grasses (*Leersia* (fig. 9), *Coleanthus*, *Nardus*) the spikelet consists of nothing more, but usually (even in uniflorous spikelets) other glumes are present. Of these the two placed distichously opposite each other at the base of the spikelet never bear any flower in their axils, and are called the *empty* or *barren glumes* (figs. 3, 8). They are the "glumes" of most writers, and together form what was called the "gluma" by R. Brown. They rarely differ much from one another, but one may be smaller or quite absent (*Panicum*, *Setaria* (fig. 10), *Paspalum*, *Lolium*), or both be altogether suppressed, as above noticed. They are commonly firm and strong, often enclose the spikelet, and are rarely provided with long points or imperfect awns. Generally speaking they do not share in the special modifications of the flowering glumes, and rarely themselves undergo modification, chiefly in hardening of portions (*Sclerachne*, *Manisuris*, *Anth-*



FIG. 8.—Spikelet of *Ssipa pennata*. The pair of barren glumes (*b*) are separated from the flowering glume, which bears a long awn, twisted below the knee (*a*). *f*, Flowering glume; *p*, Barren glumes; *f*, flowering pale. About $\frac{1}{2}$ nat. size.

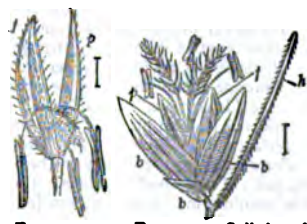

FIG. 9.—Spikelet of *Leersia*, with an abortive branch (*h*) beneath it. *f*, Flowering glume; *p*, Barren glumes; *f*, flowering pale.

phora, *Peltophorum*), so as to afford greater protection to the flowers or fruit. But it is usual to find, besides the basal glumes, a few other empty ones, and these are in two- or more-flowered spikelets (see *Triticum*, fig. 6) at the top of the rhachilla (numerous in *Lophatherum*), or in uniflorous ones (fig. 10) below and interspersed between the floral glume and the basal pair.

The axis of the spikelet is frequently jointed and breaks up into articulations above each flower. Tufts or borders of hairs are frequently present (*Calamagrostis*, *Phragmites*, *Andropogon*), and are often so long as to surround and conceal the flowers (fig. 11). The axis is often continued beyond the last flower or glume as a bristle or stalk.

Involucres or organs outside the spikelets also occur, and are

formed in various ways. Thus in *Setaria* (fig. 10), *Pennisetum*, &c., the one or more circles of simple or feathery hairs represent abortive branches of the inflorescence; in *Cenchrus* (fig. 12) these become consolidated, and the inner ones flattened so as to form a very hard globular spiny case to the spikelets. The cup-shaped involucre of *Cornucopia* is a dilatation of the axis into a hollow receptacle with a raised border. In *Cynosurus* (Dog's tail) the pectinate involucre which conceals the spikelet is a barren or abortive spikelet. Bracts of a more general character subtending branches of the inflorescence are singularly rare in Gramineae, in marked contrast with Cyperaceae, where they are so conspicuous. They however occur in a whole section of *Andropogon*, in *Anomochloa*, and at the base of the spike in *Sesleria*. The remarkable ovoid involucre of *Coix*, which becomes of stony hardness, white and polished (then known as "Job's tears," *q.v.*), is also a modified bract or leaf-sheath. It is closed except at the apex, and contains the female spikelet, the stalks of the male inflorescence and the long styles emerging through the small apical orifice.

Any number of spikelets may compose the inflorescence, and their arrangement is very various. In the spicate forms, with sessile spikelets on the main axis, the latter is often dilated and flattened (*Paspalum*), or is more or less thickened and hollowed out (*Stenolaphrum*, *Rottboellia*, *Tripsacum*), when the spikelets are sunk and buried within the cavities. Every variety of racemose and paniculate inflorescence obtains, and the number of spikelets composing those of the large kinds is often immense. Rarely the inflorescence consists of very few flowers; thus *Lygeum Spartum*, the most anomalous of European grasses, has but two or three large uniflorous spikelets, which are fused together at the base, and have no basal glumes, but are enveloped in a large, hooded, spathe-like bract.

Flower.—This is characterized by remarkable uniformity. The perianth is represented by very rudimentary, small, fleshy scales arising below the ovary, called *lodicules*, they are elongated



FIG. 11.—Spikelet of Reed (*Phragmites communis*) opened out. *a, b*, Barren glumes. *c, c*, Fertile glumes, each enclosing one flower with its pale *d*. Note the zigzag axis (*rhachilla*) bearing long silky hairs.



FIG. 12.—Spikelet of *Cenchrus echinatus* enclosed in a bristly involucre.

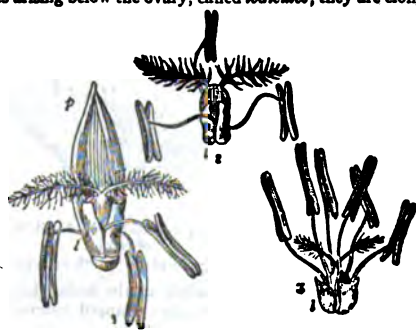

FIG. 13.—Flowers of Grasses (enlarged). 1, *Piptatherum*, with the palea *p*; 2, *Poa*; 3, *Oryza*; *l*, Lodicule.

or truncate, sometimes fringed with hairs, and are in contact with the ovary. Their usual number is two, and they are placed collaterally at the anterior side of the flower (fig. 13.) that is, within the flowering glume. They are generally considered to represent the inner whorl of the ordinary monocotyledonous

(filiceous) perianth, the outer whorl of these being suppressed as well as the posterior member of the inner whorl. This latter is present almost constantly in *Stipeae* and *Bambuseae*, which have three lodicules, and in the latter group they are occasionally more numerous. In *Anomochloa* they are represented by hairs. In *Streptochaeta* there are six lodicules, alternately arranged in two whorls. Sometimes, as in *Anthoxanthum*, they are absent. In *Melica* there is one large anterior lodicule resulting presumably from the union of the two which are present in allied genera. Professor E. Hackel, however, regards this as an undivided second pale, which in the majority of the grasses is split in halves, and the posterior lodicule, when present, as a third pale. On this view the grass-flower has no perianth. The function of the lodicules is the separation of the pale and glume to allow the protrusion of stamens and stigmas; they effect this by swelling and thus exerting pressure on the base of these two structures. Where, as in *Anthoxanthum*, there are no lodicules, pale and glume do not become laterally separated, and the stamens and stigmas protrude only at the apex of the floret (fig. 7). Grass-flowers are usually hermaphrodite, but there are very many exceptions. Thus it is common to find one or more imperfect (usually male) flowers in the same spikelet with bisexual ones, and their relative position is important in classification. *Holcus* and *Arrhenatherum* are examples in English grasses; and as a rule in species of temperate regions separation of the sexes is not carried further. In warmer countries monoecious and dioecious grasses are more frequent. In such cases the male and female spikelets and inflorescence may be very dissimilar, as in maize, Job's tears, *Euchloa*, *Spinifex*, &c.; and in some dioecious species this dissimilarity has led to the two sexes being referred to different genera (e.g. *Antheophora axilliflora* is the female of *Buchloe dactyloides*, and *Neurochne paradoxo* of a species of *Spinifex*). In other grasses, however, with the sexes in different plants (e.g. *Brizopyrum*, *Disitichlis*, *Eragrostis capitata*, *Gyncrium*), no such dimorphism obtains. *Amphicarpum* is remarkable in having cleistogamic flowers borne on long radical subterranean peduncles which are fertile, whilst the conspicuous upper paniculate ones, though apparently perfect, never produce fruit. Something similar occurs in *Leersia oryoides*, where the fertile spikelets are concealed within the leaf-sheaths.

Androecium.—In the vast majority there are three stamens alternating with the lodicules, and therefore one anterior, i.e. opposite the flowering glume, the other two being posterior and in contact with the palea (fig. 13, 1 and 2). They are hypogynous, and have long and very delicate filaments, and large, linear or oblong two-celled anthers, dorsifixed and ultimately very versatile, deeply indented at each end, and commonly exerted and pendulous. Suppression of the anterior stamen sometimes occurs (e.g. *Anthoxanthum*, fig. 7), or the two posterior ones may be absent (*Uniola*, *Cinna*, *Phippisia*, *Festuca bromoides*). There is in some genera (*Oryza*, most *Bambuseae*) another row of three stamens, making six in all (fig. 13, 3); and *Anomochloa* and *Tetrarrhena* possess four. The stamens become numerous (ten to forty) in the male flowers of a few monoecious genera (*Pariana*, *Lusiola*). In *Ochlandra* they vary from seven to thirty, and in *Gigantochloa* they are monadelphous.

Gynoecium.—The pistil consists of a single carpel, opposite the pale in the median plane of the spikelet. The ovary is small, rounded to elliptical, and one-celled, and contains a single slightly bent ovule sessile on the ventral suture (that is, springing from the back of the ovary); the micropyle points downwards. It bears usually two lateral styles which are quite distinct or connate at the base, sometimes for a greater length (fig. 14, 1), each ends in a densely hairy or feathery stigma (fig. 14). Occasionally there is but a single style, as in *Nardus* (fig. 14, 7), which corresponds to the midrib of the carpel. The very long and apparently simple stigma of maize arises from the union of two. Many of the bamboos have a third, anterior, style.

Comparing the flower of Gramineae with the general monocotyledonous plan as represented by Liliaceae and other families (fig. 15), it will be seen to differ in the absence of the outer row and

the posterior member of the inner row of the perianth-leaves, of the whole inner row of stamens, and of the two lateral carpels,

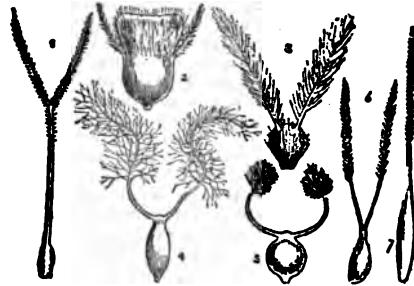

FIG. 14.—Pistils of Grasses (much enlarged). 1, *Alopecurus*; 2, *Bromus*; 3, *Arrhenatherum*; 4, *Glyceria*; 5, *Melica*; 6, *Mibora*; 7, *Nardus*.

whilst the remaining members of the perianth are in a rudimentary condition. But each or any of the usually missing organs are to be found normally in different genera, or as occasional developments.

Pollination.—Grasses are generally wind-pollinated, though self-fertilization sometimes occurs. A few species, as we have seen, are monoecious or dioecious, while many are polygamous (having unisexual as well as bisexual flowers

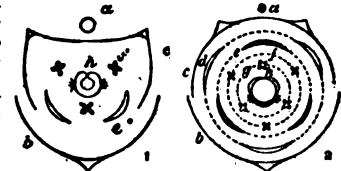

FIG. 15.—Diagrams of the ordinary Grass-flower.

1, Actual condition; 2, Theoretical, with the suppressed organs supplied. a, Axis. b, Flowering glume. c, Palea. d, Outer row of perianth leaves. e, Inner row. f, Outer row of stamens. g, Inner row. h, Pistil.

as in many members of the tribes *Andropogoneae*, fig. 18, and *Panicaceae*), and in these the male flower of a spikelet always blooms later than the hermaphrodite, so that its pollen can only effect cross-fertilization upon other spikelets in the same or another plant. Of those with only bisexual flowers, many are strongly protogynous (the stigmas protruding before the anthers are ripe), such as *Alopecurus* and *Anthoxanthum* (fig. 7), but generally the anthers protrude first and discharge the greater part of their pollen before the stigmas appear. The filaments elongate rapidly at flowering-time, and the lightly versatile anthers empty an abundance of finely granular smooth pollen through a longitudinal slit. Some flowers, such as rye, have lost the power of effective self-fertilization, but in most cases both forms, self- and cross-fertilization, seem to be possible. Thus the species of wheat are usually self-fertilized, but cross-fertilization is possible since the glumes are open above, the stigmas project laterally, and the anthers empty only about one-third of their pollen in their own flower and the rest into the air. In some cultivated races of barley, cross-fertilization is precluded, as the flowers never open. Reference has already been made to cleistogamic species which occur in several genera.

Fruit and Seed.—The ovary ripens into a usually small ovoid or rounded fruit, which is entirely occupied by the single large seed, from which it is not to be distinguished, the thin pericarp being completely united to its surface. To this peculiar fruit the term *caryopsis* has been applied (more familiarly "grain"); it is commonly furrowed longitudinally down one side (usually the inner, but in *Coix* and its allies, the outer), and an additional covering is not unfrequently provided by the adherence of the persistent palea, or even also of the flowering

glume ("chaff" of cereals). From this type are a few deviations; thus in *Sporobolus*, &c. (fig. 16), the pericarp is not united with the seed but is quite distinct, dehisces, and allows the loose seed to escape. Sometimes the pericarp is membranous, sometimes hard, forming a nut, as in some genera of *Bambuseae*, while in other *Bambuseae* it becomes thick and fleshy, forming a berry often as large as an apple. In *Melocanna* the berry forms an edible fruit 3 or 4 in. long, with a pointed beak of 2 in. more; it is indehiscent, and the small seed germinates whilst the fruit is still attached to the tree, putting out a tuft of roots and a shoot, and not falling till the latter is 6 in. long. The position of the embryo is plainly visible on the front side at the base of the grain. On the other, posterior, side of the grain is a more or less evident, sometimes punctiform, sometimes elongated or linear mark, the hilum, the place where the ovule was fastened to the wall of the ovary. The form of the hilum is constant throughout a genus, and sometimes also in whole tribes.



FIG. 16.—Fruit of *Sporobolus*, showing the dehiscent pericarp and seed.

The testa is thin and membranous but occasionally coloured, and the embryo small, the great bulk of the seed being occupied by the hard farinaceous endosperm (albumen) on which the nutritive value of the grain depends. The outermost layer of endosperm, the aleuron-layer, consists of regular cells filled with small proteid granules; the rest is made up of large polygonal cells containing numerous starch-grains in a matrix of proteid which may be continuous (horny endosperm) or granular (mealy endosperm). The embryo presents many points of interest. Its position is remarkable, closely applied to the surface of the endosperm at the base of its outer side. This character is absolute for the whole order, and effectually separates Gramineae from Cyperaceae. The part in contact with the endosperm is plate-like, and is known as the *scutellum*; the surface in contact with the endosperm forms an absorptive epithelium. In some grasses there is a small scale-like appendage opposite the scutellum, the *epiblast*. There is some difference of opinion as to which structure or structures represent the cotyledon. Three must be considered: (1) the scutellum, connected by vascular tissue with the vascular cylinder of the main axis of the embryo which it more or less envelops; it never leaves the seed, serving merely to prepare and absorb the food-stuff in the endosperm; (2) the cellular outgrowth of the axis, the epiblast, small and inconspicuous as in wheat, or larger as in *Stipa*; (3) the pileole or germ-sheath, arising on the same side of the axis and above the scutellum, enveloping the plumule in the seed and appearing above ground as a generally colourless sheath from the apex of which the plumule ultimately breaks (fig. 17, 4, b). The development of these structures (which was investigated by van Tieghem),

developing numerous hairs. The radicle then breaks through the coleorhiza, as do also the secondary rootlets where, as in the case of many cereals, these have been formed in the embryo (fig. 17, 4). The germ-sheath grows vertically upwards, its stiff apex pushing through the soil, while the plumule is hidden in its hollow interior. Finally the plumule escapes, its leaves successively breaking through at the tip of the germ-sheath. The scutellum meanwhile feeds the developing embryo from the endosperm. The growth of the primary root is limited; sooner or later adventitious roots develop from the axis above the radicle which they ultimately exceed in growth.

Means of Distribution.—Various methods of scattering the grain have been adopted, in which parts of the spikelet or inflorescence are concerned. Short spikes may fall from the culm as a whole; or the axis of a spike or raceme is jointed so that one spikelet falls with each joint as in many *Andropogoneae* and *Hordeae*. In many-flowered spikelets the rachilla is often jointed and breaks into as many pieces as there are fruits, each piece bearing a glume and pale. One-flowered spikelets may fall as a whole (as in the tribes *Panicaceae* and *Andropogoneae*), or the axis is jointed above the barren glumes so that only the flowering glume and pale fall with the fruit. These arrangements are, with few exceptions, lacking in cultivated cereals though present in their wild forms, so far as these are known. Such arrangements are disadvantageous for the complete gathering of the fruit, and therefore varieties in which they are not present would be preferred for cultivation. The persistent bracts (glume and pale) afford an additional protection to the fruit; they protect the embryo, which is near the surface, from too rapid wetting and, when once soaked, from drying up again. They also decrease the specific gravity, so that the grain is more readily carried by the wind, especially when, as in *Bria*, the glume has a large surface compared with the size of the grain, or when, as in *Holcus*, empty glumes also take part; in Canary grass (*Phalaris*) the large empty glumes bear a membranous wing on the keel. In the sugar-cane (*Saccharum*) and several allied genera the separating joints of the axis bear long hairs below the spikelets; in others, as in *Arundo* (a reed-grass), the flowering glumes are enveloped in long hairs. The awn which is frequently borne on the flowering glume is also a very efficient means of distribution, catching into fur of animals or plumage of birds, or as often in *Stipa* (fig. 8) forming a long feather for wind-carriage. In *Tragus* the glumes bear numerous short hooked bristles. The fleshy berries of some *Bambuseae* favour distribution by animals.

The awn is also of use in burying the fruit in the soil. Thus in *Stipa*, species of *Avena*, *Heteropogon* and others the base of the glume forms a sharp point which will easily penetrate the ground; above the point are short stiff upwardly pointing hairs which oppose its withdrawal. The long awn, which is bent and closely twisted below the bend, acts as a driving organ; it is very hygroscopic, the coils untwisting when damp and twisting up when dry. The repeated twisting and untwisting, especially when the upper part of the awn has become fixed in the earth or caught in surrounding vegetation, drives the point deeper and deeper into the ground. Such grasses often cause harm to sheep by catching in the wool and boring through the skin.

A peculiar method of distribution occurs in some alpine and arctic grasses, which grow under conditions where ripening of the fruit is often uncertain. The entire spikelet, or single flowers, are transformed into small-leaved shoots which fall from the axes and readily root in the ground. Some species, such as *Poa stricta*, are known only in this viviparous condition; others, like our British species *Festuca ovina* and *Poa alpina*, become viviparous under the special climatic conditions.

II. CLASSIFICATION.—Gramineae are sharply defined from all other plants, and there are no genera as to which it is possible to feel a doubt whether they should be referred to it or not. The only family closely allied is Cyperaceae, and the points of difference between the two may be here brought together. The



FIG. 17.—A Grain of Wheat. 1, back, and 2, front view; 3, vertical section, showing (b) the endosperm, and (a) embryo; 4, beginning of germination, showing (b) the pileole and (c) the radicle and secondary rootlets surrounded by their coleorhizae.

especially in relation to the origin of the vascular bundles which supply them, favours the view that the scutellum and pileole are highly differentiated parts of a single cotyledon, and this view is in accord with a comparative study of the seedling of grasses and of other monocotyledons. The epiblast has been regarded as representing a second cotyledon, but this is a very doubtful interpretation.

Germination.—In germination the coleorhiza lengthens, ruptures the pericarp, and fixes the grain to the ground by

but distinctions are found in the position of the embryo in relation to the endosperm—lateral in grasses, basal in Cyperaceae—and in the possession by Gramineae of the 2-nerved palea below each flower. Less absolute characters, but generally trustworthy and more easily observed, are the feathery stigmas, the always distichous arrangement of the glumes, the usual absence of more general bracts in the inflorescence, the split leaf-sheaths, and the hollow, cylindrical, jointed culms—some or all of which are wanting in all Cyperaceae. The same characters will distinguish grasses from the other glumiferous orders, Restiaceae, and Eriocaulonaceae, which are besides further removed by their capsular fruit and pendulous ovules. To other monocotyledonous families the resemblances are merely of adaptive or vegetative characters. Some Commelinaceae and Marantaceae approach grasses in foliage; the leaves of *Allium*, &c., possess a ligule; the habit of some palms reminds one of the bamboos; and Juncaceae and a few Liliaceae possess an inconspicuous scarious perianth. There are about 300 genera containing about 3500 well-defined species.

The great uniformity among the very numerous species of this vast family renders its classification very difficult. The difficulty has been increased by the confusion resulting from the multiplication of genera founded on slight characters, and from the description (in consequence of their wide distribution) of identical plants under several different genera.

No characters for main divisions can be obtained from the flower proper or fruit (with the exception of the character of the hilum), and it has therefore been found necessary to trust to characters derived from the usually less important inflorescence and bracts.

Robert Brown suggested two primary divisions—Paniceae and Poaceae, according to the position of the most perfect flower in the spikelet; this is the upper (apparently) terminal one in the first, whilst in the second it occupies the lower position, the more imperfect ones (if any) being above it. Munro supplemented this by another character easier of verification, and of even greater constancy, in the articulation of the pedicel in the Paniceae immediately below the glumes; whilst in Poaceae this does not occur, but the axis of the spikelet frequently articulates above the pair of empty basal glumes. Neither of these great divisions will well accommodate certain genera allied to *Phalaris*, for which Brown proposed tentatively a third group (since named *Phalarideae*); this, or at least the greater part of it, is placed by Bentham under the Poaceae.

The following arrangement has been proposed by Professor Eduard Hackel in his recent monograph on the order.

A. Spikelets one-flowered, rarely two-flowered as in *Zea*, falling from the pedicel entire or with certain joints of the rachis at maturity, rachilla not produced beyond the flowers.

a. Hilum a point; spikelets not laterally compressed.

1. Fertile glume and pale hyaline; empty glumes thick, membranous to coriaceous or cartilaginous, the lowest the largest. Rachis generally jointed and breaking up when mature.

1. Spikelets unisexual, male and female in separate inflorescences or on different parts of the same inflorescence. 1. *Maydeae*.

2. Spikelets bisexual, or male and bisexual, each male standing close to a bisexual. 2. *Andropogoneae*.

β. Fertile glume and pale cartilaginous, coriaceous or papery; empty glumes more delicate, usually herbaceous, the lowest usually smallest. Spikelets falling singly from the unjointed rachis of the spike or the ultimate branches of the panicle. 3. *Panicaceae*.

β. Hilum a line; spikelets laterally compressed.

4. *Oryzaceae*.

B. Spikelets one- to indefinite-flowered; in the one-flowered the rachilla frequently produced beyond the flower; rachilla generally jointed above the empty glumes, which remain after the fruiting glumes have fallen. When more than one-flowered, distinct internodes are developed between the flowers.

a. Culm herbaceous, annual; leaf-blade sessile, and not jointed to the sheath.

α. Spikelets upon distinct pedicels and arranged in panicles or racemes.

I. Spikelets one-flowered.

i. Empty glumes 4.

ii. Empty glumes 2.

5. *Phalarideae*.

6. *Agrostideae*.

II. Spikelets more than one-flowered.

i. Fertile glumes generally shorter than the empty glumes, usually with a bent awn on the back.

7. *Aveneae*.

ii. Fertile glumes generally longer than the empty, un-awned or with a straight, terminal awn.

9. *Festuceae*.

β. Spikelets crowded in two close rows, forming a one-sided spike or raceme with a continuous (not jointed) rachis.

8. *Chlorideae*.

γ. Spikelets in two opposite rows forming an equal-sided spike.

10. *Hordeae*.

δ. Culm woody, at any rate at the base, leaf-blade jointed to the sheath, often with a short, slender petiole.

11. *Bambusaceae*.

Tribe 1. *Maydeae* (7 genera in the warmer parts of the earth). *Zea Mays* (maize, *q.v.*, or Indian corn) (*q.v.*). *Tripsacum*, 2 or 3 species in subtropical America north of the equator; *Tr. dactyloides* (gama grass) extends northwards to Illinois and Connecticut; it is used for fodder, and as an ornamental plant. *Coix Lacryma-Jobi* (Job's tears) *q.v.*

Tribe 2. *Andropogoneae* (25 genera, mainly tropical). The spikelets are arranged in spike-like racemes, generally in pairs consisting of a sessile and stalked spikelet at each joint of the rachis (fig. 18). Many are savanna grasses, in various parts of the tropics, for instance the large genus *Andropogon*, *Elyonurus* and others. *Saccharum officinarum* (sugar-cane) (*q.v.*). *Sorghum*, an important tropical cereal known as black millet or *durra* (*q.v.*). *Miscanthus* and *Eriocaulon*, nearly allied to *Saccharum*, are tall reed-like grasses, with large silky flower-panicles, which are grown for ornament. *Imperata*, another ally, is a widespread tropical genus; one species *I. arundinacea* is the principal grass of the along-along fields in the Malay Archipelago; it is used for thatch. *Vossia*, an aquatic grass, often floating, is found in western India and tropical Africa. In the swampy lands of the upper Nile it forms, along with a species of *Saccharum*, huge floating grass barriers. *Elyonurus*, a wide-spread savanna grass in tropical and subtropical America, and also in the tropics of the old world, is rejected by cattle probably on account of its aromatic character, the spikelets having a strong balsam-like smell. Other aromatic members are *Andropogon Nardus*, a native of India, but also cultivated, the rhizome, leaves and especially the spikelets of which contain a volatile oil, which on distillation yields the citronella oil of commerce. A closely allied species, *A. Schoenanthus* (lemon-grass), yields lemon-grass oil; a variety is used by the negroes in western Africa for haemorrhage. Other species of *pogon*, the same genus are used as stimulants and cosmetics in various parts of the tropics. The species of *Heteropogon*, a cosmopolitan genus in the warmer parts of the world, have strongly awned spikelets. *Themeda Forstalis*, which occurs from the Mediterranean region to South Africa and Tasmania, is the kangaroo grass of Australia, where, as in South Africa, it often covers wide tracts.

Tribe 3. *Panicaceae* (about 25 genera, tropical to subtropical; a few temperate), a second flower, generally male, rarely hermaphrodite, is often present below the fertile flower. *Paspalum*, is a large tropical genus, most abundant in America, especially on the pampas and campos; many species are good forage plants, and the grain is sometimes used for food. *Amphicarpum*, native in the south-eastern United States, has fertile cleistogamous spikelets on filiform runners at the base of the culm, those on the terminal panicle are sterile. *Panicum*, a very polymorphic genus, and one of the largest in the order, is widely spread in all warm countries; together with species of *Paspalum* they form good forage grasses in the South American savannas and campos. *Panicum Crus-galli* is a polymorphic cosmopolitan grass, which is often grown for fodder; in one form (*P. frumentaceum*) it is cultivated in India for its grain. *P. plicatum*, with broad folded leaves, is an ornamental greenhouse grass. *P. miliaceum* is millet (*q.v.*), and *P. altissimum*, Guinea grass. In the closely allied genus *Digitaria*, which is sometimes regarded as a section of *Panicum*, the lowest barren glume is reduced to a point; *D. sanguinalis* is a very widespread grass, in Bohemia it is cultivated as a food-grain; it is also the crab-grass of the southern United States, where it is used for fodder.

In *Setaria* and allied genera the spikelet is subtended by an involucre of bristles or spines which represent sterile branches of the inflorescence. *Setaria Italica*, Hungarian grass, is extensively grown as a food-grain both in China and Japan, parts of India and western Asia, as well as in Europe, where its culture dates from prehistoric times; it is found in considerable quantity in the lake dwellings of the Stone age.

In *Cenchrus* the bristles unite to form a tough spiny capsule



FIG. 18.—A pair of spikelets of *Andropogon*.

fig. 12); *C. tribuloides* (burr-grass) and other species are troublesome weeds in North and South America, as the involucre clings to the wool of sheep and is removed with great difficulty. *Pennisetum typhoides* is widely cultivated as a grain in tropical Africa. *Spinifex*, a dioecious grass, is widespread on the coasts of Australia and eastern Asia, forming an important sand-blinder. The female heads are spinose with long pungent bracts, fall entire when ripe and are carried away by wind or sea, becoming finally anchored in the sand and falling to pieces.

Tribe 4. *Oryzeae* (16 genera, mainly tropical and subtropical). The spikelets are sometimes unisexual, and there are often six stamens. *Leersia* is a genus of swamp grasses, one of which *L. oryzoides* occurs in the north temperate zone of both old and new worlds, and is a rare grass in Surrey, Sussex and Hampshire. *Zizania aquatica* (Tuscarora or Indian rice) is a reed-like grass growing over large areas on banks of streams and lakes in North America and north-east Asia. The Indians collect the grain for food. *Oryza sativa* (rice) (*q.v.*). *Lygum Spartum*, with a creeping stem and stiff rush-like leaves, is common on rocky soil on the high plains bordering the western Mediterranean, and is one of the sources of esparto.



FIG. 19.—*Phalaris*. Spikelet of *Hierochloa*.

presence of coumarin, which is also present in the closely allied genus *Hierochloa* (fig. 19), which occurs throughout the temperate and frigid zones.

Tribe 6. *Agrostideae* (about 35 genera, occurring in all parts of the world; eleven are British). *Aristida* and *Stipa* are large and widely distributed genera, occurring especially on open plains and steppes; the conspicuously awned persistent flowering glume forms an efficient means of dispersing the grain. *Stipa pennata* is a characteristic species of the Russian steppes. *St. spartea* (porcupine grass) and other species are plentiful on the North American prairies. *St. tenacissima* is the Spanish esparto grass (*q.v.*), known in North Africa as halfa or alfa. *Phleum* has a cylindrical spike-like inflorescence; *P. pratense* (timothy) is a valuable fodder grass, as also is *Alopecurus pratensis* (foxtail). *Sporobolus*, a large genus in the warmer parts of both hemispheres, but chiefly America, derives its name from the fact that the seed is ultimately expelled from the fruit. *Agrostis* is a large world-wide genus, but especially developed in the north temperate zone, where it includes important meadow-grasses. *Calamagrostis* and *Deuyxia* are tall, often reed-like grasses, occurring throughout the temperate and arctic zones and upon high mountains in the tropics. *Ammophila arundinacea* (or *Psamma arenaria*) (Marram grass) with its long creeping stems forms a useful sand-binder on the coasts of Europe, North Africa and the Atlantic states of America.

Tribe 7. *Aveneae* (about 24 genera, seven of which are British). *Holcus lanatus* (Yorkshire fog; soft grass) is a common meadow and wayside grass with woolly or downy leaves. *Aira* is a genus of delicate annuals with slender hair-like branches of the panicle. *Deschampsia* and *Trisetum* occur in temperate and cold regions or on high mountains in the tropics; *T. pratense* (*Avena flavescens*) with a loose panicle and yellow shining spikelets is a valuable fodder-grass. *Avena fatua* is the wild oat and *A. sativa* the cultivated oat (*q.v.*). *Arrhenatherum avenaceum*, a perennial field grass, native in Britain and central and southern Europe, is cultivated in North America.

Tribe 8. *Chlorideae* (about 30 genera, chiefly in warm countries). The only British representative is *Cynodon Dactylon* (dog's tooth, Bermuda grass) found on sandy shores in the south-west of England; it is a cosmopolitan, covering the ground in sandy soils, and forming an important forage grass in many dry climates (Bermuda grass of the southern United States, and known as durba, dub and other names in India). Species of *Chloris* are grown as ornamental grasses. *Bouteloua* with numerous species (mesquite grass, grama grass) on the plains of the south-western United States, afford good grazing. *Elymus indica* is a common tropical weed; the nearly allied species *E. Coracana* is a cultivated grain in the warmer parts of Asia and throughout Africa. *Buchloe dactyloides* is the buffalo grass of the North American prairies, a valuable fodder.

Tribe 9. *Festuceae* (about 83 genera, including tropical, temperate, arctic and alpine forms) many are important meadow-grasses; 15 are British. *Glycerium argenteum* (pampas grass) is a native of southern Brazil and Argentina. *Arundo* and *Phragmites* are tall reed-grasses (see REED). Several species of *Triodia* cover large areas of the interior of Australia, and from their stiff, sharply-pointed leaves

are very troublesome. *Eragrostis*, one of the larger genera of the order, is widely distributed in the warmer parts of the earth; many species are grown for ornament and *E. abyssinica* is an important food-plant in Abyssinia.

Koeleria cristata is a fodder-grass. *Brisa media* (quaking grass) is a useful meadow-grass. *Dactylis glomerata* (cock's-foot), a perennial grass with a dense panicle, common in pastures and waste places is a useful meadow-grass. It has become naturalized in North America, where it is known as orchard grass, as it will grow in shade. *Cynosurus cristatus* (dog's tail) is a common pasture-grass. *Poa*, a large genus widely distributed in temperate and cold countries, includes many meadow and alpine grasses; eight species are British; *P. annua* (fig. 20) is the very common weed in paths and waste places; *P. pratensis* and *P. trivialis* are also common grasses of meadows, banks and pastures, the former is the "June grass" or "Kentucky blue grass" of North America; *P. alpina* is a mountain grass of the northern hemisphere and found also in the Arctic region. The largest species of the genus is *Poa flabellata* which forms great tufts 6-7 ft. high with leaves arranged like a fan; it is a native of the Falkland and certain antarctic islands where it is known as tussock grass. *Glyceria fluitans*, manna-grass, so-called from the sweet grain, is one of the best fodder grasses for swampy meadows; the grain is an article of food in central Europe. *Festuca* (fescue) is also a large and widely distributed genus, but found especially in the temperate and cold zones; it includes valuable pasture grasses, such as *F. ovina* (sheep's fescue), *F. rubra*; nine species are British. The closely allied genus *Bromus* (brome grass) is also widely distributed but most abundant in the north temperate zone; *B. erectus* is a useful forage grass on dry chalky soil.

Tribe 10. *Hordeae* (about 19 genera, widely distributed; six are British). *Nardus stricta* (mat-weed), found on heaths and dry pastures, is a small perennial with slender rigid stem and leaves, it is a useless grass, crowding out better sorts. *Lolium perenne*, ray- (or by corruption rye-) grass, is common in waste places and a valuable pasture-grass; *L. italicum* is the Italian ray-grass; *L. temulentum* (darnel) contains a narcotic principle in the grain. *Secale cereale*, rye (*q.v.*), is cultivated mainly in northern Europe. *Agropyrum repens* (couch grass) has a long creeping underground stem, and is a troublesome weed in cultivated land; the widely creeping stem of *A. junceum*, found on sandy sea-shores, renders it a useful sand-binder. *Triticum sativum* is wheat (*q.v.*) (fig. 21), and *Hordeum sativum*, barley (*q.v.*). *H. murinum*, wild barley, is a common grass in waste places. *Elymus arenarius* (lyme grass) occurs on sandy sea-shores in the north temperate zone and is a useful sand-binder.

Tribe 11. *Bambuseae*. Contains 23 genera, mainly tropical. See BAMBOO.

III. DISTRIBUTION.—Grasses are the most universally diffused of all flowering plants. There is no district in which they do not occur, and in nearly all they are a leading feature of the flora. In number of species Gramineae comes considerably after Compositae and



FIG. 20.—*Poa annua*. Plant in Flower; about $\frac{1}{2}$ nat. size. 1, one spikelet.



FIG. 21.—Spike of Wheat (*Triticum sativum*). About $\frac{1}{2}$ nat. size.

Leguminosae, the two most numerous orders of phanerogams, but in number of individual plants it probably far exceeds either; whilst from the wide extension of many of its species, the proportion of Gramineae to other orders in the various floras of the world is much higher than its number of species would lead one to expect. In tropical regions, where Leguminosae is the leading order, grasses closely follow as the second, whilst in the warm and temperate regions of the northern hemisphere, in which Compositae takes the lead, Gramineae again occupies the second position.

While the greatest number of species is found in the tropical zone, the number of individuals is greater in the temperate zones, where they form extended areas of turf. Turf- or meadow-formation depends upon uniform rainfall. Grasses also characterize steppes and savannas, where they form scattered tufts. The bamboos are a feature of tropical forest vegetation, especially in the monsoon region. As the colder latitudes are entered the grasses become relatively more numerous, and are the leading family in Arctic and Antarctic regions. The only countries where the order plays a distinctly subordinate part are some extra-tropical regions of the southern hemisphere, Australia, the Cape, Chili, &c. The proportion of graminaceous species to the whole phanerogamic flora in different countries is found to vary from nearly $\frac{1}{4}$ th in the Arctic regions to about $\frac{1}{10}$ th at the Cape; in the British Isles it is about $\frac{1}{10}$ th.

The principal climatic cause influencing the number of graminaceous species appears to be amount of moisture. A remarkable feature of the distribution of grasses is its uniformity; there are no great centres for the order, as in Compositae, where a marked preponderance of endemic species exists; and the genera, except some of the smallest or monotypic ones, have usually a wide distribution.

The distribution of the tropical tribe *Bambuseae* is interesting. The species are about equally divided between the Indo-Malayan region and tropical America, only one species being common to both. The tribe is very poorly represented in tropical Africa; one species *Oxytenanthera abyssinica* has a wide range, and three monotypic genera are endemic in western tropical Africa. None is recorded for Australia, though species may perhaps occur on the northern coast. One species of *Arundinaria* reaches northwards as far as Virginia, and the elevation attained in the Andes by some species of *Chusquea* is very remarkable,—one, *C. aristata*, being abundant from 15,000 ft. up to nearly the level of perpetual snow.

Many grasses are almost cosmopolitan, such as the common reed, *Phragmites communis*; and many range throughout the warm regions of the globe, e.g. *Cynodon Dactylon*, *Elysiue indica*, *Imperata arundinacea*, *Sporobolus indicus*, &c., and such weeds of cultivation as species of *Setaria*, *Echinochloa*. Several species of the north temperate zone, such as *Poa nemoralis*, *P. pratensis*, *Festuca ovina*, *F. rubra* and others, are absent in the tropics but reappear in the antarctic regions; others (e.g. *Phleum alpinum*) appear in isolated positions on high mountains in the intervening tropics. No tribe is confined to one hemisphere and no large genus to any one floral region; facts which indicate that the separation of the tribes goes back to very ancient times. The revision of the Australian species by Bentham well exhibits the wide range of the genera of the order in a flora generally so peculiar and restricted as that of Australia. Thus of the 90 indigenous genera (many monotypic or very small) only 14 are endemic, 1 extends to South Africa, 3 are common to Australia and New Zealand, 18 extend also into Asia, whilst no fewer than 54 are found in both the Old and New Worlds, 26 being chiefly tropical and 28 chiefly extra-tropical.

Of specially remarkable species *Lygeum* is found on the sea-sand of the eastern half of the Mediterranean basin, and the minute *Coleanthis* occurs in three or four isolated spots in Europe (Norway, Bohemia, Austria, Normandy), in North-east Asia (Amur) and on the Pacific coast of North America (Oregon, Washington). Many remarkable endemic genera occur in tropical America, including *Anomochloa* of Brazil, and most of the large aquatic species with separated sexes are found in this

region. The only genus of flowering plants peculiar to the arctic regions is the beautiful and rare grass *Pleurapogon Sabini*, of Melville Island.

Fossil Grasses.—While numerous remains of grass-like leaves are a proof that grasses were widespread and abundantly developed in past geological ages, especially in the Tertiary period, the fossil remains are in most cases too fragmentary and badly preserved for the determination of genera, and conclusions based thereon in explanation of existing geographical distribution are most unsatisfactory. There is, however, justification for referring some specimens to *Arundo*, *Phragmites*, and to the *Bambuseae*.

BIBLIOGRAPHY.—E. Hackel, *The True Grasses* (translated from Engler and Prantl, *Die natürlichen Pflanzenfamilien*, by F. Lamson Scribner and E. A. Southworth); and *Andropogoneae* in de Candolle's *Monographiae phanerogamarum* (Paris, 1839); K. S. Kunth, *Monographiae graminides* (Paris, 1829–1835) and *Agrostographia* (Stuttgart, 1833); J. C. Dollin Martius and Eichler, *Flora Brasiliensis*, ii. Pra. II. and III. (Munich, 1871–1883); A. W. Eichler, *Blüthen-diagramme* i. 119 (Leipzig, 1875); Bentham and Hooker, *Genera plantarum*, iii. 1074 (London, 1883); H. Baillon, *Histoire des plantes*, xii. 136 (Paris, 1893); J. S. Gamble, "Bambuseae of British India" in *Annals Royal Botanic Gardens, Calcutta*, vii. (1896); John Percival, *Agricultural Botany* (chapters on "Grasses," 2nd ed., London, 1902). See also accounts of the family in the various great floras, such as Ascherson and Graebner, *Synopsis der mitteleuropäischen Flora*; N. L. Britton and A. Brown, *Illustrated Flora of the Northern United States and Canada* (New York, 1896); Hooker's *Flora of British India*; *Flora Capensis* (edited by W. Thielson-Dyer); Boissier, *Flora orientalis*, &c. &c.

GRASSHOPPER (Fr. *sauterelle*, Ital. *grillò*, Ger. *Grashüpfer*, *Heuschrecke*, Swed. *Gräshoppa*), names applied to orthopterous insects belonging to the families *Locustidae* and *Acrididae*. They are especially remarkable for their saltatory powers, due to the great development of the hind legs, which are much longer than the others and have stout and powerful thighs, and also for their stridulation, which is not always an attribute of the male only. The distinctions between the two families may be briefly stated as follows:—The *Locustidae* have very long thread-like antennae, four-jointed tarsi, a long ovipositor, the auditory organs on the tibiae of the first leg and the stridulatory organ in the wings; the *Acrididae* have short stout antennae, three-jointed tarsi, a short ovipositor, the auditory organs on the first abdominal segment, and the stridulatory organ between the posterior leg and the wing. The term "grasshopper" is almost synonymous with *Locust* (g.v.). Under both "grasshopper" and "locust" are included members of both families above noticed, but the majority belong to the *Acrididae* in both cases. In Britain the term is chiefly applicable to the large green grasshopper (*Locusta* or *Phasgonura viridissima*) common in most parts of the south of England, and to smaller and much better-known species of the genera *Stenobothrus*, *Gomphoceris* and *Tettix*, the latter remarkable for the great extension of the pronotum, which often reaches beyond the extremity of the body. All are vegetable feeders, and, as in all orthopterous insects, have an incomplete metamorphosis, so that their destructive powers are continuous from the moment of emergence from the egg till death. The migratory locust (*Pachytylus cinerascens*) may be considered only an exaggerated grasshopper, and the Rocky Mountain locust (*Caloptenus spretus*) is still more entitled to the name. In Britain the species are not of sufficient size, nor of sufficient numerical importance, to do any great damage. The colours of many of them assimilate greatly to those of their habitats; the green of the *Locusta viridissima* is wonderfully similar to that of the herbage amongst which it lives, and those species that frequent more arid spots are protected in the same manner. Yet many species have brilliantly coloured under-wings (though scarcely so in English forms), and during flight are almost as conspicuous as butterflies. Those that belong to the *Acrididae* mostly lay their eggs in more or less cylindrical masses, surrounded by a glutinous secretion, in the ground. Some of the *Locustidae* also lay their eggs in the ground, but others deposit them in fissures in trees and low plants, in which the female is aided by a long flattened ovipositor, or process at the extremity of the abdomen, whereas in the *Acrididae* there is only an

apparatus of valves. The stridulation or "song" in the latter is produced by friction of the hind legs against portions of the wings or wing-covers. To a practised ear it is perhaps possible to distinguish the "song" of even closely allied species, and some are said to produce a sound differing by day and night.

GRASS OF PARNASSUS, in botany, a small herbaceous plant known as *Parnassia palustris* (natural order *Saxifragaceae*), found on wet moors and bogs in Britain but less common in the south. The white regular flower is rendered very attractive



Grass of Parnassus (*Parnassia palustris*). 1, one of the gland-bearing scales enlarged.

by a circlet of scales, opposite the petals, each of which bears a fringe of delicate filaments ending in a yellow knob. These glisten in the sunshine and look like a drop of honey. Honey is secreted by the base of each of the scales.

GRATE (from Lat. *crates*, a hurdle), the iron or steel receptacle for a domestic fire. When coal replaced logs and irons were found to be unsuitable for burning the comparatively small lumps, and for this reason and on account of the more concentrated heat of coal it became necessary to confine the area of the fire. Thus a basket or cage came into use, which, as knowledge of the scientific principles of heating increased, was succeeded by the small grate of iron and fire-brick set close into the wall which has since been in ordinary use in England. In the early part of the 19th century polished steel grates were extensively used, but the labour and difficulty of keeping them bright were considerable, and they were gradually replaced by grates with a polished black surface which could be quickly renewed by an application of black-lead. The most frequent form of the 18th-century grate was rather high from the hearth, with a small hob on each side. The brothers Adam designed many exceedingly elegant grates in the shape of movable baskets ornamented with the paterae

and acanthus leaves, the swags and festoons characteristic of their manner. The modern dog-grate is a somewhat similar basket supported upon dogs or andirons, fixed or movable. In the closing years of the 19th century a "well-grate" was invented, in which the fire burns upon the hearth, combustion being aided by an air-chamber below.

GRATIAN (FLAVIUS GRATIANUS AUGUSTUS), Roman emperor 375-383, son of Valentinian I. by Severa, was born at Sirmium in Pannonia, on the 18th of April (or 23rd of May) 359. On the 24th of August 367 he received from his father the title of Augustus. On the death of Valentinian (17th of November 375) the troops in Pannonia proclaimed his infant son (by a second wife Justina) emperor under the title of Valentinian II. (q.v.). Gratian acquiesced in their choice; reserving for himself the administration of the Gallic provinces, he handed over Italy, Illyria and Africa to Valentinian and his mother, who fixed their residence at Milan. The division, however, was merely nominal, and the real authority remained in the hands of Gratian. The eastern portion of the empire was under the rule of his uncle Valens. In May 378 Gratian completely defeated the Lentienses, the southernmost branch of the Alamanni, at Argentaria, near the site of the modern Colmar. When Valens met his death fighting against the Goths near Adrianople on the 9th of August in the same year, the government of the eastern empire devolved upon Gratian, but feeling himself unable to resist unaided the incursions of the barbarians, he ceded it to Theodosius (January 379). With Theodosius he cleared the Balkans of barbarians. For some years Gratian governed the empire with energy and success, but gradually he sank into indolence, occupied himself chiefly with the pleasures of the chase, and became a tool in the hands of the Frankish general Merobaudes and bishop Ambrose. By taking into his personal service a body of Alani, and appearing in public in the dress of a Scythian warrior, he aroused the contempt and resentment of his Roman troops. A Roman named Maximus took advantage of this feeling to raise the standard of revolt in Britain and invaded Gaul with a large army, upon which Gratian, who was then in Paris, being deserted by his troops, fled to Lyons, where, through the treachery of the governor, he was delivered over to one of the rebel generals and assassinated on the 25th of August 383.

The reign of Gratian forms an important epoch in ecclesiastical history, since during that period orthodox Christianity for the first time became dominant throughout the empire. In dealing with pagans and heretics Gratian, who during his later years was greatly influenced by Ambrose, bishop of Milan, exhibited severity and injustice at variance with his usual character. He prohibited heathen worship at Rome; refused to wear the insignia of the pontifex maximus as unbecoming a Christian; removed the altar of Victory from the senate-house at Rome, in spite of the remonstrance of the pagan members of the senate, and confiscated its revenues; forbade legacies of real property to the Vestals; and abolished other privileges belonging to them and to the pontiffs. For his treatment of heretics see the church histories of the period.

AUTHORITIES.—Amianus Marcellinus xxvii.-xxxi.; Aurelius Victor, *Epit.* 47; Zosimus iv. vi.; Ausonius (Gratian's tutor), especially the *Gratianum actio pro consulatu*; Symmachus x. cxx. 2 and 61; Ambrose, *De fide, prolegomena to Epistolae* 11, 17, 21, *Consolatio de obitu Valentiniani*; H. Richter, *Das weströmische Reich, besonders unter den Kaisern Gratian, Valentinian II. und Maximus* (1865); A. de Broglie, *L'Église et l'empire romain au IV^e siècle* (4th ed., 1882); H. Schiller, *Geschichte der römischen Kaiserzeit*, iii., iv. 31-33; Gibbon, *Decline and Fall*, ch. 27; R. Gumpoltsberger, *Kaiser Gratian* (Vienna, 1879); T. Hodgkin, *Italy and her Invaders* (Oxford, 1892), vol. 1.; Tillemont, *Hist. des empereurs*, v.; J. Wordsworth in Smith's *Dictionary of Christian Biography*. (J. H. F.)

GRATIANUS, FRANCISCUS, compiler of the *Concordia discordantium canonum* or *Decretum Gratiani*, and founder of the science of canon law, was born about the end of the 11th century at Chiusi in Tuscany or, according to another account, at Carrara near Orvieto. In early life he appears to have been received into the Camaldulian monastery of Classe near Ravenna, whence he afterwards removed to that of San Felice in Bologna, where he spent many years in the preparation of the *Concordia*. The

precise date of this work cannot be ascertained, but it contains references to the decisions of the Lateran council of 1139, and there is fair authority for believing that it was completed while Pope Alexander III. was still simply professor of theology at Bologna,—in other words, prior to 1150. The labours of Gratian are said to have been rewarded with the bishopric of Chiusi, but if so he appears never to have been consecrated; at least his name is not in any authentic list of those who have occupied that see. The year of his death is unknown.

For some account of the *Decretum Gratiani* and its history see CANON LAW. The best edition is that of Friedberg (*Corpus juris canonici*, Leipzig, 1879). Compare Schultzæ, *Zur Geschichte der Litteratur über das Decret Gratiani* (1870), *Die Glosse zum Decret Gratiani* (1872), and *Geschichte der Quellen und Litteratur des kanonischen Rechts* (3 vols., Stuttgart, 1875).

GRATRY, AUGUSTE JOSEPH ALPHONSE (1805-1872), French author and theologian, was born at Lille on the 10th of March 1805. He was educated at the *École Polytechnique*, Paris, and, after a period of mental struggle which he has described in *Souvenirs de ma jeunesse*, he was ordained priest in 1832. After a stay at Strassburg as professor of the *Petit Séminaire*, he was appointed director of the *Collège Stanislas* in Paris in 1842 and, in 1847, chaplain of the *École Normale Supérieure*. He became vicar-general of Orleans in 1861, professor of ethics at the Sorbonne in 1862, and, on the death of Barante, a member of the French Academy in 1867, where he occupied the seat formerly held by Voltaire. Together with M. Pététot, curé of Saint Roch, he reconstituted the Oratory of the Immaculate Conception, a society of priests mainly devoted to education. Gratra was one of the principal opponents of the definition of the dogma of papal infallibility, but in this respect he submitted to the authority of the Vatican Council. He died at Montreux in Switzerland on the 6th of February 1872.

His chief works are: *De la connaissance de Dieu*, opposing Positivism (1855); *La Logique* (1856); *Les Sources, conseils pour la conduite de l'esprit* (1861-1862); *La Philosophie du credo* (1861); *Commentaire sur l'évangile de Saint Matthieu* (1863); *Jésus-Christ, lettres à M. Renan* (1864); *Les Sophistes et la critique* (in controversy with E. Vacherot) (1864); *La Morale et la loi de l'histoire*, setting forth his social views (1868); *Mgr. l'évêque d'Orléans et Mgr. l'archevêque de Malines* (1866), containing a clear exposition of the historical arguments against the doctrine of papal infallibility. There is a selection of Gratra's writings and appreciation of his style by the Abbé Pichot, in *Pages choisies des Grands Écrivains* series, published by Armand-Colin (1897). See also the critical study by the oratorian A. Chauvin, *L'Abbé Gratra* (1901); *Le Père Gratra* (1900), and *Les Derniers Jours du Père Gratra et son testament spirituel*, (1872), by Cardinal Adolphe Perraud, Gratra's friend and disciple.

GRATTAN, HENRY (1746-1820), Irish statesman, son of James Grattan, for many years recorder of Dublin, was born in Dublin on the 3rd of July 1746. He early gave evidence of exceptional gifts both of intellect and character. At Trinity College, Dublin, where he had a distinguished career, he began a lifelong devotion to classical literature and especially to the great orators of antiquity. He was called to the Irish bar in 1772, but never seriously practised the law. Like Flood, with whom he was on terms of friendship, he cultivated his natural genius for eloquence by study of good models, including Bolingbroke and Junius. A visit to the English House of Lords excited boundless admiration for Lord Chatham, of whose style of oratory Grattan contributed an interesting description to *Baratariana* (see FLOOD, HENRY). The influence of Flood did much to give direction to Grattan's political aims; and it was through no design on Grattan's part that when Lord Charlemont brought him into the Irish parliament in 1775, in the very session in which Flood damaged his popularity by accepting office, Grattan quickly superseded his friend in the leadership of the national party. Grattan was well qualified for it. His oratorical powers were unsurpassed among his contemporaries. He conspicuously lacked, indeed, the grace of gesture which he so much admired in Chatham; he had not the sustained dignity of Pitt; his powers of close reasoning were inferior to those of Fox and Flood. But his speeches were packed with epigram, and expressed with rare felicity of phrase; his terse and telling sentences were richer in profound aphorisms and maxims of political philosophy than those of any other statesman save

Burke; he possessed the orator's incomparable gift of conveying his own enthusiasm to his audience and convincing them of the loftiness of his aims.

The principal object of the national party was to set the Irish parliament free from constitutional bondage to the English privy council. By virtue of Poynning's Act, a celebrated statute of Henry VII., all proposed Irish legislation had to be submitted to the English privy council for its approval under the great seal of England before being passed by the Irish parliament. A bill so approved might be accepted or rejected, but not amended. More recent English acts had further emphasized the complete dependence of the Irish parliament, and the appellate jurisdiction of the Irish House of Lords had also been annulled. Moreover, the English Houses claimed and exercised the power to legislate directly for Ireland without even the nominal concurrence of the parliament in Dublin. This was the constitution which Molyneux and Swift had denounced, which Flood had attacked, and which Grattan was to destroy. The menacing attitude of the Volunteer Convention at Dungannon greatly influenced the decision of the government in 1782 to resist the agitation no longer. It was through ranks of volunteers drawn up outside the parliament house in Dublin that Grattan passed on the 16th of April 1782, amidst unparalleled popular enthusiasm, to move a declaration of the independence of the Irish parliament. "I found Ireland on her knees," Grattan exclaimed, "I watched over her with a paternal solicitude; I have traced her progress from injuries to arms, and from arms to liberty. Spirit of Swift, spirit of Molyneux, your genius has prevailed! Ireland is now a nation!" After a month of negotiation the claims of Ireland were conceded. The gratitude of his countrymen to Grattan found expression in a parliamentary grant of £100,000, which had to be reduced by one half before he would consent to accept it.

One of the first acts of "Grattan's parliament" was to prove its loyalty to England by passing a vote for the support of 20,000 sailors for the navy. Grattan himself never failed in loyalty to the crown and the English connexion. He was, however, anxious for moderate parliamentary reform, and, unlike Flood, he favoured Catholic emancipation. It was, indeed, evident that without reform the Irish House of Commons would not be able to make much use of its newly won independence. Though now free from constitutional control it was no less subject than before to the influence of corruption, which the English government had wielded through the Irish borough owners, known as the "undertakers," or more directly through the great executive officers. "Grattan's parliament" had no control over the Irish executive. The lord lieutenant and his chief secretary continued to be appointed by the English ministers; their tenure of office depended on the vicissitudes of English, not Irish, party politics; the royal prerogative was exercised in Ireland on the advice of English ministers. The House of Commons was in no sense representative of the Irish people. The great majority of the people were excluded as Roman Catholics from the franchise; two-thirds of the members of the House of Commons were returned by small boroughs at the absolute disposal of single patrons, whose support was bought by a lavish distribution of peerages and pensions. It was to give stability and true independence to the new constitution that Grattan pressed for reform. Having quarrelled with Flood over "simple repeal" Grattan also differed from him on the question of maintaining the Volunteer Convention. He opposed the policy of protective duties, but supported Pitt's famous commercial propositions in 1785 for establishing free trade between Great Britain and Ireland, which, however, had to be abandoned owing to the hostility of the English mercantile classes. In general Grattan supported the government for a time after 1782, and in particular spoke and voted for the stringent coercive legislation rendered necessary by the Whiteboy outrages in 1785; but as the years passed without Pitt's personal favour towards parliamentary reform bearing fruit in legislation, he gravitated towards the opposition, agitated for commutation of tithes in Ireland, and supported the Whigs

on the regency question in 1788. In 1792 he succeeded in carrying an Act conferring the franchise on the Roman Catholics; in 1794 in conjunction with William Ponsonby he introduced a reform Bill which was even less democratic than Flood's bill of 1783. He was as anxious as Flood had been to retain the legislative power in the hands of men of property, for "he had through the whole of his life a strong conviction that while Ireland could best be governed by Irish hands, democracy in Ireland would inevitably turn to plunder and anarchy."¹ At the same time he desired to admit the Roman Catholic gentry of property to membership of the House of Commons, a proposal that was the logical corollary of the Relief Act of 1792. The defeat of Grattan's mild proposals helped to promote more extreme opinions, which, under French revolutionary influence, were now becoming heard in Ireland.

The Catholic question had rapidly become of the first importance, and when a powerful section of the Whigs joined Pitt's ministry in 1794, and it became known that the lord-lieutenancy was to go to Lord Fitzwilliam, who shared Grattan's views, expectations were raised that the question was about to be settled in a manner satisfactory to the Irish Catholics. Such seems to have been Pitt's intention, though there has been much controversy as to how far Lord Fitzwilliam (q.v.) had been authorized to pledge the government. After taking Grattan into his confidence, it was arranged that the latter should bring in a Roman Catholic emancipation bill, and that it should then receive government support. But finally it appeared that the viceroy had either misunderstood or exceeded his instructions; and on the 19th of February 1795 Fitzwilliam was recalled. In the outburst of indignation, followed by increasing disaffection in Ireland, which this event produced, Grattan acted with conspicuous moderation and loyalty, which won for him warm acknowledgments from a member of the English cabinet.² That cabinet, however, doubtless influenced by the wishes of the king, was now determined firmly to resist the Catholic demands, with the result that the country rapidly drifted towards rebellion. Grattan warned the government in a series of masterly speeches of the lawless condition to which Ireland had been driven. But he could now count on no more than some forty followers in the House of Commons, and his words were unheeded. He retired from parliament in May 1797, and departed from his customary moderation by attacking the government in an inflammatory "Letter to the citizens of Dublin."

At this time religious animosity had almost died out in Ireland, and men of different faiths were ready to combine for common political objects. Thus the Presbyterians of the north, who were mainly republican in sentiment, combined with a section of the Roman Catholics to form the organization of the United Irishmen, to promote revolutionary ideas imported from France; and a party prepared to welcome a French invasion soon came into existence. Thus stimulated, the increasing disaffection culminated in the rebellion of 1798, which was sternly and cruelly repressed. No sooner was this effected than the project of a legislative union between the British and Irish parliaments, which had been from time to time discussed since the beginning of the 18th century, was taken up in earnest by Pitt's government. Grattan from the first denounced the scheme with implacable hostility. There was, however, much to be said in its favour. The constitution of Grattan's parliament offered no security, as the differences over the regency question had made evident that in matters of imperial interest the policy of the Irish parliament and that of Great Britain would be in agreement; and at a moment when England was engaged in a life and death struggle with France it was impossible for the ministry to ignore the danger, which had so recently been emphasized by the fact that the independent constitution of 1782 had offered no safeguard against armed revolt. The rebellion put an end to the growing reconciliation between Roman Catholics and Protestants; religious passions were now violently inflamed, and the Orangemen and Catholics divided the island into two hostile factions.

¹ W. E. H. Lecky, *Leaders of Public Opinion in Ireland*, I. 127 (enlarged edition, 2 vols., 1903).

² *Ibid.* I. 204.

It is a curious circumstance, in view of the subsequent history of Irish politics, that it was from the Protestant Established Church, and particularly from the Orangemen, that the bitterest opposition to the union proceeded; and that the proposal found support chiefly among the Roman Catholic clergy and especially the bishops, while in no part of Ireland was it received with more favour than in the city of Cork. This attitude of the Catholics was caused by Pitt's encouragement of the expectation that Catholic emancipation, the commutation of tithes, and the endowment of the Catholic priesthood, would accompany or quickly follow the passing of the measure.

When in 1799 the government brought forward their bill it was defeated in the Irish House of Commons. Grattan was still in retirement. His popularity had temporarily declined, and the fact that his proposals for parliamentary reform and Catholic emancipation had become the watchwords of the rebellious United Irishmen had brought upon him the bitter hostility of the governing classes. He was dismissed from the privy council; his portrait was removed from the hall of Trinity College; the Merchant Guild of Dublin struck his name off their rolls. But the threatened destruction of the constitution of 1782 quickly restored its author to his former place in the affections of the Irish people. The parliamentary recess had been effectually employed by the government in securing by lavish corruption a majority in favour of their policy. On the 15th of January 1800 the Irish parliament met for its last session; on the same day Grattan secured by purchase a seat for Wicklow; and at a late hour, while the debate was proceeding, he appeared to take his seat. "There was a moment's pause, an electric thrill passed through the House, and a long wild cheer burst from the galleries."³ Enfeebled by illness, Grattan's strength gave way when he rose to speak, and he obtained leave to address the House sitting. Nevertheless his speech was a superb effort of oratory; for more than two hours he kept his audience spellbound by a flood of epigram, of sustained reasoning, of eloquent appeal. After prolonged debates Grattan, on the 26th of May, spoke finally against the committal of the bill, ending with an impassioned peroration in which he declared, "I will remain anchored here with fidelity to the fortunes of my country, faithful to her freedom, faithful to her fall." These were the last words spoken by Grattan in the Irish parliament.

The bill establishing the union was carried through its final stages by substantial majorities. The people remained listless, giving no indications of any eager dislike of the government policy. "There were absolutely none of the signs which are invariably found when a nation struggles passionately against what it deems an impending tyranny, or rallies around some institution which it really loves."⁴ One of Grattan's main grounds of opposition to the union had been his dread of seeing the political leadership in Ireland pass out of the hands of the landed gentry; and he prophesied that the time would come when Ireland would send to the united parliament "a hundred of the greatest rascals in the kingdom."⁵ Like Flood before him, Grattan had no leaning towards democracy; and he anticipated that by the removal of the centre of political interest from Ireland the evil of absenteeism would be intensified.

For the next five years Grattan took no active part in public affairs; it was not till 1805 that he became a member of the parliament of the United Kingdom. He modestly took his seat on one of the back benches, till Fox brought him forward to a seat near his own, exclaiming, "This is no place for the Irish Demosthenes!" His first speech was on the Catholic question, and though some doubt had been felt lest Grattan, like Flood, should belie at Westminster the reputation made in Dublin, all agreed with the description of his speech by the *Annual Register* as "one of the most brilliant and eloquent ever pronounced within the walls of parliament." When Fox and Grenville came into power in 1806 Grattan was offered, but refused to

³ *Ibid.* I. 241.

⁴ *Grattan's Speeches*, iv. 23.

⁵ W. E. H. Lecky, *History of England in the Eighteenth Century*, viii. 491. Cf. *Cornwallis Correspondence*, iii. 250.

⁶ W. E. H. Lecky, *Leaders of Public Opinion in Ireland*, I. 270.

accept, an office in the government. In the following year he showed the strength of his judgment and character by supporting, in spite of consequent unpopularity in Ireland, a measure for increasing the powers of the executive to deal with Irish disorder. Roman Catholic emancipation, which he continued to advocate with unflinching energy though now advanced in age, became complicated after 1808 by the question whether a veto on the appointment of Roman Catholic bishops should rest with the crown. Grattan supported the veto, but a more extreme Catholic party was now arising in Ireland under the leadership of Daniel O'Connell, and Grattan's influence gradually declined. He seldom spoke in parliament after 1810, the most notable exception being in 1815, when he separated himself from the Whigs and supported the final struggle against Napoleon. His last speech of all, in 1810, contained a passage referring to the union he had so passionately resisted, which exhibits the statesmanship and at the same time the equable quality of Grattan's character. His sentiments with regard to the policy of the union remained, he said, unchanged; but "the marriage having taken place it is now the duty, as it ought to be the inclination, of every individual to render it as fruitful, as profitable and as advantageous as possible." In the following summer, after crossing from Ireland to London when out of health to bring forward the Catholic question once more, he became seriously ill. On his death-bed he spoke generously of Castlereagh, and with warm eulogy of his former rival, Flood. He died on the 6th of June 1820, and was buried in Westminster Abbey close to the tombs of Pitt and Fox. His statue is in the outer lobby of the Houses of Parliament at Westminster. Grattan had married in 1782 Henrietta Fitzgerald, a lady descended from the ancient family of Desmond, by whom he had two sons and two daughters.

The most searching scrutiny of his private life only increases the respect due to the memory of Grattan as a statesman and the greatest of Irish orators. His patriotism was untainted by self-seeking; he was courageous in risking his popularity for what his sound judgment showed him to be the right course. As Sydney Smith said with truth of Grattan soon after his death: "No government ever dismayed him. The world could not bribe him. He thought only of Ireland; lived for no other object; dedicated to her his beautiful fancy, his elegant wit, his manly courage, and all the splendour of his astonishing eloquence."¹

BIBLIOGRAPHY.—Henry Grattan, *Memoirs of the Life and Times of the Right Hon. H. Grattan* (5 vols., London, 1839-1846); *Grattan's Speeches* (ed. by H. Grattan, junr., 1822); *Irish Parl. Debates*; W. E. H. Lecky, *History of England in the Eighteenth Century* (8 vols., London, 1878-1890) and *Leaders of Public Opinion in Ireland* (enlarged edition, 2 vols., 1903). For the controversy concerning the recall of Lord Fitzwilliam see, in addition to the foregoing, Lord Rosebery, *Pitt* (London, 1891); Lord Ashbourne, *Pitt: Some Chapters of his Life* (London, 1898); *The Pelham Papers* (*Brit. Mus. Add. MSS.*, 33118); *Carlisle Correspondence*; *Beresford Correspondence*; *Stanhope Miscellanies*; for the Catholic question, W. J. Amburst, *History of Catholic Emancipation* (2 vols., London, 1886); Sir Thomas Wyse, *Historical Sketch of the late Catholic Association of Ireland* (London, 1829); W. J. MacNeven, *Pieces of Irish History* (New York, 1807) containing an account of the United Irishmen; for the volunteer movement Thomas MacNeven, *History of the Volunteers of 1782* (Dublin, 1845); *Proceedings of the Volunteer Delegates of Ireland 1784* (Anon. Pamph. Brit. Mus.). See also F. Hardy, *Memoirs of Lord Charlemont* (London, 1812); Warden Flood, *Memoirs of Henry Flood* (London, 1838); Francis Plowden, *Historical Review of the State of Ireland* (London, 1803); Alfred Webb, *Compendium of Irish Biography* (Dublin, 1878); Sir Jonah Barrington, *Rise and Fall of the Irish Nation* (London, 1833); W. J. O'Neill Daunt, *Ireland and her Agitators*; Lord Mountmorres, *History of the Irish Parliament* (2 vols., London, 1792); Horace Walpole, *Memoirs of the Reign of George III.* (4 vols., London, 1845 and 1846); Lord Stanhope, *Life of William Pitt* (4 vols., London, 1861); Thomas Davis, *Life of J. P. Curran* (Dublin, 1846)—this contains a memoir of Grattan by D. O. Madden, and Grattan's reply to Lord Clare on the question of the Union; Charles Phillips, *Recollections of Curran and some of his Contemporaries* (London, 1822); J. A. Froude, *The English in Ireland* (London, 1881); J. G. McCarthy, *Henry Grattan: an Historical Study* (London, 1886); Lord Mahon's *History of England*, vol. vii. (1858). With special reference to the Union see *Castlereagh Correspondence*; *Corwallis Correspondence*; *Westminster Papers* (Irish State Paper Office). (R. J. M.)

¹ Sydney Smith's *Works*, ii. 166-167.

GRATTIUS (FALISCUS), Roman poet, of the age of Augustus, author of a poem on hunting (*Cynegética*), of which 541 hexameters remain. He was possibly a native of Falerii. The only reference to him in any ancient writer is incidental (Ovid, *Es. Pons*, iv. 16. 33). He describes various kinds of game, methods of hunting, the best breeds of horses and dogs.

There are editions by R. Stern (1832); E. Bährens in *Poëtas Latini Minores* (l., 1879) and G. G. Curcio in *Poëti Latini Minores* (i., 1902), with bibliography; see also H. Schenkl, *Zur Kritik des G.* (1898). There is a translation by Christopher Wase (1654).

GRAUDENZ (Polish *Grudziadz*), a town in the kingdom of Prussia, province of West Prussia, on the right bank of the Vistula, 18 m. S.S.W. of Marienwerder and 37 m. by rail N.N.E. of Thorn. Pop. (1885) 17,336, (1905) 35,988. It has two Protestant and three Roman Catholic churches, and a synagogue. It is a place of considerable manufacturing activity. The town possesses a museum and a monument to Guillaume René Courbière (1733-1811), the defender of the town in 1807. It has fine promenades along the bank of the Vistula. Graudenz is an important place in the German system of fortifications, and has a garrison of considerable size.

Graudenz was founded about 1250, and received civic rights in 1291. At the peace of Thorn in 1466 it came under the lordship of Poland. From 1665 to 1759 it was held by Sweden, and in 1772 it came into the possession of Prussia. The fortress of Graudenz, which since 1873 has been used as a barracks and a military depot and prison, is situated on a steep eminence about 1½ m. north of the town and outside its limits. It was completed by Frederick the Great in 1776, and was rendered famous through its defence by Courbière against the French in 1807.

GRAUN, CARL HEINRICH (1701-1759), German musical composer, the youngest of three brothers, all more or less musical, was born on the 7th of May 1701 at Wahrenbrück in Saxony. His father held a small government post and he gave his children a careful education. Graun's beautiful soprano voice secured him an appointment in the choir at Dresden. At an early age he composed a number of sacred cantatas and other pieces for the church service. He completed his studies under Johann Christoph Schmidt (1664-1728), and profited much by the Italian operas which were performed at Dresden under the composer Lotti. After his voice had changed to a tenor, he made his début at the opera of Brunswick, in a work by Schürmann, an inferior composer of the day; but not being satisfied with the arias assigned him he re-wrote them, so much to the satisfaction of the court that he was commissioned to write an opera for the next season. This work, *Polydorus* (1726), and five other operas written for Brunswick, spread his fame all over Germany. Other works, mostly of a sacred character, including two settings of the *Passion*, also belong to the Brunswick period. Frederick the Great, at that time crown prince of Prussia, heard the singer in Brunswick in 1735, and immediately engaged him for his private chapel at Rheinsberg. There Graun remained for five years, and wrote a number of cantatas, mostly to words written by Frederick himself in French, and translated into Italian by Boltarelli. On his accession to the throne in 1740, Frederick sent Graun to Italy to engage singers for a new opera to be established at Berlin. Graun remained a year on his travels, earning universal applause as a singer in the chief cities of Italy. After his return to Berlin he was appointed conductor of the royal orchestra (*Kapellmeister*) with a salary of 2000 thalers (£300). In this capacity he wrote twenty-eight operas, all to Italian words, of which the last, *Merope* (1756), is perhaps the most perfect. It is probable that Graun was subjected to considerable humiliation from the arbitrary caprices of his royal master, who was never tired of praising the operas of Hasse and abusing those of his *Kapellmeister*. In his oratorio *The Death of Jesus* Graun shows his skill as a contrapuntist, and his originality of melodious invention. In the Italian operas he imitates the florid style of his time, but even in these the recitatives occasionally show considerable dramatic power. Graun died on the 8th of August 1759, at Berlin, in the same house in which, thirty-two years later, Meyerbeer was born.

GRAVAMEN (from Lat. *gravare*, to weigh down; *gravis*, heavy), a complaint or grievance, the ground of a legal action, and particularly the more serious part of a charge against an accused person. In English the term is used chiefly in ecclesiastical cases, being the technical designation of a memorial presented from the Lower to the Upper House of Convocation, setting forth grievances to be redressed, or calling attention to breaches in church discipline.

GRAVE. (1) From a common Teutonic verb, meaning "to dig"; in O. Eng. *grafan*; cf. Dutch *graven*, Ger. *graben*), a place dug out of the earth in which a dead body is laid for burial, and hence any place of burial, not necessarily an excavation (see FUNERAL RITES and BURIAL). The verb "to grave," meaning properly to dig, is particularly used of the making of incisions in a hard surface (see ENGRAVING). (2) A title, now obsolete, of a local administrative official for a township in certain parts of Yorkshire and Lincolnshire; it also sometimes appears in the form "grieve," which in Scotland and Northumberland is used for sheriff (*q.v.*), and also for a bailiff or under-steward. The origin of the word is obscure, but it is probably connected with the German *graf*, count, and thus appears as the second part of many Teutonic titles, such as landgrave, burgrave and margrave. "Grieve," on the other hand, seems to be the northern representative of O.E. *gerefa*, reeve; cf. "sheriff" and "count." (3) (From the Lat. *gravis*, heavy), weighty, serious, particularly with the idea of dangerous, as applied to diseases and the like, of character or temperament as opposed to gay. It is also applied to sound, low or deep, and is thus opposed to "acute." In music the term is adopted from the French and Italian, and applied to a movement which is solemn or slow. (4) To clean a ship's bottom in a specially constructed dock, called a "graving dock." The origin of the word is obscure; according to the *New English Dictionary* there is no foundation for the connexion with "graves" or "graves," the refuse of tallow, in candle or soap-making, supposed to be used in "graving" a ship. It may be connected with an O. Fr. *grève*, mod. *grève*, shore.

GRAVEL, or **PEBBLE BEDS**, the name given to deposits of rounded, subangular, water-worn stones, mingled with finer material such as sand and clay. The word "gravel" is adapted from the O. Fr. *gravelle*, mod. *gravelle*, dim. of *grave*, coarse sand, sea-shore, Mod. Fr. *grève*. The deposits are produced by the attrition of rock fragments by moving water, the waves and tides of the sea and the flow of rivers. Extensive beds of gravel are forming at the present time on many parts of the British coasts where suitable rocks are exposed to the attack of the atmosphere and of the sea waves during storms. The flint gravels of the coast of the Channel, Norfolk, &c., are excellent examples. When the sea is rough the lesser stones are washed up and down the beach by each wave, and in this way are rounded, worn down and finally reduced to sand. These gravels are constantly in movement, being urged forward by the shore currents especially during storms. Large banks of gravel may be swept away in a single night, and in this way the coast is laid bare to the erosive action of the sea. Moreover, the movement of the gravel itself wears down the subjacent rocks. Hence in many places barriers have been erected to prevent the drift of the pebbles and preserve the land, while often it has been found necessary to protect the shores by masonry or cement work. Where the pebbles are swept along to a projecting cape they may be carried onwards and form a long spit or submarine bank, which is constantly reduced in size by the currents and tides which flow across it (e.g. Spurn Head at the mouth of the Humber). The Chesil Bank is the best instance in Britain of a great accumulation of pebbles constantly urged forward by storms in a definite direction. In the shallower parts of the North Sea considerable areas are covered with coarse sand and pebbles. In deeper water, however, as in the Atlantic, beyond the 100 fathom line pebbles are very rare, and those which are found are mostly erratics carried southward by floating icebergs, or volcanic rocks ejected by submarine volcanoes.

In many parts of Britain, Scandinavia and North America there are marine gravels, in every essential resembling those of

the sea-shore, at levels considerably above high tide. These gravels often lie in flat-topped terraces which may be traced for great distances along the coast. They are indications that the sea at one time stood higher than it does at present, and are known to geologists as "raised beaches." In Scotland such beaches are known 25, 50 and 100 ft. above the present shores. In exposed situations they have old shore cliffs behind them; although their deposits are mainly gravely there is much fine sand and silt in the raised beaches of sheltered estuaries and near river mouths.

River gravels occur most commonly in the middle and upper parts of streams where the currents in times of flood are strong enough to transport fairly large stones. In deltas and the lower portions of large rivers gravel deposits are comparatively rare and indicate periods when the volume of the stream was temporarily greatly increased. In the higher torrents also, gravels are rare because transport is so effective that no considerable accumulations can form. In most countries where the drainage is of a mature type, river gravels occur in the lower parts of the courses of the rivers as banks or terraces which lie some distance above the stream level. Individual terraces usually do not persist for a long space but are represented by a series of benches at about the same altitude. These were once continuous, and have been separated by the stream cutting away the intervening portions as it deepened and broadened its channel. Terraces of this kind often occur in successive series at different heights, and the highest are the oldest because they were laid down at a time when the stream flowed at their level and mark the various stages by which the valley has been eroded. While marine terraces are nearly always horizontal, stream terraces slope downwards along the course of the river.

The extensive deposits of river gravels in many parts of England, France, Switzerland, North America, &c., would indicate that at some former time the rivers flowed in greater volume than at the present day. This is believed to be connected with the glacial epoch and the augmentation of the streams during those periods when the ice was melting away. Many changes in drainage have taken place since then; consequently wide sheets of glacial and fluvioglacial gravel lie spread out where at present there is no stream. Often they are commingled with sand, and where there were temporary post-glacial lakes deposits of silt, brick clay and mud have been formed. These may be compared to the similar deposits now forming in Greenland, Spitzbergen and other countries which are at present in a glacial condition.

As a rule gravels consist mainly of the harder kinds of stone because these alone can resist attrition. Thus the gravels formed from chalk consist almost entirely of flint, which is so hard that the chalk is ground to powder and washed away, while the flint remains little affected. Other hard rocks such as chert, quartzite, felsite, granite, sandstone and volcanic rocks very frequently are largely represented in gravels, while coal, limestone and shale are far less common. The size of the pebbles varies from a fraction of an inch to several feet; it depends partly on the fissility of the original rocks and partly on the strength of the currents of water; coarse gravels indicate the action of powerful eroding agents. In the Tertiary systems gravels occur on many horizons, e.g. the Woolwich and Reading beds, Oldhaven beds and Bagshot beds of the Eocene of the London basin. They do not essentially differ from recent gravel deposits. But in course of time the action of percolating water assisted by pressure tends to convert gravels into firm masses of conglomerate by depositing carbonate of lime, silica and other substances in their interstices. Gravels are not usually so fossiliferous as finer deposits of the same age, partly because their porous texture enables organic remains to be dissolved away by water, and partly because shells and other fossils are comparatively fragile and would be broken up during the accumulation of the pebbles. The rock fragments in conglomerates, however, sometimes contain fossils which have not been found elsewhere. (J. S. F.)

GRAVELINES (Flem. *Gravelinghe*), a fortified seaport town of northern France, in the department of Nord and arrondissement

of Dunkirk, 15 m. S.W. of Dunkirk on the railway to Calais. Pop. (1906) town, 1858; commune, 6284. Gravelines is situated on the Aa, 1½ m. from its mouth in the North Sea. It is surrounded by a double circuit of ramparts and by a tidal moat. The river is canalized and opens out beneath the fortifications into a floating basin. The situation of the port is one of the best in France on the North Sea, though its trade has suffered owing to the nearness of Calais and Dunkirk and the siltting up of the channel to the sea. It is a centre for the cod and herring fisheries. Imports consist chiefly of timber from Northern Europe and coal from England, to which eggs and fruit are exported. Gravelines has paper-manufactories, sugar-works, fish-curing works, salt-refineries, chicory-roasting factories, a cannery for preserved peas and other vegetables and an important timber-yard. The harbour is accessible to vessels drawing 18 ft. at high tides. The greater part of the population of the commune of Gravelines dwells in the maritime quarter of Petit-Fort-Philippe at the mouth of the Aa, and in the village of Les Huttes (to the east of the town), which is inhabited by the fisher-folk.

The canalisation of the Aa by a count of Flanders about the middle of the 17th century led to the foundation of Gravelines (*gravelles*, meaning "count's canal"). In 1558 it was the scene of the signal victory of the Spaniards under the count of Egmont over the French. It finally passed from the Spaniards to the French by the treaty of the Pyrenees in 1659.

GRAVELOTTE, a village of Lorraine between Metz and the French frontier, famous as the scene of the battle of the 18th of August 1870 between the Germans under King William of Prussia and the French under Marshal Bazaine (see METZ and FRANCO-GERMAN WAR). The battlefield extends from the woods which border the Moselle above Metz to Roncourt, near the river Orne. Other villages which played an important part in the battle of Gravelotte were Saint Privat, Amanweiler or Amanvillers and Sainte-Marie-aux-Chênes, all lying to the N. of Gravelotte.

GRAVE, ALFRED PERCEVAL (1846-), Irish writer, was born in Dublin, the son of the bishop of Limerick. He was educated at Windermere College, and took high honours at Dublin University. In 1869 he entered the Civil Service as clerk in the Home Office, where he remained until he became in 1874 an inspector of schools. He was a constant contributor of prose and verse to the *Spectator*, *The Athenaeum*, *John Bull*, and *Punch*, and took a leading part in the revival of Irish letters. He was for several years president of the Irish Literary Society, and is the author of the famous ballad of "Father O'Flynn" and many other songs and ballads. In collaboration with Sir C. V. Stanford he published *Songs of Old Ireland* (1882), *Irish Songs and Ballads* (1893), the airs of which are taken from the Petrie MSS.; the airs of his *Irish Folk-Songs* (1897) were arranged by Charles Wood, with whom he also collaborated in *Songs of Erin* (1901).

His brother, Charles L. Graves (b. 1856), educated at Marlborough and at Christ Church, Oxford, also became well known as a journalist, author of two volumes of parodies, *The Howardsen Horace* (1894) and *More Howardsen Horace* (1896), and of skits in prose and verse. An admirable musical critic, his *Life and Letters of Sir George Grove* (1903) is a model biography.

GRAVESEND, a municipal and parliamentary borough, river-port and market town of Kent, England, on the right bank of the Thames opposite Tilbury Fort, 22 m. E. by S. of London by the South-Eastern & Chatham railway. Pop. (1901) 27,196. It extends about 2 m. along the river bank, occupying a slight acclivity which reaches its summit at Windmill Hill, whence extensive views are obtained of the river, with its windings and shipping. The older and lower part of the town is irregularly built, with narrow and inconvenient streets, but the upper and newer portion contains several handsome streets and terraces. Among several piers are the town pier, erected in 1832, and the terrace pier, built in 1845, at a time when local river-traffic by steamboat was specially prosperous. Gravesend is a favourite resort of the inhabitants of London, both for excursions and as a summer residence; it is also a favourite yachting centre.

The principal buildings are the town-hall, the parish church of Gravesend, erected on the site of an ancient building destroyed by fire in 1727; Milton parish church, a Decorated and Perpendicular building erected in the time of Edward II; and the county courts. Milton Mount College is a large institution for the daughters of Congregational ministers. East of the town are the earthworks designed to assist Tilbury Fort in obstructing the passage up river of an enemy's force. They were originally constructed on Vauban's system in the reign of Charles II. Rosherville Gardens, a popular resort, are in the western suburb of Rosherville, a residential quarter named after James Rosher, an owner of lime works. They were founded in 1843 by George Jones. Gravesend, which is within the Port of London, has some import trade in coal and timber, and fishing, especially of shrimps, is carried on extensively. The principal other industries are boat-building, ironfounding, brewing and soap-boiling. Fruit and vegetables are largely grown in the neighbourhood for the London market. Since 1867 Gravesend has returned a member to parliament, the borough including Northfleet to the west. The town is governed by a mayor, 6 aldermen and 18 councillors. Area, 1259 acres.

In the Domesday Survey "Gravesham" is entered among the bishop of Bayeux's lands, and a "hythe" or landing-place is mentioned. In 1401 Henry IV. granted the men of Gravesend the sole right of conveying in their own vessels all persons travelling between London and Gravesend, and this right was confirmed by Edward IV. in 1462. In 1562 the town was granted a charter of incorporation by Elizabeth, which vested the government in 2 portreeves and 12 jurats, but by a later charter of 1568 one portreeve was substituted for the two. Charles I. incorporated the town anew under the title of the mayor, jurats and inhabitants of Gravesend, and a further charter of liberties was granted by James II. in 1687. A Thursday market and fair on the 13th of October were granted to the men of Gravesend by Edward III. in 1367; Elizabeth's charters gave them a Wednesday market and fairs on the 24th of June and the 13th of October, with a court of pie-powder; by the charter of Charles I. Thursday and Saturday were made the market days, and these were changed again to Wednesday and Saturday by a charter of 1694, which also granted a fair on the 23rd of April; the fairs on these dates have died out, but the Saturday market is still held.

From the beginning of the 17th century Gravesend was the chief station for East Indianmen; most of the ships outward bound from London stopped here to victual. A customs house was built in 1782. Queen Elizabeth established Gravesend as the point where the corporation of London should welcome in state eminent foreign visitors arriving by water. State processions by water from Gravesend to London had previously taken place, as in 1522, when Henry VIII. escorted the emperor Charles V. A similar practice was maintained until modern times; as when, on the 7th of March 1863, the princess Alexandra was received here by the prince of Wales (King Edward VII.) three days before their marriage. Gravesend parish church contains memorials to "Princess" Pocahontas, who died when preparing to return home from a visit to England in 1617, and was buried in the old church. A memorial pulpit from the state of Indiana, U.S.A., made of Virginian wood, was provided in 1904, and a fund was raised for a stained-glass window by ladies of the state of Virginia.

GRAVINA, GIOVANNI VINCENZO (1664-1718), Italian littérateur and juriconsult, was born at Roggiano, a small town near Cosenza, in Calabria, on the 20th of January 1664. He was descended from a distinguished family, and under the direction of his maternal uncle, Gregorio Caloprese, who possessed some reputation as a poet and philosopher, received a learned education, after which he studied at Naples civil and canon law. In 1689 he came to Rome, where in 1695 he united with several others of literary tastes in forming the Academy of Arcadians. A schism occurred in the academy in 1711, and Gravina and his followers founded in opposition to it the Academy of Quirina. From Innocent XII. Gravina received the offer of various

ecclesiastical honours, but declined them from a disinclination to enter the clerical profession. In 1699 he was appointed to the chair of civil law in the college of La Sapienza, and in 1703 he was transferred to the chair of canon law. He died at Rome on the 6th of January 1718. He was the adoptive father of Metastasio.

Gravina is the author of a number of works of great erudition, the principal being his *Origines juris civilis*, completed in 3 vols. (1713) and his *De Romano imperio* (1712). A French translation of the former appeared in 1775, of which a second edition was published in 1822. His collected works were published at Leipzig in 1737, and at Naples, with notes by Mascovius, in 1756.

GRAVINA, a town and episcopal see of Apulia, Italy, in the province of Bari, from which it is 63 m. S.W. by rail (29 m. direct), 1148 ft. above sea-level. Pop. (1901) 18,197. The town is probably of mediæval origin, though some conjecture that it occupies the site of the ancient Blera, a post station on the Via Appia. The cathedral is a basilica of the 15th century. The town is surrounded with walls and towers, and a castle of the emperor Frederick II. rises above the town, which later belonged to the Orsini, dukes of Gravina; just outside it are dwellings and a church (S. Michele) all hewn in the rock, and now abandoned.

Prehistoric remains in the district (remains of ancient settlements, *Insusuli*, &c.) are described by V. di Cicco in *Notizie degli scavi* (1901), p. 217.

GRAVITATION (from Lat. *gravis*, heavy), in physical science, that mutual action between masses of matter by virtue of which every such mass tends toward every other with a force varying directly as the product of the masses and inversely as the square of their distances apart. Although the law was first clearly and rigorously formulated by Sir Isaac Newton, the fact of the action indicated by it was more or less clearly seen by others. Even Ptolemy had a vague conception of a force tending toward the centre of the earth which not only kept bodies upon its surface, but in some way upheld the order of the universe. John Kepler inferred that the planets move in their orbits under some influence or force exerted by the sun; but the laws of motion were not then sufficiently developed, nor were Kepler's ideas of force sufficiently clear, to admit of a precise statement of the nature of the force. C. Huygens and R. Hooke, contemporaries of Newton, saw that Kepler's third law implied a force tending toward the sun which, acting on the several planets, varied inversely as the square of the distance. But two requirements necessary to generalize the theory were still wanting. One was to show that the law of the inverse square not only represented Kepler's third law, but his first two laws also. The other was to show that the gravitation of the earth, following one and the same law with that of the sun, extended to the moon. Newton's researches showed that the attraction of the earth on the moon was the same as that for bodies at the earth's surface, only reduced in the inverse square of the moon's distance from the earth's centre. He also showed that the total gravitation of the earth, assumed as spherical, on external bodies, would be the same as if the earth's mass were concentrated in the centre. This led at once to the statement of the law in its most general form.

The law of gravitation is unique among the laws of nature, not only in its wide generality, taking the whole universe in its scope, but in the fact that, so far as yet known, it is absolutely unmodified by any condition or cause whatever. All other forms of action between masses of matter, vary with circumstances. The mutual action of electrified bodies, for example, is affected by their relative or absolute motion. But no conditions to which matter has ever been subjected, or under which it has ever been observed, have been found to influence its gravitation in the slightest degree. We might conceive the rapid motions of the heavenly bodies to result in some change either in the direction or amount of their gravitation towards each other at each moment; but such is not the case, even in the most rapidly moving bodies of the solar system. The question has also been raised whether the action of gravitation is absolutely instantaneous. If not, the action would not be exactly in the line

adjoining the two bodies at the instant, but would be affected by the motion of the line joining them during the time required by the force to pass from one body to the other. The result of this would be seen in the motions of the planets around the sun; but the most refined observations show no such effect. It is also conceivable that bodies might gravitate differently at different temperatures. But the most careful researches have failed to show any apparent modification produced in this way except what might be attributed to the surrounding conditions. The most recent and exhaustive experiment was that of J. H. Poynting and P. Phillips (*Proc. Roy. Soc.*, 76A, p. 445). The result was that the change, if any, was less than $\frac{1}{16}$ of the force for one degree change of temperature, a result too minute to be established by any measures.

Another cause which might be supposed to modify the action of gravitation between two bodies would be the interposition of masses of matter between them, a cause which materially modifies the action of electrified bodies. The question whether this cause modifies gravitation admits of an easy test from observation. If it did, then a portion of the earth's mass or of that of any other planet turned away from the sun would not be subjected to the same action of the sun as if directly exposed to that action. Great masses, as those of the great planets, would not be attracted with a force proportional to the mass because of the hindrance or other effect of the interposed portions. But not the slightest modification due to this cause is shown. The general conclusion from everything we see is that a mass of matter in Australia attracts a mass in London precisely as it would if the earth were not interposed between the two masses.

We must therefore regard the law in question as the broadest and most fundamental one which nature makes known to us.

It is not yet experimentally proved that variation as the inverse square is absolutely true at all distances. Astronomical observations extend over too brief a period of time to show any attraction between different stars except those in each other's neighbourhood. But this proves nothing because, in the case of distances so great, centuries or even thousands of years of accurate observation will be required to show any action. On the other hand the enigmatical motion of the perihelion of Mercury has not yet found any plausible explanation except on the hypothesis that the gravitation of the sun diminishes at a rate slightly greater than that of the inverse square—the most simple modification being to suppose that instead of the exponent of the distance being exactly -2 , it is $-2.000\ 000\ 161$.

The argument is extremely simple in form. It is certain that, in the general average, year after year, the force with which Mercury is drawn toward the sun does vary from the exact inverse square of its distance from the sun. The most plausible explanation of this is that one or more masses of matter move around the sun, whose action, whether they are inside or outside the orbit of Mercury, would produce the required modification in the force. From an investigation of all the observations upon Mercury and the other three interior planets, Simon Newcomb found it almost out of the question that any such mass of matter could exist without changing either the figure of the sun itself or the motion of the planes of the orbits of either Mercury or Venus. The qualification "almost" is necessary because so complex a system of actions comes into play, and accurate observations have extended through so short a period, that the proof cannot be regarded as absolute. But the fact that careful and repeated search for a mass of matter sufficient to produce the desired effect has been in vain, affords additional evidence of its non-existence. The most obvious test of the reality of the required modifications would be afforded by two other bodies, the motions of whose pericentres should be similarly affected. These are Mars and the moon. Newcomb found an excess of motions in the perihelion of Mars amounting to about $5''$ per century. But the combination of observations and theory on which this is based is not sufficient fully to establish so slight a motion. In the case of the motion of the moon around the earth, assuming the gravitation of the latter to be subject to the modification in question, the annual motion of the moon's

perigee should be greater by 1.5" than the theoretical motion. E. W. Brown is the first investigator to determine the theoretical motions with this degree of precision; and he finds that there is no such divergence between the actual and the computed motion. There is therefore as yet no ground for regarding any deviation from the law of inverse square as more than a possibility. (S. N.)

GRAVITATION CONSTANT AND MEAN DENSITY OF THE EARTH

The law of gravitation states that two masses M_1 and M_2 , distant d from each other, are pulled together each with a force $G \cdot M_1 M_2 / d^2$, where G is a constant for all kinds of matter—the gravitation constant. The acceleration of M_2 towards M_1 , or the force exerted on it by M_1 , per unit of its mass is therefore GM_1/d^2 . Astronomical observations of the accelerations of different planets towards the sun, or of different satellites towards the same primary, give us the most accurate confirmation of the distance part of the law. By comparing accelerations towards different bodies we obtain the ratios of the masses of those different bodies and, in so far as the ratios are consistent, we obtain confirmation of the mass part. But we only obtain the ratios of the masses to the mass of some one member of the system, say the earth. We do not find the mass in terms of grammes or pounds. In fact, astronomy gives us the product GM , but neither G nor M : For example, the acceleration of the earth towards the sun is about 0.6 cm/sec.² at a distance from it about 15×10^{12} cm. The acceleration of the moon towards the earth is about 0.27 cm/sec.² at a distance from it about 4×10^{10} cm. If S is the mass of the sun and E the mass of the earth we have $0.6 = GS / (15 \times 10^{12})^2$ and $0.27 = GE / (4 \times 10^{10})^2$ giving us GS and GE , and the ratio $S/E = 300,000$ roughly; but we do not obtain either S or E in grammes, and we do not find G .

The aim of the experiments to be described here may be regarded either as the determination of the mass of the earth in grammes, most conveniently expressed by its mass+its volume, that is by its "mean density" Δ , or the determination of the "gravitation constant" G . Corresponding to these two aspects of the problem there are two modes of attack. Suppose that a body of mass m is suspended at the earth's surface where it is pulled with a force w vertically downwards by the earth—its weight. At the same time let it be pulled with a force p by a measurable mass M which may be a mountain, or some measurable part of the earth's surface layers, or an artificially prepared mass brought near m , and let the pull of M be the same as if it were concentrated at a distance d . The earth pull may be regarded as the same as if the earth were all concentrated at its centre, distant R .

Then $w = G \cdot \frac{1}{2} R^2 \Delta m / R^2 = G \cdot \frac{1}{2} R \Delta m$, (1)

and $p = GMm/d^2$ (2)

By division
$$\Delta = \frac{2M}{4Rd^2} \cdot \frac{w}{p}$$

If then we can arrange to observe w/p we obtain Δ , the mean density of the earth.

But the same observations give us G also. For, putting $w = w/g$ in (2), we get

$$G = \frac{d^2}{M} \cdot \frac{p}{w \cdot g}$$

In the second mode of attack the pull p between two artificially prepared measured masses M_1, M_2 is determined when they are a distance d apart, and since $p = G \cdot M_1 M_2 / d^2$ we get at once $G = p d^2 / M_1 M_2$. But we can also deduce Δ . For putting $w = mg$ in (1) we get

$$\Delta = \frac{2}{3} \frac{g}{R} \cdot \frac{1}{\frac{p}{w}}$$

Experiments of the first class in which the pull of a known mass is compared with the pull of the earth may be termed experiments on the mean density of the earth, while experiments of the second class in which the pull between two known masses is

directly measured may be termed experiments on the gravitation constant.

We shall, however, adopt a slightly different classification for the purpose of describing methods of experiment, viz:—

1. Comparison of the earth pull on a body with the pull of a natural mass as in the Schiehallion experiment.
2. Determination of the attraction between two artificial masses as in Cavendish's experiment.
3. Comparison of the earth pull on a body with the pull of an artificial mass as in experiments with the common balance.

It is interesting to note that the possibility of gravitation experiments of this kind was first considered by Newton, and in both of the forms (1) and (2). In the *System of the World* (3rd ed., 1737, p. 40) he calculates that the deviation by a hemispherical mountain, of the earth's density and with radius 3 m., on a plumb-line at its side will be less than 2 minutes. He also calculates (though with an error in his arithmetic) the acceleration towards each other of two spheres each a foot in diameter and of the earth's density, and comes to the conclusion that in either case the effect is too small for measurement. In the *Principia*, bk. iii., prop. x., he makes a celebrated estimate that the earth's mean density is five or six times that of water. Adopting this estimate, the deviation by an actual mountain or the attraction of two terrestrial spheres would be of the orders calculated, and regarded by Newton as immeasurably small.

Whatever method is adopted the force to be measured is very minute. This may be realized if we here anticipate the results of the experiments, which show that in round numbers $\Delta = 5.5$ and $G = 1/15,000,000$ when the masses are in grammes and the distances in centimetres.

Newton's mountain, which would probably have density about $\Delta/2$ would deviate the plumb-line not much more than half a minute. Two spheres 30 cm. in diameter (about 1 ft.) and of density 11 (about that of lead) just not touching would pull each other with a force rather less than 2 dynes, and their acceleration would be such that they would move into contact if starting 1 cm. apart in rather over 400 seconds.

From these examples it will be realized that in gravitation experiments extraordinary precautions must be adopted to eliminate disturbing forces which may easily rise to be comparable with the forces to be measured. We shall not attempt to give an account of these precautions, but only seek to set forth the general principles of the different experiments which have been made.

I Comparison of the Earth Pull with that of a Natural Mass.

Bouguer's Experiments.—The earliest experiments were made by Pierre Bouguer about 1740, and they are recorded in his *Figure de la terre* (1749). They were of two kinds. In the first he determined the length of the seconds pendulum, and thence g at different levels. Thus at Quito, which may be regarded as on a table-land 1466 toises (a toise is about 6.4 ft.) above sea-level, the seconds pendulum was less by $1/1331$ than on the Isle of Inca at sea-level. But if there were no matter above the sea-level, the inverse square law would make the pendulum less by $1/1118$ at the higher level. The value of g then at the higher level was greater than could be accounted for by the attraction of an earth ending at sea-level by the difference $1/1118 - 1/1331 = 1/6983$, and this was put down to the attraction of the plateau 1466 toises high; or the attraction of the whole earth was 6983 times the attraction of the plateau. Using the rule, now known as "Young's rule," for the attraction of the plateau, Bouguer found that the density of the earth was 4.7 times that of the plateau, a result certainly much too large.

In the second kind of experiment he attempted to measure the horizontal pull of Chimborazo, a mountain about 20,000 ft. high, by the deflection of a plumb-line at a station on its south side. Fig. 1 shows the principle of the method. Suppose that two stations are fixed, one on the side of the mountain due south of the summit, and the other on the same latitude but some distance westward, away from the influence of the mountain. Suppose that at the second station a star is observed to pass the meridian, for simplicity we will say directly overhead, then a

plumb-line will hang down exactly parallel to the observing telescope. If the mountain were away it would also hang parallel to the telescope at the first station when directed to the same star. But the mountain pulls the plumb-line towards it and the star appears to the north of the zenith and evidently

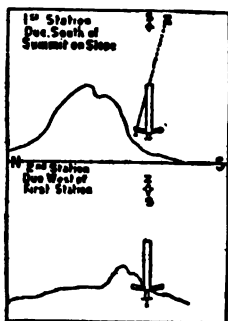

FIG. 1.—Bouguer's Plumb-line Experiment on the attraction of Chimborazo.

mountain pull/earth pull = tangent of angle of displacement of zenith.

Bouguer observed the meridian altitude of several stars at the two stations. There was still some deflection at the second station, a deflection which he estimated as $1/14$ that at the first station, and he found on allowing for this that his observations gave a deflection of 8 seconds at the first station. From the form and size of the mountain he found that if its density were that of the earth the deflection should be 103 seconds, or the earth was nearly 13 times as dense as the mountain, a result several times too large. But the work was carried on under enormous difficulties owing to the severity of the weather, and no exactness could be expected. The importance of the experiment lay in its proof that the method was possible.

Maskelyne's Experiment.—In 1774 Nevil Maskelyne (*Phil. Trans.*, 1775, p. 495) made an experiment on the deflection of the plumb-line by Schiehallion, a mountain in Perthshire, which has a short ridge nearly east and west, and sides sloping steeply on the north and south. He selected two stations on the same meridian, one on the north, the other on the south slope, and by means of a zenith sector, a telescope provided with a plumb-bob, he determined at each station the meridian zenith distances of a number of stars. From a survey of the district made in the years 1774-1776 the geographical difference of latitude between the two stations was found to be 42.94 seconds, and this would have been the difference in the meridian zenith difference of the same star at the two stations had the mountain been away. But at the north station the plumb-bob was pulled south and the zenith was deflected northwards, while at the south station the effect was reversed. Hence the angle between the zeniths, or the angle between the zenith distances of the same star at the two stations was greater than the geographical 42.94 seconds. The mean of the observations gave a difference of 54.7 seconds, or the double deflection of the plumb-line was 54.7-42.94, say 11.76 seconds.

The computation of the attraction of the mountain on the supposition that its density was that of the earth was made by Charles Hutton from the results of the survey (*Phil. Trans.*, 1778, p. 689), a computation carried out by ingenious and important methods. He found that the deflection should have been greater in the ratio 17804:9033 say 9:5, whence the density of the earth comes out at $9/5$ that of the mountain. Hutton took the density of the mountain at 2.5, giving the mean density of the earth 4.5. A revision of the density of the mountain from a careful survey of the rocks composing it was made by John Playfair many years later (*Phil. Trans.*, 1811, p. 347), and the density of the earth was given as lying between 4.5588 and 4.867.

Other experiments have been made on the attraction of mountains by Francesco Carlini (*Milano Effem. Ast.*, 1824, p. 28) on Mt. Blanc in 1821, using the pendulum method after the manner of Bouguer, by Colonel Sir Henry James and Captain A. R. Clarke (*Phil. Trans.*, 1856, p. 591), using the plumb-line deflection at Arthur's Seat, by T. C. Mendenhall (*Amer. Jour. of Sci.* xxi. p. 99), using the pendulum method on Fujiyama in Japan, and by E. D. Preston (*U.S. Coast and Geod. Survey Rep.*, 1895, p. 513) in Hawaii, using both methods.

Airy's Experiment.—In 1854 Sir G. B. Airy (*Phil. Trans.*, 1856, p. 297) carried out at Harton pit near South Shields an experiment which he had attempted many years before in conjunction with W. Whewell and R. Sheepshanks at Dolcoath. This consisted in comparing gravity at the top and at the bottom of a mine by the swings of the same pendulum, and thence finding the ratio of the pull of the intervening strata to the pull of the whole earth. The principle of the method may be understood by assuming that the earth consists of concentric spherical shells each homogeneous, the last of thickness h equal to the depth of the mine. Let the radius of the earth to the bottom of the mine be R , and the mean density up to that point be Δ . This will not differ appreciably from the mean density of the whole. Let the density of the strata of depth h be δ . Denoting the values of gravity above and below by g_0 and g_1 we have

$$g_0 = G \frac{4\pi R^3 \Delta}{R^2} = G \cdot 4\pi R \Delta,$$

and

$$g_1 = G \frac{4\pi (R-h)^3 \Delta}{(R-h)^2} + G \cdot 4\pi h \delta$$

(since the attraction of a shell h thick on a point just outside it is $G \cdot 4\pi (R+h)^2 h \delta / (R+h)^2 = G \cdot 4\pi h \delta$).

Therefore

$$g_1 = G \cdot 4\pi R \Delta \left(1 - \frac{2h}{R} + \frac{3h}{R} \frac{\delta}{\Delta} \right) \text{ nearly,}$$

whence

$$\frac{g_1}{g_0} = 1 - \frac{2h}{R} + \frac{3h}{R} \frac{\delta}{\Delta},$$

and

$$\frac{\Delta}{\delta} = \frac{3h}{R} / \left(1 - \frac{2h}{R} + \frac{g_1}{g_0} \right)$$

Stations were chosen in the same vertical, one near the pit bank, another 1250 ft. below in a disused working, and a "comparison" clock was fixed at each station. A third clock was placed at the upper station connected by an electric circuit to the lower station. It gave an electric signal every 15 seconds by which the rates of the two comparison clocks could be accurately compared. Two "invariable" seconds pendulums were swung, one in front of the upper and the other in front of the lower comparison clock after the manner of Kater, and these invariables were interchanged at intervals. From continuous observations extending over three weeks and after applying various corrections Airy obtained $g_0/g_1 = 1.00005185$. Making corrections for the irregularity of the neighbouring strata he found $\Delta/\delta = 2.6266$. W. H. Miller made a careful determination of δ from specimens of the strata, finding it 2.5. The final result taking into account the ellipticity and rotation of the earth is $\Delta = 6.565$.

Von Sterneck's Experiments.—(*Mitth. des K.U.K. Mil. Geog. Inst. zu Wien*, ii., 1882, p. 77; 1883, p. 59; vi., 1886, p. 97). R. von Sterneck repeated the mine experiment in 1882-1883 at the Adalbert shaft at Pribram in Bohemia and in 1885 at the Abraham shaft near Freiberg. He used two invariable half-seconds pendulums, one swung at the surface, the other below at the same time. The two were at intervals interchanged. Von Sterneck introduced a most important improvement by comparing the swings of the two invariables with the same clock which by an electric circuit gave a signal at each station each second. This eliminated clock rates. His method, of which it is not necessary to give the details here, began a new era in the determinations of local variations of gravity. The values which von Sterneck obtained for Δ were not consistent, but increased with the depth of the second station. This was probably due to local irregularities in the strata which could not be directly detected.

All the experiments to determine Δ by the attraction of natural masses are open to the serious objection that we cannot determine the distribution of density in the neighbourhood with any approach to accuracy. The experiments with artificial masses next to be described give much more consistent results, and the experiments with natural masses are now only of use

in showing the existence of irregularities in the earth's superficial strata when they give results deviating largely from the accepted value.

II. Determination of the Attraction between two Artificial Masses.

Cavendish's Experiment (*Phil. Trans.*, 1798, p. 469).—This celebrated experiment was planned by the Rev. John Michell. He completed an apparatus for it but did not live to begin work with it. After Michell's death the apparatus came into the possession of Henry Cavendish, who largely reconstructed it, but still adhered to Michell's plan, and in 1797-1798 he carried out the experiment. The essential feature of it consisted in the determination of the attraction of a lead sphere 12 in. in diameter on another lead sphere 2 in. in diameter, the distance between the centres being about 9 in., by means of a torsion balance. Fig. 2 shows how the experiment was carried out. A torsion rod *kk* 6 ft. long, tied from its ends to a vertical piece *mg*, was

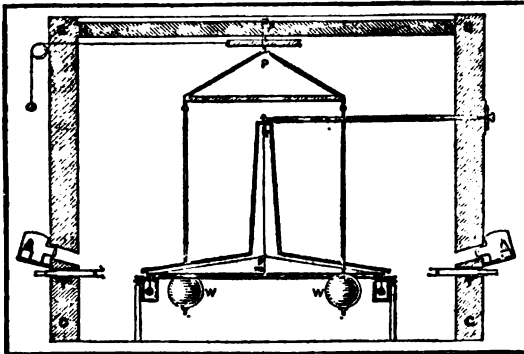

FIG. 2.—Cavendish's Apparatus. *k k*, torsion rod hung by wire *lg*; *x x*, attracted balls hung from its ends; *W W*, attracting masses.

hung by a wire *lg*. From its ends depended two lead balls *x x* each 2 in. in diameter. The position of the rod was determined by a scale fixed near the end of the arm, the arm itself carrying a vernier moving along the scale. This was lighted by a lamp and viewed by a telescope *T* from the outside of the room containing the apparatus. The torsion balance was enclosed in a case and outside this two lead spheres *W W* each 12 in. in diameter hung from an arm which could turn round an axis *Pp* in the line of *g*. Suppose that first the spheres are placed so that one is just in front of the right-hand ball *x* and the other is just behind the left-hand ball *x*. The two will conspire to pull the balls so that the right end of the rod moves forward. Now let the big spheres be moved round so that one is in front of the left ball and the other behind the right ball. The pulls are reversed and the right end moves backward. The angle between its two positions is (if we neglect cross attractions of right sphere on left ball and left sphere on right ball) four times as great as the deflection of the rod due to approach of one sphere to one ball.

The principle of the experiment may be set forth thus. Let *2a* be the length of the torsion rod, *m* the mass of a ball, *M* the mass of a large sphere, *d* the distance between the centres, supposed the same on each side. Let θ be the angle through which the rod moves round when the spheres *W W* are moved from the first to the second of the positions described above. Let μ be the couple required to twist the rod through 1 radian. Then $\mu\theta = 4GMma/d^2$. But μ can be found from the time of vibration of the torsion system when we know its moment of inertia *I*, and this can be determined. If *T* is the period $\mu = 4\pi^2 I/T^2$, whence $G = \pi^2 d^2 \theta/T^2 m a$, or putting the result in terms of the mean density of the earth Δ it is easy to show that, if *L*, the length of the seconds pendulum, is put for g/l^2 , and *C* for $2\pi R$, the earth's circumference, then

$$\Delta = \frac{L M m a T^2}{2 C \theta l^2}$$

The original account by Cavendish is still well worth studying

on account of the excellence of his methods. His work was undoubtedly very accurate for a pioneer experiment and has only really been improved upon within the last generation. Making various corrections of which it is not necessary to give a description, the result obtained (after correcting a mistake first pointed out by F. Baily) is $\Delta = 5.448$. In seeking the origin of the disturbed motion of the torsion rod Cavendish made a very important observation. He found that when the masses were left in one position for a time the attracted balls crept now in one direction, now in another, as if the attraction were varying. Ultimately he found that this was due to convection currents in the case containing the torsion rod, currents produced by temperature inequalities. When a large sphere was heated the ball near it tended to approach and when it was cooled the ball tended to recede. Convection currents constitute the chief disturbance and the chief source of error in all attempts to measure small forces in air at ordinary pressure.

Reich's Experiments (*Versuche über die mittlere Dichtigkeit der Erde mittelst der Drehwaage*, Freiberg, 1838; "Neue Versuche mit der Drehwaage," *Leipzig Abh. Math. Phys.* i., 1852, p. 383).—In 1838 F. Reich published an account of a repetition of the Cavendish experiment carried out on the same general lines, though with somewhat smaller apparatus. The chief differences consisted in the methods of measuring the times of vibration and the deflection, and the changes were hardly improvements. His result after revision was $\Delta = 5.49$. In 1852 he published an account of further work giving as result $\Delta = 5.58$. It is noteworthy that in his second paper he gives an account of experiments suggested by J. D. Forbes in which the deflection was not observed directly, but was deduced from observations of the time of vibration when the attracting masses were in different positions.

Let *T*₁ be the time of vibration when the masses are in one of the usual attracting positions. Let *d* be the distance between the centres of attracting mass and attracted ball, and δ the distance through which the ball is pulled. If *a* is the half length of the torsion rod and θ the deflection, $\delta = a\theta$. Now let the attracting masses be put one at each end of the torsion rod with their centres in the line through the centres of the balls and *d* from them, and let *T*₂ be the time of vibration. Then it is easy to show that

$$\delta/d = a\theta/d = (T_1 - T_2)/(T_1 + T_2)$$

This gives a value of θ which may be used in the formula. The experiments by this method were not consistent, and the mean result was $\Delta = 6.25$.

Baily's Experiment (*Memoirs of the Royal Astron. Soc.* xiv.)—In 1841-1842 Francis Baily made a long series of determinations by Cavendish's method and with apparatus nearly of the same dimensions. The attracting masses were 12-in. lead spheres and as attracted balls he used various masses, lead, zinc, glass, ivory, platinum, hollow brass, and finally the torsion rod alone without balls. The suspension was also varied, sometimes consisting of a single wire, sometimes being bifilar. There were systematic errors running through Baily's work, which it is impossible now wholly to explain. These made the resulting value of Δ show a variation with the nature of the attracted masses and a variation with the temperature. His final result $\Delta = 5.6747$ is not of value compared with later results.

Cornu and Baille's Experiment (*Comptes rendus*, lxxvi., 1873, p. 954; lxxvii., 1878, pp. 571, 609, 1001; xcvi., 1883, p. 1493).—In 1870 M.M. A. Cornu and J. Baille commenced an experiment by the Cavendish method which was never definitely completed, though valuable studies of the behaviour of the torsion apparatus were made. They purposely departed from the dimensions previously used. The torsion balls were of copper about 100 gm. each, the rod was 50 cm. long, and the suspending wire was 4 metres long. On each side of each ball was a hollow iron sphere. Two of these were filled with mercury weighing 12 kgn., the two spheres of mercury constituting the attracting masses. When the position of a mass was to be changed the mercury was pumped from the sphere on one side to that on the other side of a ball. To avoid counting time a

method of electric registration on a chronograph was adopted. A provisional result was $\Delta = 5.56$.

Boys's Experiment (*Phil. Trans.*, A., 1895, pt. i, p. 1).—Professor C. V. Boys having found that it is possible to draw quartz fibres of practically any degree of fineness, of great strength and true in their elasticity, determined to repeat the Cavendish experiment, using his newly invented fibres for the suspension of the torsion rod. He began by an inquiry as to the best dimensions for the apparatus. He saw that if the period of vibration is kept constant, that is, if the moment of inertia I is kept proportional to the torsion couple per radian μ , then the deflection remains the same however the linear dimensions are altered so long as they are all altered in the same proportion. Hence we are driven to conclude that the dimensions should be reduced until further reduction would make the linear quantities too small to be measured with exactness, for reduction in the apparatus enables variations in temperature and the consequent air disturbances to be reduced, and the experiment in other ways becomes more manageable. Professor Boys took as the exactness to be sought for 1 in 10,000. He further saw that reduction in length of the torsion rod with given balls is an advantage. For if the rod be halved the moment of inertia is one-fourth, and if the suspending fibre is made finer so that the torsion couple per radian is also one-fourth the time remains the same. But the moment of the attracting force is halved only, so that the deflection against one-fourth torsion is doubled. In Cavendish's arrangement there would

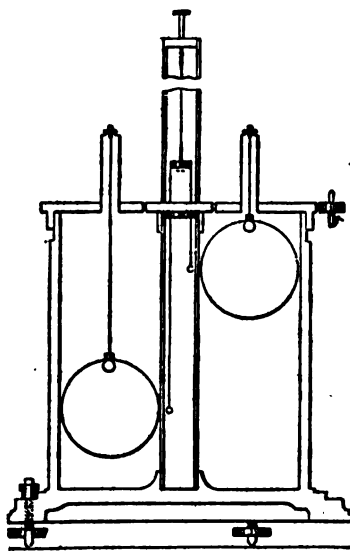

Fig. 3.—Diagram of a Section of Professor Boys's Apparatus.

be an early limit to the advantage in reduction of rod in that the mass opposite one ball would begin seriously to attract the other ball. But Boys avoided this difficulty by suspending the balls from the ends of the torsion rod at different levels and by placing the attracting masses at these different levels. Fig. 3 represents diagrammatically a vertical section of the arrangement used on a scale of about $1/10$. The torsion rod was a small rectangular mirror about 2.4 cm. wide hung by a quartz fibre about 43 cm. long. From the sides of this mirror the balls were hung by quartz fibres at levels differing by 15 cm. The balls were of gold either about 5 mm. in diameter and weighing about 1.3 gm. or about 6.5 mm. in diameter and weighing 2.65 gm. The attracting masses were lead spheres, about 10 cm. in diameter and weighing about 7.4 kgm. each. These were suspended from the top of the case which could be rotated round the central tube, and they were arranged so that the radius to the centre from the axis of the torsion system made 65° with the torsion rod, the position in which the moment of the attraction was a maximum. The torsion rod mirror reflected a distant scale by which the deflection could be read. The time of vibration was recorded on a chrono-

graph. The result of the experiment, probably the best yet made, was $\Delta = 5.527$; $G = 6.658 \times 10^{-8}$.

Braun's Experiment (*Denkschr. Akad. Wiss. Wien, math.-naturw. Cl.* 64, p. 187, 1896).—In 1896 Dr K. Braun, S. J., gave an account of a very careful and excellent repetition of the Cavendish experiment with apparatus much smaller than was used in the older experiments, yet much larger than that used by Boys. A notable feature of the work consisted in the suspension of the torsion apparatus in a receiver exhausted to about 4 mm. of mercury, a pressure at which convection currents almost disappear while "radiometer" forces have hardly begun. For other ingenious arrangements the original paper or a short abstract in *Nature*, lvi, 1897, p. 127, may be consulted. The attracted balls weighed 54 gm. each and were 25 cm. apart. The attracting masses were spheres of mercury each weighing 9 kgm. and brought into position outside the receiver. Braun used both the deflection method and the time of vibration method suggested to Reich by Forbes. The methods gave almost identical results and his final values are to three decimal places the same as those obtained by Boys.

G. K. Burgess's Experiment (*Thèses présentées à la faculté des sciences de Paris pour obtenir le titre de docteur de l'université de Paris*, 1901).—This was a Cavendish experiment in which the torsion system was buoyed up by a float in a mercury bath. The attracted masses could thus be made large, and yet the suspending wire could be kept fine. The torsion beam was 12 cm. long, and the attracted balls were lead spheres each 2 kgm. From the centre of the beam depended a vertical steel rod with a varnished copper hollow float at its end, entirely immersed in mercury. The surface of the mercury was covered with dilute sulphuric acid to remove irregularities due to varying surface tension acting on the steel rod. The size of the float was adjusted so that the torsion fibre of quartz 35 cm. long had only to carry a weight of 5 to 10 gm. The time of vibration was over one hour. The torsion couple per radian was determined by preliminary experiments. The attracting masses were each 10 kgm. turning in a circle 18 cm. in diameter. The results gave $\Delta = 5.55$ and $G = 6.64 \times 10^{-8}$.

Eötvos's Experiment (*Ann. der Physik und Chemie*, 1896, 50, p. 354).—In the course of investigations on local variations of gravity by means of the torsion balance, R. Eötvos devised a method for determining G somewhat like the vibration method used by Reich and Braun. Two pillars were built up of lead blocks 30 cm. square in cross section, 60 cm. high and 30 cm. apart. A torsion rod somewhat less than 30 cm. long with small weights at the ends was enclosed in a double-walled brass case of as little depth as possible, a device which secured great steadiness through freedom from convection currents. The suspension was a platinum wire about 150 cm. long. The torsion rod was first set in the line joining the centres of the pillars and its time of vibration was taken. Then it was set with its length perpendicular to the line joining the centres and the time again taken. From these times Eötvos was able to deduce $G = 6.65 \times 10^{-8}$ whence $\Delta = 5.53$. This is only a provisional value. The experiment was only as it were a by-product in the course of exceedingly ingenious work on the local variation in gravity for which the original paper should be consulted.

Wilsing's Experiment (*Publ. des astrophysikalischen Observ. zu Potsdam*, 1887, No. 22, vol. vi. pt. ii.; pt. iii. p. 133).—We may perhaps class with the Cavendish type an experiment made by J. Wilsing, in which a vertical "double pendulum" was used in place of a horizontal torsion system. Two weights each 540 gm. were fixed at the ends of a rod 1 metre long. A knife edge was fixed on the rod just above its centre of gravity, and this was supported so that the rod could vibrate about a vertical position. Two attracting masses, cast-iron cylinders each 325 kgm., were placed, say, one in front of the top weight on the pendulum and the other behind the bottom weight, and the position of the rod was observed in the usual mirror and scale way. Then the front attracting mass was dropped to the level of the lower weight and the back mass was raised to that of the upper weight, and the consequent deflection of the rod was

observed. By taking the time of vibration of the pendulum first as used in the deflection experiment and then when a small weight was removed from the upper end a known distance from the knife edge, the restoring couple per radian deflection could be found. The final result gave $\Delta = 5.579$.

J. Jolly's suggested Experiment (Nature xli., 1890, p. 256).—Joly has suggested that G might be determined by hanging a simple pendulum in a vacuum, and vibrating outside the case two massive pendulums each with the same time of swing as the simple pendulum. The simple pendulum would be set swinging by the varying attraction and from its amplitude after a known number of swings of the outside pendulums G could be found.

III. Comparison of the Earth Pull on a body with the Pull of an Artificial Mass by Means of the Common Balance.

The principle of the method is as follows:—Suppose a sphere of mass m and weight w to be hung by a wire from one arm of a balance. Let the mass of the earth be E and its radius be R . Then $w = GEw/R^2$. Now introduce beneath m a sphere of mass M and let d be the distance of its centre from that of m . Its pull increases the apparent weight of m say by δw . Then $\delta w = GMm/d^2$. Dividing we obtain $\delta w/w = MR^2/E\delta^2$, whence $E = MR^2/\delta^2 w$; and since $g = GE/R^2$, G can be found when E is known.

Von Jolly's Experiment (Abhand. der k. bayern. Akad. der Wiss. 2 Cl. xiii. Bd. 1 Abt. p. 157, and xiv. Bd. 2 Abt. p. 3).—In the first of these papers Ph. von Jolly described an experiment in which he sought to determine the decrease in weight with increase of height from the earth's surface, an experiment suggested by Bacon (*Nov. Org.* Bk. 2, § 36), in the form of comparison of rates of two clocks at different levels, one driven by a spring, the other by weights. The experiment in the form carried out by von Jolly was attempted by H. Power, R. Hooke, and others in the early days of the Royal Society (Mackenzie, *The Laws of Gravitation*). Von Jolly fixed a balance at the top of his laboratory and from each pan depended a wire supporting another pan 5 metres below. Two 1-kgm. weights were first balanced in the upper pans and then one was moved from an upper to the lower pan on the same side. A gain of 1.5 mgm. was observed after correction for greater weight of air displaced at the lower level. The inverse square law would give a slightly greater gain and the deficiency was ascribed to the configuration of the land near the laboratory. In the second paper a second experiment was described in which a balance was fixed at the top of a tower and provided as before with one pair of pans just below the arms and a second pair hung from these by wires 21 metres below. Four glass globes were prepared equal in weight and volume. Two of these were filled each with 5 kgm. of mercury and then all were sealed up. The two heavy globes were then placed in the upper pans and the two light ones in the lower. The two on one side were now interchanged and a gain in weight of about 31.7 mgm. was observed. Air corrections were eliminated by the use of the globes of equal volume. Then a lead sphere about 1 metre radius was built up of blocks under one of the lower pans and the experiment was repeated. Through the attraction of the lead sphere on the mass of mercury when below the gain was greater by 0.580 mgm. This result gave $\Delta = 5.692$.

Experiment of Richarz and Krigar-Menzel (Anhang zu den Abhand. der k. preuss. Akad. der Wiss. zu Berlin, 1898).—In 1884 A. König and F. Richarz proposed a similar experiment which was ultimately carried out by Richarz and O. Krigar-Menzel. In this experiment a balance was supported somewhat more than 2 metres above the floor and with scale pans above and below as in von Jolly's experiment. Weights each 1 kgm. were placed, say, in the top right pan and the bottom left pan. Then they were shifted to the bottom right and the top left, the result being, after corrections for change in density of air displaced through pressure and temperature changes, a gain in weight of 1.2453 mgm. on the right due to change in level of 1.2628 metres. Then a rectangular column of lead 220 cm. square cross section and 200 cm. high was built up under the balance between the pairs of pans. The column was perforated

with two vertical tunnels for the passage of the wires supporting the lower pans. On repeating the weighings there was now a decrease on the right when a kgm. was moved on that side from top to bottom while another was moved on the left from bottom to top. This decrease was 0.1211 mgm. showing a total change due to the lead mass of 1.2453 + 0.1211 = 1.3664 mgm. and this is obviously four times the attraction of the lead mass on one kgm. The changes in the positions of the weights were made automatically. The results gave $\Delta = 5.05$ and $G = 6.685 \times 10^{-8}$.

Poynting's Experiment (Phil. Trans., vol. 182, A, 1891, p. 565).—In 1878 J. H. Poynting published an account of a preliminary experiment which he had made to show that the common balance was available for gravitational work. The experiment was on the same lines as that of von Jolly but on a much smaller scale. In 1891 he gave an account of the full experiment carried out with a larger balance and with much greater care. The balance had a 4-ft. beam. The scale pans were removed, and from the two arms were hung lead spheres each weighing about 20 kgm. at a level about 120 cm. below the beam. The balance was supported in a case above a horizontal turn-table with axis vertically below the central knife edge, and on this turn-table was a lead sphere weighing 150 kgm.—the attracting mass. The centre of this sphere was 30 cm. below the level of the centres of the hanging weights. The turn-table could be rotated between stops so that the attracting mass was first immediately below the hanging weight on one side, and then immediately under that on the other side. On the same turn-table but at double the distance from the centre was a second sphere of half the weight introduced merely to balance the larger sphere and keep the centre of gravity at the centre of the turn-table. Before the introduction of this sphere errors were introduced through the tilting of the floor of the balance room when the turn-table was rotated. Corrections of course had to be made for the attraction of this second sphere. The removal of the large mass from left to right made an increase in weight on that side of about 1 mgm. determined by riders in a special way described in the paper. To eliminate the attraction on the beam and the rods supporting the hanging weights another experiment was made in which these weights were moved up the rods through 30 cm. and on now moving the attracting sphere from left to right the gain on the right was only about $\frac{1}{2}$ mgm. The difference, $\frac{1}{2}$ mgm., was due entirely to change in distance of the attracted masses. After all corrections the results gave $\Delta = 5.493$ and $G = 6.668 \times 10^{-8}$.

Final Remarks.—The earlier methods in which natural masses were used have disadvantages, as already pointed out, which render them now quite valueless. Of later methods the Cavendish appears to possess advantages over the common balance method in that it is more easy to ward off temperature variations, and so avoid convection currents, and probably more easy to determine the actual value of the attracting force. For the present the values determined by Boys and Braun may be accepted as having the greatest weight and we therefore take

Mean density of the earth $\Delta = 5.527$

Constant of gravitation $G = 6.658 \times 10^{-8}$

Probably $\Delta = 5.53$ and $G = 6.66 \times 10^{-8}$ are correct to 1 in 500.

AUTHORITIES.—J. H. Poynting, *The Mean Density of the Earth* (1894), gives an account of all work up to the date of publication with a bibliography; A. Stanley Mackenzie, *The Laws of Gravitation* (1899), gives annotated extracts from various papers, some historical notes and a bibliography. *A Bibliography of Geodesy, Appendix 8, Report for 1902 of the U.S. Coast and Geodetic Survey* includes a very complete bibliography of gravitational work. (J.H.P.)

GRAVY, a word usually confined to the natural juices which come from meat during cooking. In early uses (in the *New English Dictionary* the quotations date from the end of the 14th to the beginning of the 16th centuries) it meant a sauce of broth flavoured with spices and almonds. The more modern usage seems to date from the end of the 16th century. The word is obscure in origin. It has been connected with "graves" or "graves," the refuse of tallow in the manufacture of soap or candles. The more probable derivation is from the French. In Old French the word is almost certainly *grant*, and is derived

from *grain*, "something used in cooking." The word was early read and spelled with a *s* or *v* instead of *n*, and the corruption was adopted in English.

GRAY, ASA (1810-1888), American botanist, was born at Paris, Oneida county, N.Y., on the 18th of November 1810. He was the son of a farmer, and received no formal education except at the Fairfield (N.Y.) academy and the Fairfield medical school. From Dr James Hadley, the professor of chemistry and *matéria medica* he obtained his first instruction in science (1825-1826). In the spring of 1827 he first began to collect and identify plants. His formal education, such as it was, ended in February 1831, when he took the degree of M.D. His first contribution to descriptive botany appeared in 1835, and thereafter an uninterrupted series of contributions to systematic botany flowed from his pen for fifty-three years. In 1836 his first botanical text-book appeared under the title *Elements of Botany*, followed in 1839 by his *Botanical Text-Book for Colleges, Schools, and Private Students* which developed into his *Structural Botany*. He published later *First Lessons in Botany and Vegetable Physiology* (1857); *How Plants Grow* (1858); *Field, Forest, and Garden Botany* (1869); *How Plants Behave* (1872). These books served the purpose of developing popular interest in botanical studies. His most important work, however, was his *Manual of the Botany of the Northern United States*, the first edition of which appeared in 1847. This manual has passed through a large number of editions, is clear, accurate and compact to an extraordinary degree, and within its geographical limits is an indispensable book for the student of American botany.

Throughout his life Gray was a diligent writer of reviews of books on natural history subjects. Often these reviews were elaborate essays, for which the books served merely as texts; often they were clear and just summaries of extensive works; sometimes they were sharply critical, though never ill-natured or unfair; always they were interesting, lively and of literary as well as scientific excellence. The greater part of Gray's strictly scientific labour was devoted to a *Flora* of North America, the plan of which originated with his early teacher and associate, John Torrey of New York. The second volume of Torrey and Gray's *Flora* was completed in 1843; but for forty years thereafter Gray gave up a large part of his time to the preparation of his *Synoptical Flora* (1878). He lived at the period when the flora of North America was being discovered, described and systematized; and his enthusiastic labours in this fresh field placed him at the head of American botanists and on a level with the most famous botanists of the world. In 1856 he published a paper on the distribution of plants under the title *Statistics of the Flora of the Northern United States*; and this paper was followed in 1859 by a memoir on the botany of Japan and its relations to that of North America, a paper of which Sir J. D. Hooker said that "in point of originality and far-reaching results [it] was its author's *opus magnum*." It was Gray's study of plant distribution which led to his intimate correspondence with Charles Darwin during the years in which Darwin was elaborating the doctrines that later became known as Darwinism. From 1855 to 1875 Gray was both a keen critic and a sympathetic exponent of the Darwinian principles. His religious views were those of the Evangelical bodies in the Protestant Church; so that, when Darwinism was attacked as equivalent to atheism, he was in position to answer effectively the unfounded allegation that it was fatal to the doctrine of design. He taught that "the most puzzling things of all to the old-school teleologists are the *principia* of the Darwinian." He openly avowed his conviction that the present species are not special creations, but rather derived from previously existing species; and he made his avowal with frank courage, when this truth was scarcely recognized by any naturalists, and when to the clerical mind evolution meant atheism.

In 1842 Gray accepted the Fisher professorship of natural history in Harvard University. On his accession to this chair the university had no herbarium, no botanical library, few plants of any value, and but a small garden, which for lack of money had never been well stocked or well arranged. He soon brought

together, chiefly by widespread exchanges, a valuable herbarium and library, and arranged the garden; and thereafter the development of these botanical resources was part of his regular labours. The herbarium soon became the largest and most valuable in America, and on account of the numerous type specimens it contains it is likely to remain a collection of national importance. Nothing of what Gray did for the botanical department of the university has been lost; on the contrary, his labours were so well directed that everything he originated and developed has been enlarged, improved and placed on stable foundations. He himself made large contributions to the establishment by giving it all his own specimens, many books and no little money, and by his will he gave it the royalties on his books. During his long connexion with the university he brought up two generations of botanists and he always took a strong personal interest in the researches and the personal prospects of the young men who had studied under him. His scientific life was mainly spent in the herbarium and garden in Cambridge; but his labours there were relieved by numerous journeys to different parts of the United States and to Europe, all of which contributed to his work on the *Synoptical Flora*. He lived to a good age—long enough, indeed, to receive from learned societies at home and abroad abundant evidence of their profound respect for his attainments and services. He died at Cambridge, Mass., on the 30th of January 1888.

His *Letters* (1893) were edited by his wife; and his *Scientific Papers* (1888) by C. S. Sargent. (C. W. E.)

GRAY, DAVID (1838-1861), Scottish poet, the son of a handloom weaver, was born at Merkland, near Glasgow, on the 29th of January 1838. His parents resolved to educate him for the church, and through their self-denial and his own exertions as a pupil teacher and private tutor he was able to complete a course of four sessions at the university of Glasgow. He began to write poetry for *The Glasgow Citizen* and began his idyll on the Luggie, the little stream that ran through Merkland. His most intimate companion at this time was Robert Buchanan, the poet; and in May 1860 the two agreed to proceed to London, with the idea of finding literary employment. Shortly after his arrival in London Gray introduced himself to Monckton Milnes, afterwards Lord Houghton, with whom he had previously corresponded. Lord Houghton tried to persuade him to return to Scotland, but Gray insisted on staying in London. He was unsuccessful in his efforts to place Gray's poem, "The Luggie," in *The Cornhill Magazine*, but gave him some slight literary work. He also showed him great kindness when a cold which had seized him assumed the serious form of consumption, and sent him to Torquay; but as the disease made rapid progress, an irresistible longing seized Gray to return to Merkland, where he arrived in January 1861, and died on the 3rd of December following, having the day before had the gratification of seeing a printed specimen copy of his poem "The Luggie," published eventually by the exertions of Sydney Dobell. He was buried in the Auld Aisle Churchyard, Kirkintilloch, where in 1865 a monument was erected by "friends far and near" to his memory.

"The Luggie," the principal poem of Gray, is a kind of reverie in which the scenes and events of his childhood and his early aspirations are mingled with the music of the stream which he celebrates. The series of sonnets, "In the Shadows," was composed during the latter part of his illness. Most of his poems necessarily bear traces of immaturity, and lines may frequently be found in them which are mere echoes from Thomson, Wordsworth or Tennyson, but they possess, nevertheless, distinct individuality, and show a real appreciation of natural beauty.

The Luggie and other Poems, with an introduction by R. Monckton Milnes, and a brief memoir by James Hedderwick, was published in 1862; and a new and enlarged edition of Gray's *Poetical Works*, edited by Henry Glassford Bell, appeared in 1874. See also *David Gray and other Essays*, by Robert Buchanan (1868), and the same writer's poem on David Gray, in *Idylls and Legends of Inverburn*.

GRAY, ELISHA (1835-1901), American electrician, was born in Barnesville, Belmont county, Ohio, on the 2nd of August 1835. He worked as a carpenter and in a machine shop, reading

in physical science at the same time, and for five years studied at Oberlin College, where he taught for a time. He then investigated the subject of telegraphy, and in 1867 patented a telegraphic switch and annunciator. Experimenting in the transmittal of electro-tones and of musical tones by wire, he utilized in 1874 animal tissues in his receivers, and filed, on the 14th of February 1876, a caveat for the invention of a telephone, only a few hours after the filing of an application for a patent by Alexander Graham Bell. (See TELEPHONE.) The caveat was disregarded; letters patent No. 174,465 were granted to Bell, whose priority of invention was upheld in 1888 by the United States Supreme Court (see *Molecular Telephone Co. v. American Bell Telephone Co.*, 126 U.S. 1). Gray's experiments won for him high praise and the decoration of the Legion of Honour at the Paris Exposition of 1878. He was for a time a manufacturer of electrical apparatus, particularly of his own inventions; and was chief electrical expert of the Western Electric Company of Chicago. At the Columbian Exposition of 1893 Gray was chairman of the International Congress of Electricians. He died at Newtonville, Massachusetts, on the 21st of January 1901. Among his later inventions were appliances for multiplex telegraphy and the telautograph, a machine for the electric transmission of handwriting. He experimented in the submarine use of electric bells for signalling.

Gray wrote, besides scientific addresses and many monographs, *Telegraphy and Telephony* (1878) and *Electricity and Magnetism* (1900).

GRAY, HENRY PETERS (1819-1877), American portrait and genre painter, was born in New York on the 23rd of June 1819. He was a pupil of Daniel Huntington there, and subsequently studied in Rome and Florence. Elected a member of the National Academy of Design in 1842, he succeeded Huntington as president in 1870, holding the position until 1871. The later years of his life were devoted to portrait work. He was strongly influenced by the old Italian masters, painting in mellow colour with a classical tendency. One of his notable canvases was an allegorical composition called "The Birth of our Flag" (1875). He died in New York City on the 12th of November 1877.

GRAY, HORACE (1828-1902), American jurist, was born in Boston, Massachusetts, on the 24th of March 1828. He graduated at Harvard in 1845; was admitted to the bar in 1851, and in 1854-1861 was reporter to the Supreme Court of Massachusetts. He practised law, first in partnership with Ebenezer Rockwood Hoar, and later with Wilder Dwight (1823-1862) and Charles F. Blake; was appointed associate justice of the state Supreme Court on the 23rd of August 1864, becoming chief-justice on the 5th of September 1873; and was associate justice of the Supreme Court of the United States from December 1881 to August 1902, resigning only a few weeks before his death at Nahant, Mass., on the 15th of September 1902. Gray had a fine sense of the dignity of the bench, and a taste for historical study. His judgments were unmistakably clear and contained the essence of earlier opinions. A great case lawyer, he was a much greater judge, the variety of his knowledge and his contributions to admiralty and prize law and to testamentary law being particularly striking; in constitutional law he was a "loose" rather than a "strict" constructionist.

See Francis C. Lowell, "Horace Gray," in *Proceedings of the American Academy*, vol. 39, pp. 627-637 (Boston, 1904).

GRAY, JOHN DE (d. 1214), bishop of Norwich, entered Prince John's service, and at his accession (1199) was rapidly promoted in the church till he became bishop of Norwich in September 1200. King John's attempt to force him into the primacy in 1205 started the king's long and fatal quarrel with Pope Innocent III. De Gray was a hard-working royal official, in finance, in justice, in action, using his position to enrich himself and his family. In 1209 he went to Ireland to govern it as justiciar. He adopted a forward policy, attempting to extend the English frontier northward and westward, and fought a number of campaigns on the Shannon and in Fermanagh. But in 1212 he suffered a great defeat. He assimilated the coinage of

Ireland to that of England, and tried to effect a similar reform in Irish law. De Gray was a good financier, and could always raise money: this probably explains the favour he enjoyed from King John. In 1213 he is found with 500 knights at the great muster at Barham Downs, when Philip Augustus was threatening to invade England. After John's reconciliation with Innocent he was one of those exempted from the general pardon, and was forced to go in person to Rome to obtain it. At Rome he so completely gained over Innocent that the pope sent him back with papal letters recommending his election to the bishopric of Durham (1213); but he died at St Jean d'Audely in Poitou on his homeward journey (October 1214).

GRAY, JOHN EDWARD (1800-1875), English naturalist, born at Walsall, Staffordshire, in 1800, was the eldest of the three sons of S. F. Gray, of that town, druggist and writer on botany, and author of the *Supplement to the Pharmacopoeia, &c.*, his grandfather being S. F. Gray, who translated the *Philosophia Botanica* of Linnaeus for the *Introduction to Botany* of James Lee (1715-1795). Gray studied at St Bartholomew's and other hospitals for the medical profession, but at an early age was attracted to the pursuit of botany. He assisted his father by collecting notes on botany and comparative anatomy and zoology in Sir Joseph Banks's library at the British Museum, aided by Dr W. E. Leach, assistant keeper, and the systematic synopsis of the *Natural Arrangement of British Plants*, 2 vols., 1821, was prepared by him, his father writing the preface and introduction only. In consequence of his application for membership of the Linnaean Society being rejected in 1822, he turned to the study of zoology, writing on zoophytes, shells, *Mollusca* and *Papilionidae*, still aided by Dr Leach at the British Museum. In December 1824 he obtained the post of assistant in that institution; and from that date to December 1839, when J. G. Children retired from the keepership, he had so zealously applied himself to the study, classification and improvement of the national collection of zoology that he was selected as the fittest person to be entrusted with its charge. Immediately on his appointment as keeper, he took in hand the revision of the systematic arrangement of the collections; scientific catalogues followed in rapid succession; the department was raised in importance; its poverty as well as its wealth became known, and whilst increased grants, donations and exchanges made good many deficiencies, great numbers of students, foreign as well as English, availed themselves of its resources to enlarge the knowledge of zoology in all its branches. In spite of numerous obstacles, he worked up the department, within a few years of his appointment as keeper, to such a state of excellence as to make it the rival of the cabinets of Leiden, Paris and Berlin; and later on it was raised under his management to the dignity of the largest and most complete zoological collection in the world. Although seized with paralysis in 1870, he continued to discharge the functions of keeper of zoology, and to contribute papers to the *Annals of Natural History*, his favourite journal, and to the transactions of a few of the learned societies; but at Christmas 1874, having completed half a century of official work, he resigned office, and died in London on the 7th of March 1875.

Gray was an exceedingly voluminous writer, and his interests were not confined to natural history only, for he took an active part in questions of public importance of his day, such as slave emancipation, prison discipline, abolition of imprisonment for debt, sanitary and municipal organizations, the decimal system, public education, extension of the opening of museums, &c. He began to publish in 1820, and continued till the year of his death.

The titles of the books, memoirs and miscellaneous papers written by him, accompanied by a few notes, fill a privately printed list of 96 octavo pages with 1162 entries.

GRAY, PATRICK GRAY, 6TH BARON (d. 1612), was descended from Sir Andrew Gray (c. 1390-1469) of Broxmouth and Foulis, who was created a Scottish peer as Lord Gray, probably in 1445. Andrew was a leading figure in Scottish politics during the reigns of James I. and his two successors, and visited England as a

hostage, a diplomatist and a pilgrim. The 2nd Lord Gray was his grandson Andrew (d. 1514), and the 4th lord was the latter's grandson Patrick (d. 1582), a participant in Scottish politics during the stormy time of Mary, queen of Scots. Patrick's son, Patrick, the 5th lord (d. 1609), married Barbara, daughter of William, 2nd Lord Ruthven, and their son Patrick, known as the "Master of Gray," is the subject of this article. Educated at Glasgow University and brought up as a Protestant, young Patrick was married early in life to Elizabeth Lyon, daughter of Lord Glamis, whom he repudiated almost directly; and afterwards went to France, where he joined the friends of Mary, queen of Scots, became a Roman Catholic, and assisted the French policy of the Guises in Scotland. He returned and took up his residence again in Scotland in 1583, and immediately began a career of treachery and intrigue, gaining James's favour by disclosing to him his mother's secrets, and acting in agreement with James Stewart, earl of Arran, in order to keep Mary a prisoner in England. In 1584 he was sent as ambassador to England, to effect a treaty between James and Elizabeth and to exclude Mary. His ambition incited him at the same time to promote a plot to secure the downfall of Arran. This was supported by Elizabeth, and was finally accomplished by letting loose the lords banished from Scotland for their participation in the rebellion called the Raid of Ruthven, who, joining Gray, took possession of the king's person at Stirling in 1585, the league with England being ratified by the parliament in December. Gray now became the intermediary between the English government and James on the great question of Mary's execution, and in 1587 he was despatched on an embassy to Elizabeth, ostensibly to save Mary's life. Gray had, however, previously advised her secret assassination and had endeavoured to overcome all James's scruples; and though he does not appear to have carried treachery so far as to advise her death on this occasion, no representations made by him could have had any force or weight. The execution of Mary caused his own downfall and loss of political power in Scotland; and after his return he was imprisoned on charges of plots against Protestantism, of endeavouring to prevent the king's marriage, and of having been bribed to consent to Mary's death. He pleaded guilty of sedition and of having obstructed the king's marriage, and was declared a traitor; but his life was spared by James and he was banished from the country, but permitted to return in 1589, when he was restored to his office of master of the wardrobe to which he had been appointed in 1585. His further career was marked by lawlessness and misconduct. In 1592, together with the 5th Lord Bothwell, he made an unsuccessful attempt to seize the king at Falkland, and the same year earned considerable discredit by bringing groundless accusations against the Presbyterian minister, Robert Bruce; while after the king's accession to the English throne he was frequently summoned before the authorities on account of his conduct. Notwithstanding, he never lost James's favour. In 1609 he succeeded his father as 6th Baron Gray, and died in 1612.

Gray was an intimate friend of Sir Philip Sidney, but, if one of the ablest, handsomest and most fascinating, he was beyond doubt one of the most unscrupulous men of his day. He married as his second wife in 1585 Mary Stewart, daughter of Robert, earl of Orkney, and had by her, besides six daughters, a son, Andrew (d. 1663), who succeeded him as 7th Baron Gray. Andrew, who served for a long time in the French army, was a supporter, although not a very prominent one, of Charles I. and afterwards of Charles II. He was succeeded as 8th Lord Gray by Patrick (d. 1711), a son of his daughter Anne, and Patrick's successor was his kinsman and son-in-law John (d. 1724). On the extinction of John's direct line in 1878 the title of Lord Gray passed to George Stuart, earl of Moray. In 1606 Gray had been ranked sixth among the Scottish baronies.

BIBLIOGRAPHY.—Article in *Dict. of Nat. Biog.*, and authorities there quoted; Gray's relation concerning the surprise at Stirling (*Bannatyne Club Publ.* i. 131, 1827); Andrew Lang, *History of Scotland*, vol. ii. (1902); Peter Gray, *The Descent and Kinship of Patrick, Master of Gray* (1903); *Gray Papers* (Bannatyne Club, 1835); *Hist. MSS. Comm.*, *Marq. of Salisbury's MSS.*

GRAY, ROBERT (1800–1872), first bishop of Cape Town and metropolitan of South Africa, was born at Bishop Wearmouth, Durham, and was the son of Robert Gray, bishop of Bristol. He was educated at Eton and Oxford, and took orders in 1833. After holding the livings of Whitworth, Durham, 1834–1845, and Stockton-on-Tees 1845–1847, he was consecrated bishop of Cape Town in 1847; the bishopric having been endowed through the liberality of Miss (afterwards Baroness) Burdett-Coutts. Until 1853 he was a suffragan of Canterbury, but in that year he formally resigned his see and was reappointed by letters patent metropolitan of South Africa in view of the contemplated establishment of the suffragan dioceses of Graham's Town and Natal. In that capacity his coercive jurisdiction was twice called in question, and in each case the judicial committee of the privy council decided against him. The best-known case is that of Bishop Colenso, whom Gray deposed and excommunicated in 1863. The spiritual validity of the sentence was upheld by the convocation of Canterbury and the Pan-Anglican synod of 1867, but legally Colenso remained bishop of Natal. The privy council decisions declared, in effect, that the Anglican body in South Africa was on the footing of a voluntary religious society. Gray, accepting this position, obtained its recognition by the mother church as the Church of the Province of South Africa, in full communion with the Church of England. The first provincial synod was held in 1870. During his episcopate Bishop Gray effected a much-needed organization of the South African church, to which he added five new bishoprics, all carved out of the original diocese of Cape Town. It was also chiefly owing to his suggestions that the universities' mission to Central Africa was founded.

GRAY, SIR THOMAS (d. c. 1369), English chronicler, was a son of Sir Thomas Gray, who was taken prisoner by the Scots at Bannockburn and who died about 1343. The younger Thomas was present at the battle of Neville's Cross in 1346; in 1355, whilst acting as warden of Norham Castle, he was made a prisoner, and during his captivity in Edinburgh Castle he devoted his time to studying the English chroniclers, Gildas, Bede, Ranulf Higdon and others. Released in 1357 he was appointed warden of the east marches towards Scotland in 1367, and he died about 1369. Gray's work, the *Scalacronica* (so called, perhaps, from the scaling-ladder in the crest of the Grays), is a chronicle of English history from the earliest times to about the year 1362. It is, however, only valuable for the reigns of Edward I. and Edward II. and part of that of Edward III., being especially so for the account of the wars between England and Scotland, in which the author's father and the author himself took part. Writing in Norman-French, Gray tells of Wallace and Bruce, of the fights at Bannockburn, Byland and Dupplin, and makes some mention of the troubles in England during the reign of Edward II. He also narrates the course of the war in France between 1355 and 1361; possibly he was present during some of these campaigns.

The *Scalacronica* was summarized by John Leland in the 16th century; the part dealing with the period from 1066 to the end, together with the prologue, was edited for the Maitland Club by J. Stevenson (1836); and the part from 1274 to 1362 was translated into English by Sir Herbert Maxwell (Glasgow, 1907). In the extant manuscript, which is in Corpus Christi College, Cambridge, there is a gap extending from about 1340 to 1355, and Gray's account of this period is only known from Leland's summary.

GRAY, THOMAS (1716–1771), English poet, the fifth and sole surviving child of Philip and Dorothy Gray, was born in London on the 26th of December 1716. His mother's maiden name was Antrobus, and in partnership with her sister Mary she kept a millinery shop in Cornhill. This and the house connected with it were the property of Philip Gray, a money-scrivener, who married Dorothy in 1706 and lived with her in the house, the sisters renting the shop from him and supporting themselves by its profits. Philip Gray had impaired the fortune which he inherited from his father, a wealthy London merchant; yet he was sufficiently well-to-do, and at the close of his life was building a house upon some property of his own at Wanstead. But he was selfish and brutal, and in 1735 his wife took some abortive

steps to obtain a separation from him. At this date she had given birth to twelve children, of whom Thomas was the only survivor. He owed his life as well as his education to this "careful, tender mother," as he calls her. The child was suffocating when she opened one of his veins with her own hand. He went at her expense to Eton in 1727, and was confided to the care of her brother, William Antrobus, one of the assistant-masters, during some part at least of his school-life.

At Eton Gray's closest friends were Horace Walpole, Richard West (son of the lord chancellor of Ireland and grandson of the famous Bishop Burnet), and Thomas Ashton, afterwards fellow of Eton. This little coté-à-coté was dubbed "the Quadruple Alliance"; its members were studious and literary, and took little part in the amusements of their fellows. In 1734 Gray matriculated at Peterhouse, Cambridge, of which his uncle, Robert Antrobus, had been a fellow. At Cambridge he had once more the companionship of Walpole and Ashton who were at King's, but West went to Christchurch, Oxford. Gray made at this time the firmest and most constant friendship of his life with Thomas Wharton (not the poet Wharton) of Pembroke College. He was maintained by his mother, and his straitened means were eked out by certain small exhibitions from his college. His conspicuous abilities and known devotion to study perhaps atoned in the eyes of the authorities for his indifference to the regular routine of study; for mathematics in particular he had an aversion which was the one exception to his almost limitless curiosity in other directions. During his first Cambridge period he learnt Italian "like any dragon," and made translations from Guarini, Dante and Tasso, some of which have been preserved. In September 1738 he is in the agony of leaving college, nor can we trace his movements with any certainty for a while, though it may be conjectured that he spent much time with Horace Walpole, and made in his company some fashionable acquaintances in London. On the 29th of March 1739, he started with Walpole for a long continental tour, for the expenses of which it is probable that his father, for once, came in some measure to his assistance. In Paris, Gray visited the great with his friend, studied the picture-galleries, went to tragedies, comedies, operas and cultivated there that taste for the French classical dramatists, especially Racine, whom he afterwards tried to imitate in the fragmentary "Agrippina." It is characteristic of him that he travels through France with Caesar constantly in his hands, ever noting and transcribing. In the same way, in crossing the Alps and in Piedmont, he has "Livius in the chaise with him and Silius Italicus too." In Italy he made a long sojourn, principally at Florence, where Walpole's life-long correspondent, Horace Mann, was British envoy, and received and treated the travellers most hospitably. But Rome and Naples are also described in Gray's letters, sometimes vividly, always amusingly, and in his notes are almost catalogued. Herculaneum, an object of intense interest to the young poet and antiquary, had been discovered the year before. At length in April 1741 Gray and Walpole set out northwards for Reggio. Here they quarrelled. Gray, "never a boy," was a student, and at times retiring; Walpole, in his way a student too, was at this time a very social being, somewhat too frivolous, and, what was worse, too patronizing. He good-humouredly said at a later date, "Gray loves to find fault," and this fault-finding was expressed, no doubt with exaggeration, in a letter to Ashton, who violated Gray's confidence. The rupture followed, and with two friends, John Chute of the Vyne, Hampshire, and the young Francis Whithed, Gray went to Venice to see the doge wed the Adriatic on Ascension Day. Thence he returned home attended only by a *laquais de voyage*, visiting once more the Grande Chartreuse where he left in the album of the brotherhood those beautiful alcaics, *O Tu senex Religio loci*, which reveal his characteristic melancholy (enhanced by solitude and estrangement) and that sense of the glory as distinct from the horror of mountain scenery to which perhaps he was the first of Englishmen to give adequate expression. On the 18th of September 1741 we find him in London, astonishing the street boys with his deep ruffles, large bag-wig and long sword,

and "mortified" under the hands of the English barber. On the 6th of November his father died; Philip Gray had, it is evident, been less savage and niggardly at last to those who were dependent upon him, and his death left his wife and son some measure of assured peace and comfort.

London was Gray's headquarters for more than a year, with occasional visits to Stoke Poges, to which his mother and Mary Antrobus had retired from business to live with their sister, Mrs Rogers. At Stoke he heard of the death of West, to whom he had sent the "Ode on Spring," which was returned to him unopened. It was an unexpected blow, shocking in all its circumstances, especially if we believe the story that his friend's frail life was brought to a close by the discovery that the mother whom he tenderly loved had been an unfaithful wife, and, as some say, poisoned her husband. About this tragedy Gray preserved a mournful silence, broken only by the pathetic sonnet, and some Latin lines, in which he laments his loss. The year 1742, was, for him, fruitful in poetic effort, of which, however, much was incomplete. The "Agrippina," the *De principis Cogitandi*, the splenetic "Hymn to Ignorance" in which he contemplates his return to the university, remain fragments; but besides the two poems already mentioned, the "Ode on a Distant Prospect of Eton College" and the "Hymn to Adversity," perhaps the most faultless of his poems, were written before the close of the summer. After hesitating between Trinity Hall and Peterhouse, he returned to the latter, probably as a fellow-commoner. He had hitherto neglected to read for a degree; he proceeded to that of LL.B. in 1744. In 1745 a reconciliation with Walpole, long desired probably on both sides, was effected through the kind offices of Chute's sister. In 1746 he spent his time between Cambridge, Stoke and London; was much with Walpole; graphically describes the trial of the Scottish rebel lords, and studied Greek with avidity; but "the muse," which by this time perhaps had stimulated him to begin the "Elegy," "has gone, and left him in much worse company." In town he finds his friends Chute and Whithed returned to England, and "saunts about" in public places with them. The year 1747 produced only the ode on Walpole's cat, and we gather that he is mainly engaged in reading with a very critical eye, and interesting himself more in the troubles of Pembroke College, in which he almost seems to live, than in the affairs of Peterhouse. In this year also he made the acquaintance of Mason, his future biographer. In 1748 the first came before the public, but anonymously, in Dodsley's *Miscellany*, in which appeared the Eton ode, the ode on spring, and that on the cat. In the same year he sent to Wharton the beginning of the didactic poem, "The Alliance of Education and Government," which remains a fragment. His aunt, Mary Antrobus, died in 1749.

There is little to break the monotony of his days till 1750; when from Stoke he sent Walpole "a thing to which he had at last put an end." The "thing" was the "Elegy." It was shown about in manuscript by his admiring friend; it was impudently pirated, and Gray had it printed by Dodsley in self-defence. Even thus it had "a pinch or two in its cradle," of which it long bore the marks. The publication led to the one incident in Gray's life which has a touch of romance. At Stoke-house had come to live the widowed Lady Cobham, who learnt that the author of the "Elegy" was her neighbour. At her instance, Lady Schaub, her visitor, and Miss Speed, her protégée, paid him a call; the poet was out, and his quiet mother and aunts were somewhat flustered at the apparition of these women of fashion, whose acquaintance Gray had already made in town. Hence the humorous "Long Story." A platonic affection sprang up between Gray and Miss Speed; rumour, upon the death of Lady Cobham, said that they were to be married, but the lady escaped this mild destiny to become the Baroness de la Peyrière, afterwards Countess Viry, and a dangerous political intriguante.

In 1753 all Gray's completed poems, except the sonnet on the death of West, were published by Dodsley in a handsome volume illustrated by Richard Bentley, the son of the celebrated master of Trinity. To these designs we owe the vermes to the artist

which were posthumously published from a MS. torn at the end. In the same year Gray's mother died and was buried in the churchyard at Stoke Poges, the scene of the "Elegy," in the same grave with Mary Antrobus. A visit to his friend Dr Wharton at Durham later in the year revives his earlier impressions of that bolder scenery which is henceforth to be in the main the framework of his muse. Already in 1752 he had almost completed "The Progress of Poesy," in which, and in "The Bard," the imagery is largely furnished forth by mountain and torrent. The latter poem long held fire; Gray was stimulated to finish it by hearing the blind Welsh harper Parry at Cambridge. Both odes were the first-fruits of the press which Walpole had set up at Strawberry Hill, and were printed together there in 1757. They are genuinely Pindaric, that is, with corresponding strophes, antistrophes and epodes. As the Greek motto prefixed to them implies, they were vocal to the intelligent only; and these at first were few. But the odes, if they did not attain the popularity of the "Elegy," marked an epoch in the history of English poetry, and the influence of "The Bard" may be traced even in that great but very fruitful imposture, the pseudo-Ossian of Macpherson. Gray yields to the impulse of the Romantic movement; he has long been an admirer of ballad poetry; before he wrote "The Bard" he had begun to study Scandinavian literature, and the two "Norse Odes," written in 1761, were in style and metrical form strangely anticipative of Coleridge and Scott. Meanwhile his Cambridge life had been vexed by the freaks of the fellow-commoners of Peterhouse, a peculiarly riotous set. He had suffered great inconvenience for a time by the burning of his property in Cornhill, and so nervous was he on the subject of fire that he had provided himself with a rope-ladder by which he might descend from his college window. Under this window a hunting-party of these rude lads raised in the early morning the cry of fire; the poet's night-capped head appeared and was at once withdrawn. This, or little more than this, was the simple fact out of which arose the legend still current at Cambridge. The servile authorities of Peterhouse treated Gray's complaints with scant respect, and he migrated to Pembroke College. "I left my lodgings," he said, "because the rooms were noisy, and the people of the house dirty."

In 1758 died Mrs Rogers, and Gray describes himself as employed at Stoke in "dividing nothing" between himself and the surviving aunt, Mrs Oliffe, whom he calls "the spawn of Cerberus and the Dragon of Wantley." In 1759 he availed himself of the MS. treasures of the British Museum, then for the first time open to the public, made a very long sojourn in town, and in 1761 witnessed the coronation of George III., of which to his friend Brown of Pembroke he wrote a very vivacious account. In his last years he revealed a craving for a life less sedentary than heretofore. He visited various picturesque districts of Great Britain, exploring great houses and ruined abbeys; he was the pioneer of the modern tourist, noting and describing in the spirit now of the poet, now of the art-critic, now of the antiquary. In 1762 he travelled in Yorkshire and Derbyshire; in 1764 in the Lowlands of Scotland, and thence went to Southampton and its neighbourhood. In 1765 he revisits Scotland; he is the guest of Lord Strathmore at Glamis; and revels in "those monstrous creatures of God," the Highland mountains. His most notable achievement in this direction was his journey among the English lakes, of which he wrote an interesting account to Wharton; and even in 1770, the year before his death, he visited with his young friend Norton Nicholls "five of the most beautiful counties of the kingdom," and descended the Wye for 40 m. In all these quests he displays a physical energy which surprises and even perplexes us. His true academic status was worthily secured in 1768, when the duke of Grafton offered him the professorship of modern history which in 1762 he had vainly endeavoured to obtain from Bute. He wrote in 1769 the "Installation Ode" upon the appointment of Grafton as chancellor of the university. It was almost the only instance in which he successfully executed a task, not, in the strictest sense, self-imposed; the great founders of the

university are tactfully memorized and pass before us in a kind of heraldic splendour. He bore with indifference the taunts to which, from Junius and others, he was exposed for this tribute to his patron. He was contemplating a journey to Switzerland to visit his youthful friend de Bonstetten when, in the summer of 1771, he was conscious of a great decline in his physical powers. He was seized with a sudden illness when dining in his college hall, and died of gout in the stomach on the 30th of July 1771. His last moments were attended by his cousin Mary Antrobus, postmistress through his influence at Cambridge and daughter of his Eton tutor; and he was laid beside his beloved mother in the churchyard of Stoke Poges.

Owing to his shyness and reserve he had few intimate friends, but to these his loss was irreparable; for to them he revealed himself either in boyish levity and banter, or wise and sympathetic counsel and tender and yet manly consolation; to them he imparted his quiet but keen observation of passing events or the stores of his extensive reading in literature ancient, medieval or modern; and with Proteus-like variety he writes at one time as a speculative philosopher, at another as a critic in art or music, at another as a meteorologist and nature-lover. His friendship with the young, after his migration to Pembroke College, is a noteworthy trait in his character. With Lord Strathmore and the Lyons and with William Falgrave he conversed as an elder brother, and Norton Nicholls of Trinity Hall lost in him a second father, who had taught him to think and feel. The brilliant young foreigner, de Bonstetten, looked back after a long and chequered career with remembrance still vivid to the days in which the poet so soon to die taught him to read Shakespeare and Milton in the monastic gloom of Cambridge. With the elderly "Levites" of the place he was less in sympathy; they dreaded his sarcastic vein; they were conscious that he laughed at them, and in the polemics of the university he was somewhat of a free lance, fighting for his own hand. Lampons of his were privately circulated with effect, and that he could be the fiercest of satirists the "Cambridge Courtship" on the candidature of Lord Sandwich for the office of high steward, and the verses on Lord Holland's mimic ruins at Westgate, sufficiently prove. The faculty which he displays in humour and satire was denied to his more serious muse; there all was the fruit of long delay; of that higher inspiration he had a thin but very precious vein, and the sublimity which he undoubtedly attained was reached by an effort of which captious and even sympathetic criticism can discover the traces. In his own time he was regarded as an innovator, for like Collins he revived the poetic diction of the past, and the adverse judgments of Johnson and others upon his work are in fact a defence of the current literary traditions. Few men have published so little to so much effect; few have attained to fame with so little ambition. His favourite maxim was "to be employed is to be happy," but he was always employed in the first instance for the satisfaction of his own soul, and to this end and no other he made himself one of the best Greek scholars at Cambridge in the interval between Bentley and Porson. His genius was receptive rather than creative, and it is to be regretted that he lacked energy to achieve that history of English poetry which he once projected, and for which he possessed far more knowledge and insight than the poet Thomas Warton, to whom he resigned the task. He had a fine taste in music, painting and architecture; and his correspondence includes a wide survey of such European literature as was accessible to him, with criticisms, sometimes indeed a little limited and insular, yet of a singularly fresh and modern cast. In person he was below the middle height, but well-made, and his face, in which the primness of his features was redeemed by his flashing eyes, was the index of his character. There was a touch of affectation in his demeanour, and he was sometimes reticent and secretive even to his best friends. He was a refined Epicurean in his habits, and a deist rather than a Christian in his religious beliefs; but his friend, Mrs Bonfoy, had "taught him to pray" and he was keenly alive to the dangers of a flippant scepticism. In a beautiful alcaic stanza he pronounces the man supremely happy who in the depths of the heart is conscious

of the "fount of tears," and his characteristic melancholy, except in the few hours when it was indeed black, was not a pitiable state; rather, it was one secret of the charm both of the man and of the poet.

A very complete bibliography of Gray will be found in Dr. Bradshaw's edition of the poems in the Aldine series. Dodsley published ten of the poems, exclusive of the "Long Story," in 1768. Mason's *Life of Gray* (1778) included the poems and some hitherto unpublished fragments, with a selection from his letters, much garbled. Mathias in 1814 reprinted Mason's edition and added much from Gray's MS. commentaries together with some more of his translations. The most exhaustive edition of Gray's writings was achieved by the Rev. John Mitford, who first did justice to the correspondence with Wharton and Norton Nicholls (5 vols., Pickering, 1836-1843; correspondence of Gray and Mason, Bentley, 1853); see also the edition of the works by Edmund Gosse (4 vols. 1884); the *Life* by the same in Eng. Men of Letters (2nd ed., 1889); some further relics are given in *Gray and His Friends* by D. C. Tovey (Cambridge, 1890); and a new edition of the letters copiously annotated by D. C. Tovey is in the Standard Library (1900-1907). Nicholl's *Illustrations*, vol. vi. p. 805, quoted by Professor Kittredge in the *Nation*, Sept. 12th, 1900, gives the true story of Gray's migration to Pembroke College. Matthew Arnold's essay on Gray in *Ward's English Poets* is one of the minor classics of literary criticism.

(D. C. To.)

GRAY (or GREY), WALTER DE (d. 1255), English prelate and statesman, was a nephew of John de Gray, bishop of Norwich, and was educated at Oxford. He owed his early and rapid preferment in church and state to the favour of King John, becoming the king's chancellor in 1205, and being chosen bishop of Lichfield in 1210. He was, however, not allowed to keep this bishopric, but he became bishop of Worcester in 1214, resigning his office as chancellor in the same year. Gray was with John when the king signed Magna Carta in June 1215; soon after this event he left England on the king's business, and it was during his absence that he was forced into the archbishopric of York, owing his election to the good offices of John and of Pope Innocent III. He took a leading part in public affairs during the minority of Henry III., and was regarded with much favour by this king, who employed him on important errands to foreign potentates, and left him as guardian of England when he went to France in 1242. Afterwards the archbishop seems to have been less favourably disposed towards Henry, and for a time he absented himself from public business; however, in 1255, he visited London to attend a meeting of parliament, and died at Fulham on the 1st of May 1255. Gray was always anxious to assert his archiepiscopal authority over Scotland, and to maintain it against the archbishop of Canterbury, but in neither case was he very successful. He built the south transept of the minster at York and bought for his see the village, afterwards called Bishopthorpe, which is still the residence of the archbishop of York. He was also generous to the church at Ripon. Gray was regarded by his contemporaries as an avaricious, but patriotic man.

GRAY, a town of eastern France, capital of an arrondissement in the department of Haute-Saône, situated on the declivity of a hill on the left bank of the Saône, 36 m. S.W. of Vesoul by the Eastern railway. Pop. (1906) 5742. The streets of the town are narrow and steep, but it possesses broad and beautiful quays and has a busy port. Three bridges, one dating from the 18th century, unite it to suburbs on the right bank of the river, on which is the railway-station from which lines branch off to Auxonne, Dijon, Besançon and Culmont-Chalindrey. The principal buildings are the Gothic church, restored in the style of the Renaissance but with a modern portal, and the hôtel de ville, built by the Spaniards in 1568. The latter building has a handsome façade decorated with columns of red granite. Gray is the seat of a subprefect and has tribunals of first instance and of commerce, a chamber of commerce, a communal college and a small museum. It has large flour-mills; among the other industries is the manufacture of machinery and iron goods. There is also a considerable transit traffic in goods from the south of France and the colonies, and trade in iron, corn, provisions, vegetables, wine, wood, &c., much of which is carried by river. Gray was founded in the 7th century. Its fortifications were destroyed by Louis XIV. During the Franco-German War

General von Werder concentrated his army corps in the town and held it for a month, making it the *point d'appui* of movements towards Dijon and Langres, as well as towards Besançon.

Gray gave its name to the distinguished English family of de Gray, Gray or Grey, Anselm de Gray being mentioned as an Oxfordshire tenant in Domesday.

GRAYLING (*Thymallus*), fishes belonging to the family *Salmonidae*. The best known are the "poisson bleu" of the Canadian voyageurs, and the European species, *Thymallus vulgaris* (the *Asch* or *Ascho* of Germany, *ombre* of France, and *temola* of Upper Italy). This latter species is esteemed on account of its agreeable colours (especially of the dorsal fin), its well-flavoured flesh, and the sport it affords to anglers. The grayling differ from the genus *Salmo* in the smaller mouth with comparatively feeble dentition, in the larger scales, and especially in the much greater development of the dorsal fin, which contains 20 to 24 rays. These beautiful fishes, of which five or six species are known, inhabit the fresh waters of Europe, Siberia and the northern parts of North America. The European species, *T. vulgaris* or *sevillifer*, attains, though rarely, a length of 2 ft. The colours during life are remarkably changeable and iridescent; small dark spots are sometimes present on the body; the very high dorsal fin is beautifully marked with purplish bands and ocelli. In England and Scotland the grayling appears to have had originally a rather irregular distribution, but it has now been introduced into a great number of rivers; it is not found in Ireland. It is more generally distributed in Scandinavia and Russia, and the mountain streams of central Europe southwards to the Alpine water of Upper Italy. Specimens attaining to a weight of 4 lb are very scarce.

GRAYS THURROCK, or **GRAYS**, an urban district in the southeastern parliamentary division of Essex, England, on the Thames, 20 m. E. by S. from London by the London, Tilbury & Southend railway. Pop. (1901) 13,834. The church of St Peter and St Paul, wholly rebuilt, retains some Norman work. The town takes its name from a family of Gray who held the manor for three centuries from 1149. There are an endowed and two training ship schools. Roman remains have been found in the vicinity; and the geological formations exhibiting the process of silting up of a former river channel are exposed in the quarries, and contain large mammalian remains. The town has trade in bricks, lime and cement.

GRAZ (GRATZ), the capital of the Austrian duchy and crownland of Styria, 140 m. S.W. of Vienna by rail. Pop. (1900) 138,370. It is picturesquely situated on both banks of the Mur, just where this river enters a broad and fertile valley, and the beauty of its position has given rise to the punning French description, *La Ville des grâces sur la rivière de l'amour*. The main town lies on the left bank of the river at the foot of the Schlossberg (1545 ft.) which dominates the town. The beautiful valley traversed by the Mur, known as the Grazer Feld and bounded by the Wildonerberge, extends to the south; to the S.W. rise the Bacher Gebirge and the Koralpen; to the N. the Schöckel (4745 ft.), and to the N.W. the Alps of Upper Styria. On the Schlossberg, which can be ascended by a cable tramway, beautiful parks have been laid out, and on its top is the bell-tower, 60 ft. high, and the quaint clock-tower, 54 ft. high, which bears a gigantic clock-dial. At the foot of the Schlossberg is the Stadtpark.

Among the numerous churches of the city the most important is the cathedral of St Aegidius, a Gothic building erected by the emperor Frederick III. in 1450-1462 on the site of a previous church mentioned as early as 1157. It has been several times modified and redecorated, more particularly in 1718. The present copper spire dates from 1663. The interior is richly adorned with stained-glass windows of modern date, costly shrines, paintings and tombs. In the immediate neighbourhood of the cathedral is the mausoleum church erected by the emperor Ferdinand II. Worthy of mention also are the parish church, a Late Gothic building, finished in 1520, and restored in 1875, which possesses an altar piece by Tintoretto; the Augustinian church, appropriated to the service of the university since 1827;

the small Leech Kirche, an interesting building in Early Gothic style, dating from the 13th century, and the Herz Jesu-Kirche, a building in Early Gothic style, finished in 1891, with a tower 360 ft. high. Of the secular buildings the most important is the Landhaus, where the local diet holds its sittings, erected in the 16th century in the Renaissance style. It possesses an interesting portal and a beautiful arcaded court, and amongst the curiosities preserved here is the Styrian hat. In its neighbourhood is the Zeughaus or arsenal, built in 1644, which contains a very rich collection of weapons of the 15th-17th centuries, and which is maintained exactly in the same condition as it was 250 years ago. The town hall, built in 1807, and rebuilt in 1892 in the German Renaissance style, and the imperial castle, dating from the 11th century, now used as government offices, are also worth notice.

At the head of the educational institutions is the university founded in 1586 by the Austrian archduke Charles Francis, and restored in 1817 after an interruption of 45 years. It is now housed in a magnificent building, finished in 1895, and is endowed with numerous scientific laboratories and a rich library. It had in 1901 a teaching staff of 161 professors and lecturers, and 1652 students, including many Italians from the Küstenland and Dalmatia. The Joanneum Museum, founded in 1811 by the archduke John Baptist, has become very rich in many departments, and an additional huge building in the rococo style was erected in 1895 for its accommodation. The technical college, founded in 1814 by the archduke John Baptist, had in 1901 about 400 pupils.

An active trade, fostered by abundant railway communications, is combined with manufactures of iron and steel wares, paper, chemicals, vinegar, physical and optical instruments, besides artistic printing and lithography. The extensive workshops of the Southern railway are at Graz, and since the opening of the railway to the rich coal-fields of Köfisch the number of industrial establishments has greatly increased.

Amongst the numerous interesting places in the neighbourhood are: the Hilmteich, with the Hilmwarte, about 100 ft. high; and the Rosenberg (1570 ft.), whence the ascent of the Platte (2136 ft.) with extensive view is made. At the foot of the Rosenberg is Maria Grün, with a large sanatorium. All these places are situated to the N. of Graz. On the left bank of the Mur is the pilgrimage church of Maria Trost, built in 1714; on the right bank is the castle of Eggenberg, built in the 17th century. To the S.W. is the Buchkogel (2150 ft.), with a magnificent view, and a little farther south is the watering-place of Tobelbad.

History.—Graz may possibly have been a Roman site, but the first mention of it under its present name is in a document of A.D. 881, after which it became the residence of the rulers of the surrounding district, known later as Styria. Its privileges were confirmed by King Rudolph I. in 1281. Surrounded with walls and fosses in 1435, it was able in 1481 to defend itself against the Hungarians under Matthias Corvinus, and in 1529 and 1532 the Turks attacked it with as little success. As early as 1530 the Lutheran doctrine was preached in Graz by Selfried and Jacob von Eggenberg, and in 1540 Eggenberg founded the Paradies or Lutheran school, in which Kepler afterwards taught. But the archduke Charles burned 20,000 Protestant books in the square of the present lunatic asylum, and succeeded by his oppressive measures in bringing the city again under the authority of Rome. From the earlier part of the 15th century Graz was the residence of one branch of the family of Habsburg, a branch which succeeded to the imperial throne in 1619 in the person of Ferdinand II. New fortifications were constructed in the end of the 16th century by Franz von Poppendorf, and in 1644 the town afforded an asylum to the family of Ferdinand III. The French were in possession of the place in 1797 and again in 1805; and in 1809 Marshal Macdonald having, in accordance with the terms of the peace of Vienna, entered the citadel which he had vainly besieged, blew it all up with the exception of the bell-tower and the citizens' or clock tower. It benefited greatly during the 19th century from the care of the archduke John and received extended civic privileges in 1860.

See Ilwof and Peters, *Graz, Geschichte und Topographie der Stadt* (Graz, 1875); G. Fels, *Graz und seine Umgebung* (Graz, 1898); L. Mayer, *Die Stadt der Grazien* (Graz, 1897), and Holrichter, *Rückblicke in die Vergangenheit von Graz* (Graz, 1885).

GRAZZINI, ANTONIO FRANCESCO (1503-1583), Italian author, was born at Florence on the 22nd of March 1503, of good family both by his father's and mother's side. Of his youth and education all record appears to be lost, but he probably began early to practise as an apothecary. In 1540 he was one of the founders of the Academy of the Humid (degli Umidi) afterwards called "della Fiorentina," and later took a prominent part in the establishment of the more famous Accademia della Crusca. In both societies he was known as *Il Lasca* or *Leuciscus*, and this pseudonym is still frequently substituted for his proper name. His temper was what the French happily call a difficult one, and his life was consequently enlivened or disturbed by various literary quarrels. His Humid brethren went so far as to expel him for a time from the society—the chief ground of offence being apparently his ruthless criticism of the "Aramcans," a party of the academicians who maintained that the Florentine or Tuscan tongue was derived from the Hebrew, the Chaldee, or some other branch of the Semitic. He was readmitted in 1566, when his friend Salvetti was "consul" of the academy. His death took place on the 18th of February 1583. *Il Lasca* ranks as one of the great masters of Tuscan prose. His style is copious and flexible; abundantly idiomatic, but without any affectation of being so, it carries with it the force and freshness of popular speech, while it lacks not at the same time a flavour of academic culture. His principal works are *La Ceme* (1756), a collection of stories in the manner of Boccaccio, and a number of prose comedies, *La Gelosia* (1568), *La Spiritata* (1561), *I Parentadi*, *La Arenga*, *La Sibilla*, *La Pinachera*, *L'Arzigogolo*. The stories, though of no special merit as far as the plots are concerned, are told with verve and interest. A number of miscellaneous poems, a few letters and *Four Orations to the Cross* complete the list of Grazzini's extant works.

He also edited the works of Berni, and collected *Tutti i trionfi, larri, mascherate, e canti carnascialeschi: andati per Firenze dal tempo del magnifico Lorenzo de' Medici fino all'anno 1559*. In 1868 Adamo Rossi published in his *Ricerca per la biblioteca di Perugia* three "novelle" by Grazzini, from a MS. of the 16th century in the "Comunale" of Perugia; and in 1870 a small collection of those poems which have been left unpublished by previous editors appeared at Poggibonsi, *Alcune Poesie inedite*. See Pietro Fanfani's "Vita del Lasca," prefixed to his edition of the *Opere di A. Grazzini* (Florence, 1857).

GREAT AWAKENING, the name given to a remarkable religious revival centring in New England in 1740-1743, but covering all the American colonies in 1740-1750. The word "awakening" in this sense was frequently (and possibly first) used by Jonathan Edwards at the time of the Northampton revival of 1734-1735, which spread through the Connecticut Valley and prepared the way for the work in Rhode Island, Massachusetts and Connecticut (1740-1741) of George Whitefield, who had previously been preaching in the South, especially at Savannah, Georgia. He, his immediate follower, Gilbert Tennent (1703-1764), other clergymen, such as James Davenport, and many untrained hymen who took up the work, agreed in the emotional and dramatic character of their preaching, in rousing their hearers to a high pitch of excitement, often amounting to frenzy, in the undue stress they put upon "bodily effects" (the physical manifestations of an abnormal psychic state) as proofs of conversion, and in their unrestrained attacks upon the many clergymen who did not join them and whom they called "dead men," unconverted, unregenerate and careless of the spiritual condition of their parishes. Jonathan Edwards, Benjamin Colman (1673-1747), and Joseph Bellamy, recognized the viciousness of so extreme a position. Edwards personally reprimanded Whitefield for presuming to say of any one that he was unconverted, and in his *Thoughts Concerning the Present Revival of Religion* devoted much space to "showing what things are to be corrected, or avoided, in promoting this work." Edwards' famous sermon at Enfield in 1741 so affected his audience that they cried and groaned aloud, and he found

It necessary to bid them be still that he might go on; but Davenport and many itinerants provoked and invited shouting and even writhing, and other physical manifestations. At its May session in 1742 the General Court of Massachusetts forbade itinerant preaching save with full consent from the resident pastor; in May 1743 the annual ministerial convention, by a small plurality, declared against "several errors in doctrine and disorders in practice which have of late obtained in various parts of the land," against lay preachers and disorderly revival meetings; in the same year Charles Chauncy, who disapproved of the revival, published *Seasonable Thoughts on the State of Religion in New England*; and in 1744-1745 Whitefield, upon his second tour in New England, found that the faculties of Harvard and Yale had officially "testified" and "declared" against him and that most pulpits were closed to him. Some separatist churches were formed as a result of the Awakening; these either died out or became Baptist congregations. To the reaction against the gross methods of the revival has been ascribed the religious apathy of New England during the last years of the 18th century; but the martial and political excitement, beginning with King George's War (*i.e.* the American part of the War of the Austrian Succession) and running through the American War of Independence and the founding of the American government, must be reckoned at the least as contributing causes.

See Joseph Tracy, *The Great Awakening* (Boston, 1842); Samuel P. Hayes, "An Historical Study of the Edwardian Revivals," in *The American Journal of Psychology*, vol. 13 (Worcester, Mass., 1902); and Frederick M. Davenport, *Primitive Traits in Religious Revivals* (New York, 1905), especially chapter viii. pp. 94-131.
(R. W. E.)

GREAT BARRIER REEF, a vast coral reef extending for 1200 m. along the north-east coast of Australia (*q.v.*). The channel within it is protected from heavy seas by the reef, and is a valuable route of communication for coasting steamers. The reef itself is also traversed by a number of navigable passages.

GREAT BARRINGTON, a township of Berkshire county, Massachusetts, U.S.A., on the Housatonic river, in the Berkshire hills, about 25 m. S.W. of Pittsfield. Pop. (1890) 4612; (1900) 5854, of whom 1187 were foreign-born; (1910 census) 5926. Its area is about 45 sq. m. The township is traversed by a branch of the New York, New Haven & Hartford railroad, and the Berkshire Street railway (controlled by the N.Y., N.H. & H.). has its southern terminus here. Within the township are three villages—Great Barrington (the most important), Housatonic and Van Deusenville; the first two are about 5 m. apart. The village of Great Barrington, among the hills, is well known as a summer resort. The Congregational church with its magnificent organ (3954 pipes) is worthy of mention. There is a public library in the village of Great Barrington and another in the village of Housatonic. Monument Mt. (1710 ft.), partly in Stockbridge, commands a fine view of the Berkshires and the Housatonic Valley. The Sedgwick School (for boys) was removed from Hartford, Connecticut, to Great Barrington in 1869. There are various manufactures, including cotton-goods (in the village of Housatonic), and electric meters, paper, knit goods and counterpanes (in the village of Great Barrington); and marble and blue stone are quarried here; but the township is primarily given over to farming. The fair of the Housatonic Agricultural Society is held here annually during September; and the district court of South Berkshire sits here. The township was incorporated in 1761, having been, since 1743, the "North Parish of Sheffield"; the township of Sheffield, earlier known as the "Lower Housatonic Plantation" was incorporated in 1733. Great Barrington was named in honour of John Shute (1678-1734), Viscount Barrington of Ardglass (the adjective "Great" being added to distinguish it from another township of the same name). In 1761-1787 it was the shire-town. Great Barrington was a centre of the disaffection during Shays's rebellion, and on the 12th of September 1786 a riot here prevented the sitting of court. Samuel Hopkins, one of the most eminent of American theologians, was pastor here in 1743-1769; General Joseph Dwight (1703-1765), a merchant, lawyer and

brigadier-general of Massachusetts militia, who took part in the Louisburg expedition in 1745 and later in the French and Indian War, lived here from 1758 until his death; and William Cullen Bryant lived here as a lawyer and town clerk in 1816-1825. See C. J. Taylor, *History of Great Barrington* (Great Barrington, 1882).

GREAT BASIN, an area in the western Cordilleran region of the United States of America, about 200,000 sq. m. in extent, characterized by wholly interior drainage, a peculiar mountain system and extreme aridity. Its form is approximately that of an isosceles triangle, with the sharp angle extending into Lower California, W. of the Colorado river; the northern edge being formed by the divide of the drainage basin of the Columbia river, the eastern by that of the Colorado, the western by the central part of the Sierra Nevada crest, and by other high mountains. The N. boundary and much of the E. is not conspicuously uplifted, being plateau, rather than mountain. The W. half of Utah, the S.W. corner of Wyoming, the S.E. corner of Idaho, a large area in S.E. Oregon, much of S. California, a strip along the E. border of the last-named state, and almost the whole of Nevada are embraced within the limits of the Great Basin.

The Great Basin is not, as its name implies, a topographic cup. Its surface is of varied character, with many independent closed basins draining into lakes or "playas," none of which, however, has outlet to the sea. The mountain chains, which from their peculiar geologic character are known as of the "Basin Range type" (not exactly continuous in distribution with the Basin), are echeloned in short ranges running from N. to S. Many of them are fault block mountains, the crust having been broken and the blocks tilted so that there is a steep face on one side and a gentle slope on the other. This is the Basin Range type of mountain. These mountains are among the most recent in the continent, and some of them, at least, are still growing. In numerous instances clear evidence of recent movements along the fault planes has been discovered; and frequent earthquakes testify with equal force to the present uplift of the mountain blocks. The valleys between the tilted mountain blocks are smooth and often trough-like, and are often the sites of shallow salt lakes or playas. By the rain wash and wind action detritus from the mountains is carried to these valley floors, raising their level, and often burying low mountain spurs, so as to cause neighbouring valleys to coalesce. The plateau "lowlands" in the centre of the Basin are approximately 5000 ft. in altitude. Southward the altitude falls, Death valley and Coahuila valley being in part below the level of the sea. The whole Basin is marked by three features of elevation—the Utah basin, the Nevada basin and, between them, the Nevada plateau.

Over the lowlands of the Basin, taken generally, there is an average precipitation of perhaps 6-7 in., while in the Oregon region it is twice as great, and in the southern parts even less. The mountains receive somewhat more. The annual evaporation from water surfaces is from 60 to 150 in. (60 to 80 on the Great Salt Lake). The reason for the arid climate differs in different sections. In the north it is due to the fact that the winds from the Pacific lose most of their moisture, especially in winter, on the western slopes of the Sierra Nevada; in the south it is due to the fact that the region lies in a zone of calms, and light, variable winds. Precipitation is largely confined to local showers, often of such violence as to warrant the name "cloud bursts," commonly applied to the heavy down-pours of this desert region. It is these heavy rains, of brief duration, when great volumes of water rapidly run off from the barren slopes, that cause the deep channels, or arroyos, which cross the desert. Permanent streams are rare. Many mountains are quite without perennial streams, and some lack even springs. Few of the mountain creeks succeed in reaching the arid plains, and those that do quickly disappear by evaporation or by seepage into the gravels. In the N.W. there are many permanent lakes without outlet fed by the mountain streams; others, snow fed, occur among the Sierra Nevada; and some in the larger mountain masses of the middle region. Almost all are saline. The largest

of all, Great Salt Lake, is maintained by the waters of the Wasatch and associated plateaus. No lakes occur south of Owens in the W. and Sevier in the E. (39°); evaporation below these limits is supreme. Most of the small closed basins, however, contain "playas," or alkali mud flats, that are overflowed when the tributary streams are supplied with storm water.

Save where irrigation has reclaimed small areas, the whole region is a vast desert, though locally only some of the interior plains are known as "deserts." Such are the Great Salt Lake and Carson deserts in the north, the Mohave and Colorado and Amargosa (Death Valley) deserts of the south-west. Straggling forests, mainly of conifers, characterize the high plateaus of central Utah. The lowlands and the lower mountains, especially southward, are generally treeless. Cottonwoods line the streams, salt-loving vegetation margins the bare playas, low bushes and scattered bunch-grass grow over the lowlands, especially in the north. Gray desert plants, notably cactuses and other thorny plants, partly replace in the south the bushes of the north. Except on the scattered oases, where irrigation from springs and mountain streams has reclaimed small patches, the desert is barren and forbidding in the extreme. There are broad plains covered with salt and alkali, and others supporting only scattered bunch grass, sage bush, cactus and other arid land plants. There are stony wastes, or alluvial fans, where mountain streams emerge upon the plains, in time of flood, bringing detritus in their torrential courses from the mountain canyons and depositing it along the mountain base. The barrenness extends into the mountains themselves, where there are bare rock cliffs, stony slopes and a general absence of vegetation. With increasing altitude vegetation becomes more varied and abundant, until the tree limit is reached; then follows a forest belt, which in the highest mountains is limited above by cold as it is below by aridity.

The successive explorations of B. L. E. Bonneville, J. C. Fremont and Howard Stansbury (1806-1863) furnished a general knowledge of the hydrographic features and geological lacustrine history of the Great Basin, and this knowledge was rounded out by the field work of the U.S. Geological Survey from 1879 to 1883, under the direction of Grove Karl Gilbert. The mountains are composed in great part of Paleozoic strata, often modified by vulcanism and greatly denuded and sculptured by wind and water erosion. The climate in late geologic time was very different from that which prevails to-day. In the Pleistocene period many large lakes were formed within the Great Basin; especially, by the fusion of small catchment basins, two great confluent bodies of water—Lake Lahontan (in the Nevada basin) and Lake Bonneville (in the Utah basin). The latter, the remnants of which are represented to-day by Great Salt, Sevier and Utah Lakes, had a drainage basin of some 54,000 sq. m.

See G. K. Gilbert in Wheeler Survey, *U.S. Geographical Survey West of the Hundredth Meridian*, vol. iii; Clarence King and others in the *Report of the Fortieth Parallel Survey* (U.S. Geol. Exploration of the Fortieth Parallel); G. K. Gilbert's *Lake Bonneville* (U.S. Geological Survey, *Monographs*, No. 1, 1890), also I. C. Russell's *Lake Lahontan* (Same, No. 11, 1885), with references to other publications of the Survey. For reference to later geological literature, and discussion of the Basin Ranges, see J. E. Spurr, *Bull. Geol. Soc. Amer.* vol. 12, 1901, p. 217; and G. D. Louderback, same, vol. 15, 1904, p. 280; also general bibliographies issued by the U.S. Geol. Survey (e.g. *Bull.* 301, 372 and 409).

GREAT BEAR LAKE, an extensive sheet of fresh water in the north-west of Canada, between 65° and 67° N., and 117° and 123° W. It is of very irregular shape, has an estimated area of 11,200 sq. m., a depth of 270 ft., and is upwards of 200 ft. above the sea. It is 175 m. in length, and from 25 to 45 in breadth, though the greatest distance between its northern and southern arms is about 180 m. The Great Bear river discharges its waters into the Mackenzie river. It is full of fish, and the neighbouring country, though barren and uncultivated, contains quantities of game.

GREAT CIRCLE. The circle in which a sphere is cut by a plane is called a "great circle," when the cutting plane passes through the centre of sphere. Treating the earth as a sphere,

the meridians of longitude are all great circles. Of the parallels of latitude, the equator only is a great circle. The shortest line joining any two points is an arc of a great circle. For "great circle sailing" see NAVIGATION.

GREAT FALLS, a city and the county-seat of Cascade county, Montana, U.S.A., 99 m. (by rail) N.E. of Helena, on the S. bank of the Missouri river, opposite the mouth of the Sun river, at an altitude of about 3300 ft. It is 10 m. above the Great Falls of the Missouri, from which it derives its name. Pop. (1890) 3979; (1900) 14,930, of whom 4692 were foreign-born; (1910 census) 13,948. It has an area of about 8 sq. m. It is served by the Great Northern and the Billings & Northern (Chicago, Burlington & Quincy system) railways. The city has a splendid park system of seven parks (about 530 acres) with 15 m. of boulevards.¹ Among the principal buildings are a city hall, court house, high school, commercial college, Carnegie library, the Columbus Hospital and Training School for Nurses (under the supervision of the Sisters of Charity), and the Montana Deaconess hospital. There is a Federal land office in the city. Great Falls lies in the midst of a region exceptionally rich in minerals—copper, gold, silver, lead, iron, gypsum, limestone, sapphires and bituminous coal being mined in the neighbourhood. Much grain is grown in the vicinity, and the city is an important shipping point for wool, live-stock and cereals. Near Great Falls the Missouri river, within 7½ m., contracts from a width of about 900 to 300 yds. and falls more than 500 ft., the principal falls being the Black Eagle Falls (50 ft.), from which power is derived for the city's street railway and lighting plant, the beautiful Rainbow Falls (48 ft.) and Great Falls (92 ft.). Giant Spring Fall, about 20 ft. high, is a cascade formed by a spring on the bank of the river near Rainbow Falls. The river furnishes very valuable water-power, partly utilized by large manufacturing establishments, including flour mills, plaster mills, breweries, iron works, mining machinery shops, and smelting and reduction works. The Boston & Montana copper smelter is one of the largest in the world; it has a chimney stack 506 ft. high, and in 1908 employed 1200 men in the smelter and 2500 in its mining department. Great Falls ranked second (to Anaconda) among the cities of the state in the value of the factory product of 1905, which was \$13,291,979, showing an increase of 42.4% since 1900. The city owns and operates its water-supply system. Great Falls was settled in 1884, and was chartered as a city in 1888.

GREAT HARWOOD, an urban district in the Darwen parliamentary division of Lancashire, England, 4½ m. N.E. of Blackburn, on the Lancashire and Yorkshire railway. Pop. (1901) 12,015. It is of modern growth, a township of cotton operatives, with large collieries in the vicinity. An agricultural society is also maintained.

GREATHEAD, JAMES HENRY (1844-1896), British engineer, was born at Grahamstown, Cape Colony, on the 6th of August 1844. He migrated to England in 1859, and in 1864 was a pupil of P. W. Barlow, from whom he became acquainted with the shield system of tunnelling with which his name is especially associated. Barlow, indeed, had a strong belief in the shield, and was the author of a scheme for facilitating the traffic of London by the construction of underground railways running in cast-iron tubes constructed by its aid. To show what the method could do, it was resolved to make a subway under the Thames near the Tower, but the troubles encountered by Sir M. I. Brunel in the Thames Tunnel, where also a shield was employed, made engineers hesitate to undertake the subway, even though it was of very much smaller dimensions (6 ft. 7 in.

¹ Great Falls was a pioneer among the cities of the state in the development of a park system. When the city was first settled its site was a "barren tract of sand, thinly covered with buffalo-grass and patches of sage brush." The first settler, Paris Gibson, of Minneapolis, began the planting of trees, which, though not indigenous, grew well. The city's sidewalks are bordered by strips of lawn, in which there is a row of trees, and the city maintains a large nursery where trees are grown for this purpose. A general state law (1901) placing the parking of cities on a sound financial basis is due very largely to the impulse furnished by Great Falls. See an article, "Great Falls, the Pioneer Park City of Montana," by C. H. Forbes-Lindsay, in the *Craftsman* for November 1908.

internal diameter) than the tunnel. At this juncture Greathead came forward and offered to take up the contract; and he successfully carried it through in 1869 without finding any necessity to resort to the use of compressed air, which Barlow in 1867 had suggested might be employed in water-bearing strata. After this he began to practise on his own account, and mainly divided his time between railway construction and taking out patents for improvements in his shield, and for other inventions such as the "Ejector" fire-hydrant. Early in the 'eighties he began to work in conjunction with a company whose aim was to introduce into London from America the Hallidie system of cable traction, and in 1884 an act of Parliament was obtained authorizing what is now the City & South London Railway—a tube-railway to be worked by cables. This was begun in 1886, and the tunnels were driven by means of the Greathead shield, compressed air being used at those points where water-bearing gravel was encountered. During the progress of the works electrical traction became so far developed as to be superior to cables; the idea of using the latter was therefore abandoned, and when the railway was opened in 1890 it was as an electrical one. Greathead was engaged in two other important underground lines in London—the Waterloo & City and the Central London. He lived to see the tunnels of the former completed under the Thames, but the latter was scarcely begun at the time of his death, which happened at Streatham, in the south of London, on the 21st of October 1896.

GREAT LAKES OF NORTH AMERICA, THE. The connected string of five fresh-water inland seas, Lakes Superior, Michigan, Huron, Erie and Ontario, lying in the interior of North America, between the Dominion of Canada on the north and the United States of America on the south, and forming the head-waters of the St Lawrence river system, are collectively and generally known as "The Great Lakes." From the head of lake Superior these lakes are navigable to Buffalo, at the foot of lake Erie, a distance of 1023 m., for vessels having a draught of 20 ft.; from Buffalo to Kingston, 191 m. farther, the draught is limited, by the depth in the Welland canal, to 14 ft.; lake Superior, the largest and most westerly of the lakes, empties, through the river St Mary, 55 m. long, into lake Huron. From Point Iroquois, which may be considered the foot of the lake, to Sault Ste Marie, St Mary's Falls, St Mary's Rapids or the Soo, as it is variously called, a distance of 14 m., there is a single channel, which has been dredged by the United States government, at points which required deepening, to give a minimum width of 800 ft. and a depth of 23 ft. at mean stage water. Below the Sault, the river, on its course to lake Huron, expands into several lakes, and is divided by islands into numerous contracted passages. There are two navigated channels; the older one, following the international boundary-line by way of lake George,

19½ ft., the height varying as the lakes change in level. The enormous growth of inter-lake freight traffic has justified the construction of three separate locks, each overcoming the rapids by a single lift—two side by side on the United States and one on the Canadian side of the river. These locks, the largest in the world, are all open to Canadian and United States vessels alike, and are operated free from all taxes or tolls on shipping. The Canadian ship canal, opened to traffic on the 9th of September 1895, was constructed through St Mary Island, on the north side of the rapids, by the Canadian government, at a cost of \$3,684,227, to facilitate traffic and to secure to Canadian vessels an entrance to lake Superior without entering United States territory. The canal is 5967 ft. long between the extremities of the entrance piers, has one lock 900 ft. long and 60 ft. wide, with a depth on the sills at the lowest known water-level of 20½ ft. The approaches to the canal are dredged to 18 ft. deep, and are well buoyed and lighted. On the United States side of the river the length of the canal is 1½ m., the channel outside the locks having a width varying from 108 to 600 ft. and depth of 25 ft. The locks of 1855 were closed in 1886, to give place to the Poe lock. The Weitzel lock, opened to navigation on the 1st of September 1881, was built south of the old locks, the approach being through the old canal. Its chamber is 515 ft. long between lock gates, and 80 ft. wide, narrowing to 60 ft. at the gates. The length of the masonry walls is 717 ft., height 39½ ft., with 17 ft. over mitre sills at mean stage of water. The Poe lock, built because the Weitzel lock, large and fully equipped as it is, was insufficient for the rapidly growing traffic, was opened on the 3rd of August 1896. Its length between gates is 800 ft.; width 100 ft.; length of masonry walls 1100 ft.; height 43½ to 45 ft., with 22 ft. on the mitre sill at mean stage.

The expenditure by the United States government on the canal, with its several locks, and on improving the channel through the river, aggregated fourteen million dollars up to the end of 1906.¹ Plans were prepared in 1907 for a third United States lock with a separate canal approach.

The canals are closed every winter, the average date of opening up to 1893 being the 1st of May, and of closing the 1st of December. The pressure of business since that time, aided possibly by some slight climatic modification, has extended the season, so that the average date of opening is now ten days earlier and of closing twelve days later. The earliest opening was in 1902 on the 1st of April, and the latest closing in 1904 on the 20th of December.

The table below gives the average yearly commerce for periods of five years, and serves to show the rapid increase in freight growth.

Around the canals have grown up two thriving towns, one on the Michigan, the other on the Ontario side of the river, with manufactories driven by water-power derived from the Sault.

Statement of the commerce through the several Sault Ste Marie canals, averaged for every five years.²

Years.	Passages.	Registered Tonnage.	Passengers.	Coal. Net Tons.	Flour. Barrels.	Wheat. Bushels.	Other Grains. Bushels.	General Merchandise. Net Tons.	Salt. Barrels.	Iron Ore. Net Tons.	Lumber. M. ft. B.M.	Total Freight. Net Tons.
1855-1859	387	192,207	6,206	4,672	19,555	None.	34,612	2,249	1,248	27,206	320	55,797
1880-1884	4,457	2,267,166	34,607	463,431	681,726	5,435,601	936,346	81,966	107,225	867,999	79,144	2,184,731
1885-1889	7,908	4,901,105	29,434	1,398,441	1,838,325	18,438,085	1,213,815	74,447	175,725	2,497,403	197,605	5,441,297
1890-1894	11,965	9,912,589	24,609	2,678,805	5,764,766	34,875,971	1,738,706	87,540	231,178	4,939,909	510,482	10,627,349
1895-1899	18,352	18,451,447	40,289	3,270,842	8,319,699	57,227,269	23,349,134	164,426	282,156	10,728,075	832,968	19,354,974
1890-1904	19,374	26,199,795	54,093	5,457,019	7,021,839	56,269,265	26,760,533	646,277	407,263	20,020,487	999,944	31,245,565
1906 alone	22,155	41,098,324	63,033	8,739,630	6,495,350	84,271,358	54,343,155	1,134,851	468,162	35,357,042	900,631	51,751,080

has a width of 150 to 300 ft., and a depth of 17 ft.; it is buoyed but not lighted, and is not capable of navigation by modern large freighters; the other, some 12 m. shorter, an artificial channel dredged by the United States government in their own territory, has a minimum width of 300 ft. and depth of 20 ft. It is elaborately lighted throughout its length. A third channel, west of all the islands, was designed for steamers bound down, the older channel being reserved for upbound boats.

Between lake Superior and lake Huron there is a fall of 20 ft. of which the Sault, in a distance of ½ m., absorbs from 18 to

The outlet of lake Michigan, the only lake of the series lying wholly in United States territory, is at the Strait of Mackinac, near the point where the river St Mary reaches lake Huron. With lake Michigan are connected the Chicago Sanitary and Ship canal, the Illinois and Michigan, and the Illinois and Mississippi canals, for which see ILLINOIS. With lake Huron is always

¹ Statistical report of lake commerce passing through canals. Col. Chas. E. L. B. Davis, U.S.A., engineer in charge, 1907.

² Statistical report of lake commerce passing through canals, published annually by the U.S. engineer officer in charge.

³ The first five years of operation.

included Georgian Bay as well as the channel north of Manitoulin Island. As it is principally navigated as a connecting waterway between lakes Superior and Michigan and lake Erie it has no notable harbours on it. It empties into lake Erie through the river St. Clair, lake St. Clair and the river Detroit. On these connecting waters are several important manufacturing and shipping towns, and through this chain passes nearly all the traffic of the lakes, both that to and from lake Michigan ports, and also that of lake Superior. The tonnage of a single short season of navigation exceeds in the aggregate 60,000,000 tons. Extensive dredging and embankment works have been carried on by the United States government in lake St. Clair and the river Detroit, and a 20-ft. channel now exists, which is being constantly improved. Lake St. Clair is nearly circular, 25 m. in diameter, with the north-east quadrant filled by the delta of the river St. Clair. It has a very flat bottom with a general depth of only 21 ft., shoaling very gradually, usually to red beds that line the low swampy shores. To enter the lake from river St. Clair two channels have been provided, with retaining walls of cribwork, one for upward, the other for downward bound vessels. Much dredging has also been necessary at the outlet of the lake into river Detroit. A critical point in that river is at Limekiln crossing, a cut dredged through limestone rock above the Canadian town of Amherstburg. The normal depth here before improvement was 12½-15 ft.; by a project of 1902 a channel 600 ft. wide and 21 ft. deep was planned; there are separate channels for up- and down-bound vessels. To prevent vessels from crowding together in the cut, the Canadian government maintains a patrol service here, while the United States government maintains a similar patrol in the St. Mary channel.

The Grand Trunk railway opened in 1891 a single track tunnel under the river St. Clair, from Sarnia to Port Huron. It is 6026 ft. long, a cylinder 20 ft. in diameter, lined with cast iron in flanged sections. A second tunnel was undertaken between Detroit and Windsor, under the river Detroit.

From Buffalo, at the foot of lake Erie, the river Niagara runs northwards 36 m. into lake Ontario. To overcome the difference of 327 ft. in level between lakes Erie and Ontario, the Welland canal, accommodating vessels of 255 ft. in length, with a draught of 14 ft., was built, and is maintained by Canada. The Murray canal extends from Presqu'île Bay, on the north shore of lake Ontario, a distance of 6½ m., to the headquarters of the Bay of Quinte. Trent canal is a term applied to a series of water stretches in the interior of Ontario which are ultimately designed to connect lake Huron and lake Ontario. At Peterboro a hydraulic balance-lock with a lift of 65 ft., 140 ft. in length and 33 ft. clear in width, allowing a draught of 8 ft., has been constructed. The ordinary locks are 134 by 33 ft. with a draught of 6 ft. When the whole route of 200 m. is completed, there will not be more than 15 m. of actual canal, the remaining portion of the waterway being through lakes and rivers. For the Erie canal, between that lake and the Hudson river, see Erie and New York.

The population of the states and provinces bordering on the Great Lakes is estimated to be over 35,000,000. In Pennsylvania and Ohio, south of lake Erie, there are large coal-fields. Surrounding lake Michigan and west of lake Superior are vast grain-growing plains, and the prairies of the Canadian north-west are rapidly increasing the area and quantity of wheat grown; while both north and south of lake Superior are the most extensive iron mines in the world, from which 35 million tons of ore were shipped in 1906. The natural highway for the shipment of all these products is the Great Lakes, and over them coal is distributed westwards and grain and iron ore are concentrated eastwards. The great quantity of coarse freights, that could only be profitably carried long distances by water, has revolutionized the type of vessel used for its transportation, making large steamers imperative, consolidating interests and cheapening methods. It is usual for the vessels in the grain trade and in the iron-ore trade to make their up trips empty; but in consequence of the admirable facilities provided at terminal points, they make very fast time, and carry freight very

cheaply. The cost of freight per ton-mile fell from 23/100 cent in 1887 to 8/100 cent in 1898; since then the rate has slightly risen, but keeps well below 1/10 cent per ton-mile.

The traffic on the lakes may be divided into three classes, passenger, package freight and bulk freight. Of passenger boats the largest are 380 ft. long by 44 ft. beam, having a speed of over 20 m. an hour, making the round trip between Buffalo and Chicago 1800 m., or Buffalo and Duluth 2000 m., every week. They carry no freight. The Canadian Pacific railway runs a line of fine Tyne-built passenger and freight steamers between Owen Sound and Fort William, and these two lines equal in accommodation transatlantic passenger steamers. On lake Michigan many fine passenger boats run out of Chicago, and on lake Ontario there are several large and fast Canadian steamers on routes radiating from Toronto. The package freight business, that is, the transportation of goods in enclosed parcels, is principally local; all the through business of this description is controlled by lines run by the great trunk railways, and is done in boats limited in beam to 50 ft. to admit them through bridges over the rivers at Chicago and Buffalo. By far the greatest number of vessels on the lakes are bulk freighters, and the conditions of the service have developed a special type of vessel. Originally sailing vessels were largely used, but these have practically disappeared, giving place to steamers, which have grown steadily in size with every increase in available draught. In 1894 there was no vessel on the lakes with a capacity of over 5000 tons; in 1906 there were 254 vessels of a greater capacity, 12 of them carrying over 12,000 tons each. For a few years following 1890 many large barges were built, carrying up to 8000 tons each, intended to be towed by a steamer. It was found, however, that the time lost by one boat of the pair having to wait for the other made the plan unprofitable and no more were built. Following 1888 some 40 whale-back steamers and barges, having oval cross-sections without frames or decks, were built, but experience failed to demonstrate any advantage in the type, and their construction has ceased. The modern bulk freighter is a vessel 600 ft. long, 58 ft. beam, capable of carrying 14,000 tons on 20 ft. draught, built with a midship section practically rectangular, the coefficient frequently as high as .98, with about two-thirds of the entire length absolutely straight, giving a block coefficient up to .87. The triple-expansion machinery and boilers, designed to drive the boat at a speed of 12 m. an hour, are in the extreme stern, and the pilot house and quarters in the extreme bow, leaving all the cargo space together. Hatches are spaced at multiples of 12 ft. throughout the length and are made as wide as possible athwartships to facilitate loading and unloading. The vessels are built on girder frames and fitted with double bottoms for strength and water ballast. This type of vessel can be loaded in a few minutes, and unloaded by self-filling grab buckets up to ten tons capacity, worked hydraulically, in six or eight hours. The bulk freight generally follows certain well-defined routes; iron ore is shipped east from ports on both sides of lake Superior and on the west side of lake Michigan to rail shipping points on the south shore of lake Erie. Wheat and other grains from Duluth find their way to Buffalo, as do wheat, corn (maize) and other grains from Chicago. Wheat from the Canadian north-west is distributed from Fort William and Port Arthur to railway terminals on Georgian Bay, to Buffalo, and to Port Colborne for trans-shipment to canal barges for Montreal, and coal is distributed from lake Erie to all western points. The large shipping trade is assisted by both governments by a system of aids to navigation that mark every channel and danger. There are also life-saving stations at all dangerous points.

The Great Lakes never freeze over completely, but the harbours and often the connecting rivers are closed by ice. The navigable season at the Sault is about 7½ months; in lake Erie it is somewhat longer. The season of navigation has been slightly lengthened since 1905, by using powerful tugs as ice-breakers in the spring and autumn, the Canadian government undertaking the service at Canadian terminal ports, chiefly at Fort William and Port Arthur, the most northerly ports, where the season

is naturally aboast, and the Lake Carriers' Association, a federation of the freighting steamship owners, acting in the river St. Mary. Car ferries run through the winter across lake Michigan and the Strait of Mackinac, across the rivers St. Clair and Detroit, and across the middle of lakes Erie and Ontario. The largest of these steamers is 350 ft. long by 56 ft. wide, draught 14 ft., horse power 3500, speed 13 knots. She carries on four tracks 30 freight cars, with 1,350 tons of freight. Certain passenger steamers run on lake Michigan, from Chicago north, all the winter.

The level of the lakes varies gradually, and is affected by the general character of the season, and not by individual rainfalls. The variations of level of the several lakes do not necessarily synchronize. There is an annual fluctuation of about 1 ft. in the upper lakes, and in some seasons over 2 ft. in the lower lakes; the lowest point being at the end of winter and the highest in midsummer. In lake Michigan the level has ranged from a maximum in the years 1859, 1876 and 1886, to a minimum nearly 5 ft. lower in 1896. In lake Ontario there is a range of 5½ ft. between the maximum of May 1870 and the minimum of November 1895. In consequence of the shallowness of lake Erie, its level is seriously disturbed by a persistent storm; a westerly gale lowers the water at its upper end exceptionally as much as 7 ft., seriously interfering with the navigation of the river Detroit, while an easterly gale produces a similar effect at Buffalo. (For physiographical details see articles on the several lakes, and UNITED STATES.)

There is geological evidence to show that the whole basin of the lakes has in recent geological times gradually changed in level, rising to the north and subsiding southwards; and it is claimed that the movement is still in gradual progress, the rate assigned being .42 ft. per 100 m. per century. The maintenance of the level of the Great Lakes is a matter of great importance to the large freight boats, which always load to the limit of depth at critical points in the dredged channels or in the harbours. Fears have been entertained that the water power canals at Sault Ste Marie, the drainage canal at Chicago and the dredged channel in the river Detroit will permanently lower the levels respectively of lake Superior and of the Michigan-Huron-Erie group. An international deep-waterway commission exists for the consideration of this question, and army engineers appointed by the United States government have worked on the problem.¹ Wing dams in the rivers St. Mary and Niagara, to retard the discharges, have been proposed as remedial measures. The Great Lakes are practically tideless, though some observers claim to find true tidal pulsations, said to amount to 3½ in. at spring tide at Chicago. Secondary undulations of a few minutes in period, ranging from 1 to 4 in., are well marked.

The Great Lakes are well stocked with fish of commercial value. These are largely gathered from the fishermen by steam tenders, and taken fresh or in frozen condition to railway distributing points. In lakes Superior and Huron salmon-trout (*Salvelinus namaycush*, Walb) are commercially most important. They ordinarily range from 10 to 50 lb in weight, and are often larger. In Georgian Bay the catches of whitefish (*Coregonus clupeiformis*, Mitchell) are enormous. In lake Erie whitefish, lesser whitefish, erroneously called lake-herring (*C. artedii*, Le Sueur), and sturgeon (*Acipenser rubicundus*, Le Sueur) are the most common. There is good angling at numerous points on the lakes and their feeders. The river Nipigon, on the north shore of lake Superior, is famous as a stream abounding in speckled trout (*Salvelinus fontinalis*, Mitchell) of unusual size. Black bass (*Micropterus*) are found from Georgian Bay to Montreal, and the maskinonge (*Esox nobilior*, Le Sueur), plentiful in the same waters, is a very game fish that often attains a weight of 70 lb.

BIBLIOGRAPHY.—E. Channing and M. F. Lansing, *Story of the Great Lakes* (New York, 1909), for an account of the lakes in history; and for shipping, &c., J. O. Curwood, *The Great Lakes* (New York, 1909); U. S. Hydrographic office publication, No. 108, "Sailing directions for the Great Lakes," Navy Department (Washington, 1901, seq.); *Bulletin No. 17*, "Survey of Northern and North-western Lakes," Corps of Engineers, U. S. War Department, U. S.

¹ Report of the Chief of Engineers, U. S. Army, in *Report of War Department, U. S.* 1898, p. 3776.

Lake Survey Office (Detroit, Mich., 1907); *Annual reports of Canadian Department of Marine and Fisheries* (Ottawa, 1868 seq.) (W. P. A.)

GREAT MOTHER OF THE GODS, the ancient Oriental-Greek-Roman deity commonly known as Cybele (*q.v.*) in Greek and Latin literature from the time of Pindar. She was also known under many other names, some of which were derived from famous places of worship: as Dindymene from Mt. Dindymon, Mater Idaea from Mt. Ida, Sipylus from Mt. Sipylus, Agdistis from Mt. Agdistis or Agdus, Mater Phrygia from the greatest stronghold of her cult; while others were reflections of her character as a great nature goddess: e.g. Mountain Mother, Great Mother of the Gods, Mother of all Gods and all Men. As the great Mother deity whose worship extended throughout Asia Minor she was known as Mā or Ammas. Cybele is her favourite name in ancient and modern literature, while Great Mother of the Gods, or Great Idaean Mother of the Gods (*Mater Deum Magna, Mater Deum Magna Idaea*), the most frequently recurring epigraphical title, was her ordinary official designation.

The legends agree in locating the rise of the worship of the Great Mother in Asia Minor, in the region of loosely defined geographical limits which comprised the Phrygian empire of prehistoric times, and was more extensive than the Roman province of Phrygia (Diod. Sic. iii. 58; Paus. vii. 17; Arnob. v. 5; Firm. Mat. *De error.*, 3; Ovid, *Fastii*, iv. 223 ff.; Sallust. *Phil. De diis et mundo*, 4; Jul. Or. v. 165 ff.). Her best-known early seats of worship were Mt. Ida, Mt. Sipylus, Cyzicus, Sardis and Pessinus, the last-named city, in Galatia near the borders of Roman Phrygia, finally becoming the strongest centre of the cult. She was known to the Romans and Greeks as essentially Phrygian, and all Phrygia was spoken of as sacred to her (Schol. Apollon. Rhod. *Argonautica*, i. 1126). It is probable, however, that the Phrygian race, which invaded Asia Minor from the north in the 9th century B.C., found a great nature goddess already universally worshipped there, and blended her with a deity of their own. The Asiatic-Phrygian worship thus evolved was further modified by contact with the Syrians and Phoenicians, so that it acquired strong Semitic characteristics. The Great Mother known to the Greeks and Romans was thus merely the Phrygian form of the nature deity of all Asia Minor.

From Asia Minor the cult of the Great Mother spread first to Greek territory. It found its way into Thrace at an early date, was known in Boeotia by Pindar in the 6th century, and entered Attica near the beginning of the 4th century (Grant Showerman, *The Great Mother of the Gods, Bulletin of the University of Wisconsin*, No. 43, Madison, 1901). At Peiraecus, where it probably arrived by way of the Aegean islands, it existed privately in a fully developed state, that is, accompanied by the worship of Attis, at the beginning of the 4th century, and publicly two centuries later (D. Comparetti, *Annales*, 1862, pp. 23 ff.). The Greeks from the first saw in the Great Mother a resemblance to their own Rhea, and finally identified the two completely, though the Asiatic peculiarities of the cult were never universally popular with them (Showerman, p. 294). In her less Asiatic aspect, i.e. without Attis, she was sometimes identified with Gaia and Demeter. It was in this phase that she was worshipped in the Metroön at Athens. In reality, the Mother Goddess appears under three aspects: Rhea, the Homeric and Hesiodic goddess of Cretan origin; the Phrygian Mother, with Attis; and the Greek Great Mother, a modified form of the Phrygian Mother, to be explained as the original goddess of the Phrygians of Europe, communicated to the Greek stock before the Phrygian invasion of Asia Minor and consequent mingling with Asiatic stocks (cf. Showerman, p. 252).

In 204 B.C., in obedience to the Sibylline prophecy which said that whenever an enemy from abroad should make war on Italy he could be expelled and conquered if the Idaean Mother were brought to Rome from Pessinus, the cult of the Great Mother, together with her sacred symbol, a small meteoric stone reputed to have fallen from the heavens, was transferred to Rome and established in a temple on the Palatine (Livy xxix. 10-14). Her identification by the Romans with Maia, Ops, Rhea, Tellus

and Ceres contributed to the establishment of her worship on a firm footing. By the end of the Republic it had attained prominence, and under the Empire it became one of the three most important cults in the Roman world, the other two being those of Mithras and Isis. Epigraphic and numismatic evidence prove it to have penetrated from Rome as a centre to the remotest provinces (Showerman, pp. 291-293). During the brief revival of paganism under Eugenius in A.D. 394, occurred the last appearance of the cult in history. Besides the temple on the Palatine, there existed minor shrines of the Great Mother near the present church of St Peter, on the Sacra Via on the north slope of the Palatine, near the junction of the Almo and the Tiber, south of the city (*ibid.* 311-314).

In all her aspects, Roman, Greek and Oriental, the Great Mother was characterized by essentially the same qualities. Most prominent among them was her universal motherhood. She was the great parent of gods and men, as well as of the lower orders of creation. "The winds, the sea, the earth and the snowy seat of Olympus are hers, and when from her mountains she ascends into the great heavens, the son of Cronus himself gives way before her" (Apollon. Rhod. *Argonautica*, l. 1098). She was known as the All-begetter, the All-nourisher, the Mother of all the Blest. She was the great, fruitful, kindly earth itself. Especial emphasis was placed upon her maternity over wild nature. She was called the Mountain Mother; her sanctuaries were almost invariably upon mountains, and frequently in caves, the name Cybele itself being by some derived from the latter; lions were her faithful companions. Her universal power over the natural world finds beautiful expression in Apollonius Rhodius, *Argonautica*, l. 1140 ff. She was also a chaste and beautiful deity. Her especial affinity with wild nature was manifested by the orgiastic character of her worship. Her attendants, the Corybantes, were wild, half demonic beings. Her priests, the Galli, were eunuchs attired in female garb, with long hair fragrant with ointment. Together with priestesses, they celebrated her rites with flutes, horns, castanets, cymbals and tambourines, madly yelling and dancing until their frenzied excitement found its culmination in self-scourging, self-laceration or exhaustion. Self-emasculation sometimes accompanied this delirium of worship on the part of candidates for the priesthood (Showerman, pp. 234-239). The Attis of Catullus (lxiii.) is a brilliant treatment of such an episode.

Though her cult sometimes existed by itself, in its fully developed state the worship of the Great Mother was accompanied by that of Attis (*q.v.*). The cult of Attis never existed independently. Like Adonis and Aphrodite, Baal and Astarte, &c., the two formed a duality representing the relations of Mother Nature to the fruits of the earth. There is no positive evidence to prove the existence of the cult publicly in this phase in Greece before the 2nd century B.C., nor in Rome before the Empire, though it may have existed in private (Showerman, "Was Attis at Rome under the Republic?" in *Transactions of the American Philological Association*, vol. 31, 1900, pp. 46-59; Cumont, s.v. "Attis," *De Ruggiero's Dizionario epigrafico* and Pauly-Wisowa's *Realencyclopädie*, Supplement; Hepding, *Attis, seine Mythen und seine Kult*, Giessen, 1903, p. 142).

The philosophers of the late Roman Empire interpreted the Attis legend as symbolizing the relations of Mother Earth to her children the fruits. Porphyrius says that Attis signified the flowers of spring time, and was cut off in youth because the flower falls before the fruit (Augustine, *De civ. Dei*, vii. 25). Maternus (*De error.* 3) interprets the love of the Great Mother for Attis as the love of the earth for her fruits; his emasculation as the cutting of the fruits; his death as their preservation; and his resurrection as the sowing of the seed again.

At Rome the immediate direction of the cult of the Great Mother devolved upon the high priest, *Archigallus*, called Attis, a high priestess, *Sacerdos Maxima*, and its support was derived, at least in part, from a popular contribution, the *stips*. Besides other priests, priestesses and minor officials, such as musicians, curator, &c., there were certain colleges connected with the administration of the cult, called *cannophori* (reed-bearers) and

dendrophori (branch-bearers). The *Quindecimviri* exercised a general supervision over this cult, as over all other authorized cults, and it was, at least originally, under the special patronage of a club or sodality (Showerman, pp. 269-276). Roman citizens were at first forbidden to take part in its ceremonies, and the ban was not removed until the time of the Empire.

The main public event in the worship of the Great Mother was the annual festival, which took place originally on the 4th of April, and was followed on the 5th by the *Megalesia*, games instituted in her honour on the introduction of the cult. Under the Empire, from Claudius on, the *Megalesia* lasted six days, April 4-10, and the original one day of the religious festival became an annual cycle of festivals extending from the 15th to the 27th of March, in the following order: (1) The 15th of March, *Canna intrat*—the sacrifice of a six-year-old bull in behalf of the mountain fields, the high priest, a priestess and the *cannophori* officiating, the last named carrying reeds in procession in commemoration of the exposure of the infant Attis on the reedy banks of the stream Gallus in Phrygia. (This may have been originally a phallic procession. Cf. Showerman, *American Journal of Philol.* xxvii. 1, *Classical Journal* l. 4.) (2) The 22nd of March, *Arbor intrat*—the bearing in procession of the sacred pine, emblem of Attis' self-mutilation, death and immortality, to the temple on the Palatine, the symbol of the Mother's cave, by the *dendrophori*, a guild of workmen who made the Mother, among other deities, a patron. (3) The 24th of March, *Dies sanguinis*—a day of mourning, fasting and abstinence, especially sexual, commemorating the sorrow of the Mother for Attis, her abstinence from food and her chastity. The frenzied dance and self-laceration of the priests in commemoration of Attis' deed, and the submission to the act of consecration by candidates for the priesthood, was a special feature of the day. The *taurobolium* (*q.v.*) was often performed on this day, on which probably took place the initiation of mystics. (4) The 25th of March, *Hilaria*—one of the great festal days of Rome, celebrated by all the people. All mourning was put off, and good cheer reigned in token of the return of the sun and spring, which was symbolized by the renewal of Attis' life. (5) The 26th of March, *Requies*—a day of rest and quiet. (6) The 27th of March, *Lovatia*—the crowning ceremony of the cycle. The silver statue of the goddess, with the sacred meteoric stone, the *Acus*, set in its head, was borne in gorgeous procession and bathed in the Almo, the remainder of the day being given up to rejoicing and entertainment, especially dramatic representation of the legend of the deities of the day. Other ceremonies, not necessarily connected with the annual festival, were the *taurobolium* (*q.v.*), the sacrifice of a bull, and the *criobolium* (*q.v.*), the sacrifice of a ram, the latter being the analogue of the former, instituted for the purpose of giving Attis special recognition. The baptism of blood, which was the feature of these ceremonies, was regarded as purifying and regenerating (Showerman, *Great Mother*, pp. 277-284).

The Great Mother figures in the art of all periods both in Asia and Europe, but is especially prominent in the art of the Empire. No work of the first class, however, was inspired by her. She appears on coins, in painting and in all forms of sculpture, usually with mural crown and veil, well draped, seated on a throne, and accompanied by two lions. Other attributes which often appear are the patera, tympanum, cymbals, sceptre, garlands and fruits. Attis and his attributes, the pine, Phrygian cap, pedum, syrinx and torch, also appear. The Cybele of Formia, now at Copenhagen, is one of the most famous representations of the goddess. The Niobe of Mt. Sipylius is really the Mother. In literature she is the subject of frequent mention, but no work of importance, with the exception of Catullus lxiii., is due to her inspiration. Her importance in the history of religion is very great. Together with Isis and Mithras, she was a great enemy, and yet a great aid to Christianity. The gorgeous rites of her worship, its mystic doctrine of communion with the divine through enthusiasm, its promise of regeneration through baptism of blood in the *taurobolium*, were features which attracted the masses of the people and made it a strong

rival of Christianity; and its resemblance to the new religion, however superficial, made it, in spite of the scandalous practices which grew up around it, a stepping-stone to Christianity when the tide set in against paganism.

AUTHORITIES.—Grant Showerman, "The Great Mother of the Gods," *Bulletin of the University of Wisconsin*, No. 43; *Philology and Literature Series*, vol. 1, No. 3 (Madison, 1901); Hugo Hering, *Attis, seine Mythen und seine Kult* (Giessen, 1903); Rapp, *Roscher's Ausführliches Lexicon der griechischen und römischen Mythologie* s.s. "Kybele"; Drexler, *ibid.* s.s. "Meter." See ROMAN RELIGION, GREEK RELIGION, ATTIS, CORYBANTES; for the great "Hittite" portrayal of the Nature Goddess at Pteria, see PTERIA. (G. SN.)

GREAT REBELLION (1642-52), a generic name for the civil wars in England and Scotland, which began with the raising of King Charles I.'s standard at Nottingham on the 22nd of August 1642, and ended with the surrender of Dunottar Castle to the Parliament's troops in May 1652. It is usual to classify these wars into the First Civil War of 1642-46, and the Second Civil War of 1648-52. During most of this time another civil war was raging in Ireland. Its incidents had little or no connexion with those of the Great Rebellion, but its results influenced the struggle in England to a considerable extent.

1. *First Civil War (1642-46).*—It is impossible rightly to understand the events of this most national of all English wars without some knowledge of the motive forces on both sides. On the side of the king were enlisted the deep-seated loyalty which was the result of two centuries of effective royal protection, the pure cavalier spirit foreshadowing the courtier era of Charles II., but still strongly tinged with the old feudal indisciplinability, the militarism of an expert soldier nobility, well represented by Prince Rupert, and lastly a widespread distrust of extreme Puritanism, which appeared unreasonable to Lord Falkland and other philosophic statesmen and intolerable to every other class of Royalists. The foot of the Royal armies was animated in the main by the first and last of these motives; in the eyes of the sturdy rustics who followed their squires to the war the enemy were rebels and fanatics. To the cavalry, which was composed largely of the higher social orders, the rebels were, in addition, bourgeois, while the soldiers of fortune from the German wars felt all the regular's contempt for citizen militia. Thus in the first episodes of the First Civil War moral superiority tended to be on the side of the king. On the other side, the causes of the quarrel were primarily and apparently political, ultimately and really religious, and thus the elements of resistance in the Parliament and the nation were at first confused, and, later, strong and direct. Democracy, moderate republicanism and the simple desire for constitutional guarantees could hardly make head of themselves against the various forces of royalism, for the most moderate men of either party were sufficiently in sympathy to admit compromise. But the backbone of resistance was the Puritan element, and this waging war at first with the rest on the political issue soon (as the Royalists anticipated) brought the religious issue to the front. The Presbyterian system, even more rigid than that of Laud and the bishops—whom no man on either side supported save Charles himself—was destined to be supplanted by the Independents and their ideal of free conscience, but for a generation before the war broke out it had disciplined and trained the middle classes of the nation (who furnished the bulk of the rebel infantry, and later of the cavalry also) to centre their whole will-power on the attainment of their ideals. The ideals changed during the struggle, but not the capacity for striving for them, and the men capable of the effort finally came to the front and imposed their ideals on the rest by the force of their trained wills.

Material force was throughout on the side of the Parliamentary party. They controlled the navy, the nucleus of an army which was in process of being organized for the Irish war, and nearly all the financial resources of the country. They had the sympathies of most of the large towns, where the trained bands, drilled once a month, provided cadres for new regiments. Further, by recognizing the inevitable, they gained a start in war preparations which they never lost. The earls of Warwick, Essex and Manchester and other nobles and gentry of their party possessed great wealth and territorial influence. Charles, on the other hand, although he

could, by means of the "press" and the lords-lieutenant, raise men without authority from Parliament, could not raise taxes to support them, and was dependent on the financial support of his chief adherents, such as the earls of Newcastle and Derby. Both parties raised men when and where they could, each claiming that the law was on its side—for England was already a law-abiding nation—and acting in virtue of legal instruments. These were, on the side of the Parliament, its own recent "Militia Ordinance"; on that of the king, the old-fashioned "Commissions of Array." In Cornwall the Royalist leader, Sir Ralph Hopton, indicted the enemy before the grand jury of the county as disturbers of the peace, and had the *posse comitatus* called out to expel them. The local forces in fact were everywhere employed by whichever side could, by producing valid written authority, induce them to assemble.

2. *The Royalist and Parliamentarian Armies.*—This thread of local feeling and respect for the laws runs through the earlier operations of both sides almost irrespective of the main principles at stake. Many a promising scheme failed because of the reluctance of the militiamen to serve beyond the limits of their own county, and, as the offensive lay with the king, his cause naturally suffered far more therefrom than that of the enemy. But the real spirit of the struggle was very different. Anything which tended to prolong the struggle, or seemed like want of energy and avoidance of a decision, was bitterly resented by the men of both sides, who had their hearts in the quarrel and had not as yet learned by the severe lesson of Edgehill that raw armies cannot bring wars to a speedy issue. In France and Germany the prolongation of a war meant continued employment for the soldiers, but in England "we never encamped or entrenched . . . or lay fenced with rivers or defiles. Here were no leaguers in the field, as at the story of Nuremberg," neither had our soldiers any tents or what they call heavy baggage. 'Twas the general maxim of the war—Where is the enemy? Let us go and fight them. Or . . . if the enemy was coming . . . Why, what should be done! Draw out into the fields and fight them." This passage from the *Memoirs of a Cavalier*, ascribed to Defoe, though not contemporary evidence, is an admirable summary of the character of the Civil War. Even when in the end a regular professional army is evolved—exactly as in the case of Napoleon's army—the original decision-compelling spirit permeated the whole organization. From the first the professional soldiers of fortune, be their advice good or bad, are looked upon with suspicion, and nearly all those Englishmen who loved war for its own sake were too closely concerned for the welfare of their country to attempt the methods of the Thirty Years' War in England. The formal organization of both armies was based on the Swedish model, which had become the pattern of Europe after the victories of Gustavus Adolphus, and gave better scope for the moral of the individual than the old-fashioned Spanish and Dutch formations in which the man in the ranks was a highly finished automaton.

3. *Campaign of 1642.*—When the king raised his standard at Nottingham on the 22nd of August 1642, war was already in progress on a small scale in many districts, each side endeavouring to secure, or to deny to the enemy, fortified country-houses, territory, and above all arms and money. Peace negotiations went on in the midst of these minor events until there came from the Parliament an ultimatum so aggressive as to fix the warlike purpose of the still vacillating court at Nottingham, and, in the country at large, to convert many thousands of waverers to active Royalism. Ere long Charles—who had hitherto had less than 1500 men—was at the head of an army which, though very deficient in arms and equipment, was not greatly inferior in numbers or enthusiasm to that of the Parliament. The latter (20,000 strong exclusive of detachments) was organized during July, August and September about London, and moved thence to Northampton under the command of Robert, earl of Essex.

At this moment the military situation was as follows. Lord Hertford in south Wales, Sir Ralph Hopton in Cornwall, and the

¹ Gustavus Adolphus before the battle of the *Ålte Veste* (see THIRTY YEARS' WAR).

young earl of Derby in Lancashire, and small parties in almost every county of the west and the midlands, were in arms for the king. North of the Tees, the earl of Newcastle, a great territorial magnate, was raising troops and supplies for the king, while Queen Henrietta Maria was busy in Holland arranging for the importation of war material and money. In Yorkshire opinion was divided, the royal cause being strongest in York and the North Riding, that of the Parliamentary party in the clothing towns of the West Riding and also in the important seaport of Hull. The Yorkshire gentry made an attempt to neutralize the county, but a local struggle soon began, and Newcastle thereupon prepared to invade Yorkshire. The whole of the south and east as well as parts of the midlands and the west and the important towns of Bristol and Gloucester were on the side of the Parliament. A small Royalist force was compelled to evacuate Oxford on the 10th of September.

On the 13th of September the main campaign opened. The king—in order to find recruits amongst his sympathizers and arms in the armouries of the Derbyshire and Staffordshire trained bands, and also to be in touch with his disciplined regiments in Ireland by way of Chester—moved westward to Shrewsbury, Essex following suit by marching from Northampton to Worcester. Near the last-named town a sharp cavalry engagement (Powick Bridge) took place on the 23rd between the advanced cavalry of Essex's army and a force under Prince Rupert which was engaged in protecting the retirement of the Oxford detachment. The result of the fight was the instantaneous overthrow of the rebel cavalry, and this gave the Royalist troopers a confidence in themselves and in their brilliant leader which was not destined to be shaken until they met Cromwell's Ironsides. Rupert soon withdrew to Shrewsbury, where he found many Royalist officers eager to attack Essex's new position at Worcester. But the road to London now lay open and it was decided to take it. The intention was not to avoid a battle, for the Royalist generals desired to fight Essex before he grew too strong, and the temper of both sides made it impossible to postpone the decision; in Clarendon's words, "it was considered more counsellable to march towards London, it being morally sure that the earl of Essex would put himself in their way," and accordingly the army left Shrewsbury on the 12th of October, gaining two days' start of the enemy, and moved south-east via Bridgnorth, Birmingham and Kenilworth. This had the desired effect. Parliament, alarmed for its own safety, sent repeated orders to Essex to find the king and bring him to battle. Alarm gave place to determination when it was discovered that Charles was enlisting papists and seeking foreign aid. The militia of the home counties was called out, a second army under the earl of Warwick was formed round the nucleus of the London trained bands, and Essex, straining every nerve to regain touch with the enemy, reached Kineton, where he was only 7 m. from the king's headquarters at Edgecote, on the 22nd.

4. *Battle of Edgehill.*—Rupert promptly reported the enemy's presence, and his confidence dominated the irresolution of the king and the caution of Lord Lindsey, the nominal commander-in-chief. Both sides had marched widely dispersed in order to live, and the rapidity with which, having the clearer purpose, the Royalists drew together helped considerably to neutralize Essex's superior numbers. During the morning of the 23rd the Royalists formed in battle order on the brow of Edgehill facing towards Kineton. Essex, experienced soldier as he was, had distrusted his own raw army too much to force a decision earlier in the month, when the king was weak; he now found Charles in a strong position with an equal force to his own 14,000, and some of his regiments were still some miles distant. But he advanced beyond Kineton, and the enemy promptly left their strong position and came down to the foot of the hill, for, situated as they were, they had either to fight wherever they could induce the enemy to engage, or to starve in the midst of hostile garrisons. Rupert was on the right of the king's army with the greater part of the horse, Lord Lindsey and Sir Jacob Astley in the centre with the foot, Lord Wilmot (with whom rode the earl of Forth, the principal military adviser

of the king) with a smaller body of cavalry on the left. In rear of the centre were the king and a small reserve. Essex's order was similar. Rupert charged as soon as his wing was deployed, and before the infantry of either side was ready. Taking ground to his right front and then wheeling inwards at full speed he instantly rode down the Parliamentary horse opposed to him. Some infantry regiments of Essex's left centre shared the same fate as their cavalry. On the other wing Forth and Wilmot likewise swept away all that they could see of the enemy's cavalry, and the undisciplined Royalists of both wings pursued the fugitives in wild disorder up to Kineton, where they were severely handled by John Hampden's infantry brigade (which was escorting the artillery and baggage of Essex's army). Rupert brought back only a few rallied squadrons to the battlefield, and in the meantime affairs there had gone badly for the king. The right and centre of the Parliamentary foot (the left having been brought to a halt by Rupert's charge) advanced with great resolution, and being at least as ardent as, and much better armed than, Lindsey's men, engaged them fiercely and slowly gained ground. Only the best regiments on either side, however, maintained their order, and the decision of the infantry battle was achieved mainly by a few Parliamentary squadrons. One regiment of Essex's right wing only had been the target of Wilmot's charge, the other two had been at the moment invisible, and, as every Royalist troop on the ground, even the king's guards, had joined in the mad ride to Kineton, these, Essex's life-guard, and some troops that had rallied from the effect of Rupert's charge—amongst them Captain Oliver Cromwell's—were the only cavalry still present. All these joined with decisive effect in the attack on the left of the royal infantry. The king's line was steadily rolled up from left to right, the Parliamentary troopers captured his guns and regiment after regiment broke up. Charles himself stood calmly in the thick of the fight, but he had not the skill to direct it. The royal standard was taken and retaken, Lindsey and Sir Edmund Verney, the standard-bearer, being killed. By the time that Rupert returned both sides were incapable of further effort and disillusioned as to the prospect of ending the war at a blow.

On the 24th Essex retired, leaving Charles to claim the victory and to reap its results. Banbury and Oxford were recaptured by the Royalists, and by the 28th Charles was marching down the Thames valley on London. Negotiations were reopened, and a peace party rapidly formed itself in London and Westminster. Yet field fortifications sprang up around London, and when Rupert stormed and sacked Brentford on the 12th of November the trained bands moved out at once and took up a position at Turnham Green, barring the king's advance: Hampden, with something of the fire and energy of his cousin Cromwell, urged Essex to turn both flanks of the Royal army via Acton and Kingston, but experienced professional soldiers urged him not to trust the London men to hold their ground while the rest manoeuvred. Hampden's advice was undoubtedly premature. A Sedan or Worcester was not within the power of the Parliamentarians of 1642, for, in Napoleon's words, "one only manoeuvres around a fixed point," and the city levies at that time were certainly not, *vis-à-vis* Rupert's cavalry, a fixed point. As a matter of fact, after a slight cannonade at Turnham Green on the 13th, Essex's two-to-one numerical superiority of itself compelled the king to retire to Reading. Turnham Green has justly been called the Valmy of the English Civil War. Like Valmy, without being a battle, it was a victory, and the tide of invasion came thus far, ebbed, and never returned.

5. *The Winter of 1642-43.*—In the winter, while Essex lay inactive at Windsor, Charles by degrees consolidated his position in the region of Oxford. The city was fortified as a reduct for the whole area, and Reading, Wallingford, Abingdon, Brill, Banbury and Marlborough constituted a complete defensive ring which was developed by the creation of smaller posts from time to time. In the north and west, winter campaigns were actively carried on. "It is summer in Yorkshire, summer in Devon, and cold winter at Windsor," said one of Essex's critics. At the beginning of December Newcastle crossed the Tees,

defeated Hotham, the Parliamentary commander in the North Riding, then joining hands with the hard-pressed Royalists at York, established himself between that city and Pontefract. Lord Fairfax and his son Sir Thomas, who commanded for the Parliament in Yorkshire, had to retire to the district between Hull and Selby, and Newcastle was free to turn his attention to the Puritan "clothing towns" of the West Riding—Leeds, Halifax and Bradford. The townsmen, however, showed a determined front, the younger Fairfax with a picked body of cavalry rode through Newcastle's lines into the West Riding to help them, and about the end of January 1643 the earl gave up the attempt to reduce the towns. He continued his march southward, however, and gained ground for the king as far as Newark, so as to be in touch with the Royalists of Nottinghamshire, Derbyshire and Leicestershire (who, especially about Newark and Ashby-de-la-Zouch, were strong enough to neutralise the local forces of the Parliament), and to prepare the way for the further advance of the army of the north when the queen's convoy should arrive from over-seas.

In the west Sir Ralph Hopton and his friends, having obtained a true bill from the grand jury against the Parliamentary disturbers of the peace, placed themselves at the head of the county militia and drove the rebels from Cornwall, after which they raised a small force for general service and invaded Devonshire (November 1642). Subsequently a Parliamentary army under the earl of Stamford was withdrawn from south Wales to engage Hopton, who had to retire into Cornwall. There, however, the Royalist general was free to employ the militia again, and thus reinforced he won a victory over a part of Stamford's forces at Bradock Down near Liskeard (January 19, 1643) and resumed the offensive. About the same time Hertford, no longer opposed by Stamford, brought over the South Wales Royalists to Oxford, and the fortified area around that place was widened by the capture of Cirencester on the 2nd of February. Gloucester and Bristol were now the only important garrisons of the Roundheads in the west. In the midlands, in spite of a Parliamentary victory won by Sir William Brereton at Nantwich on the 28th of January, the Royalists of Shropshire, Staffordshire and Leicestershire soon extended their influence through Ashby-de-la-Zouch into Nottinghamshire and joined hands with their friends at Newark. Further, around Chester a new Royalist army was being formed under Lord Byron, and all the efforts of Brereton and of Sir John Gell, the leading supporter of the Parliament in Derbyshire, were required to hold their own, even before Newcastle's army was added to the list of their enemies. Lord Brooke, who commanded for the Parliament in Warwickshire and Staffordshire and was looked on by many as Essex's eventual successor, was killed in besieging Lichfield cathedral on the 2nd of March, and, though the cathedral soon capitulated, Gell and Brereton were severely handled in the indecisive battle of Hopton Heath near Stafford on the 10th of March, and Prince Rupert, after an abortive raid on Bristol (March 7), marched rapidly northward, storming Birmingham en route, and recaptured Lichfield cathedral. He was, however, soon recalled to Oxford to take part in the main campaign. The position of affairs for the Parliament was perhaps at its worst in January. The Royalist successes of November and December, the ever-present dread of foreign intervention, and the burden of new taxation which the Parliament now found itself compelled to impose; disheartened its supporters. Disorders broke out in London, and, while the more determined of the rebels began thus early to think of calling in the military assistance of the Scots, the majority were for peace on any conditions. But soon the position improved somewhat; Stamford in the west and Brereton and Gell in the midlands, though hard pressed, were at any rate in arms and undefeated, Newcastle had failed to conquer the West Riding, and Sir William Waller, who had cleared Hampshire and Wiltshire of "malignants," entered Gloucestershire early in March, destroyed a small Royalist force at Highnam (March 24), and secured Bristol and Gloucester for the Parliament. Finally, some of Charles's own intrigues opportunely coming to light, the waverers, seeing the impos-

sibility of plain dealing with the court, rallied again to the party of resistance, and the series of negotiations called by the name of the Treaty of Oxford closed in April with no more result than those which had preceded Edgehill and Turnham Green. About this time too, following and improving upon the example of Newcastle in the north, Parliament ordered the formation of the celebrated "associations" or groups of counties banded together by mutual consent for defence. The most powerful and best organized of these was that of the eastern counties (headquarters Cambridge), where the danger of attack from the north was near enough to induce great energy in the preparations for meeting it, and at the same time too distant effectively to interfere with these preparations. Above all, the Eastern Association was from the first guided and inspired by Colonel Cromwell.

6. *The Plan of Campaign, 1643.*—The king's plan of operations for the next campaign, which was perhaps inspired from abroad, was more elaborate than the simple "point" of 1642. The king's army, based on the fortified area around Oxford, was counted sufficient to use up Essex's forces. On either hand, therefore, in Yorkshire and in the west, the Royalist armies were to fight their way inwards towards London, after which all three armies, converging on that place in due season, were to cut off its supplies and its sea-borne revenue and to starve the rebellion into surrender. The condition of this threefold advance was of course that the enemy should not be able to defeat the armies in detail, i.e. that he should be fixed and held in the Thames valley; this secured, there was no purely military objection against operating in separate armies from the circumference towards the centre. It was on the rock of local feeling that the king's plan came to grief. Even after the arrival of the queen and her convoy, Newcastle had to allow her to proceed with a small force, and to remain behind with the main body, because of Lancashire and the West Riding, and above all because the port of Hull, in the hands of the Fairfaxes, constituted a menace that the Royalists of the East Riding refused to ignore. Hopton's advance too, undertaken without the Cornish levies, was checked in the action of Sourton Down (Dartmoor) on the 25th of April, and on the same day Waller captured Hereford. Essex had already left Windsor to undertake the siege of Reading, the most important point in the circle of fortresses round Oxford, which after a vain attempt at relief surrendered to him on the 26th of April. Thus the opening operations were unfavourable, not indeed so far as to require the scheme to be abandoned, but at least delaying the development until the campaigning season was far advanced.

7. *Victories of Hopton.*—But affairs improved in May. The queen's long-expected convoy arrived at Woodstock on the 13th. The earl of Stamford's army, which had again entered Cornwall, was attacked in its selected position at Stratton and practically annihilated by Hopton (May 16). This brilliant victory was due above all to Sir Bevil Grenville and the lithe Cornishmen, who, though but 2400 against 5400 and destitute of artillery, stormed "Stamford Hill," killed 300 of the enemy, and captured 1700 more with all their guns, colours and baggage. Devon was at once overrun by the victors. Essex's army, for want of material resources, had had to be content with the capture of Reading, and a Royalist force under Hertford and Prince Maurice (Rupert's brother) moved out as far as Salisbury to hold out a hand to their friends in Devonshire, while Waller, the only Parliamentary commander left in the field in the west, had to abandon his conquests in the Severn valley to oppose the further progress of his intimate friend and present enemy, Hopton. Early in June Hertford and Hopton united at Chard and rapidly moved, with some cavalry skirmishing, towards Bath, where Waller's army lay. Avoiding the barrier of the Mendips, they moved round via Frome to the Avon. But Waller, thus cut off from London and threatened with investment, acted with great skill, and some days of manoeuvres and skirmishing followed, after which Hertford and Hopton found themselves on the north side of Bath facing Waller's entrenched position on the top of Lansdown Hill. This position the Royalists

stormed on the 5th of July. The battle of Lansdown was a second Stratton for the Cornishmen, but this time the enemy was of different quality and far differently led, and they had to mourn the loss of Sir Bevil Grenville and the greater part of their whole force. At dusk both sides stood on the flat summit of the hill, still firing into one another with such energy as was not yet expended, and in the night Waller drew off his men into Bath. "We were glad they were gone," wrote a Royalist officer, "for if they had not, I know who had within the hour." Next day Hopton was severely injured by the explosion of a wagon containing the reserve ammunition, and the Royalists, finding their victory profitless, moved eastward to Devizes, closely followed by the enemy. On the 10th of July Sir William Waller took post on Roundway Down, overlooking Devizes, and captured a Royalist ammunition column from Oxford. On the 11th he came down and invested Hopton's foot in Devizes itself, while the Royalist cavalry, Hertford and Maurice with them, rode away towards Salisbury. But although the siege was pressed with such vigour that an assault was fixed for the evening of the 13th, the Cornishmen, Hopton directing the defence from his bed, held out stubbornly, and on the afternoon of July 13th Prince Maurice's horsemen appeared on Roundway Down, having ridden to Oxford, picked up reinforcements there, and returned at full speed to save their comrades. Waller's army tried its best, but some of its elements were of doubtful quality and the ground was all in Maurice's favour. The battle did not last long. The combined attack of the Oxford force from Roundway and of Hopton's men from the town practically annihilated Waller's army. Very soon afterwards Rupert came up with fresh Royalist forces, and the combined armies moved westward. Bristol, the second port of the kingdom, was their objective, and in four days from the opening of the siege it was in their hands (July 26). Waller with the beaten remnant of his army at Bath being powerless to intervene. The effect of this blow was felt even in Dorsetshire. Within three weeks of the surrender Prince Maurice with a body of fast-moving cavalry overran that county almost unopposed.

8. *Adwalton Moor*.—Newcastle meanwhile had resumed operations against the clothing towns, this time with success. The Fairfaxes had been fighting in the West Riding since January with such troops from the Hull region as they had been able to bring across Newcastle's lines. They and the townsmen together were too weak for Newcastle's increasing forces, and an attempt was made to relieve them by bringing up the Parliament's forces in Nottinghamshire, Derbyshire, Lincolnshire and the Eastern Association. But local interests prevailed again, in spite of Cromwell's presence, and after assembling at Nottingham, the midland rebels quietly dispersed to their several counties (June 2). The Fairfaxes were left to their fate, and about the same time Hull itself narrowly escaped capture by the queen's forces through the treachery of Sir John Hotham, the governor, and his son, the commander of the Lincolnshire Parliamentarians. The latter had been placed under arrest at the instance of Cromwell and of Colonel Hutchinson, the governor of Nottingham Castle; he escaped to Hull, but both father and son were seized by the citizens and afterwards executed. More serious than an isolated act of treachery was the far-reaching Royalist plot that had been detected in Parliament itself, for complicity in which Lord Conway, Edmund Waller the poet, and several members of both Houses were arrested. The safety of Hull was of no avail for the West Riding towns, and the Fairfaxes underwent a decisive defeat at Adwalton (Atherton) Moor near Bradford on the 30th of June. After this, by way of Lincolnshire, they escaped to Hull and reorganized the defence of that place. The West Riding perforce submitted.

The queen herself with a second convoy and a small army under Henry (Lord) Jermyn soon moved via Newark, Ashby-de-la-Zouch, Lichfield and other Royalist garrisons to Oxford, where she joined her husband on the 14th of July. But Newcastle (now a marquis) was not yet ready for his part in the programme. The Yorkshire troops would not march on London while the enemy was master of Hull, and by this time there was

a solid barrier between the royal army of the north and the capital. Roundway Down and Adwalton Moor were not after all destined to be fatal, though peace-riots in London, dissensions in the Houses, and quarrels amongst the generals were their immediate consequences. A new factor had arisen in the war—the Eastern Association.

9. *Cromwell and the Eastern Association*.—This had already intervened to help in the siege of Reading and had sent troops to the abortive gathering at Nottingham, besides clearing its own ground of "malignants." From the first Cromwell was the dominant influence. Fresh from Edgehill, he had told Hampden, "You must get men of a spirit that is likely to go as far as gentlemen will go," not "old decayed serving-men, tapeters and such kind of fellows to encounter gentlemen that have honour and courage and resolution in them," and in January 1643 he had gone to his own county to "raise such men as had the fear of God before them and made some conscience of what they did." These men, once found, were willing, for the cause, to submit to a rigorous training and an iron discipline such as other troops, fighting for honour only or for profit only, could not be brought to endure.¹ The result was soon apparent. As early as the 13th of May, Cromwell's regiment of horse—recruited from the horse-loving yeomen of the eastern counties—demonstrated its superiority in the field in a skirmish near Grantham, and in the irregular fighting in Lincolnshire during June and July (which was on the whole unfavourable to the Parliament), as previously in pacifying the Eastern Association itself, these Puritan troopers distinguished themselves by long and rapid marches that may bear comparison with almost any in the history of the mounted arm. When Cromwell's second opportunity came at Gainsborough on the 28th of July, the "Lincolneer" horse who were under his orders were fired by the example of Cromwell's own regiment, and Cromwell, directing the whole with skill, and above all with energy, utterly routed the Royalist horse and killed their general, Charles Cavendish.

In the meantime the army of Essex had been inactive. After the fall of Reading a serious epidemic of sickness had reduced it to impotence. On the 18th of June the Parliamentary cavalry was routed and John Hampden mortally wounded at Chalgrove Field near Chiselhampton, and when at last Essex, having obtained the desired reinforcements, moved against Oxford from the Aylesbury side, he found his men demoralized by inaction, and before the menace of Rupert's cavalry, to which he had nothing to oppose, he withdrew to Bedfordshire (July). He made no attempt to intercept the march of the queen's convoys, he had permitted the Oxford army, which he should have held fast, to intervene effectually in the midlands, the west, and the south-west, and Waller might well complain that Essex, who still held Reading and the Chilterns, had given him neither active nor passive support in the critical days preceding Roundway Down. Still only a few voices were raised to demand his removal, and he was shortly to have an opportunity of proving his skill and devotion in a great campaign and a great battle. The centre and the right of the three Royalist armies had for a moment (Roundway to Bristol) united to crush Waller, but their concentration was short-lived. Plymouth was to Hopton's men what Hull was to Newcastle's—they would not march on London until the menace to their homes was removed. Further, there were dissensions among the generals which Charles was too weak to crush, and consequently the original plan reappears—the main Royalist army to operate in the centre, Hopton's (now Maurice's) on the right, Newcastle on the left towards London. While waiting for the fall of Hull and Plymouth, Charles naturally decided to make the best use of his time by reducing Gloucester, the one great fortress of the Parliament in the west.

10. *Siege and Relief of Gloucester*.—This decision quickly brought on a crisis. While the earl of Manchester (with Cromwell as his lieutenant-general) was appointed to head the forces of the Eastern Association against Newcastle, and Waller was

¹ "Making not money but that which they took to be the public felicity to be their end they were the more engaged to be valiant" (Baxter).

given a new army wherewith again to engage Hopton and Maurice, the task of saving Gloucester from the king's army fell to Essex, who was heavily reinforced and drew his army together for action in the last days of August. Resort was had to the press-gang to fill the ranks, recruiting for Waller's new army was stopped, and London sent six regiments of trained bands to the front, closing the shops so that every man should be free to take his part in what was thought to be the supreme trial of strength.

On the 26th, all being ready, Essex started. Through Aylesbury and round the north side of Oxford to Stow-on-the-Wold the army moved resolutely, not deterred by want of food and rest, or by the attacks of Rupert's and Wilmot's horse on its flank. On the 5th of September, just as Gloucester was at the end of its resources, the siege was suddenly raised and the Royalists drew off to Painswick, for Essex had reached Cheltenham and the danger was over. Then, the field armies being again face to face and free to move, there followed a series of skilful manoeuvres in the Severn and Avon valleys, at the end of which the Parliamentary army gained a long start on its homeward road via Cricklade, Hungerford and Reading. But the Royalist cavalry under Rupert, followed rapidly by Charles and the main body from Evesham, strained every nerve to head off Essex at Newbury, and after a sharp skirmish on Alkbourne Chase on the 18th of September succeeded in doing so. On the 19th the whole Royal army was drawn up, facing west, with its right on Newbury and its left on Enborne Heath. Essex's men knew that evening that they would have to break through by force—there was no suggestion of surrender.

11. *First Battle of Newbury, September 20, 1643.*—The ground was densely intersected by hedges except in front of the Royalists' left centre (Newbury Wash) and left (Enborne Heath), and, practically, Essex's army was never formed in line of battle, for each unit was thrown into the fight as it came up its own road or lane. On the left wing, in spite of the Royalist counter-strokes, the attack had the best of it, capturing field after field, and thus gradually gaining ground to the front. Here Lord Falkland was killed. On the Reading road itself Essex did not succeed in deploying on to the open ground on Newbury Wash, but victoriously repelled the royal horse when it charged up to the lanes and hedges held by his foot. On the extreme right of the Parliamentary army, which stood in the open ground of Enborne Heath, took place a famous incident. Here two of the London regiments, fresh to war as they were, were exposed to a trial as severe as that which broke down the veteran Spanish infantry at Rocroi in this same year. Rupert and the Royalist horse again and again charged up to the squares of pikes, and between each charge his guns tried to disorder the Londoners, but it was not until the advance of the royal infantry that the trained bands retired, slowly and in magnificent order, to the edge of the heath. The result of it all was that Essex's army had fought its hardest and failed to break the opposing line. But the Royalists had suffered so heavily, and above all the valour displayed by the rebels had so profoundly impressed them, that they were glad to give up the disputed road and withdraw into Newbury. Essex thereupon pursued his march, Reading was reached on the 22nd after a small rearguard skirmish at Aldermaston, and so ended one of the most dramatic episodes of English history.

12. *Hull and Winceby.*—Meanwhile the siege of Hull had commenced. The Eastern Association forces under Manchester promptly moved up into Lincolnshire, the foot besieging Lynn (which surrendered on the 16th of September) while the horse rode into the northern part of the county to give a hand to the Fairfaxes. Fortunately the sea communications of Hull were open. On the 18th of September part of the cavalry in Hull was ferried over to Barton, and the rest under Sir Thomas Fairfax went by sea to Saltfleet a few days later, the whole joining Cromwell near Spilsby. In return the old Lord Fairfax, who remained in Hull, received infantry reinforcements and a quantity of ammunition and stores from the Eastern Association. On the 11th of October Cromwell and Fairfax together

won a brilliant cavalry action at Winceby, driving the Royalist horse in confusion before them to Newark, and on the same day Newcastle's army around Hull, which had suffered terribly from the hardships of continuous siege work, was attacked by the garrison and so severely handled that next day the siege was given up. Later, Manchester retook Lincoln and Gainsborough, and thus Lincolnshire, which had been almost entirely in Newcastle's hands before he was compelled to undertake the siege of Hull, was added in fact as well as in name to the Eastern Association.

Elsewhere, in the reaction after the crisis of Newbury, the war languished. The city regiments went home, leaving Essex too weak to hold Reading, which the Royalists reoccupied on the 3rd of October. At this the Londoners offered to serve again, and actually took part in a minor campaign around Newport Pagnell, which town Rupert attempted to fortify as a menace to the Eastern Association and its communications with London. Essex was successful in preventing this, but his London regiments again went home, and Sir William Waller's new army in Hampshire failed lamentably in an attempt on Basing House (November 7), the London trained bands deserting *en bloc*. Shortly afterwards Arundel surrendered to a force under Sir Ralph, now Lord Hopton (December 9).

13. *The "Irish Cessation" and the Solemn League and Covenant.*—Politically, these months were the turning-point of the war. In Ireland, the king's lieutenant, by order of his master, made a truce with the Irish rebels (Sept. 15). Charles's chief object was to set free his army to fight in England, but it was believed universally that Irish regiments—in plain words, papists in arms—would shortly follow. Under these circumstances his act united against him nearly every class in Protestant England, above all brought into the English quarrel the armed strength of Presbyterian Scotland. Yet Charles, still trusting to intrigue and diplomacy to keep Scotland in check, deliberately rejected the advice of Montrose, his greatest and most faithful lieutenant, who wished to give the Scots employment for their army at home. Only ten days after the "Irish cessation," the Parliament at Westminster swore to the Solemn League and Covenant, and the die was cast. It is true that even a semblance of Presbyterian theocracy put the "Independents" on their guard and definitely raised the question of freedom of conscience, and that secret negotiations were opened between the Independents and Charles on that basis, but they soon discovered that the king was merely using them as instruments to bring about the betrayal of Aylesbury and other small rebel posts. All parties found it convenient to interpret the Covenant liberally for the present, and at the beginning of 1644 the Parliamentary party showed so united a front that even Pym's death (December 8, 1643) hardly affected its resolution to continue the struggle.

The troops from Ireland, thus obtained at the cost of an enormous political blunder, proved to be untrustworthy after all. Those serving in Hopton's army were "mutinous and shrewdly infected with the rebellious humour of England." When Waller's Londoners surprised¹ and routed a Royalist detachment at Alton (December 13, 1643), half the prisoners took the Covenant. Hopton had to retire, and on the 6th of January 1644 Waller recaptured Arundel. Byron's Cheshire army was in no better case. Newcastle's retreat from Hull and the loss of Gainsborough had completely changed the situation in the midlands, Breton was joined by the younger Fairfax from Lincolnshire, and the Royalists were severely defeated for a second time at Nantwich (January 25). As at Alton, the majority of the prisoners (amongst them Colonel George Monk) took the Covenant and entered the Parliamentary army. In Lancashire, as in Cheshire, Staffordshire, Nottinghamshire and Lincolnshire, the cause of the Parliament was in the ascendant. Resistance revived in the West Riding towns, Lord Fairfax was again in the field in the

¹ For the third time within the year the London trained bands turned out in force. It was characteristic of the early years of the war that imminent danger alone called forth the devotion of the citizen soldier. If he was employed in ordinary times (e.g. at Basing House) he would neither fight nor march with spirit.

East Riding, and even Newark was closely besieged by Sir John Meldrum. More important news came in from the north. The advanced guard of the Scottish army had passed the Tweed on the 19th of January, and the marquis of Newcastle with the remnant of his army would soon be attacked in front and rear at once.

14. *Newark and Cheriton (March 1644).*—As in 1643, Rupert was soon on his way to the north to retrieve the fortunes of his side. Moving by the Welsh border, and gathering up garrisons and recruits snowball-wise as he marched, he went first to Cheshire to give a hand to Byron, and then, with the utmost speed, he made for Newark. On the 20th of March 1644 he bivouacked at Bingham, and on the 21st he not only relieved Newark but routed the besiegers' cavalry. On the 22nd Meldrum's position was so hopeless that he capitulated on terms. But, brilliant soldier as he was, the prince was unable to do more than raid a few Parliamentary posts around Lincoln, after which he had to return his borrowed forces to their various garrisons and go back to Wales—laden indeed with captured pikes and muskets—to raise a permanent field army. But Rupert could not be in all places at once. Newcastle was clamorous for aid. In Lancashire, only the countess of Derby, in Lathom House, held out for the king, and her husband pressed Rupert to go to her relief. Once, too, the prince was ordered back to Oxford to furnish a travelling escort for the queen, who shortly after this gave birth to her youngest child and returned to France. The order was countermanded within a few hours, it is true, but Charles had good reason for avoiding detachments from his own army. On the 29th of March, Hopton had undergone a severe defeat at Cheriton near New Alresford. In the preliminary manoeuvres and in the opening stages of the battle the advantage lay with the Royalists, and the earl of Forth, who was present, was satisfied with what had been achieved and tried to break off the action. But Royalist indiscipline ruined everything. A young cavalry colonel charged in defiance of orders, a fresh engagement opened, and at the last moment Waller snatched a victory out of defeat. Worse than this was the news from Yorkshire and Scotland. Charles had at last assented to Montrose's plan and promised him the title of marquis, but the first attempt to raise the Royalist standard in Scotland gave no omen of its later triumphs. In Yorkshire Sir Thomas Fairfax, advancing from Lancashire through the West Riding, joined his father. Selby was stormed on the 11th of April, and thereupon Newcastle, who had been manoeuvring against the Scots in Durham, hastily drew back, sent his cavalry away, and shut himself up with his foot in York. Two days later the Scottish general, Alexander Leslie, Lord Leven, joined the Fairfaxes and prepared to invest that city.

15. *Plans of Campaign for 1644.*—The original plan of the Parliamentary "Committee of Both Kingdoms," which directed the military and civil policy of the allies after the fashion of a modern cabinet, was to combine Essex's and Manchester's armies in an attack upon the king's army, Aylesbury being appointed as the place of concentration. Waller's troops were to continue to drive back Hopton and to reconquer the west, Fairfax and the Scots to invest Newcastle's army, while in the midlands Brereton and the Lincolnshire rebels could be counted upon to neutralize, the one Byron, the others the Newark Royalists. But Waller, once more deserted by his trained bands, was unable to profit by his victory of Cheriton, and retired to Farnham. Manchester, too, was delayed because the Eastern Association was still suffering from the effects of Rupert's Newark exploit—Lincoln, abandoned by the rebels on that occasion, was not reoccupied till the 6th of May. Moreover, Essex found himself compelled to defend his conduct and motives to the Committee of Both Kingdoms, and as usual was straitened for men and money. But though there were grave elements of weakness on the other side, the Royalists considered their own position to be hopeless. Prince Maurice was engaged in the fruitless siege of Lyme Regis, Gloucester was again a centre of activity and counterbalanced Newark, and the situation in the north was practically desperate. Rupert himself came

to Oxford (April 25) to urge that his new army should be kept free to march to aid Newcastle, who was now threatened—owing to the abandonment of the enemy's original plan—by Manchester as well as Fairfax and Leven. There was no further talk of the concentric advance of three armies on London. The fiery prince and the methodical earl of Brentford (Forth) were at once at least in recommending that the Oxford area with its own garrison and a mobile force in addition should be the pivot of the field armies' operations. Rupert, needing above all adequate time for the development of the northern offensive, was not in favour of abandoning any of the barriers to Essex's advance. Brentford, on the other hand, thought it advisable to contract the lines of defence, and Charles, as usual undecided, agreed to Rupert's scheme and executed Brentford's. Reading, therefore, was dismantled early in May, and Abingdon given up shortly afterwards.

16. *Cropredy Bridge.*—It was now possible for the enemy to approach Oxford, and Abingdon was no sooner evacuated than (May 26) Waller's and Essex's armies united there—still, unfortunately for their cause, under separate commanders. From Abingdon Essex moved direct on Oxford, Waller towards Wantage, where he could give a hand to Massey, the energetic governor of Gloucester. Affairs seemed so bad in the west (Maurice with a whole army was still vainly besieging the single line of low breastworks that constituted the fortress of Lyme) that the king despatched Hopton to take charge of Bristol. Nor were things much better at Oxford; the barriers of time and space and the supply area had been deliberately given up to the enemy, and Charles was practically forced to undertake extensive field operations with no hope of success save in consequence of the enemy's mistakes. The enemy, as it happened, did not disappoint him. The king, probably advised by Brentford, conducted a skilful war of manoeuvre in the area defined by Stourbridge, Gloucester, Abingdon and Northampton, at the end of which Essex, leaving Waller to the secondary work, as he conceived it, of keeping the king away from Oxford and reducing that fortress, marched off into the west with most of the general service troops to repeat at Lyme Regis his Gloucester exploit of 1643. At one moment, indeed, Charles (then in Bewdley) rose to the idea of marching north to join Rupert and Newcastle, but he soon made up his mind to return to Oxford. From Bewdley, therefore, he moved to Buckingham—the distant threat on London producing another evanescent citizen army drawn from six counties under Major-General Browne—and Waller followed him closely. When the king turned upon Browne's motley host, Waller appeared in time to avert disaster, and the two armies worked away to the upper Cherwell. Brentford and Waller were excellent strategists of the 17th century type, and neither would fight a pitched battle without every chance in his favour. Eventually on the 29th of June the Royalists were successful in a series of minor fights about Cropredy Bridge, and the result was, in accordance with continental custom, admitted to be an important victory, though Waller's main army drew off unharmed. In the meantime, Essex had relieved Lyme (June 15) and occupied Weymouth, and was preparing to go farther. The two rebel armies were now indeed separate. Waller had been left to do as best he could, and a worse fate was soon to overtake the cautious earl.

17. *Campaign of Marston Moor.*—During these manoeuvres the northern campaign had been fought to an issue. Rupert's courage and energy were more likely to command success in the English Civil War than all the conscientious caution of an Essex or a Brentford. On the 16th of May he left Shrewsbury to fight his way through hostile country to Lancashire, where he hoped to re-establish the Derby influence and raise new forces. Stockport was plundered on the 25th, the besiegers of Lathom House utterly defeated at Bolton on the 28th. Soon afterwards he received a large reinforcement under General Goring, which included 5000 of Newcastle's cavalry. The capture of the almost defenceless town of Liverpool—undertaken as usual to allay local fears—did not delay Rupert more than three or four days, and he then turned towards the Yorkshire border with

greatly augmented forces. On the 14th of June he received a despatch from the king, the gist of which was that there was a time-limit imposed on the northern enterprise. If York were lost or did not need his help, Rupert was to make all haste southward via Worcester. "If York be relieved and you beat the rebels' armies of both kingdoms, then, but otherways not, I may possibly make a shift upon the defensive to spin out time until you come to assist me."

Charles did manage to "spin out time." But it was of capital importance that Rupert had to do his work upon York and the allied army in the shortest possible time, and that, according to the despatch, there were only two ways of saving the royal cause, "having relieved York by beating the Scots," or marching with all speed to Worcester. Rupert's duty, interpreted through the medium of his temperament, was clear enough. Newcastle still held out, his men having been encouraged by a small success on the 17th of June, and Rupert reached Knaresborough on the 30th. At once Leven, Fairfax and Manchester broke up the siege of York and moved out to meet him. But the prince, moving still at high speed, rode round their right flank via Boroughbridge and Thornton Bridge and entered York on the north side. Newcastle tried to dissuade Rupert from fighting, but his record as a general was scarcely convincing as to the value of his advice. Rupert curtly replied that he had orders to fight, and the Royalists moved out towards Marston Moor (q.v.) on the morning of July 2, 1644. The Parliamentary commanders, fearing a fresh manoeuvre, had already begun to retire towards Tadcaster, but as soon as it became evident that a battle was impending they turned back. The battle of Marston Moor began about four in the afternoon. It was the first real trial of strength between the best elements on either side, and it ended before night with the complete victory of the Parliamentary armies. The Royalist cause in the north collapsed once for all, Newcastle fled to the continent, and only Rupert, resolute as ever, extricated 6000 cavalry from the *débrûle* and rode away whence he had come, still the dominant figure of the war.

18. *Independency.*—The victory gave the Parliament entire control of the north, but it did not lead to the definitive solution of the political problem, and in fact, on the question of Charles's place in a new Constitution, the victorious generals quarrelled even before York had surrendered. Within three weeks of the battle the great army was broken up. The Yorkshire troops proceeded to conquer the isolated Royalist posts in their county, the Scots marched off to besiege Newcastle-on-Tyne and to hold in check a nascent Royalist army in Westmorland. Rupert in Lancashire they neglected entirely. Manchester and Cromwell, already estranged, marched away into the Eastern Association. There, for want of an enemy to fight, their army was forced to be idle, and Cromwell and the ever-growing Independent element quickly came to suspect their commander of lukewarmness in the cause. Waller's army, too, was spiritless and immobile. On the 2nd of July, despairing of the existing military system, he made to the Committee of Both Kingdoms the first suggestion of the New Model.—"My lords," he wrote, "till you have an army merely your own, that you may command, it is . . . impossible to do anything of importance." Browne's trained band army was perhaps the most ill-behaved of all—once the soldiers attempted to murder their own general. Parliament in alarm set about the formation of a new general service force (July 12), but meantime both Waller's and Browne's armies (at Abingdon and Reading respectively) ignominiously collapsed by mutiny and desertion. It was evident that the people at large, with their respect for the law and their anxiety for their own homes, were tired of the war. Only those men—such as Cromwell—who has set their hearts on fighting out the quarrel of conscience, kept steadfastly to their purpose. Cromwell himself had already decided that the king himself must be deprived of his authority, and his supporters were equally convinced. But they were relatively few. Even the Eastern Association trained bands had joined in the disaffection in Waller's army, and that unfortunate general's suggestion of a professional army, with all its dangers, indicated the only means

of enforcing a peace such as Cromwell and his friends desired. There was this important difference, however, between Waller's idea and Cromwell's achievement—that the professional soldiers of the New Model were disciplined, led, and in all things inspired by "godly" officers. Godliness, devotion to the cause, and efficiency were indeed the only criteria Cromwell applied in choosing officers. Long before this he had warned the Scottish major-general Lawrence Crawford that the precise colour of a man's religious opinions mattered nothing compared with his devotion to them, and had told the committee of Suffolk, "I had rather have a plain russet-coated captain that knows what he fights for and loves what he knows than that which you call a 'gentleman' and is nothing else. I honour a gentleman that is so indeed . . . but seeing it was necessary the work must go on, better plain men than none." If "men of honour and birth" possessed the essentials of godliness, devotion, and capacity, Cromwell preferred them, and as a fact only seven out of thirty-seven of the superior officers of the original New Model were not of gentle birth.

19. *Lostwithiel.*—But all this was as yet in the future. Essex's military promenade in the west of England was the subject of immediate interest. At first successful, this general penetrated to Plymouth, whence, securely based as he thought, he could overrun Devon. Unfortunately for him he was persuaded to overrun Cornwall as well. At once the Cornishmen rose, as they had risen under Hopton, and the king was soon on the march from the Oxford region, disregarding the armed mobs under Waller and Browne. Their state reflected the general languishing of the war spirit on both sides, not on one only, as Charles discovered when he learned that Lord Wilmot, the lieutenant-general of his horse, was in correspondence with Essex. Wilmot was of course placed under arrest, and was replaced by the dissolute General Goring. But it was unpleasantly evident that even gay cavaliers of the type of Wilmot had lost the ideals for which they fought, and had come to believe that the realm would never be at peace while Charles was king. Henceforward it will be found that the Royalist foot, now a thoroughly professional force, is superior in quality to the once superb cavalry, and that not merely because its opportunities for plunder, &c., are more limited. Materially, however, the immediate victory was undeniably with the Royalists. After a brief period of manoeuvre, the Parliamentary army, now far from Plymouth, found itself surrounded and starving at Lostwithiel, on the Fowey river, without hope of assistance. The horse cut its way out through the investing circle of posts, Essex himself escaped by sea, but Major-General Skippon, his second in command, had to surrender with the whole of the foot on the 2nd of September. The officers and men were allowed to go free to Portsmouth, but their arms, guns and munitions were the spoil of the victors. There was now no trustworthy field force in arms for the Parliament south of the Humber, for even the Eastern Association army was distracted by its religious differences, which had now at last come definitely to the front and absorbed the political dispute in a wider issue. Cromwell already proposed to abolish the peerage, the members of which were inclined to make a hollow peace, and had ceased to pay the least respect to his general, Manchester, whose scheme for the solution of the quarrel was an impossible combination of Charles and Presbyterianism. Manchester for his part sank into a state of mere obstinacy, refusing to move against Rupert, even to besiege Newark, and actually threatened to hang Colonel Lilburne for capturing a Royalist castle without orders.

20. *Operations of Essex's, Waller's and Manchester's Armies.*—After the success of Lostwithiel there was little to detain Charles's main army in the extreme west, and meanwhile Banbury, a most important point in the Oxford circle, and Basing House (near Basingstoke) were in danger of capture. Waller, who had organized a small force of reliable troops, had already sent cavalry into Dorsetshire with the idea of assisting Essex, and he now came himself with reinforcements to prevent, so far as lay in his power, the king's return to the Thames valley. Charles was accompanied of course only by his permanent forces and

by parts of Prince Maurice's and Hopton's armies—the Cornish levies had as usual scattered as soon as the war receded from their borders. Manchester slowly advanced to Reading, Essex gradually reorganized his broken army at Portsmouth, while Waller, far out to the west at Shaftesbury, endeavored to gain the necessary time and space for a general concentration in Wiltshire, where Charles would be far from Oxford and Basing and, in addition, outnumbered by two to one. But the work of rearming Essex's troops proceeded slowly for want of money, and Manchester peevishly refused to be hurried either by his more vigorous subordinates or by the Committee of Both Kingdoms, saying that the army of the Eastern Association was for the guard of its own employers and not for general service. He pleaded the renewed activity of the Newark Royalists as his excuse, forgetting that Newark would have been in his hands ere this had he chosen to move thither instead of lying idle for two months. As to the higher command, things had come to such a pass that, when the three armies at last united, a council of war, consisting of three army commanders, several senior officers, and two civilian delegates from the Committee, was constituted. When the vote of the majority had determined what was to be done, Essex, as lord general of the Parliament's first army, was to issue the necessary orders for the whole. Under such conditions it was not likely that Waller's hopes of a great battle at Shaftesbury would be realized. On the 8th of October he fell back, the royal army following him step by step and finally reaching Whitechurch on the 20th of October. Manchester arrived at Basingstoke on the 17th, Waller on the 19th, and Essex on the 21st. Charles had found that he could not relieve Basing (a mile or two from Basingstoke) without risking a battle with the enemy between himself and Oxford;¹ he therefore took the Newbury road and relieved Donnington Castle near Newbury on the 22nd. Three days later Banbury too was relieved by a force which could now be spared from the Oxford garrison. But for once the council of war on the other side was for fighting a battle, and the Parliamentary armies, their spirits revived by the prospect of action and by the news of the fall of Newcastle and the defeat of a sally from Newark, marched briskly. On the 26th they appeared north of Newbury on the Oxford road. Like Essex in 1643, Charles found himself headed off from the shelter of friendly fortresses, but beyond this fact there is little similarity between the two battles of Newbury, for the Royalists in the first case merely drew a barrier across Essex's path. On the present occasion the eager Parliamentarians made no attempt to force the king to attack them; they were well content to attack him in his chosen position themselves, especially as he was better off for supplies and quarters than they.

21. *Second Newbury.*—The second battle of Newbury is remarkable as being the first great manœuvre-battle (as distinct from "pitched" battle) of the Civil War. A preliminary reconnaissance by the Parliamentary leaders (Essex was not present, owing to illness) established the fact that the king's infantry held a strong line of defence behind the Lambourn brook from Shaw (inclusive) to Donnington (exclusive), Shaw House and adjacent buildings being held as an advanced post. In rear of the centre, in open ground just north of Newbury, lay the bulk of the royal cavalry. In the left rear of the main line, and separated from it by more than a thousand yards, lay Prince Maurice's corps at Speen, advanced troops on the high ground west of that village, but Donnington Castle, under its energetic governor Sir John Boys, formed a strong post covering this gap with artillery fire. The Parliamentary leaders had no intention of flinging their men away in a frontal attack on the line of the Lambourn, and a flank attack from the east side could hardly succeed owing to the obstacle presented by the confluence of the Lambourn and the Kennet, hence they decided on a wide turning movement via Chieveley, Winterbourne and Wickham Heath, against Prince Maurice's position—a decision which, daring and energetic

¹ Charles's policy was still, as before Marston Moor, to "spin out time" until Rupert came back from the north.

as it was, led only to a modified success, for reasons which will appear. The flank march, out of range of the castle, was conducted with punctuality and precision. The troops composing it were drawn from all three armies and led by the best fighting generals, Waller, Cromwell, and Essex's subordinates Balfour and Skippon. Manchester at Clay Hill was to stand fast until the turning movement had developed, and to make a vigorous holding attack on Shaw House as soon as Waller's guns were heard at Speen. But there was no commander-in-chief to co-ordinate the movements of the two widely separated corps, and consequently no co-operation. Waller's attack was not unexpected, and Prince Maurice had made ready to meet him. Yet the first rush of the rebels carried the entrenchments of Speen Hill, and Speen itself, though stoutly defended, fell into their hands within an hour, Essex's infantry recapturing here some of the guns they had had to surrender at Lostwithiel. But meantime Manchester, in spite of the entreaties of his staff, had not stirred from Clay Hill. He had made one false attack already early in the morning, and been severely handled, and he was aware of his own deficiencies as a general. A year before this he would have asked for and acted upon the advice of a capable soldier, such as Cromwell or Crawford, but now his mind was warped by a desire for peace on any terms, and he sought only to avoid defeat pending a happy solution of the quarrel. Those who sought to gain peace through victory were meanwhile driving Maurice back from hedge to hedge towards the open ground at Newbury, but every attempt to emerge from the lanes and fields was repulsed by the royal cavalry, and indeed by every available man and horse, for Charles's officers had gauged Manchester's intentions, and almost stripped the front of its defenders to stop Waller's advance. Nightfall put an end to the struggle around Newbury, and then—too late—Manchester ordered the attack on Shaw House. It failed completely in spite of the gallantry of his men, and darkness being then complete it was not renewed. In its general course the battle closely resembled that of Freiburg (*q.v.*), fought the same year on the Rhine. But, if Waller's part in the battle corresponded in a measure to Turenne's, Manchester was unequal to playing the part of Condé, and consequently the results, in the case of the French won by three days' hard fighting, and even then comparatively small, were in the case of the English practically nil. During the night the royal army quietly marched away through the gap between Waller's and Manchester's troops. The heavy artillery and stores were left in Donnington Castle, Charles himself with a small escort rode off to the north-west to meet Rupert, and the main body gained Wallingford unmolested. An attempt at pursuit was made by Waller and Cromwell with all the cavalry they could lay hands on, but it was unsupported, for the council of war had decided to content itself with besieging Donnington Castle. A little later, after a brief and half-hearted attempt to move towards Oxford, it referred to the Committee for further instructions. Within the month Charles, having joined Rupert at Oxford and made him general of the Royalist forces *vice* Brentford, reappeared in the neighbourhood of Newbury. Donnington Castle was again relieved (November 9) under the eyes of the Parliamentary army, which was in such a miserable condition that even Cromwell was against fighting, and some manœuvres followed, in the course of which Charles relieved Basing House and the Parliamentary armies fell back, not in the best order, to Reading. The season for field warfare was now far spent, and the royal army retired to enjoy good quarters and plentiful supplies around Oxford.

22. *The Self-Sensory Ordinance.*—On the other side, the dissensions between the generals had become flagrant and public, and it was no longer possible for the Houses of Parliament to ignore the fact that the army must be radically reformed. Cromwell and Waller from their places in parliament attacked Manchester's conduct, and their attack ultimately became, so far as Cromwell was concerned, an attack on the Lords, most of whom held the same views as Manchester, and on the Scots, who attempted to bring Cromwell to trial as an "incendiary." At the crisis of their bitter controversy Cromwell suddenly

proposed to stifle all animosities by the resignation of all officers who were members of either House, a proposal which affected himself not less than Essex and Manchester. The first "self-denying ordinance" was moved on the 9th of December, and provided that "no member of either house shall have or execute any office or command . . ." &c. This was not accepted by the Lords, and in the end a second "self-denying ordinance" was agreed to (April 3, 1645), whereby all the persons concerned were to resign, but without prejudice to their reappointment. Simultaneously with this, the formation of the New Model was at last definitely taken into consideration. The last exploit of Sir William Waller, who was not re-employed after the passing of the ordinance, was the relief of Taunton, then besieged by General Goring's army. Cromwell served as his lieutenant-general on this occasion, and we have Waller's own testimony that he was in all things a wise, capable and respectful subordinate. Under a leader of the stamp of Waller, Cromwell was well satisfied to obey, knowing the cause to be in good hands.

23. *Decline of the Royalist Cause.*—A raid of Goring's horse from the west into Surrey and an unsuccessful attack on General Browne at Abingdon were the chief enterprises undertaken on the side of the Royalists during the early winter. It was no longer "summer in Devon, summer in Yorkshire" as in January 1643. An ever-growing section of Royalists, amongst whom Rupert himself was soon to be numbered, were for peace; many scores of loyalist gentlemen, impoverished by the loss of three years' rents of their estates and hopeless of ultimate victory, were making their way to Westminster to give in their submission to the Parliament and to pay their fines. In such circumstances the old decision-seeking strategy was impossible. The new plan, suggested probably by Rupert, had already been tried with strategical success in the summer campaign of 1644. As we have seen, it consisted essentially in using Oxford as the centre of a circle and striking out radially at any favourable target—"manœuvring about a fixed point," as Napoleon called it. It was significant of the decline of the Royalist cause that the "fixed point" had been in 1643 the king's field army, based indeed on its great entrenched camp, Banbury-Cirencester-Reading-Oxford, but free to move and to hold the enemy wherever met, while now it was the entrenched camp itself, weakened by the loss or abandonment of its outer posts, and without the power of binding the enemy if they chose to ignore its existence, that conditioned the scope and duration of the single remaining field army's enterprises.

24. *The New Model Ordinance.*—For the present, however, Charles's cause was crumbling more from internal weakness than from the blows of the enemy. Fresh negotiations for peace which opened on the 29th of January at Uxbridge (by the name of which place they are known to history) occupied the attention of the Scots and their Presbyterian friends, the rise of Independence and of Cromwell was a further distraction, and over the new army and the Self-denying Ordinance the Lords and Commons were seriously at variance. But in February a fresh mutiny in Waller's command struck alarm into the hearts of the disputants. The "treaty" of Uxbridge came to the same end as the treaty of Oxford in 1643, and a settlement as to army reform was achieved on the 15th of February. Though it was only on the 25th of March that the second and modified form of the ordinance was agreed to by both Houses, Sir Thomas Fairfax and Philip Skippon (who were not members of parliament) had been approved as lord general and major-general (of the infantry) respectively of the new army as early as the 21st of January. The post of lieutenant-general and cavalry commander was for the moment left vacant, but there was little doubt as to who would eventually occupy it.

25. *Victories of Montrose.*—In Scotland, meanwhile, Montrose was winning victories which amazed the people of the two kingdoms. Montrose's royalism differed from that of Englishmen of the 17th century less than from that of their forefathers under Henry VIII. and Elizabeth. To him the king was the protector of his people against Presbyterian theocracy, scarcely less offensive to him than the Inquisition itself, and the feudal

oppression of the great nobles. Little as this ideal corresponded to the Charles of reality, it inspired in Montrose not merely romantic heroism but a force of leadership which was sufficient to carry to victory the nobles and gentry, the wild Highlanders and the experienced professional soldiers who at various times and places constituted his little armies. His first unsuccessful enterprise has been mentioned above. It seemed, in the early stages of his second attempt (August 1644), as if failure were again inevitable, for the gentry of the northern Lowlands were overawed by the prevailing party and resented the leadership of a lesser noble, even though he were the king's lieutenant over all Scotland. Disappointed of support where he most expected it, Montrose then turned to the Highlands. At Blair Athol he gathered his first army of Royalist clansmen, and good fortune gave him also a nucleus of trained troops. A force of disciplined experienced soldiers (chiefly Irish Macdonalds and commanded by Alastair of that name) had been sent over from Ireland earlier in the year, and, after ravaging the glens of their hereditary enemies the Campbells, had attempted without success, now here, now there, to gather the other clans in the king's name. Their hand was against every man's, and when he finally arrived in Badenoch, Alastair Macdonald was glad to protect himself by submitting to the authority of the king's lieutenant.

There were three hostile armies to be dealt with, besides—ultimately—the main covenanting army far away in England. The duke of Argyll, the head of the Campbells, had an army of his own clan and of Lowland Covenanter levies, Lord Elcho with another Lowland army lay near Perth, and Lord Balfour of Burleigh was collecting a third (also composed of Lowlanders) at Aberdeen. Montrose turned upon Elcho first, and found him at Tippermuir near Perth on the 1st of September 1644. The Royalists were about 3000 strong and entirely foot, only Montrose himself and two others being mounted, while Elcho had about 7000 of all arms. But Elcho's townsmen found that pike and musket were clumsy weapons in inexperienced hands, and, like Mackay's regulars at Killiecrankie fifty years later, they wholly failed to stop the rush of the Highland swordsmen. Many hundreds were killed in the pursuit, and Montrose slept in Perth that night, having thus accounted for one of his enemies. Balfour of Burleigh was to be his next victim, and he started for Aberdeen on the 4th. As he marched, his Highlanders slipped away to place their booty in security. But the Macdonald regulars remained with him, and as he passed along the coast some of the gentry came in, though the great western clan of the Gordons was at present too far divided in settlement to take his part. Lord Lewis Gordon and some Gordon horse were even in Balfour's army. On the other hand, the earl of Airlie brought in forty-four horsemen, and Montrose was thus able to constitute two wings of cavalry on the day of battle. The Covenanters were about 2500 strong and drawn up on a slope above the How Burn¹ just outside Aberdeen (September 13, 1644). Montrose, after clearing away the enemy's skirmishers, drew up his army in front of the opposing line, the foot in the centre, the forty-four mounted men, with musketeers to support them, on either flank. The hostile left-wing cavalry charged piecemeal, and some bodies of troops did not engage at all. On the other wing, however, Montrose was for a moment hard pressed by a force of the enemy that attempted to work round to his rear. But he brought over the small band of mounted men that constituted his right wing cavalry, and also some musketeers from the centre, and destroyed the assailants, and when the ill-led left wing of the Covenanters charged again, during the absence of the cavalry, they were mown down by the close-range volleys of Macdonald's musketeers. Shortly afterwards the centre of Balfour's army yielded to pressure and fled in disorder. Aberdeen was sacked by order of Montrose, whose drummer had been murdered while delivering a message under a flag of truce to the magistrates.

26. *Inverlochy.*—Only Argyll now remained to be dealt with. The Campbells were fighting men from birth, like Montrose's own men, and had few townsmen serving with them. Still there were enough of the latter and of the impedimenta of regular

¹The ground has been entirely built over for many years.

warfare with him to prevent Argyll from overtaking his 'agile enemy, and ultimately after a "hide-and-seek" in the districts of Rothiemurchus, Blair Athol, Banchory and Strathbogie, Montrose stood to fight at Fyvie Castle, repulsed Argyll's attack on that place and slipped away again to Rothiemurchus. There he was joined by Camerons and Macdonalds from all quarters for a grand raid on the Campbell country; he himself wished to march into the Lowlands, well knowing that he could not achieve the decision in the Grampians, but he had to bow, not for the first time nor the last, to local impotency. The raid was duly executed, and the Campbells' boast, "It's a far cry to Loch Awe," availed them little. In December and January the Campbell lands were thoroughly and mercilessly devastated, and Montrose then retired slowly to Loch Ness, where the bulk of his army as usual dispersed to store away its plunder. Argyll, with such Highland and Lowland forces as he could collect after the disaster, followed Montrose towards Lochaber, while the Seaforth and other northern clans marched to Loch Ness. Caught between them, Montrose attacked the nearest. The Royalists crossed the hills into Glen Roy, worked thence along the northern face of Ben Nevis, and descended like an avalanche upon Argyll's forces at Inverlochry (February 2, 1645). As usual, the Lowland regiments gave way at once—Montrose had managed in all this to keep with him a few cavalry—and it was then the turn of the Campbells. Argyll, escaped in a boat, but his clan, as a fighting force, was practically annihilated, and Montrose, having won four victories in these six winter months, rested his men and exultingly promised Charles that he would come to his assistance with a brave army before the end of the summer.

27. *Organisation of the New Model Army.*—To return to the New Model. Its first necessity was regular pay; its first duty to serve wherever it might be sent. Of the three armies that had fought at Newbury only one, Essex's, was in a true sense a general service force, and only one, Manchester's, was paid with any regularity. Waller's army was no better paid than Essex's and no more free from local ties than Manchester's. It was therefore broken up early in April, and only 600 of its infantry passed into the New Model. Essex's men, on the other hand, wanted but regular pay and strict officers to make them excellent soldiers, and their own major-general, Skippon, managed by tact and his personal popularity to persuade the bulk of the men to rejoin Manchester's army, in which Cromwell had been the guiding influence from first to last, was naturally the backbone of the New Model. Early in April Essex, Manchester, and Waller resigned their commissions, and such of their forces as were not embodied in the new army were sent to do local duties, for minor armies were still maintained, General Poyntz's in the north midlands, General Massey's in the Severn valley, a large force in the Eastern Association, General Browne's in Buckinghamshire, &c., besides the Scots in the north.

The New Model originally consisted of 14,400 foot and 3700 horse and dragoons. Of the infantry only 6000 came from the combined armies, the rest being new recruits furnished by the press.¹ Thus there was considerable trouble during the first months of Fairfax's command, and discipline had to be enforced with unusual sternness. As for the enemy, Oxford was openly contemptuous of "the rebels' new brutish general" and his men, who seemed hardly likely to succeed where Essex and Waller had failed. But the effect of the Parliament's having "an army all its own" was soon to be apparent.

28. *First Operations of 1645.*—On the Royalist side the campaign of 1645 opened in the west, whither the young prince of Wales (Charles II.) was sent with Hyde (later earl of Clarendon), Hopton and others as his advisers. General (Lord) Goring, however, now in command of the Royalist field forces in this quarter, was truculent, insubordinate and dissolute, though on the rare occasions when he did his duty he displayed a certain degree of skill and leadership, and the influence of the prince's

¹ The Puritans had by now disappeared almost entirely from the ranks of the infantry. *Per contra* the officers and sergeants and the troopers of the horse were the sternest Puritans of all, the survivors of three years of a disheartening war.

counsellors was but small. As usual, operations began with the sieges necessary to conciliate local feeling. Plymouth and Lyme were blocked up, and Taunton again invested. The reinforcement thrown into the last place by Waller and Cromwell was dismissed by Blake (then a colonel in command of the fortress and afterwards the great admiral of the Commonwealth), and after many adventures rejoined Waller and Cromwell. The latter generals, who had not yet laid down their commissions, then engaged Goring for some weeks, but neither side having infantry or artillery, and both finding subsistence difficult in February and March and in country that had been fought over for two years past, no results were to be expected. Taunton still remained unrelieved, and Goring's horse still rode all over Dorsetshire when the New Model at last took the field.

29. *Rupert's Northern March.*—In the midlands and Lancashire the Royalist horse, as ill-behaved even as Goring's men, were directly responsible for the ignominious failure with which the king's main army began its year's work. Prince Maurice was joined at Ludlow by Rupert and part of his Oxford army early in March, and the brothers drove off Brereton from the siege of Beeston Castle and relieved the pressure on Lord Byron in Cheshire. So great was the danger of Rupert's again invading Lancashire and Yorkshire that all available forces in the north, English and Scots, were ordered to march against him. But at this moment the prince was called back to clear his line of retreat on Oxford. The Herefordshire and Worcestershire peasantry, weary of military exactions, were in arms, and though they would not join the Parliament, and for the most part dispersed after stating their grievances, the main enterprise was wrecked. This was but one of many ill-armed crowds—"Clubmen" as they were called—that assembled to enforce peace on both parties. A few regular soldiers were sufficient to disperse them in all cases, but their attempt to establish a third party in England was morally as significant as it was materially futile. The Royalists were now fighting with the courage of despair, those who still fought against Charles did so with the full determination to ensure the triumph of their cause, and with the conviction that the only possible way was the annihilation of the enemy's armed forces, but the majority were so weary of the war that the earl of Manchester's Presbyterian royalism—which had contributed so materially to the prolongation of the struggle—would probably have been accepted by four-fifths of all England as the basis of a peace. It was, in fact, in the face of almost universal opposition that Fairfax and Cromwell and their friends at Westminster guided the cause of their weaker comrades to complete victory.

30. *Cromwell's Raid.*—Having without difficulty rid himself of the Clubmen, Rupert was eager to resume his march into the north. It is unlikely that he wished to join Montrose, though Charles himself favoured that plan, but he certainly intended to fight the Scottish army, more especially as after Inverlochry it had been called upon to detach a large force to deal with Montrose. But this time there was no Royalist army in the north to provide infantry and guns for a pitched battle, and Rupert had perforce to wait near Hereford till the main body, and in particular the artillery train, could come from Oxford and join him. It was on the march of the artillery train to Hereford that the first operations of the New Model centred. The infantry was not yet ready to move, in spite of all Fairfax's and Skippon's efforts, and it became necessary to send the cavalry by itself to prevent Rupert from gaining a start. Cromwell, then under Waller's command, had come to Windsor to resign his commission as required by the Self-denying Ordinance. Instead, he was placed at the head of a brigade of his own old soldiers, with orders to stop the march of the artillery train. On the 23rd of April he started from Watlington north-westward. At dawn on the 24th he routed a detachment of Royalist horse at Islip. On the same day, though he had no guns and only a few firearms in the whole force, he terrified the governor of Bletchingdon House into surrender. Riding thence to Witney, Cromwell won another cavalry fight at Bampton-in-the-Bush on the 27th, and attacked Faringdon House, though without success, on the

29th. Thence he marched at leisure to Newbury. He had done his work thoroughly. He had demoralized the Royalist cavalry, and, above all, had carried off every horse on the country-side. To all Rupert's entreaties Charles could only reply that the guns could not be moved till the 7th of May, and he even summoned Goring's cavalry from the west to make good his losses.

31. *Civilian Strategy*.—Cromwell's success thus forced the king to concentrate his various armies in the neighbourhood of Oxford, and the New Model had, so Fairfax and Cromwell hoped, found its target. But the Committee of Both Kingdoms on the one side, and Charles, Rupert and Goring on the other, held different views. On the 1st of May Fairfax, having been ordered to relieve Taunton, set out from Windsor for the long march to that place; meeting Cromwell at Newbury on the 2nd, he directed the lieutenant-general to watch the movements of the king's army, and himself marched on to Blandford, which he reached on the 7th of May. Thus Fairfax and the main army of the Parliament were marching away in the west while Cromwell's detachment was left, as Waller had been left the previous year, to hold the king as best he could. On the very evening that Cromwell's raid ended, the leading troops of Goring's command destroyed part of Cromwell's own regiment near Faringdon, and on the 3rd Rupert and Maurice appeared with a force of all arms at Burford. Yet the Committee of Both Kingdoms, though aware on the 29th of Goring's move, only made up its mind to stop Fairfax on the 3rd, and did not send off orders till the 5th. These orders were to the effect that a detachment was to be sent to the relief of Taunton, and that the main army was to return. Fairfax gladly obeyed, even though a siege of Oxford and not the enemy's field army was the objective assigned him. But long before he came up to the Thames valley the situation was again changed. Rupert, now in possession of the guns and their teams, urged upon his uncle the resumption of the northern enterprise, calculating that with Fairfax in Somersetshire, Oxford was safe. Charles accordingly marched out of Oxford on the 7th towards Stow-on-the-Wold, on the very day, as it chanced, that Fairfax began his return march from Blandford. But Goring and most of the other generals were for a march into the west, in the hope of dealing with Fairfax as they had dealt with Essex in 1644. The armies therefore parted as Essex and Waller had parted at the same place in 1644, Rupert and the king to march northward, Goring to return to his independent command in the west. Rupert, not unnaturally wishing to keep his influence with the king and his authority as general of the king's army unimpaired by Goring's notorious indiscipline, made no attempt to prevent the separation, which in the event proved wholly unprofitable. The flying column from Blandford relieved Taunton long before Goring's return to the west, and Colonel Weldon and Colonel Graves, its commanders, set him at defiance even in the open country. As for Fairfax, he was out of Goring's reach preparing for the siege of Oxford.

32. *Charles in the Midlands*.—On the other side also the generals were working by data that had ceased to have any value. Fairfax's siege of Oxford, ordered by the Committee on the 10th of May, and persisted in after it was known that the king was on the move, was the second great blunder of the year and was hardly redeemed, as a military measure, by the visionary scheme of assembling the Scots, the Yorkshiremen, and the midland forces to oppose the king. It is hard to understand how, having created a new model army "all its own" for general service, the Parliament at once tied it down to a local enterprise, and trusted an improvised army of local troops to fight the enemy's main army. In reality the Committee seems to have been misled by false information to the effect that Goring and the governor of Oxford were about to declare for the Parliament, but had they not despatched Fairfax to the relief of Taunton in the first instance the necessity for such intrigues would not have arisen. However, Fairfax obeyed orders, invested Oxford, and, so far as he was able without a proper siege train, besieged it for two weeks, while Charles and Rupert ranged the midlands unopposed. At the end of that time came news so alarming that the Committee hastily

abdicated their control over military operations and gave Fairfax a free hand. "Black Tom" gladly and instantly abandoned the siege and marched northward to give battle to the king.

Meanwhile Charles and Rupert were moving northward. On the 11th of May they reached Droitwich, whence after two days' rest they marched against Brereton. The latter hurriedly raised the sieges he had on hand, and called upon Yorkshire and the Scottish army there for aid. But only the old Lord Fairfax and the Yorkshiremen responded. Leven had just heard of new victories won by Montrose, and could do no more than draw his army and his guns over the Pennine chain into Westmorland in the hope of being in time to bar the king's march on Scotland via Carlisle.

33. *Dundee*.—After the destruction of the Campbells at Inverlochy, Montrose had cleared away the rest of his enemies without difficulty. He now gained a respectable force of cavalry by the adhesion of Lord Gordon and many of his clan, and this reinforcement was the more necessary as detachments from Leven's army under Baillie and Hurry—disciplined infantry and cavalry—were on the march to meet him. The Royalists marched by Elgin and through the Gordon country to Aberdeen, and thence across the Esk to Coupar-Angus, where Baillie and Hurry were encountered. A war of manoeuvre followed, in which they thwarted every effort of the Royalists to break through into the Lowlands, but in the end retired into Fife. Montrose thereupon marched into the hills with the intention of reaching the upper Forth and thence the Lowlands, for he did not disguise from himself the fact that there, and not in the Highlands, would the quarrel be decided, and was sanguine—over-sanguine, as the event proved—as to the support he would obtain from those who hated the kirk and its system. But he had called to his aid the semi-barbarous Highlanders, and however much the Lowlands resented a Presbyterian inquisition, they hated and feared the Highland clans beyond all else. He was equally disappointed in his own army. For a war of positions the Highlanders had neither aptitude nor inclination, and at Dunkeld the greater part of them went home. If the small remnant was to be kept to its duty, plunder must be found, and the best objective was the town of Dundee. With a small force of 750 foot and horse Montrose brilliantly surprised that place on the 4th of April, but Baillie and Hurry were not far distant, and before Montrose's men had time to plunder the prize they were collected to face the enemy. His retreat from Dundee was considered a model operation by foreign students of the art of war (then almost as numerous as now), and what surprised them most was that Montrose could rally his men after a sack had begun. The retreat itself was remarkable enough. Baillie moved parallel to Montrose on his left flank towards Arbroath, constantly heading him off from the hills and attempting to pin him against the sea. Montrose, however, halted in the dark so as to let Baillie get ahead of him and then turned sharply back, crossed Baillie's track, and made for the hills. Baillie soon realized what had happened and turned back also, but an hour too late. By the 6th the Royalists were again safe in the broken country of the Esk valley. But Montrose cherished no illusions as to joining the king at once; all he could do, he now wrote, was to neutralize as many of the enemy's forces as possible.

34. *Auldearn*.—For a time he wandered in the Highlands seeking recruits. But soon he learned that Baillie and Hurry had divided their forces, the former remaining about Perth and Stirling to observe him, the latter going north to suppress the Gordons. Strategy and policy combined to make Hurry the objective of the next expedition. But the soldier of fortune who commanded the Covenanters at Aberdeen was no mean antagonist. Marching at once with a large army (formed on the nucleus of his own trained troops and for the rest composed of clammén and volunteers) Hurry advanced to Elgin, took contact with Montrose there, and, gradually and skilfully retiring, drew him into the hostile country round Inverness. Montrose fell into the trap, and Hurry took his measures to surprise him at Auldearn so successfully that (May 9) Montrose, even though the

indiscipline of some of Hurry's young soldiers during the night march gave him the alarm, had barely time to form up before the enemy was upon him. But the best strategy is of no avail when the battle it produces goes against the strategist, and Montrose's tactical skill was never more conspicuous than at Auldearn. Alastair Macdonald with most of the Royalist infantry and the Royal standard was posted to the right (north) of the village to draw upon himself the weight of Hurry's attack; only enough men were posted in the village itself to show that it was occupied, and on the south side, out of sight, was Montrose himself with a body of foot and all the Gordon horse. It was the prototype, on a small scale, of Austerlitz. Macdonald resisted sturdily while Montrose edged away from the scene of action, and at the right moment and not before, though Macdonald had been driven back on the village and was fighting for life amongst the gardens and enclosures, Montrose let loose Lord Gordon's cavalry. These, abandoning for once the pistol tactics of their time, charged home with the sword. The enemy's right wing cavalry was scattered in an instant, the nearest infantry was promptly ridden down, and soon Hurry's army had ceased to exist.

35. *Campaign of Naseby.*—If the news of Auldearn brought Leven to the region of Carlisle, it had little effect on his English allies. Fairfax was not yet released from the siege of Oxford, in spite of the protests of the Scottish representatives in London. Massey, the active and successful governor of Gloucester, was placed in command of a field force on the 25th of May, but he was to lead it against, not the king, but Goring. At that moment the military situation once more changed abruptly. Charles, instead of continuing his march on to Lancashire, turned due eastward towards Derbyshire. The alarm at Westminster when this new development was reported was such that Cromwell, in spite of the Self-Denying Ordinance, was sent to raise an army for the defence of the Eastern Association. Yet the Royalists had no intentions in that direction. Conflicting reports as to the condition of Oxford reached the royal headquarters in the last week of May, and the eastward march was made chiefly to "spin out time" until it could be known whether it would be necessary to return to Oxford, or whether it was still possible to fight Leven in Yorkshire—his move into Westmorland was not yet known—and invade Scotland by the easy east coast route.

Goring's return to the west had already been countermanded and he had been directed to march to Harborough, while the South Wales Royalists were also called in towards Leicester. Later orders (May 26) directed him to Newbury, whence he was to feel the strength of the enemy's positions around Oxford. It is hardly necessary to say that Goring found good military reasons for continuing his independent operations, and marched off towards Taunton regardless of the order. He redressed the balance there for the moment by overawing Massey's weak force, and his purse profited considerably by fresh opportunities for extortion, but he and his men were not at Naseby. Meanwhile the king, at the geographical centre of England, found an important and wealthy town at his mercy. Rupert, always for action, took the opportunity, and Leicester was stormed and thoroughly pillaged on the night of the 30th-31st of May. There was the usual panic at Westminster, but, unfortunately for Charles, it resulted in Fairfax being directed to abandon the siege of Oxford and given *carte blanche* to bring the Royal army to battle wherever it was met. On his side the king had, after the capture of Leicester, accepted the advice of those who feared for the safety of Oxford—Rupert, though commander-in-chief, was unable to insist on the northern enterprise—and had marched to Daventry, where he halted to throw supplies into Oxford. Thus Fairfax in his turn was free to move, thanks to the insubordination of Goring, who would neither relieve Oxford nor join the king for an attack on the New Model. The Parliamentary general moved from Oxford towards Northampton so as to cover the Eastern Association. On the 12th of June the two armies were only a few miles apart, Fairfax at Kilsbury, Charles at Daventry, and, though the Royalists turned northward again on the 13th to resume the Yorkshire project under the very eyes of the enemy, Fairfax followed close. On the night of

the 13th Charles slept at Lubenham, Fairfax at Guilsborough. Cromwell, just appointed lieutenant-general of the New Model, had ridden into camp on the morning of the 13th with fresh cavalry from the eastern counties, Colonel Rossiter came up with more from Lincolnshire on the morning of the battle, and it was with an incontestable superiority of numbers and an overwhelming moral advantage that Fairfax fought at Naseby (9.7.) on the 14th of June. The result of the battle, this time a decisive battle, was the annihilation of the Royal army. Part of the cavalry escaped, a small fraction of it in tolerable order, but the guns and the baggage train were taken, and, above all, the splendid Royal infantry were killed or taken prisoners to a man.

36. *Effects of Naseby.*—After Naseby, though the war dragged on for another year, the king never succeeded in raising an army as good as, or even more numerous than, that which Fairfax's army had so heavily outnumbered on the 14th of June. That the fruits of the victory could not be gathered in a few weeks was due to a variety of hindrances rather than to direct opposition—to the absence of rapid means of communication, the paucity of the forces engaged on both sides relatively to the total numbers under arms, and from time to time to the political exigencies of the growing quarrel between Presbyterians and Independents. As to the latter, within a few days of Naseby, the Scots rejoiced that the "back of the malignants was broken," and demanded reinforcements as a precaution against "the insolence of others," i.e. Cromwell and the Independents—"to whom alone the Lord has given the victory of that day." Leven had by now returned to Yorkshire, and a fortnight after Naseby, after a long and honourable defence by Sir Thomas Glemham, Carlisle fell to David Leslie's besieging corps. Leicester was reoccupied by Fairfax on the 18th, and on the 20th Leven's army, moving slowly southward, reached Mansfield. This move was undertaken largely for political reasons, i.e. to restore the Presbyterian balance as against the victorious New Model. Fairfax's army was intended by its founders to be a specifically English army, and Cromwell for one would have employed it against the Scots almost as readily as against malignants. But for the moment the advance of the northern army was of the highest military importance, for Fairfax was thereby set free from the necessity of undertaking sieges. Moreover, the publication of the king's papers taken at Naseby gave Fairfax's troops a measure of official and popular support which a month before they could not have been said to possess, for it was now obvious that they represented the armed force of England against the Irish, Danes, French, Lorrainers, &c., whom Charles had for three years been endeavouring to let loose on English soil. Even the Presbyterians abandoned for the time any attempt to negotiate with the king, and advocated a vigorous prosecution of the war.

37. *Fairfax's Western Campaign.*—This, in the hands of Fairfax and Cromwell, was likely to be effective. While the king and Rupert, with the remnant of their cavalry, hurried into South Wales to join Sir Charles Gerard's troops and to raise fresh infantry, Fairfax decided that Goring's was the most important Royalist army in the field, and turned to the west, reaching Lechlade on the 26th, less than a fortnight after the battle of Naseby. One last attempt was made to dictate the plan of campaign from Westminster, but the Committee refused to pass on the directions of the Houses, and he remained free to deal with Goring as he desired. Time pressed; Charles in Monmouthshire and Rupert at Bristol were well placed for a junction with Goring, which would have given them a united army 15,000 strong. Taunton, in spite of Massey's efforts to keep the field, was again besieged, and in Wilts and Dorset numerous bands of Clubmen were on foot which the king's officers were doing their best to turn into troops for their master. But the process of collecting a fresh royal army was slow, and Goring and his subordinate, Sir Richard Grenville, were alienating the king's most devoted adherents by their rapacity, cruelty and debauchery. Moreover, Goring had no desire to lose the independent command he had extorted at Stow-on-the-Wald in May.

Still, it was clear that he must be disposed of as quickly as possible, and Fairfax requested the Houses to take other measures against the king (June 26). This they did by paying up the arrears due to Leven's army and bringing it to the Severn valley. On the 8th of July Leven reached Alcester, bringing with him a Parliamentarian force from Derbyshire under Sir John Gell. The design was to besiege Hereford.

38. *Langport*.—By that time Fairfax and Goring were at close quarters. The Royalist general's line of defence faced west along the Yeo and the Parrett between Yeovil and Bridgwater, and thus barred the direct route to Taunton. Fairfax, however, marched from Lechlade via Marlborough and Blandford—hindered only by Clubmen—to the friendly posts of Dorchester and Lyme, and with these as his centre of operations he was able to turn the headwaters of Goring's river-line via Beaminster and Crewkerne. The Royalists at once abandoned the south and west side of the rivers—the siege of Taunton had already been given up—and passed over to the north and east bank. Bridgwater was the right of this second line as it had been the left of the first; the new left was at Ilchester. Goring could thus remain in touch with Charles in south Wales through Bristol, and the siege of Taunton having been given up there was no longer any incentive for remaining on the wrong side of the water-line. But his army was thoroughly demoralized by its own licence and indiscipline, and the swift, handy and resolute regiments of the New Model made short work of its strong positions. On the 7th of July, demonstrating against the points of passage between Ilchester and Langport, Fairfax secretly occupied Yeovil. The post at that place, which had been the right of Goring's first position, had, perhaps rightly, been withdrawn to Ilchester when the second position was taken up, and Fairfax repaired the bridge without interruption. Goring showed himself unequal to the new situation. He might, if sober, make a good plan when the enemy was not present to disturb him, and he certainly led cavalry charges with boldness and skill. But of strategy in front of the enemy he was incapable. On the news from Yeovil he abandoned the line of the Yeo as far as Langport without striking a blow, and Fairfax, having nothing to gain by continuing his détour through Yeovil, came back and quietly crossed at Long Sutton, west of Ilchester (July 9). Goring had by now formed a new plan. A strong rearguard was posted at Langport and on high ground east and north-east of it to hold Fairfax, and he himself with the cavalry rode off early on the 8th to try and surprise Taunton. This place was no longer protected by Massey's little army, which Fairfax had called up to assist his own. But Fairfax, who was not yet across Long Sutton bridge, heard of Goring's raid in good time, and sent Massey after him with a body of horse. Massey surprised a large party of the Royalists at Ilminster on the 9th, wounded Goring himself, and pursued the fugitives up to the south-eastern edge of Langport. On the 10th Fairfax's advanced guard, led by Major Bethel of Cromwell's own regiment, brilliantly stormed the position of Goring's rearguard east of Langport, and the cavalry of the New Model, led by Cromwell himself, swept in pursuit right up to the gates of Bridgwater, where Goring's army, dismayed and on the point of collapse, was more or less rallied. Thence Goring himself retired to Barnstaple. His army, under the regimental officers, defended itself in Bridgwater resolutely till the 23rd of July, when it capitulated. The fall of Bridgwater gave Fairfax complete control of Somerset and Dorset from Lyme to the Bristol channel. Even in the unlikely event of Goring's raising a fresh army, he would now have to break through towards Bristol by open force, and a battle between Goring and Fairfax could only have one result. Thus Charles had perforce to give up his intention of joining Goring—his recruiting operations in south Wales had not been so successful as he hoped, owing to the apathy of the people and the vigour of the local Parliamentary leaders—and to resume the northern enterprise begun in the spring.

39. *Schemes of Lord Digby*.—This time Rupert would not be with him. The prince, now despairing of success and hoping only for a peace on the best terms procurable, listlessly returned

to his governorship of Bristol and prepared to meet Fairfax's impending attack. The influence of Rupert was supplanted by that of Lord Digby. As sanguine as Charles and far more energetic, he was for the rest of the campaign the guiding spirit of the Royalists, but being a civilian he proved incapable of judging the military factors in the situation from a military standpoint, and not only did he offend the officers by constituting himself a sort of confidential military secretary to the king, but he was distrusted by all sections of Royalists for his reckless optimism. The resumption of the northern enterprise, opposed by Rupert and directly inspired by Digby, led to nothing. Charles marched by Bridgnorth, Lichfield and Ashbourne to Doncaster, where on the 18th of August he was met by great numbers of Yorkshire gentlemen with promises of fresh recruits. For a moment the outlook was bright, for the Derbyshire men with Gell were far away at Worcester with Leven, the Yorkshire Parliamentarians engaged in besieging Scarborough Castle, Pontefract and other posts. But two days later he heard that David Leslie with the cavalry of Leven's army was coming up behind him, and that, the Yorkshire sieges being now ended, Major-General Poyntz's force lay in his front. It was now impossible to wait for the new levies, and reluctantly the king turned back to Oxford, raiding Huntingdonshire and other parts of the hated Eastern Association *en route*.

40. *Montrose's Last Victories*.—David Leslie did not pursue him. Montrose, though the king did not yet know it, had won two more battles, and was practically master of all Scotland. After Auldearn he had turned to meet Baillie's army in Strathspye, and by superior mobility and skill forced that commander to keep at a respectful distance. He then turned upon a new army which Lindsay, titular earl of Crawford, was forming in Forfarshire, but that commander betook himself to a safe distance, and Montrose withdrew into the Highlands to find recruits (June). The victors of Auldearn had mostly dispersed on the usual errand, and he was now deserted by most of the Gordons, who were recalled by the chief of their clan, the marquess of Huntly, in spite of the indignant remonstrances of Huntly's heir, Lord Gordon, who was Montrose's warmest admirer. Baillie now approached again, but he was weakened by having to find trained troops to stiffen Lindsay's levies; and a strong force of the Gordons had now been persuaded to rejoin Montrose. The two armies met in battle near Alford on the Don; little can be said of the engagement save that Montrose had to fight, cautiously and tentatively as at Aberdeen, not in the decision-forcing spirit of Auldearn, and that in the end Baillie's cavalry gave way and his infantry was cut down as it stood. Lord Gordon was amongst the Royalist dead (July 2). The plunder was put away in the glens before any attempt was made to go forward, and thus the Covenanters had leisure to form a numerous, if not very coherent, army on the nucleus of Lindsay's troops. Baillie, much against his will, was continued in the command, with a council of war (chiefly of nobles whom Montrose had already defeated, such as Argyll, Elcho and Balfour) to direct his every movement. Montrose, when rejoined by the Highlanders, moved to meet him, and in the last week of July and the early part of August there were manoeuvres and minor engagements round Perth. About the 7th of August Montrose suddenly slipped away into the Lowlands, heading for Glasgow. Thereupon another Covenanting army began to assemble in Clydesdale. But it was clear that Montrose could beat mere levies, and Baillie, though without authority and despairing of success, hurried after him. Montrose then, having drawn Baillie's Fifeshire militia far enough from home to ensure their being discontented, turned upon them on the 14th of August near Kilsyth. Baillie protested against fighting, but his aristocratic masters of the council of war decided to cut off Montrose from the hills by turning his left wing. The Royalist general seized the opportunity, and his advance caught them in the very act of making a flank march (August 15). The head of the Covenanters' column was met and stopped by the furious attack of the Gordon infantry, and Alastair Macdonald led the men of his own name and the Macleans against its flank. A breach was made in the centre of Baillie's army at the first rush, and then

Montrose sent in the Gordon and Ogilvy horse. The leading half of the column was surrounded, broken up and annihilated. The rear half, seeing the fate of its comrades, took to flight, but in vain, for the Highlanders pursued *à outrance*. Only about one hundred Covenanting infantry out of six thousand escaped. Montrose was now indeed the king's lieutenant in all Scotland.

41. *Fall of Bristol.*—But Charles was in no case to resume his northern march. Fairfax and the New Model, after reducing Bridgwater, had turned back to clear away the Dorsetshire Clubmen and to besiege Sherborne Castle. On the completion of this task, it had been decided to besiege Bristol, and on the 23rd of August—while the king's army was still in Huntingdon, and Goring was trying to raise a new army to replace the one he had lost at Langport and Bridgwater—the city was invested. In these urgent circumstances Charles left Oxford for the west only a day or two after he had come in from the Eastern Association raid. Calculating that Rupert could hold out longest, he first moved to the relief of Worcester, around which place Leven's Scots, no longer having Leslie's cavalry with them to find supplies, were more occupied with plundering their immediate neighbourhood for food than with the siege works. Worcester was relieved on the 1st of September by the king. David Leslie with all his cavalry was already on the march to meet Montrose, and Leven had no alternative but to draw off his infantry without fighting. Charles entered Worcester on the 8th, but he found that he could no longer expect recruits from South Wales. Worse was to come. A few hours later, on the night of the 9th–10th, Fairfax's army stormed Bristol. Rupert had long realized the hopelessness of further fighting—the very summons to surrender sent in by Fairfax placed the fate of Bristol on the political issue,—the lines of defence around the place were too extensive for his small force, and on the 11th he surrendered on terms. He was escorted to Oxford with his men, conversing as he rode with the officers of the escort about peace and the future of his adopted country. Charles, almost stunned by the suddenness of the catastrophe, dismissed his nephew from all his offices and ordered him to leave England, and for almost the last time called upon Goring to rejoin the main army—if a tiny force of raw infantry and disheartened cavalry can be so called—in the neighbourhood of Raglan. But before Goring could be brought to withdraw his objections Charles had again turned northward towards Montrose. A weary march through the Welsh hills brought the Royal army on the 22nd of September to the neighbourhood of Chester. Charles himself with one body entered the city, which was partially invested by the Parliamentarian colonel Michael Jones, and the rest under Sir Marmaduke Langdale was sent to take Jones's lines in reverse. But at the opportune moment Poyntz's forces, which had followed the king's movements since he left Doncaster in the middle of August, appeared in rear of Langdale, and defeated him in the battle of Rowton Heath (September 24), while at the same time a sortie of the king's troops from Chester was repulsed by Jones. Thereupon the Royal army withdrew to Denbigh, and Chester, the only important seaport remaining to connect Charles with Ireland, was again besieged.

42. *Philiphaugh.*—Nor was Montrose's position, even after Kilsyth, encouraging, in spite of the persistent rumours of fighting in Westmorland that reached Charles and Digby. Glasgow and Edinburgh were indeed occupied, and a parliament summoned in the king's name. But Montrose had now to choose between Highlanders and Lowlanders. The former, strictly kept away from all that was worth plundering, rapidly vanished, even Alastair Macdonald going with the rest. Without the Macdonalds and the Gordons, Montrose's military and political resettlement of Scotland could only be shadowy, and when he demanded support from the sturdy middle classes of the Lowlands, it was not forgotten that he had led Highlanders to the sack of Lowland towns. Thus his new supporters could only come from amongst the discontented and undisciplined Border lords and gentry, and long before these moved to join him the romantic conquest of Scotland was over. On the 6th of September David Leslie had recrossed the frontier with his cavalry and some

infantry he had picked up on the way through northern England. Early on the morning of the 13th he surprised Montrose at Philiphaugh near Selkirk. The king's lieutenant had only 650 men against 4000, and the battle did not last long. Montrose escaped with a few of his principal adherents, but his little army was annihilated. Of the veteran Macdonald infantry, 500 strong that morning, 250 were killed in the battle and the remainder put to death after accepting quarter. The Irish, even when they bore a Scottish name, were, by Scotsmen even more than Englishmen, regarded as beasts to be knocked on the head. After Naseby the Irishwomen found in the king's camp were branded by order of Fairfax; after Philiphaugh more than 300 women, wives or followers of Macdonald's men, were butchered. Montrose's Highlanders at their worst were no more cruel than the sober soldiers of the kirk.

43. *Digby's Northern Expedition.*—Charles received the news of Philiphaugh on the 28th of September, and gave orders that the west should be abandoned, the prince of Wales should be sent to France, and Goring should bring up what forces he could to the Oxford region. On the 4th of October Charles himself reached Newark (whither he had marched from Denbigh after revictualing Chester and suffering the defeat of Rowton Heath). The intention to go to Montrose was of course given up, at any rate for the present, and he was merely waiting for Goring and the Royalist militia of the west—each in its own way a broken reed to lean upon. A hollow reconciliation was patched up between Charles and Rupert, and the court remained at Newark for over a month. Before it set out to return to Oxford another Royalist force had been destroyed. On the 14th of October, receiving information that Montrose had raised a new army, the king permitted Langdale's northern troops to make a fresh attempt to reach Scotland. At Langdale's request Digby was appointed to command in this enterprise, and, civilian though he was, and disastrous though his influence had been to the discipline of the army, he led it boldly and skilfully. His immediate opponent was Poyntz, who had followed the king step by step from Doncaster to Chester and back to Welbeck, and he succeeded on the 15th in surprising Poyntz's entire force of foot at Sherburn. Poyntz's cavalry were soon after this reported approaching from the south, and Digby hoped to trap them also. At first all went well and body after body of the rebels was routed. But by a singular mischance the Royalist main body mistook the Parliamentary squadrons in flight through Sherburn for friends, and believing all was lost took to flight also. Thus Digby's cavalry fled as fast as Poyntz's and in the same direction, and the latter, coming to their senses first, drove the Royalist horse in wild confusion as far as Skipton. Lord Digby was still sanguine, and from Skipton he actually penetrated as far as Dumfries. But whether Montrose's new army was or was not in the Lowlands, it was certain that Leven and Leslie were on the Border, and the mad adventure soon came to an end. Digby, with the mere handful of men remaining to him, was driven back into Cumberland, and on the 24th of October, his army having entirely disappeared, he took ship with his officers for the Isle of Man. Poyntz had not followed him beyond Skipton, and was now watching the king from Nottingham, while Royster with the Lincoln troops was posted at Grantham. The king's chances of escaping from Newark were becoming smaller day by day, and they were not improved by a violent dispute between him and Rupert, Maurice, Lord Gerard and Sir Richard Willis, at the end of which these officers and many others rode away to ask the Parliament for leave to go over-seas. The pretext of the quarrel mattered little, the distinction between the views of Charles and Digby on the one hand and Rupert and his friends on the other was fundamental—to the latter peace had become a political as well as a military necessity. Meanwhile south Wales, with the single exception of Raglan Castle, had been overrun by the Parliamentarians. Everywhere the Royalist posts were falling. The New Model, no longer fearing Goring, had divided, Fairfax reducing the garrisons of Dorset and Devon, Cromwell those of Hampshire. Amongst the latter was the famous Basing House, which was stormed at dawn on the

24th of October and burnt to the ground. Cromwell, his work finished, returned to headquarters, and the army wintered in the neighbourhood of Crediton.

44. *End of the First War.*—The military events of 1646 call for no comment. The only field army remaining to the king was Goring's, and though Hopton, who sorrowfully accepted the command after Goring's departure, tried at the last moment to revive the memories and the local patriotism of 1643, it was of no use to fight against the New Model with the armed rabble that Goring turned over to him. Dartmouth surrendered on January 18, Hopton was defeated at Torrington on February 16, and surrendered the remnant of his worthless army on March 14. Exeter fell on April 13. Elsewhere, Hereford was taken on December 17, 1645, and the last battle of the war was fought and lost at Stow-on-the-Wold by Lord Astley on March 21, 1646. Newark and Oxford fell respectively on May 6 and June 24. On August 31 Montrose escaped from the Highlands. On the 19th of the same month Raglan Castle surrendered, and the last Royalist post of all, Harlech Castle, maintained the useless struggle until March 13, 1647. Charles himself, after leaving Newark in November 1645, had spent the winter in and around Oxford, whence, after an adventurous journey, he came to the camp of the Scottish army at Southwell on May 5, 1646.

45. *Second Civil War (1648-52).*—The close of the First Civil War left England and Scotland in the hands potentially of any one of the four parties or any combination of two or more that should prove strong enough to dominate the rest. Armed political Royalism was indeed at an end, but Charles, though practically a prisoner, considered himself and was, almost to the last, considered by the rest as necessary to ensure the success of whichever amongst the other three parties could come to terms with him. Thus he passed successively into the hands of the Scots, the Parliament and the New Model, trying to reverse the verdict of arms by coquetting with each in turn. The Presbyterians and the Scots, after Cornet Joyce of Fairfax's horse seized upon the person of the king for the army (June 3, 1647), began at once to prepare for a fresh civil war, this time against Independency, as embodied in the New Model—henceforward called the Army—and after making use of its sword, its opponents attempted to disband it, to send it on foreign service, to cut off its arrears of pay, with the result that it was exasperated beyond control, and, remembering not merely its grievances but also the principle for which it had fought, soon became the most powerful political party in the realm. From 1646 to 1648 the breach between army and parliament widened day by day until finally the Presbyterian party, combined with the Scots and the remaining Royalists, felt itself strong enough to begin a second civil war.

46. *The English War.*—In February 1648 Colonel Poyer, the Parliamentary governor of Pembroke Castle, refused to hand over his command to one of Fairfax's officers, and he was soon joined by some hundreds of officers and men, who mutinied, ostensibly for arrears of pay, but really with political objects. At the end of March, encouraged by minor successes, Poyer openly declared for the king. Disbanded soldiers continued to join him in April, all South Wales revolted, and eventually he was joined by Major-General Laugharne, his district commander, and Colonel Powel. In April also news came that the Scots were arming and that Berwick and Carlisle had been seized by the English Royalists. Cromwell was at once sent off at the head of a strong detachment to deal with Laugharne and Poyer. But before he arrived Laugharne had been severely defeated by Colonel Horton at St Fagans (May 8). The English Presbyterians found it difficult to reconcile their principles with their allies when it appeared that the prisoners taken at St Fagans bore "We long to see our King" on their hats; very soon in fact the English war became almost purely a Royalist revolt, and the war in the north an attempt to enforce a mixture of Royalism and Presbyterianism on Englishmen by means of a Scottish army. The former were disturbers of the peace and no more. Nearly all the Royalists who had fought in the First Civil War had given their parole not to bear arms against the

Parliament, and many honourable Royalists, foremost amongst them the old Lord Astley, who had fought the last battle for the king in 1646, refused to break their word by taking any part in the second war. Those who did so, and by implication those who abetted them in doing so, were likely to be treated with the utmost rigour if captured, for the army was in a less placable mood in 1648 than in 1645, and had already determined to "call Charles Stuart, that man of blood, to an account for the blood he had shed." On the 21st of May Kent rose in revolt in the king's name. A few days later a most serious blow to the Independents was struck by the defection of the navy, from command of which they had removed Vice-Admiral Batten, as being a Presbyterian. Though a former lord high admiral, the earl of Warwick, also a Presbyterian, was brought back to the service, it was not long before the navy made a purely Royalist declaration and placed itself under the command of the prince of Wales. But Fairfax had a clearer view and a clearer purpose than the distracted Parliament. He moved quickly into Kent, and on the evening of June 1 stormed Maidstone by open force, after which the local levies dispersed to their homes, and the more determined Royalists, after a futile attempt to induce the City of London to declare for them, fled into Essex. In Cornwall, Northamptonshire, North Wales and Lincolnshire the revolt collapsed as easily. Only in South Wales, Essex and the north of England was there serious fighting. In the first of these districts Cromwell rapidly reduced all the fortresses except Pembroke, where Laugharne, Poyer and Powel held out with the desperate courage of deserters. In the north, Pontefract was surprised by the Royalists, and shortly afterwards Scarborough Castle declared for the king. Fairfax, after his success at Maidstone and the pacification of Kent, turned northward to reduce Essex, where, under their ardent, experienced and popular leader Sir Charles Lucas, the Royalists were in arms in great numbers. He soon drove the enemy into Colchester, but the first attack on the town was repulsed and he had to settle down to a long and wearisome siege *en règle*. A Surrey rising, remembered only for the death of the young and gallant Lord Francis Villiers in a skirmish at Kingston (July 7), collapsed almost as soon as it had gathered force, and its leaders, the duke of Buckingham and the earl of Holland, escaped, after another attempt to induce London to declare for them, to St Albans and St Neots, where Holland was taken prisoner. Buckingham escaped over-seas.

47. *Lambert in the North.*—By the 10th of July therefore the military situation was well defined. Cromwell held Pembroke, Fairfax Colchester, Lambert Pontefract under siege; elsewhere all serious local risings had collapsed, and the Scottish army had crossed the Border. It is on the adventures of the latter that the interest of the war centres. It was by no means the veteran army of Leven, which had long been disbanded. For the most part it consisted of raw levies, and as the kirk had refused to sanction the enterprise of the Scottish parliament, David Leslie and thousands of experienced officers and men declined to serve. The duke of Hamilton proved to be a poor substitute for Leslie; his army, too, was so ill provided that as soon as England was invaded it began to plunder the countryside for the bare means of sustenance. Major-General Lambert, a brilliant young general of twenty-nine, was more than equal to the situation. He had already left the sieges of Pontefract and Scarborough to Colonel Rossiter, and hurried into Cumberland to deal with the English Royalists under Sir Marmaduke Langdale. With his cavalry he got into touch with the enemy about Carlisle and slowly fell back, fighting small rearguard actions to annoy the enemy and gain time, to Bowes and Barnard Castle. Langdale did not follow him into the mountains, but occupied himself in gathering recruits and supplies of material and food for the Scots. Lambert, reinforced from the midlands, reappeared early in June and drove him back to Carlisle with his work half finished. About the same time the local horse of Durham and Northumberland were put into the field by Sir A. Hesilrige, governor of Newcastle, and under the command of Colonel Robert Lilburne won a considerable success (June 30) at the river Coquet. This reverse, coupled with the existence of Langdale's

force on the Cumberland side, practically compelled Hamilton to choose the west coast route for his advance, and his army began slowly to move down the long *couloir* between the mountains and the sea. The campaign which followed is one of the most brilliant in English history.

48. *Campaign of Preston.*—On the 8th of July the Scots, with Langdale as advanced guard, were about Carlisle, and reinforcements from Ulster were expected daily. Lambert's horse were at Penrith, Hexham and Newcastle, too weak to fight and having only skillful leading and rapidity of movement to enable them to gain time. Far away to the south Cromwell was still tied down before Pembroke, Fairfax before Colchester. Elsewhere the rebellion, which had been put down by rapidity of action rather than sheer weight of numbers, smouldered, and Prince Charles and the fleet cruised along the Essex coast. Cromwell and Lambert, however, understood each other perfectly, while the Scottish commanders quarrelled with Langdale and each other. Appleby Castle surrendered to the Scots on the 31st of July, whereat Lambert, who was still hanging on to the flank of the Scottish advance, fell back from Barnard Castle to Richmond so as to close Wensleydale against any attempt of the invaders to march on Pontefract. All the restless energy of Langdale's horse was unable to dislodge him from the passes or to find out what was behind that impenetrable cavalry screen. The crisis was now at hand. Cromwell had received the surrender of Pembroke on the 11th, and had marched off, with his men unpaid, ragged and shoeless, at full speed through the midlands. Rains and storms delayed his march, but he knew that Hamilton in the broken ground of Westmorland was still worse off. Shoes from Northampton and stockings from Coventry met him at Nottingham, and, gathering up the local levies as he went, he made for Doncaster, where he arrived on the 8th of August, having gained six days in advance of the time he had allowed himself for the march. He then called up artillery from Hull, exchanged his local levies for the regulars who were besieging Pontefract, and set off to meet Lambert. On the 12th he was at Wetherby, Lambert with horse and foot at Otley, Langdale at Skipton and Gargrave, Hamilton at Lancaster, and Sir George Monro with the Scots from Ulster and the Carlisle Royalists (organized as a separate command owing to friction between Monro and the generals of the main army) at Hornby. On the 13th, while Cromwell was marching to join Lambert at Otley, the Scottish leaders were still disputing as to whether they should make for Pontefract or continue through Lancashire so as to join Lord Byron and the Cheshire Royalists.

49. *Preston Fight.*—On the 14th Cromwell and Lambert were at Skipton, on the 15th at Gisburn, and on the 16th they marched down the valley of the Ribble towards Preston with full knowledge of the enemy's dispositions and full determination to attack him. They had with them horse and foot not only of the army, but also of the militia of Yorkshire, Durham, Northumberland and Lancashire, and withal were heavily outnumbered, having only 8600 men against perhaps 20,000 of Hamilton's command. But the latter were scattered for convenience of supply along the road from Lancaster, through Preston, towards Wigan, Langdale's corps having thus become the left flank guard instead of the advanced guard. Langdale called in his advanced parties, perhaps with a view to resuming the duties of advanced guard, on the night of the 13th, and collected them near Longridge. It is not clear whether he reported Cromwell's advance, but, if he did, Hamilton ignored the report, for on the 17th Monro was half a day's march to the north, Langdale east of Preston, and the main army strung out on the Wigan road, Major-General Baillie with a body of foot, the rear of the column, being still in Preston. Hamilton, yielding to the impotency of his lieutenant-general, the earl of Callendar, sent Baillie across the Ribble to follow the main body just as Langdale, with 3000 foot and 500 horse only, met the first shock of Cromwell's attack on Preston Moor. Hamilton, like Charles at Edgehill, passively shared in, without directing, the battle, and, though Langdale's men fought magnificently, they were after four hours' struggle driven to the Ribble. Baillie

attempted to cover the Ribble and Darwen bridges on the Wigan road, but Cromwell had forced his way across both before night-fall. Pursuit was at once undertaken, and not relaxed until Hamilton had been driven through Wigan and Winwick to Uttoxeter and Ashbourne. There, pressed furiously in rear by Cromwell's horse and held up in front by the militia of the midlands, the remnant of the Scottish army laid down its arms on the 25th of August. Various attempts were made to raise the Royalist standard in Wales and elsewhere, but Preston was the death-blow. On the 28th of August, starving and hopeless of relief, the Colchester Royalists surrendered to Lord Fairfax. The victors in the Second Civil War were not merciful to those who had brought war into the land again. On the evening of the surrender of Colchester, Sir Charles Lucas and Sir George Lisle were shot. Laugharne, Poyer and Powel were sentenced to death, but Poyer alone was executed on the 25th of April 1649, being the victim selected by lot. Of five prominent Royalist peers who had fallen into the hands of the Parliament, three, the duke of Hamilton, the earl of Holland, and Lord Capel, one of the Colchester prisoners and a man of high character, were beheaded at Westminster on the 9th of March. Above all, after long hesitations, even after renewal of negotiations, the army and the Independents "purged" the House of their ill-wishers, and created a court for the trial and sentence of the king. The more resolute of the judges nerved the rest to sign the death-warrant, and Charles was beheaded at Whitehall on the 30th of January.

50. *Cromwell in Ireland.*—The campaign of Preston was undertaken under the direction of the Scottish parliament, not the kirk, and it needed the execution of the king to bring about a union of all Scottish parties against the English Independents. Even so, Charles II. in exile had to submit to long negotiations and hard conditions before he was allowed to put himself at the head of the Scottish armies. The marquis of Huntly was executed for taking up arms for the king on the 22nd of March 1649. Montrose, under Charles's directions, made a last attempt to rally the Scottish Royalists early in 1650. But Charles merely used Montrose as a threat to obtain better conditions for himself from the Covenanters, and when the noblest of all the Royalists was defeated (Carbisdale, April 27), delivered up to his pursuers (May 4), and executed (May 21, 1650), he was not ashamed to give way to the demands of the Covenanters, and to place himself at the head of Montrose's executioners. His father, whatever his faults, had at least chosen to die for an ideal, the Church of England. Charles II. now proposed to regain the throne by allowing Scotland to impose Presbyterianism on England, and dismissed all the faithful Cavaliers who had followed him to exile. Meanwhile, Ireland, in which a fresh war, with openly anti-English and anti-Protestant objects, had broken out in 1648, was thoroughly reduced to order by Cromwell, who beat down all resistance by his skill, and even more by his ruthless severity, in a brief campaign of nine months (battle of Rathmines near Dublin, won by Colonel Michael Jones, August 2, 1649; storming of Drogheda, September 11, and of Wexford, October 11, by Cromwell; capture of Kilkenny, March 28, 1650, and of Clonmel, May 10). Cromwell returned to England at the end of May 1650, and on June 26 Fairfax, who had been anxious and uneasy since the execution of the king, resigned the command-in-chief of the army to his lieutenant-general. The pretext, rather than the reason, of Fairfax's resignation was his unwillingness to lead an English army to reduce Scotland.

51. *The Invasion of Scotland.*—This important step had been resolved upon as soon as it was clear that Charles II. would come to terms with the Covenanters. From this point the Second Civil War becomes a war of England against Scotland. Here at least the Independents carried the whole of England with them. No Englishman cared to accept a settlement at the hands of a victorious foreign army, and on the 28th of June, five days after Charles II. had sworn to the Covenant, the new lord-general was on his way to the Border to take command of the English army. About the same time a new militia act was passed that was destined to give full and decisive effect to the

national spirit of England in the great final campaign of the war. Meanwhile the motto *frappes fort, frappes vite* was carried out at once by the regular forces. On the 19th of July 1650 Cromwell made the final arrangements at Berwick-on-Tweed. Major-General Harrison, a gallant soldier and an extreme Independent, was to command the regular and auxiliary forces left in England, and to secure the Commonwealth against Royalists and Presbyterians. Cromwell took with him Fleetwood as lieutenant-general and Lambert as major-general, and his forces numbered about 10,000 foot and 3000 horse. His opponent David Leslie (his comrade of Marston Moor) had a much larger force, but its degree of training was inferior, it was more than tainted by the political dimensions of the people at large, and it was, in great part at any rate, raised by forced enlistment. On the 22nd of July Cromwell crossed the Tweed. He marched on Edinburgh by the sea coast, through Dunbar, Haddington and Musselburgh, living almost entirely on supplies landed by the fleet which accompanied him—for the country itself was incapable of supporting even a small army—and on the 29th he found Leslie's army drawn up and entrenched in a position extending from Leith to Edinburgh.

52. *Operations around Edinburgh.*—The same day a sharp but indecisive fight took place on the lower slopes of Arthur's Seat, after which Cromwell, having felt the strength of Leslie's line, drew back to Musselburgh. Leslie's horse followed him up sharply, and another action was fought, after which the Scots assaulted Musselburgh without success. Militarily Leslie had the best of it in these affairs, but it was precisely this moment that the kirk party chose to institute a searching three days' examination of the political and religious-sentiments of his army. The result was that the army was "purged" of 80 officers and 3000 soldiers as it lay within musket shot of the enemy. Cromwell was more concerned, however, with the supply question than with the distracted army of the Scots. On the 6th of August he had to fall back as far as Dunbar to enable the fleet to land supplies in safety, the port of Musselburgh being unsafe in the violent and stormy weather which prevailed. He soon returned to Musselburgh and prepared to force Leslie to battle. In preparation for an extended manoeuvre three days' rations were served out. Tents were also issued, perhaps for the first time in the civil wars, for it was a regular professional army, which had to be cared for, made comfortable and economized, that was now carrying on the work of the volunteers of the first war. Even after Cromwell started on his manoeuvre, the Scottish army was still in the midst of its political troubles, and, certain though he was that nothing but victory in the field would give an assured peace, he was obliged to intervene in the confused negotiations of the various Scottish parties. At last, however, Charles II. made a show of agreeing to the demands of his strange supporters, and Leslie was free to move. Cromwell had now entered the hill country, with a view to occupying Queensferry and thus blocking up Edinburgh. Leslie had the shorter road and barred the way at Corstorphine Hill (August 21). Cromwell, though now far from his base, manoeuvred again to his right, Leslie meeting him once more at Gogar (August 27). The Scottish lines at that point were strong enough to dismay even Cromwell, and the manoeuvre on Queensferry was at last given up. It had cost the English army severe losses in sick, and much suffering in the autumn nights on the bleak hillsides.

53. *Dunbar.*—On the 28th Cromwell fell back on Musselburgh, and on the 31st, after embarking his non-effective men, to Dunbar. Leslie followed him up, and wished to fight a battle at Dunbar on Sunday, the 1st of September. But again the kirk intervened, this time to forbid Leslie to break the Sabbath, and the unfortunate Scottish commander could only establish himself on Doon Hill (see DUNBAR) and send a force to Cockburnspath to bar the Berwick road. He had now 23,000 men to Cromwell's 11,000, and proposed, *faute de mieux*, to starve Cromwell into surrender. But the English army was composed of "ragged soldiers with bright muskets," and had a great captain of undisputed authority at their head. Leslie's, on the other hand,

had lost such discipline as it had ever possessed, and was now, under outside influences, thoroughly disintegrated. Cromwell wrote home, indeed, that he was "upon an engagement very difficult," but, desperate as his position seemed, he felt the pulse of his opponent and steadily refused to take his army away by sea. He had not to wait long. It was now the turn of Leslie's men on the hillside to endure patiently privation and exposure, and after one night's bivouac, Leslie, too readily inferring that the enemy was about to escape by sea, came down to fight. The battle of Dunbar (*q.v.*) opened in the early morning of the 3rd of September. It was the most brilliant of all Oliver's victories. Before the sun was high in the heavens the Scottish army had ceased to exist.

54. *Royalism in Scotland.*—After Dunbar it was easy for the victorious army to overrun southern Scotland, more especially as the dissensions of the enemy were embittered by the defeat of which they had been the prime cause. The kirk indeed put Dunbar to the account of its own remissness in not purging their army more thoroughly, but, as Cromwell wrote on the 4th of September, the kirk had "done its do." "I believe their king will set up on his own score," he continued, and indeed, now that the army of the kirk was destroyed and they themselves were secure behind the Forth and based on the friendly Highlands, Charles and the Cavaliers were in a position not only to defy Cromwell, but also to force the Scottish national spirit of resistance to the invader into a purely Royalist channel. Cromwell had only received a few drafts and reinforcements from England, and for the present he could but block up Edinburgh Castle (which surrendered on Christmas eve), and try to bring up adequate forces and material for the siege of Stirling—an attempt which was frustrated by the badness of the roads and the violence of the weather. The rest of the early winter of 1650 was thus occupied in semi-military, semi-political operations between detachments of the English army and certain armed forces of the kirk party which still maintained a precarious existence in the western Lowlands, and in police work against the moss-troopers of the Border counties. Early in February 1651, still in the midst of terrible weather, Cromwell made another resolute but futile attempt to reach Stirling. This time he himself fell sick, and his losses had to be made good by drafts of recruits from England, many of whom came most unwillingly to serve in the cold wet bivouacs that the newspapers had graphically reported.¹

55. *The English Militia.*—About this time there occurred in England two events which had a most important bearing on the campaign. The first was the detection of a widespread Royalist-Presbyterian conspiracy—how widespread no one knew, for those of its promoters who were captured and executed certainly formed but a small fraction of the whole number. Harrison was ordered to Lancashire in April to watch the north Welsh, Isle of Man and Border Royalists, and military precautions were taken in various parts of England. The second was the revival of the militia. Since 1644 there had been no general employment of local forces, the quarrel having fallen into the hands of the regular armies by force of circumstances. The New Model, though a national army, resembled Wellington's Peninsular army more than the soldiers of the French Revolution and the American Civil War. It was now engaged in prosecuting a war of aggression against the hereditary foe over the Border—strictly the task of a professional army with a national basis. The militia was indeed raw and untrained. Some of the Essex men "fell flat on their faces on the sound of a cannon." In the north of England Harrison complained to Cromwell of the "badness" of his men, and the lord general sympathized, having "had much such stuff" sent him to make good the losses in trained men. Even he for a moment lost touch with the spirit of the people. His recruits were unwilling drafts for foreign service, but in England the new levies were trusted to defend

¹ The tents were evidently issued for regular marches, not for cross-country manoeuvres against the enemy. These manoeuvres, as we have seen, often took several days. The *bons généraux ordinaires* of the 17th and 18th centuries framed his manoeuvres on a smaller scale so as not to expose his expensive and highly trained soldiers to discomfort and the consequent temptation to desert.

their homes, and the militia was soon triumphantly to justify its existence on the day of Worcester.

56. *Inverkeithing*.—While David Leslie organized and drilled the king's new army beyond the Forth, Cromwell was, slowly and with frequent relapses, recovering from his illness. The English army marched to Glasgow in April, then returned to Edinburgh. The motives of the march and that of the return are alike obscure, but it may be conjectured that, the forces in England under Harrison having now assembled in Lancashire, the Edinburgh-Newcastle-York road had to be covered by the main army. Be this as it may, Cromwell's health again broke down and his life was despaired of. Only late in June were operations actively resumed between Stirling and Linlithgow. At first Cromwell sought without success to bring Leslie to battle, but he stormed Callendar House near Falkirk on July 13, and on the 16th of July he began the execution of a brilliant and successful manœuvre. A force from Queensferry, covered by the English fleet, was thrown across the Firth of Forth to Northferry. Lambert followed with reinforcements, and defeated a detachment of Leslie's army at Inverkeithing on the 20th. Leslie drew back at once, but managed to find a fresh strong position in front of Stirling, whence he defied Cromwell again. At this juncture Cromwell prepared to pass his whole army across the firth. His contemplated manœuvre of course gave up to the enemy all the roads into England, and before undertaking it the lord general held a consultation with Harrison, as the result of which that officer took over the direct defence of the whole Border. But his mind was up even before this, for on the day he met Harrison at Linlithgow three-quarters of his whole army had already crossed into Fife. Burntisland, surrendered to Lambert on the 20th, gave Cromwell a good harbour upon which to base his subsequent movements. On the 30th of July the English marched upon Perth, and the investment of this place, the key to Leslie's supply area, forced the crisis at once. Whether Leslie would have preferred to manœuvre Cromwell from his vantage-ground or not is immaterial; the young king and the now predominant Royalist element at headquarters seized the long-awaited opportunity at once, and on the 31st, leaving Cromwell to his own devices, the Royal army marched southward to raise the Royal standard in England.

57. *The Third Scottish Invasion of England*.—Then began the last and most thrilling campaign of the Great Rebellion. Charles II. expected complete success. In Scotland, *vis-à-vis* the extreme Covenanters, he was a king on conditions, and he was glad enough to find himself in England with some thirty solidly organized regiments under Royalist officers and with no regular army in front of him. He hoped, too, to rally not merely the old faithful Royalists, but also the overwhelming numerical strength of the English Presbyterians to his standard. His army was kept well in hand, no excesses were allowed, and in a week the Royalists covered 150 m.—in marked contrast to the duke of Hamilton's ill-fated expedition of 1648. On the 8th of August the troops were given a well-earned rest between Penrith and Kendal.

But the Royalists were mistaken in supposing that the enemy was taken aback by their new move. Everything had been foreseen both by Cromwell and by the Council of State in Westminster. The latter had called out the greater part of the militia on the 7th. Lieutenant-General Fleetwood began to draw together the midland contingents at Banbury, the London trained bands turned out for field service no fewer than 14,000 strong. Every suspected Royalist was closely watched, and the magazines of arms in the country-houses of the gentry were for the most part removed into the strong places. On his part Cromwell had quietly made his preparations. Perth passed into his hands on the 2nd of August, and he brought back his army to Leith by the 5th. Thence he despatched Lambert with a cavalry corps to harass the invaders. Harrison was already at Newcastle picking the best of the county mounted troops to add to his own regulars. On the 9th Charles was at Kendal, Lambert hovering in his rear, and Harrison marching swiftly to bar his way at the Mersey. Fairfax emerged for a moment from his retirement to organize the Yorkshire levies, and the best of these as well as of

the Lancashire, Cheshire and Staffordshire militias were directed upon Warrington, which point Harrison reached on the 15th, a few hours in front of Charles's advanced guard. Lambert too, slipping round the left flank of the enemy, joined Harrison, and the English fell back (16th), slowly and without letting themselves be drawn into a fight, along the London road.

58. *Campaign of Worcester*.—Cromwell meanwhile, leaving Monk with the least efficient regiments to carry on the war in Scotland, had reached the Tyne in seven days, and thence, marching 20 m. a day in extreme heat—with the country people carrying their arms and equipment—the regulars entered Ferrybridge on the 19th, at which date Lambert, Harrison and the north-western militia were about Congleton.¹ It seemed probable that a great battle would take place between Lichfield and Coventry about the 25th or 26th of August, and that Cromwell, Harrison, Lambert and Fleetwood would all take part in it. But the scene and the date of the *dénouement* were changed by the enemy's movements. Shortly after leaving Warrington the young king had resolved to abandon the direct march on London and to make for the Severn valley, where his father had found the most constant and the most numerous adherents in the first war, and which had been the centre of gravity of the English Royalist movement of 1648. Sir Edward Massey, formerly the Parliamentary governor of Gloucester, was now with Charles, and it was hoped that he would induce his fellow-Presbyterians to take arms. The military quality of the Welsh border Royalists was well proved, that of the Gloucestershire Presbyterians not less so, and, based on Gloucester and Worcester as his father had been based on Oxford, Charles II. hoped, not unnaturally, to deal with an Independent minority more effectually than Charles I. had done with a Parliamentary majority of the people of England. But even the pure Royalism which now ruled in the invading army could not alter the fact that it was a Scottish army, and it was not an Independent faction but all England that took arms against it. Charles arrived at Worcester on the 22nd of August, and spent five days in resting the troops, preparing for further operations, and gathering and arming the few recruits who came in. It is unnecessary to argue that the delay was fatal; it was a necessity of the case foreseen and accepted when the march to Worcester had been decided upon, and had the other course, that of marching on London via Lichfield, been taken the battle would have been fought three days earlier with the same result. As affairs turned out Cromwell merely shifted the area of his concentration two marches to the south-west, to Evesham. Early on the 28th Lambert surprised the passage of the Severn at Upton, 6 m. below Worcester, and in the action which followed Massey was severely wounded. Fleetwood followed Lambert. The enemy was now only 16,000 strong and disheartened by the apathy with which they had been received in districts formerly all their own. Cromwell, for the first and last time in his military career, had a two-to-one numerical superiority.

59. *The "Crowning Mercy"*.—He took his measures deliberately. Lilburne from Lancashire and Major Mercer with the Worcestershire horse were to secure Bewdley Bridge on the enemy's line of retreat. Lambert and Fleetwood were to force their way across the Teme (a little river on which Rupert had won his first victory in 1642) and attack St John's, the western suburb of Worcester. Cromwell himself and the main army were to attack the town itself. On the 3rd of September, the anniversary of Dunbar, the programme was carried out exactly. Fleetwood forced the passage of the Teme, and the bridging train (which had been carefully organized for the purpose) bridged both the Teme and the Severn. Then Cromwell on the left bank and Fleetwood on the right swept in a semicircle 4 m. long up to Worcester. Every hedgerow was contested by the stubborn Royalists, but Fleetwood's men would not be denied, and Cromwell's extreme right on the eastern side of the town repelled, after three hours' hard fighting, the last desperate attempt of the Royalists to break

¹ The lord general had during his march thrown out successively two flying columns under Colonel Lilburne to deal with the Lancashire Royalists under the earl of Derby. Lilburne entirely routed the enemy at Wigan on the 25th of August.

out. It was indeed, as a German critic¹ has pointed out, the prototype of Sedan. Everywhere the defences were stormed as darkness came on, regulars and militia fighting with equal gallantry, and the few thousands of the Royalists who escaped during the night were easily captured by Lilburne and Mercer, or by the militia which watched every road in Yorkshire and Lancashire. Even the country people brought in scores of prisoners, for officers and men alike, stunned by the suddenness of the disaster, offered no resistance. Charles escaped after many adventures, but he was one of the few men in his army who regained a place of safety. The Parliamentary militia were sent home within a week. Cromwell, who had ridiculed "such stuff" six months ago, knew them better now. "Your new raised forces," he wrote to the House, "did perform singular good service, for which they deserve a very high estimation and acknowledgment." Worcester resembled Sedan in much more than outward form. Both were fought by "nations in arms," by citizen soldiers who had their hearts in the struggle, and could be trusted not only to fight their hardest but to march their best. Only with such troops would a general dare to place a deep river between the two halves of his army or to send away detachments beforehand to reap the fruits of victory, in certain anticipation of winning the victory with the remainder. The sense of duty, which the raw militia possessed in so high a degree, ensured the arrival and the action of every column at the appointed time and place. The result was, in brief, one of those rare victories in which a pursuit is superfluous—a "crowning mercy," as Cromwell called it. There is little of note in the closing operations. Monk had completed his task by May 1652; and Scotland, which had twice attempted to impose its will on England, found itself reduced to the position of an English province under martial law. The details of its subjection are uninteresting after the tremendous climax of Worcester.

BIBLIOGRAPHY—Earl of Clarendon, *The History of the Rebellion* (Oxford, 1702-1704, ed. W. D. Macray, Oxford, 1888); R. Baillie, *Letters and Journals* (Bannatyne Society, 1841); T. Carlyle, *Cromwell's Letters and Speeches* (new edition, S. C. Lomas, London, 1904); *Fairfax Correspondence* (ed. R. Bell, London, 1849); E. Borlase, *History of the Irish Rebellion* (London, 1675); R. Bellings, *Fragmentum historicum, or the... War in Ireland* (London, 1772); J. Heath, *Chronicle of the late Intestine War* (London, 1676); *Military Memoirs of Colonel Birch* (Camden Society, new series, vol. vii., 1873); *Autobiography of Captain John Hodgson* (edition of 1882); *Papers on the earl of Manchester*, Camden Society, vol. viii., and *English Historical Review*, vol. iii.; J. Ricraft, *Survey of England's Champions* (1647, reprinted, London, 1818); ed. E. Warburton, *Memoirs of Prince Rupert and the Cavaliers* (London, 1849); J. Vicars, *Jehovah-Jereh* (1644), and *England's Worthies* (1647), the latter reprinted in 1845; Anthony a Wood, *History and Antiquities of the University of Oxford* (ed. J. Gutch, Oxford, 1792-1795); Margaret, duchess of Newcastle, *Life of William Cavendish, Duke of Newcastle* (ed. C. H. Firth, London, 1886); Lucy Hutchinson, *Memoir of the Life of Colonel Hutchinson* (ed. C. H. Firth, Oxford, 1806); *Memoirs of Edward Ludlow* (ed. C. H. Firth, Oxford, 1892); S. Ashe and W. Goode, *The Services of the Earl of Manchester's Army* (London, 1644); H. Cary, *Memorials of the Great Civil War* (London, 1842); Patrick Gordon, *Passages from the Diary of Patrick Gordon* (Spalding Club, Aberdeen, 1859); J. Gwynne, *Military Memoirs of the Civil War* (ed. Sir W. Scott, Edinburgh, 1822); *Narratives of Hamilton's Expedition, 1648* (C. H. Firth, Scottish Historical Society, Edinburgh, 1904); Lord Hopton, *Bellum Civile* (Somerset Record Society, London, 1902); *Irish War of 1642* (Camden Society, old series, vol. xiv., 1841); *Her Carolinum, Marches of Charles I. 1641-1649* (London, 1660); Hugh Peters, *Reports from the Armies of Fairfax and Cromwell* (London, 1645-1646); "Journal of the Marches of Prince Rupert" (ed. C. H. Firth, *Engl. Historical Review*, 1898); J. Sprigge, *Anglia Rediviva* (London, 1847, reprinted Oxford, 1854); R. Symonds, *Diary of the Marches of the Royal Army, 1644-1645* (ed. C. E. Long, Camden Society, old series, 1859); J. Corbet, *The Military Government of Gloucester* (London, 1645); M. Carter, *Expeditions of Kent, Essex, and Colchester* (London, 1650); *Tracts relating to the Civil War in Lancashire* (ed. G. Ormerod, Chetham Society, London, 1844); *Discourse of the War in Lancashire* (ed. W. Beaumont, Chetham Society, London, 1864); Sir M. Langdale, *The late Fight at Preston* (London, 1648); *Journal of the Siege of Lathom House* (London, 1823); J. Rushworth, *The Storming of Bristol* (London, 1645); S. R. Gardiner, *History of the Great Civil War* (London, 1886); and *History of the Commonwealth and Protectorate* (London, 1903); C. H. Firth, *Oliver Cromwell* (New York and London, 1900); *Cromwell's Army* (London, 1902); "The Raising of the Ironsides," *Transactions R. Hist.*

¹ Fritzo Hoening, *Cromwell*.

Society, 1899 and 1901; papers in *English Historical Review*, and memoirs of the leading personages of the period in *Dictionary of National Biography*; T. S. Baldock, *Cromwell as a Soldier* (London, 1899); F. Hoening, *Oliver Cromwell* (Berlin, 1887-1889); Sir J. Maclean, *Memoirs of the Family of Pomis* (Exeter, 1886); Sir C. Markham, *Life of Fairfax* (London, 1870); M. Napier, *Life and Times of Montrose* (Edinburgh, 1840); W. B. Devereux, *Lines of the Earls of Essex* (London, 1853); W. G. Ross, *Mil. Engineering in the Civil War* (R.E. Professional Papers, 1887); "The Battle of Naseby," *English Historical Review*, 1888; *Oliver Cromwell and his Ironsides* (Chatham, 1869); F. N. Maude, *Cavalry, its Past and Future* (London, 1903); E. Scott, *Rupert, Prince Palatine* (London, 1899); M. Stace, *Cromwelliana* (London, 1870); C. S. Terry, *Life and Campaigns of Alexander Leslie, Earl of Leven* (London, 1899); Madame H. de Witt, *The Lady of Lathom* (London, 1869); F. Masera, *Tracts relating to the Civil War* (London, 1815); P. A. Charrier, *Cromwell* (London, 1905), also paper in *Royal United Service Institution Journal*, 1906; T. Arnold and W. G. Ross, "Edgehill," *English Historical Review*, 1887; "The History of Basing House (Basingstoke, 1869); E. Broxap, "The Sieges of Hull," *English Historical Review*, 1905; J. Willis Bunt, *The Civil War in Worcestershire* (Birmingham, 1905); C. Coates, *History of Reading* (London, 1802); F. Drake, *Eboracum: History of the City of York* (London, 1736); N. Drake, *Siege of Pontefract Castle* (Surtees Society Miscellaneous, London, 1861); G. N. Godwin, *The Civil War in Hampshire* (2nd ed., London, 1904); J. F. Hollings, *Leicester during the Civil War* (Leicester, 1840); R. Holmes, *Sieges of Pontefract Castle* (Pontefract, 1887); A. Kingston, *East Anglia and the Civil War* (London, 1897); H. E. Malden, "Maidstone, 1648," *English Hist. Review*, 1892; W. Money, *Battles of Newbury* (Newbury, 1884); J. R. Phillips, *The Civil War in Wales and the Marches* (London, 1874); G. Rigaud, *Lines round Oxford* (1880); G. Roberts, *History of Lyme* (London, 1834); [R. Robinson] *Sieges of Bristol* (Bristol, 1868); [J. H. Round] *History of Colchester Castle* (Colchester, 1882) and "The Case of Lucas and Lisle," *Transactions of R. Historical Society*, 1804; R. R. Sharpe, *London and the Kingdom* (London, 1894); I. Tullie, *Siege of Carlisle* (1840); E. A. Walford, "Edgehill," *English Hist. Review*, 1905; J. Washbourne, *Bibliotheca Gloucesterensis* (Gloucester, 1825); J. Webb, *Civil War in Herefordshire* (London, 1879). (C. F. A.)

GREAT SALT LAKE, a shallow body of highly concentrated brine in the N.W. part of Utah, U.S.A., lying between 118° 8' and 113° 2' W. long. and between 40° 7' and 41° 8' lat. Great Salt Lake is 4218 ft. above sea-level. It has no outlet, and is fed chiefly by the Jordan, the Weber and the Bear rivers, all draining the mountainous country to the E. and S.E. The irregular outline of the lake has been compared to the roughly drawn hand, palm at the S., thumb (exaggerated in breadth) pointing N.E., and the fingers (crowded together and drawn too small) reaching N.

No bathymetric survey of the lake has been made, but the maximum depth is 60 ft. and the mean depth less than 20 ft., possibly as little as 13 ft. The lake in 1906 was approximately 75 m. long, from N.W. to S.E., and had a maximum width of 50 m. and an area of 1750 sq. m. This area is not constant, as the water is very shallow at the margins, and the relation between supply from precipitation, &c., and loss by evaporation is variable, there being an annual difference in the height of the water of 15-18 in. between June (highest) and November (lowest), and besides a difference running through longer cycles: in 1850 the water was lower and the lake smaller than by any previous observations (the area and general outline were nearly the same again in 1906); then the water rose until 1873; and between 1886 and 1902 the fall in level was 11 ft. The range of rise and fall from 1845 to 1886 was 13 ft., this being the rise in 1865-1886. With the fall of water there is an increase in the specific gravity, which in 1850 was 1.17, and in September 1901 was 1.179; in 1850 the proportion of solids by weight was 22.282%, in September 1901 it was 25.221; at the earlier of these dates the solids in a litre of water weighed 260.69 grams, at the latter date 302.122 grams. The exact cause of this cyclic variation is unknown: the low level of 1906 is usually regarded as the result of extensive irrigation and ploughing in the surrounding country, which have robbed the lake, in part, of its normal supply of water. It is also to be noted that the rise and fall of the lake level have been coincident, respectively, with continued wet and dry cycles. That the lake will soon dry up entirely seems unlikely, as there is a central trough, 25 to 30 m. wide, about 40 ft. deep, running N.W. and S.E. The area and

GREAT SLAVE LAKE—GREAVES

shore-line of the lake are evidently affected by a slight surface tilt, for during the same generation that has seen the recent fall of the lake level the shore-line is in many cases 2 m. from the old, and fences may be seen a mile or more out in the lake. The lake bed is for the most part clear sand along the margin, and in deeper water is largely coated with crusts of salt, soda and gypsum.

The lake is a novel and popular bathing resort, the specific gravity of the water being so great that one cannot sink or entirely submerge oneself. There are well-equipped bathing pavilions at Garfield and Saltair on the S. shore of the lake about 20 m. from Salt Lake City. The bathing is invigorating; it must be followed by a freshwater bath because of the incrustation of the body from the briny water. The large amount of salt in the water makes both fauna and flora of the lake scanty; there are a few algae, the larvae of an *Ephydra* and of a *Tipula* fly, specimens of what seems to be *Corixa decolor*, and in great quantities, so as to tint the surface of the water, the brine shrimp, *Artemia salina* (or *gracilis* or *fertilis*), notable biologically for the rarity of males, for the high degree of parthenogenesis and for apparent interchangeableness with the *Branchipus*.

The lake is of interest for its generally mountainous surroundings, save to the N.W., where it skirts the Great Salt Lake Desert, for the mountainous peninsula, the Promontory, lying between thumb and fingers of the hand, shaped like and resembling in geological structure the two islands S. of it, Fremont and Antelope,¹ and the Oquirrh range S. of the lake. The physiography of the surrounding country shows clearly that the basin occupied by Great Salt Lake is one of many left by the drying up of a large Pleistocene lake, which has been called lake Bonneville. Well-defined wave-cut cliffs and terraces show two distinct shore-lines of this early lake, one the "Bonneville Shore-line," about 1000 ft. above Great Salt Lake, and the other, the "Provo Shore-line," about 625 ft. higher than the present lake. These shore-lines and the presence of two alluvial deposits, the lower and the larger of yellow clay 90 ft. deep, and, separated from it by a plane of erosion, the other, a deposit of white marl, 10-20 ft. deep, clearly prove the main facts as to lake Bonneville: a dry basin was first occupied by the shallow waters of a small lake; then, during a long period of excessive moisture (or cold), the waters rose and spread over an area nearly as large as lake Huron with a maximum depth of 1000 ft.; a period of great dryness followed, in which the lake disappeared; then came a second, shorter, but more intense period of moisture, and in this time the lake rose, covered a larger area than before, including W. Utah and a little of S. Idaho and of E. Nevada, about 19,750 sq. m., had a very much broken shore-line of 2550 m. and a maximum depth of 1050 ft. and a mean depth of 800 ft., overflowed the basin at the N., and by a tributary stream through Red Rock Pass at the N. end of the Cache valley poured its waters into the Columbia river system. The great lake was then gradually reduced by evaporation, leaving only shallow bodies of salt water, of which Great Salt Lake is the largest. The cause of the climatic variations which brought about this complex history of the Salt Lake region is not known; but it is worthy of note that the periods of highest water levels were coincident with a great expansion of local valley glaciers, some of which terminated in the waters of lake Bonneville.

Industrially Great Salt Lake is of a certain importance. In early days it was the source of the salt supply of the surrounding country; and the manufacture of salt is now an important industry. The brine is pumped into conduits, carried to large ponds and there evaporated by the sun; during late years the salt has been refined here, being purified of the sulphates and magnesium compounds which formerly rendered it efflorescent and of a low commercial grade. Mirabilite, or Glauber's salt, is commercially valuable, occurring in such quantities in parts of the lake that one may wade knee-deep in it; it separates

¹ Besides these islands there are a few small islands farther N., and W. of Antelope, Stansbury Island, which, like Antelope and Fremont islands, is connected with the mainland by a bar sometimes uncovered and rarely in more than a foot of water.

from the brine at a temperature between 30° and 20° F. The lake is crossed E. and W. by the Southern Pacific railway's so-called "Lucina Cut-off," which runs from Ogden to Lucina on a trestle with more than 20 m. of "fill"; the former route around the N. end of the lake was 43 m. long.

Great Salt Lake was first described in 1689 by Baron La Hontan, who had merely heard of it from the Indians. "Jim" Bridger, a famous mountaineer and scout, saw the lake in 1824, apparently before any other white man. Captain Bonneville described the lake and named it after himself, but the name was transferred to the great Pleistocene lake. John C. Frémont gave the first description of any accuracy in his *Report* of 1845. But comparatively little was known of it before the Mormon settlement in 1847. In 1850 Captain Howard Stansbury completed a survey, whose results were published in 1852. The most extensive and important studies of the region, however, are those by Grove Karl Gilbert of the United States Geological Survey, who in 1879-1890 studied especially the earlier and greater lake.

See J. E. Talmage, *The Great Salt Lake, Present and Past* (Salt Lake City, 1900); and Grove Karl Gilbert, *Lake Bonneville*, monograph 1 of United States Geological Survey (Washington, 1890), containing (pp. 12-19) references to the earlier literature.

GREAT SLAVE LAKE (ATHAPUSCOW), a lake of Mackenzie district, Canada. It is situated between 60° 50' and 62° 55' N. and 108° 40' and 117° W., at an altitude of 391 ft. above the sea. It is 325 m. long, from 15 to 50 m. wide, and includes an area of 9770 sq. m. The water is very clear and deep. Its coast line is irregular and deeply indented by large bays, and its north-eastern shores are rugged and mountainous. The western shores are well wooded, chiefly with spruce, but the northern and eastern are dreary and barren. It is navigable from about the 1st of July to the end of October. The Yellow-knife, Hoarfrost, Lockhart (discharging the waters of Aylmer, Clinton-Colden and Artillery Lakes), Tchudzetz, Du Rocher, Hay (400 m. in length), and Slave rivers empty into Great Slave Lake. The bulk of its water empties by the Mackenzie river into the Arctic Ocean, but a small portion finds its way by the Ark-i-linik river into Hudson's Bay. It was discovered in 1771 by Samuel Hearne.

GREAT SOUTHERN OCEAN, the name given to the belt of water which extends almost continuously round the globe between the parallel of 40° S. and the Antarctic Circle (66½° S.). The fact that the southern extremity of South America is the only land extending into this belt gives it special physical importance in relation to tides and currents, and its position with reference to the Antarctic Ocean and continent makes it convenient to regard it as a separate ocean from which the Atlantic, Pacific and Indian Oceans may be said to radiate. (See OCEAN.)

GREAVES, JOHN (1602-1652), English mathematician and antiquary, was the eldest son of John Greaves, rector of Colemore, near Alresford in Hampshire. He was educated at Balliol College, Oxford, and in 1630 was chosen professor of geometry in Gresham College, London. After travelling in Europe, he visited the East in 1637, where he collected a considerable number of Arabic, Persian and Greek manuscripts, and made a more accurate survey of the pyramids of Egypt than any traveller who had preceded him. On his return to Europe he visited a second time several parts of Italy, and during his stay at Rome instituted inquiries into the ancient weights and measures. In 1643 he was appointed to the Savilian professorship of astronomy at Oxford, but he was deprived of his Gresham professorship for having neglected its duties. In 1645 he essayed a reformation of the calendar, but his plan was not adopted. In 1648 he lost both his fellowship and his Savilian chair on account of his adherence to the royalist party. But his private fortune more than sufficed for all his wants till his death on the 8th of October 1652.

Besides his papers in the *Philosophical Transactions*, the principal works of Greaves are *Pyramidographia, or a Description of the Pyramids in Egypt* (1646); *A Discourse on the Roman Foot and*

Denarius (1649); and *Elementa Linguae Persicae* (1649). His miscellaneous works were published in 1737 by Dr Thomas Birch, with a biographical notice of the author. See also Smith's *Vita quorundam erudit. vivorum* and Ward's *Gresham Professors*.

GREBE (Fr. *grèbe*), the generally accepted name for all the birds of the family *Podicipedidae*,¹ belonging to the group *Pygopodas* of Illiger, members of which inhabit almost all parts of the world. Some systematic writers have distributed them into several so-called genera, but, with one exception, these seem to be insufficiently defined, and here it will be enough to allow but two—Latham's *Podiceps* and the *Centropelma* of Sclater and Salvin. Grebes are at once distinguishable from



Great Crested Grebe.

all other water-birds by their rudimentary tail and the peculiar structure of their feet, which are not only placed far behind, but have the tarsi flattened and elongated toes furnished with broad lobes of skin and flat blunt nails.

In Europe are five well-marked species of *Podiceps*, the commonest and smallest of which is the very well-known dabchick of English ponds, *P. fuscicollis* or *minor*, the little grebe of ornithologists, found throughout the British Islands, and with a wide range in the old world. Next in size are two species known as the eared and horned grebes, the former of which, *P. nigricollis*, is a visitor from the south, only occasionally showing itself in Britain and very rarely breeding, while the latter, *P. auritus*, has a more northern range, breeding plentifully in Iceland, and is a not uncommon winter-visitor. Then there is the larger red-necked grebe, *P. griseigena*, also a northern bird, and a native of the subarctic parts of both Europe and America, while lastly the great crested grebe, *P. cristatus* or *gaunt*—known as the loon on the meres and broads of East Anglia and some other parts of England, is also widely spread over the old world. North America is credited with seven species of grebes, of which two (*P. griseigena* and *P. auritus*) are admitted to be specifically inseparable from those already named, and two (*P. occidentalis* and *P. californicus*) appear to be but local forms; the remaining two (*P. dominicus* and *P. ludovicianus*) may, however, be accounted good species, and the last differs so much from other grebes that many systematists make it the type of a distinct genus, *Podilymbus*. South America seems to possess four or five more species, one of which, the *P. micropterus* of Gould (*Proc. Zool. Society*, 1858, p. 220), has been deservedly separated

¹ Often, but erroneously, written *Podicipidae*. The word *Podiceps* being a contracted form of *Podicipes* (cf. Gloger, *Journal für Ornithologie*, 1854, p. 430, note), a combination of *podex*, *podicis* and *pes*, *pedis*, its further compounds must be in accordance with its derivation.

from the genus *Podiceps* under the name *Centropelma* by Sclater and Salvin (*Exot. Ornithology*, p. 189, pl. xcvi.), owing to the form of its bill, and the small size of its wings, which renders it absolutely flightless. Lake Titicaca in Bolivia is, so far as is known at present, its only habitat. Grebes in general, though averse from taking wing, have much greater power of flight than would seem possible on examination of their alar organs, and are capable of prolonged aerial journeys. Their plumage is short and close. Above it is commonly of some shade of brown, but beneath it is usually white, and so glossy as to be in much request for muffs and the trimming of ladies' dresses. Some species are remarkable for the crests or tippets, generally of a golden-chestnut colour, they assume in the breeding season. *P. auritus* is particularly remarkable in this respect, and when in its full nuptial attire presents an extraordinary aspect, the head (being surrounded, as it were, by a *nimbus* or aureole, such as that with which painters adorn saintly characters), reflecting the rays of light, glitters with a glory that passes description. All the species seem to have similar habits of nidification. Water-weeds are pulled from the bottom of the pool, and piled on a convenient foundation, often a seminant growth of bog-bean (*Menyanthes*), till they form a large mass, in the centre of which a shallow cup is formed, and the eggs, with a chalky white shell almost equally pointed at each end, are laid—the parent covering them, whenever she has time to do so, before leaving the nest. Young grebes are beautiful objects, clothed with black, white and brown down, disposed in streaks and their bill often brilliantly tinted. When taken from the nest and placed on dry ground, it is curious to observe the way in which they progress—using the wings almost as fore-feet, and suggesting the notion that they must be quadrupeds instead of birds. (A. N.)

GRECO, EL the name commonly given to Dominico Theotocopuli (d. 1614), Cretan painter, architect and sculptor. He was born in Crete, between 1545 and 1550, and announces his Cretan origin by his signature in Greek letters on his most important pictures, especially on the "St Maurice" in the Escorial. He appears to have studied art first of all in Venice, and on arriving in Rome in 1570 is described as having been a pupil of Titian, in a letter written by the miniaturist, Giulio Clovio, addressed to Cardinal Alessandro Farnesi, dated the 15th of November 1570.

Although a student under Titian, he was at no time an exponent of his master's spirit, and his early historical pictures were attributed to many other artists, but never to Titian. Of his early works, two pictures of "The Healing of the Blind Man" at Dresden and Palma, and the four of "Christ driving the money-changers out of the Temple" in the Yarborough collection, the Cork collection, the National Gallery, and the Beruete collection at Madrid, are the chief. His first authentic portrait is that of his fellow-countryman, Giulio Clovio. It was painted between 1570 and 1578, is signed in Greek characters, and preserved at Naples, and the last portrait he painted under the influence of the Italian school appears to be that of a cardinal now in the National Gallery, of which four replicas painted in Spain are known. He appears to have come to Spain in 1577, but, on being questioned two years later in connexion with a judicial suit, as to when he arrived in the country, and for what purpose he came, declined to give any information. He was probably attracted by the prospect of participating in the decoration of the Escorial, and he appears to have settled down in Toledo, where his first works were the paintings for the high altar of Santo Domingo, and his famous picture of "The Disrobing of Christ" in the sacristy of the cathedral. It was in connexion with this last-named work that he proved refractory, and the records of a law-suit respecting the price to be paid to him give us the earliest information of the artist's sojourn in Spain. In 1590, he painted the "History of St Maurice" for Philip II., and in 1578, his masterpiece, entitled "The Burial of the Count Orgaz." This magnificent picture, one of the finest in Spain, is at last being appreciated, and can only be put a little below the masterpieces of Velazquez. It is a strangely

individual work, representing Spanish character even more truthfully than did any Spanish artist, and it gathers up all the fugitive moods, the grace and charm, the devices and defects of a single race, and gives them complete stability in their wavering expressions.

Between 1595 and 1600, El Greco executed two groups of paintings in the church of San José at Toledo, and in the hospital of La Caridad, at Illescas. Besides these, he is known to have painted thirty-two portraits, several manuscripts, and many paintings for altar-pieces in Toledo and the neighbourhood. As an architect he was responsible for more than one of the churches of Toledo, and as a sculptor for carvings both in wood and in marble, and he can only be properly understood in all his varied excellences after a visit to the city where most of his work was executed.

He died on the 7th of April 1614, and the date of his death is one of the very few certain facts which we have respecting him. The record informs us that he made no will, that he received the sacraments, and was buried in the church of Santo Domingo. The popular legend of his having gone mad towards the latter part of his career has no foundation in fact, but his painting became more and more eccentric as his life went on, and his natural perversity and love of strange, cold colouring, increased towards the end of his life. As has been well said, "Light with him was only used for emotional appeal, and was focussed or scattered at will." He was haughtily certain of the value of his own art, and was determined to paint in cold, ashen colouring, with livid, startling effect, the gaunt and extraordinary figures that he beheld with his eccentric genius. His pictures have wonderful visionary quality, admirable invention, and are full of passionate fervency. They may be considered extravagant, but are never commonplace, and are exceedingly attractive in their intense emotion, marvellous sincerity, and strange, chilly colour.

El Greco's work is typically modern, and from it the portrait-painter, J. S. Sargent, claims to have learnt more than from that of any other artist. It immortalizes the character of the people amongst whom he dwelt, and he may be considered as the initiator of truth and realism in art, a precursor and inspirer of Velazquez.

In his own time he was exceedingly popular, and held in great repute. Sonnets were written in his honour, and he is himself said to have written several treatises, but these have not come down to our time. For more than a generation his work was hardly known, but it is now gaining rapidly in importance, and its true position is more and more recognized. Some examples of the artist's own handwriting have been discovered in Toledo, and Señor Don Manuel Cossia of Madrid has spent many years collecting information for a work dealing with the artist.

(G. C. W.)

GRECO-TURKISH WAR, 1897. This war between Greece and Turkey (see GREECE: *Modern History*) involved two practically distinct campaigns, in Thessaly and in Epirus. Upon the Thessalian frontier the Turks, early in March, had concentrated six divisions (about 58,000 men), 1500 sabres and 156 guns, under Edhem Pasha. A seventh division was rendered available a little later. The Greeks numbered about 45,000 infantry, 800 cavalry and 96 guns, under the crown prince. On both sides there was a considerable dispersion of forces along the frontier. The Turkish navy, an important factor in the war of 1877-78, had become paralytic ten years later, and the Greek squadron held complete command of the sea. Expeditionary forces directed against the Turkish line of communications might have influenced the course of the campaign; but for such work the Greeks were quite unprepared, and beyond bombarding one or two insignificant ports on the coast-line, and aiding the transport of troops from Athens to Volo, the navy practically accomplished nothing. On the 9th and 10th April Greek irregulars crossed the frontier, either with a view to provoke hostilities or in the hope of fomenting a rising in Macedonia. On the 16th and 17th some fighting occurred, in which Greek regulars took part; and on the 18th Edhem Pasha, whose headquarters had for some time been established at

Elassona, ordered a general advance. The Turkish plan was to turn the Greek left and to bring on a decisive action, but this was not carried out. In the centre the Turks occupied the Meluna Pass on the 19th, and the way was practically open to Larissa. The Turkish right wing, however, moving on Damani and the Reveni Pass, encountered resistance, and the left wing was temporarily checked by the Greeks among the mountains near Nezeros. At Mati, covering the road to Tyrnavo, the Greeks entrenched themselves. Here sharp fighting occurred on the 21st and 22nd, during which the Greeks sought to turn the right flank of the superior Turkish central column. On the 23rd fighting was renewed, and the advance guard of the Turkish left column, which had been reinforced, and had pressed back the Greeks, reached Deliler. The Turkish forces had now drawn together, and the Greeks were threatened on both flanks. In the evening a general retreat was ordered, and the loose discipline of the Greek army was at once manifested. Rumours of disaster spread among the ranks, and wild panic supervened. There was nothing to prevent an orderly retirement upon Larissa, which had been fortified and provisioned, and which offered a good defensive position. The general débâcle could not, however, be arrested, and in great disorder the mass of the Greek army fled southwards to Pharsala. There was no pursuit, and the Turkish commander-in-chief did not reach Larissa till the 27th. Thus ended the first phase of the war, in which the Greeks showed tenacity in defence, which proved fruitless by reason of initially bad strategic dispositions entailing far too great dispersion, and also because there was no plan of action beyond a general desire to avoid risking a defeat which might prevent the expected risings in Macedonia and elsewhere. The handling of the Turkish army showed little skill or enterprise; but on both sides political considerations tended to prevent the application of sound military principles.

Larissa being abandoned by the Greeks, Velesino, the junction of the Thessalian railways, where there was a strong position covering Volo, seemed to be the natural rallying point for the Greek army. Here the support of the fleet would have been secured, and a Turkish advance across the Othrys range upon Athens could not have taken place until the flanking position had been captured. Whether by direction or by natural impulse, however, the mass of the Greek troops made for Pharsala, where some order was re-established, and preparations were made to resist attack. The importance of Velesino was recognized by sending a brigade thither by railway from Pharsala, and the inferior Greek army was thus split into two portions, separated by nearly 40 m. On 27th April a Turkish reconnaissance on Velesino was repulsed, and further fighting occurred on the 29th and 30th, in which the Greeks under Colonel Smolenski held their own. Meanwhile the Turks made preparations to attack Pharsala, and on 5th May the Greeks were driven from their positions in front of the town by three divisions. Further fighting followed on the 6th, and in the evening the Greek army retired in fair order upon Domokos. It was intended to turn the Greek left with the first division under Hairy Pasha, but the flanking force did not arrive in time to bring about a decisive result. The abandonment of Pharsala involved that of Velesino, where the Turks had obtained no advantage, and on the evening of the 5th Colonel Smolenski began a retirement upon Halmiros. Again delaying, Edhem Pasha did not attack Domokos till the 17th, giving the Greeks time to entrench their positions. The attack was delivered in three columns, of which the right was checked and the centre failed to take the Greek trenches and suffered much loss. The left column, however, menaced the line of retreat, and the Greek army abandoned the whole position during the night. No effective stand was made at the Furka Pass, which was evacuated on the following night. Colonel Smolenski, who arrived on the 18th from Halmiros, was directed to hold the pass of Thermopylae. The Greek forces being much demoralized, the intervention of the tsar was invoked by telegraph; and the latter sent a personal appeal to the Sultan, who directed a suspension of hostilities. On the 20th an armistice was arranged.

100

100

100

In Epirus at the outbreak of war about 15,000 Greeks, including a cavalry regiment and five batteries, the whole under Colonel Manos, occupied a line of defence from Arta to Peta. The Turks, about 28,000 strong, with forty-eight guns, under Achmet Hifsi Pasha, were distributed mainly at Iannina, Pentepagadia, and in front of Arta. On 18th April the Turks commenced a three days' bombardment of Arta; but successive attempts to take the bridge were repulsed, and during the night of the 21st they retired on Philippiada, 26 m. distant, which was attacked and occupied by Colonel Manos on the 23rd. The Greeks then advanced to Pentepagadia, meeting with little resistance. Their difficulties now began. After some skirmishing on the 27th, the position held by their advanced force near Homopolis was attacked on the 28th. The attack was renewed on the 29th, and no Greek reinforcements were forthcoming when needed. The Euzones made a good defence, but were driven back by superior force, and a retreat was ordered, which quickly degenerated into panic-stricken flight to and across the Arta. Reinforcements, including 2500 Epirote volunteers, were sent to Arta from Athens, and on 12th May another incursion into Turkish territory began, the apparent object being to occupy a portion of the country in view of the breakdown in Thessaly and the probability that hostilities would shortly end. The advance was made in three columns, while the Epirote volunteers were landed near the mouth of the Luro river with the idea of cutting off the Turkish garrison of Prevesa. The centre column, consisting of a brigade, three squadrons and two batteries, which were intended to take up and hold a defensive position, attacked the Turks near Strevina on the 13th. The Greeks fought well, and being reinforced by a battalion from the left column, resumed the offensive on the following day, and fairly held their own. On the night of the 15th a retreat was ordered and well carried out. The volunteers landed at the mouth of the Luro, were attacked and routed with heavy loss.

The campaign in Epirus thus failed as completely as that in Thessaly. Under the terms of the treaty of peace, signed on 20th September, and arranged by the European powers, Turkey obtained an indemnity of £14,000,000, and a rectification of the Thessalian frontier, carrying with it some strategic advantage. History records few more unjustifiable wars than that which Greece gratuitously provoked. The Greek troops on several occasions showed tenacity and endurance, but discipline and cohesion were manifestly wanting. Many of the officers were incapable; the campaign was gravely mismanaged; and politics, which led to the war, impeded its operations. On the other hand, the fruits of the German tuition, which began in 1880, and received a powerful stimulus by the appointment of General von der Goltz in 1883, were shown in the Turkish army. The mobilization was on the whole smoothly carried out, and the newly completed railways greatly facilitated the concentration on the frontier. The young school of officers trained by General von der Goltz displayed ability, and the artillery at Pharsala and Domokos was well handled. The superior leading was, however, not conspicuously successful; and while the rank and file again showed excellent military qualities, political conditions and the Oriental predilection for half-measures and for denying full responsibility and full powers to commanders in the field enfeebled the conduct of the campaign. On account of the total want of careful and systematic peace training on both sides, a war which presented several interesting strategic problems provided warnings in place of military lessons. (G. S. C.)

GREECE,¹ an ancient geographical area, and a modern kingdom more or less corresponding thereto, situated at the south-eastern extremity of Europe and forming the most southerly portion of the Balkan Peninsula. The modern kingdom is bounded on the N. by European Turkey and on the E., S. and W. by the Aegean, Mediterranean and Ionian seas. The name *Græcia*, which was more or less vaguely given to the ancient country by the Romans, seems not to have been employed by any native writer before Aristotle; it was apparently derived

¹ See also GREEK ART, GREEK LANGUAGE, GREEK LAW, GREEK LITERATURE, GREEK RELIGION.

by the Romans from the Illyrians, who applied the name of an Epirote tribe (*Γραικοί*, Græci) to all their southern neighbours. The names Hellas, Hellenes (*Ἑλλάς*, *Ἑλληνες*), by which the ancient Greeks called their country and their race, and which are still employed by the modern Greeks, originally designated a small district in Phthiotis in Thessaly and its inhabitants, who gradually spread over the lands south of the Cambunian mountains. The name Hellenes was not universally applied to the Greek race until the post-Homeric epoch (Thucyd. i. 3).

I. GEOGRAPHY AND STATISTICS

The ancient Greeks had a somewhat vague conception of the northern limits of Hellas. Thessaly was generally included and Epirus excluded; some writers included some of the southern cantons of Epirus, while others excluded not only all that country but Aetolia and Acarnania. Generally speaking, the confines of Hellas in the age of its greatest distinction were represented by a line drawn from the northern shore of the Ambracian Gulf on the W. to the mouth of the Peneus on the E. Macedonia and Thrace were regarded as outside the pale of Hellenic civilization till 386 B.C., when after his conquest of Thessaly and Phocis, Philip of Macedon obtained a seat in the Amphictyonic Council. In another sense, however, the name Hellas expressed an ethnological rather than a geographical unity; it denoted every country inhabited by Hellenes. It thus embraced all the Greek settlements on the coasts and islands of the Mediterranean, on the shores of the Hellespont, the Bosphorus and the Black Sea. Nevertheless, the Greek peninsula within the limits described above, together with the adjacent islands, was always regarded as Hellas *par excellence*. The continental area of Hellas proper was no greater than that of the modern Greek kingdom, which comprises but a small portion of the territories actually occupied by the Greek race. The Greeks have always been a maritime people, and the real centre of the national life is now, as in antiquity, the Aegean Sea or Archipelago. Thickly studded with islands and bordered by deeply indented coasts with sheltered creeks and harbours, the Aegean in the earliest days of navigation invited the enterprise of the mariner; its shores, both European and Asiatic, became covered with Greek settlements and its islands, together with Crete and Cyprus, became Greek. True to their maritime instincts, the Greeks rarely advanced inland to any distance from the sea; the coasts of Macedonia, Thrace and Asia Minor are still mainly Greek, but, except for some isolated colonies, the *hinterland* in each case lies outside the limits of the race. Continental Greece is divided by its mountain ranges into a number of natural cantons; the existence of physical barriers tended in the earliest times to the growth of isolated political communities, and in the epoch of its ancient independence the country was occupied by seventeen separate states, none of them larger than an ordinary English county. These states, which are noticed separately, were: Thessaly, in northern Greece; Acarnania, Aetolia, Locris, Doris, Phocis, Megaris, Boeotia and Attica in central Greece; and Corinthia, Sicyonia, Achæa, Elis, Messenia, Laconia, Argolis and Arcadia in the Peloponnesus.

Modern Greece, which (including the adjacent islands) extends from 35° 50' to 39° 54' N. and from 19° 20' to 26° 15' E., comprises all the area formerly occupied by these states. Under the arrangement concluded at Constantinople on the 21st of July 1832 between Great Britain, France, Russia and Turkey, the northern boundary of Greece was drawn from the Gulf of Arta (*Sinus Ambracius*) to the Gulf of Volo (*S. Pagasæus*), the line keeping to the crest of the Othrys range. Thessaly and part of Acarnania were thus left to Turkey. The island of Euboea, the Cyclades and the northern Sporades were added to the new kingdom. In 1864 the Ionian Islands (*q.v.*) were ceded by Great Britain to Greece. In 1880 the Conference of Berlin proposed a new frontier, which transferred to Greece not only Thessaly but a considerable portion of southern Epirus, extending to the river Kalamas. This, however, was rejected by Turkey, and the existing boundary was traced in 1881. Starting from the Aegean coast at a point

Extent of ancient Greece.

Extent of modern Greece.

near Platamona, between Mount Olympus and the mouth of the Salambria (Peneus), the line passes over the heights of Kritiri and Zygos (Pindus) and descends the course of the river Arta to its mouth. After the war of 1897 Greece restored to Turkey some strategical points on the frontier possessing no geographical importance. The greatest length of Greece is about 250 m., the greatest breadth 180 m. The country is generally divided into five parts, which are indicated by its natural features:—(i.) Northern Greece, which extends northwards from Mount Othrys and the gulfs of Zeitun(Lamia) and Arta to the Cambunian Mountains, and comprises Thessaly and a small portion of Epirus; (ii.) Central Greece, extending from the southern limits of Northern Greece to the gulfs of Corinth and Aegina; (iii.) the peninsula of the Peloponnesus or Morea, attached to the mainland by the Isthmus of Corinth; (iv.) the Ionian Islands on the west coasts of Epirus and Greece; (v.) The islands of the Aegean Sea, including Euboea, the Cyclades and the northern Sporades.

In the complexity of its contour and the variety of its natural features Greece surpasses every country in Europe, as Europe surpasses every continent in the world. The broken character of its coast-line is unique; except a few districts in Thessaly no part of the country is more than 50 m. from the sea. Although the area of Greece is considerably smaller than that of Portugal, its coast-line is greater than that of Spain and Portugal together. The mainland is penetrated by numerous gulfs and inlets, and the adjoining seas are studded with islands. Another characteristic is the number and complexity of the mountain chains, which traverse every part of the country and which, together with their ramifications, cover four-fifths of its surface. The mountain-chains interlace, the interstices forming small enclosed basins, such as the plain of Boeotia and the plateau of Arcadia; the only plain of any extent is that of Thessaly. The mountains project into the sea, forming peninsulas, and sometimes reappearing in rows or groups of islands; they descend abruptly to the coast or are separated from it by small alluvial plains. The portions of the country suitable for human colonization were thus isolated one from the other, but as a rule possessed easy access to the sea. The earliest settlements were generally situated on or around some rocky elevation, which dominated the surrounding plain and was suitable for fortification as a citadel or acropolis; owing to the danger of piratical attacks they were usually at some little distance from the sea, but in the vicinity of a natural harbour. The physical features of the country played an important part in moulding the character of its inhabitants. Protected against foreign invasion by the mountain barriers and to a great extent cut off from mutual intercourse except by sea, the ancient Greek communities developed a marked individuality and a strong sentiment of local patriotism; their inhabitants were both mountaineers and mariners; they possessed the love of country, the vigour and the courage which are always found in highlanders, together with the spirit of adventure, the versatility and the passion for freedom characteristic of a seafaring people. The great variety of natural products as well as the facility of maritime communication tended to the early growth of commercial enterprise, while the peculiar beauty of the scenery, though little dwelt upon in ancient literature, undoubtedly quickened the poetic and artistic instincts of the race. The effects of physical environment are no less noticeable among the modern Greeks. The rural populations of Attica and Boeotia, though descended from Albanian colonists in the middle ages, display the same contrast in character which marked the inhabitants of those regions in ancient times.

In its general aspect the country presents a series of striking and interesting contrasts. Fertile tracts covered with vineyards, olive groves, corn-fields or forests display themselves in close proximity with rugged heights and rocky precipices; the landscape is never monotonous; its outlines are graceful, and its colouring, owing to the clearness of the air, is at once brilliant and delicate, while the sea, in most instances, adds a picturesque feature, enhancing the charm and variety of the scenery.

The ruling feature in the mountain system of northern Greece is the great chain of Pindus, which, extending southwards from the lofty Shar Dagh (Skardos) near Uskub, forms the backbone of the Balkan peninsula. Reaching the frontier of Greece a little S. of lat. 40°, the Pindus range is intersected by the Cambunian Mountains running E. and W.; the eastern branch, which forms the northern boundary of Thessaly, extends to the Gulf of Salonica and culminates in Mount Olympus (9754 ft.) a little to the N. of the Greek frontier; then bending to the S.E. it follows the coast-line, forming a rampart between the Thessalian plain and the sea; the barrier is severed at one point only where the river Salambria (anc. Peneus) finds an exit through the narrow defile of Tempe. South of Tempe the mountain ridge, known as the Mavro Vouno, connects the pyramidal Kissovo (anc. Ossa, 6400 ft.) with Plesidi (anc. Pelion, 5310 ft.); it is prolonged in the Magnesian peninsula, which separates the Gulf of Volo from

the Aegean, and is continued by the mountains of Euboea (highest summits, Dirphys, 5725 ft., and Ocha, 4830 ft.) and by the islands of Andros and Tenos. West of Pindus, the Cambunian Mountains are continued by several ridges which traverse Epirus from north to south, enclosing the plain and lake of Iannina; the most westerly of these, projecting into the Adriatic, forms the Acroceranian promontory terminating in Cape Glossa. The principal pass through the Cambunian Mountains is that of Meluna, through which runs the carriage-road connecting the town of Ellassona in Macedonia with Larissa, the capital of Thessaly; there are horse-paths at Reveni and elsewhere. The central chain of Pindus at the point where it is intersected by the Cambunian Mountains forms the mass of Zygos (anc. Larmon, 7113 ft.) through which a horse-path connects the town of Metzovo with Kalabaka in Thessaly; on the declivity immediately N. of Kalabaka are a series of rocky pinnacles on which a number of monasteries are perched. Trending to the S., the Pindus chain terminates in the conical Mount Velouchi (anc. Tymphrestus, 7609 ft.) in the heart of the mountainous region of northern Greece. From this centre-point a number of mountains radiate in all directions. To the E. runs the chain of Helloo (anc. Othrys; highest summit, Hagios Elias, 5558 ft.) separating the plain of Thessaly from the valley of the Spercheios and traversed by the Phourka pass (2789 ft.); to the S.E. is Mount Katávotbra (anc. Oeta, 7080 ft.) extending to the southern shore of the Gulf of Lamia at Thermopylae; to the S.E., S. and S.W. are the mountains of Aetolia and Acarnania. The Aetolian group, which may be regarded as the direct continuation of the Pindus range, includes Kiona (8240 ft.), the highest mountain in Greece, and Vardousi (anc. Kovos, 8100 ft.). The mountains of Acarnania with $\sigma\eta\eta\eta$ $\sigma\eta\eta\eta$ (5215 ft.) rise to the W. of the valley of the Aspropotamo (anc. Achelous). The Aetolian Mountains are prolonged to the S.E. by the double-crested Liakoura (anc. Parnassus; 8064 ft.) in Phocia; by Palaeo Vouno (anc. Helicon, 5738 ft.) and Eleates (anc. Cithaeron, 4626 ft.) respectively W. and S. of the Beotian plain; and by the mountains of Attica,—Oza (anc. Parnes, 4626 ft.), Mendeli (anc. Pentelicus or Brilessos, 3639 ft.), Trellouvo (anc. Hymettus, 3569 ft.), and Keratia (2136 ft.)—terminating in the promontory of Sunium, but reappearing in the islands of Ceos, Cythnos, Seriphos and Siphnos. South of Cithaeron are Patara in Megaris (3583 ft.) and Makri Plagi (anc. Geraneia, 4495 ft.) overlooking the Isthmus of Corinth.

The mountains of the Morea, grouped around the elevated central plateau of Arcadia, form an independent system with ramifications extending through the Argolid peninsula on the E. and the three southern promontories of Malea, Tenaaros and Acritas. At the eastern end of the northern chain, separating Arcadia from the Gulf of Corinth, is Ziria (anc. Cylene, 7789 ft.); it forms a counterpart to Parnassus on the opposite side of the gulf. A little to the W. is Chelmos (anc. Araxia, 7725 ft.); farther W. Olonos (anc. Erymanthus, 7297 ft.) and Zolias (anc. Panachaikon, 6322 ft.) overlooking the Gulf of Patras. The highest summit in the Argolid peninsula is Hagios Elias (anc. Arachnaeon, 3930 ft.). The series of heights forming the eastern rampart of Arcadia, including Artemision (5814 ft.) and Ktenia (5246 ft.) is continued to the S. by the Malevo range (anc. Parnon, highest summit 6365 ft.) which extends into the peninsula of Malea and reappears in the island of Cerigo. Separated from Parnon by the Eurotas valley to the W., the chain of Taygetus (mod. *Pentadaktylon*; highest summit Hagios Elias, 7874 ft., the culminating point of the Morea) forms a barrier between the plains of Laconia and Messenia; it is traversed by the Langada pass leading from Sparta to Kalamata. The range is prolonged to the S. through the arid district of Maina and terminates in Cape Matapan (anc. *Taenarum*). The mountains of western Arcadia are less lofty and of a less marked type; they include Hagios Petros (4777 ft.) and Palaecastro (anc. *Pholoi*, 2257 ft.) N. of the Alpheus valley, Diaphorti (anc. *Lycæus*, 4660 ft.), the haunt of Pan, and Nomia (4554 ft.) W. of the plain of Megalopolis. Farther south, the mountains of western Messenia form a detached group (Varvara, 4003 ft.; Mathia, 3140 ft.) extending to Cape Gallo (anc. *Acritas*) and the Oenussae Islands. In central Arcadia are Apanokrapa (anc. *Maenalus*, also sacred to Pan) and Roudia (5072 ft.); the Taygetus chain forms the southern continuation of these mountains.

The more noteworthy fortified heights of ancient Greece were the Acrocorinthus, the citadel of Corinth (1885 ft.); Ithome (2631 ft.) at Messene; Larissa (950 ft.) at Argos; the Acropolis of Mycenae (910 ft.); Tiryns (60 ft.) near Nauplia, which also possessed its own citadel, the Palamidhi or Acro-nauplia (705 ft.); the Acropolis of Athens (300 ft. above the mean level of the city and 512 ft. above the sea), and the Cadmea of Thebes (713 ft.).

Greece has few rivers; most of these are small, rapid and turbid, as might be expected from the mountainous configuration of the country. They are either perennial rivers or torrents, the white beds of the latter being dry in summer, and only filled with water after the autumn rains. The chief rivers (none of which is navigable) are the Salambria (Peneus) in Thessaly, the Mavroptamo (Cephalus) in Phocia, the Hellada (Spercheios) in Phthiotis, the Aspropotamo (Achelous) in Aetolia, and the Ruphia (Alpheus) and Vasiliko (Eurotas) in the Morea. Of the famous rivers of Athens, the one, the Ilissus, is only a chain of pools all summer, and the other, the Cephissus, though never absolutely dry, does not reach the sea.

being drawn off in numerous artificial channels to irrigate the neighbouring olive groves. A frequent peculiarity of the Greek rivers is their sudden disappearance in subterranean chasms and reappearance on the surface again, such as gave rise to the fabled course of the Alpheus under the sea, and its emergence in the fountain of Arethusa in Syracuse. Some of these chasms—"Katavothras"—are merely sieves with herbage and gravel in the bottom, but others are large caverns through which the course of the river may sometimes be followed. Floods are frequent, especially in autumn, and natural fountains abound and gush out even from the tops of the hills. Aganippe rises high up among the peaks of Helicon, and Peirene flows from the summit of Acrocorinthus. The only noteworthy cascade, however, is that of the Styx in Arcadia, which has a fall of 500 ft. During part of the year it is lost in snow, and it is at all times almost inaccessible. Lakes are numerous, but few are of considerable size, and many merely marshes in summer. The largest are Karla (*Bocheis*) in Thessaly, Trichonis in Aetolia, Copals in Boeotia, Pheneus and Stymphalus in Arcadia.

The valleys are generally narrow, and the plains small in extent, deep basins walled in among the hills or more free at the mouths of the rivers. The principal plains are those of Thessaly, Phlissas, Boeotia, Messenia, Argos, Elis and Marathon. The bottom of these plains consists of an alluvial soil, the most fertile in Greece. In some of the mountainous regions, especially in the Morea, are extensive table-lands. The plain of Mantinea is 2000 ft. high, and the upland district of Sciritis, between Sparta and Tegea, is in some parts 3000 ft.

Strabo said that the guiding thing in the geography of Greece was the sea, which presses in upon it at all parts with a thousand arms. From the Gulf of Arta on the one side to the Gulf of Volo on the other the coast is indented with a succession

of natural bays and gulfs. The most important are the Gulfs of Aegina (*Soronicus*) and Lepanto (*Corinthiacus*), which separate the Morea from the northern mainland of Greece—the first an inlet of the Aegean, the second of the Ionian Sea—and are now connected by a canal cut through the high land of the narrow isthmus of Corinth (3½ m. wide). The outer portion of the Gulf of Lepanto is called the Gulf of Patras, and the inner part the Bay of Corinth; a narrow inlet on the north side of the same gulf, called the Bay of Salona or Itea, penetrates northwards into Phocis so far that it is within 24 geographical miles of the Gulf of Zeiton on the north-east coast. The width of the entrance to the gulf of Lepanto is subject to singular changes, which are ascribed to the formation of alluvial deposits by certain marine currents, and their removal again by others. At the time of the Peloponnesian war this channel was 1200 yds. broad; in the time of Strabo it was only 850; and in our own day it has again increased to 2200. On the coast of the Morea there are several large gulfs, that of Arcadia (*Cyparissias*) on the west, Kalamata (*Messeniacus*) and Kolokythia (*Laconicus*) on the south and Nauplia (*Argolicus*) on the east. Between Euboea and the mainland lie the channels of Trikeri, Talanti (*Euboicum Mare*) and Egripo; the latter two are connected by the strait of Egripo (*Euripus*). This strait, which is spanned by a swing-bridge, is about 180 ft. wide, and is remarkable for the unexplained eccentricity of its tide, which has puzzled ancients and moderns alike. The current runs at the average speed of 5 m. an hour, but continues only for a short time in one direction, changing its course, it is said, ten or twelve times in a day; it is sometimes very violent.

There are no volcanoes on the mainland of Greece, but everywhere traces of volcanic action and frequently visitations of earthquakes, for it lies near a centre of volcanic agency, the island of Santorini, which has been within recent years in a state of eruption. There is an extinct crater at Mount Laphystium (*Granitsa*) in Boeotia. The mountain of Methane, on the coast of Argolis, was produced by a volcanic eruption in 282 B.C. Earthquakes laid Thebes in ruins in 1853, destroyed every house in Corinth in 1858, filled up the Castalian spring in 1870, devastated Zante in 1893 and the district of Atalanta in 1894. There are hot springs at Thermopylae and other places, which are used for sanitary purposes. Various parts of the coast exhibit indications of upheaval within historical times. On the coast of Elis four rocky islets are now joined to the land, which were separate from it in the days of ancient Greece. There are traces of earlier sea-beaches at Corinth, and on the coast of the Morea, and at the mouth of the Hellada. The land has gained so much that the pass of Thermopylae which was extremely narrow in the time of Leonidas and his three hundred, is now wide enough for the motions of a whole army.

Structurally, Greece may be divided into two regions, an eastern and a western. The former includes Thessaly, Boeotia, the island of Euboea, the isthmus of Corinth, and the peninsula of *Geology*. Argolis, and, throughout, the strike of the beds is nearly from west to east. The western region includes the Pindus and all the parallel ranges, and the whole of the Peloponnesus excepting Argolis. Here the folds which affect the Mesozoic and early Tertiary strata run approximately from N.N.W. to S.S.E.

Up to the close of the 19th century the greater part of Greece was believed to be formed of Cretaceous rocks, but later researches have shown that the supposed Cretaceous beds include a variety of geological horizons. The geological sequence begins with crystalline

schists and limestones, followed by Palaeozoic, Triassic and Liassic rocks. The oldest beds which hitherto have yielded fossils belong to the Carboniferous System (*Fusulina* limestone of Euboea). Following upon these older beds are the great limestone masses which cover most of the eastern region, and which are now known to include Jurassic, Tithonian, Lower and Upper Cretaceous and Eocene beds. In the Pindus and the Peloponnesus these beds are overlaid by a series of shales and platy limestones (Olonos Limestone of the Peloponnesus), which were formerly supposed to be of Tertiary age. It has now been shown, however, that the upper series of limestones has been brought upon the top of the lower by a great overthrust. Triassic fossils have been found in the Olonos Limestone and it is almost certain that other Mesozoic horizons are represented.

The earth movements which produced the mountain chains of western Greece have folded the Eocene beds and must therefore be of post-Eocene date. The Neogene beds, on the other hand, are not affected by the folds, although by faulting without folding they have in some places been raised to a height of nearly 6000 ft. They lie, however, chiefly along the coast and in the valleys, and consist of marls, conglomerates and sands, sometimes with seams of lignite. The Pikermi deposits, of late Miocene age, are famous for their rich mammalian fauna.

Although the folding which formed the mountain chains appears to have ceased, Greece is still continually shaken by earthquakes, and these earthquakes are closely connected with the great lines of fracture to which the country owes its outline. Around the narrow gulf which separates the Peloponnesus from the mainland, earthquakes are particularly frequent, and another region which is often shaken is the south-western corner of Greece, the peninsula of Messene.¹

(P. L.A.)

The vegetation of Greece in general resembles that of southern Italy while presenting many types common to that of Asia Minor. Owing to the geographical configuration of the peninsula and its Mediterranean regions is often found in juxtaposition with that of central Europe. In respect to its vegetation the country may be regarded as divided into four zones. In the first, extending from the sea-level to the height of 1500 ft., oranges, olives, dates, almonds, pomegranates, figs and vines flourish, and cotton and tobacco are grown. In the neighbourhood of streams are found the laurel, myrtle, oleander and lentisk, together with the plane and white poplar; the cypress is often a picturesque feature in the landscape, and there is a variety of aromatic plants. The second zone, from 1500 to 3500 ft., is the region of the oak, chestnut and other British trees. In the third, from 3500 to 5500 ft., the beech is the characteristic forest tree; the *Abies cephalonica* and *Pinus pinea* now take the place of the *Pinus halepensis*, which grows everywhere in the lower regions. Above 5500 ft. is the Alpine region, marked by small plants, lichens and mosses. During the short period of spring anemones and other wild flowers enrich the hillsides with magnificent colouring; in June all verdure disappears except in the watered districts and elevated plateaux. The asphodel grows abundantly in the dry rocky soil; aloes, planted in rows, form impenetrable hedges. Medicinal plants are numerous, such as the *India Helenium*, the *Mandragora officinarum*, the *Colchicum napellianum* and the *Helleborus orientalis*, which still grows abundantly near Aspraspitia, the ancient Anticyra, at the foot of Parnassus.

The fauna is similar to that of the other Mediterranean peninsulas, and includes some species found in Asia Minor but not elsewhere in Europe. The lion existed in northern Greece in the time of Aristotle and at an earlier period in the Morea. The bear *Panthera* is still found in the Pindus range. Wolves are common in all the mountainous regions and jackals are numerous in the Morea. Foxes are abundant in all parts of the country; the polecat is found in the woods of Attica and the Morea; the lynx is now rare. The wild boar is common in the mountains of northern Greece, but is almost extinct in the Peloponnesus. The badger, the marten and the weasel are found on the mainland and in the islands. The red deer, the fallow deer and the roe exist in northern Greece, but are becoming scarce. The otter is rare. Hares and rabbits are abundant in many parts of the country, especially in the Cyclades; the two species never occupy the same district, and in the Cyclades some islands (Naxos, Melos, Tenos, &c.) form the exclusive domain of the hares, others (Scriphos, Kimolos, Mykonos, &c.) of the rabbits. In Andros alone a demarcation has been arrived at, the hares retaining the northern and the rabbits the southern portion of the island.

¹ For the Geology of Greece see: M. Neumayr, &c., *Denks. k. Akad. Wiss. Wien, math.-nat. Cl. vol. xl.* (1880); A. Philippson, *Der Peloponnes* (Berlin, 1892) and "Beiträge zur Kenntnis der griechischen Inselwelt," *Peterm. Mit., Ergänz.-heft No. 134* (1901); R. Lepsius, *Geologie von Attika* (Berlin, 1893); L. Cayeux, "Phénomènes de charriage dans la Méditerranée orientale," *C. R. Acad. Sci. Paris*, vol. cxxvi. (1903) pp. 474-476; J. Deprat, "Note préliminaire sur la géologie de l'île d'Eubée," *Bull. Soc. Géol. France*, ser. 4, vol. iii. (1903) pp. 229-243, p. vii. and "Note sur la géologie du massif de Pélion et sur l'influence exercée par les massifs archéens sur la tectonique de l'Égée," *ib. vol. iv.* (1904), pp. 299-338.

In Epirus at the outbreak of war about 15,000 Greeks, including a cavalry regiment and five batteries, the whole under Colonel Manos, occupied a line of defence from Arta to Peta. The Turks, about 28,000 strong, with forty-eight guns, under Achmet Hifsi Pasha, were distributed mainly at Iannina, Pentepagadia, and in front of Arta. On 18th April the Turks commenced a three days' bombardment of Arta; but successive attempts to take the bridge were repulsed, and during the night of the 21st they retired on Philippiada, 26 m. distant, which was attacked and occupied by Colonel Manos on the 23rd. The Greeks then advanced to Pentepagadia, meeting with little resistance. Their difficulties now began. After some skirmishing on the 27th, the position held by their advanced force near Homopolus was attacked on the 28th. The attack was renewed on the 29th, and no Greek reinforcements were forthcoming when needed. The Euzones made a good defence, but were driven back by superior force, and a retreat was ordered, which quickly degenerated into panic-stricken flight to and across the Arta. Reinforcements, including 2500 Epirote volunteers, were sent to Arta from Athens, and on 12th May another incursion into Turkish territory began, the apparent object being to occupy a portion of the country in view of the breakdown in Thessaly and the probability that hostilities would shortly end. The advance was made in three columns, while the Epirote volunteers were landed near the mouth of the Luro river with the idea of cutting off the Turkish garrison of Prevesa. The centre column, consisting of a brigade, three squadrons and two batteries, which were intended to take up and hold a defensive position, attacked the Turks near Strevina on the 13th. The Greeks fought well, and being reinforced by a battalion from the left column, resumed the offensive on the following day, and fairly held their own. On the night of the 15th a retreat was ordered and well carried out. The volunteers landed at the mouth of the Luro, were attacked and routed with heavy loss.

The campaign in Epirus thus failed as completely as that in Thessaly. Under the terms of the treaty of peace, signed on 20th September, and arranged by the European powers, Turkey obtained an indemnity of £14,000,000, and a rectification of the Thessalian frontier, carrying with it some strategic advantage. History records few more unjustifiable wars than that which Greece gratuitously provoked. The Greek troops on several occasions showed tenacity and endurance, but discipline and cohesion were manifestly wanting. Many of the officers were incapable; the campaign was gravely mismanaged; and politics, which led to the war, impeded its operations. On the other hand, the fruits of the German tuition, which began in 1880, and received a powerful stimulus by the appointment of General von der Goltz in 1883, were shown in the Turkish army. The mobilization was on the whole smoothly carried out, and the newly completed railways greatly facilitated the concentration on the frontier. The young school of officers trained by General von der Goltz displayed ability, and the artillery at Pharsala and Domokos was well handled. The superior leading was, however, not conspicuously successful; and while the rank and file again showed excellent military qualities, political conditions and the Oriental predilection for half-measures and for denying full responsibility and full powers to commanders in the field enfeebled the conduct of the campaign. On account of the total want of careful and systematic peace training on both sides, a war which presented several interesting strategic problems provided warnings in place of military lessons. (G. S. C.)

GREECE,¹ an ancient geographical area, and a modern kingdom more or less corresponding thereto, situated at the south-eastern extremity of Europe and forming the most southerly portion of the Balkan Peninsula. The modern kingdom is bounded on the N. by European Turkey and on the E., S. and W. by the Aegean, Mediterranean and Ionian seas. The name *Graecia*, which was more or less vaguely given to the ancient country by the Romans, seems not to have been employed by any native writer before Aristotle; it was apparently derived

¹ See also GREEK ART, GREEK LANGUAGE, GREEK LAW, GREEK LITERATURE, GREEK RELIGION.

by the Romans from the Illyrians, who applied the name of an Epirote tribe (*Γραικοί*, Graeci) to all their southern neighbours. The names *Hellas*, *Hellenes* (*Ἕλλας*, *Ἕλληνες*), by which the ancient Greeks called their country and their race, and which are still employed by the modern Greeks, originally designated a small district in Phthiotis in Thessaly and its inhabitants, who gradually spread over the lands south of the Cambunian mountains. The name *Hellenes* was not universally applied to the Greek race until the post-Homeric epoch (Thucyd. i. 3).

I. GEOGRAPHY AND STATISTICS

The ancient Greeks had a somewhat vague conception of the northern limits of *Hellas*. Thessaly was generally included and Epirus excluded; some writers included some of the southern cantons of Epirus, while others excluded not only all that country but *Aetolia* and *Acarnania*. Generally speaking, the confines of *Hellas* in the age of its greatest distinction were represented by a line drawn from the northern shore of the Ambracian Gulf on the W. to the mouth of the Peneus on the E. Macedonia and Thrace were regarded as outside the pale of Hellenic civilization till 386 B.C., when after his conquest of Thessaly and Phocis, Philip of Macedon obtained a seat in the Amphictyonic Council. In another sense, however, the name *Hellas* expressed an ethnological rather than a geographical unity; it denoted every country inhabited by *Hellenes*. It thus embraced all the Greek settlements on the coasts and islands of the Mediterranean, on the shores of the Hellespont, the Bosphorus and the Black Sea. Nevertheless, the Greek peninsula within the limits described above, together with the adjacent islands, was always regarded as *Hellas par excellence*. The continental area of *Hellas* proper was no greater than that of the modern Greek kingdom, which comprises but a small portion of the territories actually occupied by the Greek race. The Greeks have always been a maritime people, and the real centre of the national life is now, as in antiquity, the Aegean Sea or Archipelago. Thickly studded with islands and bordered by deeply indented coasts with sheltered creeks and harbours, the Aegean in the earliest days of navigation invited the enterprise of the mariner; its shores, both European and Asiatic, became covered with Greek settlements and its islands, together with Crete and Cyprus, became Greek. True to their maritime instincts, the Greeks rarely advanced inland to any distance from the sea; the coasts of Macedonia, Thrace and Asia Minor are still mainly Greek, but, except for some isolated colonies, the *hinterland* in each case lies outside the limits of the race. Continental Greece is divided by its mountain ranges into a number of natural cantons; the existence of physical barriers tended in the earliest times to the growth of isolated political communities, and in the epoch of its ancient independence the country was occupied by seventeen separate states, none of them larger than an ordinary English county. These states, which are noticed separately, were: Thessaly, in northern Greece; *Acarnania*, *Aetolia*, *Locris*, *Doris*, *Phocis*, *Megaris*, *Boeotia* and *Attica* in central Greece; and *Corinthia*, *Sicyonia*, *Achaea*, *Elis*, *Messenia*, *Laconia*, *Argolis* and *Arcadia* in the Peloponnesus.

Modern Greece, which (including the adjacent islands) extends from 35° 50' to 39° 54' N. and from 19° 20' to 26° 15' E., comprises all the area formerly occupied by these states. Under the arrangement concluded at Constantinople on the 21st of July 1832 between Great Britain, France, Russia and Turkey, the northern boundary of Greece was drawn from the Gulf of Arta (*Sinus Ambracius*) to the Gulf of Volo (*S. Pagasaeus*), the line keeping to the crest of the Othrys range. Thessaly and part of *Acarnania* were thus left to Turkey. The island of *Euboea*, the *Cyclades* and the northern *Sporades* were added to the new kingdom. In 1864 the Ionian Islands (*q.v.*) were ceded by Great Britain to Greece. In 1880 the Conference of Berlin proposed a new frontier, which transferred to Greece not only Thessaly but a considerable portion of southern Epirus, extending to the river *Kalamas*. This, however, was rejected by Turkey, and the existing boundary was traced in 1881. Starting from the Aegean coast at a point

Extent of ancient Greece.

Extent of modern Greece.

regiments). It consists of a red cap with dark blue tassel, a white shirt with wide sleeves, a vest and jacket, sometimes of velvet, handsomely adorned with gold or black braid, a belt in which various weapons are carried, a white kilt or *fustanella* of many folds, white hose tied with garters, and red leather shoes with pointed ends, from which a tassel depends. Over all is worn the shaggy white *capote*. The islanders wear a dark blue costume with a crimson waistband, loose trousers descending to the knee, stockings and pumps or long boots. The women's costume is very varied; the loose red *fez* is sometimes worn and a short velvet jacket with rich gold embroidery. The more elderly women are generally attired in black. In the Megara district and elsewhere peasant girls wear on festive occasions a head-dress composed of strings of coins which formerly represented the dowry.

Greece is a constitutional monarchy; hereditary in the male line, or, in case of its extinction, in the female. The sovereign, by decision of the conference of London (August 1863), is styled "king of the Hellenes"; the title "king of Greece" was borne by King Otho. The heir apparent is styled *ὁ διάδοχος*, "the successor"; the title "duke of Sparta," which has been accorded to the crown prince, is not generally employed in Greece. The king and the heir apparent must belong to the Orthodox Greek Church; a special exception has been made for King George, who is a Lutheran. The king attains his majority on completing his eighteenth year; before ascending the throne he must take the oath to the constitution in presence of the principal ecclesiastical and lay dignitaries of the kingdom, and must convoke the Chamber within two months after his accession. The civil list amounts to 1,125,000 dr., in addition to which it was provided that King George should receive £4000 annually as a personal allowance from each of the three protecting powers, Great Britain, France and Russia. The heir apparent receives from the state an annuity of 200,000 dr. The king has a palace at Athens and other residences at Corfu, Tatoi (on the slopes of Mt Parnes) and Larissa. The present constitution dates from the 29th of October 1864. The legislative power is shared by the king with a single chamber (*βουλὴ*) elected by manhood suffrage for a period of four years. The election is by ballot; candidates must have completed their thirtieth year and electors their twenty-first. The deputies (*βουλευταὶ*), according to the constitution, receive only their travelling expenses, but they vote themselves a payment of 1800 dr. each for the session and a further allowance in case of an extraordinary session. The Chamber sits for a term of not less than three or more than six months. No law can be passed except by an absolute majority of the house, and one-half of the members must be present to form a quorum; these arrangements have greatly facilitated the practice of obstruction, and often enable individual deputies to impose terms on the government for their attendance. In 1898 the number of deputies was 234. Some years previously a law diminishing the national representation and enlarging the constituencies was passed by Trikoupis with the object of checking the local influence of electors upon deputies, but the measure was subsequently repealed. The number of deputies, however, who had hitherto been elected in the proportion of one to twelve thousand of the population, was reduced in 1905, when the proportion of one to sixteen thousand was substituted; the Chamber of 1906, elected under the new system, consisted of 177 deputies. In 1906 the electoral districts were diminished in number and enlarged so as to coincide with the twenty-six administrative departments (*νόμοι*); the reduction of these departments to their former number of sixteen, which is in contemplation, will bring about some further diminution in parliamentary representation. It is hoped that recent legislation will tend to check the pernicious practice of bartering personal favours, known as *συναλλαγὴ*, which still prevails to the great detriment of public morality, paralysing all branches of the administration and wasting the resources of the state. Political parties are formed not for the furtherance of any principle or cause, but with the object of obtaining the spoils of office, and

the various groups, possessing no party watchword or programme, frankly designate themselves by the names of their leaders. Even the strongest government is compelled to bargain with its supporters in regard to the distribution of patronage and other favours. The consequent instability of successive ministries has retarded useful legislation and seriously checked the national progress. In 1906 a law was passed disqualifying junior officers of the army and navy for membership of the Chamber; great numbers of these had hitherto been candidates at every election. This much-needed measure had previously been passed by Trikoupis, but had been repealed by his rival Delyannas. The executive is vested in the king, who is personally irresponsible, and governs through ministers chosen by himself and responsible to the Chamber, of which they are *ex-officio* members. He appoints all public officials, sanctions and proclaims laws, convokes, prorogues and dissolves the Chamber, grants pardon or amnesty, coins money and confers decorations. There are seven ministries which respectively control the departments of foreign affairs, the interior, justice, finance, education and worship, the army and the navy.

The 26 departments or *νομοὶ*, into which the country is divided for administrative purposes, are each under a prefect or nomarch (*νόμαρχος*); they are subdivided into 60 districts or eparchies, and into 445 communes or demes (*δήμοι*) Local administration. under mayors or demarchs (*δημαρχοί*). The prefects and sub-prefects are nominated by the government; the mayors are elected by the communes for a period of four years. The prefects are assisted by a departmental council, elected by the population, which manages local business and assesses rates; there are also communal councils under the presidency of the mayors. There are altogether some 12,000 state-paid officials in the country, most of them inadequately remunerated and liable to removal or transferral upon a change of government. A host of office-seekers has thus been created, and large numbers of educated persons spend many years in idleness or in political agitation. A law passed in 1905 secures tenure of office to civil servants of fifteen years' standing, and some restrictions have been placed on the dismissal and transferral of schoolmasters.

Under the Turks the Greeks retained, together with their ecclesiastical institutions, a certain measure of local self-government and judicial independence. The Byzantine code, based on the Roman, as embodied in the *Ἐκτάββλος* Justice. of Armenopoulos (1345), was sanctioned by royal decree in 1855 with some modifications as the civil law of Greece. Further modifications and new enactments were subsequently introduced, derived from the old French and Bavarian systems. The penal code is Bavarian, the commercial French. Liberty of person and domicile is inviolate; no arrest can be made, no house entered, and no letter opened without a judicial warrant. Trial by jury is established for criminal, political and press offences. A new civil code, based on Saxon and Italian law, has been drawn up by a commission of jurists, but it has not yet been considered by the Chamber. A separate civil code, partly French, partly Italian, is in force in the Ionian Islands. The law is administered by 1 court of cassation (styled the "Areopagus"), 5 courts of appeal, 26 courts of first instance, 233 justices of the peace and 19 correctional tribunals.

The judges, who are appointed by the Crown, are liable to removal by the minister of justice, whose exercise of this right is often invoked by political partisans. The administration of justice suffers in consequence, more especially in the country districts, where the judges must reckon with the influential politicians and their adherents. The pardon or release of a convicted criminal is not infrequently due to pressure on the part of some powerful patron. The lamentable effects of this system have long been recognized, and in 1906 a law was introduced securing tenure of office for two or four years to judges of the courts of first instance and of the inferior tribunals. In the circumstances crime is less rife than might be expected, the temperate habits of the Greeks have conduced to this result. A serious feature is the great prevalence of homicide, due in

part to the passionate character of the people, but still more to the almost universal practice of carrying weapons. The traditions of the vendetta are almost extinct in the Ionian Islands, but still linger in Maina, where family feuds are transmitted from generation to generation. The brigand of the old-fashioned type (ληστές, κλέφτες) has almost disappeared, except in the remoter country districts, and piracy, once so prevalent in the Aegean, has been practically suppressed, but numbers of outlaws or absconding criminals (φωγέται) still haunt the mountains, and the efforts of the police to bring them to justice are far from successful. Their ranks were considerably increased after the war of 1897, when many deserters from the army and adventurers who came to Greece as volunteers betook themselves to a predatory life. On the other hand, there is no habitually criminal class in Greece, such as exists in the large centres of civilization, and professional mendicancy is still rare.

Police duties, for which officers and, in some cases, soldiers of the regular army were formerly employed, are since 1906 carried out by a reorganized gendarmerie force of 194 officers and 6344 non-commissioned officers and men, distributed in the twenty-six departments and commanded by an inspector-general resident at Athens, who is aided by a consultative commission. There are male and female prisons at all the departmental centres; the number of prisoners in 1906 was 5705. Except in the Ionian Islands, the general condition of the prisons is deplorable; discipline and sanitation are very deficient, and conflicts among the prisoners are sometimes reported in which knives and even revolvers are employed. A good prison has been built near Athens by Andreas Syngros, and a reformatory for juvenile offenders (εφεστρατόν) has been founded by George Averoff, another national benefactor. Capital sentences are usually commuted to penal servitude for life; executions, for which the guillotine is employed, are for the most part carried out on the island of Bourzi near Nauplia; they are often postponed for months or even for years. There is no enactment resembling the Habeas Corpus Act, and accused persons may be detained indefinitely before trial. The Greeks, like the other nations liberated from Turkish rule, are somewhat litigious, and numbers of lawyers find occupation even in the smaller country towns.

The Greeks, an intelligent people, have always shown a remarkable zeal for learning, and popular education has made great strides. So eager is the desire for instruction that schools are often founded in the rural districts on the initiative of the villagers, and the sons of peasants, artisans and small shopkeepers come in numbers to Athens, where they support themselves by domestic service or other humble occupations in order to study at the university during their spare hours. Almost immediately after the accession of King Otto steps were taken to establish elementary schools in all the communes, and education was made obligatory. The law is not very rigorously applied in the remoter districts, but its enforcement is scarcely necessary. In 1898 there were 2914 "demic" or primary schools, with 3465 teachers, attended by 129,210 boys (5.38% of the population) and 29,119 girls (1.19% of the population). By a law passed in 1905 the primary schools, which had reached the number of 3359 in that year, were reduced to 2604. The expenditure on primary schools is nominally sustained by the communes, but in reality by the government in the form of advances to the communes, which are not repaid; it was reduced in 1905 from upwards of 7,000,000 dr. to under 6,000,000 dr. In 1905 there were 306 "Hellenic" or secondary schools, with 819 teachers and 21,575 pupils (boys only) maintained by the state at a cost of 1,720,096 dr.; and 39 higher schools, or gymnasia, with 261 masters and 6483 pupils, partly maintained by the state (expenditure 615,600 dr.) and partly by benefactions and other means. Besides these public schools there are several private educational institutions, of which there are eight at Athens with 650 pupils. The Polytechnic Institute of Athens affords technical instruction in the departments of art and science to 221 students. Scientific agricultural instruction has been much neglected; there is an agricultural school at

Aidinon in Thessaly with 40 pupils; there are eight agricultural stations (εργαστήρια) in various parts of the country. There are two theological seminaries—the Rizari School at Athens (120 pupils) and a preparatory school at Arta; three other seminaries have been suppressed. The Commercial and Industrial Academy at Athens (about 225 pupils), a private institution, has proved highly useful to the country; there are four commercial schools, each in one of the country towns. A large school for females at Athens, the Arnakion, is attended by 1200 girls. There are several military and naval schools, including the military college of the Eusepiades at Athens and the school of naval cadets (σχολή ναυτικών) at Athens. The university of Athens in 1905 numbered 57 professors and 2598 students, of whom 557 were from abroad. Of the six faculties, theology numbered 79 students, law 1467, medicine 567, arts 206, physics and mathematics 192, and pharmacy 87. The university receives a subvention from the state, which in 1905 amounted to 563,960 dr.; it possesses a library of over 150,000 volumes and geological, zoological and botanical museums. A small tax on university education was imposed in 1903; the total cost to the student for the four years' course at the university is about £25. Higher education is practically gratuitous in Greece, and there is a somewhat ominous increase in the number of educated persons who disdain agricultural pursuits and manual labour. The intellectual culture acquired is too often of a superficial character owing to the tendency to sacrifice scientific thoroughness and accuracy, to neglect the more useful branches of knowledge, and to aim at a showy dialectic and literary proficiency. (For the native and foreign archaeological institutions see ATHENS.)

The Greek branch of the Orthodox Eastern Church is practically independent, like those of Servia, Montenegro and Rumania, though nominally subject to the patriarchate of Constantinople. The jurisdiction of the patriarch was in fact repudiated in 1833, when the king was declared the supreme head of the church, and the severance was completed in 1850. Ecclesiastical affairs are under the control of the Ministry of Education. Church government is vested in the Holy Synod, a council of five ecclesiastics under the presidency of the metropolitan of Athens; its sittings are attended by a royal commissioner. The church can invoke the aid of the civil authorities for the punishment of heresy and the suppression of unorthodox literature, pictures, &c. There were formerly 21 archbishoprics and 29 bishoprics in Greece, but a law passed in 1899 suppressed the archbishoprics (except the metropolitan see of Athens) on the death of the existing prelates, and fixed the total number of sees at 32. The prelates derive their incomes partly from the state and partly from the church lands. There are about 3500 priests, who belong for the most part to the poorest classes. The parochial clergy have no fixed stipends, and often resort to agriculture or small trading in order to supplement the scanty fees earned by their ministrations. Owing to their lack of education their personal influence over their parishioners is seldom considerable. In addition to the parochial clergy there are 19 preachers (λεροχρημικες) salaried by the state. There are 170 monasteries and 4 nunneries in Greece, with about 1600 monks and 250 nuns. In regard to their constitution the monasteries are either "Idiorhythmic" or "coenobian" (see ATHOS); the monks (καλόγηροι) are in some cases assisted by lay brothers (κοσμηκοί). More than 300 of the smaller monasteries were suppressed in 1829 and their revenues secularized. Among the more important and interesting monasteries are those of Megaspelaion and Lavra (where the standard of insurrection, unfurled in 1821, is preserved) near Kalavryta, St Luke of Stiris near Arachova, Daphne and Penteli near Athens, and the Meteora group in northern Thessaly. The bishops, who must be unmarried, are as a rule selected from the monastic order and are nominated by the king; the parish priests are allowed to marry, but the remarriage of widowers is forbidden. The bulk of the population, about 2,000,000, belongs to the Orthodox Church; other Christian confessions number about 15,000, the great majority being Roman Catholics. The Roman Catholics (principally in Naxos and the Cyclades) have three

archbishops (Athens, Naxos and Corfu), five bishops and about 60 churches. The Jews, who are regarded with much hostility, have almost disappeared from the Greek mainland; they now number about 5,000, and are found principally at Corfu. The Mahomedans are confined to Thessaly except a few at Chalcia. National sentiment is a more powerful factor than personal religious conviction in the attachment of the Greeks to the Orthodox Church; a Greek without the pale of the church is more or less an alien. The Catholic Greeks of Syros sided with the Turks at the time of the revolution; the Mahomedans of Crete, though of pure Greek descent, have always been hostile to their Christian fellow-countrymen and are commonly called Turks. On the other hand, that portion of the Macedonian population which acknowledges the patriarch of Constantinople is regarded as Greek, while that which adheres to the Bulgarian exarchate, though differing in no point of doctrine, has been declared schismatic. The constitution of 1864 guarantees toleration to all creeds in Greece and imposes no civil disabilities on account of religion.

Greece is essentially an agricultural country; its prosperity depends on its agricultural products, and more than half the population is occupied in the cultivation of the soil and kindred pursuits. The land in the plains and valleys is exceedingly rich, and, wherever there is a sufficiency of water, produces magnificent crops. Cereals nevertheless furnish the principal figure in the list of imports, the annual value being about 30,000,000 fr. The country, especially since the acquisition of the fertile province of Thessaly, might under a well-developed agricultural system provide a food-supply for all its inhabitants and an abundant surplus for exportation. Thessaly alone, indeed, could furnish cereals for the whole of Greece. Unfortunately, however, agriculture is still in a primitive state, and the condition of the rural population has received very inadequate attention from successive governments. The wooden plough of the Hesiodic type is still in use, especially in Thessaly; modern implements, however, are being gradually introduced. The employment of manure and the rotation of crops are almost unknown; the fields are generally allowed to lie fallow in alternate years. As a rule, countries dependent on agriculture are liable to sudden fluctuations in prosperity, but in Greece the diversity of products is so great that a failure in one class of crops is usually compensated by exceptional abundance in another. Among the causes which have hitherto retarded agricultural progress are the ignorance and conservatism of the peasantry, antiquated methods of cultivation, want of capital, absentee proprietorship, sparsity of population, bad roads, the prevalence of usury, the uncertainty of boundaries and the land tax, which, in the absence of a survey, is levied on ploughing oxen; to these may be added the insecurity hitherto prevailing in many of the country districts and the growing distaste for rural life which has accompanied the spread of education. Large estates are managed under the metayer system; the cultivator paying the proprietor from one-third to half of the gross produce; the landlords, who prefer to live in the larger towns, see little of their tenants, and rarely interest themselves in their welfare. A great proportion of the best arable land in Thessaly is owned by persons who reside permanently out of the country. The great estates in this province extend over some 1,500,000 acres, of which about 500,000 are cultivated. In the Peloponnesus peasant proprietorship is almost universal; elsewhere it is gradually supplanting the metayer system; the small properties vary from 2 or 3 to 50 acres. The extensive state lands, about one-third of the area of Greece, were formerly the property of Mahomedan religious communities (*vakoufis*); they are for the most part farmed out annually by auction. They have been much encroached upon by neighbouring owners; a considerable portion has also been sold to the peasants. The rich plain of Thessaly suffers from alternate droughts and inundations, and from the ravages of field mice; with improved cultivation, drainage and irrigation it might be rendered enormously productive. A commission has been occupied for some years in preparing

a scheme of hydraulic works. Usury is, perhaps, a greater scourge to the rural population than any visitation of nature; the institution of agricultural banks, lending money at a fair rate of interest on the security of their land, would do much to rescue the peasants from the clutches of local Skylocks. There is a difficulty, however, in establishing any system of land credit owing to the lack of a survey. Since 1897 a law passed in 1882 limiting the rate of interest to 8% (to 9% in the case of commercial debts) has to some extent been enforced by the tribunals. In the Ionian Islands the rate of 10% still prevails.

The following figures give approximately the acreage in 1906 and the average annual yield of agricultural produce, no official statistics being available:—

	Acres.
Fields sown or lying fallow	3,000,000
Vineyards	337,500
Current plantations	175,000
Olives (10,000,000 trees)	250,000
Fruit trees (fig, mulberry, &c.)	125,000
Meadows and pastures	7,500,000
Forests	2,000,000
Waste lands	2,875,000
	16,262,500

The average annual yield is as follows:—

Wheat	350,000,000 kilograms
Maize	100,000,000 "
Rye	20,000,000 "
Barley	70,000,000 "
Oats	75,000,000 "
Beans, lentils, &c.	25,000,000 "
Currants	350,000,000 Venetian lb
Sultanina	4,000,000 "
Wine	3,000,000 hectolitres
Olive oil	300,000 "
Olives (preserved)	12,000,000 kilograms
Figs (exported only)	100,000,000 "
Seed cotton	6,500,000 "
Tobacco	8,000,000 "
Vegetables and fresh fruits	20,000,000 "
Cocoons	1,000,000 "
Hesperidium (exported only)	4,000,000 "
Carobs (exported only)	10,000,000 "
Resin	5,000,000 "
Beet	12,000,000 "

Rice is grown in the marshy plains of Elis, Boeotia, Marathon and Missolonghi; beet in Thessaly. The cultivation of vegetables is increasing; beans, peas and lentils are the most common. Potatoes are grown in the upland districts, but are not a general article of diet. Of late years market-gardening has been taken up as a new industry in the neighbourhood of Athens. There is a great variety of fruits. Olive plantations are found everywhere; in 1860 they occupied about 90,000 acres; in 1887, 433,701 acres. The trees are sometimes of immense age and form a picturesque feature in the landscape. In latter years the groves in many parts of the western Morea and Zante have been cut down to make room for currant plantations; the destruction has been deplorable in its consequences, for, as the tree requires twenty years to come into full bearing, replanting is seldom resorted to. Preserved olives, eaten with bread, are a common article of food. Excellent olive oil is produced in Attica and elsewhere. The value of the oil and fruit exported varies from five to ten million francs. Figs are also abundant, especially in Messenia and in the Cyclades. Mulberry trees are planted for the purposes of sericulture; they have been cut down in great numbers in the currant-growing districts. Other fruit trees are the orange, citron, lemon, pomegranate and almond. Peaches, apricots, pears, cherries, &c., abound, but are seldom scientifically cultivated; the fruit is generally gathered while unripe. Cotton in 1906 occupied about 12,500 acres, chiefly in the neighbourhood of Livadia. Tobacco plantations in 1893 covered 16,320 acres, yielding about 3,500,000 kilograms; the yield in 1906 was 9,000,000 kilograms. About 40% of the produce is exported, principally to Egypt and Turkey. More important are the vineyards, which occupied in 1887 an area of 306,421 acres. The best wine is made at Patras, on the royal estate at Declea, and on other estates in Attica; a peculiar flavour is imparted to the wine of the country by the addition of resin. The wine of Santorin, the modern representative of the famous "malmssey," is mainly exported to Russia. The foreign demand for Greek wines is rapidly increasing; 3,770,257 gallons were exported in 1890, 4,974,196 gallons in 1894. There is also a growing demand for Greek cognac. The export of wine in 1905 was 20,850,941 okeas, value 5,848,344 fr.; of cognac, 363,720 okeas, value 1,091,160 fr.

The currant, by far the most important of Greek exports, is cultivated in a limited area extending along the southern shore of the Gulf of Corinth and the seaboard of the Western Peloponnesus.

in Zaure, Cephalonia and Leucas, and in certain districts of Acarnania and Aetolia; attempts to cultivate it elsewhere have generally proved unsuccessful. The history of the currant industry has been a record of extraordinary vicissitudes.

Previously to 1877 the currant was exported solely for eating purposes, the amounts for the years 1872 to 1877 being 70,766 tons, 71,222 tons, 76,210 tons, 72,916 tons, 86,047 tons, and 82,181 tons respectively. In 1877, however, the French vineyards began to suffer seriously from the phylloxera, and French wine producers were obliged to have recourse to dried currants, which make an excellent wine for blending purposes. The importation of currants into France at once rose from 881 tons in 1877 to 20,999 tons in 1880, and to 70,401 tons in 1889, or about 20,000 tons more than were imported into England in that year. Meanwhile the total amount of currants produced in Greece had nearly doubled in these thirteen years. The country was seized with a mania for currant planting; every other industry was neglected, and olive, orange and lemon groves were cut down to make room for the more lucrative growth. The currant growers, in order to increase their production as rapidly as possible, had recourse to loans at a high rate of interest, and the great profits which they made were devoted to further planting, while the loans remained unpaid. A crisis followed rapidly. By 1891 the French vineyards had to a great extent recovered from the disease, and wine producers in France began to clamour against the competition of foreign wines and wine-producing raisins and currants. The import duty on these was thereupon raised from 6 francs to 13 francs per 100 kilos, and was further increased in 1894 to 25 francs. The currant trade with France was thus extinguished; of a crop averaging 160,000 tons, only some 110,000 now found a market. Although a fresh opening for exportation was found in Russia, the value of the fruit dropped from £15 to £5 per ton, a price scarcely covering the cost of cultivation. In July 1895 the government introduced a measure, since known as the Retention (*rapapheosis*) Law, by which it was enacted that every shipper should deliver into depots provided by the government a weight of currants equivalent to 15% of the amount which he intended to export. A later law fixed the quantity to be retained by the state at 10%, which might be increased to 20%, should a representative committee, meeting every summer at Athens, so advise the government. The currants thus taken over by the government cannot be exported unless they are reduced to pulp, syrup or otherwise rendered unsuitable for eating purposes; they may be sold locally for wine-making or distilling, due precautions being taken that they are not used in any other way. The price of exported currants is thus maintained at an artificial figure. The Retention Law, which after 1895 was voted annually, was passed for a period of ten years in 1899. This pernicious measure, which is in defiance of all economic laws, perpetuates a superfluous production, retards the development of other branches of agriculture and burdens the government with vast accumulations of an unmarketable commodity. It might excusably be adopted as a temporary expedient to meet a pressing crisis, but as a permanent system it can only prove detrimental to the country and the currant growers themselves.

In 1899 a "Bank of Viticulture" was established at Patras for the purpose of assisting the growers, to whom it was bound to make advances at a low rate of interest; it undertook the storage and the sale of the retained fruit, from which its capital was derived. The bank soon found itself burdened with an enormous unsaleable stock, while its loans for the most part remained unpaid; meantime over-production, the cause of the trouble, continued to increase, and prices further diminished. In 1903 a syndicate of English and other foreign capitalists made proposals for a monopoly of the export, guaranteeing fixed prices to the growers. The scheme, which conflicted with Anglo-Greek commercial conventions, was rejected by the Theotokis ministry; serious disturbances followed in the currant-growing districts, and M. Theotokis resigned. His successor, M. Kallias, in order to appease the cultivators, arranged that the Currant Bank should offer them fixed minimum prices for the various growths, and guaranteed it a loan of 6,000,000 dr. The resources of the bank, however, gave out before the end of the season, and prices pursued their downward course. Another experiment was then tried; the export duty (15%) was made payable in kind, the retention quota being thus practically raised from 20 to 35%. The only result of this measure was a diminution of the export; in the spring of 1905 prices fell very low and the growers began to despair. A syndicate of banks and capitalists then came forward, which introduced the system now in operation. A privileged company was formed which obtained a charter from the government for twenty years, during which period the retention and export duties are maintained at the fixed rates of 20 and 15% respectively. The company aims at keeping up the prices of the marketable qualities by employing profitably for industrial purposes the unexported surplus and retained inferior qualities; it pays to the state 4,000,000 dr. annually under the head of export duty; offers all growers at the beginning of each agricultural year a fixed price of 115 dr. per 1000 Venetian lb irrespective of quality, and pays a price varying from 115 dr. to 145 dr. according to quality at the end of the year for the unexported surplus. In return for these advantages to the growers the company is entitled to receive 7 dr. on every 1000 lb of currants produced and to dispose of the whole retained amount. A special company has been formed

for the conversion of the superfluous product into spirit, wine, &c. The system may perhaps prove commercially remunerative, but it penalises the producers of the better growths in order to provide a livelihood for the growers of inferior and unmarketable kinds and protracts an abnormal situation. The following table gives the annual currant crop from 1877 to 1905:—

Year.	Total crop (tons).	Exported to Gt. Britain.	Exported to France.
1877	82,181	..	881
1878	100,004	..	9,086
1879	92,311	..	19,087
1880	92,337	..	20,999
1881	121,994	..	30,315
1882	109,403	51,933	26,282
1883	114,980	52,099	24,815
1884	129,268	59,629	39,198
1885	113,287	55,765	37,730
1886	127,570	48,892	45,000
1887	127,160	55,549	37,438
1888	158,728	63,714	40,735
1889	142,308	52,251	69,553
1890	146,749	67,302	37,816
1891	164,545	70,762	39,712
1892	116,944	60,418	21,721
1893	119,886	73,000	6,800
1894	135,500	64,500	15,000
1895	167,695	60,500	26,500
1896	153,514	65,000	6,500
1897	115,730	63,000	2,000
1898	153,514	69,500	6,000
1899	144,071	65,600	3,800
1900	47,236	36,000	300
1901	139,820	58,000	1,216
1902	152,580	58,400	4,782
1903	179,499	54,800	4,470
1904	146,500	58,850	820
1905	162,957	61,700	1,042

The "peronospora," a species of white blight, first caused considerable damage in the Greek vineyards in 1892, recurring in 1897 and 1900.

More than half the cultivable area of Greece is devoted to pasturage. Cattle-rearing, as a rule, is a distinct occupation from agricultural farming; the herds are sent to pasture on the mountains in the summer, and return to the plains at the beginning of winter. The larger cattle are comparatively rare, being kept almost exclusively for agricultural labour; the smaller are very abundant. Beef is scarcely eaten in Greece, the milk of cows is rarely drunk and butter is almost unknown. Cheese, a staple article of diet, is made from the milk of sheep and goats. The number of larger cattle has declined in recent years; that of the smaller has increased. The native breed of oxen is small; buffaloes are seldom seen except in north-western Thessaly; a few camels are used in the neighbourhood of Parnassus. The Thessalian breed of horses, small but sturdy and enduring, can hardly be taken to represent the celebrated chargers of antiquity. Mules are much employed in the mountainous districts; the best type of these animals is found in the islands. The flocks of long-horned sheep and goats add a picturesque feature to Greek rural scenery. The goats are more numerous in proportion to the population than in any other European country (137 per 100 inhabitants). The shepherds' dogs rival those of Bulgaria in ferocity. According to an unofficial estimate published in 1905 the numbers of the various domestic animals in 1899 were as follows: Oxen and buffaloes, 408,744; horses, 157,068; mules, 88,869; donkeys, 141,774; camels, 51; sheep, 4,568,151; goats, 3,339,439; pigs, 79,716. During the four years 1899-1902 the annual average value of imported cattle was 4,218,015 dr., of exported cattle 209,321 dr.

The forest area (about 2,500,000 acres or one-fifth of the surface of the mainland) is for the most part state property. The value of the forests has been estimated at 200,000,000 fr.; the most productive are in the district extending from the Pindus range to the Gulf of Corinth. The principal trees are the oak (about 30 varieties), the various coniferæ, the chestnut, maple, elm, beech, alder, cornel and arbutus. In Greece, as in other lands formerly subject to Turkish rule, the forests are not only neglected, but often deliberately destroyed; this great source of national wealth is thus continually diminishing. Every year immense forest fires may be seen raging in the mountains, and many of the most picturesque districts in the country are converted into desolate wildernesses. These conflagrations are mainly the work of shepherds eager to provide increased pasturage for their flocks; they are sometimes, however, due to the carelessness of smokers, and occasionally, it is said, to spontaneous ignition in hot weather. Great damage is also done by the goats, which browse on the young saplings; the pine trees are much injured by the practice of scoring their bark for resin. With the disappearance of the trees the soil of the mountain slopes, deprived of its natural protection, is soon washed away

by the rain; the rapid descent of the water causes inundations in the plains, while the uplands become sterile and lose their vegetation. The climate has been affected by the change; rain falls less frequently but with greater violence, and the process of denudation is accelerated. The government has from time to time made efforts for the protection of the forests, but with little success till recently. A staff of inspectors and forest guards was first organized in 1877. The administration of the forests has since 1893 been entrusted to a department of the Ministry of Finance, which controls a staff of 4 inspectors (*επιθεωρηταί*), 31 superintendents (*δασαρχοί*), 52 head foresters (*αρχιφύλακες*) and 298 foresters (*δασοφύλακες*). The foresters are aided during the summer months, when fires are most frequent, by about 500 soldiers and gendarmes. About a third of these functionaries have received instruction in the school of forestry at Vythines in the Morea, open since 1898. Owing to the measures now taken, which include excommunication by the parish priests of incendiaries and their accomplices, the conflagrations have considerably diminished. The total annual value of the products of the Greek forests averages 15,000,000 drachmae. The revenue accruing to the government in 1905 was 1,418,158 dr., as compared with 583,991 dr. in 1883. The increase is mainly due to improved administration. The supply of timber for house-construction, ship-building, furniture-making, railway sleepers, &c., is insufficient, and is supplemented by importation (annual value about 12,000,000 francs); transport is rendered difficult by the lack of roads and navigable streams. The principal secondary products are valonea (annual exportation about 1,250,000 fr.) and resin, which is locally employed as a preservative ingredient in the fabrication of wine. The administration of the forests is still defective, and measures for the augmentation and better instruction of the staff of foresters have been designed by the government. In 1900 a society for the re-afforesting of the country districts and environs of the large towns was founded at Athens under the patronage of the crown princess.

The chief minerals are silver, lead, zinc, copper, manganese, magnesia, iron, sulphur and coal. Emeric, salt, millstone and gypsum, which are found in considerable quantities, *Mines.* are worked by the government. The important mines at Laurium, a source of great wealth to ancient Athens, were reopened in 1864 by a Franco-Italian company, but were declared to be state property in 1871; they are now worked by a Greek and a French company. The output of marketable ore in 1899 amounted to 486,760 tons, besides 289,292 tons of dressed lead ore. In 1905 the output was as follows: Raw and roasted manganese iron ore, 113,636 tons; hematite iron ore, 94,734 tons; calamine or zinc ore, 22,612 tons; arsenic and argentiferous lead, 1875 tons; zinc blende and galena, 443 tons; total, 233,300 tons, together with 164,857 tons of dressed lead, producing 13,822 tons of silver pig lead containing 1657 to 1910 grams of silver per ton. It has been found profitable to resmelt the scoriae of the ancient workings. The total value of the exports from the Laurium mines, which in 1875 amounted to only £150,513, had in 1899 increased to £227,209, but fell in 1905 to £499,882. The revenue accruing to the government from all mines

	Tons.	Francs.
Chrome	8,900	337,952
Emery	6,972	742,486
Gypsum	185	7,995
Iron ore	465,622	3,387,407
Ferromanganese	89,687	1,182,652
Lead (argentiferous pig) ore	13,729	6,811,792
Lignite	11,757	143,814
Magnesite	43,460	864,982
Manganese ore	8,171	122,365
Mill stones	12,628	34,660
Salt	25,201	1,638,065
Sulphur	1,126	121,000
Zinc ore	22,562	2,852,355

and quarries, including those worked by the state, was estimated in the budget for 1906 at 1,332,000 dr. The emery of Naxos, which is a state monopoly, is excellent in quality and very abundant. Mines of iron ore have latterly been opened at Larimna in Locris. Magnesite mines are worked by an Anglo-Greek company in Euboea. There are sulphur and manganese mines in the island of Melos, and the volcanic island of Santorin produces pozzolana, a kind of cement, which is exported in considerable quantities. The great abundance of marble in Greece has latterly attracted the attention of foreign capitalists. New quarries have been opened since 1897 by an English company on the north slope of Mount Pentelicus, and are now connected by rail with Athens and the Peiraeus. The marble on this side of the mountain is harder than that on the south, which alone was worked by the ancients. The output in 1905 was 1573 tons. Mount Pentelicus furnished material for most of the celebrated buildings of ancient Athens: the marble, which is white, blue-veined, and somewhat transparent, assumes a rich yellow hue after long exposure to the air. The famous Parian quarries are still worked; white marble is also found at Scyros, Tenos and Naxos; grey at Stoura and Karystos; variegated at Valaxa and Karystos;

green on Taygetus and in Thessaly; black at Tenos; and red (porphyry) in Maina.

The official statistics of the output and value of minerals produced in 1905 were as in the preceding table.

The number of persons employed in mining operations in 1905 was 9934.

Owing to the natural aptitude of the Greeks for commerce and their predilection for a seafaring life a great portion of the trade of the Levant has fallen into their hands. Important Greek mercantile colonies exist in all the larger ports of the Mediterranean and the Black Sea, and many of them possess great wealth. In some of the islands of the archipelago almost every household is the owner or joint owner of a ship. The Greek mercantile marine, which in 1888 consisted of 1352 vessels (70 steamers) with a total tonnage of 219,415 tons, numbered in 1906, according to official returns, 1364 vessels (275 steamers) with a total tonnage of 427,291 tons. This figure is apparently too low, as the ship-owners are prone to understate the tonnage in order to diminish the payment of dues. Almost the whole corn trade of Turkey is in Greek hands. A large number of the sailing ships, especially the smaller vessels engaged in the coasting trade, belong to the islanders. A considerable portion of the shipping on the Danube and Pruth is owned by the inhabitants of Ithaca and Cephalonia; a certain number of their *ships* (*οκάκια*) have latterly been acquired by Rumanian Jews, but the Greek flag is still predominant. There are seven principal Greek steamship companies owning 40 liners with a total tonnage of 21,972 tons. In 1847 there was but one lighthouse in Greek waters; in 1906 there were 70 lighthouses and 68 port lanterns. Hermoupolis (Syra) is the chief seat of the carrying trade, but as a commercial port it yields to Peiraeus, which is the principal centre of distribution for imports. Other important ports are Patras, Volo, Corfu, Kalamata and Laurium.

The following table gives the total value (in francs) of special Greek commerce for the given years:—

	1887.	1892.	1897.	1902.
Imports	131,849,325	119,306,007	116,363,348	137,229,364
Exports	102,652,487	82,261,464	81,708,626	79,663,473

The marked fluctuations in the returns are mainly attributable to variations in the price and quantity of imported cereals and in the sale of currants. The great excess of imports, caused by the large importation of food-stuffs and manufactured articles, is due to the neglect of agriculture and the undeveloped condition of local industries.

The imports and exports for 1905 were distributed as follows:—

	Imports from.		Exports to.	
	Frs.	Frs.	Frs.	Frs.
Russia	27,725,218	810,925		
Great Britain	27,516,928	24,436,707		
Austria-Hungary	19,444,415	7,876,806		
Turkey	15,538,370	4,516,403		
Germany	13,896,687	7,514,474		
France	10,101,070	7,078,321		
Italy	6,190,253	4,266,210		
Bulgaria	5,135,718	133,106		
Rumania	3,814,641	1,152,207		
America	2,656,501	6,440,648		
Belgium	2,276,393	2,068,138		
Netherlands	1,921,762	7,180,301		
Egypt	634,035	5,928,555		
Switzerland	348,281			
Other countries	4,555,781	4,288,365		
Total	141,756,053	83,691,166		

An enumeration of the chief articles of importation and exportation, together with their value, will be found in tabular form overleaf. Greece does not possess any manufacturing industries on a large scale; the absence of a native coal supply is an obstacle to their development. In 1889 there were 145 establishments employing steam of 5568 indicated horse-power; in 1892 the total horse-power employed was estimated at 10,000. In addition to the smelting-works at Laurium, at which some 5000 hands are employed by Greek and French companies and local proprietors, there are flour mills, cloth, cotton and silk spinning mills, ship-building and engineering works, oil-presses, tanneries, powder and dynamite mills, soap mills (about

Principal Articles of Importation.				
Articles.	1904.		1905.	
	Total value in francs.	Imported from the United Kingdom.	Total value in francs.	Imported from the United Kingdom.
Cereals	27,735,808	none	32,511,784	none
Textiles	17,999,344	10,762,464	13,460,620	5,497,172
Raw minerals	13,341,191	7,630,633		
Forest products	10,146,500	9,769	12,254,190	61,309
Wrought metals	7,757,444	2,162,250		
Coals and pit-coal	6,522,086	6,087,088	5,073,841	4,308,357
Yarn and tissues	4,739,819	2,504,667	8,021,523	6,838,079
Fish	4,992,615	2,394,224	1,014,164	186,072
Raw hides	4,558,101	478,965	3,909,657	215,745
Various animals	4,271,151	none	3,373,523	1,268
Horses	3,011,150	none	2,070,250	none
Paper, books, &c.	3,327,444	157,017	3,319,700	76,454
Coffee	2,957,601	293,610	3,060,904	107,296
Sugar	2,606,696	none	2,887,834	70
Rice	1,977,894	63,882	1,901,486	236,027
Colours	1,750,858	341,839	2,146,509	281,433

Chief Articles of Exportation.				
Articles.	1904.		1905.	
	Total value in francs.	Exported to the United Kingdom.	Total value in francs.	Exported to the United Kingdom.
Currants	28,841,678	14,569,137	34,299,780	17,008,929
Minerals and raw metals	19,134,185	5,161,898	15,125,072	5,438,698
Wines	10,084,960	429,143	5,832,139	881,696
Tobacco	7,285,385	39,512	6,157,092	147,565
Olive oil	4,163,262	212,081	2,150,285	64,310
Figs	3,583,428	68,304	3,309,432	338,196
Minerals and metals (worked)	2,754,245	7,750	2,607,580	900
Olives	1,793,362	9,833	1,138,116	18,800
Valonia	1,538,678	200,849	1,077,014	146,927
Cognac.	1,027,224	12,039	1,091,160	2,283

40), and some manufactures of paper, glass, matches, turpentine, white lead, hats, gloves, candles, &c. About 100 factories are established in the neighbourhood of Athens and Peiræus. The wine industry (10 factories) is of considerable importance, and the manufacture of cognac has latterly made great progress; there are 10 large and numerous small cognac distilleries. Ship-building is carried on actively at all the ports on the mainland and islands; about 200 ships, mostly of low tonnage, are launched annually.

Public Works.—The important drainage-works at Lake Copais were taken over by an English company in 1890. The lake covered an area of 58,080 acres, the greater part of which is now rendered fit for cultivation. The drainage works consist of a canal, 28 kilometres in length, and a tunnel of 600 metres descending through the mountain to a lower lake, which is connected by a second tunnel with the sea. The reclaimed land is highly fertile. The area under crops amounted in 1906 to 27,414 acres, of which 20,744 were let to tenants and the remainder farmed by the company. The uncultivated portion affords excellent grazing. The canal through the Isthmus of Corinth was opened to navigation in November 1893. The total cost of the works, which were begun by a company in 1882, was 70,000,000 francs. The narrowness of the canal, which is only 24-60 metres broad at the surface, and the strength of the current which passes through it, seriously detract from its utility. The high charges imposed on foreign vessels have proved almost prohibitive. There are reduced rates for ships sailing in Greek waters. Up to the 31st of July 1906, 37,214 vessels, with a tonnage of 4,971,922, had passed through the canal. The receipts up to that date were 3,207,833 drachmæ (mainly from Greek ships) and 415,976 francs (mainly from foreign ships). In 1905, 2930 vessels (2735 Greek) passed through, the receipts being 281,835 drachmæ and 34,142 francs. The total liabilities of the company in 1906 were about 40,000,000 fr. The canal would be more frequented by foreign shipping if the harbours at its entrances were improved, and its sides, which are of masonry, lined with beams; efforts are being made to raise funds for these purposes. The widening of the Eurippus Channel at Chalcis to the extent of 21-56 metres was accomplished in 1894. The operations involved the destruction of the picturesque Venetian tower which guarded the strait. A canal was completed in 1903 rendering navigable the shallow channel between Leucas (Santa Maura) and the mainland (breadth 15 metres, depth 5 metres). Large careening docks were undertaken in 1909 at Peiræus at an estimated cost of 4,750,000 drachmæ.

Communications.—Internal communication by roads is improving, though much remains to be done, especially as regards the quality of the roads. A considerable impetus was given to road-making

under the Trikoupis administration. In 1878 there were only 555 m. of roads; in 1898 there were 2398 m.; in 1906, 3275 m. Electric trams have been introduced at Patras. Railways were open to traffic in 1900 for a length of 598 m.; in 1906 for a length of 867 m. The circuit of the Morea railways (462 m.) was completed in 1902; from Diakophto, on the north coast, a cogwheel railway, finished in 1894, ascends to Kalavryta. A very important undertaking is the completion of a line from Peiræus to the frontier, the contract for which was signed in 1900 between the Greek government and the Eastern Railway Extension Syndicate (subsequently converted into the *Société des Chemins de Fer helléniques*). A line connecting Peiræus with Larissa was begun in 1890, but in 1894 the English company which had undertaken the contract went into liquidation. Under the contract of 1900 the line was drawn through Demerli, in the south of Thessaly, to Larissa, a distance of 217 m., and continued through the vale of Tempe to the Turkish frontier (about 246 m. in all). Branch lines have been constructed to Larina and Chalcis. The establishment of a connexion with the continental railway system, by a junction with the line from Belgrade to Salonica, would be of immense advantage to Greece, and the Peiræus would become an important place of embarkation for Egypt, India and the Far East.

In 1905 the number of post offices was 640. Of these 320 were also telegraph and 89 telephone **Post and telegraphs.** stations, with 664 clerks; the remaining post offices possess no special staff, but

are served by persons who also pursue other occupations. The number of postmen and other employees was 889. During the year there passed through the post 6,897,899 ordinary letters for the interior, 2,980,958 for foreign destinations, 2,788,477 from abroad; 540,411 registered letters or parcels for the interior, 309,907 for foreign countries, and 300,150 from abroad; 880,673 post-cards for the interior, 504,785 from abroad, and 189,975 sent abroad; 100,680 samples; 7,068,125 printed papers for the interior, 5,278,406 to or from foreign countries. Telegraph lines in 1905 extended over 4222 m. with 6836 m. of wires; 841,913 inland telegrams, 221,188 service telegrams and 129,936 telegrams to foreign destinations were despatched, and 169,519 received from abroad. Receipts amounted to 4,589,601 drachmæ (postal service 2,744,212, telegraph and telephone services 1,845,389 drachmæ) and expenditure to 3,954,742 drachmæ.

The Greek army has recently been in a state of transition. Its condition has never been satisfactory, partly owing to the absence of systematic effort in the work of organization, partly owing to the pernicious influence of political parties, and in times of national emergency it has never been in a condition of readiness. The experience of the war of 1897 proved the need of far-reaching administrative changes and disciplinary reforms. A scheme of complete reorganization was subsequently elaborated under the auspices of the crown prince Constantine, the commander-in-chief, and received the assent of the Chamber in June 1904. During the war of 1897 about 65,000 infantry, 1000 cavalry, and 24 batteries were put into the field, and after great efforts another 15,000 men were mobilized. Under the new scheme it is proposed to maintain on a peace footing 1887 officers, 25,140 non-commissioned officers and men, and 4059 horses and mules; in time of war the active army will consist of at least 120,000 men and the territorial army of at least 60,000 men. The heavy expenditure entailed by the project has been an obstacle to its immediate realization. In order to meet this expenditure a special fund has been instituted in addition to the ordinary military budget, and certain revenues have been assigned to it amounting to about 5,500,000 drachmæ annually. In 1906, however, it was decided to suspend partially for five years the operation of the law of 1904 and to devote

the resources thus economized together with other funds to the immediate purchase of new armaments and equipment. Under this temporary arrangement the peace strength of the army in 1908 consisted of 1039 officers and civilians, 19,416 non-commissioned officers and men and 2661 horses and mules; it is calculated that the reserves will furnish about 77,000 men and the territorial army about 37,000 men in time of war.

Military service is obligatory, and liability to serve begins from the twenty-first year. The term of service comprises two years in the active army, ten years in the active army reserve (for cavalry eight years), eight years in the territorial army (for cavalry ten years) and ten years for all branches in the territorial army reserve. As a rule, however, the period of service in the active army has hitherto been considerably shortened; with a view to economy, the men, under the law of 1904, receive furlough after eighteen months with the colours. Exemptions from military service, which were previously very numerous, are also restricted considerably by the law of 1904, which will secure a yearly contingent of about 13,000 men in time of peace. The conscripts in excess of the yearly contingent are withdrawn by lot; they are required to receive six months' training in the ranks as supernumeraries before passing into the reserve, in which they form a special category of "liability" men. Under the temporary system of 1906 the contingent is reduced to about 10,000 men by postponing the abrogation of several exemptions, and the period of service is fixed at fourteen months for all the conscripts alike. The field army as constituted by the law of 1904 consists of 3 divisions, each division comprising 2 brigades of infantry, each of 2 regiments of 3 battalions and other units. There are thus 36 battalions of infantry (of which 12 are cadres); also 6 battalions of *evzones* (highlanders), 18 squadrons of cavalry (6 cadres), 33 batteries of artillery (6 cadres), 3 battalions of engineers and telegraphists, 3 companies of ambulance, 3 of train, &c. The artillery is composed of 24 field batteries, 3 heavy and 6 mountain batteries; it is mainly provided with Krupp 7.5 cm. guns dating from 1870 or earlier. After a series of trials in 1907 it was decided to order 36 field batteries of 7.5 cm. quick-firing guns and 6 mountain batteries, in all 168 guns, with 1500 projectiles for each battery from the Creuzot factory. The infantry, which was hitherto armed with the obsolete Gras rifle (.433 in.), was furnished in 1907 with the Mannlicher-Schönauer (model 1903) of which 100,000 had been delivered in May 1908. Hitherto the gendarmerie, which replaced the police, have formed a corps drawn from the army, which in 1908 consisted of 194 officers and 6344 non-commissioned officers and men, but a law passed in 1907 provided for these forces being thenceforth recruited separately by voluntary enlistment in annual contingents of 700 men. The participation of the officers in politics, which has proved very injurious to discipline, has been checked by a law forbidding officers below the rank of colonel to stand for the Chamber. In the elections of 1905 115 officers were candidates. The three divisional headquarters are at Larissa, Athens and Missolonghi; the six headquarters of brigades are at Trikkala, Larissa, Athens, Chalcis, Missolonghi and Nauplia. In 1907 annual manoeuvres were instituted.

The Greek fleet consisted in 1907 of 3 armoured barbette ships of 4885 tons (built in France in 1890, reconstructed 1899), carrying each three 10-8-in. guns, five 6-in., thirteen quick-firing and smaller guns, and three torpedo tubes; 1 cruiser of 1770 tons (built in 1879), with two 6.7-in. and six light quick-firing guns; 1 armoured central battery ship of 1774 tons (built 1867, reconstructed 1897) with two 8.4 in. and nine small quick-firing guns; 2 coast-defence gunboats with one 10-6-in. gun each; 4 corvettes; 1 torpedo depot ship; 8 destroyers, each with six guns (ordered in 1905); 3 transport steamers; 7 small gunboats; 3 mining boats; 5 torpedo boats; 1 royal yacht; 2 school ships and various minor vessels. The personnel of the navy was composed in 1907 of 437 officers, 26 cadets, 1118 petty officers, 2372 seamen and stokers, 60 boys and 99 civilians, together with 386 artisans employed at the

arsenal. The navy is manned chiefly by conscription; the period of service is two years, with four years in the reserve. The headquarters of the fleet and arsenal are in the island of Salamis, where there is a dockyard with naval stores, a floating dock and a torpedo school. Most of the vessels of the Greek fleet were in 1907 obsolete; in 1904 a commission under the presidency of Prince George proposed the rearmament of the existing ironclads and the purchase of three new ironclads and other vessels. A different scheme of reorganization, providing almost exclusively for submarines and scout vessels, was suggested to the government by the French admiral Fournier in 1908, but was opposed by the Greek naval officers. With a view to the augmentation and better equipment of the fleet a special fund was instituted in 1900 to which certain revenues have been assigned; it has been increased by various donations and bequests and by the proceeds of a state lottery. The fleet is not exercised methodically either in navigation or gunnery practice; a long voyage, however, was undertaken by the ironclad vessels in 1904. The Greeks, especially the islanders of the Aegean, make better sailors than soldiers; the personnel of the navy, if trained by foreign officers, might be brought to a high state of efficiency.

The financial history of Greece has been unsatisfactory from the outset. Excessive military and naval expenditure (mainly due to repeated and hasty mobilizations), a lax and improvident system of administration, the corruption of political parties, and the instability of the government, which has rendered impossible the continuous application of any scheme of fiscal reform—all alike have contributed to the economic ruin of the country. For a long series of years preceding the declaration of national insolvency in 1893 successive budgets presented a deficit, which in years of political excitement and military activity assumed enormous proportions; the shortcomings of the budget were supplied by the proceeds of foreign loans, or by means of advances obtained in the country at a high rate of interest. The two loans which had been contracted during the war of independence were extinguished by means of a conversion in 1889. Of the existing foreign loans the earliest is that of 60,000,000 fr., guaranteed by the three protecting powers in 1832; owing to the payment of interest and amortization by the powers, the capital amounted in 1871 to 100,392,833 fr.; on this Greece pays an annual sum of 900,000 fr., of which 300,000 have been granted by the powers as a yearly subvention to King George. The only other existing foreign obligation of early date is the debt to the heirs of King Otho (4,500,000 dr.) contracted in 1868. A large amount of internal debt was incurred between 1848 and 1880, but a considerable proportion of this was redeemed with the proceeds of the foreign loans negotiated after this period. At the end of 1880 the entire national debt, external and internal, stood at 252,632,481 dr. In 1881 the era of great foreign loans began. In that year a 5% loan of 120,000,000 fr. was raised to defray the expenses of the mobilization of 1880. This was followed in 1884 by a 5% loan of 170,000,000 fr., of which 100,000,000 was actually issued. The service of these loans was guaranteed by various State revenues. A patriotic loan "of 30,000,000 dr. without interest, issued during the war excitement of 1885, proved a failure, only 2,723,860 dr. being subscribed. In 1888 a 4% loan of 135,000,000 fr. was contracted, secured on the receipts of the five State monopolies, the management of which was entrusted to a privileged company. In the following year (1889) two 4% loans of 30,000,000 fr. and 125,000,000 fr. respectively were issued without guarantee or sinking fund; Greek credit had now apparently attained an established position in the foreign money market, but a decline of public confidence soon became evident. In 1890, of a 5% loan of 80,000,000 fr. effective, authorized for the construction of the Peiraeus-Larissa railway, only 40,050,000 fr. was taken up abroad and 12,900,000 fr. at home; large portions of the proceeds were devoted to other purposes. In 1892 the government was compelled to make large additions to the internal floating debt, and to borrow 16,500,000 fr. from the National Bank on onerous terms. In 1893 an effort to obtain a foreign loan for the reduction of the forced currency proved unsuccessful. (For the events leading up to the declaration of national bankruptcy in that year see under *Recent History*.) A funding convention was concluded in the summer, under which the creditors accepted scrip instead of cash payments of interest. A few months later this arrangement was reversed by the Chamber, and on the 13th December a law was passed assigning provisionally to all the foreign loans alike 30% of the stipulated interest; the reduced coupons were made payable in paper instead of gold, the sinking funds were suspended, and the sums encashed by the monopoly company were confiscated. The causes of the financial catastrophe may be briefly summarized as follows: (1) The military preparations of 1885-1886, with the attendant disorganization of the country; the extraordinary expenditure of these years amounted to 130,987,772 dr. (2) Excessive borrowing abroad, involving a charge

for the service of foreign loans altogether disproportionate to the revenue. (3) Remissions in the collection of taxation: the total loss through arrears in a period of ten years (1882-1891) was 36,549,202 dr., being in the main attributable to non-payment of direct taxes. (4) The adverse balance of trade, largely due to the neglected condition of agriculture; in the five years preceding the crisis (1888-1892) the exports were stated to amount to 119,578,973; while the imports reached £24,890,146; foreign live stock and cereals being imported to the amount of £6,193,579. The proximate cause of the crisis was the rise in the exchange owing to the excessive amount of paper money in circulation. Forced currency was first introduced in 1868, when 15,000,000 dr. in paper money was issued; it was abolished in the following year, but reintroduced in 1877 with a paper issue of 44,000,000 dr. It was abolished a second time in 1884, but again put into circulation in 1885, when paper loans to the amount of 45,000,000 dr. were authorized. In 1893 the total authorized forced currency was 146,000,000 dr., of which 88,000,000 (including 14,000,000 dr. in small notes) was on account of the government. The gold and silver coinage had practically disappeared from circulation. The rate of exchange, as a rule, varies directly with the amount of paper money in circulation, but, owing to speculation, it is liable to violent fluctuations whenever there is an exceptional demand for gold in the market. In 1893 the gold franc stood at the ratio of 1.50 to the paper drachma; the service of the foreign loans required upwards of 31,000,000 dr. in gold, and any attempt to realize this sum in the market would have involved an outlay equivalent to at least half the budget. With the failure of the projected loan for the withdrawal of the forced currency repudiation became inevitable. The law of the 13th of December was not recognized by the national creditors: prolonged negotiations followed, but no arrangement was arrived at till 1897, when the intervention of the powers after the war with Turkey furnished the opportunity for a definite settlement. It was stipulated that Turkey should receive an indemnity of £74,000,000 contingent on the evacuation of Thessaly; in order to secure the payment of this sum by Greece without prejudice to the interests of her creditors, and to enable the country to recover from the economic consequences of the war, Great Britain, France and Russia undertook to guarantee a 2½% loan of 170,000,000 fr., of which 150,000,000 fr. has been issued. By the preliminary treaty of peace (18th of September 1897) an International Financial Commission, composed of six representatives of the powers, was charged with the payment of the indemnity to Turkey, and with "absolute control" over the collection and employment of revenue sufficient for the service of the foreign debt. A law defining the powers of the Commission was passed by the Chamber, 26th of February 1898 (o.s.). The revenues assigned to its supervision were the five government monopolies, the tobacco and stamp duties, and the import duties of Peiraeus (total annual value estimated at 39,600,000 dr.); the collection was entrusted to a Greek society, which is under the absolute control of the Commission. The returns of Peiraeus customs (estimated at 10,700,000 dr.) are regarded as an extra guarantee, and are handed over to the Greek government; when the produce of the other revenues exceeds 28,900,000 dr. the "plus value" or surplus is divided in the proportion of 50-8 % to the Greek government and 49-2 % to the creditors. The plus values amounted to 3,301,481 dr. in 1898, 3,533,755 dr. in 1899, and 3,442,713 dr. in 1900. Simultaneously with the establishment of the control the interest for the Monopoly Loan was fixed at 4½%, for the Funding Loan at 4%, and for the other loans at 3½% of the original interest. With the revenues at its disposal the International Commission has already been enabled to make certain augmentations in the service of the foreign debt; since 1900 it has begun to take measures for the reduction of the forced currency, of which 2,000,000 dr. will be annually bought up and destroyed till the amount in circulation is reduced to 40,000,000 dr. On the 1st of January 1901 the authorized paper issue was 164,000,000 dr., of which 92,000,000 (including 18,000,000 in fractional currency) was on account of the government; the amount in actual circulation was 148,619,618 dr. On the 31st of July 1906 the paper issue had been reduced to 152,775,975 dr., and the amount in circulation was 124,668,057 dr. The financial commission retains its powers until the extinction of all the foreign loans contracted since 1881. Though its activity is mainly limited to the administration of the assigned revenues, it has exercised a beneficial influence over the whole domain of Greek finance; the effect may be observed in the greatly enhanced value of Greek securities since its institution, averaging 25-76% in 1906. No change can be made in its composition or working without the consent of the six powers, and none of the officials employed in the collection of the revenues subject to its control can be dismissed or transferred without its consent. It thus constitutes an element of stability and order which cannot fail to react on the general administration. It is unable, however, to control the expenditure or to assert any direct influence over the government, with which the responsibility still rests for an improved system of collection, a more efficient staff of functionaries and the repression of smuggling. The country has shown a remarkable vitality in recovering from the disasters of 1897, and should it in future obtain a respite from paroxysms of military and political excitement, its financial regeneration will be assured.

The following table gives the actual expenditure and receipts for the period 1889-1906 inclusive:

Year.	Actual Receipts.	Actual Expenditure.	Surplus or Deficit.
	Drachmae.	Drachmae.	Drachmae.
1889	83,731,391	110,772,327	-27,040,736
1890	79,931,795	125,932,579	-46,000,784
1891	99,321,872	122,836,384	-23,514,513
1892	95,168,568	107,283,498	-11,817,929
1893 ¹	96,723,418	92,133,365	+4,589,853
1894	102,883,643	85,133,752	+17,749,891
1895	94,657,065	91,641,967	+3,015,098
1896	96,931,726	90,890,607	+6,041,119
1897 ²	92,485,825	137,043,929	-44,558,104
1898 ³	104,949,718	110,341,431	+5,391,713
1899	111,318,273	104,586,504	+6,731,769
1900	112,206,849	112,049,279	+157,570
1901	115,734,159	113,646,301	+2,087,858
1902	123,949,931	121,885,707	+2,064,224
1903	120,194,362	117,436,549	+2,757,813
1904	121,186,246	120,200,247	+985,999
1905	126,472,580	118,699,761	+7,772,819
1906	125,753,358	124,461,577	+1,291,781

The steady increase of receipts since 1898 attests the growing prosperity of the country, but expenditure has been allowed to outstrip revenue, and, notwithstanding the official figures which represent a series of surpluses, the accumulated deficit in 1905 amounted to about 14,000,000 dr. in addition to treasury bonds for 8,000,000 dr. A remarkable feature has been the rapid fall in the exchange since 1903; the gold franc, which stood at 1-63 dr. in 1902, had fallen to 1-08 in October 1906. The decline, a favourable symptom if resulting from normal economic factors, is apparently due to a combination of exceptional circumstances, and consequently may not be maintained; it has imposed a considerable strain on the financial and commercial situation. The purchasing power of the drachma remains almost stationary and the price of imported commodities continues high; import dues, which since 1904 are payable in drachmae at the fixed rate of 1-45 to the franc, have been practically increased by more than 30%. In April 1900 a 4% loan of 43,750,000 francs for the completion of the railway from Peiraeus to the Turkish frontier, and another loan of 11,750,000 drachmae for the construction of a line from Pyrgos to Meligala, linking up the Morea railway system, were sanctioned by the Chamber; the first-named, the "Greek Railways Loan," was taken up at 80 by the syndicate contracting for the works and was placed on the market in 1902. The service of both loans is provided by the International Commission from the surplus funds of the assigned revenues. On the 1st of January 1906 the external debt amounted to 725,939,500 francs and the internal (including the paper circulation) to 171,629,436 drachmae.

The budget estimates for 1906 were as follows: Civil list, 1,325,000 dr.; pensions, payment of deputies, &c., 7,706,676 dr.; public debt, 34,253,471 dr.; foreign affairs, 3,563,994 dr.; justice, 6,240,271 dr.; interior, 13,890,927 dr.; religion and education, 7,143,924 dr.; army, 20,618,263 dr.; navy, 7,583,360 dr.; finance, 2,362,143 dr.; collection of revenue, 10,050,487 dr.; various expenditure, 9,122,752 dr.; total, 124,461,577 dr.

The two privileged banks in Greece are the National Bank, founded in 1841: capital 20,000,000 drachmae in 20,000 shares of 1000 dr. each, fully paid up; reserve fund 13,500,000 dr.; notes in circulation (September 1906) 126,721,887 dr., of which 76,360,905 dr. on account of the government; and the Ionian Bank, incorporated in 1839: capital paid up £315,500 in 63,102 shares of £5 each; notes in circulation, 10,200,000 drachmae, of which 3,500,000 (in fractional notes of 1 and 2 dr.) on account of the government. The notes issued by these two banks constitute the forced paper currency circulating throughout the kingdom. In the case of the Ionian Bank the privilege of issuing notes, originally limited to the Ionian Islands, will expire in 1920. The National Bank is a private institution under supervision of the government, which is represented by a royal commissioner on the board of administration; the central establishment is at Athens with forty-two branches throughout the country. The headquarters of the Ionian Bank, which is a British institution, are in London; the bank has a central office at Athens and five branches in Greece. The privileged Epiro-Thessalian Bank ceased to exist from the 4th of January 1900, when it was amalgamated with the National Bank. There are several other banking companies, as well as private banks, at Athens. The most important is the Bank of Athens (capital 40,000,000 dr.), founded in 1893; it possesses five branches in Greece and six abroad.

Greece entered the Latin Monetary Union in 1868. The monetary unit is the new drachma, equivalent to the franc, and divided into

¹ Reduction of interest on foreign debt by 70 %.

² War with Turkey.

³ International Financial Commission instituted.

100 lepta or centimes. There are nickel coins of 20, 10 and 5 lepta, copper coins of 10 and 5 lepta. Gold and silver coins were minted in Paris between 1868 and 1884, but have since practically disappeared from the country. The paper currency consists of notes for 1000 dr., 500 dr., 100 dr., 25 dr., 10 dr. and 5 dr., and of fractional notes for 2 dr. and 1 dr. *Weights and measures.* The decimal system of weights and measures was adopted in 1876, but some of the old Turkish standards are still in general use. The dram = $\frac{1}{7}$ oz. avoirdupois approximately; the oke = 400 drams or 2.8 lb; the kilo = 22 okes or 0.114 of an imperial quarter; the cantar or quintal = 44 okes or 123.2 lb. Liquids are measured by weight. The punta = 1½ in.; the rappa, 3¼ in.; the pik, 26 in.; the stadion = 1 kilometre or 1093½ yds. The stremma (square measure) is nearly one-third of an acre.

Authorities.—W. Leake, *Researches in Greece* (1814), *Travels in the Morea* (3 vols., 1830), *Travels in Northern Greece* (4 vols., 1834), *Peloponnesiaca* (1846); Bursian, *Geographie von Griechenland* (2 vols., Leipzig, 1862–1873); Lolling, "Hellenische Landeskunde und Topographie," in Ivan Müller's *Handbuch der historischen Altertumswissenschaft*; C. Wordsworth, *Greece; Pictorial, Descriptive and Historical* (new ed., revised by H. F. Tozer, London, 1882); K. Stephano, *La Grèce* (Paris, 1884); C. Neumann and J. Partsch, *Physikalische Geographie von Griechenland* (Breslau, 1885); K. Krumbacher, *Griechische Reise* (Berlin, 1886); J. P. Mahaffy, *Rambles and Studies in Greece* (London, 1887); R. A. H. Bickford-Smith, *Greece under King George* (London, 1893); Ch. Diehl, *Excursions archéologiques en Grèce* (Paris, 1893); Perrot and Chipiez, *Histoire de l'art*, tome vi., "La Grèce primitive" (Paris, 1894); tome vii., "La Grèce archaïque" (Paris, 1898); A. Philippson, *Griechenland und seine Stellung im Orient* (Leipzig, 1897); L. Serraeant, *Greece in the Nineteenth Century* (London, 1897); J. C. Frazer, *Pausanias's Description of Greece* (6 vols., London, 1898); *Pausanias and other Greek Sketches* (London, 1900); *Graeco-Turkish War of 1897*, from official sources, by a German staff officer (Eng. trans., London, 1898); J. A. Symonds, *Studies, and Sketches in Italy and Greece* (3 vols., 2nd ed., London, 1898); V. Bérard, *La Turquie et l'hellénisme contemporaine* (Paris, 1900).

For the climate. D. Aeginetes, *Τὸ κλίμα τῆς Ἑλλάδος* (Athens, 1908).

For the fauna: Th. de Heldrick, *La Faune de la Grèce* (Athens, 1898).

For special topography: A. Meliarares, *Κυκλαδικὰ θῆρα γεωγραφία καὶ ιστορία τῶν Κυκλαδικῶν νήσων* (Athens, 1874); *Τροπικὰ καὶ γεωγραφικὰ τῶν Κυκλαδῶν νήσων* Ἀθήραι καὶ Κίω (Athens, 1880); *Γεωγραφία πόλεως ἡῶν καὶ ἀρχαία τοῦ ποιοῦ Ἀργολίδος καὶ Κορινθίας* (Athens, 1886); *Γεωγραφία πόλεως ἡῶν καὶ ἀρχαία τοῦ ποιοῦ Κεφαλληνίας* (Athens, 1890); Th. Bent, *The Cyclades* (London, 1885); A. Bötticher, *Olympia* (2nd ed., Berlin, 1886); J. Partsch, *Die Insel Corfu: eine geographische Monographie* (Gotha, 1887); *Die Insel Lesbos* (Gotha, 1889); *Kephallenia und Ithaka* (Gotha, 1890); *Die Insel Zante* (Gotha, 1891); A. Philippson, *Der Peloponnes. (Versuch einer Landeskunde auf geologischer Grundlage.)* (Berlin, 1892); "Thessalien und Epirus" (*Reisen und Forschungen im nördlichen Griechenland*) (Berlin, 1897); *Die griechischen Inseln des ägäischen Meeres* (Berlin, 1897); W. J. Woodhouse, *Aetolia* (Oxford, 1897); Schultz and Barnsley, *The Monastery of St Luke of Sitris* (London, 1901); M. Lamprinides, *Ἡ Νάυρα* (Athens, 1898); *Monuments de l'art byzantin*, publiés par le Ministère de l'Instruction, tome I.; G. Millet, "Le Monastère de Daphni" (Paris, 1900). For the life, customs and habits of the modern Greeks: C. Wachsmuth, *Das alte Griechenland im neuen* (Bonn, 1864); C. K. Tuckerman, *The Greeks of to-day* (London, 1873); B. Schmidt, *Volksleben der Neugriechen und das hellenische Altertum* (Leipzig, 1871); Estournelle de Constant, *La Vie de province en Grèce* (Paris, 1878); E. About, *La Grèce contemporaine* (Paris, 1855; 8th ed., 1883); J. T. Bent, *Modern Life and Thought among the Greeks* (London, 1891); J. Rennell Rodd, *The Customs and Lore of Modern Greece* (London, 1892). Guide-books, Baedeker's *Greece* (3rd ed., Leipzig, 1905); Murray's *Handbook for Greece* (7th ed., London, 1905); Macmillan's *Guide to the Eastern Mediterranean* (London, 1901). (J. D. B.)

2. HISTORY

a. Ancient; to 146 B.C.

1. *Introductory.*—It is necessary to indicate at the outset the scope and object of the present article. The reader must not expect to find in it a compendious summary of the chief events in the history of ancient Greece. It is not intended to supply an "Outlines of Greek History." It may be questioned whether such a sketch of the history, within the limits of space which are necessarily imposed in a work of reference, would be of utility to any class of readers. At any rate, the plan of the present work, in which the subject of Greek history is treated of in a large number of separate articles, allows of the narrative of events being given in a more satisfactory form under the more general of the headings (e.g. ATHENS, SPARTA, PELOPONNESIAN

WAR). The character of the history itself suggests a further reason why a general article upon Greek history should not be confined to, or even attempt, a narrative of events. A sketch of Greek history is not possible in the sense in which a sketch of Roman history, or even of English history, is possible. Greek history is not the history of a single state. When Aristotle composed his work upon the constitutions of the Greek states, he found it necessary to extend his survey to no less than 158 states. Greek history is thus concerned with more than 150 separate and independent political communities. Nor is it even the history of a single country. The area occupied by the Greek race extended from the Pyrenees to the Caucasus, and from southern Russia to northern Africa. It is inevitable, therefore, that the impression conveyed by a sketch of Greek history should be a misleading one. A mere narrative can hardly fail to give a false perspective. Experience shows that such a sketch is apt to resolve itself into the history of a few great movements and of a few leading states. What is still worse, it is apt to confine itself, at any rate for the greater part of the period dealt with, to the history of Greece in the narrower sense, i.e. of the Greek peninsula. For the identification of Greece with Greece proper there may be some degree of excuse when we come to the 5th and 4th centuries. In the period that lies behind the year 500 B.C. Greece proper forms but a small part of the Greek world. In the 7th and 6th centuries it is outside Greece itself that we must look for the most active life of the Greek people and the most brilliant manifestations of the Greek spirit. The present article, therefore, will be concerned with the causes and conditions of events, rather than with the events themselves; it will attempt analysis rather than narrative. Its object will be to indicate problems and to criticize views; to suggest lessons and parallels, and to estimate the importance of the Hellenic factor in the development of civilization.

2. *The Minoan and Mycenaean Ages.*—When does Greek history begin? Whatever may be the answer that is given to this question, it will be widely different from any that could have been proposed a generation ago. Then the question was, How late does Greek history begin? To-day the question is, How early does it begin? The suggestion made by Grote that the first Olympiad (776 B.C.) should be taken as the starting-point of the history of Greece, in the proper sense of the term "history," seemed likely, not so many years ago, to win general acceptance. At the present moment the tendency would seem to be to go back as far as the 3rd or 4th millennium B.C. in order to reach a starting-point. It is to the results of archaeological research during the last thirty years that we must attribute so startling a change in the attitude of historical science towards this problem. In the days when Grote published the first volumes of his *History of Greece* archaeology was in its infancy. Its results, so far as they affected the earlier periods of Greek history, were scanty; its methods were unscientific. The methods have been gradually perfected by numerous workers in the field; but the results, which have so profoundly modified our conceptions of the early history of the Aegean area, are principally due to the discoveries of two men, Heinrich Schliemann and A. J. Evans. A full account of these discoveries will be found elsewhere (see *AEGEAN CIVILIZATION AND CRETE*). It will be sufficient to mention here that Schliemann's labours began with the excavations on the site of Troy in the years 1870–1873; that he passed on to the excavations at Mycenae in 1876 and to those at Tiryns in 1884. It was the discoveries of these years that revealed to us the Mycenaean age, and carried back the history to the middle of the 2nd millennium. The discoveries of Dr A. J. Evans in the island of Crete belong to a later period. The work of excavation was begun in 1900, and was carried on in subsequent years. It has revealed to us the Minoan age, and enabled us to trace back the development and origins of the civilization for a further period of 1000 or 1500 years. The dates assigned by archaeologists to the different periods of Mycenaean and Minoan art must be regarded as merely approximate. Even the relation of the two civilizations is still, to some extent, a matter of conjecture. The general chronological scheme,

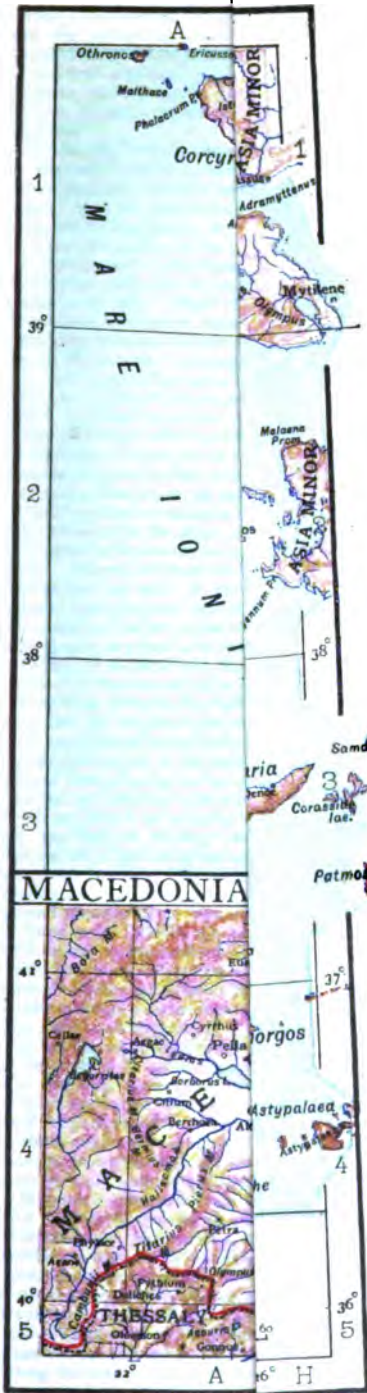

Emery Walker sc.

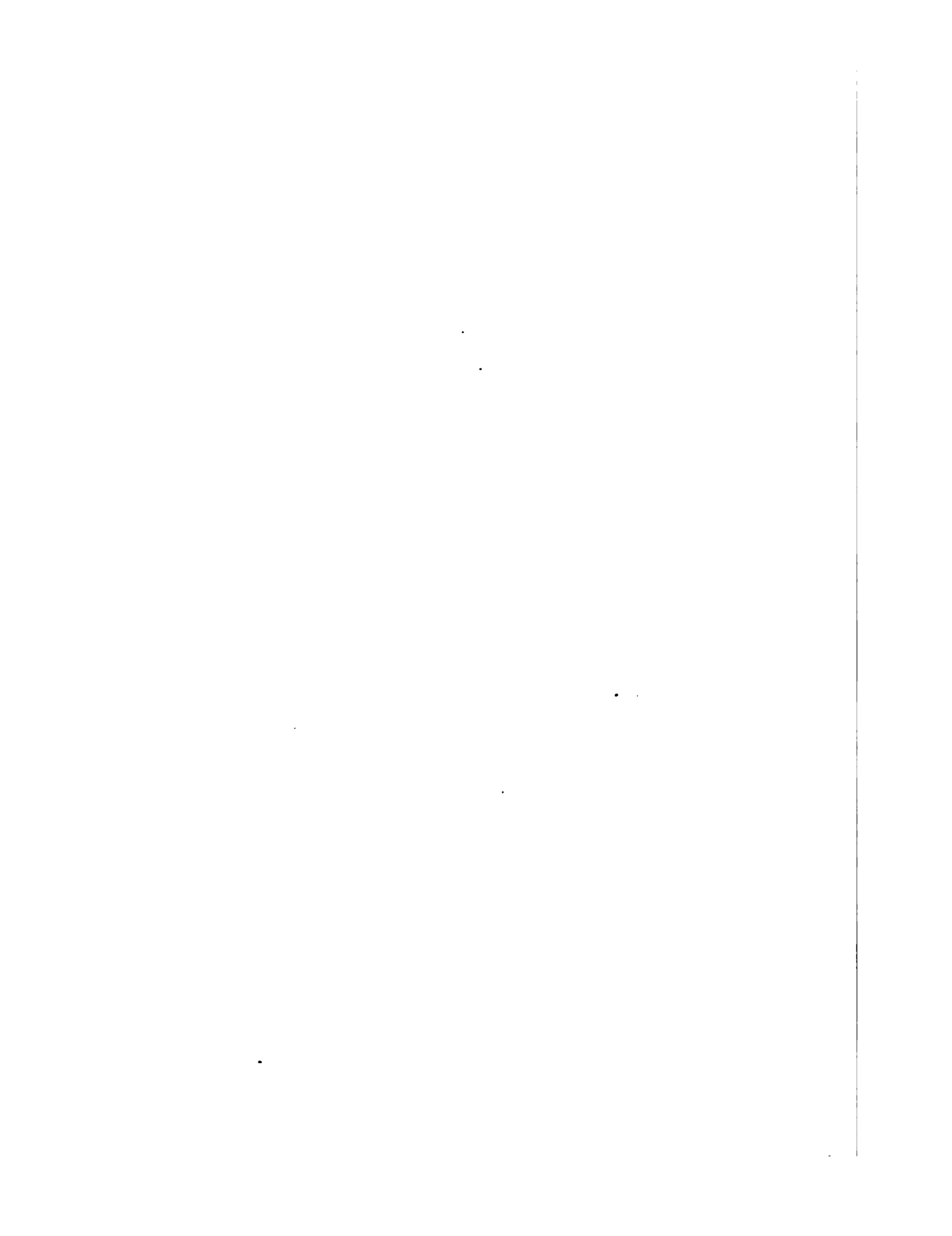

however, in the sense of the relative order of the various periods and the approximate intervals between them, is too firmly established, both by internal evidence, such as the development of the styles of pottery, and of the art in general, and by external evidence, such as the points of contact with Egyptian art and history, to admit of its being any longer seriously called in question.

If, then, by "Greek history" is to be understood the history of the lands occupied in later times by the Greek race (i.e. the Greek peninsula and the Aegean basin), the beginnings of the history must be carried back some 2000 years before Grote's proposed starting-point. If, however, "Greek history" is taken to mean the history of the Greek people, the determination of the starting-point is far from easy. For the question to which archaeology does not as yet supply any certain answer is the question of race. Were the creators of the Minoan and Mycenaean civilization Greeks or were they not? In some degree the Minoan evidence has modified the answer suggested by the Mycenaean. Although wide differences of opinion as to the origin of the Mycenaean civilization existed among scholars when the results of Schliemann's labours were first given to the world, a general agreement had gradually been arrived at in favour of the view which would identify Mycenaean with Achæan or Homeric. In presence of the Cretan evidence it is no longer possible to maintain this view with the same confidence. The two chief difficulties in the way of attributing either the Minoan or the Mycenaean civilization to an Hellenic people are connected respectively with the script and the religion. The excavations at Cnossus have yielded thousands of tablets written in the linear script. There is evidence that this script was in use among the Mycenaean as well. If Greek was the language spoken at Cnossus and Mycenæ, how is it that all attempts to decipher the script have hitherto failed? The Cretan excavations, again, have taught us a great deal as to the religion of the Minoan age; they have, at the same time, thrown a new light upon the evidence supplied by Mycenaean sites. It is no longer possible to ignore the contrast between the cults of the Minoan and Mycenaean ages, and the religious conceptions which they imply, and the cults and religious conceptions prevalent in the historical period. On the other hand, it may safely be asserted that the argument derived from the Mycenaean art, in which we seem to trace a freedom of treatment which is akin to the spirit of the later Greek art, and is in complete contrast to the spirit of Oriental art, has received striking confirmation from the remains of Minoan art. The decipherment of the script would at once solve the problem. We should at least know whether the dominant race in Crete in the Minoan age spoke an Hellenic or a non-Hellenic dialect. And what could be inferred with regard to Crete in the Minoan age could almost certainly be inferred with regard to the mainland in the Mycenaean age. In the meanwhile, possibly until the tablets are read, at any rate until further evidence is forthcoming, any answer that can be given to the question must necessarily be tentative and provisional. (See *ÆGEAN CIVILIZATION*.)

It has already been implied that this period of the history of Greece may be subdivided into a Minoan and a Mycenaean age. Whether these terms are appropriate is a question of comparatively little importance. They at least serve to remind us of the part played by the discoveries at Mycenæ and Cnossus in the reconstruction of the history. The term "Mycenaean," it is true, has other associations than those of locality. It may seem to imply that the civilization disclosed in the excavations at Mycenæ is Achæan in character, and that it is to be connected with the Pelopid dynasty to which Agamemnon belonged. In its scientific use, the term must be cleared of all such associations. Further, as opposed to "Minoan" it must be understood in a more definite sense than that in which it has often been employed. It has come to be generally recognized that two different periods are to be distinguished in Schliemann's discoveries at Mycenæ itself. There is an earlier period, to which belong the objects found in the shaft-graves, and there is a later period, to which belong the beehive tombs and the remains of the palaces. It

is the latter period which is "Mycenaean" in the strict sense; i.e. it is "Mycenaean" as opposed to "Minoan." To this period belong also the palace at Tiryns, the beehive-tombs discovered elsewhere on the mainland of Greece and one of the cities on the site of Troy (Schliemann's sixth). The pottery of this period is as characteristic of it, both in its forms (e.g. the "stirrup" or "false-necked" form of vase) and in its peculiar glaze, as is the architecture of the palaces and the beehive-tombs. Although the chief remains have been found on the mainland of Greece itself, the art of this period is found to have extended as far north as Troy and as far east as Cyprus. On the other hand, hardly any traces of it have been discovered on the west coast of Asia Minor, south of the Troad. The Mycenaean age, in this sense, may be regarded as extending from 1600 to 1200 B.C. The Minoan age is of far wider extent. Its latest period includes both the earlier and the later periods of the remains found at Mycenæ. This is the period called by Dr Evans "Late Minoan." To this period belong the Great Palace at Cnossus and the linear system of writing. The "Middle Minoan" period, to which the earlier palace belongs, is characterized by the pictographic system of writing and by polychrome pottery of a peculiarly beautiful kind. Dr Evans proposes to carry back this period as far as 2500 B.C. Even behind it there are traces of a still earlier civilization. Thus the Minoan age, even if limited to the middle and later periods, will cover at least a thousand years. Perhaps the most surprising result of the excavations in Crete is the discovery that Minoan art is on a higher level than Mycenaean art. To the scholars of a generation ago it seemed a thing incredible that the art of the shaft-graves, and the architecture of the beehive-tombs and the palaces, could belong to the age before the Dorian invasion. The most recent discoveries seem to indicate that the art of Mycenæ is a decadent art; they certainly prove that an art, hardly inferior in its way to the art of the classical period, and a civilization which implies the command of great material resources, were flourishing in the Aegean perhaps a thousand years before the siege of Troy.

To the question, "What is the origin of this civilization? Is it of foreign derivation or of native growth?" it is not possible to give a direct answer. It is clear, on the one hand that it was developed, by a gradual process of differentiation, from a culture which was common to the whole Aegean basin and extended as far to the west as Sicily. It is equally clear, on the other hand, that foreign influences contributed largely to the process of development. Egyptian influences, in particular, can be traced throughout the "Minoan" and "Mycenaean" periods. The developed art, however, both in Crete and on the mainland, displays characteristics which are the very opposite of those which are commonly associated with the term "oriental." Egyptian work, even of the best period, is stiff and conventional; in the best Cretan work, and, in a less degree, in Mycenaean work, we find an originality and a freedom of treatment which remind one of the spirit of the Greek artists. The civilization is, in many respects, of an advanced type. The Cretan architects could design on a grand scale, and could carry out their designs with no small degree of mechanical skill. At Cnossus we find a system of drainage in use, which is far in advance of anything known in the modern world before the 19th century. If the art of the Minoan age falls short of the art of the Periclean age, it is hardly inferior to that of the age of Pheidias. It is a civilization, too, which has long been familiar with the art of writing. But it is one that belongs entirely to the Bronze Age. Iron is not found until the very end of the Mycenaean period, and then only in small quantities. Nor is this the only point of contrast between the culture of the earliest age and that of the historical period in Greece. The chief seats of the early culture are to be found either in the island of Crete, or, on the mainland, at Tiryns and Mycenæ. In the later history Crete plays no part, and Tiryns and Mycenæ are obscure. With the great names of a later age, Argos, Sparta, Athens, no great discoveries are connected. In northern Greece, Orchomenos rather than Thebes is the centre of influence. Further points of contrast readily

*Oriental
influ-
ence.*

suggest themselves. The so-called Phœnician alphabet, in use amongst the later Greeks, is unknown in the earliest age. Its systems of writing, both the earlier and the later one, are syllabic in character, and analogous to those in vogue in Asia Minor and Cyprus. In the art of war, the chariot is of more importance than the foot-soldier, and the latter, unlike the Greek hoplite, is lightly clad, and trusts to a shield large enough to cover the whole body, rather than to the metal helmet, breast-plate and greaves of later times (see *ARMS AND ARMOUR: Greek*). The political system appears to have been a despotic monarchy, and the realm of the monarch to have extended to far wider limits than those of the "city-states" of historical Greece. It is, perhaps, in the religious practices of the age, and in the ideas implied in them, that the contrast is most apparent. Neither in Crete nor on the mainland is there any trace of the worship of the "Olympian" deities. The cults in vogue remind us rather of Asia than of Greece. The worship of pillars and of trees carries us back to Canaan, while the double-headed axe, so prominent in the ritual of Cnossus, survives in later times as the symbol of the national deity of the Carians. The beehive-tombs, found on many sites on the mainland besides Mycenæ, are evidence both of a method of sepulture and of ideas of the future state, which are alien to the practice and the thought of the Greeks of history. It is only in one region—in the island of Cyprus—that the culture of the Mycenaean age is found surviving into the historical period. As late as the beginning of the 5th century B.C. Cyprus is still ruled by kings, the alphabet has not yet displaced a syllabary, the characteristic forms of Mycenaean vases still linger on, and the chief deity of the island is the goddess with attendant doves whose images are among the common objects of Mycenaean finds.

3. *The Homeric Age.*—Alike in Crete and on the mainland the civilization disclosed by excavation comes abruptly to an end. In Crete we can trace it back from c. 1200 A.C. to the Neolithic period. From the Stone Age to the end of the Minoan Age the development is continuous and uninterrupted.¹ But between the culture of the Early Age and the culture of the Dorians, who occupied the island in historical times, no connexion whatever can be established. Between the two there is a great gulf fixed. It would be difficult to imagine a greater contrast than that presented by the rude life of the Dorian communities in Crete when it is compared with the political power, the material resources and the extensive commerce of the earlier period. The same gap between the archaeological age and the historical exists on the mainland also. It is true that the solution of continuity is here less complete. Mycenaean art continues, here and there, in a debased form down to the 9th century, a date to which we can trace back the beginnings of the later Greek art. On one or two lines (e.g. architecture) it is even possible to establish some sort of connexion between them. But Greek art as a whole cannot be evolved from Mycenaean art. We cannot bridge over the interval that separates the latter art, even in its decline, from the former. It is sufficient to compare the "dipylon" ware (with which the process of development begins, which culminates in the pottery of the Great Age) with the Mycenaean vases, to satisfy oneself that the gulf exists. What then is the relation of the Heroic or Homeric Age (i.e. the age whose life is portrayed for us in the poems of Homer) to the Earliest Age? It too presents many contrasts to the later periods. On the other hand, it presents contrasts to the Minoan Age, which, in their way, are not less striking. Is it then to be identified with the Mycenaean Age? Schliemann, the discoverer of the Mycenaean culture, unhesitatingly identified Mycenaean with Homeric. He even identified the shaft-graves of Mycenæ with the tombs of Agamemnon and Clytemnestra. Later inquirers, while refusing to discover so literal a correspondence between things Homeric and things Mycenaean, have not hesitated to accept a general correspondence between the Homeric Age and the Mycenaean. Where it is a case of

comparing literary evidence with archaeological, an exact coincidence is not of course to be demanded. The most that can be asked is that a general correspondence should be established. It may be conceded that the case for such a correspondence appears *prima facie* a strong one. There is much in Homer that seems to find confirmation or explanation in Schliemann's finds. Mycenæ is Agamemnon's city; the plan of the Homeric house agrees fairly well with the palaces at Tiryns and Mycenæ; the forms and the technique of Mycenaean art serve to illustrate passages in the poems; such are only a few of the arguments that have been urged. It is the great merit of Professor Ridgeway's work (*The Early Age of Greece*) that it has demonstrated, once and for all, that Mycenaean is not Homeric pure and simple. He insists upon differences as great as the resemblances. Iron is in common use in Homer; it is practically unknown to the Mycenaean. In place of the round shield and the metal armour of the Homeric soldier, we find at Mycenæ that the warrior is lightly clad in linen, and that he fights behind an oblong shield, which covers the whole body; nor are the chariots the same in form. The Homeric dead are cremated; the Mycenaean are buried. The gods of Homer are the deities of Olympus, of whose cult no traces are to be found in the Mycenaean Age. The novelty of Professor Ridgeway's theory is that for the accepted equation, Homeric = Achæan = Mycenaean, he proposes to substitute the equations, Homeric = Achæan = post-Mycenaean, and Mycenaean = pre-Achæan = Pelasgian. The Mycenaean civilization he attributes to the Pelasgians, whom he regards as the indigenous population of Greece, the ancestors of the later Greeks, and themselves Greek both in speech and blood. The Homeric heroes are Achæans, a fair-haired Celtic race, whose home was in the Danube valley, where they had learned the use of iron. In Greece they are newcomers, a conquering class comparable to the Norman invaders of England or Ireland, and like them they have acquired the language of their subjects in the course of a few generations. The Homeric civilization is thus Achæan, i.e. it is Pelasgian (Mycenaean) civilization, appropriated by a ruder race; but the Homeric culture is far inferior to the Mycenaean. Here, at any rate, the Norman analogy breaks down. Norman art in England is far in advance of Saxon. Even in Normandy (as in Sicily), where the Norman appropriated rather than introduced, he not only assimilated but developed. In Greece the process must have been reversed.

The theory thus outlined is probably stronger on its destructive side than on its constructive. To treat the Achæans as an immigrant race is to run counter to the tradition of the Greeks themselves, by whom the Achæans were regarded as indigenous (cf. Herod. viii. 73). Nor is the Pelasgian part of the theory easy to reconcile with the Homeric evidence. If the Achæans were a conquering class ruling over a Pelasgian population, we should expect to find this difference of race a prominent feature in Homeric society. We should, at least, expect to find a Pelasgian background to the Homeric picture. As a matter of fact, we find nothing of the sort. There is no consciousness in the Homeric poems of a distinction of race between the governing and the subject classes. There are, indeed, Pelasgians in Homer, but the references either to the people or the name are extraordinarily few. They appear as a people, presumably in Asia Minor, in alliance with the Trojans; they appear also, in a single passage, as one of the tribes inhabiting Crete. The name survives in "Pelasgion Argos," which is probably to be identified with the valley of the Spercheius,² and as an epithet of Zeus of Dodona. The population, however, of Pelasgion Argos and of Dodona is no longer Pelasgian. Thus, in the age of Homer, the Pelasgians belong, so far as Greece proper is concerned, to a past that is already remote. It is inadmissible to appeal to Herodotus against Homer. For the conditions of the Homeric age Homer is the sole authoritative witness. If, however, Professor Ridgeway has failed to prove that "Mycenaean" equals "Pelasgian" he has certainly proved that much that is Homeric is post-Mycenaean. It is possible

¹ It would be more accurate to say to the year 1500 B.C. At Cnossus the palace is sacked soon after this date, and the art, both in Crete and in the whole Aegean area, becomes lifeless and decadent.

² See T. W. Allen in the *Classical Review*, vol. xx. (1906), No. 4 (May).

that different strata are to be distinguished in the Homeric poems. There are passages which seem to assume the conditions of the Mycenaean age; there are others which presuppose the conditions of a later age. It may be that the latter passages reflect the circumstances of the poet's own times, while the former ones reproduce those of an earlier period. If so, the substitution of iron for bronze must have been effected in the interval between the earlier and the later periods.

It has already been pointed out that the question whether the makers of the Minoan and Mycenaean civilizations were Greeks must still be regarded as an open one. No such question can be raised as to the Homeric Age. The Achaeans may or may not have been Greek in blood. What is certain is that the Achaean Age

forms an integral part of Greek history. Alike on the linguistic, the religious and the political sides, Homer is the starting-point of subsequent developments. In the Greek dialects the great distinction is that between the Doric and the rest. Of the non-Doric dialects the two main groups are the Aeolic and Ionic, both of which have been developed, by a gradual process of differentiation, from the language of the Homeric poems. With regard to religion it is sufficient to refer to the judgment of Herodotus, that it was Homer and Hesiod who were the authors of the Greek theogony (ii. 53 *οὐδὲν εἰς αὐτὸν ποιεῖσθαι θεογονίαν Ἑλλήνων*). It is a commonplace that Homer was the Bible of the Greeks. On the political side, Greek constitutional development would be unintelligible without Homer. When Greek history, in the proper sense, begins, oligarchy is almost universal. Everywhere, however, an antecedent stage of monarchy has to be presupposed. In the Homeric system monarchy is the sole form of government; but it is monarchy already well on the way to being transformed into oligarchy. In the person of the king are united the functions of priest, of judge and of leader in war. He belongs to a family which claims divine descent and his office is hereditary. He is, however, no despotic monarch. He is compelled by custom to consult the council (*boule*) of the elders, or chiefs. He must ask their opinion, and, if he fails to obtain their consent, he has no power to enforce his will. Even when he has obtained the consent of the council, the proposal still awaits the approval of the assembly (*agora*), of the people.

Thus in the Homeric state we find the germs not only of the oligarchy and democracy of later Greece, but also of all the various forms of constitution known to the Western world. And a monarchy such as is depicted in the Homeric poems is clearly ripe for transmutation into oligarchy. The chiefs are addressed as kings (*βασιλῆες*), and claim, equally with the monarch, descent from the gods. In Homer, again, we can trace the later organization into tribe (*φύλη*), clan (*γῆνος*), and phratry, which is characteristic of Greek society in the historical period, and meets us in analogous forms in other Aryan societies. The *γῆνος* corresponds to the Roman *gens*, the *φύλη* to the Roman tribe, and the phratry to the *curia*. The importance of the *phratry* in Homeric society is illustrated by the well-known passage (*Iliad* ix. 63) in which the outcast is described as "one who belongs to no phratry" (*ἀφφράτριος*). It is a society that is, of course, based upon slavery, but it is slavery in its least repulsive aspect. The treatment which Eumaeus and Eurycleia receive at the hands of the poet of the *Odyssey* is highly creditable to the humanity of the age. A society which regarded the slave as a mere chattel would have been impatient of the interest shown in a swineherd and a nurse. It is a society, too, that exhibits many of the distinguishing traits of later Greek life. Feasting and quarrels, it is true, are of more moment to the heroes than to the contemporaries of Pericles or Plato; but "music" and "gymnastic" (though the terms must be understood in a more restricted sense) are as distinctive of the age of Homer as of that of Pindar. In one respect there is retrogression in the historical period. Woman in Homeric society enjoys a greater freedom, and receives greater respect, than in the Athens of Sophocles and Pericles.

4. *The Growth of the Greek States.*—The Greek world at the

beginning of the 6th century B.C. presents a picture in many respects different from that of the Homeric Age. The Greek race is no longer confined to the Greek peninsula. It occupies the islands of the Aegean, the western seaboard of Asia Minor, the coasts of Macedonia and Thrace, of southern Italy and Sicily. Scattered settlements are found as far apart as the mouth of the Rhone, the north of Africa, the Crimea and the eastern end of the Black Sea. The Greeks are called by a national name, *Hellenes*, the symbol of a fully-developed national self-consciousness. They are divided into three great branches, the Dorian, the Ionian and the Aeolian, names almost, or entirely, unknown to Homer. The heroic monarchy has nearly everywhere disappeared. In Greece proper, south of Thermopylae, it survives, but in a peculiar form, in the Spartan state alone. What is the significance and the explanation of contrasts so profound?

It is probable that the explanation is to be found, directly or indirectly, in a single cause, the Dorian invasion. In Homer the Dorians are mentioned in one passage only (*Odyssey* xix. 177). They there appear as one of the races which inhabit Crete. In the historical period the whole Peloponnese, with the exception of Arcadia, Elis and Achaea, is Dorian. In northern Greece the Dorians occupy the little state of Doris, and in the Aegean they form the population of Crete, Rhodes and some smaller islands. Thus the chief centres of Minoan and Mycenaean culture have passed into Dorian hands, and the chief seats of Achaean power are included in Dorian states. Greek tradition explained the overthrow of the Achaean system by an invasion of the Peloponnese by the Dorians, a northern tribe, which had found a temporary home in Doris. The story ran that, after an unsuccessful attempt to force an entrance by the Isthmus of Corinth, they had crossed from Naupactus, at the mouth of the Corinthian Gulf, landed on the opposite shore, and made their way into the heart of the Peloponnese, where a single victory gave them possession of the Achaean states. Their conquests were divided among the invaders into three shares, for which lots were cast, and thus the three states of Argos, Sparta and Messenia were created. There is much in this tradition that is impossible or improbable. It is impossible, e.g. for the tiny state of Doris, with its three or four "small, sad villages" (*σάλλες μικραὶ καὶ λυπηρόχωροι*, Strabo, p. 427), to have furnished a force of invaders sufficient to conquer and re-people the greater part of the Peloponnese. It is improbable that the conquest should have been either as sudden, or as complete, as the legend represents. On the contrary, there are indications that the conquest was gradual, and that the displacement of the older population was incomplete. The improbability of the details affords, however, no ground for questioning the reality of the invasion.¹ The tradition can be traced back at Sparta to the 7th century B.C. (Tyrtaeus, quoted by Strabo, p. 362), and there is abundant evidence, other than that of legend, to corroborate it. There is the Dorian name, to begin with. If, as Beloch supposes, it originated on the coast of Asia Minor, where it served to distinguish the settlers in Rhodes and the neighbouring islands from the Ionians and Aeolians to the north of them, how came the great and famous states of the Peloponnese to adopt a name in use among the petty colonies planted by their kinsmen across the sea? Or, if Dorian is simply Old Peloponnesian, how are we to account for the Doric dialect or the Dorian pride of race?

It is true that there are great differences between the literary Doric, the dialect of Corinth and Argos, and the dialects of Laconia and Crete, and that there are affinities between the dialect of Laconia and the non-Dorian dialects of Arcadia and Elis. It is equally true, however, and of far more consequence, that all the Doric dialects are distinguished from all other Greek dialects by certain common characteristics. Perhaps the strongest sentiment in the Dorian nature is the pride of race. Indeed, it looks as if the Dorians claimed to be the sole genuine Hellenes. How can we account for an indigenous population, first imagining itself to be immigrant, and then developing a

¹ It has been impugned by J. Beloch, *Griechische Geschichte*, i. 149 ff.

themselves were in some cases on a similar level of culture. Where the natives were still backward or barbarous, they came of a stock either closely related to the Greek, or at least separated from it by no great physical differences. We need only contrast the Carian, the Sicel, the Thracian or even the Scythian, with the native Australian, the Hottentot, the Red Indian or the Maori, to apprehend the advantage of the Greek. Amalgamation with the native races was easy, and it involved neither physical nor intellectual degeneracy as its consequence. Of the races with which the Greeks came in contact the Thracian was far from the highest in the scale of culture; yet three of the greatest names in the Great Age of Athens are those of men who had Thracian blood in their veins, viz. Themistocles, Cimon and the historian Thucydides. In the absence of any distinction of colour, no insuperable barrier existed between the Greek and the hellenized native. The *demoi* of the colonial cities were largely recruited from the native population,¹ nor was there anything in the Greek world analogous to the "mean whites" or the "black belt." Of hardly less importance were the climatic conditions. In this respect the Mediterranean area is unique. There is no other region of the world of equal extent in which these conditions are at once so uniform and so favourable. Nowhere had the Greek settler to encounter a climate which was either unsuited to his labour or subversive of his vigour. That in spite of these advantages so little, comparatively speaking, was effected in the work of Hellenization before the epoch of Alexander and the Diadochi, was the effect of a single counteracting cause. The Greek colonist, like the Greek trader, clung to the shore. He penetrated no farther inland than the sea-breeze. Hence it was only in islands, such as Sicily or Cyprus, that the process of Hellenization was complete. Elsewhere the Greek settlements formed a mere fringe along the coast.

To the 7th century there belongs another movement of high importance in its bearing upon the economic, religious and literary development of Greece, as well as upon its constitutional history. This movement is the rise of the *tyrannis*. In the political writers of a later age the word possesses a clear-cut connotation. From other forms of monarchy it is distinguished by a twofold differentiation. The *tyrannus* is an unconstitutional ruler, and his authority is exercised over unwilling subjects. In the 7th and 6th centuries the line was not drawn so distinctly between the tyrant and the legitimate monarch. Even Herodotus uses the words "tyrant" and "king" interchangeably (e.g. the princes of Cyprus are called "kings" in v. 110 and "tyrants" in v. 109), so that it is sometimes difficult to decide whether a legitimate monarch or a tyrant is meant (e.g. Aristophiles of Tarentum, lli. 136, or Telys of Sybaris, v. 44). But the distinction between the tyrant and the king of the Heroic Age is a valid one. It is not true that his rule was always exercised over unwilling subjects; it is true that his position was always unconstitutional. The Homeric king is a legitimate monarch; his authority is invested with the sanctions of religion and immemorial custom. The tyrant is an illegitimate ruler; his authority is not recognized, either by customary usage or by express enactment. But the word "tyrant" was originally a neutral term; it did not necessarily imply a misuse of power. The origin of the *tyrannis* is obscure. The word *tyrannus* has been thought, with some reason, to be a Lydian one. Probably both the name and the thing originated in the Greek colonies of Asia Minor, though the earliest tyrants of whom we hear in Asia Minor (at Ephesus and Miletus) are a generation later than the earliest in Greece itself, where, both at Sicily and at Corinth, tyranny appears to date back to the second quarter of the 7th century. It is not unusual to regard tyranny as a universal stage in the constitutional development of the Greek states, and as a stage that occurs everywhere at one and the same period. In reality, tyranny is confined to certain regions, and it is a phenomenon that is peculiar to no one age or century. In Greece proper, before the

¹ At Syracuse the *demoi* makes common cause with the Sicel serf-population against the nobles (Herod. vii. 155).

4th century B.C., it is confined to a small group of states round the Corinthian and Saronic Gulfs. The greater part of the Peloponnese was exempt from it, and there is no good evidence for its existence north of the Isthmus, except at Megara and Athens. It plays no part in the history of the Greek cities in Chalcidice and Thrace. It appears to have been rare in the Cyclades. The regions in which it finds a congenial soil are two, Asia Minor and Sicily. Thus it is incorrect to say that most Greek states passed through this stage. It is still wider of the mark to assume that they passed through it at the same time. There is no "Age of the Tyrants." Tyranny began in the Peloponnese a hundred years before it appears in Sicily, and it has disappeared in the Peloponnese almost before it begins in Sicily. In the latter the great age of tyranny comes at the beginning of the 5th century; in the former it is at the end of the 7th and the beginning of the 6th. At Athens the history of tyranny begins after it has ended both at Sicily and Corinth. There is, indeed, a period in which tyranny is non-existent in the Greek states; roughly speaking, the last sixty years of the 5th century. But with this exception, there is no period in which the tyrant is not to be found. The greatest of all the tyrannies, that of Dionysius at Syracuse, belongs to the 4th century. Nor must it be assumed that tyranny always comes at the same stage in the history of a constitution; that it is always a stage between oligarchy and democracy. At Corinth it is followed, not by democracy but by oligarchy, and it is an oligarchy that lasts, with a brief interruption, for two hundred and fifty years. At Athens it is not immediately preceded by oligarchy. Between the Eupatrid oligarchy and the rule of Peisistratus there comes the timocracy of Solon. These exceptions do not stand alone. The cause of tyranny is, in one sense, uniform. In the earlier centuries, at any rate, tyranny is always the expression of discontent; the tyrant is always the champion of a cause. But it would be a mistake to suppose that the discontent is necessarily political, or that the cause which he champions is always a constitutional one. At Sicily it is a racial one; Cleisthenes is the champion of the older population against their Dorian oppressors (see Herod. v. 67, 68). At Athens the discontent is economic rather than political; Peisistratus is the champion of the Diacrii, the inhabitants of the poorest region of Attica. The party-strifes of which we hear in the early history of Miletus, which doubtless gave the tyrant his opportunity, are concerned with the claims of rival industrial classes. In Sicily the tyrant is the ally of the rich and the foe of the *demoi*, and the cause which he champions, both in the 5th century and the 4th, is a national one, that of the Greek against the Carthaginian. We may suspect that in Greece itself the tyrannies of the 7th century are the expression of an anti-Dorian reaction. It can hardly be an accident that the states in which the *tyrannis* is found at this epoch, Corinth, Megara, Sicily, Epidaurus, are all of them states in which a Dorian upper class ruled over a subject population. In Asia Minor the *tyrannis* assumes a peculiar character after the Persian conquest. The tyrant rules as the deputy of the Persian satrap. Thus in the East the tyrant is the enemy of the national cause; in the West, in Sicily, he is its champion.

Tyranny is not a phenomenon peculiar to Greek history. It is possible to find analogies to it in Roman history, in the power of Caesar, or of the Caesars; in the despotisms of medieval Italy; or even in the Napoleonic empire. Between the tyrant and the Italian despot there is indeed a real analogy; but between the Roman principate and the Greek *tyrannis* there are two essential differences. In the first place, the principate was expressed in constitutional forms, or veiled under constitutional fictions; the tyrant stood altogether outside the constitution. And, secondly, at Rome both Julius and Augustus owed their position to the power of the sword. The power of the sword, it is true, plays a large part in the history of the later tyrants (e.g. Dionysius of Syracuse); the earlier ones, however, had no mercenary armies at their command. We can hardly compare the bodyguard of Peisistratus to the legions of the first or the second Caesar.

The view taken of the *tyrannis* in Greek literature is almost uniformly unfavourable. In this respect there is no difference between Plato and Aristotle, or between Herodotus and the later historians.¹ His policy is represented as purely selfish, and his rule as oppressive. Herodotus is influenced partly by the traditions current among the oligarchs, who had been the chief sufferers, and partly by the odious associations which had gathered round tyranny in Asia Minor. The philosophers write under their impressions of the later *tyrannis*, and their account is largely an a priori one. It is seldom that we find any attempt, either in the philosophers or the historians, to do justice to the real services rendered by the tyrants.² Their first service was a constitutional one. They helped to break down the power of the old aristocratic houses, and thus to create the social and political conditions indispensable to democracy. The *tyrannis* involved the sacrifice of liberty in the cause of equality. When tyranny falls, it is never succeeded by the aristocracies which it had overthrown. It is frequently succeeded by an oligarchy, but it is an oligarchy in which the claim to exclusive power is based, not upon mere birth, but upon wealth, or the possession of land. It would be unfair to treat this service as one that was rendered unconsciously and unwillingly. Where the tyrant asserted the claims of an oppressed class, he consciously aimed at the destruction of privilege and the effacement of class distinctions. Hence it is unjust to treat his power as resting upon mere force. A government which can last eighty or a hundred years, as was the case with the tyrannies at Corinth and Sicyon, must have a moral force behind it. It must rest upon the consent of its subjects. The second service which the tyrants rendered to Greece was a political one. Their policy tended to break down the barriers which isolated each petty state from its neighbours. In their history we can trace a system of widespread alliances, which are often cemented by matrimonial connexions. The Cypselid tyrants of Corinth appear to have been allied with the royal families of Egypt, Lydia and Phrygia, as well as with the tyrants of Miletus and Epidaurus, and with some of the great Athenian families. In Sicily we find a league of the northern tyrants opposed to a league of the southern; and in each case there is a corresponding matrimonial alliance. Anaxilaus of Rhegium is the son-in-law and ally of Terillus of Himera; Gelo of Syracuse stands in the same relation to Theron of Agrigintum. Royal marriages have played a great part in the politics of Europe. In the comparison of Greek and modern history it has been too often forgotten how great a difference it makes, and how great a disadvantage it involves, to a republic that it has neither sons nor daughters to give in marriage. In commerce and colonization the tyrants were only continuing the work of the oligarchies to which they succeeded. Greek trade owed its expansion to the intelligent efforts of the oligarchs who ruled at Miletus and Corinth, in Samos, Aegina and Euboea; but in particular cases, such as Miletus, Corinth, Sicyon and Athens, there was a further development, and a still more rapid growth, under the tyrants. In the same way, the foundation of the colonies was in most cases due to the policy of the oligarchical governments. They can claim credit for the colonies of Chalcis and Eretria, of Megara, Phocaea and Samos, as well as for the great Achaean settlements in southern Italy. The Cypselids at Corinth, and Thrasybulus at Miletus, are instances of tyrants who colonized on a great scale.

In their religious policy the tyrants went far to democratize Greek religion. The functions of monarchy had been largely religious; but, while the king was necessarily a priest, he was not the only priest in the community. There were special priesthoods, hereditary in particular families, even in the monarchical period; and upon the fall of the monarchy, while the priestly functions of the kings passed to republican magistrates, the priesthoods which were in the exclusive possession of the great families tended to become the important ones. Thus, before the rise of tyranny, Greek religion is aristocratic. The cults recognized

¹ An exception should perhaps be made in the case of Thucydides.

² The Peisistratidae come off better, however

by the state are the *sacra* of noble clans. The religious prerogatives of the nobles helped to confirm their political ones, and, as long as religion retained its aristocratic character, it was impossible for democracy to take root. The policy of the tyrants aimed at fostering popular cults which had no associations with the old families, and at establishing new festivals. The cult of the wine-god, Dionysus, was thus fostered at Sicyon by Cleisthenes, and at Corinth by the Cypselids; while at Athens a new festival of this deity, which so completely overshadowed the older festival that it became known as the Great Dionysia, probably owed its institution to Peisistratus. Another festival, the Panathenaea, which had been instituted only a few years before his rise to power, became under his rule, and thanks to his policy, the chief national festival of the Athenian state. Everywhere, again, we find the tyrants the patrons of literature. Pindar and Bacchylides, Aeschylus and Simonides found a welcome at the court of Hiero. Polycrates was the patron of Anacreon, Periander of Arion. To Peisistratus has been attributed, possibly not without reason, the first critical edition of the text of Homer, a work as important in the literary history of Greece as was the issue of the Authorized Version of the Bible in English history. It would judge fairly of tyranny, and of what it contributed to the development of Greece, we must remember how many states there were in whose history the period of greatest power coincides with the rule of a tyrant. This is unquestionably true of Corinth and Sicyon, as well as of Syracuse in the 5th, and again in the 4th century; it is probably true of Samos and Miletus. In the case of Athens it is only the splendour of the Great Age that blinds us to the greatness of the results achieved by the policy of the Peisistratids.

With the overthrow of this dynasty tyranny disappears from Greece proper for more than a century. During the century and a half which had elapsed since its first appearance the whole aspect of Greek life, and of the Greek world, had changed. The development was as yet incomplete, but the lines on which it was to proceed had been clearly marked out. Political power was no longer the monopoly of a class. The struggle between the "few" and the "many" had begun; in one state at least (Athens) the victory of the "many" was assured. The first chapter in the history of democracy was already written. In the art of war the two innovations which were ultimately to establish the military supremacy of Greece, hoplite tactics and the trireme, had already been introduced. Greek literature was no longer synonymous with epic poetry. Some of its most distinctive forms had not yet been evolved;

The arts.

indeed, it is only quite at the end of the period that prose-writing begins; but both lyric and elegiac poetry had been brought to perfection. In art, statuary was still comparatively stiff and crude; but in other branches, in architecture, in vase-painting and in coin-types, the aesthetic genius of the race had asserted its pre-eminence. Philosophy, the supreme gift of Greece to the modern world, had become a living power. Some of her most original thinkers belong to the 6th century. Criticism had been applied to everything in turn: to the gods, to conduct, and to the conception of the universe. Before the Great Age begins, the claims of intellectual as well as of political freedom had been vindicated. It was not, however, in Greece proper that progress had been greatest. In the next century the centre of gravity of Greek civilization shifts to the western side of the Aegean; in the 6th century it must be looked for at Miletus, rather than at Athens. In order to estimate how far the development of Greece had advanced, or to appreciate the distinctive features of Greek life at this period, we must study Ionia, rather than Attica or the Peloponnese. Almost all that is greatest and most characteristic is to be found on the eastern side of the Aegean. The great names in the history of science and philosophy before the beginning of the 5th century—Thales, Pythagoras, Xenophanes, Heraclitus, Parmenides, Anaximander, Hecataeus; names which are representative of mathematics, astronomy, geography and metaphysics, are all, without exception, Ionian. In poetry, too, the most famous names, if not so exclusively Ionian, are connected either with the Asiatic coast or with

the Cyclades. Against Archilochus and Anacreon, Sappho and Alcaeus, Greece has nothing better to set, after the age of Hesiod, than Tyrtaeus and Theognis. Reference has already been made to the greatness of the Ionians as navigators, as colonizers and as traders. In wealth and in population, Miletus, at the epoch of the Persian conquest, must have been far ahead of any city of European Greece. Sybaris, in Magna Graecia, can have been its only rival outside Ionia. There were two respects, however, in which the comparison was in favour of the mother-country. In warfare, the superiority of the Spartan infantry was unquestioned; in politics, the Greek states showed a greater power of combination than the Ionian.

Finally, Ionia was the scene of the first conflicts with the Persian. Here were decided the first stages of a struggle which

External relations.

was to determine the place of Greece in the history of the world. The rise of Persia under Cyrus was, as Herodotus saw, the turning-point of Greek history. Hitherto the Greek had proved himself indispensable to the oriental monarchies with which he had been brought into contact. In Egypt the power of the Saitic kings rested upon the support of their Greek mercenaries. Amasis (569-525 B.C.), who is raised to the throne as the leader of a reaction against the influence of the foreign garrison, ends by showing greater favour to the Greek soldiery and the Greek traders than all that were before him. With Lydia the relations were originally hostile; the conquest of the Greek fringe is the constant aim of Lydian policy. Greek influences, however, seem to have quickly permeated Lydia, and to have penetrated to the court. Alyattes (610-560 B.C.) marries an Ionian wife, and the succession is disputed between the son of this marriage and Croesus, whose mother was a Carian. Croesus (560-546 B.C.) secures the throne, only to become the lavish patron of Greek sanctuaries and the ally of a Greek state. The history of Hellenism had begun. It was the rise of Cyrus that closed the East to Greek enterprise and Greek influences. In Persia we find the antithesis of all that is characteristic of Greece—autocracy as opposed to liberty; a military society organized on an aristocratic basis, to an industrial society, animated by a democratic spirit; an army, whose strength lay in its cavalry, to an army, in which the foot-soldier alone counted; a morality, which assigned the chief place to veracity, to a morality which subordinated it to other virtues; a religion, which ranks among the great religions of the world, to a religion, which appeared to the most spiritual minds among the Greeks themselves both immoral and absurd. Between two such races there could be neither sympathy nor mutual understanding. In the Great Age the Greek had learned to despise the Persian, and the Persian to fear the Greek.

Persian wars.

In the 6th century it was the Persian who despised, and the Greek who feared. The history of the conflicts between the Ionian Greeks and the Persian empire affords a striking example of the combination of intellectual strength and political weakness in the character of a people. The causes of the failure of the Ionians to offer a successful resistance to Persia, both at the time of the conquest by Harpagus (546-545 B.C.) and in the Ionic revolt (499-494 B.C.), are not far to seek. The centrifugal forces always tended to prove the stronger in the Greek system, and nowhere were they stronger than in Ionia. The tie of their tribal union proved weaker, every time it was put to the test, than the political and commercial interests of the individual states. A league of jealous commercial rivals is certain not to stand the strain of a protracted struggle against great odds. Against the advancing power of Lydia a common resistance had not so much as been attempted. Miletus, the greatest of the Ionian towns, had received aid from Chios alone. Against Persia a common resistance was attempted. The Panionium, the centre of a religious amphictyony, became for the moment the centre of a political league. At the time of the Persian conquest Miletus held aloof. She secured favourable terms for herself, and left the rest of Ionia to its fate. In the later conflict, on the contrary, Miletus is the leader in the revolt. The issue was determined, not as Herodotus represents it, by the inherent indolence of the Ionian nature, but by the selfish

policy of the leading states. In the sea-fight at Lade (494 B.C.) the decisive battle of the war, the Milesians and Chians fought with desperate courage. The day was lost thanks to the treachery of the Samian and Lesbian contingents.

The causes of the successful resistance of the Greeks to the invasions of their country, first by Datis and Artaphernes (490 B.C.), in the reign of Darius, and then by Xerxes in person (480-479 B.C.), are more complex. Their success was partly due to a moral cause. And this was realized by the Greeks themselves. They felt (see Herod. vii. 104) that the subjects of a despot are no match for the citizens of a free state, who yield obedience to a law which is self-imposed. But the cause was not solely a moral one. Nor was the result due to the numbers and efficiency of the Athenian fleet, in the degree that the Athenians claimed (see Herod. vii. 139). The truth is that the conditions, both political and military, were far more favourable to the Greek defence in Europe than they had been in Asia. At this crisis the centripetal forces proved stronger than the centrifugal. The moral ascendancy of Sparta was the determining factor. In Sparta the Greeks had a leader whom all were ready to obey (Herod. viii. 2). But for her influence the forces of disintegration would have made themselves felt as quickly as in Ionia. Sparta was confronted with immense difficulties in conducting the defence against Xerxes. The two chief naval powers, Athens and Aegina, had to be reconciled after a long and exasperating warfare (see ARGINA). After Thermopylae, the whole of northern Greece, with the exception of Athens and a few minor states, was lost to the Greek cause. The supposed interests of the Peloponnesians, who formed the greater part of the national forces, conflicted with the supposed interests of the Athenians. A more impartial view than was possible to the generation for which Herodotus wrote suggests that Sparta performed her task with intelligence and patriotism. The claims of Athens and Sparta were about equally balanced. And in spite of her great superiority in numbers,¹ the military conditions were far from favourable to Persia. A land so mountainous as Greece is was unsuited to the operations of cavalry, the most efficient arm of the service in the Persian Army, as in most oriental ones. Ignorance of local conditions, combined with the dangerous nature of the Greek coast, exposed their ships to the risk of destruction; while the composite character of the fleet, and the jealousies of its various contingents, tended to neutralize the advantage of numbers. In courage and discipline, the flower of the Persian infantry was probably little inferior to the Greek; in equipment, they were no match for the Greek panoply. Lastly, Xerxes laboured under a disadvantage, which may be illustrated by the experience of the British army in the South African War—distance from his base.

5. *The Great Age (480-338 B.C.).*—The effects of the repulse of Persia were momentous in their influence upon Greece. The effects upon Elizabethan England of the defeat of the Spanish armada would afford quite an inadequate parallel. It gave the Greeks a heightened sense, both of their own national unity and of their superiority to the barbarian, while at the same time it helped to create the material conditions requisite alike for the artistic and political development of the 5th century. Other cities besides Athens were adorned with the proceeds of the spoils won from Persia, and Greek trade benefited both from the reunion of Ionia with Greece, and from the suppression of piracy in the Aegean and the Hellespont. Do these developments justify us in giving to the period, which begins with the repulse of Xerxes, and ends with the victory of Philip, the title of "the Great Age"? If the title is justified in the case of the 5th century, should the 4th century be excluded from the period? At first sight, the difference between the 4th century and the 5th may seem greater than that which exists between the 5th and the 6th. On the political side, the 5th century is an age of growth, the 4th an age of decay; on the literary side, the

¹ The numbers given by Herodotus (upwards of 5,000,000) are enormously exaggerated. We must divide by ten or fifteen to arrive at a probable estimate of the forces that actually crossed the Hellespont.

former is an age of poetry, the latter an age of prose. In spite of these contrasts, there is a real unity in the period which begins with the repulse of Xerxes and ends with the death of Alexander, as compared with any preceding one. It is an age of maturity in politics, in literature, and in art; and this is true of no earlier age. Nor can we say that the 5th century is, in all these aspects of Greek life, immature as compared with the 4th, or, on the other hand, that the 4th is decadent as compared with the 5th. On the political side, maturity is, in one sense, reached in the earlier century. There is nothing in the later century so great as the Athenian empire. In another sense, maturity is not reached till the 4th century. It is only in the later century that the tendency of the Greek constitutions to conform to a common type, democracy, is (at least approximately) realized, and it is only in this century that the principles upon which democracy is based are carried to their logical conclusion. In literature, if we confine our attention to poetry, we must pronounce the 5th century the age of completed development; but in prose the case is different. The style even of Thucydides is immature, as compared with that of Isocrates and Plato. In philosophy, however high may be the estimate that is formed of the genius of the earlier thinkers, it cannot be disputed that in Plato and Aristotle we find a more mature stage of thought. In art, architecture may perhaps be said to reach its zenith in the 5th, sculpture in the 4th century. In its political aspect, the history of the Great Age resolves itself into the history of two movements, the imperial and the democratic. Hitherto Greece had meant, politically, an aggregate of independent states, very numerous, and, as a rule, very small. The principle of autonomy was to the Greek the most sacred of all political principles; the passion for autonomy the most potent of political factors. In the latter half of the 6th century Sparta had succeeded in combining the majority of the Peloponnesian states into a loose federal union; so loose, however, that it appears to have been dormant in the intervals of peace. In the crisis of the Persian invasion the Peloponnesian League was extended so as to include all the states which had espoused the national cause. It looked on the morrow of Plataea and Mycale (the two victories, won simultaneously, in 479 B.C., by Spartan commanders, by which the danger from Persia was finally averted) as if a permanent basis for union might be found in the hegemony of Sparta. The sense of a common peril and a common triumph brought with it the need of a common union; it was Athens, however, instead of Sparta, by whom the first conscious effort was made to transcend the isolation of the Greek political system and to bring the units into combination. The league thus founded (the Delian League, established in 477 B.C.) was under the presidency of Athens, but it included hardly any other state besides those that had conducted the defence of Greece. It was formed, almost entirely, of the states which had been liberated from Persian rule by the great victories of the war. The Delian League, even in the form in which it was first established, as a confederation of autonomous allies, marks an advance in political conceptions upon the Peloponnesian League. Provision is made for an annual revenue, for periodical meetings of the council, and for a permanent executive. It is a real federation, though an imperfect one. There were defects in its constitution which rendered it inevitable that it should be transformed into an empire. Athens was from the first "the predominant partner." The fleet was mainly Athenian, the commanders entirely so; the assessment of the tribute was in Athenian hands; there was no federal court appointed to determine questions at issue between Athens and the other members; and, worst omission of all, the right of secession was left undecided. By the middle of the century the Delian League has become the Athenian empire. Henceforward the imperial idea, in one form or another, dominates Greek politics. Athens failed to extend her authority over the whole of Greece. Her empire was overthrown; but the triumph of autonomy proved the triumph of imperialism. The Spartan empire succeeds to the Athenian, and, when it is finally shattered at Leuctra (371 B.C.), the hegemony of Thebes,

which is established on its ruins, is an empire in all but name. The decay of Theban power paves the way for the rise of Macedon.

Thus throughout this period we can trace two forces contending for mastery in the Greek political system. Two causes divide the allegiance of the Greek world, the cause of empire and the cause of autonomy. The formation of the confederacy of Delos did not involve the dissolution of the alliance between Athens and Sparta. For seventeen years more Athens retained her place in the league, "which had been established against the Mede" under the presidency of Sparta in 480 B.C. (Thuc. i. 102). The ascendancy of Cimon and the Philolaconian party at Athens was favourable to a good understanding between the two states; and at Sparta in normal times the balance inclined in favour of the party whose policy is best described by the motto "quieta non movere."

In the end, however, the opposition of the two contending forces proved too strong for Spartan neutrality. The fall of Cimon (461 B.C.) was followed by the so-called "First Peloponnesian War," a conflict between Athens and her maritime rivals, Corinth and Aegina, into which Sparta was ultimately drawn. Thucydides regards the hostilities of these years (460-454 B.C.), which were resumed for a few months in 446 B.C., on the expiration of the Five Years' Truce, as preliminary to those of the great Peloponnesian War (431-404 B.C.). The real question at issue was in both cases the same. The tie that united the opponents of Athens was found in a common hostility to the imperial idea. It is a complete misapprehension to regard the Peloponnesian War as a mere duel between two rival claimants for empire. The ultimatum presented by Sparta on the eve of the war demanded the restoration of autonomy to the subjects of Athens. There is no reason for doubting her sincerity in presenting it in this form. It would, however, be an equal misapprehension to regard the war as merely a struggle between the cause of empire and the cause of autonomy. Corresponding to this fundamental contrast there are other contrasts, constitutional, racial and military. The military interest of the war is largely due to the fact that Athens was a sea power and Sparta a land one. As the war went on, the constitutional aspect tended to become more marked. At first there were democracies on the side of Sparta, and oligarchies on the side of Athens. In the last stage of the war, when Lysander's influence was supreme, we see the forces of oligarchy everywhere united and organized for the destruction of democracy. In its origin the war was certainly not due to the rivalry of Dorian and Ionian. This racial, or tribal, contrast counted for more in the politics of Sicily than of Greece; and, though the two great branches of the Greek race were represented respectively by the leaders of the two sides, the allies on neither side belonged exclusively to the one branch or the other. Still, it remains true that the Dorian states were, as a rule, on the Spartan side, and the Ionian states, as a rule, on the Athenian—a division of sentiment which must have helped to widen the breach, and to intensify the animosities.

As a political experiment the Athenian empire possesses a unique interest. It represents the first attempt to fuse the principles of imperialism and democracy. It is at once the first empire in history possessed and administered by a sovereign people, and the first which sought to establish a common system of democratic institutions amongst its subjects.¹ It was an experiment that failed, partly owing to the inherent strength of the oligarchic cause, partly owing to the exclusive character of ancient citizenship. The Athenians themselves recognized that their empire depended for its existence upon the solidarity of democratic interests (see Thuc. iii. 47; Pseudo-Xenophon, *de Rep. Ath.* i. 14, iii. 10). An understanding existed between the democratic leaders in the subject-states and the democratic party at Athens.

¹ It has been denied by some writers (e.g. by A. H. J. Greenidge) that Athens interfered with the constitutions of the subject-states. For the view put forward in the text, the following passages may be quoted: Aristotle, *Politics* 1307 b 20; Isocrates, *Panegyricus*, 105, 106, *Panathenæicus*, 54 and 68; Xenophon, *Hellenicus*, iii. 4-7; *Pa.-Xen. Athen. Constit.* i. 14, iii. 10.

The Peloponnesian Wars.

The Athenian empire.

Charges were easily trumped up against obnoxious oligarchs, and conviction as easily obtained in the Athenian courts of law. Such a system forced the oligarchs into an attitude of opposition. How much this opposition counted for was realized when the Sicilian disaster (413 B.C.) gave the subjects their chance to revolt. The organization of the oligarchical party throughout the empire, which was effected by Lysander in the last stage of the war, contributed to the overthrow of Athenian ascendancy hardly less than the subsidies of Persia. Had Athens aimed at establishing a community of interest between herself and her subjects, based upon a common citizenship, her empire might have endured. It would have been a policy akin to that which secured the permanence of the Roman empire. And it was a policy which found advocates when the day for it was past (see Aristophanes, *Lysistrata*, 574 ff.; cf. the grant of citizenship to the Samians after Aegospotami, *C.I.A.* iv. 2, 1b). But the policy pursued by Athens in the plenitude of her power was the reverse of the policy pursued by Rome in her treatment of the franchise. It is hardly an exaggeration to say that the fate of the empire was sealed by the law of Pericles (451 B.C.), by which the franchise was restricted to those who could establish Athenian descent on both sides. It was not merely that the process of amalgamation through intermarriage was abruptly checked; what was more serious was that a hard and fast line was drawn, once and for all, between the small body of privileged rulers and the great mass of unprivileged subjects. Maine (*Early Institutions*, lecture 13) has classed the Athenian empire with those of the familiar Oriental type, which attempt nothing beyond the raising of taxes and the levying of troops. The Athenian empire cannot, indeed, be classed with the Roman, or with the British rule in India; it does not, therefore, deserve to be classed with the empires of Cyrus or of Jenghiz Khan. Though the basis of its organization, like that of the Persian empire under Darius, was financial, it attempted, and secured, objects beyond the mere payment of tribute and the supply of ships. If Athens did not introduce a common religion, or a common system of education, or a common citizenship, she did introduce a common type of political institutions, and a common jurisdiction.¹ She went some way, too, in the direction of establishing a common system of coins, and of weights and measures. A common language was there already. In a word, the Athenian empire marks a definite stage of political evolution.

The other great political movement of the age was the progress of democracy. Before the Persian invasion democracy was a rare phenomenon in Greek politics. Where it was found it existed in an undeveloped form, and its tenure of power was precarious. By the beginning of the Peloponnesian War it had become the prevalent form of government. The great majority of Greek states had adopted democratic constitutions. Both in the Athenian sphere of influence and in the colonial world outside that sphere, democracy was all but the only form of constitution known. It was only in Greece proper that oligarchy held its own. In the Peloponnese it could count a majority of the states; in northern Greece at least a half of them. The spread of democratic institutions was arrested by the victory of Sparta in the East, and the rise of Dionysius in the West. There was a moment at the end of the 5th century when it looked as if democracy was a lost cause. Even Athens was for a brief period under the rule of the Thirty (404-403 B.C.). In the regions which had formed the empire of Athens the decarchies set up by Lysander were soon overthrown, and democracies restored in most cases, but oligarchy continued to be the prevalent form in Greece proper until Leuctra (371 B.C.), and in Sicily tyranny had a still longer tenure of power. By the end of the Great Age oligarchy has almost disappeared from the Greek world, except in the sphere of Persian influence. The Spartan monarchy still survives; a few Peloponnesian states still maintain the rule of the few; here

¹ The evidence seems to indicate that all the more important criminal cases throughout the empire were tried in the Athenian courts. In civil cases Athens secured to the citizens of the subject-states the right of suing Athenian citizens, as well as citizens of other subject-states.

and there in Greece itself we meet with a revival of the *tyrannis*; but, with these exceptions, democracy is everywhere the only type of constitution. And democracy has developed as well as spread. At the end of the 5th century the constitution of Cleisthenes, which was a democracy in the view of his contemporaries, had come to be regarded as an aristocracy (Aristof. *Alh. Pol.* 29, 3). We can trace a similar change of sentiment in Sicily. As compared with the extreme form of constitution adopted at Syracuse after the defeat of the Athenian expedition, the democracies established two generations earlier, on the fall of the *tyrannis*, appeared oligarchical. The changes by which the character of the Greek democracies was revolutionized were four in number: the substitution of sortition for election, the abolition of a property qualification, the payment of officials and the rise of a class of professional politicians. In the democracy of Cleisthenes no payment was given for service, whether as a magistrate, a juror or a member of the Boule. The higher magistracies were filled by election, and they were held almost exclusively by the members of the great Athenian families. For the highest office of all, the archonship, none but *Pentacosiomedimni* (the first of the four Solonian classes) were eligible. The introduction of pay and the removal of the property qualification formed part of the reforms of Pericles. Sortition had been instituted for election a generation earlier (487 B.C.).² What is perhaps the most important of all these changes, the rise of the demagogues, belongs to the era of the Peloponnesian War. From the time of Cleisthenes to the outbreak of the war every statesman of note at Athens, with the exception of Themistocles (and, perhaps, of Ephialtes), is of aristocratic birth. Down to the fall of Cimon the course of Athenian politics is to a great extent determined by the alliances and antipathies of the great clans. With the Peloponnesian War a new epoch begins. The chief office, the *strategia*, is still, as a rule, held by men of rank. But leadership in the Ecclesia has passed to men of a different class. The demagogues were not necessarily poor men. Cleon was a wealthy man; Eucrates, Lysicles and Hyperbolus were, at any rate, tradesmen rather than artisans. The first "labour member" proper is Cleophon (411-404 B.C.), a lyre-maker. They belonged, however, not to the land-owning, but to the industrial classes; they were distinguished from the older race of party-leaders by a vulgar accent, and by a violence of gesture in public speaking, and they found their supporters among the population of the city and its port, the Peiræus, rather than among the farmers of the country districts. In the 4th century the demagogues, though under another name, that of orators, have acquired entire control of the Ecclesia. It is an age of professionalism, and the professional soldier has his counterpart in the professional politician. Down to the death of Pericles the party-leader had always held office as Strategus. His rival, Thucydides, son of Melesias, forms a solitary exception to this statement. In the 4th century the divorce between the general and the statesman is complete. The generals are professional soldiers, who aspire to no political influence in the state, and the statesmen devote themselves exclusively to politics, a career for which they have prepared themselves by a professional training in oratory or administrative work. The ruin of agriculture during the war had reduced the old families to insignificance. Birth counts for less than nothing as a political asset in the age of Demosthenes.

But great as are the contrasts which have been pointed out between the earlier and the later democracy, those that distinguish the ancient conception of democracy from the modern are of a still more essential nature. The differences that distinguish the democracies of ancient Greece from those of the modern world have their origin, to a great extent, in the difference between a city-state and a nation-state. Many of the most famous Greek states

² After this date, and partly in consequence of the change, the archonship, to which sortition was applied, loses its importance. The *strategi* (generals) become the chief executive officials. As election was never replaced by the lot in that case, the change had less practical meaning than might appear at first sight. (See ANTHONY STRATEGUS.)

The nature democracy.

The city-state.

had an area of a few square miles; the largest of them was no larger than an English county. Political theory put the limit of the citizen-body at 10,000. Though this number was exceeded in a few cases, it is doubtful if any state, except Athens, ever counted more than 20,000 citizens. In the nation-states of modern times, democratic government is possible only under the form of a representative system; in the city-state representative government was unnecessary, and therefore unknown. In the ancient type of democracy a popular chamber has no existence. The Ecclesia is not a chamber in any sense of the term; it is an assembly of the whole people, which every citizen is entitled to attend, and in which every one is equally entitled to vote and speak. The question raised in modern political science, as to whether sovereignty resides in the electors or their representatives, has thus neither place nor meaning in ancient theory. In the same way, one of the most familiar results of modern analysis, the distinction between the executive and the legislative, finds no recognition in the Greek writers. In a direct system of government there can be no executive in the proper sense. Executive functions are discharged by the ecclesia, to whose decision the details of administration may be referred. The position of the strategi, the chief officials in the Athenian democracy of the 5th century, was in no sense comparable to that of a modern cabinet. Hence the individual citizen in an ancient democracy was concerned in, and responsible for, the actual work of government to a degree that is inconceivable in a modern state. Thus participation in the administrative and judicial business of the state is made by Aristotle the differentia of the citizen (*πολιτης εστιν ο μετεχων κρισεως και αρχης*, Aristot. *Politics*, p. 1275 a 20). A large proportion of the citizens of Athens, in addition to frequent service in the courts of law, must in the course of their lives have held a magistracy, great or small, or have acted for a year or two as members of the Boule.¹ It must be remembered that there was nothing corresponding to a permanent civil service in the ancient state. Much of the work of a government office would have been transacted by the Athenian Boule. It must be remembered, too, that political and administrative questions of great importance came before the popular courts of law. Hence it follows that the ordinary citizen of an ancient democracy, in the course of his service in the Boule or the law-courts, acquired an interest in political questions, and a grasp of administrative work, which none but a select few can hope to acquire under the conditions of the modern system. Where there existed neither a popular chamber nor a distinct executive, there was no opportunity for the growth of a party-system. There were, of course, political parties at Athens and elsewhere—oligarchs and democrats, conservatives and radicals, a peace-party and a war-party; according to the burning question of the day. There was, however, nothing equivalent to a general election, to a cabinet (or to that collective responsibility which is of the essence of a cabinet), or to the government and the opposition. Party organization, therefore, and a party system, in the proper sense, were never developed. Whatever may have been the evils incident to the ancient form of democracy, the "boss," the caucus and the spoils-system were not among them.

Besides these differences, which, directly or indirectly, result from the difference of scale, there are others, hardly less profound, which are not connected with the size of the city-state. Perhaps the most striking contrast between the democracies of ancient and of modern times is to be found in their attitude towards privilege. Ancient democracy implies privilege; modern democracy implies its destruction. In the more fully developed democracies of the modern world (e.g. in the United States, or in Australia), the privilege of class is unknown; in some of them (e.g. New Zealand, Australia, Norway) even the privilege of sex has been abolished. Ancient democracy was bound up with privilege as much as oligarchy was. The transition from the latter to the former was effected by enlarging the area of privilege and by altering its basis. In an oligarchical state citizenship

¹ For an estimate of the numbers annually engaged in the service of Athens, see Aristot. *Ath. Pol.* 24. 3.

might be confined to 10% of the free population; under a democracy 50% might enjoy it. In the former case the qualification might be wealth or land; in the latter case it might be, as it was at Athens, birth, i.e. descent, on both sides, from a citizen family. But, in both cases alike, the distinction between a privileged and an unprivileged body of free-born residents is fundamental. To the unprivileged class belonged, not only foreigners temporarily resident (*ξῖνοι*) and aliens permanently domiciled (*μετρώουσι*), but also those native-born inhabitants of the state who were of foreign extraction, on one side or the other.² The privileges attaching to citizenship included, in addition to eligibility for office and a vote in the assembly, such private rights as that of owning land or a house, or of contracting a marriage with one of citizen status. The citizen, too, was alone the recipient of all the various forms of pay (e.g. for attendance in the assembly, for service in the Boule or the law-courts, or for the celebration of the great festivals) which are so conspicuous a feature in the developed democracy of the 4th century. The *melœci* could not even plead in a court of law in person, but only through a patron (*προστάτης*). It is intelligible that privileges so great should be jealously guarded. In the democracies of the modern world naturalization is easy; in those of ancient Greece admission to the franchise was rarely accorded. In modern times, again, we are accustomed to connect democracy with the emancipation of women. It is true that only a few democratic constitutions grant them the suffrage; but though, as a rule, they are denied public rights, the growth of popular government has been almost everywhere accompanied by an extension of their private rights, and by the removal of the restrictions imposed by law, custom or public opinion upon their freedom of action. In ancient Greece the democracies were as illiberal in their policy as the oligarchies. Women of the respectable class were condemned to comparative seclusion. They enjoyed far less freedom in 4th-century Athens than in the Homeric Age. It is not in any of the democracies, but in conservative Sparta, that they possess privilege and exercise influence.

Position of women.

The most fundamental of all the contrasts between democracy in its ancient and in its modern form remains to be stated. The ancient state was inseparable from slavery. In this respect there was no difference between democracy and the other forms of government. No inconsistency was felt, therefore, between this institution and the democratic principle. Modern political theory has been profoundly affected by the conception of the dignity of labour; ancient political theory tended to regard labour as a disqualification for the exercise of political rights. Where slavery exists, the taint of it will inevitably cling to all labour that can be performed by the slave. In ancient Athens (which may be taken as typical of the Greek democracies) unskilled labour was almost entirely slave-labour, and skilled labour was largely so. The arts and crafts were, to some extent, exercised by citizens, but to a less extent in the 4th than in the 6th century. They were, however, chiefly left to aliens or slaves. The citizen-body of Athens in the age of Demosthenes has been stigmatized as consisting in great measure of salaried paupers. There is, doubtless, an exaggeration in this. It is, however, true, both that the system of state-pay went a long way towards supplying the simple wants of a southern population, and that a large proportion of the citizens had time to spare for the service of the state. Had the life of the lower class of citizens been absorbed in a round of mechanical labours, as fully as is the life of our industrial classes, the working of an ancient democracy would have been impossible. In justice to the ancient democracies it must be conceded that, while popular government carried with it neither the enfranchisement of the alien nor the emancipation of the slave, the rights secured to both classes were more considerable in the democratic states than elsewhere. The lot of the slave, as well as that of the alien, was a peculiarly favourable one at Athens. The pseudo-Xenophon in the 5th century (*De rep. Ath.* 1. 10-12) and Plato

² Foreign is not used here as equivalent to non-Hellenic. It means "belonging to another state, whether Greek or barbarian."

in the 4th (*Republic*, p. 503 B), prove that the spirit of liberty, with which Athenian life was permeated, was not without its influence upon the position of these classes. When we read that critics complained of the opulence of slaves, and of the liberties they took, and when we are told that the slave could not be distinguished from the poorer class of citizens either by his dress or his look, we begin to realize the difference between the slavery of ancient Athens and the system as it was worked on the Roman *latifundia* or the plantations of the New World.

It had been anticipated that the fall of Athens would mean the triumph of the principle of autonomy. If Athens had surrendered within a year or so of the Sicilian catastrophe, this anticipation would probably have been fulfilled. It was the last phase of the struggle (412-404 B.C.) that rendered a Spartan empire inevitable.

The oligarchical governments established by Lysander recognized that their tenure of power was dependent upon Spartan support, while Lysander himself, to whose genius, as a political organizer not less than as a commander, the triumph of Sparta was due, was unwilling to see his work undone. The Athenian empire had never included the greater part of Greece proper; since the Thirty Years' Peace its possessions on the mainland, outside the boundaries of Attica, were limited to Naupactus and Plataea. Sparta, on the other hand, attempted the control of the entire Greek world east of the Adriatic. Athens had been compelled to acknowledge a dual system; Sparta sought to establish uniformity. The attempt failed from the first. Within a year of the surrender of Athens, Thebes and Corinth had drifted into an attitude of opposition, while Argos remained hostile. It was not long before the policy of Lysander succeeded in uniting against Sparta the very forces upon which she had relied when she entered on the Peloponnesian War. The Corinthian War (394-387 B.C.) was brought about by the alliance of all the second-class powers—Thebes, Athens, Corinth, Argos—against the one first-class power, Sparta. Though Sparta emerged successful from the war, it was with the loss of her maritime empire, and at the cost of recognizing the principle of autonomy as the basis of the Greek political system. It was already evident, thus early in the century, that the centrifugal forces were to prove stronger than the centripetal. Two further causes may be indicated which help to explain the failure of the Spartan empire. In the first place Spartan sea-power was an artificial creation. History seems to show that it is idle for a state to aspire to naval supremacy unless it possesses a great commercial marine. Athens had possessed such a marine; her naval supremacy was due not to the mere size of her fleet, but to the numbers and skill of her seafaring population. Sparta had no commerce. She could build fleets more easily than she could man them. A single defeat (at Cnidus, 391 B.C.) sufficed for the ruin of her sea-power. The second cause is to be found in the financial weakness of the Spartan state. The Spartan treasury had been temporarily enriched by the spoils of the Peloponnesian War, but neither during that war, nor afterwards, did Sparta succeed in developing any scientific financial system. Athens was the only state which either possessed a large annual revenue or accumulated a considerable reserve. Under the conditions of Greek warfare, fleets were more expensive than armies. Not only was money needed for the building and maintenance of the ships, but the sailor must be paid, while the soldier served for nothing. Hence the power with the longest purse could both build the largest fleet and attract the most skillful seamen.

The battle of Leuctra transferred the hegemony from Sparta to Thebes, but the attempt to unite Greece under the leadership of Thebes was from the first doomed to failure. The conditions were less favourable to Thebes than they had been to Athens or Sparta. Thebes was even more exclusively a land-power than Sparta. She had no revenue comparable to that of Athens in the preceding century. Unlike Athens and Sparta, she had not the advantage of being identified with a political cause. As the enemy of Athens in the 5th century, she was on the side of oligarchy; as the rival of Sparta in the 4th, she was on the side of democracy; but in her

bid for primacy she could not appeal, as Athens and Sparta could, to a great political tradition, nor had she behind her, as they had, the moral force of a great political principle. Her position, too, in Boeotia itself was insecure. The rise of Athens was in great measure the result of the *synoecism* (*συνουσιασμός*) of Attica. All inhabitants of Attica were Athenians. But "Boeotian" and "Theban" were not synonymous terms. The Boeotian league was an imperfect form of union, as compared with the Athenian state, and the claim of Thebes to the presidency of the league was, at best, sullenly acquiesced in by the other towns. The destruction of some of the most famous of the Boeotian cities, however necessary it may have been in order to unite the country, was a measure which at once impaired the resources of Thebes and outraged Greek sentiment. It has been often held that the failure of Theban policy was due to the death of Epaminondas (at the battle of Mantinea, 362 B.C.). For this view there is no justification. His policy had proved a failure before his death. Where it harmonized with the spirit of the age, the spirit of dissidence, it succeeded; where it attempted to run counter to it, it failed. It succeeded in destroying the supremacy of Sparta in the Peloponnese; it failed to unite the Peloponnese on a new basis. It failed still more signally to unite Greece north of the Isthmus. It left Greece weaker and more divided than it found it (see the concluding words of Xenophon's *Hellenics*). It would be difficult to overestimate the importance of his policy as a destructive force; as a constructive force it effected nothing! The Peloponnesian system which Epaminondas overthrew had lasted two hundred years. Under Spartan leadership the Peloponnese had enjoyed almost complete immunity from invasion and comparative immunity from *stasis* (faction). The claim that Isocrates makes for Sparta is probably well-founded (*Archidamus*, 64-69; during the period of Spartan ascendancy the Peloponnesians were *εὐδαιμονοτάτοι τῶν Ἑλλήνων*). Peloponnesian sentiment had been one of the chief factors in Greek politics; to it, indeed, in no small degree was due the victory over Persia. The Theban victory at Leuctra destroyed the unity, and with it the peace and the prosperity, of the Peloponnese. It inaugurated a period of misery, the natural result of *stasis* and invasion, to which no parallel can be found in the earlier history (See Isocrates, *Archidamus*, 65, 66; the Peloponnesians were *ὀρθαδίμονοι ταῖς συμφοραῖς*). It destroyed, too, the Peloponnesian sentiment of hostility to the invader. The bulk of the army that defeated Mardonius at Plataea came from the Peloponnese; at Chæronea no Peloponnesian state was represented.

The question remains, Why did the city-state fail to save Greece from conquest by Macedon? Was this result due to the inherent weakness either of the city-state itself, or of one particular form of it, democracy? It is clear, in any case, that the triumph of Macedon was the effect of causes which had long been at work. If neither Philip nor Alexander had appeared on the scene, Greece might have maintained her independence for another generation or two; but, when invasion came, it would have found her weaker and more distracted, and the conquerors might easily have been less imbued with the Greek spirit, and less sympathetic towards Greek ideals, than the great Macedonian and his son. These causes are to be found in the tendencies of the age, political, economic and moral. Of the two movements which characterized the Great Age in its political aspect, the imperial and the democratic, the one failed and the other succeeded. The failure and the success were equally fatal to the chances of Greece in the conflict with Macedon. By the middle of the 4th century Greek politics had come to be dominated by the theory of the balance of power. This theory, enunciated in its coarsest form by Demosthenes (*Pro Megalopoliti*, 4 *συνφέρει τῇ πόλει καὶ Λακεδαιμονίῳ ὁδοῦναι εἶναι καὶ Θηβαίους*; cf. in *Aristocrat.* 102, 103), had shaped the foreign policy of Athens since the end of the Peloponnesian War. As long as Sparta was the stronger, Athens inclined to a Theban alliance; after Leuctra she tended in the direction of a Spartan one. At the epoch of Philip's

It failed even to create a united Arcadia or a strong Messenia.

accession the forces were everywhere nicely balanced. The Peloponnesse was fairly equally divided between the Theban and the Spartan interests, and central Greece was similarly divided between the Theban and the Athenian. Farther north we get an Athenian party opposed to an Olynthian in Chalcidice, and a republican party, dependent upon the support of Thebes, opposed to that of the tyrants in Thessaly. It is easy to see that the political conditions of Greece, both in the north and in the south, invited interference from without. And the triumph of democracy in its extreme form was ruinous to the military efficiency of Greece. On the one side there was a monarchical state, in which all powers, civil as well as military, were concentrated in the hands of a single ruler; on the other, a constitutional system, in which a complete separation had been effected between the responsibility of the statesman and that of the commander.¹

It could not be doubtful with which side victory would rest. Meanwhile, the economic conditions were steadily growing worse. The cause which Aristotle assigns for the decay of the Spartan state—a declining population (see *Politics*, p. 1270 a ἐπὶ ὄλεθρον ἢ πόλις τῶν Λακεδαιμονίων διὰ τῆν ἀλλαγῆσθαι)—might be extended to the Greek world generally. The loss of population was partly the result of war and *stasis*—Isocrates speaks of the number of political exiles from the various states as enormous²—but it was also due to a declining birth-rate, and to the exposure of infants. Aristotle, while condemning exposure, sanctions the procuring of abortion (*Politics*, 1335 b). It is probable that both ante-natal and post-natal infanticide were rife everywhere, except among the more backward communities. A people which has condemned itself to racial suicide can have little chance when pitted against a nation in which healthier instincts prevail. The materials for forming a trustworthy estimate of the population of Greece at any given epoch are not available; there is enough evidence, however, to prove that the military population of the leading Greek states at the era of the battle of Chaeronea (338 B.C.) fell far short of what it had been at the beginning of the Peloponnesian War. The decline in population had been accompanied by a decline in wealth, both public and private; and while revenues had shrunk, expenditure had grown. It was a century of warfare; and warfare had become enormously more expensive, partly through the increased employment of mercenaries, partly through the enhanced cost of material. The power of the purse had made itself felt even in the 5th century; Persian gold had helped to decide the issue of the great war. In the politics of the 4th century the power of the purse becomes the determining factor. The public finance of the ancient world was singularly simple in character, and the expedients for raising a revenue were comparatively few. The distinction between direct and indirect taxation was recognized in practice, but states as a rule were reluctant to submit to the former system. The revenue of Athens in the 5th century was mainly derived from the tribute paid by her subjects; it was only in time of war that a direct tax was levied upon the citizen-body.³ In the age of Demosthenes the revenue derived from the Athenian Confederacy was insignificant. The whole burden of the expenses of a war fell upon the 1200 richest citizens, who were subject to direct taxation in the dual form of the *Triarchy* and the *Eisphora* (property-tax). The revenue thus raised was wholly insufficient for an effort on a great scale; yet the revenues of Athens at this period must have exceeded those of any other state.

It is to moral causes, however, rather than to political or economic ones, that the failure of Greece in the conflict with Macedonia is attributed by the most famous Greek statesmen of that age. Demosthenes is never weary of insisting upon the decay of patriotism among the citizens and upon the decay of probity among their leaders. Venality had always been the besetting sin of Greek statesmen. Pericles' boast as to his

¹ See Demosthenes, *On the Crown*, 235. Philip was ἀπορρήτους, ἀεπίστους, ἀφειδούς, ἀβροτοὺς παύσας.

² See Archidamus, 68; *Philippus*, 96, ὅσα ἄνθρωποι εἶναι οὐκ ἔστιν ἀπορρήτους μίσην καὶ ἀπίστον ἢ τῶν Πλατωνίων ἢ ἢ τῶν Πολυπολιτῶν.

³ The *Liturgies* (e.g. the triarchy) had much the same effect as a direct tax levied upon the wealthiest citizens.

own incorruptibility (Thuc. ii. 60) is significant as to the reputation of his contemporaries. In the age of Demosthenes the level of public life in this respect had sunk at least as low as that which prevails in many states of the modern world (see Demosth. *On the Crown*, 61 παρὰ τοῖς Ἕλλησιν, οὐ τισὶν ἄλλ' ἀπασιν ὁμοίως φορὰ προδοσίας καὶ δωροδοκίαν συνίβη; cf. §§ 295, 296). Corruption was certainly not confined to the Macedonian party. The best that can be said in defence of the patriots, as well as of their opponents, is that they honestly believed that the policy which they were bribed to advocate was the best for their country's interests. The evidence for the general decay of patriotism among the mass of the citizens is less conclusive. The battle of Megalopolis (331 B.C.), in which the Spartan soldiery "went down in a blaze of glory," proves that the spirit of the Lacedaemonian state remained unchanged. But at Athens it seemed to contemporary observers—to Isocrates equally with Demosthenes—that the spirit of the great days was extinct (see Isocr. *On the Peace*, 47, 48). It cannot, of course, be denied that public opinion was obstinately opposed to the diversion of the Theoric Fund to the purposes of the war with Philip. It was not till the year before Chaeronea that Demosthenes succeeded in persuading the assembly to devote the entire surplus to the expenses of the war.⁴ Nor can it be denied that mercenaries were far more largely employed in the 4th century than in the 5th. In justice, however, to the Athenians of the Demosthenic era, it should be remembered that the burden of direct taxation was rarely imposed, and was reluctantly endured, in the previous century. It must also be remembered that, even in the 4th century, the Athenian citizen was ready to take the field, provided that it was not a question of a distant expedition or of prolonged service.⁵ For distant expeditions, or for prolonged service, a citizen-militia is unsuited. The substitution of a professional force for an unprofessional one is to be explained, partly by the change in the character of Greek warfare, and partly by the operation of the laws of supply and demand. There had been a time when warfare meant a brief campaign in the summer months against a neighbouring state. It had come to mean prolonged operations against a distant enemy.⁶ Athens was at war, e.g. with Philip, for eleven years continuously (357–346 B.C.). If winter campaigns in Thrace were unpopular at this epoch, they had been hardly less unpopular in the epoch of the Peloponnesian War. In the days of her greatness, too, Athens had freely employed mercenaries, but it was in the navy rather than the army. In the age of Pericles the supply of mercenary rowers was abundant, the supply of mercenary troops inconsiderable. In the age of Demosthenes incessant warfare and ceaseless revolution had filled Greece with crowds of homeless adventurers. The supply helped to create the demand. The mercenary was as cheap as the citizen-soldier, and much more effective. On the whole, then, it may be inferred that it is a mistake to regard the prevalence of the mercenary system as the expression of a declining patriotism. It would be nearer the mark to treat the transition from the voluntary to the professional system as cause rather than effect: as one among the causes which contributed to the decay of public spirit in the Greek world.

⁴ 6. *From Alexander to the Roman Conquest (336–146 B.C.)*.—In the history of Greece proper during this period the interest is mainly constitutional. It may be called the age of federation. Federation, indeed, was no novelty in Greece. Federal unions had existed in Thessaly, in Boeotia and elsewhere, and the Boeotian league can be traced back at least to the 6th century. Two newly-founded federations, the Chalcidian and the Arcadian, play no inconsiderable part in the politics of the 4th century. But it is not till the 3rd century that federation attains to its full development in Greece, and becomes the normal type of polity. The two great

⁵ His extreme caution in approaching the question at an earlier date is to be noticed. See, e.g., *Olynthiacs*, i. 19, 20.

⁶ e.g. the two expeditions sent to Euboea, the cavalry force that took part in the battle of Mantinea, and the army that fought at Chaeronea. The troops in all these cases were citizens.

⁷ For the altered character of warfare see Demosthenes, *Philippics*, iii. 48, 49.

Federal
govern-
ment.

leagues of this period are the Aetolian and the Achaean. Both had existed in the 4th century, but the latter, which had been dissolved shortly before the beginning of the 3rd century, becomes important only after its restoration in 280 B.C., about which date the former, too, first begins to attract notice. The interest of federalism lies in the fact that it marks an advance beyond the conception of the city-state. It is an attempt to solve the problem which the Athenian empire failed to solve, the reconciliation of the claims of local autonomy with those of national union. The federal leagues of the 3rd century possess a further interest for the modern world, in that there can be traced in their constitutions a nearer approach to a representative system than is found elsewhere in Greek experience. A genuine representative system, it is true, was never developed in any Greek polity. What we find in the leagues is a sort of compromise between the principle of a primary assembly and the principle of a representative chamber. In both leagues the nominal sovereign was a primary assembly, in which every individual citizen had the right to vote. In both of them, however, the real power lay with a council (*Bouλή*) composed of members representative of each of the component states.¹

The real interest of this period, however, is to be looked for elsewhere than in Greece itself. Alexander's career is one of the turning-points in history. He is one of the few to whom it has been given to modify the whole future of the human race. He originated two forces which have profoundly affected the development of civilization. He created Hellenism, and he created for the western world the monarchical ideal. Greece had produced personal rulers of ability, or even of genius; but to the greatest of these, to Peisistratus, to Dionysius, even to Jason of Pherae, there clung the fatal taint of illegitimacy. As yet no ruler had succeeded in making the person of the monarch respectable. Alexander made it sacred. From him is derived, for the West, that "divinity that doth hedge a king." And in creating Hellenism he created, for the first time, a common type of civilization, with a common language, literature and art, as well as a common form of political organization. In Asia Minor he was content to reinforce the existing Hellenic elements (cf. the case of Side, Arrian, *Anabasis*, i. 26. 4). In the rest of the East his instrument of hellenization was the *polis*. He is said to have founded no less than seventy cities, destined to become centres of Greek influence; and the great majority of these were in lands in which city-life was almost unknown. In this respect his example was emulated by his successors. The eastern provinces were soon lost, though Greek influences lingered on even in Bactria and across the Indus. It was only the regions lying to the west of the Euphrates that were effectively hellenized, and the permanence of this result was largely due to the policy of Rome. But after all deductions have been made, the great fact remains that for many centuries after Alexander's death Greek was the language of literature and religion, of commerce and of administration throughout the Nearer East. Alexander had created a universal empire as well as a universal culture. His empire perished at his death, but its central idea survived—that of the municipal freedom of the Greek *polis* within the framework of an imperial system. Hellenistic civilization may appear degenerate when compared with Hellenic; when compared with the civilizations which it superseded in non-Hellenic lands, it marks an unquestionable advance. (For the history of Greek civilization in the East, see HELLENISM.) Greece left her mark upon the civilization of the West as well as upon that of the East, but the process by which her influence was diffused was essentially different. In the East Hellenism came in the train of the conqueror, and Rome was content to build upon the foundations laid by Alexander. In the West Greek influences were diffused by the Roman conquest of Greece. It was through the ascendancy which Greek literature, philosophy and art acquired over the Roman mind that Greek culture penetrated to the nations of western Europe. The civilization

¹ It is known that the councillors were appointed by the states in the Aetolian league; it is only surmised in the case of the Achaean.

of the East remained Greek. The civilization of the West became and remained Latin, but it was a Latin civilization that was saturated with Greek influences. The ultimate division, both of the empire and the church, into two halves, finds its explanation in this original difference of culture.

ANCIENT AUTHORITIES.—(I.) For the earliest periods of Greek history, the so-called Minoan and Mycenaean, the evidence is purely archaeological. It is sufficient here to refer to the article AEGEAN CIVILIZATION. For the next period, the Heroic or Homeric Age, the evidence is derived from the poems of Homer. In any estimate of the value of these poems as historical evidence, much will depend upon the view taken of the authorship, age and unity of the poems. For a full discussion of these questions see HOMER. It cannot be questioned that the poems are evidence for the existence of a period in the history of the Greek race, which differed from later periods in political and social, military and economic conditions. But here agreement ends. If, as is generally held by German critics, the poems are not earlier than the 9th century, if they contain large interpolations of considerably later date and if they are Ionian in origin, the authority of the poems becomes comparatively slight. The existence of different strata in the poems will imply the existence of inconsistencies and contradictions in the evidence; nor will the evidence be that of a contemporary. It will also follow that the picture of the heroic age contained in the poems is an idealized one. The more extreme critics, e.g. Beloch, deny that the poems are evidence even for the existence of a pre-Dorian epoch. If, on the other hand, the poems are assigned to the 11th or 12th century, to a Peloponnesian writer, and to a period anterior to the Dorian Invasion and the colonization of Asia Minor (this is the view of the late Dr D. B. Munro), the evidence becomes that of a contemporary, and the authority of the poems for the distribution of races and tribes in the Heroic Age, as well as for the social and political conditions of the poet's time, would be conclusive. Homer recognizes no Dorians in Greece, except in Crete (see *Odyssey*, xix. 177), and no Greek colonies in Asia Minor. Only two explanations are possible. Either there is deliberate archaism in the poems, or else they are earlier in date than the Dorian Invasion and the colonization of Asia Minor.

II. For the period that extends from the end of the Heroic Age to the end of the Peloponnesian War² the two principal authorities are Herodotus and Thucydides. Not only have the other historical works which treated of this period perished (those at least whose date is earlier than the Christian era), but their authority was secondary and their material chiefly derived from these two writers. In one respect then this period of Greek history stands alone. Indeed, it might be said, with hardly an exaggeration, that there is nothing like it elsewhere in history. Almost our sole authorities are two writers of unique genius, and they are writers whose works have come down to us intact. For the period which ends with the repulse of the Persian invasion our authority is Herodotus. For the period which extends from 478 to 411 we are dependent upon Thucydides'. In each case, however, a distinction must be drawn. The Persian Wars form the proper subject of Herodotus's work; the Peloponnesian War is the subject of Thucydides. The interval between the two wars is merely sketched by Thucydides; while of the period anterior to the conflicts of the Greek with the Persian, Herodotus does not attempt either a complete or a continuous narrative. His references to it are episodic and accidental. Hence our knowledge of the Persian Wars and of the Peloponnesian War is widely different in character from our knowledge of the rest of this period. In the history of these wars the *lacunae* are few; in the rest of the history they are alike frequent and serious. In the history, therefore, of the Persian and Peloponnesian Wars little is to be learnt from the secondary sources. Elsewhere, especially in the interval between the two wars, they become relatively important.

In estimating the authority of Herodotus (q.v.) we must be

² Strictly speaking, to 411 B.C. For the last seven years of the war our principal authority is Xenophon, *Hellenica*, i., ii.

careful to distinguish between the invasion of Xerxes and all that is earlier. Herodotus's work was published soon after 430 B.C., i.e. about half a century after the invasion. Much of his information was gathered in the course of the preceding twenty years. Although his evidence is not that of an eye-witness, he had opportunities of meeting those who had themselves played a part in the war, on one side or the other (e.g. Thersander of Orchomenos, ix. 16). In any case, we are dealing with a tradition which is little more than a generation old, and the events to which the tradition relates, the incidents of the struggle against Xerxes, were of a nature to impress themselves indelibly upon the minds of contemporaries. Where, on the other hand, he is treating of the period anterior to the invasion of Xerxes, he is dependent upon a tradition which is never less than two generations old, and is sometimes centuries old. His informants were, at best, the sons or grandsons of the actors in the wars (e.g. Archias the Spartan, iii. 55). Moreover, the invasion of Xerxes, entailing, as it did, the destruction of cities and sanctuaries, especially of Athens and its temples, marks a dividing line in Greek history. It was not merely that evidence perished and records were destroyed. What in reference to tradition is even more important, a new consciousness of power was awakened, new interests were aroused, and new questions and problems came to the front. The former things had passed away; all things were become new. A generation that is occupied with making history on a great scale is not likely to busy itself with the history of the past. Consequently, the earlier traditions became faint and obscured, and the history difficult to reconstruct. As we trace back the conflict between Greece and Persia to its beginnings and antecedents, we are conscious that the tradition becomes less trustworthy as we pass back from one stage to another. The tradition of the expedition of Datis and Artaphernes is less credible in its details than that of the expedition of Xerxes, but it is at once fuller and more credible than the tradition of the Ionian revolt. When we get back to the Scythian expedition, we can discover but few grains of historical truth.

Much recent criticism of Herodotus has been directed against his veracity as a traveller. With this we are not here concerned. The criticism of him as an historian begins with Thucydides. Among the references of the latter writer to his predecessor are the following passages: i. 21; i. 22 *ad fin.*; i. 20 *ad fin.* (cf. Herod. ix. 53, and vi. 57 *ad fin.*); iii. 62 § 4 (cf. Herod. ix. 87); ii. 2 §§ 1 and 3 (cf. Herod. vii. 233); ii. 8 § 3 (cf. Herod. vi. 98). Perhaps the two clearest examples of this criticism are to be found in Thucydides' correction of Herodotus's account of the Cylonian conspiracy (Thuc. i. 126, cf. Herod. v. 71) and in his appreciation of the character of the Themistocles—a veiled protest against the slanderous tales accepted by Herodotus (i. 138). In Plutarch's tract "On the Malignity of Herodotus," there is much that is suggestive, although his general standpoint, viz. that Herodotus was in duty bound to suppress all that was discreditable to the valour or patriotism of the Greeks, is not that of the modern critic. It must be conceded to Plutarch that he makes good his charge of bias in Herodotus's attitude towards certain of the Greek states. The question, however, may fairly be asked, how far this bias is personal to the author, or how far it is due to the character of the sources from which his information was derived. He cannot, indeed, altogether be acquitted of personal bias. His work is, to some extent, intended as an *apologia* for the Athenian empire. In answer to the charge that Athens was guilty of robbing other Greek states of their freedom, Herodotus seeks to show, firstly, that it was to Athens that the Greek world, as a whole, owed its freedom from Persia, and secondly, that the subjects of Athens, the Ionian Greeks, were unworthy to be free. This leads him to be unjust both to the services of Sparta and to the qualities of the Ionian race. For his estimate of the debt due to Athens see vii. 139. For bias against the Ionians see especially iv. 142 (cf. Thuc. vi. 77); cf. also i. 143 and 146, vi. 12-14 (Ladé), vi. 112 *ad fin.* A striking example of his prejudice in favour of Athens is furnished by vi. 91. At a moment when Greece rang with the crime of

Athens in expelling the Aeginetans from their island, he ventures to trace in their expulsion the vengeance of heaven for an act of sacrilege nearly sixty years earlier (see AEGINA). As a rule, however, the bias apparent in his narrative is due to the sources from which it is derived. Writing at Athens, in the first years of the Peloponnesian War, he can hardly help seeing the past through an Athenian medium. It was inevitable that much of what he heard should come to him from Athenian informants, and should be coloured by Athenian prejudices. We may thus explain the leniency which he shows towards Argos and Thessaly, the old allies of Athens, in marked contrast to his treatment of Thebes, Corinth and Aegina, her deadliest foes. For Argos cf. vii. 152; Thessaly, vii. 172-174; Thebes, vii. 132, vii. 233, ix. 87; Corinth (especially the Corinthian general Adeimantus, whose son Aristeus was the most active enemy of Athens at the outbreak of the Peloponnesian War), vii. 5, vii. 21, viii. 29 and 61, vii. 94; Aegina, ix. 78-80 and 85. In his intimacy with members of the great Alcmaeonid house we probably have the explanation of his depreciation of the services of Themistocles, as well as of his defence of the family from the charges brought against it in connexion with Cylon and with the incident of the shield shown on Pentelicus at the time of Marathon (v. 71, vi. 121-124). His failure to do justice to the Cypselid tyrants of Corinth (v. 92), and to the Spartan king Cleomenes, is to be accounted for by the nature of his sources—in the former case, the tradition of the Corinthian oligarchy; in the latter, accounts, partly derived from the family of the exiled king Demaratus and partly representative of the view of the ephorate. Much of the earlier history is cast in a religious mould, e.g. the story of the Mermnad kings of Lydia in book i., or of the fortunes of the colony of Cyrene (iv. 145-167). In such cases we cannot fail to recognize the influence of the Delphic priesthood. Grote has pointed out that the moralizing tendency observable in Herodotus is partly to be explained by the fact that much of his information was gathered from priests and at temples, and that it was given in explanation of votive offerings, or of the fulfilment of oracles. Hence the determination of the sources of his narrative has become one of the principal tasks of Herodotean criticism. In addition to the current tradition of Athens, the family tradition of the Alcmaeonidae, and the stories to be heard at Delphi and other sanctuaries, there may be indicated the Spartan tradition, in the form in which it existed in the middle of the 5th century; that of his native Halicarnassus, to which is due the prominence of its queen Artemisia; the traditions of the Ionian cities, especially of Samos and Miletus (important both for the history of the Mermnadae and for the Ionian Revolt); and those current in Sicily and Magna Graecia, which were learned during his residence at Thurii (Sybaris and Croton, v. 44, 45; Syracuse and Gela, vii. 153-167). Among his more special sources we can point to the descendants of Demaratus, who still held, at the beginning of the 4th century, the principality in the Troad which had been granted to their ancestor by Darius (Xen. *Hell.* iii. 1. 6), and to the family of the Persian general Artabazus, in which the satrapy of *Dasylium* (Phrygia) was hereditary in the 5th century.¹ His use of written material is more difficult to determine. It is generally agreed that the list of Persian satrapies, with their respective assessments of tribute (iii. 89-97), the description of the royal road from Sardis to Susa (v. 52-54), and of the march of Xerxes, together with the list of the contingents that took part in the expedition (vii. 26-131), are all derived from documentary and authoritative sources. From previous writers (e.g. Dionysius of Miletus, Hecataeus, Charon of Lampsacus and Xanthus the Lydian) it is probable that he has borrowed little, though the fragments are too scanty to permit of adequate comparison. His references to monuments, dedicatory offerings, inscriptions and oracles are frequent.

The chief defects of Herodotus are his failure too grasp the principles of historical criticism, to understand the nature of military operations, and to appreciate the importance of

¹ Possibly some of his information about Persian affairs may have been derived, at first or second hand, from Zopyrus, son of Megabyzus, whose flight to Athens is mentioned in iii. 160.

chronology. In place of historical criticism we find a crude rationalism (e.g. ii. 45, vii. 129, viii. 8). Having no conception of the distinction between occasion and cause, he is content to find the explanation of great historical movements in trivial incidents or personal motives. An example of this is furnished by his account of the Ionian revolt, in which he fails to discover the real causes either of the movement or of its result. Indeed, it is clear that he regarded criticism as no part of his task as an historian. In vii. 152 he states the principles which have guided him—*ἐγὼ δὲ ἀφελῶ λέγειν τὰ λεγόμενα, πάλαιθεν γὰρ μὲν οὐ παράτασι ἀφελῶ, καὶ μοι τοῦτο τὸ ἔτος ἔχρω ἐς πάντα λόγον*. In obedience to this principle he again and again gives two or more versions of a story. We are thus frequently enabled to arrive at the truth by a comparison of the discrepant traditions. It would have been fortunate if all ancient writers who lacked the critical genius of Thucydides had been content to adopt the practice of Herodotus. His accounts of battles are always unsatisfactory. The great battles, Marathon, Thermopylae, Salamis and Plataea, present a series of problems. This result is partly due to the character of the traditions which he follows—traditions which were to some extent inconsistent or contradictory, and were derived from different sources; it is, however, in great measure due to his inability to think out a strategical combination or a tactical movement. It is not too much to say that the battle of Plataea, as described by Herodotus, is wholly unintelligible. Most serious of all his deficiencies is his careless chronology. Even in the case of the 5th century, the data which he affords are inadequate or ambiguous. The interval between the Scythian expedition and the Ionian revolt is described by so vague an expression as *μερὰ δὲ οὐ πολλῶν χρόνων ἔπειτα κακῶν ἦν* (v. 28). In the history of the revolt itself, though he gives us the interval between its outbreak and the fall of Miletus (*ἔργω ἔρει*, vi. 18), he does not give us the interval between this and the battle of Lade, nor does he indicate with sufficient precision the years to which the successive phases of the movement belong. Throughout the work professed synchronisms too often prove to be mere literary devices for facilitating a transition from one subject to another (cf. e.g. v. 81 with 89, 90; or vi. 51 with 87 and 94). In the 6th century, as Grote pointed out, a whole generation, or more, disappears in his historical perspective (cf. i. 30, vi. 125, v. 94, iii. 47, 48, v. 113 contrasted with v. 104 and iv. 162). The attempts to reconstruct the chronology of this century upon the basis of the data afforded by Herodotus (e.g. by Beloch, *Rheinisches Museum*, xlv., 1890, pp. 465-473) have completely failed.

In spite of all such defects Herodotus is an author, not only of unrivalled literary charm, but of the utmost value to the historian. If much remains uncertain or obscure, even in the history of the Persian Wars, it is chiefly to motives or policy, to topography or strategy, to dates or numbers, that uncertainty attaches. It is to these that a sober criticism will confine itself.

Thucydides is at once the father of contemporary history and the father of historical criticism. From a comparison of i. 1, i. 22 and v. 26, we may gather both the principles to which he adhered in the composition of his work and the conditions under which it was composed. It is seldom that the circumstances of an historical writer have been so favourable for the accomplishment of his task. Thucydides was a contemporary of the Twenty-Seven Years' War in the fullest sense of the term. He had reached manhood at its outbreak, and he survived its close by at least half-a-dozen years. And he was more than a mere contemporary. As a man of high birth, a member of the Periclean circle, and the holder of the chief political office in the Athenian state, the *strategia*, he was not only familiar with the business of administration and the conduct of military operations, but he possessed in addition a personal knowledge of those who played the principal part in the political life of the age. His exile in the year 424 afforded him opportunities of visiting the scenes of distant operations (e.g. Sicily) and of coming in contact with the actors on the other side. He himself tells us that he spared no pains to obtain the best information available in each case. He also tells us that

he began collecting materials for his work from the very beginning of the war. Indeed, it is probable that much of books i.-v. 24 was written soon after the Peace of Nicias (421), just as it is possible that the history of the Sicilian Expedition (books vi. and vii.) was originally intended to form a separate work. To the view, however, which has obtained wide support in recent years, that books i.-v. 22 and books vi. and vii. were separately published, the rest of book v. and book viii. being little more than a rough draught, composed after the author had adopted the theory of a single war of twenty-seven years' duration, of which the Sicilian Expedition and the operations of the years 431-421 formed integral parts, there seem to the present writer to be insuperable objections. The work, as a whole, appears to have been composed in the first years of the 4th century, after his return from exile in 404, when the material already in existence must have been revised and largely recast. There are exceedingly few passages, such as iv. 48, 5, which appear to have been overlooked in the process of revision. It can hardly be questioned that the impression left upon the reader's mind is that the point of view of the author, in all the books alike, is that of one writing after the fall of Athens.

The task of historical criticism in the case of the Peloponnesian War is widely different from its task in the case of the Persian Wars. It has to deal, not with facts as they appear in the traditions of an imaginative race, but with facts as they appeared to a scientific observer. Facts, indeed, are seldom in dispute. The question is rather whether facts of importance are omitted, whether the explanation of causes is correct, or whether the judgment of men and measures is just. Such inaccuracies as have been brought home to Thucydides on the strength, e.g. of epigraphic evidence, are, as a rule, trivial. His most serious errors relate to topographical details, in cases where he was dependent on the information of others. Sphacteria (see *PLYOS*) (see G. B. Grundy, *Journal of Hellenic Studies*, xvi., 1896, p. 1) is a case in point. Nor have the difficulties connected with the siege of Plataea been cleared up either by Grundy or by others (see Grundy, *Topography of the Battle of Plataea*, &c., 1894). Where, on the contrary, he is writing at first hand his descriptions of sites are surprisingly correct. The most serious charge as yet brought against his authority as to matters of fact relates to his account of the Revolution of the Four Hundred, which appears, at first sight, to be inconsistent with the documentary evidence supplied by Aristotle's *Constitution of Athens* (q.v.). It may be questioned, however, whether the documents have been correctly interpreted by Aristotle. On the whole, it is probable that the general course of events was such as Thucydides describes (see E. Meyer, *Forschungen*, ii. 406-436), though he failed to appreciate the position of Theramenes and the Moderate party, and was clearly misinformed on some important points of detail. With regard to the omission of facts, it is unquestionable that much is omitted that would not be omitted by a modern writer. Such omissions are generally due to the author's conception of his task. Thus the internal history of Athens is passed over as forming no part of the history of the war. It is only where the course of the war is directly affected by the course of political events (e.g. by the Revolution of the Four Hundred) that the internal history is referred to. However much it may be regretted that the relations of political parties are not more fully described, especially in book v., it cannot be denied that from his standpoint there is logical justification even for the omission of the ostracism of Hyperbolus. There are omissions, however, which are not so easily explained. Perhaps the most notable instance is that of the raising of the tribute in 425 B.C. (see *DELIAN LEAGUE*).

Nowhere is the contrast between the historical methods of Herodotus and Thucydides more apparent than in the treatment of the causes of events. The distinction between the occasion and the cause is constantly present to the mind of Thucydides, and it is his tendency to make too little rather than too much of the personal factor. Sometimes, however, it may be doubted whether his explanation of the causes of an event is adequate or correct. In tracing the causes of the Peloponnesian War itself.

modern writers are disposed to allow more weight to the commercial rivalry of Corinth; while in the case of the Sicilian expedition, they would actually reverse his judgment (ii. 65 ὁ δὲ Ζηκελίαν πλοῦς ὅς οὐ τοσοῦτον γυνώσκεις ἀμάρτυρα ἢ πρὸς οὐδὲ τρέφειν). To us it seems that the very idea of the expedition implied a gigantic miscalculation of the resources of Athens and of the difficulty of the task. His judgments of men and of measures have been criticized by writers of different schools and from different points of view. Grote criticized his verdict upon Cleon, while he accepted his estimate of the policy of Pericles. More recent writers, on the other hand, have accepted his view of Cleon, while they have selected for attack his appreciation alike of the policy and the strategy of Pericles. He has been charged, too, with failure to do justice to the statesmanship of Alcibiades.¹ There are cases, undoubtedly, in which the balance of recent opinion will be adverse to the view of Thucydides. There are many more in which the result of criticism has been to establish his view. That he should occasionally have been mistaken in his judgment and his views is certainly no detraction from his claim to greatness.

On the whole, it may be said that while the criticism of Herodotus, since Grote wrote, has tended seriously to modify our view of the Persian Wars, as well as of the earlier history, the criticism of Thucydides, in spite of its imposing bulk, has affected but slightly our view of the course of the Peloponnesian War. The labours of recent workers in this field have borne most fruit where they have been directed to subjects neglected by Thucydides, such as the history of political parties, or the organization of the empire (G. Gilbert's *Innere Geschichte Athens im Zeitalter des pel. Krieges* is a good example of such work).

In regard to Thucydides' treatment of the period between the Persian and Peloponnesian Wars (the so-called *Pentecontaetis*) it should be remembered that he does not profess to give, even in outline, the history of this period as a whole. The period is regarded simply as a prelude to the Peloponnesian War. There is no attempt to sketch the history of the Greek world or of Greece proper during this period. There is, indeed, no attempt to give a complete sketch of Athenian history. His object is to trace the growth of the Athenian Empire, and the causes that made the war inevitable. Much is therefore omitted not only in the history of the other Greek states, especially the Peloponnesian, but even in the history of Athens. Nor does Thucydides attempt an exact chronology. He gives us a few dates (e.g. surrender of Ithome, in the tenth year, i. 103; of Thasos, in the third year, i. 101; duration of the Egyptian expedition six years, i. 110; interval between Tanagra and Oenophyta 61 days, i. 108; revolt of Samos, in the sixth year after the Thirty Years' Truce, i. 115), but from these data alone it would be impossible to reconstruct the chronology of the period. In spite of all that can be gleaned from our other authorities, our knowledge of this, the true period of Athenian greatness, must remain slight and imperfect as compared with our knowledge of the next thirty years.

Of the secondary authorities for this period the two principal ones are Diodorus (xi. 38 to xii. 37) and Plutarch. Diodorus is of value chiefly in relation to Sicilian affairs, to which *Diodorus* he devotes about a third of this section of his work and for which he is almost our sole authority. His source for Sicilian history is the Sicilian writer Timaeus (q.v.), an author of the 3rd century B.C. For the history of Greece Proper during the *Pentecontaetia* Diodorus contributes comparatively little of importance. Isolated notices of particular events (e.g. the *Synœcism* of Elis, 471 B.C., or the foundation of Amphipolis, 437 B.C.), which appear to be derived from a chronological writer, may generally be trusted. The greater part of his narrative is, however, derived from Ephorus, who appears to have had before him little authentic information for this period of Greek history other than that afforded by Thucydides' work. Four of Plutarch's *Lives* are concerned with this period, viz. *Themistocles*, *Aristides*, *Cimon* and *Pericles*. From the *Aristides* little can

¹ For a defence of Thucydides' judgment on all three statesmen, see E. Meyer, *Forschungen*, ii. 296-379.

be gained. Plutarch, in this biography, appears to be mainly dependent upon Idomeneus of Lampsacus, an excessively untrustworthy writer of the 3rd century B.C., who is probably *Plutarch* to be credited with the invention of the oligarchical conspiracy at the time of the battle of Plataea (ch. 13), and of the decree of Aristides, rendering all four classes of citizens eligible for the archonship (ch. 22). The *Cimon*, on the other hand, contains much that is valuable; such as, e.g. the account of the battle of the Eurymedon (chs. 12 and 13). To the *Pericles* we owe several quotations from the Old Comedy. Two other of the *Lives*, *Lycurgus* and *Solon*, are amongst our most important sources for the early history of Sparta and Athens respectively. Of the two (besides *Pericles*) which relate to the Peloponnesian War, *Alcibiades* adds little to what can be gained from Thucydides and Xenophon; the *Nicias*, on the other hand, supplements Thucydides' narrative of the Sicilian expedition with many valuable details, which, it may safely be assumed, are derived from the contemporary historian, Philistus of Syracuse. Amongst the most valuable material afforded by Plutarch are the quotations, which occur in almost all the *Lives*, from the collection of Athenian decrees (*ἡψησμένων συναγωγῆς*) formed by the Macedonian writer Craterus, in the 3rd century B.C. Two other works may be mentioned in connexion with the history of Athens. For the history of the Athenian Constitution down to the end of the 5th century B.C. Aristotle's *Constitution of Athens* (q.v.) is our chief authority. *The constitution.* The other *Constitution of Athens*, erroneously attributed to Xenophon, a tract of singular interest both on literary and historical grounds, throws a good deal of light on the internal condition of Athens, and on the system of government, both of the state and of the empire, in the age of the Peloponnesian War, during the earlier years of which it was composed.

To the literary sources for the history of Greece, especially of Athens, in the 5th century B.C. must be added the epigraphic. Few inscriptions have been discovered which date *Inscriptions.* back beyond the Persian Wars. For the latter half of the 5th century they are both numerous and important. Of especial value are the series of Quota-lists, from which can be calculated the amount of tribute paid by the subject-allies of Athens from the year 454 B.C. onwards. The great majority of the inscriptions of this period are of Athenian origin. Their value is enhanced by the fact that they relate, as a rule, to questions of organization, finance and administration, as to which little information is to be gained from the literary sources.

For the period between the Persian and Peloponnesian Wars Busolt, *Griechische Geschichte*, iii. 1, is indispensable. Hill's *Sources of Greek History*, B.C. 478-431 (Oxford, 1897) is excellent. It gives the most important inscriptions in a convenient form.

III. *The 4th Century to the Death of Alexander*.—Of the historians who flourished in the 4th century the sole writer whose works have come down to us is Xenophon. It is a singular *Xenophon.* accident of fortune that neither of the two authors, who at once were most representative of their age and did most to determine the views of Greek history current in subsequent generations, Ephorus (q.v.) and Theopompus (q.v.), should be extant. It was from them, rather than from Herodotus, Thucydides or Xenophon that the Roman world obtained its knowledge of the history of Greece in the past, and its conception of its significance. Both were pupils of Isocrates, and both, therefore, bred up in an atmosphere of rhetoric. Hence their popularity and their influence. The scientific spirit of Thucydides was alien to the temper of the 4th century, and hardly more congenial to the age of Cicero or Tacitus. To the rhetorical spirit, which is common to both, each added defects peculiar to himself. Theopompus is a strong partisan, a sworn foe to Athens and to Democracy. Ephorus, though a military historian, is ignorant of the art of war. He is also incredibly careless and uncritical. It is enough to point to his description of the battle of the Eurymedon (Diodorus xi. 60-62), in which, misled by an epigram, which he supposed to relate to this engagement (it really refers to the Athenian victory off Salamis in Cyprus, 449 B.C.), he

makes the coast of Cyprus the scene of Cimon's naval victory, and finds no difficulty in putting it on the same day as the victory on shore on the banks of the Eurymedon, in Pamphylia. Only a few fragments remain of either writer, but Theopompus (*q.v.*) was largely used by Plutarch in several of the *Lives*, while Ephorus continues to be the main source of Diodorus' history, as far as the outbreak of the Sacred War (Fragments of Ephorus in Müller's *Fragmenta historicorum Graecorum*, vol. i.; of Theopompus in *Hellenica Oxyrhynchia, cum Theopompi et Cratippi fragmentis*, ed. B. P. Grenfell and A. S. Hunt, 1900).

It may be at least claimed for Xenophon (*q.v.*) that he is free from all taint of the rhetorical spirit. It may also be claimed for him that, as a witness, he is both honest and well-informed. But, if there is no justification for the charge of deliberate falsification, it cannot be denied that he had strong political prejudices, and that his narrative has suffered from them. His historical writings are the *Anabasis*, an account of the expedition of the Ten Thousand, the *Hellenica* and the *Agésilauis*, a eulogy of the Spartan king. Of these the *Hellenica* is far the most important for the student of history. It consists of two distinct parts (though there is no ground for the theory that the two parts were separately written and published), books i. and ii., and books iii. to vii. The first two books are intended as a continuation of Thucydides' work. They begin, quite abruptly, in the middle of the Attic year 411/10, and they carry the history down to the fall of the Thirty, in 403. Books iii. to vii., the *Hellenica* proper, cover the period from 402 to 362, and give the histories of the Spartan and Theban hegemonies down to the death of Epaminondas. There is thus a gap of two years between the point at which the first part ends and that at which the second part begins. The two parts differ widely, both in their aim and in the arrangement of the material. In the first part Xenophon attempts, though not with complete success, to follow the chronological method of Thucydides, and to make each successive spring, when military and naval operations were resumed after the winter's interruption, the starting-point of a fresh section. The resemblance between the two writers ends, however, with the outward form of the narrative. All that is characteristic of Thucydides is absent in Xenophon. The latter writer shows neither skill in portraiture, nor insight into motives. He is deficient in the sense of proportion and of the distinction between occasion and cause. Perhaps his worst fault is a lack of imagination. To make a story intelligible it is necessary sometimes to put oneself in the reader's place, and to appreciate his ignorance of circumstances and events which would be perfectly familiar to the actors in the scene or to contemporaries. It was not given to Xenophon, as it was to Thucydides, to discriminate between the circumstances that are essential and those that are not essential to the comprehension of the story. In spite, therefore, of its wealth of detail, his narrative is frequently obscure. It is quite clear that in the trial of the generals, *e.g.*, something is omitted. It may be supplied as Diodorus has supplied it (xiii. 201), or it may be supplied otherwise. It is probable that, when under cross-examination before the council, the generals, or some of them, disclosed the commission given to Theramenes and Thrasylbulus. The important point is that Xenophon himself has omitted to supply it. As it stands his narrative is unintelligible. In the first two books, though there are omissions (*e.g.* the loss of Nisaea, 409 B.C.), they are not so serious as in the last five, nor is the bias so evident. It is true that if the account of the rule of the Thirty given in Aristotle's *Constitution of Athens* is accepted, Xenophon must have deliberately misrepresented the course of events to the prejudice of Theramenes. But it is at least doubtful whether Aristotle's version can be sustained against Xenophon's, though it may be admitted, not only that there are mistakes as to details in the latter writer's narrative, but that less than justice is done to the policy and motives of the "Buskin." The *Hellenica* was written, it should be remembered, at Corinth, after 362. More than forty years had thus elapsed since the events recorded in the first two books,

and after so long an interval accuracy of detail, even where the detail is of importance, is not always to be expected.¹ In the second part the chronological method is abandoned. A subject once begun is followed out to its natural ending, so that sections of the narrative which are consecutive in order are frequently parallel in point of date. A good example of this will be found in book iv. In chapters 2 to 7 the history of the Corinthian war is carried down to the end of 390, so far as the operations on land are concerned, while chapter 8 contains an account of the naval operations from 394 to 388. In this second part of the *Hellenica* the author's disqualifications for his task are more apparent than in the first two books. The more he is acquitted of bias in his selection of events and in his omissions, the more clearly does he stand convicted of lacking all sense of the proportion of things. Down to Leuctra (371 B.C.) Sparta is the centre of interest, and it is of the Spartan state alone that a complete or continuous history is given. After Leuctra, if the point of view is no longer exclusively Spartan, the narrative of events is hardly less incomplete. Throughout the second part of the *Hellenica* omissions abound which it is difficult either to explain or justify. The formation of the Second Athenian Confederacy of 377 B.C., the foundation of Megalopolis and the restoration of the Messenian state are all left unrecorded. Yet the writer who passes them over without mention thinks it worth while to devote more than one-sixth of an entire book to a chronicle of the unimportant feats of the citizens of the petty state of Phlius. Nor is any attempt made to appraise the policy of the great Theban leaders, Pelopidas and Epaminondas. The former, indeed, is mentioned only in a single passage, relating to the embassy to Susa in 368; the latter does not appear on the scene till a year later, and receives mention but twice before the battle of Mantinea. An author who omits from his narrative some of the most important events of his period, and elaborates the portraiture of an Agesilaus while not attempting the bare outline of an Epaminondas, may be honest; he may even write without a consciousness of bias; he certainly cannot rank among the great writers of history.²

For the history of the 4th century Diodorus assumes a higher degree of importance than belongs to him in the earlier periods. This is partly to be explained by the deficiencies of Diodorus. Xenophon's *Hellenica*, partly by the fact that for the interval between the death of Epaminondas and the accession of Alexander we have in Diodorus alone a continuous narrative of events. Books xiv. and xv. of his history include the period covered by the *Hellenica*. More than half of book xiv. is devoted to the history of Sicily and the reign of Dionysius, the tyrant of Syracuse. For this period of Sicilian history he is, practically, our sole authority. In the rest of the book, as well as in book xv., there is much of value, especially in the notices of Macedonian history. Thanks to Diodorus we are enabled to supply many of the omissions of the *Hellenica*. Diodorus is, *e.g.*, our sole literary authority for the Athenian naval confederation of 377. Book xvi. must rank, with the *Hellenica* and Arrian's *Anabasis*, as one of the three principal authorities for this century, so far, at least, as works of an historical character are concerned. It is our authority for the Social and the Sacred Wars, as well as for the reign of Philip. It is a curious irony of fate that, for what is perhaps the most momentous epoch in the history of Greece, we should have to turn to a writer of such inferior capacity. For this period his material is better and his importance greater: his intelligence is as limited as ever. Who but Diodorus would be capable of narrating the siege and capture of Methone twice over, once under the year 354, and again under the year 352 (xvi. 31 and 34; cf. xii. 35 and 42; Archidamus (*q.v.*) dies in 434, commands Peloponnesian army in 431); or of giving three different numbers of years (eleven, ten and nine) in three different passages (chs. 14, 23 and 59) for the length of the

¹ On the discrepancies between Xenophon's account of the Thirty, and Aristotle's, see G. Busolt, *Hermes* (1898), pp. 71-86.

² The fragment of the New Historian (*Oxyrhynchus Papyri*, vol. v.) affords exceedingly important material for the criticism of Xenophon's narrative. (See THEOPOMPUS.)

Sacred War; or of asserting the conclusion of peace between Athens and Philip in 340, after the failure of his attack on Perinthus and Byzantium? Amongst the subjects which are omitted is the Peace of Philocrates. For the earlier chapters, which bring the narrative down to the outbreak of the Sacred War, Ephorus, as in the previous book, is Diodorus' main source. His source for the rest of the book, i.e. for the greater part of Philip's reign, cannot be determined. It is generally agreed that it is not the *Philippica* of Theopompus.

For the reign of Alexander our earliest extant authority is Diodorus, who belongs to the age of Augustus. Of the others,

Historians of Alexander's reign.
Q. Curtius Rufus, who wrote in Latin, lived in the reign of the emperor Claudius, Arrian and Plutarch in the 2nd century A.D. Yet Alexander's reign is one of the best known periods of ancient history.

The Peloponnesian War and the twenty years of Roman history which begin with 63 B.C. are the only two periods which we can be said to know more fully or for which we have more trustworthy evidence. For there is no period of ancient history which was recorded by a larger number of contemporary writers, or for which better or more abundant materials were available. Of the writers actually contemporary with Alexander there were five of importance—Ptolemy, Aristobulus, Callisthenes, Onesicritus and Nearchus; and all of them occupied positions which afforded exceptional opportunities of ascertaining the facts. Four of them were officers in Alexander's service. Ptolemy, the future king of Egypt, was one of the *somatophylaces* (we may, perhaps, regard them as corresponding to Napoleon's marshals); Aristobulus was also an officer of high rank (see Arrian, *Anab.* vi. 29. 10); Nearchus was admiral of the fleet which surveyed the Indus and the Persian Gulf, and Onesicritus was one of his subordinates. The fifth, Callisthenes, a pupil of Aristotle, accompanied Alexander on his march down to his death in 327 and was admitted to the circle of his intimate friends. A sixth historian, Cleitarchus, was possibly also a contemporary; at any rate he is not more than a generation later. These writers had at their command a mass of official documents, such as the *βασίλειαι ἐφημερίδες*—the *Gazette and Court Circular* combined—edited and published after Alexander's death by his secretary, Eumenes of Cardia; the *στραβούλ*, or records of the marches of the armies, which were carefully measured at the time; and the official reports on the conquered provinces. That these documents were made use of by the historians is proved by the references to them which are to be found in Arrian, Plutarch and Strabo; e.g. Arrian, *Anab.* vii. 25 and 26, and Plutarch, *Alexander* 76 (quotation from the *βασίλειαι ἐφημερίδες*); Strabo xv. 723 (reference to the *στραβούλ*), ii. 69 (reports drawn up on the various provinces). We have, in addition, in Plutarch numerous quotations from Alexander's correspondence with his mother, Olympias, and with his officers. The contemporary historians may be roughly divided into two groups. On the one hand there are Ptolemy and Aristobulus, who, except in a single instance, are free from all suspicion of deliberate invention. On the other hand, there are Callisthenes, Onesicritus and Cleitarchus, whose tendency is rhetorical. Nearchus appears to have allowed full scope to his imagination in dealing with the wonders of India, but to have been otherwise veracious. Of the extant writers Arrian (q.v.) is incomparably the most valuable. His merits are twofold. As the commander of Roman legions and the author of a work on tactics, he combined a practical with a theoretical knowledge of the military art, while the writers whom he follows in the *Anabasis* are the two most worthy of credit, Ptolemy and Aristobulus. We may well hesitate to call in question the authority of writers who exhibit an agreement which it would be difficult to parallel elsewhere in the case of two independent historians. It may be inferred from Arrian's references to them that there were only eleven cases in all in which he found discrepancies between them. The most serious drawback which can be alleged against them is an inevitable bias in Alexander's favour. It would be only natural that they should pass over in silence the worst blots on their great commander's fame. Next in value to the *Anabasis*

comes Plutarch's *Life of Alexander*, the merits of which, however, are not to be gauged by the influence which it has exercised upon literature. The *Life* is a valuable supplement to the *Anabasis*, partly because Plutarch, as he is writing biography rather than history (for his conception of the difference between the two see the famous preface, *Life of Alexander*, ch. i.), is concerned to record all that will throw light upon Alexander's character (e.g. his epigrammatic sayings and quotations from his letters); partly because he tells us much about his early life, before he became king, while Arrian tells us nothing. It is unfortunate that Plutarch writes in an uncritical spirit; it is hardly less unfortunate that he should have formed no clear conception and drawn no consistent picture of Alexander's character. Book xvii. of Diodorus and the *Historiae Alexandri* of Curtius Rufus are thoroughly rhetorical in spirit. It is probable that in both cases the ultimate source is the work of Cleitarchus.

It is towards the end of the 5th century that a fresh source of information becomes available in the speeches of the orators, the earliest of whom is Antiphon (d. 411 B.C.). Lysias is of great importance for the history of the Thirty (see the speeches against Eratosthenes and Agoratus), and a good deal may be gathered from Andocides with regard to the last years of the 5th and the opening years of the next century. At the other end of this period Lycurgus, Hyperides and Dinarchus throw light upon the time of Philip and Alexander. The three, however, who are of most importance to the historian are Isocrates, Aeschines and Demosthenes. Isocrates (q.v.), whose long life (436–338) more than spans the interval between the outbreak of the Peloponnesian War and the triumph of Macedon at Chaeronea, is one of the most characteristic figures in the Greek world of his day. To comprehend that world the study of Isocrates is indispensable; for in an age dominated by rhetoric he is the prince of rhetoricians. It is difficult for a modern reader to do him justice, so alien is his spirit and the spirit of his age from ours. It must be allowed that he is frequently monotonous and prolix; at the same time it must not be forgotten that, as the most famous representative of rhetoric, he was read from one end of the Greek world to the other. He was the friend of Evagoras and Archidamus, of Dionysius and Philip; he was the master of Aeschines and Lycurgus amongst orators and of Ephorus and Theopompus amongst historians. No other contemporary writer has left so indelible a stamp upon the style and the sentiment of his generation. It is a commonplace that Isocrates is the apostle of Panhellenism. It is not so generally recognized that he is the prophet of Hellenism. A passage in the *Panegyricus* (§ 50 *ὅστε τὸ τῶν Ἑλλήνων ὄνομα μῆτε τοῦ γένους ἀλλὰ τῆς διαπολιτικῆς ἐστὶν ἐκείνου καὶ μᾶλλον Ἑλλήνας καλεῖσθαι τοὺς τῆς παιδείας τῆς ἡμετέρας ἢ τοὺς τῆς κοινῆς φύσεως μετέχοντας*) is the key to the history of the next three centuries. Doubtless he had no conception of the extent to which the East was to be hellenized. He was, however, the first to recognize that it would be hellenized by the diffusion of Greek culture rather than of Greek blood. His Panhellenism was the outcome of his recognition of the new forces and tendencies which were at work in the midst of a new generation. When Greek culture was becoming more and more international, the exaggeration of the principle of autonomy in the Greek political system was becoming more and more absurd. He had sufficient insight to be aware that the price paid for this autonomy was the domination of Persia; a domination which meant the servitude of the Greek states across the Aegean and the demoralization of Greek political life at home. His Panhellenism led him to a more liberal view of the distinction between what was Greek and what was not than was possible to the intenser patriotism of a Demosthenes. In his later orations he has the courage not only to pronounce that the day of Athens as a first-rate power is past, but to see in Philip the needful leader in the crusade against Persia. The earliest and greatest of his political orations is the *Panegyricus*, published in 380 B.C., midway between the peace of Antalcidas and Leuctra. It is his *apologia* for Panhellenism. To the period of the Social War belongs the *De pace* (355 B.C.) and the *Areopagiticus* (354 B.C.).

both of great value as evidence for the internal conditions of Athens at the beginning of the struggle with Macedon. The *Plataicus* (373 B.C.) and the *Archidamus* (366 B.C.) throw light upon the politics of Boeotia and the Peloponnese respectively. The *Panathenaicus* (339 B.C.), the child of his old age, contains little that may not be found in the earlier orations. The *Philippus* (346 B.C.) is of peculiar interest, as giving the views of the Macedonian party.

Not the least remarkable feature in recent historical criticism is the reaction against the view which was at one time almost universally accepted of the character, statesmanship and authority of the orator Demosthenes (q.v.).

Demosthenes. During the last quarter of a century his character and statesmanship have been attacked, and his authority impugned, by a series of writers of whom Holm and Beloch are the best known. With the estimate of his character and statesmanship we are not here concerned. With regard to his value as an authority for the history of the period, it is to his speeches, and to those of his contemporaries, Aeschines, Hypereides, Dinarchus and Lycurgus, that we owe our intimate knowledge, both of the working of the constitutional and legal systems, and of the life of the people, at this period of Athenian history. From this point of view his value can hardly be overestimated. As a witness, however, to matters of fact, his authority can no longer be rated as highly as it once was, e.g. by Schaefer and by Grote. The orator's attitude towards events, both in the past and in the present, is inevitably a different one from the historian's. The object of a Thucydides is to ascertain a fact, or to exhibit it in its true relations. The object of a Demosthenes is to make a point, or to win his case. In their dealings with the past the orators exhibit a levity which is almost inconceivable to a modern reader. Andocides, in a passage of his speech *On the Mysteries* (§ 107), speaks of Marathon as the crowning victory of Xerxes' campaign; in his speech *On the Peace* (§ 3) he confuses Miltiades with Cimon, and the Five Years' Peace with the Thirty Years' Truce. Though the latter passage is a mass of absurdities and confusions, it was so generally admired that it was incorporated by Aeschines in his speech *On the Embassy* (§§ 172-176). If such was their attitude towards the past; if, in order to make a point, they do not hesitate to pervert history, is it likely that they would conform to a higher standard of veracity in their statements as to the present—as to their contemporaries, their rivals or their own actions? When we compare different speeches of Demosthenes, separated by an interval of years, we cannot fail to observe a marked difference in his statements. The farther he is from the events, the bolder are his mis-statements. It is only necessary to compare the speech *On the Crown* with that *On the Embassy*, and this latter speech with the *Philippics* and *Olynthiacs*, to find illustrations. It has come to be recognized that no statement as to a matter of fact is to be accepted, unless it receives independent corroboration, or unless it is admitted by both sides. The speeches of Demosthenes may be conveniently divided into four classes according to their dates. To the pre-Philippic period belong the speeches *On the Symmories* (354 B.C.), *On Megalopolis* (352 B.C.), *Against Aristocrates* (351 B.C.), and, perhaps, the speech *On Rhodes* (? 351 B.C.). These speeches betray no consciousness of the danger threatened by Philip's ambition. The policy recommended is one based upon the principle of the balance of power. To the succeeding period, which ends with the peace of Philocrates (346 B.C.), belong the *First Philippic* and the three *Olynthiacs*. To the period between the peace of Philocrates and Chaeronea belong the speech *On the Peace* (346 B.C.), the *Second Philippic* (344 B.C.), the speeches *On the Embassy* (344 B.C.) and *On the Chersonese* (341 B.C.), and the *Third Philippic*. The masterpiece of his genius, the speech *On the Crown*, was delivered in 330 B.C., in the reign of Alexander. Of the three extant speeches of Aeschines (q.v.) that *On the Embassy* is of great value, as enabling us to correct the mis-statements of Demosthenes. For the period from the death of Alexander to the fall of Corinth (323-146 B.C.) our literary authorities are singularly defective. For the Diadochi Diodyrus (books xviii.-xx.) is our chief source. These books form the

most valuable part of Diodorus' work. They are mainly based upon the work of Hieronymus of Cardia, a writer who combined exceptional opportunities for ascertaining the truth (he was in the service first of Eumenes, and then of Antigonus) with an exceptional sense of its importance. Hieronymus ended his history at the death of Pyrrhus (272 B.C.), but, unfortunately, book xx. of Diodorus' work carries us no farther than 303 B.C., and of the later books we have but scanty fragments. The narrative of Diodorus may be supplemented by the fragments of Arrian's *History of the events after Alexander's death* (which reach, however, only to 321 B.C.), and by Plutarch's *Lives of Eumenes* and of *Demetrius*. For the rest of the 3rd century and the first half of the 2nd we have his *Lives of Pyrrhus*, of *Aratus*, of *Philopoemen*, and of *Agis* and *Cleomenes*. For the period from 220 B.C. onwards Polybius (q.v.) is our chief authority (see *ROMAN ANCIENT HISTORY*, section "Authorities"). In a period in which the literary sources are so scanty great weight attaches to the epigraphic and numismatic evidence.

BIBLIOGRAPHY.—The literature which deals with the history of Greece, in its various periods, departments and aspects, is of so vast a bulk that all that can be attempted here is to indicate the most important and most accessible works.

General Histories of Greece.—Down to the middle of the 19th century the only histories of Greece deserving of mention were the products of English scholarship. The two earliest of these were published about the same date, towards the end of the 18th century, nearly three-quarters of a century before any history of Greece, other than a mere compendium, appeared on the Continent. John Gillies' *History of Greece* was published in 1786, Mitford's in 1784. Both works were composed with a political bias and a political object. Gillies was a Whig. In the dedication (to George III.) he expresses the view that "the History of Greece exposes the dangerous turbulence of Democracy, and arraigns the despotism of Tyrants, while it evinces the inestimable benefits, resulting to Liberty itself, from the steady operation of well-regulated monarchy." Mitford was a Tory, who thought to demonstrate the evils of democracy from the example of the Athenian state. His *History*, in spite of its bias, was a work of real value. More than fifty years elapsed between Mitford's work and Thirlwall's. Connop Thirlwall, fellow of Trinity College, Cambridge, afterwards bishop of St David's, brought a sound judgment to the aid of ripe scholarship. His *History of Greece*, published in 1835-1838 (8 vols.), is entirely free from the controversial tone of Mitford's volumes. Ten years later (1846) George Grote published the first volumes of his history, which was not completed (in 12 vols.) till 1856. Grote, like Mitford, was a politician—an ardent Radical, with republican sympathies. It was in order to refute the slanders of the Tory partisan that he was impelled to write a history of Greece, which should do justice to the greatest democracy of the ancient world, the Athenian state. Thus, in the case of three of these four writers, the interest in their subject was mainly political. Incomparably the greatest of these works is Grote's. Grote had his faults and his limitations. His prejudices are strong, and his scholarship is weak; he had never visited Greece, and he knew little or nothing of Greek art; and, at the time he wrote, the importance of coins and inscriptions was imperfectly apprehended. In spite of every defect, however, his work is the greatest history of Greece that has yet been written. It is not too much to say that nobody knows Greek history till he has mastered Grote. No history of Greece has since appeared in England on a scale at all comparable to that of Grote's work. The most important of the more recent ones is that by J. B. Bury (1 vol., 1900), formerly fellow of Trinity College, Dublin, afterwards Regius Professor of Modern History at Cambridge. Mitford and Bury end with the death of Alexander; Gillies and Grote carry on the narrative a generation farther; while Thirlwall's work extends to the absorption of Greece in the Roman Empire (146 B.C.).

While in France the *Histoire des Grecs* (ending at 146 B.C.) of Victor Duruy (new edition, 2 vols., 1883), Minister of Public Instruction under Napoleon III., is the only one that need be mentioned, in Germany there has been a succession of histories of Greece since the middle of the 19th century. Kortüm's *Geschichte Griechenlands* (3 vols., 1854), a work of little merit, was followed by Max Duncker's *Geschichte der Griechen* (vols. 1 and 2 published in 1856; vols. 1 and 2, Neue Folge, which bring the narrative down to the death of Pericles, in 1884; the two former volumes form vols. 3, 6 and 7 of his *Geschichte des Alterthums*), and by the *Griechische Geschichte* of Ernst Curtius (3 vols., 1857-1867). An English translation of Duncker, by S. F. Alleyne, appeared in 1883 (2 vols., Bentley), and of Curtius, by A. W. Ward (5 vols., Bentley, 1868-1873). Among more recent works may be mentioned the *Griechische Geschichte* of Adolf Holm (4 vols., Berlin, 1886-1894; English translation by F. Clarke, 4 vols., Macmillan, 1894-1896), and histories with the same title by Julius Beloch (3 vols., Strassburg, 1893-1904) and Georg Busolt (2nd ed., 3 vols., Gotha, 1893-1904). Holm carries on the narrative to 30 B.C., Beloch to 217 B.C., Busolt to Chaeronea

(338 B.C.).¹ Busolt's work is entirely different in character from any other history of Greece. The writer's object is to refer in the notes (which constitute five-sixths of the book) to the views of every writer in any language upon every controverted question. It is absolutely indispensable, as a work of reference, for any serious study of Greek history. The ablest work since Grote's is Eduard Meyer's *Geschichte des Altertums*, of which 5 vols. (Stuttgart and Berlin, 1888-1902) have appeared, carrying the narrative down to the death of Epaminondas (362 B.C.). Vols. 2-5 are principally concerned with Greek history. It must be remembered that, partly owing to the literary finds and the archaeological discoveries of the last thirty years, and partly owing to the advance made in the study of epigraphy and numismatics, all the histories published before those of Busolt, Beloch, Meyer and Bury are out of date.

Works bearing on the History of Greece.—Earlier works and editions are omitted, except in the case of a work which has not been superseded.

Introductions.—C. Wachsmuth, *Einführung in das Studium der alten Geschichte* (1 vol., Leipzig, 1895); E. Meyer, *Forschungen zur alten Geschichte* (2 parts, Halle, 1892-1899; quite indispensable); J. B. Bury, *The Ancient Greek Historians* (London, 1909).

Constitutional History and Institutions.—G. F. Schömann, *Griechische Altertümer* (2 vols., Berlin, 1855-1899; vol. 1, tr. by E. G. Hardy and J. S. Mann, Rivingtons, 1880); G. Gilbert, *Griechische Staatsaltertümer* (2nd ed., 2 vols., Leipzig, 1893; vol. 1, tr. by E. J. Brooks and T. Nicklin, Swan Sonnenschein, 1895); K. F. Hermann, *Lehrbuch der griechischen Antiquitäten* (6th ed., 4 vols., Freiburg, 1882-1896); Müller, *Handbuch der klassischen Altertumswissenschaft* (9 vols., Nördlingen, 1886, in progress; several of the volumes are concerned with Greek history); J. H. Lipsius, *Das attische Recht und Rechtsverfahren* (Leipzig, 1905, in progress); A. H. J. Greenidge, *Handbook of Greek Constitutional History* (1 vol., Macmillan, 1896); Pauly-Wisowa, *Realencyclopädie der klassischen Altertumswissenschaft* (Stuttgart, 1894 foll.).

Geography.—E. H. Bunbury, *History of Ancient Geography amongst the Greeks and Romans* (2nd ed., 2 vols., Murray, 1883); W. M. Leake, *Travels in the Morea* (3 vols., 1830), and *Travels in Northern Greece* (4 vols., 1834); H. F. Tozer, *Lectures on the Geography of Greece* (1 vol., Murray, 1873), and *History of Ancient Geography* (1 vol., Cambridge, 1897); J. P. Mahaffy, *Rambles and Studies in Greece* (3rd ed., 1 vol., Macmillan, 1887, an admirable book); C. Burman, *Geographie von Griechenland* (2 vols., Leipzig, 1872); H. Berger, *Geschichte der wissenschaftlichen Erdkunde der Griechen* (4 parts, Leipzig, 1887-1893); Ernst Curtius, *Peloponnesus* (2 vols., Göttingen, 1850-1851).

Epigraphy and Numismatics.—*Corpus Inscriptionum Atticarum* (Berlin, 1873, in progress); *Corpus Inscriptionum Graecarum* (Berlin, 1892, in progress). The following selections of Greek inscriptions may be mentioned: E. F. Hicks and C. F. Hill, *Manual of Greek Historical Inscriptions* (new ed., 1 vol., Oxford, 1901); W. Dittenberger, *Sylloge Inscriptionum Graecarum* (2nd ed., 2 vols., Berlin, 1898); C. Michel, *Recueil d'inscriptions grecques* (Paris, 1900). Among works on numismatics the English reader may refer to B. V. Head, *Historia numorum* (1 vol., Oxford, 1887); G. F. Hill, *Handbook of Greek and Roman Coins* (1 vol., Macmillan, 1899), as well as to the *British Museum Catalogue of Greek Coins*. In French the most important general work is the *Monnaies grecques* of F. Imhoof-Blumer (Paris, 1883).

Chronology, Trade, War, Social Life, &c.—H. F. Clinton, *Fasti Hellenici* (3rd ed., 3 vols., Oxford, 1841, a work of which English scholarship may well be proud; it is still invaluable for the study of Greek chronology); B. Büchsenhütz, *Besitz und Erwerb im griechischen Altertum* (1 vol., Halle, 1869; this is still the best book on Greek commerce); J. Beloch, *Die Bevölkerung der griechisch-römischen Welt* (1 vol., Leipzig, 1886); W. Rüstow and H. Köchly, *Geschichte des griechischen Kriegswesens* (1 vol., Aarau, 1852); J. P. Mahaffy, *Social Life in Greece* (2nd ed., 1 vol., 1875). (E. M. W.)

b. Post-Classical: 146 B.C.-A.D. 1800

I. THE PERIOD OF ROMAN RULE.—(i) *Greece under the Republic* (146-27 B.C.). After the collapse of the Achaean League (q.v.) the Senate appointed a commission to reorganize Greece as a Roman dependency. Corinth, the chief centre of resistance, was destroyed and its inhabitants sold into slavery. In addition to this act of exemplary punishment, which may perhaps have been inspired in part by the desire to crush a commercial competitor, steps were taken to obviate future insurrections. The national and cantonal federations were dissolved, commercial intercourse between cities was restricted, and the government transferred from the democracies to the propertied classes, whose interests were bound up with Roman supremacy. In other respects few changes were made in existing institutions. Some favoured states like Athens and Sparta retained their full sovereign rights as *civitates liberae*, the other

¹Vol. iii. goes down to the end of the Peloponnesian War.

cities continued to enjoy local self-government. The ownership of the land was not greatly disturbed by confiscations, and though a tribute upon it was levied, this impost may not have been universal. General powers of supervision were entrusted to the governor of Macedonia, who could reserve cases of high treason for his decision, and in case of need send troops into the country. But although Greece was in the *provincia* of the Macedonian proconsul, in the sense of belonging to his sphere of command, its status was in fact more favourable than that of other provincial dependencies.

This settlement was acquiesced in by the Greek people, who had come to realize the hopelessness of further resistance. The internal disorder which was arising from the numerous disputes about property rights consequent upon the political revolutions was checked by the good offices of the historian Polybius, whom the Senate deputed to mediate between the litigants. The pacification of the country eventually became so complete that the Romans withdrew the former restrictions upon intercourse and allowed some of the leagues to revive. But its quiet was seriously disturbed during the first Mithradatic War (88-84 B.C.), when numerous Greek states sided with Mithradates (q.v.). The success which the invader experienced in detaching the Greeks from Rome is partly to be explained by the skillful way in which his agents incited the imperialistic ambitions of prominent cities like Athens, partly perhaps by his promises of support to the democratic parties. The result of the war was disastrous to Greece. Apart from the confiscations and exactions by which the Roman general L. Cornelius Sulla punished the disloyal communities, the extensive and protracted campaigns led Central Greece in a ruinous condition. During the last decades of the Roman republic European Greece was scarcely affected by contemporary wars nor yet exploited by Roman magistrates in the same systematic manner as most other provinces. Yet oppression by officials who traversed Greece from time to time and demanded lavish entertainments and presentations in the guise of *viaticum* or *aurum coronarium* was not unknown. Still greater was the suffering produced by the rapacity of Roman traders and capitalists: it is recorded that Sicily was reduced to sell its most cherished art treasures in order to satisfy its creditors. A more indirect but none the less far-reaching drawback to Greek prosperity was the diversion of trade which followed upon the establishment of direct communication between Italy and the Levant. The most lucrative source of wealth which remained to the European Greeks was pasturage in large domains, an industry which almost exclusively profited the richer citizens and so tended to widen the breach between capitalists and the poorer classes, and still further to pauperize the latter. The coast districts and islands also suffered considerably from swarms of pirates who, in the absence of any strong fleet in Greek waters, were able to obtain a firm footing in Crete and freely plundered the chief trading places and sanctuaries; the most notable of such visitations was experienced in 69 B.C. by the island of Delos. This evil came to an end with the general suppression of piracy in the Mediterranean by Pompey (67 B.C.), but the depopulation which it had caused in some regions is attested by the fact that the victorious admiral settled some of his captives on the desolated coast strip of Achaëa.

In the conflict between Julius Caesar and Pompey the Greeks provided the latter with a large part of his excellent fleet. In 48 B.C. the decisive campaign of the war was fought on Greek soil, and the resources of the land were severely taxed by the requisitions of both armies. As a result of Caesar's victory at Pharsalus, the whole country fell into his power; the treatment which it received was on the whole lenient, though individual cities were punished severely. After the murder of Caesar the Greeks supported the cause of Brutus (42 B.C.), but were too weak to render any considerable service. In 39 B.C. the Peloponnese for a short time was made over to Sextus Pompeius. During the subsequent period Greece remained in the hands of M. Antonius (Mark Antony), who imposed further exactions in order to defray the cost of his wars. The extensive levies which

be made in 31 B.C. for his campaign against Octavian, and the contributions which his gigantic army required, exhausted the country's resources so completely that a general famine was prevented only by Octavian's prompt action after the battle of Actium in distributing supplies of grain and evacuating the land with all haste. The depopulation which resulted from the civil wars was partly remedied by the settlement of Italian colonists at Corinth and Patrae by Julius Caesar and Octavian; on the other hand, the foundation of Nicopolis (q.v.) by the latter merely had the effect of transferring the people from the country to the city.

(ii.) *The Early Roman Empire* (27 B.C.—A.D. 323).—Under the emperor Augustus Thessaly was incorporated with Macedonia; the rest of Greece was converted into the province of Achaea, under the control of a senatorial praefectus resident at Corinth. Many states, including Athens and Sparta, retained their rights as free and nominally independent cities. The provincials were encouraged to send delegates to a communal synod (*συνδρ τῶν Ἀχαιῶν*) which met at Argos to consider the general interests of the country and to uphold national Hellenic sentiment; the Delphic amphictyony was revived and extended so as to represent in a similar fashion northern and central Greece.

Economic conditions did not greatly improve under the empire. Although new industries sprang up to meet the needs of Roman luxury, and Greek marble, textiles, and table delicacies were in great demand, the only cities which retained a really flourishing trade were the Italian communities of Corinth and Patrae. Commerce languished in general, and the soil was mainly abandoned to pasturage. Though certain districts retained a measure of prosperity, e.g. Thessaly, Phocis, Elis, Argos and Laconia, huge tracts stood depopulated and many notable cities had sunk into ruins; Aetolia, Acarnania and Epirus never recovered from the effects of former wars and from the withdrawal of their surviving inhabitants into Nicopolis. Such wealth as remained was amassed in the hands of a few great landowners and capitalists; the middle class continued to dwindle, and large numbers of the people were reduced to earning a precarious subsistence, supplemented by frequent doles and largesses.

The social aspect of Greek life henceforward becomes its most attractive feature. After a long period of storm and stress, the European Hellenes had relapsed into a quiet and resigned frame of mind which stands in sharp contrast on the one hand with the energy and ability, and on the other with the vulgar intriguing of their Asiatic kinsmen. Seeing no future before them, the inhabitants were content to dwell in contemplation amid the glories of the past. National pride was fostered by the undisguised respect with which the leading Romans of the age treated Hellenic culture. And although this sentiment could degenerate into antiquarian pedantry and vanity, such as finds its climax in the diatribes of Apollonius of Tyana against the "barbarians," it prevented the nation from sinking into some of the worst vices of the age. A healthy social tone repressed extravagant luxury and the ostentatious display of wealth, and good taste long checked the spread of gladiatorial contests beyond the Italian community of Corinth. The most widespread abuse of that period, the adulation and adoration of emperors, was indeed introduced into European Greece and formed an essential feature of the proceedings at the Delphic amphictyony, but it never absorbed the energies of the people in the same way as it did in Asia. In order to perpetuate their old culture, the Greeks continued to set great store by classical education, and in Athens they possessed an academic centre which gradually became the chief university of the Roman empire. The highest representatives of this type of old-world refinement are to be found in Dio Chrysostom and especially in Plutarch of Chaeroneia (q.v.).

The relations between European Greece and Rome were practically confined to the sphere of scholarship. The Hellenes had so far lost their warlike qualities that they supplied scarcely any recruits to the army. They retained too much local patriotism to crowd into the official careers of senators or imperial servants. Although in the 1st century A.D. the astute Greek

man of affairs and the *Græculus æsuriens* of Juvenal abounded in Rome, both these classes were mainly derived from the less pure-blooded population beyond the Aegean.

The influx of Greek rhetoricians and professors into Italy during the 2nd and 3rd centuries was balanced by the large number of travellers who came to Greece to frequent its sanatoria, and especially to admire its works of art; the abundance in which these latter were preserved is strikingly attested in the extant record of Pausanias (about A.D. 170).

The experience of the Greeks under their earliest governors seems to have been unfortunate, for in A.D. 15 they petitioned Tiberius to transfer the administration to an imperial legate. This new arrangement was sanctioned, but only lasted till A.D. 44, when Claudius restored the province to the senate. The praefects of the later 1st and 2nd centuries were sometimes ill qualified for their posts, but cases of oppression are seldom recorded against them. The years 66 and 67 were marked by a visit of the emperor Nero, who made a prolonged tour through Greece in order to display his artistic accomplishments at the various national festivals. In return for the flattering reception accorded to him he bestowed freedom and exemption from tribute upon the country. But this favour was almost neutralized by the wholesale depredations which he committed among the chief collections of art. A scheme for cutting through the Corinthian isthmus and so reviving the Greek carrying trade was inaugurated in his presence, but soon abandoned.

As Nero's grant of self-government brought about a recrudescence of misplaced ambition and party strife, Vespasian revoked the gift and turned Achaea again into a province, at the same time burdening it with increased taxes. In the 2nd century a succession of genuinely phil-Hellenic emperors made serious attempts to revive the nation's prosperity. Important material benefits were conferred by Hadrian, who made a lengthy visit to Greece. Besides erecting useful public works in many cities, he relieved Achaea of its arrears of tribute and exempted it from various imposts. In order to check extravagance on the part of the free cities, he greatly extended the practice of placing them under the supervision of imperial functionaries known as *correctores*. Hadrian fostered national sentiment by establishing a new pan-Hellenic congress at Athens, while he gave recognition to the increasing ascendancy of Hellenic culture at Rome by his institution of the Athenaeum.

In the 3rd century the only political event of importance was the edict of Caracalla which threw open the Roman citizenship to large numbers of provincials. Its chief effect in Greece was to diminish the preponderance of the wealthy classes, who formerly had used their riches to purchase the franchise and so to secure exemption from taxation. The chief feature of this period is the renewal of the danger from foreign invasions. Already in 175 a tribe named Costoboci had penetrated into central Greece, but was there broken up by the local militia. In 253 a threatened attack was averted by the stubborn resistance of Thessalonica. In 267–268 the province was overrun by Gothic bands, which captured Athens and some other towns, but were finally repulsed by the Attic levies and exterminated with the help of a Roman fleet.

(iii.) *The Late Roman Empire*.—After the reorganization of the empire by Diocletian, Achaea occupied a prominent position in the "diocese" of Macedonia. Under Constantine I. it was included in the "praefecture" of Illyricum. It was subdivided into the "eparchies" of Hellas, Peloponnesus, Nicopolis and the islands, with headquarters at Thebes, Corinth, Nicopolis and Samos. Thessaly was incorporated with Macedonia. A complex hierarchy of imperial officials was now introduced, and the system of taxation elaborated so as to yield a steady revenue to the central power. The levying of the land-tax was imposed upon the *δεκάπρωτοι* or "ten leading men," who, like the Latin *decuriones*, were entrusted henceforth with the administration in most cities. The tendency to reduce all constitutions to the Roman municipal pattern became prevalent under the rulers of this period, and the greater number of them was stereotyped

by the general regulations of the Codex Theodosianus (438). Although the elevation of Constantinople to the rank of capital was prejudicial to Greece, which felt the competition of the new centre of culture and learning and had to part with numerous works of art destined to embellish its privileged neighbour, the general level of prosperity in the 4th century was rising. Commercial stagnation was checked by a renewed expansion of trade consequent upon the diversion of the trade routes to the east from Egypt to the Euxine and Aegean Seas. Agriculture remained in a depressed condition, and many small proprietors were reduced to serfdom; but the fiscal interests of the government called for the good treatment of this class, whose growth at the expense of the slaves was an important step in the gradual equalization of the entire population under the central despotism which restored solidarity to the Greek nation.

This prosperity received a sharp set-back by a series of unusually severe earthquakes in 375 and by the irruption of a host of Visigoths under Alaric (395-396), whom the imperial officers allowed to overrun the whole land unmolested and the local levies were unable to check. Though ultimately hunted down in Arcadia and induced to leave the province, Alaric had time to execute systematic devastations which crippled Greece for several decades. The arrears of taxation which accumulated in consequence were remitted by Theodosius II. in 478.

The emperors of the 4th century made several attempts to stamp out by edict the old pagan religion, which, with its accompaniment of festivals, oracles and mysteries, still maintained an outward appearance of vigour, and, along with the philosophy in which the intellectual classes found comfort, retained the affection of the Greeks. Except for the decree of Theodosius I. by which the Olympian games were interdicted (394), these measures had no great effect, and indeed were not rigorously enforced. Paganism survived in Greece till about 600, but the interchange of ideas and practices which the long-continued contact with Christianity had effected considerably modified its character. Hence the Christian religion, though slow in making its way, eventually gained a sure footing among a nation which accepted it spontaneously. The hold of the Church upon the Greeks was strengthened by the judicious manner in which the clergy, unsupported by official patronage and often out of sympathy with the Arian emperors, identified itself with the interests of the people. Though in the days when the orthodox Church found favour at court corruption spread among its higher branches, the clergy as a whole rendered conspicuous service in opposing the arbitrary interferences of the central government and in upholding the use of the Hellenic tongue, together with some rudiments of Hellenic culture.

The separation of the eastern and western provinces of the empire ultimately had an important effect in restoring the language and customs of Greece to their predominant position in the Levant. This result, however, was long retarded by the romanizing policy of Constantine and his successors. The emperors of the 5th and 6th centuries had no regard for Greek culture, and Justinian I. actively counteracted Hellenism by propagating Roman law in Greece, by impairing the powers of the self-governing cities, and by closing the philosophical schools at Athens (529). In course of time the inhabitants had so far forgotten their ancient culture that they abandoned the name of Hellenes for that of Romans (*Rhomaioi*). For a long time Greece continued to be an obscure and neglected province, with no interest beyond its church and its commercial operations, and its culture declined rapidly. Its history for some centuries dwindles into a record of barbarian invasions which, in addition to occasional plagues and earthquakes, seem to have been the only events found worthy of record by the contemporary chroniclers.

In the 5th century Greece was only subjected to brief raids by Vandal pirates (466-474) and Ostrogoths (482). In Justinian's reign irruptions by Huns and Avars took place, but led to no far-reaching results. The emperor had endeavoured to strengthen the country's defences by repairing the fortifications of cities and frontier posts (530), but his policy of supplanting the local

guards by imperial troops and so rendering the natives incapable of self-defence was ill-advised; fortunately it was never carried out with energy, and so the Greek militias were occasionally able to render good service against invaders.

Towards the end of the century mention is made for the first time of an incursion by Slavonic tribes (581). These invaders are to be regarded as merely the forerunners of a steady movement of immigration by which a considerable part of Greece passed for a time into foreign hands. It is doubtful how far the newcomers won their territory by force of arms; in view of the desolation of many rural tracts, which had long been in progress as a result of economic changes, it seems probable that numerous settlements were made on unoccupied land and did not challenge serious opposition. At any rate the effect upon the Greek population was merely to accelerate its emigration from the interior to the coastland and the cities. The foreigners, consisting mainly of Slovenes and Wends, occupied the mountainous inland, where they mostly led a pastoral life; the natives retained some strips of plain and dwelt secure in their walled towns, among which the newly-built fortresses of Monemvasia, Corone and Calamata soon rose to prosperity. The Slavonic element, to judge by the geographical names in that tongue which survive in Greece, is specially marked in N.W. Greece and Peloponnesus; central Greece appears to have been protected against them by the fortress-square of Chalcis, Thebes, Corinth and Athens. For a long time the two nations dwelt side by side without either displacing the other. The Slavs were too rude and poor, and too much distracted with cantonal feuds, to make any further headway; the Greeks, unused to arms and engrossed in commerce, were content to adopt a passive attitude. The central government took no steps to dislodge the invaders, until in 783 the empress Irene sent an expedition which reduced most of the tribes to pay tribute. In 810 a desperate attempt by the Slavs to capture Patrae was foiled; henceforth their power steadily decreased and their submission to the emperor was made complete by 850. A powerful factor in their subjugation was the Greek clergy, who by the 10th century had christianized and largely hellenized all the foreigners save a remnant in the peninsula of Maina.

II. THE BYZANTINE PERIOD.—In the 7th century the Greek language made its way into the imperial army and civil service, but European Greece continued to have little voice in the administration. The land was divided into four "themes" under a yearly appointed civil and military governor. Imperial troops were stationed at the chief strategic points, while the natives contributed ships for naval defence. During the dispute about images the Greeks were the backbone of the image-worshipping party, and the iconoclastic edicts of Leo III. led to a revolt in 727 which, however, was easily crushed by the imperial fleet; a similar movement in 823, when the Greeks sent 350 ships to aid a pretender, met with the same fate. The firm government of the Isaurian dynasty seems to have benefited Greece, whose commerce and industry again became flourishing. In spite of occasional set-backs due to the depredations of pirates, notably the Arab corsairs who visited the Aegean from the 7th century onwards, the Greeks remained the chief carriers in the Levant until the rise of the Italian republics, supplying all Europe with its silk fabrics.

In the 10th century Greece experienced a renewal of raids from the Balkan tribes. The Bulgarians made incursions after 929 and sometimes penetrated to the Isthmus; but they mostly failed to capture the cities, and in 995 their strength was broken by a crushing defeat on the Spercheus at the hands of the Byzantine army. Yet their devastations greatly thinned the population of northern Greece, and after 1084 Thessaly was occupied without resistance by nomad tribes of Vlachs. In 1084 also Greece was subjected to the first attack from the new nations of the west, when the Sicilian Normans gained a footing in the Ionian Islands. The same people made a notable raid upon the seaboard of Greece in 1145-1146, and sacked the cities of Thebes and Corinth. The Venetians also appear as rivals of

Slavonic
Immigra-
tion.

the Greeks, and after 1122 their encroachments in the Aegean Sea never ceased.

In spite of these attacks, the country on the whole maintained its prosperity. The travellers Idrisi of Palermo (1153) and Benjamin of Tudela (1161) testify to the briskness of commerce, which induced many foreign merchants to take up their residence in Greece. But this prosperity revived an aristocracy of wealth which used its riches and power for purely selfish ends, and under the increasing laxity of imperial control the *archontes* or municipal rulers often combined with the clergy in oppressing the poorer classes. Least of all were these nobles prepared to become the champions of Greece against foreign invaders at a time when they alone could have organized an effectual resistance.

III. *The Latin Occupation and Turkish Conquest.*—The capture of Constantinople and dissolution of the Byzantine empire by the Latins (1204) brought in its train an invasion of Greece by Frankish barons eager for new territory. The natives, who had long forgotten the use of arms and dreaded no worse oppression from their new masters, submitted almost without resistance, and only the N.W. corner of Greece, where Michael Angelus, a Byzantine prince, founded the "despotat" of Epirus, was saved from foreign occupation. The rest of the country was divided up between a number of Frankish barons, chief among whom were the dukes of Achaëa (or Peloponnese) and "grand signors" of Thebes and Athens, the Venetians, who held naval stations at different points and the island of Crete, and various Italian adventurers who mainly settled in the Cyclades. The conquerors transplanted their own language, customs and religion to their new possessions, and endeavoured to institute the feudal system of land-tenure. Yet recognizing the superiority of Greek civil institutions they allowed the natives to retain their law and interpal administration and confirmed proprietors in possession of their land on payment of a rent; the Greek church was subordinated to the Roman archbishops, but upheld its former control over the people. The commerce and industry of the Greek cities was hardly affected by the change of government.

Greek history during the Latin occupation loses its unity and has to be followed in several threads. In the north the "despots" of Epirus extended their rule to Thessaly and Macedonia, but eventually were repulsed by the Asiatic Greeks of Nicaea, and after a decisive defeat at Pelagonia (1250) reduced to a small dominion round Iannina. Thessaly continued to change masters rapidly. Till 1308 it was governed by a branch line of the Epirote dynasty. When this family died out it fell to the Grand Catalan Company; in 1350 it was conquered along with Epirus by Stephen Dushan, king of Servia. About 1397 it was annexed by the Ottoman Turks, who after 1431 also gradually wrested Epirus from its latest possessors, the Beneventine family of Tocco (1390-1469).

The leading power in central Greece was the Burgundian house de la Roche, which established a mild and judicious government in Boeotia and Attica and in 1261 was raised to ducal rank by the French king Louis IX. A conflict with the Grand Catalan Company resulted in a disastrous defeat of the Franks on the Boeotian Cephissus (1311) and the occupation of central Greece by the Spanish mercenaries, who seized for themselves the barons' fiefs and installed princes from the Sicilian house of Aragon as "dukes of Athens and Neopatra" (Thessaly). After seventy-five years of oppressive rule and constant wars with their neighbours the Catalans were expelled by the Peloponnesian baron Nerio Acciaiuoli. The new dynasty, whose peaceful government revived its subjects' industry, became tributary to the Turks about 1415, but was deposed by Sultan Mahommed II., who annexed central Greece in 1456.

The conquest of the Peloponnese was effected by two French knights, William Champlitte and Geoffrey Villehardouin, the latter of whom founded a dynasty of "princes of all Achaëa." The rulers of this line were men of ability, who controlled their barons and spiritual vassals with a firm hand and established good order throughout their province. The Franks of the Morea maintained as high a standard of culture as their com-

patriots at home, while the natives grew rich enough from their industry to pay considerable taxes without discontent. The climax of the Villehardouins' power was attained under Prince William, who subdued the last independent cities of the coast and the mountaineers of Maina (1246-1248). In 1259, however, the same ruler was involved in the war between the rulers of Epirus and Nicaea, and being captured at the battle of Pelagonia, could only ransom himself by the cession of Laconia to the restored Byzantine empire. This new dependency after 1349 was treated with great care by the Byzantine monarchs, who sought to repress the violence of the local aristocracies by sending their kinsmen to govern under the title of "despots." On the other hand, with the extinction of the Villehardouin dynasty the Frankish province fell more and more into anarchy; at the same time the numbers of the foreigners were constantly dwindling through war, and as they disdained to recruit them by intermarriage, the preponderance of the native element in the Morea eventually became complete. Thus by 1400 the Byzantines were enabled to recover control over almost the whole peninsula and apportion it among several "despots." But the mutual quarrels of these princes soon proved fatal to their rule. Already in the 14th century they had employed Albanians and the Turkish pirates who harried their coasts as auxiliaries in their wars. The Albanians largely remained as settlers, and the connexion with the Turks could no longer be shaken off. In spite of attempts to fortify the Isthmus (1415) an Ottoman army penetrated into Morea and deported many inhabitants in 1423. An invasion of central Greece by the despot Constantine was punished by renewed raids in 1446 and 1450. In 1457 the despot Thomas withheld the tribute which he had recently stipulated to pay, but was reduced to obedience by an expedition under Mahommed II. (1458). A renewed revolt in 1459 was punished by an invasion attended with executions and deportations on a large scale, and by the annexation of the Morea to Turkey (1460).

IV. *The Turkish Dominion till 1800.*—Under the Ottoman government Greece was split up into six *sanjaks* or military divisions: (1) Morea, (2) Epirus, (3) Thessaly, (4) Euboea, Bœotia and Attica, (5) Aetolia and Acarnania, (6) the rest of central Greece, with capitals at Nauplia, Jannina, Trikkala, Negropont (Chalkis), Karili and Lepanto; further divisions were subsequently composed of Crete and the islands. In each *sanjak* a number of fiefs was apportioned to Turkish settlers, who were bound in return to furnish some mounted men for the sultan's army, the total force thus held in readiness being over 7000. The local government was left in the hands of the *archontes* or primates in each community, who also undertook the farming of the taxes and the policing of their districts. Law was usually administered by the Greek clergy. The natives were not burdened with large imposts, but the levying of the land-tithes was effected in an inconvenient fashion, and the capitation-tax, to which all Christians were subjected was felt as a humiliation. A further grievance lay in the requisitions of forced labour which the pashas were entitled to call for; but the most galling exaction was the tribute of children for the recruiting of the Janissaries (*g.v.*), which was often levied with great ruthlessness. The habitual weakness of the central government also left the Greeks exposed to frequent oppression by the Turkish residents and by their own magistrates and clergy. But the new rulers met with singularly little opposition. The dangerous elements of the population had been cleared away by Mahommed's executions; the rest were content to absorb their energies in agriculture and commerce, which in spite of preferential duties and capitulations to foreign powers largely fell again into the hands of Greeks. Another important instrument by which the people were kept down was their own clergy, whom the Turkish rulers treated with marked favour and so induced to acquiesce in their dominion.

In the following centuries Greece was often the theatre of war in which the Greeks played but a passive part. Several wars with Venice (1463-79, 1498-1504) put the Turks in possession of the last Italian strongholds on the mainland. But the

issue was mainly fought out on sea; the conflicts which had never ceased in the Aegean since the coming of the Italians now grew fiercer than ever; Greek ships and sailors were frequently requisitioned for the Turkish fleets, and the damage done to the Greek seaboard by the belligerents and by fleets of adventurers and corsairs brought about the depopulation of many islands and coast-strips. The conquest of the Aegean by the Ottomans was completed by 1570; but Venice retained Crete till 1669 and never lost Corfu until its cession to France in 1797.

In 1684 the Venetians took advantage of the preoccupation of Turkey on the Danube to attack the Morea. A small mercenary army under Francesco Morosini captured the strong places with remarkable ease, and by 1687 had conquered almost the whole peninsula. In 1687 the invaders also captured Athens and Lepanto; but the former town had soon to be abandoned, and with their failure to capture Negropont (1688) the Venetians were brought to a standstill. By the peace of Karlowitz (1699) the Morea became a possession of Venice. The new rulers, in spite of the commercial restrictions which they imposed in favour of their own traders, checked the impoverishment and decrease of population (from 300,000 to 86,000) which the war had caused. By their attempts to cooperate with the native magistrates and the mildness of their administration they improved the spirit of their subjects. But they failed to make their government popular, and when in 1715 the Ottomans with a large and well-disciplined army set themselves to recover the Morea, the Venetians were left without support from the Greeks. The peninsula was rapidly recaptured and by the peace of Passarowitz (1718) again became a Turkish dependency. The gaps left about this time in the Greek population were largely made up by an immigration from Albania.

The condition of the Greeks in the 18th century showed a great improvement which gave rise to yet greater hopes. Already in the 17th century the personal services of the subjects had been commuted into money contributions, and since 1676 the tribute of children fell into abeyance. The increasing use of Greek officials in the Turkish civil service, coupled with the privileges accorded to the Greek clergy throughout the Balkan countries, tended to recall the consciousness of former days of predominance in the Levant. Lastly, the education of the Greeks, which had always remained on a comparatively high level, was rapidly improved by the foundation of new schools and academies.

The long neglect which Greece had experienced at the hands of the European Powers was broken in 1764, when Russian agents appeared in the country with promises of a speedy deliverance from the Turks. A small expedition under Feodor and Alexis Orloff actually landed in the Morea in 1769, but failed to rouse national sentiment. Although the Russian fleet gained a notable victory off Chesme near Chios, a heavy defeat near Tripolitza ruined the prospects of the army. The Albanian troops in the Turkish army subsequently ravaged the country far and wide, until in 1779 they were exterminated by a force of Turkish regulars. In 1774 a concession, embodied in the treaty of Kuchuk Kainarji, by which Greek traders were allowed to sail under the protection of the Russian flag, marked an important step in the rehabilitation of the country as an independent power. Greek commerce henceforth spread swiftly over the Mediterranean, and increased intercourse developed a new sense of Hellenic unity. Among the pioneers who fostered this movement should be mentioned Constantine Rhigas, the "modern Tyrtaeus," and Adamantios Coraïs (q.v.), the reformer of the Greek tongue. The revived memories of ancient Hellas and the impression created by the French revolution combined to give the final impulse which made the Greeks strike for freedom. By 1800 the population of Greece had increased to 1,000,000, and although 200,000 of these were Albanians, the common aversion to the Moslem united the two races. The military resources of the country alone remained deficient, for the *armatoli* or local militias, which had never been quite disbanded since Byzantine times, were at last suppressed by Ali

Pasha of Iannina and found but a poor substitute in the klephts who henceforth spring into prominence. But at the first sign of weakness in the Turkish dominion the Greek nation was ready to rise, and the actual outbreak of revolt had become merely a question of time.

AUTHORITIES.—General: G. Finlay, *History of Greece* (ed. Tozer, Oxford, 1877), especially vols. i., iv., v.; K. Paparrhigopoulos, *Ἱστορία τοῦ Ἑλληνικοῦ ἔθνους* (4th ed., Athens, 1903), vols. ii.-v.; *Histoire de la civilisation hellénique* (Paris, 1878); R. v. Scala, *Das Griechentum seit Alexander dem Grossen* (Leipzig and Vienna, 1904); and specially W. Müller, *The Latins in the Levant* (1908).

Special—(a) The Roman period: Strabo, bks. viii.-x.; Pausanias, *Descriptio Graecias*; G. F. Hertzberg, *Die Geschichte Griechenlands unter der Herrschaft der Römer* (Halle, 1866-1875); Sp. Lampros, *Ἱστορία τῆς Ἑλλάδος* (Athens, 1888 sqq.), vol. iii.; A. Holm, *History of Greece* (Eng. trans., London, 1894-1898), vol. iv., chs. 19, 24, 26, 28 sqq.; Th. Mommsen, *The Provinces of the Roman Empire* (Eng. trans., London, 1886, ch. 7); J. P. Mahaffy, *The Greek World under Roman sway, from Polybius to Plutarch* (London, 1890); W. Müller, "The Romans in Greece" (*Westminster Review*, August 1903, pp. 186-210); L. Friedländer, "Griechenland unter den Römern" (*Deutsche Rundschau*, 1899, pp. 251-274, 402-430).

(b) The Byzantine and Latin periods: G. F. Hertzberg, *Geschichte Griechenlands seit dem Absterben des antiken Lebens* (Gotha, 1876-1879), vols. i., ii.; C. Hopf, *Geschichte Griechenlands im Mittelalter* (Leipzig, 1868); J. A. Buchon, *Histoire des conquêtes et de l'établissement des Français dans les États de l'ancienne Grèce* (Paris, 1846); G. Schmitt, *The Chronicle of Morea* (London, 1904); W. Müller, "The Princes of the Peloponnese" (*Quarterly Review*, July 1905, pp. 109-135); D. Bikelas, *Seven Essays on Christian Greece* (Paisley and London, 1890); *La Grèce byzantine et moderne* (Paris, 1893), pp. 1-193.

(c) The Turkish and Venetian periods: Hertzberg, *op. cit.*, vol. iii.; K. M. Bartholdy, *Geschichte Griechenlands von der Eroberung Konstantinopels* (Leipzig, 1870), bks. i. and ii., pp. 1-155; K. N. Sathas, *Τουρκοκρατορία Ἑλλάδος* (Athens, 1869); W. Müller, "Greece under the Turks" (*Westminster Review*, August and September 1904, pp. 195-210, 304-320; *English Historical Review*, 1904, pp. 646-668); L. Ranke, "Die Venetianer in Morea" (*Historisch-politische Zeitschrift*, ii. 405-502).

(d) Special subjects: Religion. E. Hatch, *The Influence of Greek Ideas and Usages upon the Christian Church* (London, 1890). Ethnology. J. P. Fallmerayer, *Geschichte der Hellenen* (Munich, 1875); S. Zampelios, *Ἡ ἐθνικὴ γενεαλογία τῶν Ἑλλήνων* (Athens, 1857); A. Philippson, "Zur Ethnographie des Peloponnes" (*Petersmann's Mitteilungen* 36 (1890), pp. 1-11, 33-41); A. Vasiljev, "Die Slaven in Griechenland" (*Visantskiy Vremennik*, St Petersburg, 5 (1898), pp. 404-438, 626-670).

See also ROMAN EMPIRE, LATER; ATHENS. (M. O. B. C.)

c. Modern History: 1800-1908.

At the beginning of the 19th century Greece was still under Turkish domination, but the dawn of freedom was already breaking, and a variety of forces were at work which prepared the way for the acquisition of national independence. The decadence of the Ottoman empire, which began with the retreat of the Turks from Vienna in 1683, was indicated in the 18th century by the weakening of the central power, the spread of anarchy in the provinces, the ravages of the janissaries, and the establishment of practically independent sovereignties or fiefs, such as those of Mehemet of Bushat at Skodra and of Ali Pasha of Tepelen at Iannina; the 19th century witnessed the first uprisings of the Christian populations and the detachment of the outlying portions of European Turkey. Up to the end of the 18th century none of the subject races had risen in spontaneous revolt against the Turks, though in some instances they rendered aid to the sultan's enemies; the spirit of the conquered nations had been broken by ages of oppression. In some of the remote and more mountainous districts, however, the authority of the Turks had never been completely established; in Montenegro a small fragment of the Serb race maintained its independence; among the Greeks, the Mainotes in the extreme south of the Morea and the Sphakiot mountaineers in Crete had never been completely subdued. Resistance to Ottoman rule was maintained sporadically in the mountainous districts by the Greek *klephts* or brigands, the counterpart of the Slavonic *haiduks*, and by the pirates of the Aegean; the *armatotes* or bodies of Christian warriors, recognized by the Turks as a local police, often differed little in their proceedings from the brigands whom they were appointed to pursue.

Of the series of insurrections which took place in the 19th century, the first in order of time was the Servian, which broke out in 1804; the second was the Greek, which began in 1821. In both these movements the influence of **Russian influence.** Russia played a considerable part. In the case of the Servians Russian aid was mainly diplomatic, in that of the Greeks it eventually took a more material form. Since the days of Peter the Great, the eyes of Russia had been fixed on Constantinople, the great metropolis of the Orthodox faith. The policy of inciting the Greek Christians to revolt against their oppressors, which was first adopted in the reign of the empress Anna, was put into practical operation by the empress Catharine II., whose favourite, Orlov, appeared in the Aegean with a fleet in 1769 and landed in the Morea, where he organized a revolt. The attempt proved a failure; Orlov re-embarked, leaving the Greeks at the mercy of the Turks, and terrible massacres took place at Tripolitza, Lemnos and elsewhere. By the treaty of Kutchuk-Kainarji (July 21, 1774) Russia obtained a vaguely-defined protectorate over the Orthodox Greek subjects of Turkey, and in 1781 she arrived at an arrangement with Austria, known as the "Greek project," for a partition of Turkish territory and the restoration of the Byzantine empire under Constantine, the son of Catharine II. The outbreak of the French Revolution distracted the attention of the two empires, but Russia never ceased to intrigue among the Christian subjects of Turkey. A revolt of the inhabitants of Sulis in 1790 took place with her connivance, and in the two first decades of the 19th century her agents were active and ubiquitous.

The influence of the French Revolution, which pervaded all Europe, extended to the shores of the Aegean. The Greeks, **Greek** who had hitherto been drawn together mainly by a common religion, were now animated by the sentiment of nationality and by an ardent desire for political freedom. The national awakening, as in the case of the other subject Christian nations, was preceded by a literary revival. Literary and patriotic societies, the Philhellenes, the Philomousi, came into existence; Greek schools were founded everywhere; the philological labours of Coraëus, which created the modern written language, furnished the nation with a mode of literary expression; the songs of Rhigas of Velestino fired the enthusiasm of the people. In 1815 was founded the celebrated *Philiké Hetaëra*, or friendly society, a revolutionary organization with centres at Moscow, Bucharest, Trieste, and in all the cities of the Levant; it collected subscriptions, issued manifestos, distributed arms and made preparations for the coming insurrection. The revolt of Ali Pasha of Iannina against the authority of the sultan in 1820 formed the prelude to the Greek uprising; this despot, who had massacred the Greeks by hundreds, now declared himself their friend, and became a member of the Hetaëra. In March 1821 Alexander Ypsilanti, a former aide-de-camp of the tsar Alexander I., and president of the Hetaëra, entered Moldavia from Russian territory at the head of a small force; in the same month Archbishop Germanos of Patras unfurled the standard of revolt at Kalavryta in the Morea.

For the history of the prolonged struggle which followed see GREEK WAR OF INDEPENDENCE. The warfare was practically brought to a close by the annihilation of the Egyptian fleet at Navarino by the fleets of Great Britain, France and Russia on the 20th of October 1827. Nine months previously, Count John Capo d'Istria (*q.v.*), formerly minister of foreign affairs of the tsar Alexander, had been elected president of the Greek republic for seven years beginning on January 18, 1828. By the protocol of London (March 22, 1829) the Greek mainland south of a line drawn from the Gulf of Arta to the Gulf of Volo, the Morea and the Cyclades were declared a principality tributary to the sultan under a Christian prince. The limits drawn by the protocol of London were confirmed by the treaty of Adrianople (September 14, 1829), by which Greece was constituted an independent monarchy. The governments of Russia, France and England were far from sharing the enthusiasm which the gallant resistance of the

Greeks had excited among the peoples of Europe, and which inspired the devotion of Byron, Cochrane, Sir Richard Church, Fabvier and other distinguished Philhellenes; jealousies prevailed among the three protecting powers, and the newly-liberated nation was treated in a niggardly spirit; its narrow limits were reduced by a new protocol (February 3, 1830), which drew the boundary line at the Aspropotamo, the Spercheios and the Gulf of Lamia. Capo d'Istria, whose Russian proclivities and arbitrary government gave great offence to the Greeks, was assassinated by two members of the Mavromichalis family (October 9, 1831), and a stage of anarchy followed. Before his death the throne of Greece had been offered to Prince Leopold of Saxe-Coburg-Gotha, afterwards king of the Belgians, who declined it, basing his refusal on the inadequacy of the limits assigned to the new kingdom and especially the exclusion of Crete.

By the convention of London (May 7, 1832) Greece was declared an independent kingdom under the protection of Great Britain, France and Russia with Prince Otto, **King Otto.** son of King Louis I. of Bavaria, as king. The frontier line, now traced from the Gulf of Arta to the Gulf of Lamia, was fixed by the arrangement of Constantinople (July 21, 1832). King Otto, who had been brought up in a despotic court, ruled absolutely for the first eleven years of his reign; he surrounded himself with Bavarian advisers and Bavarian troops, and his rule was never popular. The Greek chiefs and politicians, who found themselves excluded from all influence and advancement, were divided into three factions which attached themselves respectively to the three protecting powers. On the 15th of September 1843 a military revolt broke out which compelled the king to dismiss the Bavarians and to accept a constitution. A responsible ministry, a senate nominated by the king, and a chamber elected by universal suffrage were now instituted. Mavrocordatos, the leader of the English party, became the first prime minister, but his government was overthrown at the ensuing elections, and a coalition of the French and Russian parties under Kolettis and Metaxas succeeded to power. The warfare of factions was aggravated by the rivalry between the British and French ministers, Sir Edmond Lyons and M. Piscatory; King Otto supported the French party, and trouble arose with the British government, which in 1847 despatched warships to enforce the payment of interest on the loan contracted after the War of Independence. A British fleet subsequently blockaded the Peiræus in order to obtain satisfaction for the claims of Pacifico, a Portuguese Jew under British protection, whose house had been plundered during a riot. On the outbreak of hostilities between Russia and Turkey in 1853 the Greeks displayed sympathy with Russia; armed bands were sent into Thessaly, and an insurrection was fomented in Epirus in the hope of securing an accession of territory. In order to prevent further hostile action on the part of Greece, British and French fleets made a demonstration against the Peiræus, which was occupied by a French force during the Crimean War. The disappointment of the national hopes increased the unpopularity of King Otto, who had never acquiesced in constitutional rule. In 1862 a military revolt broke out, and a national assembly pronounced his deposition. The vacant throne was offered by the assembly to Duke Nicholas of Leuchtenberg, a cousin of the tsar, but the mass of the people desired a constitutional monarchy of the British type; a plebiscite was taken, and Prince Alfred of England was elected by an almost unanimous vote. The three protecting powers, however, had bound themselves to the exclusion of any member of their ruling houses. In the following year Prince William George of Schleswig-Holstein-Sonderburg-Glücksburg, whom the British government had designated as a suitable candidate, was elected by the National Assembly with the title "George I., king of the Hellenes." Under the treaty of London (July 13, 1863) the change of dynasty was sanctioned by the three protecting powers, Great Britain undertaking to cede to Greece the seven Ionian Islands, which since 1815 had formed a commonwealth under British protection.

On the 29th of October 1863 the new sovereign arrived in Athens, and in the following June the British authorities handed over the Ionian Islands to a Greek commissioner. King George thus began his reign under the most favourable auspices, the patriotic sentiments of the Greeks being flattered by the acquisition of new territory. He was, however, soon confronted with constitutional difficulties; party spirit ran riot at Athens, the ministries which he appointed proved short-lived, his counsellor, Count Spennock, became the object of violent attacks, and at the end of 1864 he was compelled to accept an ultra-democratic constitution, drawn up by the National Assembly. This, the sixth constitution voted since the establishment of the kingdom, is that which is still in force. In the following year Count Spennock left Greece, and the attention of the nation was concentrated on the affairs of Crete. The revolution which broke out in that island received moral and material support from the Greek government, with the tacit approval of Russia; military preparations were pressed forward at Athens, and cruisers were purchased, but the king, aware of the inability of Greece to attain her ends by warlike means, discouraged a provocative attitude towards Turkey, and eventually dismissed the bellicose cabinet of Koumoundouros. The removal of a powerful minister commanding a large parliamentary majority constituted an important precedent in the exercise of the royal prerogative; the king adopted a similar course with regard to Delyannes in 1890 and 1897. The relations with the porte, however, continued to grow worse, and Hobart Pasha, with a Turkish fleet, made a demonstration off Syra. The Cretan insurrection was finally crushed in the spring of 1869, and a conference of the powers, which assembled that year at Paris, imposed a settlement of the Turkish dispute on Greece, but took no steps on behalf of the Cretans. In 1870 the murder of several Englishmen by brigands in the neighbourhood of Athens produced an unfavourable impression in Europe; in the following year the confiscation of the Laurion mines, which had been ceded to a Franco-Italian company, provoked energetic action on the part of France and Italy. In 1875, after an acute constitutional crisis, Charilaos Trikoupes, who but ten months previously had been imprisoned for denouncing the crown in a newspaper article, was summoned to form a cabinet. This remarkable man, the only great statesman whom modern Greece has produced, exercised an extraordinary influence over his countrymen for the next twenty years; had he been able to maintain himself uninterruptedly in power during that period, Greece might have escaped a long succession of misfortunes. His principal opponent, Theodoros Delyannes, succeeded in rallying a strong body of adherents, and political parties, hitherto divided into numerous factions, centred around these two prominent figures.

In 1877 the outbreak of the Russo-Turkish War produced a fever of excitement in Greece; it was felt that the quarrels of the party leaders compromised the interests of the country, and the populace of Athens insisted on the formation of a coalition cabinet. The "great" or "oecumenical" ministry, as it was called, now came into existence under the presidency of the veteran Kanares; in reality, however, it was controlled by Trikoupes, who, recognizing the unpreparedness of the country, resolved on a pacific policy. The capture of Plevna by the Russians brought about the fall of the "oecumenical" ministry, and Koumoundouros and Delyannes, who succeeded to power, ordered the invasion of Thessaly. Their warlike energies, however, were soon checked by the signing of the San Stefano Treaty, in which the claims of Greece to an extension of frontier were altogether ignored. At the Berlin congress two Greek delegates obtained a hearing on the proposal of Lord Salisbury. The congress decided that the rectification of the frontier should be left to Turkey and Greece, the mediation of the powers being proposed in case of non-agreement; it was suggested, however, that the rectified frontier should extend from the valley of the Peneus on the east to the mouth of the Kalamas, opposite the southern extremity of Corfu, on the west. In 1879 a Greco-Turkish commission

for the delimitation met first at Prevesa, and subsequently at Constantinople, but its conferences were without result, the Turkish commissioners declining the boundary suggested at Berlin. Greece then invoked the arbitration of the powers, and the settlement of the question was undertaken by a conference of ambassadors at Berlin (1880). The line approved by the conference was practically that suggested by the congress; Turkey, however, refused to accept it, and the Greek army was once more mobilized. It was evident, however, that nothing could be gained by an appeal to arms, the powers not being prepared to apply coercion to Turkey. By a convention signed at Constantinople in July 1881, the demarcation was entrusted to a commission representing the six powers and the two interested parties. The line drawn ran westwards from a point between the mouth of the Peneus and Platamona to the summits of Mounts Kritiri and Zygos, thence following the course of the river Arta to its mouth. An area of 13,395 square kilometres, with a population of 300,000 souls, was thus added to the kingdom, while Turkey was left in possession of Iannina, Metzovo and most of Epirus. The ceded territory was occupied by Greek troops before the close of the year.

In 1882 Trikoupes came into power at the head of a strong party, over which he exercised an influence and authority hitherto unknown in Greek political life. With the exception of three brief intervals (May 1885 to May 1886, October 1890 to February 1892, and a few months in 1893), he continued in office for the next twelve years. The reforms which he introduced during this period were generally of an unpopular character, and were loudly denounced by his democratic rivals; most of them were cancelled during the intervals when his opponent Delyannes occupied the premiership. The same want of continuity proved fatal to the somewhat ambitious financial programme which he now inaugurated. While pursuing a cautious foreign policy, and keeping in control the rash impetuosity of his fellow-countrymen, he shared to the full the national desire for expansion, but he looked to the development of the material resources of the country as a necessary preliminary to the realization of the dreams of Hellenism. With this view he endeavoured to attract foreign capital to the country, and the confidence which he inspired in financial circles abroad enabled him to contract a number of loans and to better the financial situation by a series of conversions. Under a stable, wise, and economical administration this far-reaching programme might perhaps have been carried out with success, but the vicissitudes of party politics and the periodical outbursts of national sentiment rendered its realization impossible. In April 1885 Trikoupes fell from power, and a few months later the indignation excited in Greece by the revolution of Philippopolis placed Delyannes once more at the head of a warlike movement. The army and fleet were again mobilized with a view to exacting territorial compensation for the aggrandizement of Bulgaria, and several conflicts with the Turkish troops took place on the frontier. The powers, after repeatedly inviting the Delyannes cabinet to disarm, established a blockade of Peiræus and other Greek ports (8th May 1886), France alone declining to co-operate in this measure. Delyannes resigned (11th May) and Trikoupes, who succeeded to power, issued a decree of disarmament (23rd May). Hostilities, however, continued on the frontier, and the blockade was not raised till 7th June. Trikoupes had now to face the serious financial situation brought about by the military activity of his predecessor. He imposed heavy taxation, which the people, for the time at least, bore without murmuring, and he continued to inspire such confidence abroad that Greek securities maintained their price in the foreign market. It was ominous, however, that a loan which he issued in 1890 was only partially covered. Meanwhile the Cretan difficulty had become once more a source of trouble to Greece. In 1889 Trikoupes was grossly deceived by the Turkish government, which, after inducing him to dissuade the Cretans from opposing the occupation of certain fortified posts, issued a firman annulling many important provisions in the constitution of the island. The indignation

in Greece was intense, and popular discontent was increased by the success of the Bulgarians in obtaining the *exequatur* of the sultan for a number of bishops in Macedonia. In the autumn of 1890 Trikoupes was beaten at the elections, and Delyannes, who had promised the people a radical reform of the taxation, succeeded to power. He proved unequal, however, to cope with the financial difficulty, which now became urgent; and the king, perceiving that a crisis was imminent, dismissed him and recalled Trikoupes. The hope of averting national bankruptcy depended on the possibility of raising a loan by which the rapid depreciation of the paper currency might be arrested, but foreign financiers demanded guarantees which seemed likely to prove hurtful to Greek susceptibilities; an agitation was raised at Athens, and Trikoupes suddenly resigned (May 1893). His conduct at this juncture appears to have been due to some misunderstandings which had arisen between him and the king. The Sotiropoulos-Rhalls ministry which followed effected a temporary settlement with the national creditors, but Trikoupes, returning to power in the autumn, at once annulled the arrangement. He now proceeded to a series of arbitrary measures which provoked the severest criticism throughout Europe and exposed Greece to the determined hostility of Germany. A law was hastily passed which deprived the creditors of 70% of their interest, and the proceeds of the revenues conceded to the monopoly bondholders were seized (December 1893). Long negotiations followed, resulting in an arrangement which was subsequently reversed by the German bondholders. In January 1895 Trikoupes resigned office, in consequence of a disagreement with the crown prince on a question of military discipline. His popularity had vanished, his health was shattered, and he determined to abandon his political career. His death at Cannes (11th April 1896), on the eve of a great national convulsion, deprived Greece of his masterly guidance and sober judgment at a critical moment in her history.

His funeral took place at Athens on 23rd April, while the city was still decorated with flags and garlands after the celebration of the Olympic games. The revival of the ancient festival, which drew together multitudes of Greeks from abroad, led to a lively awakening of the national sentiment, hitherto depressed by the economic misfortunes of the kingdom, and a secret patriotic society, known as the *Ethniké Hetaera*, began to develop prodigious activity, enrolling members from every rank of life and establishing branches in all parts of the Hellenic world. The society had been founded in 1894, by a handful of young officers who considered that the military organization of the country was neglected by the government; its principal aim was the preparation of an insurrectionary movement in Macedonia, which, owing to the activity of the Bulgarians and the reconciliation of Prince Ferdinand with Russia, seemed likely to be withdrawn for ever from the domain of Greek irredentism. The outbreak of another insurrection in Crete supplied the means of creating a diversion for Turkey while the movement in Macedonia was being matured; arms and volunteers were shipped to the island, but the society was as yet unable to force the hand of the government, and Delyannes, who had succeeded Trikoupes in 1895, loyally aided the powers in the restoration of order by advising the Cretans to accept the constitution of 1896. The appearance of strong insurgent bands in Macedonia in the summer of that year testified to the activity of the society and provoked the remonstrances of the powers, while the spread of its propaganda in the army led to the issue of a royal rescript announcing grand military manoeuvres, the formation of a standing camp, and the rearmament of the troops with a new weapon (6th December). The objects of the society were effectually furthered by the evident determination of the porte to evade the application of the stipulated reforms in Crete; the Cretan Christians lost patience, and indignation was widespread in Greece. Emissaries of the society were despatched to the island, and affairs were brought to a climax by an outbreak at Canea on 4th February 1897. The Turkish troops fired on

the Christians, thousands of whom took refuge on the warships of the powers, and a portion of the town was consumed by fire.

Delyannes now announced that the government had abandoned the policy of abstention. On the 6th two warships were despatched to Canea, and on the 10th a torpedo flotilla, commanded by Prince George, left Peiræus amid tumultuous demonstrations. The ostensible object of these measures was the protection of Greek subjects in Crete, and Delyannes was still anxious to avoid a definite rupture with Turkey, but the *Ethniké Hetaera* had found means to influence several members of the ministry and to alarm the king. Prince George, who had received orders to prevent the landing of Turkish reinforcements on the island, soon withdrew from Cretan waters owing to the decisive attitude adopted by the commanders of the international squadron. A note was now addressed by the government to the powers, declaring that Greece could no longer remain a passive spectator of events in Crete, and on the 13th of February a force of 2500 men, under Colonel Vassos, embarked at Peiræus. On the same day a Greek warship fired on a Turkish steam yacht which was conveying troops from Candia to Sitia. Landing near Canea on the night of the 14th, Colonel Vassos issued a proclamation announcing the occupation of Crete in the name of King George. He had received orders to expel the Turkish garrisons from the fortresses, but his advance on Canea was arrested by the international occupation of that town, and after a few engagements with the Turkish troops and irregulars he withdrew into the interior of the island. Proposals for the coercion of Greece were now put forward by Germany, but Great Britain declined to take action until an understanding had been arrived at with regard to the future government of Crete. Eventually (2nd March) collective notes were addressed to the Greek and Turkish governments announcing the decision of the powers that (1) Crete could in no case in present circumstances be annexed to Greece; (2) in view of the delays caused by Turkey in the application of the reforms, Crete should be endowed with an effective autonomous administration, calculated to ensure it a separate government, under the suzerainty of the sultan. Greece was at the same time summoned to remove its army and fleet within the space of six days, and Turkey was warned that its troops must for the present be concentrated in the fortified towns and ultimately withdrawn from the island. The action of the powers produced the utmost exasperation at Athens; the populace demanded war with Turkey and the annexation of Crete, and the government drew up a reply to the powers in which, while expressing the conviction that autonomy would prove a failure, it indicated its readiness to withdraw some of the ships, but declined to recall the army. A suggestion that the troops might receive a European mandate for the preservation of order in the island proved unacceptable to the powers, owing to the aggressive action of Colonel Vassos after his arrival. Meanwhile troops, volunteers and munitions of war were hurriedly despatched to the Turkish frontier in anticipation of an international blockade of the Greek ports, but the powers contented themselves with a pacific blockade of Crete, and military preparations went on unimpeded.

While the powers dillyed, the danger of war increased; on 29th March the crown prince assumed command of the Greek troops in Thessaly, and a few days later hostilities were precipitated by the irregular forces of the *Ethniké Hetaera*, which attacked several Turkish outposts near Grevena. According to a report of its proceedings, subsequently published by the society, this invasion received the previous sanction of the prime minister. On 17th April Turkey declared war. The disastrous campaign which followed was of short duration, and it was evident from the outset that the Greeks had greatly underrated the military strength of their opponents (see GREECO-TURKISH WAR). After the evacuation of Larissa on the 24th, great discontent prevailed at Athens; Delyannes was invited by the king to resign, but refusing to do so was dismissed (29th April). His successor, Rhalls, after recalling the army from Crete (9th May) invoked the mediation

Nation-
alist
agitation,
1896.

Cretan
crisis,
1897.

War with
Turkey.

of the powers, and an armistice was concluded on the 19th of that month. Thus ended an unfortunate enterprise, which was undertaken in the hope that discord among the powers would lead to a European war and the dismemberment of Turkey. Greek interference in Crete had at least the result of compelling Europe to withdraw the island for ever from Turkish rule. The conditions of peace put forward by Turkey included a war indemnity of £10,000,000 and the retention of Thessaly; the latter demand, however, was resolutely opposed by Great Britain, and the indemnity was subsequently reduced to £4,000,000. The terms agreed to by the powers were rejected by Rhalles; the chamber, however, refused him a vote of confidence and King George summoned Zaimes to power (October 3). The definitive treaty of peace, which was signed at Constantinople on the 6th of December, contained a provision for a slight modification of the frontier, designed to afford Turkey certain strategical advantages; the demilitarization was carried out by a commission composed of military delegates of the powers and representatives of the interested parties. The evacuation of Thessaly by the Turkish troops was completed in June 1898. An immediate result of the war was the institution of an international financial commission at Athens, charged with the control of certain revenues assigned to the service of the national debt. The state of the country after the conclusion of hostilities was deplorable; the towns of northern Greece and the islands were crowded with destitute refugees from Thessaly; violent recriminations prevailed at Athens, and the position of the dynasty seemed endangered. A reaction, however, set in, in consequence of an attempt to assassinate King George (28th February 1898), whose great services to the nation in obtaining favourable terms from the powers began to receive general recognition. In the following summer the king made a tour through the country, and was everywhere received with enthusiasm. In the autumn the powers, on the initiative of Russia, decided to entrust Prince George of Greece with the government of Crete; on 26th November an intimation that the prince had been appointed high commissioner in the island was formally conveyed to the court of Athens, and on 21st December he landed in Crete amid enthusiastic demonstrations (see CRETE).

In April 1899 Zaimes gave way to Theotokes, the chief of the Trikoupi party, who introduced various improvements in the administration of justice and other reforms including a measure transferring the administration of the army from the minister of war to the crown prince. In May 1901 a meeting took place at Abbazia, under the auspices of the Austro-Hungarian government, between King George and King Charles of Rumania with a view to the conclusion of a Graeco-Rumanian understanding directed against the growth of Slavonic, and especially Bulgarian, influence in Macedonia. The compact, however, was destined to be short-lived owing to the prosecution of a Rumanian propaganda among the semi-Hellenized Vlachs of Macedonia. In November riots took place at Athens, the patriotic indignation of the university students and the populace being excited by the issue of a translation of the Gospels into modern Greek at the suggestion of the queen. The publication was attributed to Panславist intrigues against Greek supremacy over the Orthodox populations of the East, and the archbishop of Athens was compelled to resign. Theotokes, whose life was attempted, retired from power, and Zaimes formed a cabinet. In 1902 the progress of the Bulgarian movement in Macedonia once more caused great irritation in Greece. Zaimes, having been defeated at the elections in December, resigned, and was succeeded by Delyannes, whose popularity had not been permanently impaired by the misfortunes of the war. Delyannes now undertook to carry out extensive economic reforms, and introduced a measure restoring the control of the army to the ministry of war. He failed, however, to carry out his programme, and, being deserted by a section of his followers, resigned in June 1903, when Theotokes again became prime minister. The new cabinet resigned within a month owing to the outbreak of disturbances in the current-

growing districts, and Rhalles took office for the second time (July 8). The Bulgarian insurrection in Macedonia during the autumn caused great excitement in Athens, and Rhalles adopted a policy of friendship with Turkey (see MACEDONIA). The co-operation of the Greek party in Macedonia with the Turkish authorities exposed it to the vengeance of the insurgents, and in the following year a number of Greek bands were sent into that country. The campaign of retaliation was continued in subsequent years.

In December Rhalles, who had lost the support of the Delyannist party, was replaced by Theotokes, who promulgated a scheme of army reorganization, introduced various economies and imposed fresh taxation. In December ^{Murder of Delyannes.} the government was defeated on a vote of confidence and Delyannes once more became prime minister, obtaining a considerable majority in the elections which followed (March 1905), but on the 23rd of June he was assassinated. He was succeeded by Rhalles, who effected a settlement of the current question and cultivated friendly relations with Turkey in regard to Macedonia.

In the autumn anti-Greek demonstrations in Rumania led to a rupture of relations with that country. In December the ministry resigned owing to an adverse vote of the chamber, and Theotokes formed a cabinet. The new government, as a preliminary to military and naval reorganization, introduced a law directed against the candidature of military officers for parliament. Owing to obstruction practised by the military members of the chamber a dissolution took place, and at the subsequent elections (April 1906) Theotokes secured a large majority. In the autumn various excesses committed against the Greeks in Bulgaria in reprisal for the depredations of the Greek bands in Macedonia caused great indignation in Greece, but diplomatic relations between the two countries were not suspended. On the 26th of September Prince George, who had resigned the high commissionership of Crete, returned to Athens; the designation of his successors was accorded by the protecting powers to King George as a satisfaction to Greek national sentiment (see CRETE). The great increase in the activity of the Greek bands in Macedonia during the following spring and summer led to the delivery of a Turkish note at Athens (July 1907), which was supported by representations of the powers.

In October 1908 the proclamation by the Cretan assembly of union with Greece threatened fresh complications, the cautious attitude of the Greek government leading to an agitation in the army, which came to a head in 1909. On the 18th of July a popular demonstration against his Cretan policy led to the resignation of Theotokes, whose successor, Rhalles, announced a programme of military and economical reform. The army, however, took matters into its own hands, and on the 23rd of August Rhalles was replaced by Mavromichales, the nominee of the "Military League." For the next six months constitutional government was practically superseded by that of the League, and for a while the crown itself seemed to be in danger. The influence of the League, however, rapidly declined; army and navy quarrelled; and a fresh *coup d'état* at the beginning of 1910 failed of its effect, owing to the firmness of the king. On the 7th of February Mavromichales resigned, and his successor, Dragoumis, accepting the Cretan leader Venezelo's suggestion of a national assembly, succeeded in persuading the League to dissolve (March 29) on receiving the king's assurance that such an assembly would be convened. On the 31st, accordingly, King George formally proclaimed the convocation of a national assembly to deal with the questions at issue.

AUTHORITIES.—Finlay, *History of Greece* (Oxford, 1877); K. N. Sathas, *Μεταμορφωσις Βασιλευσων* (7 vols., Venice, 1872-1894); and *Μεταμορφωσις Ἑλληστικῆς ἱστορίας. Documents inédits relatifs à l'histoire du moyen âge* (9 vols., Paris, 1880-1890); Sp. Trikoupeas, *Ἱστορία τῆς Ἑλληνικῆς κρατασθένου* (4 vols., 3rd ed., Athens, 1888); K. Paparrhethopoulos, *Ἱστορία τοῦ Ἑλληνικοῦ ἔθνους* (5 vols., 4th ed., Athens, 1903); J. Philemon, *Δοκίμιον ἱστορικῶν περὶ τῆς Ἑλληνικῆς κρατασθένου* (Athens, 1859-1861); P. Kontoyannes, *Οἱ Ἕλληνας κατὰ τὴν πρότερον ἐπὶ Ἀλκατρίνης ῥωσσοτουρκικῆν πόλεμον* (Athens, 1903); D. G. Kampouroglou, *Ἱστορία τῶν Ἀθηνῶν. Τουρκοκρατία, 1458-1687* (2 vols., Athens, 1889-1890); and *Μεταμορφωσις τῆς Ἑλληστικῆς ἱστορίας τῶν Ἀθηνῶν*.

votaries, little space remained free, and great spaces or subsidiary chapels such as are usual in Christian cathedrals did not exist. (see TEMPLE).

Here our concern is not with the purposes or arrangements of a temple, but with its appearance and construction, regarded as a work of art, and as an embodiment of Greek ideas. A few simple and striking principles may be formulated, which are characteristic of all Greek buildings:—

(i.) Each member of the building has one function, and only one, and this function controls even the decoration of that member. The pillar of a temple is made to support the architrave and is for that purpose only. The flutings of the pillar, being perpendicular, emphasize this fact. The line of support which runs up through the pillar is continued in the triglyph, which also shows perpendicular grooves. On the other hand, the wall of a temple is primarily meant to divide or space off; thus it may well at the top be decorated by a horizontal band of relief, which belongs to it as a border belongs to a curtain. The base of a column, if moulded, is moulded in such a way as to suggest support of a great weight; the capital of a column is so carved as to form a transition between the column and the cornice which it supports.

(ii.) Greek architects took the utmost pains with the proportions, the symmetry as they called it, of the parts of their buildings. This was a thing in which the keen and methodical eyes of the Greeks delighted, to a degree which a modern finds it hard to understand. Simple and natural relations, 1:2, 1:3, 2:3 and the like, prevailed between various members of a construction. All curves were planned with great care, to please the eye with their flow; and the alternations and correspondences of features is visible at a glance. For example, the temple must have two pediments and two porches, and on its sides and fronts triglyph and metope must alternate with unvarying regularity.

(iii.) Rigidity in the simple lines of a temple is avoided by the device that scarcely any outline is actually straight. All are carefully planned and adapted to the eye of the spectator. In the Parthenon the line of the floor is curved, the profiles of the columns are curved, the corner columns slope inward from their bases, the columns are not even equidistant. This elaborate adaptation, called entasis, was expounded by F. C. Penrose in his work on Athenian architecture, and has since been observed in several of the great temples of Greece.

(iv.) Elaborate decoration is reserved for those parts of the temple which have, or at least appear to have, no strain laid upon them. It is true that in the archaic age experiments were made in carving reliefs on the lower drums of columns (as at Ephesus) and on the line of the architrave (as at Assus). But such examples were not followed. Nearly always the spaces reserved for mythological reliefs or groups are the tops of walls, the spaces between the triglyphs, and particularly the pediments surmounting the two fronts, which might be left hollow without danger to the stability of the edifice. Detached figures in the round are in fact found only in the pediments, or standing upon the tops of the pediments. And metopes are sculptured in higher relief than friezes.

"When we examine in detail even the simplest architectural decoration, we discover a combination of care, sense of proportion, and reason. The flutings of an Ionic column are not in section mere arcs of a circle, but made up of a combination of curves which produce a beautiful optical effect; the lines of decoration, as may be best seen in the case of the Erechtheum, are cut with a marvellous delicacy. Instead of trying to invent new schemes, the mason contents himself with improving the regular patterns until they approach perfection, and he takes everything into consideration. Mouldings on the outside of a temple, in the full light of the sun, are differently planned from those in the diffused light of the interior. Mouldings executed in soft stone are less fine than those in marble. The mason thinks before he works, and while he works, and thinks in entire correspondence with his surroundings."¹

Greek architecture, however, is treated elsewhere (see ARCHITECTURE); we will therefore proceed to speak briefly of the principles exemplified in sculpture. Existing works of Greek

¹ Grammar of Greek Art.

sculpture fall easily into two classes. The first class comprises what may be called works of substantive art, statues or groups made for their own sake and to be judged by themselves. Such are cult-statues of gods and goddesses from temple and shrine, honorary portraits of rulers or of athletes, dedicated groups and the like. The second class comprises decorative sculptures, such as were made, usually in relief, for the decoration of temples and tombs and other buildings, and were intended to be subordinate to architectural effect.

Speaking broadly, it may be said that the works of substantive sculpture in our museums are in the great majority of cases copies of doubtful exactness and very various merit. The Hermes of Praxiteles is almost the only marble statue which can be assigned positively to one of the great sculptors; we have to work back towards the productions of the peers of Praxiteles through works of poor execution, often so much restored in modern times as to be scarcely recognizable. Decorative works, on the other hand, are very commonly originals, and their date can often be accurately fixed, as they belong to known buildings. They are thus infinitely more trustworthy and more easy to deal with than the copies of statues of which the museums of Europe, and more especially those of Italy, are full. They are also more commonly unrestored. But yet there are certain disadvantages attaching to them. Decorative works, even when carried out under the supervision of a great sculptor, were but seldom executed by him. Usually they were the productions of his pupils or masons. Thus they are not on the same level of art as substantive sculpture. And they vary in merit to an extraordinary extent, according to the capacity of the man who happened to have them in hand, and who was probably but little controlled. Every one knows how noble are the pedimental sculptures of the Parthenon. But we know no reason why they should be so vastly superior to the frieze from Phigalia; nor why the heads from the temple at Tegea should be so fine, while those from the contemporary temple at Epidaurus should be comparatively insignificant. From the records of payments made to the sculptors who worked on the Erechtheum at Athens it appears that they were ordinary masons, some of them not even citizens, and paid at the rate of 60 drachms (about 60 francs) for each figure, whether of man or horse, which they produced. Such piece-work would not, in our days, produce a very satisfactory result.

Works of substantive sculpture may be divided into two classes, the statues of human beings and those of the gods. The line between the two is not, however, very easy to draw, or very definite. For in representing men the Greek sculptor had an irresistible inclination to idealize, to represent what was generic and typical rather than what was individual, and the essential rather than the accidental. And in representing deities he so fully anthropomorphized them that they became men and women, only raised above the level of everyday life and endowed with a superhuman stateliness. Moreover, there was a class of heroes represented largely in art who covered the transition from men to gods. For example, if one regards Heracles as a deity and Achilles as a man of the heroic age and of heroic mould, the line between the two will be found to be very narrow.

Nevertheless one may for convenience speak first of human and afterwards of divine figures. It was the custom from the 6th century onwards to honour those who had done any great achievement by setting up their statues in conspicuous positions. One of the earliest examples is that of the tyrannicides, Harmodius and Aristogiton, a group, a copy of which has come down to us (Plate I fig. 50²). Again, people who had not won any distinction were in the habit of dedicating to the deities portraits of themselves or of a priest or priestess, thus bringing themselves, as it were, constantly under the notice of a divine patron. The rows of statues before the temples at Miletus, Athens and

² It may here be pointed out that it was found impossible, with any regard for the appearance of the pages, to arrange the Plates for this article so as to preserve a chronological order in the individual figures; they are arranged consecutively as regards the history or the period, and are only grouped for convenience in paging.—Ed.

elsewhere came thus into being. But from the point of view of art, by far the most important class of portraits consisted of athletes who had won victories at some of the great games of Greece, at Olympia, Delphi or elsewhere. Early in the 6th century the custom arose of setting up portraits of athletic victors in the great sacred places. We have records of numberless such statues executed by all the greatest sculptors. When Pausanias visited Greece he found them everywhere far too numerous for complete mention.

It is the custom of studying and copying the forms of the finest of the young athletes, combined with the Greek habit of complete nudity during the sports, which lies at the basis of Greek excellence in sculpture. Every sculptor had unlimited opportunities for observing young vigorous bodies in every pose and in every variety of strain. The natural sense of beauty which was an endowment of the Greek race impelled him to copy and preserve what was excellent, and to omit what was ungainly or poor. Thus there existed, and in fact there was constantly accumulating, a vast series of types of male beauty, and the public taste was cultivated to an extreme delicacy. And of course this taste, though it took its start from athletic customs, and was mainly nurtured by them, spread to all branches of portraiture, so that elderly men, women, and at last even children, were represented in art with a mixture of idealism and fidelity to nature such as has not been reached by the sculpture of any other people.

The statues of the gods began either with stiff and ungainly figures roughly cut out of the trunk of a tree, or with the monstrous and symbolical representations of Oriental art. In the Greece of late times there were still standing rude pillars, with the tops sometimes cut into a rough likeness to the human form. And in early decoration of vases and vessels one may find Greek deities represented with wings, carrying in their hands lions or griffins, bearing on their heads lofty crowns. But as Greek art progressed it grew out of this crude symbolism. In the language of Brunn, the Greek artists borrowed from Oriental or Mycenaean sources the letters used in their works, but with these letters they spelled out the ideas of their own nation. What the artists of Babylon and Egypt express in the character of the gods by added attribute or symbol, swiftness by wings, control of storms by the thunderbolt, traits of character by animal heads, the artists of Greece work more and more fully into the sculptural type; modifying the human subject by the constant addition of something which is above the ordinary level of humanity, until we reach the Zeus of Pheidias or the Demeter of Cnidus. When the decay of the high ethical art of Greece sets in, the gods become more and more warped to the merely human level. They lose their dignity, but they never lose their charm.

The decorative sculpture of Greece consists not of single figures, but of groups; and in the arrangement of these groups the strict Greek laws of symmetry, of rhythm, and of balance, come in. We will take the three most usual forms, the pediment, the metope and the frieze, all of which belong properly to the temple, but are characteristic of all decoration, whether of tomb, trophy or other monument.

The form of the pediment is triangular; the height of the triangle in proportion to its length being about 1:8. The conditions of space are here strict and dominant; to comply with them requires some ingenuity. To a modern sculptor the problem thus presented is almost insoluble; but it was allowable in ancient art to represent figures in a single composition as of various sizes, in correspondence not to actual physical measurement but to importance. As the more important figures naturally occupy the midmost place in a pediment, their greater size comes in conveniently. And by placing some of the persons of the group in a standing, some in a seated, some in a reclining position, it can be so contrived that their heads are equidistant from the upper line of the pediment.

The statues in a Greek pediment, which are after quite an early period usually executed in the round, fall into three, five or seven groups, according to the size of the whole. As examples

to illustrate this exposition we take the two pediments of the temple at Olympia, the most complete which have come down to us, which are represented in figs. 33 and 34. The east pediment represents the preparation for the chariot race between Pelops and Oenomaus. The central group consists of five figures, Zeus standing between the two pairs of competitors and their wives. In the corners recline the two river-gods Alpheus and Cladeus, who mark the locality; and the two sides are filled up with the closely corresponding groups of the chariots of Oenomaus and Pelops with their grooms and attendants. Every figure to the left of Zeus balances a corresponding figure on his right, and all the lines of the composition slope towards a point above the apex of the pediment.

In the opposite or western pediment is represented the battle between Lapiths and Centaurs which broke out at the marriage of Peirithous in Thessaly. Here we have no less than nine groups. In the midst is Apollo. On each side of him is a group of three, a centaur trying to carry off a woman and a Lapith striking at him. Beyond these on each side is a struggling pair, next once more a trio of two combatants and a woman, and finally in each corner two reclining female figures, the outermost apparently nymphs to mark locality. A careful examination of these compositions will show the reader more clearly than detailed description how clearly in this kind of group Greek artists adhered to the rules of rhythm and of balance.

The metopes were the long series of square spaces which ran along the outer walls of temples between the upright triglyphs and the cornice. Originally they may have been left open and served as windows; but the custom came in as early as the 7th century, first of filling them in with painted boards or slabs of stone, and next of adorning them with sculpture. The metopes of the Treasury of Sicyon at Delphi (Plate IV. fig. 66) are as early as the first half of the 6th century. This recurrence of a long series of square fields for occupation well suited the genius and the habits of the sculptor. As subjects he took the successive exploits of some hero such as Heracles or Theseus, or the contemporary groups of a battle. His number of figures was limited to two or three, and these figures had to be worked into a group or scheme, the main features of which were determined by artistic tradition, but which could be varied in a hundred ways so as to produce a pleasing and in some degree novel result.

With metopes, as regards shape, we may compare the reliefs of Greek tombs, which also usually occupy a space roughly square, and which also comprise but a few figures arranged in a scheme generally traditional. A figure standing giving his hand to one seated, two men standing hand in hand, or a single figure in some vigorous pose is sufficient to satisfy the simple but severe taste of the Greeks.

In regard to friezes, which are long reliefs containing figures ranged between parallel lines, there is more variety of custom. In temples the height of the relief from the background varies according to the light in which it was to stand, whether direct or diffused. Almost all Greek friezes, however, are of great simplicity in arrangement and perspective. Locality is at most hinted at by a few stones or trees, never actually portrayed. There is seldom more than one line of figures, in combat or procession, their heads all equidistant from the top line of the frieze. They are often broken up into groups; and when this is the case, figure will often balance figure on either side of a central point almost as rigidly as in a pediment. An example of this will be found in the section of the Mausoleum frieze shown in fig. 70, Plate IV. Some of the friezes executed by Greek artists for semi-Greek peoples, such as those adorning the tomb at Trysa in Lycia, have two planes, the figures in the background being at a higher level.

The rules of balance and symmetry in composition which are followed in Greek decorative art are still more to be discerned in the paintings of vases, which must serve, in the absence of more dignified compositions, to enlighten us as to the methods of Greek painters. Great painters would not, of course, be bound by architectonic rule in the same degree as the mere workmen who painted vases. Nevertheless we must never forget that

Greek painting of the earlier ages was of extreme simplicity. It did not represent localities, save by some slight hint; it had next to no perspective; the colours used were but very few even down to the days of Apelles. Most of the great pictures of which we hear consisted of but one or two figures; and when several figures were introduced they were kept apart and separately treated, though, of course, not without relation to one another. Idealism and ethical purpose must have predominated in painting as in sculpture and in the drama and in the writing of history.

We will take from vases a few simple groups to illustrate the laws of Greek drawing; colouring we cannot illustrate.

The fields offered to the draughtsman on Greek vases naturally follow the form of the vase; but they may be set down as



(Brit. Mus. Catalogue of Vases, III. Pl. vi. 5).
FIG. 1.—Kylix by Epictetus.

approximately round, square or oblong. To each of these spaces the artist carefully adapts his designs. In fig. 1 we have a characteristic adaptation to circular form by the vase painter Epictetus.

In the early period of painting all the space not occupied by the figures is filled with patterns or accessories, or even animals which have no connexion with the subject (fig. 9). In later and more developed art,

as in this example, the outlines of the figures are so arranged as to fill the space.

When the space is square we have much the same problem as is presented by the metope spaces of a temple. In the case of both square and oblong fields the laws of balance are carefully observed. Thus if there is an even number of figures in the scheme, two of them will form a sort of centre-piece, those on either side balancing one another. If the number of figures is uneven, either there will be a group of three in the midst, or the midmost figure will be so contrived that he belongs wholly to neither side, but is the balance between them. These remarks will be made clear by figs. 2 and 3, which repeat the two sides

which represent the defeat of one of these by the other; the vanquished has commonly fallen on his knees, but still defends himself. There is a scheme for the leading away of a captive woman; the captor leads her by the hand looking back at her, while a friend walks behind to ward off pursuit. Such schemes are constantly varied in detail, and often very skillfully varied; but the Greek artist uses schemes as a sort of shorthand, to show as clearly as possible what he meant. They serve the same purpose as the mask in the acting of a play, the first glance at which will tell the spectators what they have to look for.

No doubt the great painters of Greece were not so much under the dominion of these schemes as the very inferior painters of vases. They used the schemes for their own purposes instead of being used by them. But as great poets do not revolt against the restrictions of the sonnet or of rhyme, so great artists in Greece probably found recognised conventions more helpful than hurtful.

Students of Greek sculpture and vases must be warned not to suppose that Greek reliefs and drawings can be taken as direct illustrations of Homer or the dramatists. Book illustration in the modern sense did not exist in Greece. The poet and the painter pursued courses which were parallel, but never in actual contact. Each moved by the traditions of his own craft. The poet took the accepted tale and enshined it in a setting of feeling and imagination. The painter took the traditional schemes which were current, and altered or enlarged them, adding new figures and new motives, but not attempting to set aside the general scheme. But varieties suitable to poetry were not likely to be suitable in painting. Thus it is but seldom that a vase-painter seems to have had in his mind, as he drew, passages of the Homeric poems, though these might well be familiar to him. And almost never does a vase-painting of the 5th century show any sign of the influence of the dramatists, who were bringing before the Athenian public on the stage many of the tales and incidents popular with the vase-painter. Only on vases of lower Italy of the 4th century and later we can occasionally discern something of Aeschylean and Euripidean influence in the treatment of a myth; and even in a few cases we may discern that the vase-painter has taken suggestions direct from the actors in the theatre.

3. *Historic Sketch.*—We propose next to trace in brief outline the history of Greek art from its rise to its decay. We begin with the rise of a national art, after the destruction of the



From *Wiener Vorleschblätter*, 1890, Pl. viii., by permission of the Director of the K. K. Österreich. Archäol. Institut.

FIG. 2. Vase Drawings.



FIG. 3.

of an amphora, one of which bears a design of three figures, the other of four.

The Greek artist not only adhered to the architectonic laws of balance and symmetry, but he thought in schemes. Certain group arrangements had a recognized signification. There are schemes for warriors fighting on equal terms, and schemes

Minoan and Mycenaean civilizations of early Greece by the irruption of tribes from the north, that is to say, about 800 B.C., and we stop with the Roman age of Greece, after which Greek art works in the service of the conquerors (see ROMAN ART). The period 800-50 B.C. we divide into four sections: (1) the period down to the Persian Wars, 800-480 B.C.; (2) the period

of the early schools of art, 480-400 B.C.; (3) the period of the later great schools, 400-300 B.C.; (4) the period of Hellenistic art, 300-50 B.C. In dealing with these successive periods we confine our sketch to the three greater branches of representative art, architecture, sculpture and painting, which in Greece are closely connected. The lesser arts, of pottery, gem-engraving, coin-stamping and the like, are treated of under the heads of CERAMICS, GEM, NUMISMATICS, &c., while the more technical treatment of architectural construction are dealt with under ARCHITECTURE and allied architectural articles. Further, for brief accounts of the chief artists the reader is referred to biographical articles, under such heads as PHIDIAS, PRAXITELES, APOLLO. We treat here only of the main course of art in its historic evolution.

Period I. 800-480 B.C.—The fact is now generally allowed that the Mycenaean, or as it is now termed Aegean, civilization was for the most part destroyed by an invasion from the north. This invasion appears to have been gradual; its racial character is much in dispute.

Archaeological evidence abundantly proves that it was the conquest of a more by a less rich and civilized race. In the graves of the period (900-600 B.C.) we find none of the wealthy spoil which has made celebrated the tombs of Mycenae and Vaphio (q.v.). The character of the pottery and the bronze-work which is found in these later graves reminds us of the art of the necropolis of Hallstatt in Austria, and other sites belonging to what is called the bronze age of North Europe. Its predominant characteristic is the use of geometrical forms, the lozenge, the triangle, the meander, the circle with tangents, in place of the elaborate spirals and plant-forms which mark Mycenaean ware. For this reason the period from the 9th to the 7th century in Greece passes by the name of "the Geometric Age." It is commonly held that in the remains of the Geometric Age we may trace the influence of the Dorians, who, coming in as a hardy but uncultivated race, probably of purer Aryan blood than the previous inhabitants of Greece, not only brought to an end the wealth and the luxury which marked the Mycenaean age, but also replaced an art which was in character essentially southern by one which belonged rather to the north and the west. The great difficulty inherent in this view, a difficulty which has yet to be met, lies in the fact that some of the most abundant and characteristic remains of the geometric age which we possess come, not from Peloponnesus, but from Athens and Boeotia, which were never conquered by the Dorians.

The geometric ware is for the most part adorned with painted patterns only. Fig. 4 is a characteristic example, a small two-handled vase from Rhodes in the Ashmolean Museum, the adornment of which consists in zigzags, circles with tangents, and lines of water birds, perhaps swans. Sometimes, however, especially in the case of large vases from the cemetery at Athens, which adjoins the Dipylon gate, scenes



FIG. 4.—Geometric Vase from Rhodes. (Ashmolean Museum.)

from Greek life are depicted, from daily life, not from legend or divine myth. Especially scenes from the lying-in-state and the burial of the dead are prevalent. An excerpt from a Dipylon vase (fig. 5) shows a dead man on his couch surrounded by mourners, male and female. Both sexes are apparently represented naked, and are distinguished very simply; some of them hold branches to sprinkle the corpse or to keep away flies. It

will be seen how primitive and conventional is the drawing of this age, presenting a wonderful contrast to the free drawing and modelling of the Mycenaean age. In the same graves with the pottery are sometimes found plaques of gold or bronze, and towards the end of the geometric age these sometimes bear scenes from mythology, treated with the greatest simplicity.



Mon. & Inst. ix. 30.

FIG. 5.—Corpse with Mourners.

For example, in the museum of Berlin are the contents of a tomb found at Corinth, consisting mainly of gold work of geometric decoration. But in the same tomb were also found gold plates or plaques of repoussé work bearing subjects from Greek

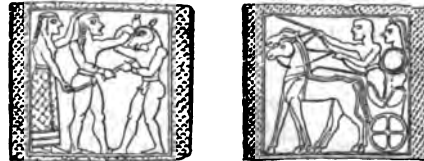

Arch. Zeit. 1884, 2.

FIG. 6.—Gold Plaques: Corinth.

legend. Two of these are shown in fig. 6. On one Theseus is slaying the Minotaur, while Ariadne stands by and encourages the hero. The tale could not have been told in a simpler or more straightforward way. On the other we have an armed warrior with his charioteer in a chariot drawn by two horses. The treatment of the human body is here more advanced than on the vases of the Dipylon. On the site of Olympia, where Mycenaean remains are not found, but the earliest monuments show the geometric style, a quantity of dedications in bronze have been found, the decoration of which belongs to this style. Fig. 7 shows the handle of a tripod from Olympia, which is adorned with geometric patterns and surmounted by the figure of a horse.



Olympia iv. 25.

FIG. 7.—Handle of Tripod.

It was about the 6th century that the genius of the Greeks, almost suddenly, as it seems to us, emancipated itself from the thralldom of tradition, and passed beyond the limits with which the nations of the east and west had hitherto been content, in a free and bold effort towards the ideal. Thus the 6th century marks

the stage in art in which it may be said to have become definitely Hellenic. The Greeks still borrowed many of their decorative forms, either from the prehistoric remains in their own country or, through Phœnician agency, from the old-world empires of Egypt and Babylon, but they used those forms freely to express their own meaning. And gradually, in the course of the century, we see both in the painting of vases and in sculpture a national spirit and a national style forming under the influence of Greek religion and mythology, Greek athletic training, Greek worship of beauty. We must here lay emphasis on the fact, which is sometimes overlooked in an age which is greatly given to the Darwinian search after origins, that it is one thing to trace back to its original sources the nascent art of Greece, and quite another thing to follow and to understand its gradual embodiment of Hellenic ideas and civilization. The immense success with which the veil has in late years been lifted from the prehistoric age of Greece, and the clearness with which we can discern the various strands woven into the web of Greek art, have tended to fix our attention rather on what Greece possessed in common with all other peoples at the same early stage of civilization than on what Greece added for herself to this common stock. In many respects the art of Greece is incomparable—one of the great inspirations which have redeemed the world from mediocrity and vulgarity. And it is the searching out and appreciation of this unique and ideal beauty in all its phases, in idea and composition and execution, which is the true task of Greek archaeological science.

In very recent years it has been possible, for the first time, to trace the influence of Ionian painting, as represented by vases, on the rise of art. The discoveries at Naucratis and Daphnæ in Egypt, due to the keenness and pertinacity of W. M. Flinders Petrie, threw new light on this matter. It became evident that when those cities were first inhabited by Ionian Greeks, in the 7th century, they used pottery of



Mss. Neptolm, 27.

FIG. 8.—Jug from Rhodes.

several distinct but allied styles, the most notable feature of which was the use of the lotus in decoration, the presence of continuous friezes of animals and of monsters, and the filling up of the background with rosettes, lozenges and other forms. Fig. 8 shows a vase found in Rhodes which illustrates this Ionian decoration. The sphinx, the deer and the swan are prominent on it, the last-named serving as a link between the geometric ware and the more brilliant and varied ware of the Ionian cities. The assignment of the many species of early Ionic ware to various Greek localities, Miletus, Samos, Phœcia and other cities, is a work of great difficulty, which now closely occupies the attention of archaeologists. For the results of their studies the reader is referred to two recent German works, Böhlau's *Aus ionischen und italischen Nekropolen*, and Endt's *Beiträge zur ionischen Vasenmalerei*. The feature which is most interesting in this pottery from our present point of view is the way in which representations of Greek myth and legend gradually make their way, and relegate the mere decoration of the vases to borders and neck. One of the earliest examples of representation of a really Greek subject is the contest of Menelaus and Euphorbus on a plate found in Rhodes. On the vases of Melos, of the 7th century, which are, however, not Ionian, but rather Dorian in character, we have a certain number of mythological scenes,

battles of Homeric heroes and the like. One of these is shown in fig. 9. It represents Apollo in a chariot drawn by winged horses, playing on the lyre, and accompanied by a pair of Muses, meeting his sister Artemis. It is notable that Apollo is bearded, and that Artemis holds her stag by the horns, much in the manner of the deities on Babylonian cylinders; in the other hand she carries an arrow; above is a line of water birds.

Some sites in Asia Minor and the islands adjoining, such cities as Samos, Camirus in Rhodes, and the Ionian colonies on the



Conse, Md. Tongelassr, 4.

FIG. 9.—Vase Painting: Melos.

Black Sea, have furnished us with a mass of ware of the Ionian class, but it seldom bears interesting subjects; it is essentially decorative. For Ionian ware which has closer relation to Greek mythology and history we must turn elsewhere. The cemeteries of the great Etruscan cities, Caere in particular, have preserved for us a large number of vases, which are now generally recognized as Ionian in design and drawing, though they may in some cases be only Italian imitations of Ionian imported ware. Thus has been filled up what was a blank page in the history of early Greek art. The Ionian painting is unrestrained in character, characterized by a licence not foreign to the nature of the race, and wants the self-control and moderation which belong to Doric art, and to Attic art after the first.

Some of the most interesting examples of early Ionic painting are found on the sarcophagi of Clazomenæ. In that city in archaic times an exceptional custom prevailed of burying the dead in great coffins of terra-cotta adorned with painted scenes from chariot-racing, war and the chase. The British Museum possesses some remarkable specimens, which are published in A. S. Murray's *Terra-Cotta Sarcophagi of the British Museum*. On one of them he sees depicted a battle between Cimmerian invaders and Greeks, the former accompanied to the field by their great war-dogs. In some of the representations of hunting on these sarcophagi the hunters ride in chariots, a way of hunting quite foreign to the Greeks, but familiar to us from Assyrian wall-sculptures. We know that the life of the Ionians before the Persian conquest was refined and not untinged with luxury, and they borrowed many of the stately ways of the satraps of the kings of Assyria and Persia.

Fig. 10 shows a curious product of the Ionian workshops, a fish of solid gold, adorned with reliefs which represent a flying

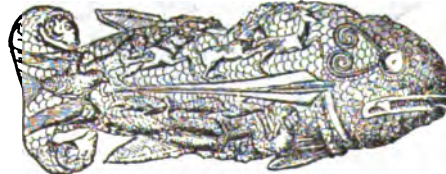

Parvulinger, Goldfund v. Veltersfelde.

FIG. 10.—Fish of Gold.

eagle, lions pulling down their prey, and a monstrous sea-god among his fishes. This relic is the more valuable on account of the spot where it was found—Veltersfelde in Brandenburg. It

furnishes a proof that the influence and perhaps the commerce of the Greek colonies on the Black Sea spread far to the north through the countries of the Scythians and other barbarians. The fish dates from the 6th century B.C.

We may compare some of the gold ornaments from Camirus in Rhodes, which show an Ionian tendency, perhaps combined with Phoenician elements. On one of them (fig. 11) we see a centaur with human forelegs holding up a fawn, on the other

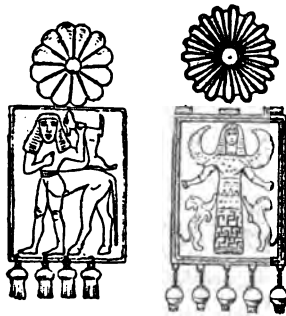

Brit. Mus.

FIG. 11.—Gold Ornaments from Camirus.

the oriental goddess whom the Greeks identified with their Artemis, winged, and flanked by lions. This form was given to Artemis on the Corinthian chest of Cypselus, a work of art preserved at Olympia, and carefully described for us by Pausanias. From Ionia the style of vase-painting which has been called by various names, but may best be termed the "orientalizing," spread to Greece proper. Its main home here was in Corinth; and small Corinthian unguent-vases bearing figures of swans, lions, monsters and human beings, the intervals between which are filled by rosettes, are found wherever Corinthian trade penetrated, notably in the cemeteries of Sicily. For the larger Corinthian vases, which bore more elaborate scenes from mythology, we must again turn to the graves of the cities of Etruria. Here, besides the Ionian ware, of which mention has already been made, we find pottery of three Greek cities clearly defined, that of Corinth, that of Chalcis in Euboea, and that of Athens. Corinthian and Chalcidian ware is most readily distinguished by means of the alphabets used in the inscriptions which have distinctive forms easily to be identified. Whether in the style of the paintings coming from the various cities any distinct differences may be traced is a far more difficult question, into which we cannot now enter. The subjects are mostly from heroic legend, and are treated with great simplicity and directness. There is a manly vigour about them which distinguishes them at a glance from the laxer works of Ionian style. Fig. 12 shows a group from a Chalcidian vase, which represents the conflict



Mon. & Inst. I. 51.

FIG. 12.—Fight over the Body of Achilles.

over the dead body of Achilles. The corpse of the hero lies in the midst, the arrow in his heel. The Trojan Glaucus tries to draw away the body by means of a rope tied round the ankle, but in doing so is transfixed by the spear of Ajax, who charges under the protection of the goddess Athena. Paris on the Trojan side shoots an arrow at Ajax.

In fig. 13, from a Corinthian vase, Ajax falls on his sword in the presence of his colleagues, Odysseus and Diomedes. The short stature of Odysseus is a well-known Homeric feature. These vases are black-figured; the heroes are painted in silhouette on

the red ground of the vases. Their names are appended in archaic Greek letters.

The early history of vase-painting at Athens is complicated. It was only by degrees that the geometric style gave way to, or developed into, what is known as the black-figured style. It would seem that until the age of Peisistratus Athens was not notable in the world of art, and nothing could be ruder than some of the vases of Athens in the 7th century,



Mus. Napolon, 66.

FIG. 13.—Suicide of Ajax.

for example that here figured, on one side of which are represented the winged Harpies (fig. 14) and on the other Perseus accompanied by Athena flying from the pursuit of the Gorgons. This vase retains in its decoration some features of geometric style; but the lotus and rosette, the lion and sphinx which appear on it, belong to the wave of Ionian influence. Although it involves a departure from strict chronological order, it will be well here to follow the course of development in pottery at Athens until the end of our period. Neighbouring cities, and especially Corinth, seem to have exercised a strong influence at Athens about the



Arch. Zeit. 1885, 9.

FIG. 14.—Harpies: Attic Vase.

7th century. We have even a class of vases called by archaeologists Corintho-Attic. But in the course of the 6th century there is formed at Athens a distinct and marked black-figured style. The most remarkable example of this ware is the so-called François vase at Munich, by Clitias and Ergotimus, which contains, in most careful and precise rendering, a number of scenes from Greek myth. One of these vases is dated, since it bears the name and the figure of Callias in his chariot (*Mon. dell' Inst.* iii. 45), and this Callias won a victory at Olympia in 564 B.C. Fig. 15 shows the reverse of a somewhat later black-figured vase of the Panathenaic class, given at Athens as a prize to the winner of a foot-race at the Panathenaea, with the foot-race (*stadion*) represented on it. A large number of Athenian vases of the 6th century have reached us, which bear the signatures of the potters who made, or the artists who painted them; lists of these will be found in the useful work of Klein, *Griechische Vasen mit Meistersignaturen*. The recent excavations on the

Acropolis have proved the erroneousess of the view, strongly maintained by Brunn, that the mass of the black-figured vases were of a late and imitative fabric. We now know that, with a few exceptions, vases of this class are not later than the early part of the 5th century. The same excavations have also proved that red-figured vase-painting, that is, vase-painting in which the background was blocked out with black, and the figures left in the natural colour of the vase originated at Athens in the last quarter of the 6th century. We cannot here give a



Mon. d. Inst. t. 48 m.

FIG. 15.—Foot-race: Panathenaic Vase.

detailed account of the beautiful series of Athenian vases of this fabric. Many of the finest of them are in the British Museum. As an example, fig. 16 presents a group by the painter Pamphaeus, representing Heracles wrestling with the river-monster Achelous, which belongs to the age of the Persian Wars. The clear precision of the figures, the vigour of the grouping, the correctness of the anatomy and the delicacy of the lines are all marks of distinction. The student of art will perhaps find the nearest parallel to these vase-pictures in Japanese drawings. The Japanese artists are very inferior to the Greek in their love and understanding of the human body, but equal them in freshness and vigour of design. At the same time began the beautiful series of white



Wittenberg, D. 6.

FIG. 16.—Heracles and Achelous.

vases made at Athens for the purpose of burial with the dead, and found in great quantities in the cemeteries of Athens, of Eretria, of Gela in Sicily, and of some other cities. They are well represented in the British Museum and that of Oxford.

We now return to the early years of the 6th century, and proceed to trace, by the aid of recent discoveries, the rise of architecture and sculpture. The Greek temple in its character and form gives the clue to the whole character of Greek art. It is the abode of the deity, who is represented by his sacred image; and the flat surfaces of the temple offer a great field to the sculptor for the depicting of sacred legend. The process of discovery has emphasized the line which divides Ionian from Dorian architecture and art. We will speak first of the temples

and the sculpture of Ionia. The Ionians were a people far more susceptible than were the Dorians to oriental influences. The dress, the art, the luxury of western Asia attracted them with irresistible force. We may suspect, as Brunn has suggested, that Ionian artists worked in the great Assyrian and Persian palaces, and that the reliefs which adorn the walls of those palaces were in part their handiwork. Some of the great temples of Ionia have been excavated in recent years, notably those of Apollo at Miletus, of Hera at Samos, and of Artemis at Ephesus. Very little, however, of the architecture of the 6th-century temples of those sites has been recovered. Quite recently, however, the French excavators at Delphi have successfully restored the treasury of the people of Cnidus, which is quite a gem of Ionic style, the entablature being supported in front not by pillars but by two maidens or Corac, and a frieze running all round the building above. But though this building is of



FIG. 17.—Restoration of the Treasury of Cnidus.

Ionic type, it is scarcely in the technical sense of Ionic style, since the columns have not Ionic capitals, but are carved with curious reliefs. The Ionic capital proper is developed in Asia by degrees (see ARCHITECTURE and CAPITAL; also Perrot and Chipiez, *Hist. de l'Art*, vii. ch. 4).

The Doric temple is not wholly of European origin. One of the earliest examples is the old temple of Assus in Troas. Yet it was developed mainly in Hellas and the west. The most ancient example is the Heraeum at Olympia, next to which come the fragmentary temples of Corinth and of Selinus in Sicily. With the early Doric temple we are familiar from examples which have survived in fair preservation to our own days at Agrigento in Sicily, Paestum in Italy, and other sites.

Of the decorative sculpture which adorned these early temples we have more extensive remains than we have of actual construction. It will be best to speak of them under their districts. On the coast of Asia Minor, the most extensive series of archaic decorative sculptures which has come down to us is that which adorned the temple of Assus (fig. 18). These were placed in a unique position on the temple, a long frieze running along the entablature, with representations of wild animals, of centaurs, of Hercules seizing Achelous, and of men feasting, scene succeeding scene without much order or method. The only figures from Miletus which can be considered as belonging to the original temple destroyed by Darius, are the dedicated seated statues, some of which, brought away by Sir Charles Newton, are now preserved at the British Museum. At Ephesus Mr Wood has been more successful, and has recovered considerable fragments

of the temple of Artemis, to which, as Herodotus tells us, Croesus presented many columns. The lower part of one of these columns, bearing figures in relief of early Ionian style, has been put together at the British Museum; and remains of inscriptions recording the presentation by Croesus are still to be traced. Reliefs from a cornice of somewhat later date are also to be found at the British Museum. Among the Aegean islands,



From Perrot and Chipiez, vii. pl. 35, by permission of Chapman and Hall, Ltd., and Hachette & Co.

FIG. 18.—Restoration of the Temple at Assus.

Delos has furnished us with the most important remains of early art. French excavators have there found a very early statue of a woman dedicated by one Nicandra to Artemis, a figure which may be instructively compared with another from Samos, dedicated to Hera by Cheramueus. The Delian statue is in shape like a flat beam; the Samian, which is headless, is like a round tree. The arms of the Delian figure are rigid to the sides; the Samian lady has one arm clasped to her breast. A great improvement on these helpless and inexpressive figures is marked by another figure found at Delos, and connected, though perhaps incorrectly, with a basis recording the execution of a statue by Archermus and Micciades, two sculptors who stood, in the middle of the 6th century, at the head of a sculptural school at Chios. The representation (fig. 19) is of a running or flying figure, having six wings, like the seraphim in the vision of



FIG. 19.—Nike of Delos, restored.

Isaiah, and clad in long drapery. It may be a statue of Nike or Victory, who is said to have been represented in winged form by Archermus. The figure, with its neatness and precision of work, its expressive face and strong outlines, certainly marks great progress in the art of sculpture. When we examine the

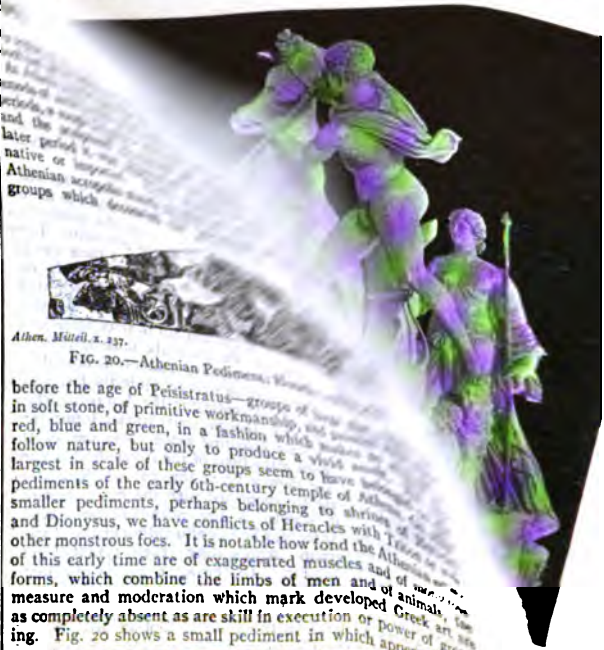

Athen. Mittell. x. 237.

FIG. 20.—Athenian Pediment; Heracles and Athena.

before the age of Peisistratus—groups of large size, in soft stone, of primitive workmanship, and generally in red, blue and green, in a fashion which follows nature, but only to produce a vivid and not a true likeness. The largest in scale of these groups seem to have been the pediments of the early 6th-century temple of Athena at Peisistratus, perhaps belonging to shrines of Athena and Dionysus, we have conflicts of Heracles with Typhon and other monstrous foes. It is notable how fond the Athenians of this early time are of exaggerated muscles and of forms, which combine the limbs of men and of animals, the measure and moderation which mark developed Greek art, as completely absent as are skill in execution or power of grouping. Fig. 20 shows a small pediment in which appears in relief



Athen. Mittell. xxii. 2.

FIG. 21.—Pediment: Athena and Giant.

the slaying of the Lernaean hydra by Heracles. The hero strikes at the many-headed water-snake, somewhat inappropriately, with his club. Iolaus, his usual companion, holds the reins of the chariot which awaits Heracles after his victory. On the extreme left a huge crab comes to the aid of the hydra. There can be little doubt that Athens owed its great start in art to the influence of the court of Peisistratus, at which artists of all kinds were welcome. We can trace a gradual transformation in sculpture, in which the influence of the Chian and other progressive schools of sculpture is visible, not only in the substitution of island marble for native stone, but in increased grace and truth to nature, in the toning down of glaring colour, and the appearance of taste in composition. A transition

between the older and the newer is furnished by the well-known statue of the calf-bearer, an Athenian preparing to sacrifice a calf to the deities, which is made of marble of Hymettus, and in robust clumsiness of forms is not far removed from the limestone pediments. The sacrificer has been commonly spoken of as Hermes or Theseus, but he seems rather to be an ordinary human votary.



FIG. 22.—Figure by Antenor, restored.

In the time of Peisistratus or his sons a peristyle of columns was added to the old temple of Athena; and this necessitated the preparation of fresh pediments. These were of marble. In one of them was represented the battle between gods and giants; in the midst Athena herself striking at a prostrate foe (fig. 21). In these figures no eye can fail to trace remarkable progress. On about the same level of art are the charming statues dedicated to Athena, which were set up in the latter half of the 6th century in the Acropolis, whose graceful though conventional forms and delicate colouring make them one of the great attractions of the Acropolis Museum. We show a figure (fig. 22) which, if it be rightly connected with the basis on which it stands, is the work of the sculptor Antenor, who was also author of a celebrated group representing the tyrant-slayers, Harmodius and Aristogiton. To the same age belong many other votive reliefs of the Acropolis, representing horsemen, scribes and other votaries of Athena.

From Athens we pass to the seats of Dorian art. And in doing so we find a complete change of character. In place of draped goddesses and female figures, we find nude male forms. In place of Ionian softness and elegance, we find hard, rigid outlines, strong muscular development, a greater love of and faithfulness to the actual human form—the influence of the palaestra rather than of the harem.



FIG. 23.—Bust from Crete.

To the known series of archaic male figures, recent years have added many examples. We may especially mention a series of figures from the temple of Apollo Ptoos in Boeotia, probably representing the god himself. Still more noteworthy are two colossal nude figures of Apollo, remarkable both for force and for rudeness, found at Delphi, the inscriptions of which prove them to be the work of an Argive sculptor. (Plate V. fig. 76.) From Crete we have acquired the upper

part of a draped figure (fig. 23), whether male or female is not certain, which should be an example of the early Daedalic school, whence the art of Peloponnesus was derived; but we can scarcely venture to treat it as a characteristic product of that school; rather the likeness to the dedication of Nicandra is striking.

Another remarkable piece of Athenian sculpture, of the time of the Persian Wars, is the group of the tyrannicides Harmodius

and Aristogiton, set up by the people of Athens, and made by the sculptors Critius and Nesiotes. These figures were hard and rigid in outline, but showing some progress in the treatment of the nude. Copies are preserved in the museum of Naples (Plate I. fig. 50). It should be observed that one of the heads does not belong.

Next in importance to Athens, as a find-spot for works of early Greek art, ranks Olympia. Olympia, however, did not suffer like Athens from sudden violence, and the explorations there have brought to light a continuous series of remains, beginning with the bronze tripods of the geometric age already mentioned and ending at the barbarian invasions of the 4th century A.D. Notable among the 6th-century stone-sculpture of Olympia are the

Olympia,
Sparta,
Sollers.



FIG. 24.—Head of Hera: Olympia.

pediment of the treasury of the people of Megara, in which is represented a battle of gods and giants, and a huge rude head of Hera (fig. 24), which seems to be part of the image worshipped in the Heraeum. Its flatness and want of style are noteworthy. Among the temples of Greece proper the Heraeum of Olympia stands almost alone for antiquity and interest, its chief rival, besides the temples of Athens, being the other temple of Hera at Argos. It appears to have been originally constructed of wood, for which stone was by slow degrees, part by part, substituted. In the time of Pausanias one of the pillars was still of oak, and at the present day the varying diameter of the columns and other structural irregularities bear witness to the process of constant renewal which must have taken place. The early small bronzes of Olympia form an important series, figures of deities standing or striding, warriors in their armour, athletes with exaggerated muscles, and women draped in the Ionian fashion, which did not become unpopular in Greece until after the Persian Wars. Excavations at Sparta have revealed interesting monuments belonging to the worship of ancestors, which seems in the conservative Dorian states of Greece to have been more strongly developed than elsewhere. On some of these stones, which doubtless belonged to the family cults of Sparta, we see the ancestor seated holding a wine-cup, accompanied by his faithful horse or dog; on some we see the ancestor and ancestress seated side by side (fig. 25), ready to receive the gifts of their descendants, who appear in the corner of the relief on a much smaller scale. The male figure holds a wine-cup, in allusion to the libations of wine made at the tomb. The female figure holds her veil and the pomegranate, the recognized food of the dead. A huge serpent stands erect behind the pair. The style of these sculptures is as striking as the subjects; we see lean, rigid



FIG. 25.—Spartan Tombstone: Berlin.



Photo, Brogi.
Fig. 50.—Harmodius and Aristogiton.
(Nat. Mus., Naples.)



Photo, Brogi.
Fig. 51.—Farnese Bull. (Naples.)



Photo, Anderson.
Fig. 52.—Laocoon Group. (Vatican.)



Photo, Anderson.
Fig. 53.—Ganymede of Leochares. (Vatican.)



Photo, Anderson.
Fig. 54.—Flaying of Marsyas. (Villa Albani, Rome.)



Photo, Anderson.
Fig. 55.—Apollo of the Belvedere. (Vatican.)



Fig. 56.—Head of young Alexander. (Brit. Mus.)



Photo, Seebah.
Fig. 57.—Hermes of Alcamenes. (Constantinople.)



Fig. 58.—Theseus and Amazon (Eretria).



Photo, Mansell.
Fig. 59.—Drum of Column from Ephesus. (Brit. Mus.)



Photo, Baldwin Coolidge.
Fig. 60.—Young Hermes. (Mus. of Fine Arts, Boston.)

GREEK ART

PLATE III.



Photo, Giraudon.
 Fig. 61.—Winged Victory of Samothrace. (LOUVRE.)



Photo, Giraudon.
 Fig. 62.—Winged Victory of Samothrace. (LOUVRE.)



Photo, Anderson.
 Fig. 64.—Marsyas of Myron. (LATERAN MUS.)



Fig. 63.—Head of Warrior, Restored, from Tegea.



Photo, Mansell.
 Fig. 65.—East Pediment of the Parthenon: left and right ends. (BRIT. MUS.)



Fig. 66.—Metope of the Treasury of Sicyon at Delphi.
(From *Fouilles de Delphes*, by permission of A. Fontemoing.)



Fig. 67.—Greek Painting of Woman's Head.
(From *Comptes Rendus* of St. Petersburg, 1865, Pl. I.)



Photo, F. Bruckmann.
Fig. 68.—Discobolus of Myron, Restored by Prof. Furtwängler.



Photo, Giraudon.
Fig. 69.—Fighter of Agasias. (LOUVRE.)



Photo, Mansell.
Fig. 70.—Portion of Frieze of Mausoleum. (BRIT. MUS.)

GREEK ART

PLATE V.



From a Cast.
Fig. 71.—Aphrodite of Cnidus.
(Vatican.)



Photo, Anderson.
Fig. 72.—Bronze Boxer of Terme.
(Rome.)



Fig. 73.—Bronze of Cerigotto.
(Athens.) Found in the sea
near Cythera.



Fig. 74.—Agias at Delphi.
(From *Fouilles de Delphes*, by
permission of A. Fontemoing.)



Fig. 75.—Cora (Koré) of Erechtheum.
(Athens.)



Fig. 76.—Apollo at Delphi.
(From *Fouilles de Delphes*, by
permission of A. Fontemoing.)



Photo, Giraudon.
Fig. 77.—Aphrodite of Melos. (Louvre.)



Photo, Alinari.
Fig. 78.—Niobe and Her Youngest Daughter. (Florence.)



Photo, Anderson.
Fig. 79.—Apoxyomenus. (Vatican.)



Photo, Brogi.
Fig. 80.—Doryphorus of Polyclitus. (Nat. Mus., Naples.)



Photo, Alinari.
Fig. 81.—Antioch Seated on a Rock. (Vatican.)



Photo, English Photographic Co.
Fig. 82.—Hermes of Praxiteles. (Olympia.)

forms with severe outline carved in a very low relief, the surface of which is not rounded but flat. The name of Selinus in Sicily, an early Megarian colony, has long been associated with some of the most curious of early sculptures; the metopes of ancient temples, representing the exploits of Heracles and of Perseus. Even more archaic metopes have in recent years been brought to light, one representing a seated sphinx; one the journey of Europa over the sea on the back of the amorous bull (fig. 26), a pair of dolphins swimming beside her. In simplicity and in rudeness of work these reliefs remind us of the limestone pediments of Athens (fig. 20), but yet they are of another and a severer style; the Ionian laxity is wanting.

The recent French excavations at Delphi add a new and important chapter to the history of 6th-century art. Of three Delphi treasure-houses, those of Sicyon, Cnidus and Athens, the sculptural adornments have been in great part recovered. These sculptures form a series almost covering the century 570-470 B.C., and include representations of some myths



FIG. 26.—Metope; Europa on Bull: Palermo.

of which we have hitherto had no example. We may say here a few words as to the sculpture which has been discovered, leaving to the article DELPHI an account of the topography and the buildings of the sacred site. Of the archaic temple of Apollo, built as Herodotus tells us by the Alcmaeonidae of Athens, the only sculptural remains which have come down to us are some fragments of the pedimental figures. Of the treasures which contained the offerings of the pious at Delphi, the most archaic of which there are remains is that belonging to the people of Sicyon. To it appertain a set of exceedingly primitive metopes. One represents Idas and Dioscuri driving off cattle (Plate IV, fig. 66); another, the ship Argo; another, Europa on the bull, others merely animals, a ram or a boar. The treasury of the people of Cnidus (or perhaps Siphnos) is in style some half a century later (see fig. 17). To it belongs a long frieze representing a variety of curious subjects: a battle, perhaps between Greeks

and Castor and Pollux; Aeolus holding the winds in sacks. The Treasury of the Athenians, erected at the time of the Persian Wars, was adorned with metopes of singularly clear-cut and beautiful style, but very fragmentary, representing the deeds of Heracles and Theseus.

We have yet to speak of the most interesting and important of all Greek archaic sculptures, the pediments of the temple at Aegina (*q.v.*). These groups of nude athletes fighting over the corpses of their comrades are preserved at Munich, and are familiar to artists and students. But the very fruitful excavations of Professor Furtwängler have put them in quite a new light. Furtwängler (*Aegina: Heiligtum der Aphaia*) has entirely rearranged these pediments, in a way which removes the extreme simplicity and rigour of the composition, and introduces far greater variety of attitudes and motive. We repeat here these new arrangements (figs. 27 and 28), the reasons for which must be sought in Furtwängler's great publication. The individual figures are not much altered, as the restorations of Thorwaldsen, even when incorrect, have now a prescriptive right of which it is not easy to deprive them. Besides the pediments of Aegina must be set the remains of the pediments of the temple of Apollo at Eretria in Euboea, the chief group of which (Plate II, fig. 58), Theseus carrying off an Amazon, is one of the most finely executed works of early Greek art.

Period II. 480-400 B.C.—The most marvellous phenomenon in the whole history of art is the rapid progress made by Greece in painting and sculpture during the 5th century B.C. As in literature the 5th century takes us from the rude peasant plays of Thespis to the drama of Sophocles and Euripides; as in philosophy it takes us from Pythagoras to Socrates; so in sculpture it covers the space from the primitive works made for the Peisistratidae to some of the most perfect productions of the chisel.

In architecture the 5th century is ennobled by the Theseum, the Parthenon and the Erechtheum, the temples of Zeus at Olympia, of Apollo at Phigalia, and many other central shrines, as well as by the Hall of the Mystae at Eleusis and the Propylaea of the Acropolis. Some of the most important of the Greek temples of Italy and Sicily, such as those of Segesta and Selinus, date from the same age. It is, however, only of their sculptural decorations, carried out by the greatest masters in Greece, that we need here treat in any detail.

It is the rule in the history of art that innovations and technical progress are shown earlier in the case of painting than in that of sculpture, a fact easily explained by the greater ease and rapidity of the brush compared with the chisel. That this was the order of development in Greek art cannot be doubted. But our means for judging of the painting of the 5th century are very slight. The noble paintings of such masters



FIG. 27.—Restoration of West Pediment, Aegina.

as Polygnotus, Micon and Panaenus, which once adorned the walls of the great porticoes of Athens and Delphi, have disappeared. There remain only the designs drawn rather than painted on the beautiful vases of the age, which in some degree help us to realize, not the colouring or the charm of contemporary



FIG. 28.—Restoration of East Pediment, Aegina.

help us to realize, not the colouring or the charm of contemporary

paintings, but the principle of their composition and the accuracy of their drawing.

Polygnotus of Thasos was regarded by his compatriots as a great ethical painter. His colouring and composition were alike very simple, his figures quiet and statuesque, his drawing careful and precise. He won his fame largely by incorporating in his works the best current ideas as to mythology, religion and morals. In particular his painting of Hades with its rewards and punish-



From *Monumenti dell' Instituto di Correspondenza archeologica*, xi. 40.
FIG. 29.—Vase of Orvieto. (The Children of Niobe.)

ments, which was on the walls of the building of the people of Cnidus at Delphi, might be considered as a great religious work, parallel to the paintings of the Campo Santo at Pisa or to the painted windows of such churches as that at Fairford. But he also introduced improvements in perspective and greater freedom in grouping.

It is fortunate for us that the Greek traveller Pausanias has left us very careful and detailed descriptions of some of the most important of the frescoes of Polygnotus, notably of the Taking of Troy and the Visit to Hades, which were at Delphi. A comparison of these descriptions with vase paintings of the middle of the 5th century has enabled us to discern with great probability the principles of Polygnotan drawing and perspective. Professor Robert has even ventured to restore the paintings on the evidence of vases. We here represent one of the scenes depicted on a vase found at Orvieto (fig. 29), which is certainly Polygnotan in character. It represents the slaying of the children of Niobe by Apollo and Artemis. Here we may observe a remarkable perspective. The different heights of the rocky background are represented by lines traversing the picture on which the figures stand; but the more distant figures are no smaller than the nearer. The forests of Mount Sipylus are represented by a single conventional tree.



Arch. Zeit. 1878, pl. 22.

FIG. 30.—Vase Drawing

beautifully drawn, and full of charm; but there is a want of energy in the action.

There can be little doubt that the school of Polygnotus exercised great influence on contemporary sculpture. Panaenus, brother of Phidias, worked with Polygnotus, and many of the groupings found in the sculptures of the Parthenon remind us of those usual with the Thasian master. At this simple and early stage of art there was no essential difference between fresco-

painting and coloured relief, light and shade and aerial perspective being unknown. We reproduce two vase-paintings, one (fig. 30) a group of man and horse which closely resembles figures in the Panathenaic frieze of the Parthenon (fig. 31); the other (fig. 32) representing Victory pouring water for a sacrificial ox to drink, which reminds us of the balustrade of the shrine of Wingless Victory at Athens.

Most writers on Greek painting have supposed that after the middle of the 5th century the technique of painting rapidly improved. This may well have been the case; but we have little means of testing the question. Such improvements would soon raise such a barrier between fresco-painting and vase-painting,—

which by its very nature must be simple and architectonic,—that vases can no longer be used with confidence as evidence for contemporary painting. The stories told us by Pliny of the lives of Greek painters are mostly of a trivial and untrustworthy character. Some of them are mentioned in this *Encyclopaedia* under the names of individual artists. We can only discern a few general facts. Of Agatharchus of Athens we learn that he painted, under compulsion, the interior of the house of Alcibiades. And we are told that he painted a scene for the tragedies of Aeschylus or Sophocles. This has led some writers to suppose that he attempted illusive landscape; but this is contrary to the possibilities of the time; and it is fairly certain that what he really did was to paint the wooden front of the stage building in imitation of architecture; in fact he painted a permanent architectural background, and not one suited to any particular play. Of other painters who flourished at the end of the century, such as Zeuxis and Aristides, it will be best to speak under the next period.

It is now generally held, in consequence of evidence furnished by tombs, that the 5th century saw the end of the making of

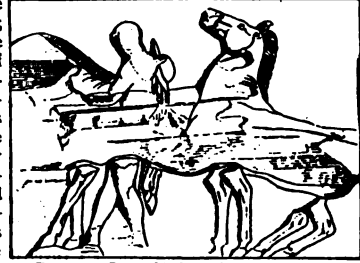

FIG. 31.—Part of Frieze of the Parthenon.



From Gerhards' *Ausgewählte Vasenbilder*, ii. pl. 1.

FIG. 32.—Nikē and Bull.

vases on a great scale at Athens for export to Italy and Sicily. And in fact few things in the history of art are more remarkable than the rapidity with which vase-painting at Athens reached its highest point and passed it on the downward road. At the beginning of the century black-figured ware was scarcely out of fashion, and the masters of the severe red-figured style, Pamphaeus, Epictetus and their contemporaries, were in vogue.

The schools of Euphronius, Hiero and Duris belong to the age of the Persian war. With the middle of the century the works of these makers are succeeded by unsigned vases of most beautiful design, some of them showing the influence of Polygnotus. In the later years of the century, when the empire of Athens was approaching its fall, drawing becomes laxer and more careless, and in the treatment of drapery we frequently note the over-elaboration of folds, the want of simplicity, which begin to mark contemporary sculpture. These changes of style can only be

stood Zeus the supreme arbiter. On one side of him stood Oenomaüs with his wife Sterope, on the other Pelops and Hippodameia, the daughter of Oenomaüs, whose position at once indicates that she is on the side of the newcomer, whatever her parents may feel. Next on either side are the four-horse chariots of the two competitors, that of Oenomaüs in the charge of his perfidious groom Myrtilus, who contrived that it should break down in the running, that of Pelops tended by his grooms. At either end, where the pediment narrows to a point, reclines a

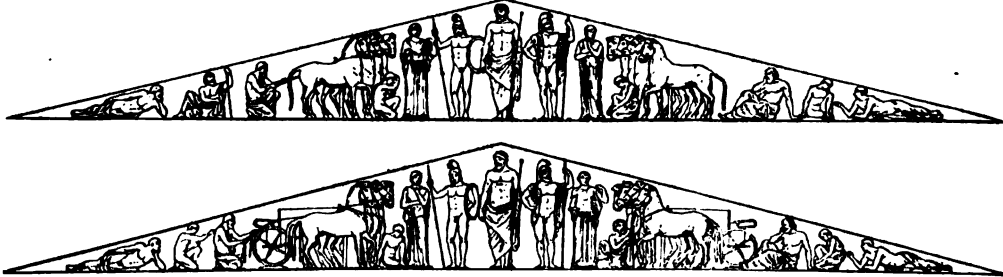

FIG. 33.—East Pediment, Olympia. Two Restorations.

satisfactorily followed in the vase rooms of the British Museum, or other treasuries of Greek art (see also A. B. Walters, *History of Ancient Pottery*; and the article CERAMICS).

Among the sculptural works of this period the first place may be given to the great temple of Zeus at Olympia. The statue by Pheidias which once occupied the place of honour in that temple, and was regarded as the noblest monument of Greek religion, has of course disappeared, nor

are we able with confidence to restore it. But the plan of the temple, its pavement, some of its architectural ornaments, remain. The marbles which occupied the pediments and the metopes of the temple have been in large part recovered, having been probably thrown down by earthquakes and gradually buried in the alluvial soil. The utmost ingenuity and science of the archaeologists of Germany have been employed in the recovery of the composition of these groups; and although doubt remains as to the places of some figures, and their precise attitudes, yet we may fairly say that we know more about the sculpture of

river god, at one end Alpheus, the chief stream of Olympia, at the other end his tributary Cladus. Only one figure remains, not noticed in the careful description of Pausanias, the figure of a handmaid kneeling, perhaps one of the attendants of Sterope. Our engraving gives two conjectural restorations of the pediment, that of Treu and that of Kekule, which differ principally in the arrangement of the corners of the composition; the position of the central figures and of the chariots can scarcely be called in question. The moment chosen is one, not of action, but of expectancy, perhaps of preparation for sacrifice. The arrangement is undeniably stiff and formal, and in the figures we note none of the trained perfection of style which belongs to the sculptures of the Parthenon, an almost contemporary temple. Faults abound, alike in the rendering of drapery and in the representation of the human forms, and the sculptor has evidently trusted to the painter who was afterwards to colour his work, to remedy some of his clumsiness, or to make clear the ambiguous. Nevertheless there is in the whole a dignity, a

soberly, and a simplicity, which reconcile us to the knowledge that this pediment was certainly regarded in antiquity as a noble work, fit to adorn even the palace of Zeus. In the other, the western pediment (fig. 34), the subject is the riot of the Centaurs when they attended the wedding of Peirithous in Thessaly, and, attempting to carry off the bride and her comrades, were slain by Peirithous and Theseus. In the midst of the pediment, invisible like Zeus in the eastern pediment, stands Apollo, while on either side of him Theseus and Peirithous attack the Centaurs with weapons hastily snatched. Our illustration gives two possible arrangements. The monsters are in various attitudes

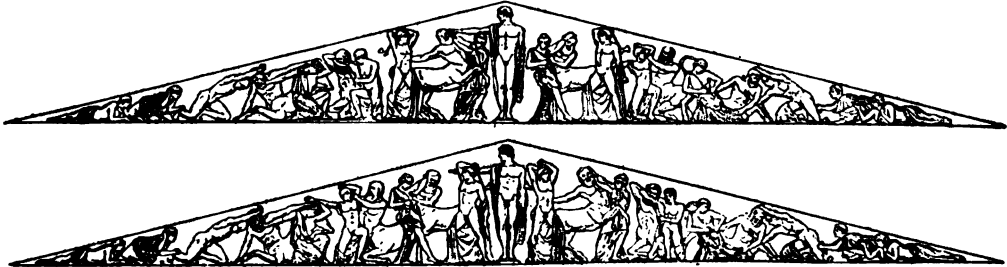

FIG. 34.—West Pediment, Olympia. Two Restorations.

the Olympian temple of Zeus than about the sculpture of any other great Greek temple. The exact date of these sculptures is not certain, but we may with some confidence give them to 470-460 B.C. (In speaking of them we shall mostly follow the opinion of Dr Treu, whose masterly work in vol. iii. of the great German publication on Olympia is a model of patience and of science.) In the eastern pediment (fig. 33), as Pausanias tells us, were represented the preparations for the chariot-race between Oenomaüs and Pelops, the result of which was to determine whether Pelops should find death or a bride and a kingdom. In the midst, invisible to the contending heroes,

sobriety, and a simplicity, which reconcile us to the knowledge that this pediment was certainly regarded in antiquity as a noble work, fit to adorn even the palace of Zeus. In the other, the western pediment (fig. 34), the subject is the riot of the Centaurs when they attended the wedding of Peirithous in Thessaly, and, attempting to carry off the bride and her comrades, were slain by Peirithous and Theseus. In the midst of the pediment, invisible like Zeus in the eastern pediment, stands Apollo, while on either side of him Theseus and Peirithous attack the Centaurs with weapons hastily snatched. Our illustration gives two possible arrangements. The monsters are in various attitudes

of attempted violence, of combat and defeat; with each grapples one of the Lapith heroes in the endeavour to rob them of their prey. In the corners of the pediment recline female figures, perhaps attendant slaves, though the farthest pair may best be identified as local Thessalian nymphs, looking on with the calmness of divine superiority, yet not wholly unconcerned in what is going forward. Though the composition of the two pediments differs notably, the one bearing the impress of a parade-like repose, the other of an overstrained activity, yet



Olympia, iii. 45.
FIG. 35.—Metope: Olympia; restored.

the style and execution are the same in both, and the shortcomings must be attributed to the inferior skill of a local school of sculptors compared with those of Athens or of Aegina. It even appears likely that the designs also belong to a local school. Pausanias, it is true, tells us that the pediments were the work of Alcámenes, the pupil of Pheidias, and of Paeonius, a sculptor of Thrace, respectively; but it is almost certain that he was misled by the local guides, who would naturally be anxious to connect the sculptures of their great temple with well-known names.



Olympia, iii. 48.
FIG. 36.—Nike of Paionius; restored.

The metopes of the temple are in the same style of art as the pediments, but the defects of awkwardness and want of mastery are less conspicuous, because the narrow limits of the metope exclude any elaborate grouping. The subjects are provided by the twelve labours of Heracles; the figures introduced in each metope are but two or at most three; and the action is simplified as much as possible. The example shown (fig. 35) represents

Heracles holding up the sky on a cushion, with the friendly aid of a Hesperid nymph, while Atlas, whom he has relieved of his usual burden, approaches bringing the apples which it was the task of Heracles to procure. Another of the fruits of the excavations of Olympia is the floating Victory by Paonius, unfortunately faceless (fig. 36), which was set up in all probability in memory of the victory of the Athenians and their Messenian allies at Sphacteria in 425 B.C. The inscription states that it was dedicated by the Messenians

and people of Naupactus from the spoils of their enemies, but the name of the enemy is not mentioned in the inscription. The statue of Paonius, which comes floating down through the air with drapery borne backward, is of a bold and innovating type, and we may trace its influence in many works of the next age.

Among the discoveries at Delphi none is so striking and valuable to us as the life-size statue in bronze of a charioteer holding in his hand the reins. This is maintained *Belgiate* by M. Homolle to be part of a chariot-group set up *chariotier* by Polyzalus, brother of Gelo and Hiero of Syracuse, in honour of a victory won in the chariot-race at the Pythian games at Delphi (fig. 37). The charioteer is evidently a high-born youth, and is clad in the long chiton which was necessary to protect a driver of a chariot from the rush of air. The date would be about 480-470 B.C. Bronze groups representing victorious chariots with their drivers were among the noblest and most costly dedications of antiquity; the present figure is our only satisfactory representative of them. In style the figure is very notable, tall and slight beyond all contemporary examples. The contrast between the conventional decorousness of face and drapery and the lifelike accuracy of hands and



Mémoires, *Pinel*, 1897, 16.
FIG. 37.—Bronze Charioteer: Delphi.

feet is very striking, and indicates the clashing of various tendencies in art at the time when the great style was formed in Greece.

The three great masters of the 5th century, Myron, Pheidias and Polyclitus are all in some degree known to us from their works. Of Myron we have copies of two works, the Marsyas (Plate III. fig. 64) and the Discobolus. The Marsyas (a copy in the Lateran Museum) represents the Satyr so named in the grasp of conflicting emotions, eager to pick up the flutes which Athena has thrown down, but at the same time dreading her displeasure if he does so. The Discobolus has usually been judged from the examples in the Vatican and the British Museum, in which the anatomy is modernized and the head wrongly put on. We have now photographs of the very superior replica in the Lancelotti gallery at Rome, the pose of which is much nearer to the original. Our illustration represents a restoration made at Munich, by combining the Lancelotti head with the Vatican body (Plate IV. fig. 68).

Of the works of Pheidias we have unfortunately no certain copy, if we except the small replicas at Athens of his Athena Parthenos. The larger of these (fig. 38) was found in 1880; it is very clumsy, and the wretched device by which a pillar is introduced to support the Victory in the hand of Athena can scarcely be supposed to have belonged to the great original. Tempting theories have been published by Furtwängler (*Masterpieces of Greek Sculpture*) and other archaeologists, which identify copies of the Athena Lemnia of Pheidias, his Pantarces,

his Aphrodite Uranis and other statues; but doubt hangs over all these attributions.

A more pertinent and more promising question is, how far we may take the decorative sculpture of the Parthenon, since Lord Elgin's time the pride of the British Museum, as the actual work of Pheidias, or as done from his designs. Here again we have no conclusive evidence; but it appears from the testimony of inscriptions that the pediments at all events were not executed until after Pheidias's death.

Of these the pediments and frieze of the Parthenon (*q. v.*), whose work soever they may be, stand at the head of all Greek decorative sculpture.



FIG. 38.—Statuette of Athena Parthenos. In A. S. Murray's *Sculptures of the Parthenon*.

An abundant literature has sprung up in regard to these sculptures in recent years. It will suffice here to mention the discussions in Furtwängler's *Masterpieces*, and the very ingenious attempts of Sauer to determine by a careful examination of the bases and backgrounds of the pediments as they now stand how the figures must have been arranged in them. The two ends of the eastern pediment (Plate III. fig. 65) are the only fairly well-preserved part of the pediments.

Among the pupils of Pheidias who may naturally be supposed to have worked on the sculptures of the Parthenon, the most notable were Alcámenes and Agoracritus. Some fragments remain of the great statue of Nemesis at Rhamnus by Agoracritus. And an interesting light has been thrown on Alcámenes by the discovery at Pergamum of a professed copy of his Hermes set up at the entrance to the Acropolis at Athens (Plate II. fig. 57). The style of this work, however, is conventional and archaic, and we can scarcely regard it as typical of the master.

Another noted contemporary who was celebrated mainly for his portraits was Cresilas, a Cretan. Several copies of his portrait of Pericles exist, and testify to the lofty and idealizing style of portraiture in this great age.

We possess also admirable sculpture belonging to the other important temples of the Acropolis, the Erechtheum and the temple of Nike. The temple of Nike is the earlier, being possibly a memorial of the Spartan defeat at Sphacteria. The Erechtheum belongs to the end of our period, and embodies the delicacy and finish of the conservative school of sculpture at Athens just as the Parthenon illustrates the ideas of the more progressive school. The reconstruction of the Erechtheum has been a task which has long occupied the attention of archaeologists (see the paper by Mr Stevens in the *American Journal of Archaeology*, 1906). Our illustration (Plate V. fig. 75) shows one of the Corae or maidens who support the entablature of the south porch of the Erechtheum in her proper setting. This use of the female figure in place of a pillar is based on old Ionian

precedent (see fig. 17) and is not altogether happy; but the idea is carried out with remarkable skill, the perfect repose and solid strength of the maiden being emphasized.

Beside Pheidias of Athens must be placed the greatest of early Argive sculptors, Polyclitus. His two typical athletes, the Doryphorus or spear-bearer (Plate VI. fig. 80) and the Diadumenus, have long been identified, and though the copies are not first-rate, they enable us to recover the principles of the master's art.

Among the bases discovered at Olympia, whence the statues had been removed, are three or four which bear the name of Polyclitus, and the definite evidence furnished by these bases as to the position of the feet of the statues which they once bore has enabled archaeologists, especially Professor Furtwängler, to identify copies of those statues among known works. Also newly discovered copies of Polyclitan works have made their appearance. At Delos there has been found a copy of the Diadumenus, which is of much finer work than the statue in the British Museum from Vaison. The Museum of Fine Arts at Boston, U.S.A., has secured a very beautiful statue of a young Hermes, who but for the wings on the temples might pass as a boy athlete of Polyclitan style (Plate II. fig. 60). In fact, instead of relying as regards the manner of Polyclitus on Roman copies of the Doryphorus and Diadumenus, we have quite a gallery of athletes, boys and men, who all claim relationship, nearer or more remote, to the school of the great Argive master. It might have been hoped that the excavations, made under the leadership of Professor Waldstein at the Argive Heraeum, would have enlightened us as to the style of Polyclitus. Just as the sculptures of the Parthenon are the best monument of Pheidias, so it might seem likely that the sculptural decoration of the great temple which contained the Hera of Polyclitus would show us at large how his school worked in marble. Unfortunately the fragments of sculpture from the Heraeum are few. The most remarkable is a female head; which may perhaps come from a pediment (fig. 39). But archaeologists are not in agreement whether it is in style Poly-



FIG. 39.—Female Head: Heraeum.

clitan or whether it rather resembles in style Attic works. Other heads and some highly-finished fragments of bodies come apparently from the metopes of the same temple. (See also article ARGOS.)

Another work of Polyclitus was his Amazon, made it is said in competition with his great contemporaries, Pheidias, Cresilas and Phradmon, all of whose Amazons were preserved in the great temple of Artemis at Ephesus. In our museums are many statues of Amazons representing 5th century originals. These have usually been largely restored, and it is no easy matter to discover their original type. Professor Michaelis has recovered

successfully three types (fig. 40). The attribution of these is a matter of controversy. The first has been given to the chisel of Polyclitus; the second seems to represent the Wounded Amazon of Cresilas; the third has by some archaeologists been given to Pheidias. It does not represent a wounded amazon, but one alert, about to leap upon her horse with the help of a spear as a leaping pole.

We can devote little more than a passing mention to the sculpture of other temples and shrines of the later 5th century, which nevertheless deserve careful study. The frieze from the temple of Apollo at Phigalia, representing Centaur and Amazon battles, is familiar to visitors of the British Museum, where, however, its proximity to the remains of the

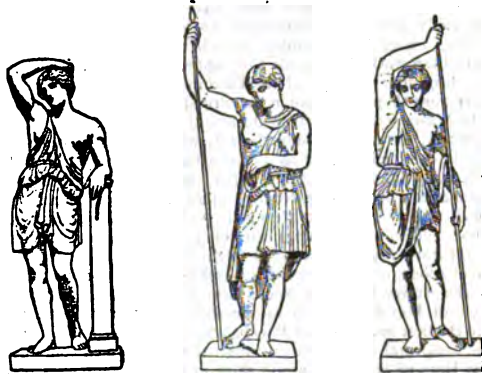

FIG. 40.—Types of Amazons (Michaelis.)

Parthenon lays stress upon the faults of grouping and execution which this frieze presents. It seems to have been executed by local Arcadian artists. More pleasing is the sculpture of the Ionic tomb called the Nereid monument, brought by Sir Charles Fellows from Lycia. Here we have not only a series of bands of relief which ran round the tomb, but also detached female figures, whence the name which it bears is derived. A recent view sees in these women with their fluttering drapery not nymphs of the sea, but personifications of sea-breezes.

The series of known Lycian tombs has been in recent years enriched through the acquisition by the museum of Vienna of the sculptured friezes which adorned a heroon near Geul Bashi. In the midst of the enclosure was a tomb, and the walls of the enclosure itself were adorned within and without with a great series of reliefs, mostly of mythologic purport. Many subjects which but rarely occur in early Greek art, the siege of Troy, the adventure of the Seven against Thebes, the carrying off of the daughters of Leucippus, Ulysses shooting down the Suitors, are here represented in detail. Professor Benndorf, who has published these sculptures in an admirable volume, is disposed to see in them the influence of the Thasian painter Polygnotus. Any one can see their kinship to painting, and their subjects recur in some of the great frescoes painted by Polygnotus, Micon and others for the Athenians. Like other Lycian sculptures, they contain non-Hellenic elements; in fact Lycia forms a link of the chain which extends from the wall-paintings of Assyria to works like the columns of Trajan and of Antoninus, but is not embodied in the more purely idealistic works of the highest Greek art. The date of the Vienna tomb is not much later than the middle of the 5th century. A small part of the frieze of this monument is shown in fig. 41. It will be seen that in this fragment there are two scenes, one directly above the other. In the upper line Ulysses, accompanied by his son Telemachus, is in the act of shooting the suitors, who are reclining at table in the midst of a feast; a cup-bearer, possibly Melanthius, is escaping by a door behind Ulysses. In the lower line is the central group of a frieze which represents the hunting of the

Calydonian boar, which is represented, as is usual in the best time of Greek art, as an ordinary animal and no monster.

Archaeologists have recently begun to pay more attention to an interesting branch of Greek art which had until recently been neglected, that of sculptured portraits. The known portraits of the 5th century now include Pericles, Herodotus, Thucydides, Anacreon, Sophocles, Euripides, Socrates and others. As might be expected in a time when style in sculpture was so strongly pronounced, these portraits, when not later unfaithful copies, are notably ideal. They represent the great men whom they portray not in the spirit of realism. Details are neglected, expression is not elaborated; the sculptor tries to represent what is permanent in his subject rather than what is temporary. Hence these portraits do not seem to belong to a particular time of life; they only represent a man in the perfection of physical force and mental energy. And the race of type is clearly shown through individual traits. In some cases it is still disputed whether statues of this age represent deities or mortals, so notable are the repose and dignity which even human figures acquire under the hands of 5th-century masters. The Pericles after Cresilas in the British Museum, and the athlete-portraits of Polyclitus, are good examples.

Period III. 400-300 B.C.—The high ideal level attained by Greek art at the end of the 5th century is maintained in the 4th. There cannot be any question of decay in it save at Athens, where undoubtedly the loss of religion and the decrease of national prosperity acted prejudicially. But in Peloponnesus the time was one of expansion; several new and important cities, such as Messene, Megalopolis and Mantinea, arose under the protection of Epaminondas. And in Asia the Greek cities were still prosperous and artistic, as were the cities of Italy and Sicily which kept their independence. On the whole we find during this age some diminution of the freshness and simplicity of art;



Heroon of Geul Bashi, Trpis, Pl. 7.

FIG. 41.—Odysseus and Suitors; Hunting of Boar.

it works less in the service of the gods and more in that of private patrons; it becomes less ethical and more sentimental and emotional. On the other hand, there can be no doubt that technique both in painting and sculpture advanced with rapid strides; artists had a greater mastery of their materials, and ventured on a wider range of subject.

In the 4th century no new temples of importance rose at Athens; the Acropolis had taken its final form; but at Messene, Tegea, Epidaurus and elsewhere, very admirable buildings arose. The remains of the temple at Tegea are of wonderful beauty and finish; as are those of the theatre and the so-called *Tholos* of Epidaurus. In Asia Minor vast temples of the Ionic order arose, especially at Miletus and Ephesus. The colossal pillars of Miletus astonish the visitors to the Louvre; while the sculptured columns of Ephesus in the British Museum (Plate II, fig. 59) show a high level of artistic skill. The Mausoleum erected about 350 B.C. at Halicarnassus in memory of Mausolus, king of Caria, and adorned with sculpture by the most noted

artists of the day, was reckoned one of the wonders of the world. It has been in part restored in the British Museum. Mr Oldfield's conjectural restoration, published in *Archæologia* for 1895, though it has many rivals, surpasses them all in the lightness of the effect, and in close correspondence to the description by Pliny. We show a small part of the sculptural decoration, representing a battle between Greeks and Amasons (Plate IV. fig. 70), wherein the energy of the action and the careful balance of figure against figure are remarkable. We possess also the fine portraits of Mausolus himself and his wife Artemisia, which stood in or on the building, as well as part of a gigantic chariot with four horses which surmounted it.

Another architectural work of the 4th century, in its way a gem, is the structure set up at Athens by Lysicrates, in memory of a choragic victory. This still survives, though the reliefs with which it is adorned have suffered severely from the weather.

The 4th century is the brilliant period of ancient painting. It opens with the painters of the Asiatic School, Zeuxis and Parrhasius and Protogenes, with their contemporaries Nicias and Apollodorus of Athens, Timanthes of Sicyon or Cythnus, and



Nat. Mus., Naples.

FIG. 42.—Greek Drawing of Women playing at Knucklebones.

Euphranor of Corinth. It witnesses the rise of a great school at Sicyon, under Eupompus and Pamphilus, which was noted for its scientific character and the fineness of its drawing, and which culminated in Apelles, the painter of Alexander the Great, and probably the greatest master of the art in antiquity. To each of these painters a separate article is given, fixing their place in the history of the art. Of their paintings unfortunately we can form but a very inadequate notion. Vase-paintings, which in the 5th century give us some notion at least of contemporary drawing, are less careful in the 4th century. Now and then we find on them figures admirably designed, or successfully foreshortened; but these are rare occurrences. The art of the vase decorator has ceased to follow the methods and improvements of contemporary fresco painters, and is pursued as a mere branch of commerce.

But very few actual paintings of the age survive, and even these fragmentary remains have with time lost the freshness of their colouring; nor are they in any case the work of a noteworthy hand. We reproduce two examples. The first is from a stone of the vault of a Crimean grave (Plate IV. fig. 67). The date of the grave is fixed to the 4th century by ornaments found in it, among which was a gold coin of Alexander the Great. The

representation is probably of Demeter or her priestess, her hair bound with poppies and other flowers. The original is of large size. The other illustration (fig. 42) represents the remains of a drawing on marble, representing a group of women playing knucklebones. It was found at Herculaneum. Though signed by one Alexander of Athens, who was probably a worker of the Roman age, Professor Robert is right in maintaining that Alexander only copied a design of the age of Zeuxis and Parrhasius. In fact the drawing and grouping is so closely like that of reliefs of about 400 B.C. that the drawing is of great historic value, though there be no colouring. Several other drawings of the same class have been found at Herculaneum, and on the walls of the Transtiberine Villa at Rome (now in the Terme Museum).

Until about the year 1880, our knowledge of the great Greek sculptors of the 4th century was derived mostly from the statements of ancient writers and from Roman copies; or what were supposed to be copies, of their works. We are now in a far more satisfactory position. We now possess an original work of Praxiteles, and sculptures executed under the immediate direction of, if not from the hand of, other great sculptors of that age—Scopas, Timotheus and others. Among all the discoveries made at Olympia, none has become so familiar to the artistic world as that of the Hermes of Praxiteles. It is the first time that we have become possessed of a first-rate Greek original by one of the greatest of sculptors. Hitherto almost all the statues in our museums have been either late copies of Greek works of art, or else the mere decorative sculpture of temples and tombs, which was by the ancients themselves but little regarded. But we can venture without misgiving to submit the new Hermes to the strictest examination, sure that in every line and touch we have the work of a great artist. This is more than we can say of any of the literary remains of antiquity—poem, play or oration. Hermes is represented by the sculptor (fig. 43 and Plate VI. fig. 82) in the act of carrying the young child Dionysus to the nymphs who were charged with his rearing. On the journey he pauses and amuses himself by holding out to the child-god a bunch of grapes, and watching his eagerness to grasp them. To the modern eye the child is not a success; only the latest art of Greece is at home in dealing with children. But the Hermes, strong without excessive muscular development, and graceful without leanness, is a model of physical formation, and his face expresses the perfection of health, natural endowment and sweet nature. The statue can scarcely be called a work of religious art in the modern or Christian sense of the word religious, but from the Greek point of view it is religious, as embodying the result of the harmonious development of all human faculties and life in accordance with nature.

The Hermes not only adds to our knowledge of Praxiteles, but also confirms the received views in regard to him. Already many works in galleries of sculpture had been identified as copies of statues of his school. Noteworthy among these are, the group at Munich representing Peace nursing the infant Wealth, from an original by Cephisodotus, father of Praxiteles; copies of the Cnidian Aphrodite of Praxiteles, especially one in the Vatican which is here illustrated (Plate V. fig. 71); copies of the Apollo slaying a lizard (Sauroctonus), of a Satyr (in the Capitol Museum), and others. These works, which are noted



Olympia, iii. 53.

FIG. 43.—Hermes of Praxiteles; restored.

for their softness and charm, make us understand the saying of the ancient critics that Praxiteles and Scopas were noted for the pathos of their works, as Pheidias and Polyclitus for the ethical quality of those they produced. But the pathos of Praxiteles is of a soft and dreamy character; there is no action, or next to none; and the emotions which he rouses are sentimental rather than passionate. Scopas, as we shall see, was of another mood. The discovery of the Hermes has naturally set archaeologists searching in the museums of Europe for other works which may from their likeness to it in various respects be set down as Praxitelean in character. In the case of many of the great sculptors of Greece—Strongylion, Silanion, Calamis and others—it is of little use to search for copies of their works, since we have little really trustworthy evidence on which to base our inquiries. But in the case of Praxiteles we really stand on a safe level. Naturally it is impossible in these pages to give any sketch of the results, some almost certain, some very doubtful, of the researches of archaeologists in quest of Praxitelean works. But we may mention a few works which have been claimed by good judges as coming from the master himself. Professor Bruhn claimed as work of Praxiteles a torso of a satyr in the Louvre, in scheme identical with the well-known satyr of the Capitol. Professor Furtwängler puts in the same category a delicately beautiful head of Aphrodite at Petworth. And his translator, Mrs Strong, regards the Aberdeen head of a young man in the British Museum as the actual work of Praxiteles. Certainly this last head does not suffer when placed beside the Olympian head of Hermes. At Mantinea has been found a basis whereon stood a group of Latona and her two children, Apollo and Artemis, made by Praxiteles. This base bears reliefs representing the musical contest of Apollo and Marsyas, with the Muses as spectators, reliefs very pleasing in style, and quite in the manner of Attic artists of the 4th century. But of course we must not ascribe them to the hand of Praxiteles himself; great sculptors did not themselves execute the reliefs which adorned temples and other monuments, but reserved them for their pupils. Yet the graceful figures of the Muses of Mantinea suggest how much was due to Praxiteles in determining the tone and character of Athenian art in relief in the 4th century. Exactly the same style which marks them belongs also to a mass of sepulchral monuments at Athens, and such works as the Sidonian sarcophagus of the Mourning Women, to be presently mentioned.

Excavation on the site of the temple of Athena Alea at Tegea has resulted in the recovery of works of the school of Scopas. Pausanias tells us that Scopas was the architect of the temple, and so important in the case of a Greek temple is the sculptural decoration, that we can scarcely doubt that the sculpture also of the temple at Tegea was under the supervision of Scopas, especially as he was more noted as a sculptor than as an architect. In the pediments of the temple were represented two scenes from mythology, the hunting of the Calydonian boar and the combat between Achilles and Telephus. To one or other of these scenes belong several heads of local marble discovered on the spot, which are very striking from their extraordinary life and animation. Unfortunately they are so much injured that they can scarcely be made intelligible except by the help of restoration; we therefore engrave one of them, the helmeted head, as restored by a German sculptor (Plate III. fig. 63). The strong bony frame of this head, and its depth from front to back, are not less noteworthy than the parted lips and deeply set and strongly shaded eye; the latter features impart to the head a vividness of expression such as we have found in no previous work of Greek art, but which sets the key to the developments of art which take place in the Hellenistic age. A draped torso of Atalanta from the same pediment has been fitted to one of these heads. Hitherto Scopas was known to us, setting aside literary records, only as one of the sculptors who had worked at the Mausoleum. Ancient critics and travellers, however, bear ample testimony to his fame, and the wide range of his activity, which extended to northern Greece, Peloponnese and Asia Minor. His Maenads

and his Tritons and other beings of the sea were much copied in antiquity. But perhaps he reached his highest level in statues such as that of Apollo as leader of the Muses, clad in long drapery.

The interesting precinct of Aesculapius at Epidaurus has furnished us with specimens of the style of an Athenian contemporary of Scopas, who worked with him on the Mausoleum. An inscription which records the sums *Timotheus, Bryaxis, Leochares*, spent on the temple of the Physician-god, informs us that the models for the sculptures of the pediments, and one set of acroteria or roof adornments, were the work of Timotheus. Of the pedimental figures and the acroteria considerable fragments have been recovered, and we may with confidence assume that at all events the models for these were by Timotheus. It is strange that the unsatisfactory arrangement whereby a noted sculptor makes models and some local workman the figures enlarged from those models, should have been tolerated by so artistic a people as the Greeks. The subjects of the pediments appear to have been the common ones of battles between Greek and Amazon and between Lapith and Centaur. We possess fragments of some of the Amazon figures, one of which, striking downwards at the enemy, is here shown (fig. 44). Their attitudes are vigorous and alert; but the work shows no delicacy of detail. Figures of Nereids riding on horses, which were found on the same site, may very probably be roof ornaments (acroteria) of the temple. We have also several figures of Victory, which probably were acroteria on some smaller temple, perhaps that of Artemis. A base found at Athens, sculptured with figures of horsemen in relief, bears the name of Bryaxis, and was probably made by a pupil of his. Probable conjecture assigns to Leochares the originals copied in the



FIG. 44.—Amazon from Epidaurus.

Ganymede of the Vatican, borne aloft by an eagle (Plate I. fig. 53) and the noble statue of Alexander the Great at Munich (see *LEOCHARES*). Thus we may fairly say that we are now acquainted with the work of all the great sculptors who worked on the Mausoleum—Scopas, Bryaxis, Leochares and Timotheus; and are in a far more advantageous position than were the archaeologists of 1880 for determining the artistic problems connected with that noblest of ancient tombs.

Contemporary with the Athenian school of Praxiteles and Scopas was the great school of Argos and Sicyon, of which Lysippus was the most distinguished member. Lysippus continued the academic traditions of Polyclitus, but he was far bolder in his choice of subjects and more innovating in style. Gods, heroes and mortals alike found in him a sculptor who knew how to combine fine ideality with a vigorous actuality. He was at the height of his fame during Alexander's life, and the grandiose ambition of the great Macedonian found him ample employment, especially in the frequent representation of himself and his marshals.

We have none of the actual works of Lysippus; but our best evidence for his style will be found in the statue of Agias an athlete (Plate V. fig. 74) found at Delphi, and shown by an inscription to be a marble copy of a bronze original by Lysippus. The Apoxyomenus of the Vatican (man scraping himself with a strigil) (Plate VI. fig. 79) has hitherto been regarded as a copy from Lysippus; but of this there is no evidence, and the style of that statue belongs rather to the 3rd century than the 4th.

The Agias, on the other hand, is in style contemporary with the works of 4th-century sculptors.

Of the elaborate groups of combatants with which Lysippus enriched such centres as Olympia and Delphi, or of the huge bronze statues which he erected in temples and shrines, we can form no adequate notion. Perhaps among the extant heads of Alexander the one which is most likely to preserve the style of Lysippus is the head from Alexandria in the British Museum (Plate II. fig. 56), though this was executed at a later time.

Many noted extant statues may be attributed with probability to the latter part of the 4th or the earlier part of the 3rd century. We will mention a few only. The celebrated group at Florence representing Niobe and her children falling before the arrows of Apollo and Artemis is certainly a work of the pathetic school, and may be by a pupil of Praxiteles. Niobe, in an agony of grief, which is in the marble tempered and idealized, tries to protect her youngest daughter from destruction (Plate VI. fig. 78). Whether the group can have originally been fitted into the gable of a temple is a matter of dispute.

Two great works preserved in the Louvre are so noted that it is but necessary to mention them, the Aphrodite of Melos (Plate VI. fig. 77), in which archaeologists are now disposed to see the influence of Scopas, and the Victory of Samothrace (Plate III. figs. 61 and 62), an original set up by Demetrius Poliorketes after a naval victory won at Salamis in Cyprus in 306 B.C. over the fleet of Ptolemy, king of Egypt.

Nor can we pass over without notice two works so celebrated as the Apollo of the Belvedere in the Vatican (Plate II. fig. 55), and the Artemis of Versailles. The Apollo is now by most archaeologists regarded as probably a copy of a work of Leochares, to whose Ganymede it bears a superficial resemblance. The Artemis is regarded as possibly due to some artist of the same age. But it is by no means clear that we have the right to remove either of these figures from among the statues of the Hellenistic age. The old theory of Preller, which saw in them copies from a trophy set up to commemorate the repulse of the Gauls at Delphi in 278 B.C., has not lost its plausibility.

This may be the most appropriate place for mentioning the remarkable find made at Sidon in 1886 of a number of sarcophagi, which once doubtless contained the remains of kings of Sidon. They are now in the museum of Constantinople, and are admirably published by Hamdy Bey and T. Reinach (*Une Necropole royale à Sidon, 1892-1896*). The sarcophagi in date cover a considerable period. The earlier are made on Egyptian models, the covers shaped roughly in the form of a human body or mummy. The later, however, are Greek in form, and are clearly the work of skilled

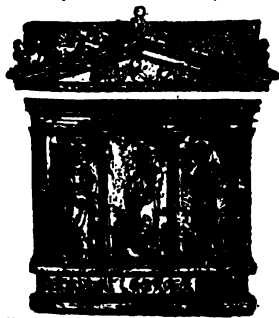

Hamdy et Reinach, *Necropole à Sidon*, Pl. 7.
FIG. 45.—Tomb of Mourning Women: Sidon.

Greek sculptors, who seem to have been employed by the grandees of Phoenicia in the adornment of their last resting-places. Four of these sarcophagi in particular claim attention, and in fact present us with examples of Greek art of the 5th and 4th centuries in several of its aspects. To the 5th century belong the tomb of the Satrap, the reliefs of which bring before us the activities and glories of some unknown king, and the Lycian sarcophagus, so called from its form, which resembles that of

tombs found in Lycia, and which is also adorned with reliefs which have reference to the past deeds of the hero buried in the tomb, though these deeds are represented, not in the Oriental manner directly, but in the Greek manner, clad in mythological forms. To the 4th century belong two other sarcophagi. One of these is called the Tomb of Mourning Women. On all sides of it alike are ranged a series of beautiful female figures, separated by Ionic pillars, each in a somewhat different attitude, though all attitudes denoting grief (fig. 45). The pediments at the ends of the cover are also closely connected with the mourning for the loss of a friend and protector, which is the theme of the whole decoration of the sarcophagus. We see depicted in them the telling of the news of the death, with the results in the mournful attitude of the two seated figures. The mourning women must be taken, not as the representation of any persons in particular, but generally as the expression of the feeling of a city. Such figures are familiar to us in the art of the second Attic school; we could easily find parallels to the sarcophagus among the 4th-century sepulchral reliefs of Athens. We can scarcely be mistaken in attributing the workmanship of this beautiful sarcophagus to some sculptor trained in the school of Praxiteles. And it is a conjecture full of probability that it once contained the body of Strato, king of Sidon, who ruled about 380 B.C., and who was *proxenos* or public friend of the Athenians.

More celebrated is the astonishing tomb called that of Alexander, though there can be no doubt that, although it commemorates the victories and exploits of Alexander, it was made not to hold his remains, but those of some ruler of Sidon who was high in his favour. Among all the monuments of antiquity which have come down to us, none is more admirable than this, and none more characteristic of the Greek genius. We give, in two lines, the composition which adorned one of the sides of this sarcophagus. It represents a victory of Alexander, probably that of the Granicus (fig. 46). On the left we see the Macedonian king charging the Persian horse, on the right his general Parmenio, and in the midst a younger officer, perhaps Cleitus. Mingled with the chiefs are foot-soldiers, Greek and Macedonian, with whom the Persians are mingled in unequal fray. What most strikes the modern eye is the remarkable freshness and force of the action and the attitudes. Those, however, who have seen the originals have been specially impressed with the colouring, whereof, of course, our engraving gives no hint, but which is applied to the whole surface of the relief with equal skill and delicacy. There are other features in the relief on which a Greek eye would have dwelt with special pleasure—the exceedingly careful symmetry of the whole, the balancing of figure against figure, the skill with which the result of the battle is hinted rather than depicted. The composition is one in which the most careful planning and the most precise calculation are mingled with freedom of hand and expressiveness in detail. The faces in particular show more expression than would be tolerated in art of the previous century. We are unable as yet to assign an author or even a school to the sculptor of this sarcophagus; he comes to us as a new and striking phenomenon in the history of ancient art. The reliefs which adorn the other sides of the sarcophagus are almost equally interesting. On one side we see Alexander again, in the company of a Persian noble, hunting a lion. The short sides also show us scenes of fighting and hunting. In fact it can scarcely be doubted that if we had but a clue to the interpretation of the reliefs, they would be found to embody historic events of the end of the 4th century. There are but a few other works of art, such as the Bayeux tapestry and the Column of Trajan, which bring contemporary history so vividly before our eyes. The battles with the Persians represented in some of the sculpture of the Parthenon and the temple of Nike at Athens are treated conventionally and with no attempt at realism; but here the ideal and the actual are blended into a work of consummate art, which is at the same time, to those who can read the language of Greek art, a historic record. The portraits of Alexander the Great which appear on this sarcophagus are almost contemporary, and the most authentic likenesses of him which we possess. The great Macedonian exercised so strong an influence on contemporary art that a multitude of heads of the age, both of gods and men, and even the portraits of his successors, show traces of his type.

We have yet to mention what are among the most charming and the most characteristic products of the Greek chisel, the

beautiful tombs, adorned with seated or standing portraits or with reliefs, which were erected in great numbers on all the main roads of Greece. A great number of these from the Dipylon cemetery are preserved in the Central Museum at Athens, and

ful Pompeian mosaic (fig. 47), which represents the victory of Alexander at Issus. This work being in stone has preserved its colouring; and it stands at a far higher level of art than ordinary Pompeian paintings, which are the work of mere house-decorators.



Hamdy et Reinsch. *Nicropolis à Sidon*, Pl. 30.

FIG. 46.—Battle of The Granicus: Sarcophagus from Sidon.

impress all visitors by the gentle sentiment and the charm of grouping which they display (Gardner, *Sculptured Tombs of Hellas*).

Period IV. 300-50 B.C.—There can be no question but that the period which followed the death of Alexander, commonly called the age of Hellenism, was one of great activity and expansion in architecture. The number of cities founded by himself and his immediate successors in Asia and Egypt was enormous. The remains of these cities have in a few cases (Ephesus, Pergamum, Assus, Priene, Alexandria) been partially excavated. But the adaptation of Greek architecture to the needs of the semi-Greek peoples included in the dominions of the kings of Egypt, Syria and Pergamum is too vast a subject for us to enter upon here (see ARCHITECTURE).

Painting during this age ceased to be religious. It was no longer for temples and public stoae that artists worked, but for private persons; especially they made frescoes for the decoration of the walls of houses, and panel pictures for galleries set up by rich patrons. The names of very few painters of the Hellenistic age have come down to us. There can be no doubt that the character of the art declined, and there were no longer produced great works to be the pride of cities, or to form an embodiment for all future time of the qualities of a deity or the circumstances of scenes mythical or historic. But at the same time the mural paintings of Pompeii and other works of the Roman age, which are usually more or less nearly derived from Hellenistic models, prove that in technical matters painting continued to progress. Colouring became more varied, groups more elaborate, perspective was worked out with greater accuracy, and imagination shook itself free from many of the conventions of early art. Pompeian painting, however, must be treated of under Roman, not under Greek art. We figure a single example, to show the elaboration of painting at Alexandria and elsewhere, the wonder-

This on the contrary is certainly copied from the work of a great master. It is instructive to compare it with the sarcophagus illustrated in Fig. 46, which it excels in perspective and in the freedom of individual figures, though the composition is much less careful and precise. Alexander charges from the left (his portrait being the least successful part of the picture), and bears down a young Persian; Darius in his chariot flies towards the right; in the foreground a young knight is trying to manage a restive horse. It will be observed how very simple is the indication of locality: a few stones and a broken tree stand for rocks and woods.

Among the original sculptural creations of the early Hellenistic age, a prominent place is claimed by the statue of Fortune, typifying the city of Antioch

(Plate VI. fig. 81), a work of Eutychides, a pupil of Lysippus. Of this we possess a small copy, which is sufficient to show how worthy of admiration was the original. We have a beautiful embodiment of the personality of the city, seated on a rock, holding ears of corn, while the river Orontes, embodied in a young male figure, springs forth at her feet.

This is, so far as we know, almost the only work of the early part of the 3rd century which shows imagination. Sculptors often worked on a colossal scale, producing such monsters as the colossal Apollo at Rhodes, the work of Chares of Lindus, which was more than 100 ft. in height. But they did not show freshness or invention; and for the most part content themselves



From a photograph by O. Brogi.

FIG. 47.—Mosaic of the Battle of Issus (Naples).

with varying the types produced in the great schools of the 4th century. The wealthy kings of Syria, Egypt and Asia Minor formed art galleries, and were lavish in their payments; but it has often been proved in the history of art that originality cannot be produced by mere expenditure.

A great artist, whose date has been disputed, but who is now assigned to the Hellenistic age, Damophon of Messene, is known to us from his actual works. He set up in the shrine of the *Mistress* (Despoena) at Lycosura in Arcadia a great group of figures consisting of Despoena, Demeter, Artemis and the Titan Anytus. Three colossal heads found on the spot probably belong to the three last-mentioned deities. We illustrate the head of Anytus, with wild disordered hair and turbulent expression (fig. 48). Dr Dörpfeld has argued, on



FIG. 48.—Head of Anytus: Lycosura.

architectural grounds, that shrine and images alike must be given to a later time than the 4th century; and this judgment is now confirmed by inscriptional and other evidence. In one important direction sculpture certainly made progress. Hitherto Greek sculptors had contented themselves with studying the human body whether in rest or motion, from outside. The dissection of the human body, with a consequent increase in knowledge of anatomy, became usual at Alexandria in the medical school which flourished under the Ptolemies. This improved anatomical knowledge soon reacted upon the art of sculpture. Works such as

the *Fighter of Agasias* in the Louvre (Plate IV. fig. 69), and in a less degree the *Apoxyomenus* (Plate VI. fig. 79), display a remarkable internal knowledge of the human frame, such as could only come from the habit of dissection. Whether this was really productive of improvement in sculpture may be doubted. But it is impossible to withhold one's admiration from works which show an astonishing knowledge of the body of man down to its bony framework, and a power and mastery of execution which have never since been surpassed. With accuracy in the portrayal of men's bodies goes of necessity a more naturalistic tendency in portraiture. As we have seen, the art of portraiture was at a high ideal level in the Pheidias age; and even in the age of Alexander the Great, notable men were rendered rather according to the idea than the fact. To a base and mechanical naturalism Greek art never at any time descended. But from 300 B.C. onwards we have a marvellous series of portraits which may be termed rather characteristic than ideal, which are very minute in their execution, and delight in laying emphasis on the havoc wrought by time and life on the faces of noteworthy men. Such are the portraits of Demosthenes, of Antisthenes, of Zeno and others, which exist in our galleries. And it was no long step from these actual portraits to the invention of characteristic types to represent the great men of a past generation, such as Homer and Lycurgus, or to form generic images to represent weatherbeaten fishermen or toothless old women.

Our knowledge of the art of the later Hellenistic age has received a great accession since 1875 through the systematic labours directed by the German Archaeological Institute, which have resulted in recovering the remains of Pergamum, the fortress-city which was the capital of the dynasty of the Philetaeri. Among the ancient buildings of Pergamum none was more ambitious in scale and striking in execution than the great altar used for sacrifices to Zeus, a monument supposed to be referred to in the phrase of the *Apocalypse* "where Satan's throne is." This altar, like many great sacrificial altars of later Greece, was a vast erection to which one mounted by many steps, and its outside was adorned

with a frieze which represented on a gigantic scale, in the style of the 2nd century B.C., the battle between the gods and the giants. This enormous frieze (see PERGAMUM) is now one of the treasures of the Royal Museums of Berlin, and it cannot fail to impress visitors by the size of the figures, the energy of the action, and the strong vein of sentiment which pervades the whole, giving it a certain air of modernity, though the subject is strange to the Christian world. In early Greek art the giants were they oppose the gods are represented as men armed in full panoply, "in shining armour, holding long spears in their hands," to use the phrase in which Hesiod describes them. But in the Pergamene frieze the giants are strange compounds, having the heads and bodies of wild and fierce barbarians, sometimes also human legs, but sometimes in the place of legs two long serpents, the heads of which take with the giants themselves a share in the battle. Sometimes also they are winged. The gods appear in the forms which had been gradually made for them in the course of Greek history, but they are usually accompanied by the animals sacred to them in cultus, between which and the serpent-feet of the giants a weird combat goes on. We can conjecture the source whence the Pergamene artist derived the shaggy hair, the fierce expression, the huge muscles of his giants (fig. 49); probably these features came originally from the Galatians, who at the time had settled in Asia Minor, and were spreading the terror of their name and the report of their savage devastations through all Asia Minor. The victory over the giants clearly stands for the victory of Greek civilization over Gallic barbarism; and this meaning is made more emphatic because the gods are obviously inferior in physical force to their opponents, indeed, a large proportion of the divine combatants are goddesses. Yet everywhere the giants are overthrown, writhing in pain on the ground, or transfixed by the weapons of their opponents; everywhere the gods are victorious, yet in the victory retain much of their divine calm. The piecing together of the frieze at Berlin has been a labour of many years; it is

now complete, and there is a special museum devoted to it. Some of the groups have become familiar to students from photographs, especially the group which represents Zeus slaying his enemies with thunderbolts, and the group wherein Athena seizes by the hair an overthrown opponent, who is winged, while Victory runs to crown her, and beneath is seen Gaia, the earth-goddess who is the mother of the giants, rising out of the ground, and mourning over her vanquished and tortured children. Another and smaller frieze which also decorated the altar-place gives us scenes from the history of Telephus, who opposed the landing of the army of Agamemnon in Asia Minor and was overthrown by Achilles. This

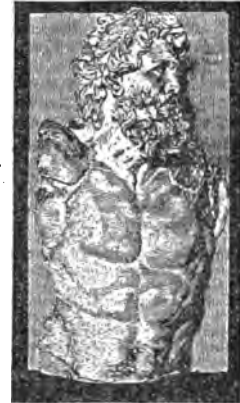

FIG. 49.—Giant from Great Altar: Pergamum.

frieze, which is quite fragmentary, is put together by Dr Schneider in the *Jahrbuch* of the German Archaeological Institute for 1900.

Since the Renaissance Rome has continually produced a crop of works of Greek art of all periods, partly originals brought from Greece by conquering generals, partly copies, such as the group at Rome formerly known as *Paetus and Arria*, and the overthrown giants and barbarians which came from the elaborate trophy set up by Aitalus at Athens, of which copies exist in many museums. A noted work of kindred school is the group of *Laocoon and his sons* (Plate I. fig. 52), signed by Rhodian sculptors of the 1st century B.C., which has been perhaps more discussed than any work of the Greek chisel, and served as a peg

for the aesthetic theories of Lessing and Goethe. In our days the histrionic and strained character of the group is regarded as greatly diminishing its interest, in spite of the astounding skill and knowledge of the human body shown by the artists. To the same school belong the late representations of Marsyas being flayed by the victorious Apollo (Plate II. fig. 54), a somewhat repulsive subject, chosen by the artists of this age as a means for displaying their accurate knowledge of anatomy.

On what a scale some of the artists of Asia Minor would work is shown us by the enormous group, by Apollonius and Tauriscus of Tralles, which is called the Farnese Bull (Plate I. fig. 51), and which represents how Dirce was tied to a wild bull by her stepsons Zethus and Amphion.

The extensive excavations and alterations which have taken place at Rome in recent years have been very fruitful; the results may be found partly in the palace of the Conservatori on the Capitol, partly in the new museum of the Terme. Among recently found statues none excel in interest some bronzes of large size dating from the Hellenistic age.

In the figure of a seated boxer (Plate V. fig. 72), in scale somewhat exceeding life, attitude and gesture are expressive. Evidently the boxer has fought already, and is awaiting a further conflict. His face is cut and swollen; on his hands are the terrible caestus, here made of leather, and not loaded with iron, like the caestus described by Virgil. The figure is of astounding force; but though the face is brutal and the expression savage, in the sweep of the limbs there is nobility, even ideal beauty. To the last the Greek artist could not set aside his admiration for physical perfection. Another bronze figure of more than life-size is that of a king of the Hellenistic age standing leaning on a spear. He is absolutely nude, like the athletes of Polyclitus. Another large bronze presents us with a Hellenistic type of Dionysus.

Besides the bronzes found in Rome we may set those recently found in the sea on the coast of Cythera, the contents of a ship sailing from Greece to Rome, and lost on the way. The date of these bronze statues has been disputed. In any case, even if executed in the Roman age, they go back to originals of the 5th and 4th centuries. The most noteworthy among them is a beautiful athlete (Plate V. fig. 73) standing with hand upraised, which reflects the style of the Attic school of the 4th century.

After 146 B.C. when Corinth was destroyed and Greece became a Roman province, Greek art, though by no means extinct, worked mainly in the employ of the Roman conquerors (see ROMAN ART).

IV. SELECT BIBLIOGRAPHY.—I. General works on Greek Art.—The only recent general histories of Greek art are: H. Brunn, *Griechische Kunstgeschichte*, bks. i. and ii., dealing with archaic art; W. Klein, *Geschichte der griechischen Kunst*, no illustrations; Perrot et Chipiez, *Histoire de l'art dans l'antiquité*, vols. vii. and viii. (archaic art only).

Introductory are: P. Gardner, *Grammar of Greek Art*; J. E. Harrison, *Introductory Studies in Greek Art*; H. B. Walters, *Art of the Greeks*.

Useful are also: H. Brunn, *Geschichte der griechischen Künstler*, (new edition, 1889); J. Overbeck, *Die antiken Schriftquellen zur Geschichte der bildenden Künste bei den Griechen*; untranslated passages in Latin and Greek; the Elder Pliny's *Chapters on the History of Art*, edited by K. Jex-Blake and E. Sellers; H. S. Jones, *Ancient Writers on Greek Sculpture*.

II. Periodicals dealing with Greek Archaeology.—England: *Journal of Hellenic Studies*; *Annual of the British School at Athens*; *Classical Review*. France: *Revue archéologique*; *Gazette archéologique*; *Bulletin de correspondance hellénique*. Germany: *Jahrbuch des K. deutschen arch. Instituts*; *Mitteilungen des arch. Inst.*, Athenische Abteilung, Römische Abteilung; *Antike Denkmäler*. Austria: *Jahreshefte des K. Österreich. arch. Instituts*. Italy: Publications of the *Accademia dei Lincei*; *Monumenti antichi*; *Not. dei scavi*; *Bullettino comunale di Roma*. Greece: *Ephemeros archaiologikos*; *Delion archaiologikon*; *Praktika* of the Athenian Archaeological Society.

III. Greek Architecture.—General: Perrot et Chipiez, *Histoire de l'art dans l'antiquité*, vol. vii.; A. Choisy, *Histoire de l'architecture*, vol. i.; Anderson and Spiers, *Architecture of Greece and Rome*; E. Boutmy, *Philosophie de l'architecture en Grèce*; R. Sturgis, *History of Architecture*, vol. i.; A. Marquand, *Greek Architecture*.

IV. Greek Sculpture.—General: M. Collignon, *Histoire de la sculpture grecque* (2 vols.); E. A. Gardner, *Handbook of Greek Sculpture*.

The date is given when the work cannot be considered new.

ture; A. Furtwängler, *Masterpieces of Greek Sculpture*, translated and edited by E. Sellers; Friederichs and Wolters, *Baukunst zur Geschichte der griechisch-römischen Plastik* (1887); von Mach, *Handbook of Greek and Roman Sculpture*, 500 plates; H. Bulle, *Der schöne Mensch in der Kunst: Altertum*, 216 plates; S. Reinach, *Répertoire de la statuaire grecque et romaine*, 3 vols.

V. Greek Painting and Vases.—Woltmann and Woermann, *History of Painting*, vol. i., translated and edited by S. Colvin (1880); H. B. Walters, *History of Ancient Pottery* (2 vols.); Harrison and MacColl, *Greek Vase-paintings* (1894); O. Rayet et M. Collignon, *Histoire de la céramique grecque* (1888); P. Girard, *La Peinture antique* (1892); S. Reinach, *Répertoire des vases peints grecs et étrusques* (2 vols.); Furtwängler und Reichhold, "Griechische Vasenmalerei," *Wiener Vorlesblätter für archäologische Übungen* (1887-1890).

VI. Special Schools and Sites.—A. Joubin, *La Sculpture grecque entre les guerres médiques et l'époque de Périclès*; C. Waldstein, *Essays on the Art of Pheidias* (1885); W. Klein, *Praxiteles*; G. Perrot, *Praxitèle*; A. S. Murray, *Sculptures of the Parthenon*; W. Klein, *Euphronios*; E. Pottier, *Douris*; P. Gardner, *Sculptured Tombs of Hellas*; E. A. Gardner, *Ancient Athens*; A. Bötticher, *Olympia*; Bernoulli, *Griechische Ikonographie*; P. Gardner, *The Types of Greek Coins* (1883); E. A. Gardner, *Six Greek Sculptors*.

VII. Books related to the subject.—J. G. Frazer, *Pausanias's Description of Greece* (6 vols.); J. Lange, *Darstellung des Menschen in der älteren griechischen Kunst*; E. Brücke, *The Human Figure; its Beauties and Defects*; A. Michaelis, *Ancient Marbles in Great Britain* (1882); *Catalogue of Greek Sculpture in the British Museum* (3 vols.); *Catalogue of Greek Vases in the British Museum* (4 vols.); J. B. Bury, *History of Greece* (illustrated edition); Baumeister, *Denkmäler des klassischen Altertums* (3 vols.). (P. G.)

GREEK FIRE, the name applied to inflammable and destructive compositions used in warfare during the middle ages and particularly by the Byzantine Greeks at the sieges of Constantinople. The employment of liquid fire is represented on Assyrian bas-reliefs. At the siege of Plataea (429 B.C.) the Spartans attempted to burn the town by piling up against the walls wood saturated with pitch and sulphur and setting it on fire (Thuc. ii. 77), and at the siege of Delium (424 B.C.) a cauldron containing pitch, sulphur and burning charcoal, was placed against the walls and urged into flame by the aid of a bellows, the blast from which was conveyed through a hollow tree-trunk (Thuc. iv. 100). Aeneas Tacticus in the following century mentions a mixture of sulphur, pitch, charcoal, incense and tow, which was packed in wooden vessels and thrown lighted upon the decks of the enemy's ships. Later, as in receipts given by Vegetius (c. A.D. 350), naphtha or petroleum is added, and some nine centuries afterwards the same substances are found forming part of mixtures described in the later receipts (which probably date from the beginning of the 13th century) of the collection known as the *Liber ignium* of Marcus Graecus. In subsequent receipts saltpetre and turpentine make their appearance, and the modern "carcass composition," containing sulphur, tallow, rosin, turpentine, saltpetre and crude antimony, is a representative of the same class of mixtures, which became known to the Crusaders as Greek fire but were more usually called wildfire. Greek fire, properly so-called, was, however, of a somewhat different character. It is said that in the reign of Constantine Pogonatus (648-685) an architect named Callinicus, who had fled from Heliopolis in Syria to Constantinople, prepared a wet fire which was thrown out from siphons (τὸ διὰ τῶν σιφῶνων ἐκφερόμενον πῦρ ὕγρῶν), and that by its aid the ships of the Saracens were set on fire at Cyzicus and their defeat assured. The art of compounding this mixture, which is also referred to as πῦρ θαλάσσιον, or sea fire, was jealously guarded at Constantinople, and the possession of the secret on several occasions proved of great advantage to the city. The nature of the compound is somewhat obscure. It has been supposed that the novelty introduced by Callinicus was saltpetre, but this view involves the difficulty that that substance was apparently not known till the 13th century, even if it were capable of accounting for the properties attributed to the wet fire. Lieut.-Colonel H. W. L. Hime, after a close examination of the available evidence, concludes that what distinguished Greek fire from the other incendiaries of the period was the presence of quicklime, which was well known to give rise to a large development of heat when brought into contact with water. The mixture, then, was composed of such materials as sulphur and naphtha with

quicklime, and took fire spontaneously when wetted—whence the name of wet fire or sea-fire; and portions of it were "projected and at the same time ignited by applying the hose of a water engine to the breach" of the siphon, which was a wooden tube, cased with bronze.

See Lieut.-Col. H. W. L. Hime, *Gunpowder and Ammunition, their Origin and Progress* (London, 1904).

GREEK INDEPENDENCE, WAR OF, the name given to the great rising of the Greek subjects of the sultan against the Ottoman domination, which began in 1821 and ended in 1833 with the establishment of the independent kingdom of Greece. The circumstances that led to the insurrection and the general diplomatic situation by which its fortunes were from time to time affected are described elsewhere (see **GREECE: History**; **TURKEY: History**). The present article is confined to a description of the general character and main events of the war itself. If we exclude the abortive invasion of the Danubian principalities by Prince Alexander Ypsilanti (March 1821), which collapsed ignominiously as soon as it was disavowed by the tsar, the theatre of the war was confined to continental Greece, the Morea, and the adjacent narrow seas. Its history may, broadly speaking, be divided into three periods: the first (1821-1824), during which the Greeks, aided by numerous volunteers from Europe, were successfully pitted against the sultan's forces alone; the second, from 1824, when the disciplined troops of Mehemet Ali, pasha of Egypt, turned the tide against the insurgents; the third, from the intervention of the European powers in the autumn of 1827 to the end.

When, on the 2nd of April 1821, Archbishop Germanos, head of the *Hetaeria* in the Morea, raised the standard of the cross at Kalavryta as the signal for a general rising of the Christian population, the circumstances were highly favourable. In the Morea itself, in spite of plentiful warning, the Turks were wholly unprepared; while the bulk of the Ottoman army, under the *scakier* Khurshid Pasha, was engaged in the long task of reducing the intrepid Ali, pasha of Iannina (see **ALI**, pasha of Iannina).

Another factor, and that the determining one, soon came to the aid of the Greeks. In warfare carried on in such a country as Greece, sea-girt and with a coast deeply indented, inland without roads and intersected with rugged mountains, victory—as Wellington was quick to observe—must rest with the side that has command of the sea. This was assured to the insurgents at the outset by the revolt of the maritime communities of the Greek archipelago. The Greeks of the islands had been accustomed from time immemorial to seafaring; their ships—some as large as frigates—were well armed, to guard against the Barbary pirates and rovers of their own kin; lastly, they had furnished the bulk of the sailors to the Ottoman navy which, now that this recruiting ground was closed, had to be manned hastily with impressed crews of dock-labourers and peasants, many of whom had never seen the sea. The Turkish fleet, "adrift in the Archipelago"—as the British seamen put it—though greatly superior in tonnage and weight of metal, could never be a match for the Greek brig, manned as these were by trained, if not disciplined, crews.

The war was begun by the Greeks without definite plan and without any generally recognized leadership. The force with which Germanos marched from Kalavryta against Patras was composed of peasants armed with scythes, clubs and slings, among whom the "primates" exercised a somewhat honorary authority. The town itself was destroyed and those of its Mussulman inhabitants who could not escape into the citadel were massacred; but the citadel remained in the hands of the Turks till 1828. Meanwhile, in the south, leaders of another stamp had appeared: Petros, bey of the Maina (*q.v.*) chief of the Mavromichales, who at the head of his clan attacked Kalamata and put the Mussulman inhabitants to the sword; and Kolokotrones, a notable brigand once in the service of the Ionian government, who—fortified by a vision of the Virgin—captured Karytaena and slaughtered its infidel population. Encouraged by these

successes the revolt spread rapidly; within three weeks there was not a Mussulman left in the open country, and the remnants of the once dominant class were closely besieged in the fortified towns by hosts of wild peasants and brigands. The flames of revolt now spread across the Isthmus of Corinth: early in April the Christians of Dervenokhoris rose, and the whole of Boeotia and Attica quickly followed suit; at the beginning of May the Mussulman inhabitants of Athens were blockaded in the Acropolis. In the Morea, meanwhile, a few Mussulman fortresses still held out: Coron, Modon, Navarino, Patras, Nauplia, Monemvasia, Tripolitsa. One by one they fell, and everywhere were repeated the same scenes of butchery. The horrors culminated in the capture of Tripolitsa, the capital of the vilayet. In September this was taken by storm; Kolokotrones rode in triumph to the citadel over streets carpeted with the dead; and the crowning triumph of the Cross was celebrated by a cold-blooded massacre of 2000 prisoners of all ages and both sexes. This completed the success of the insurrection in the Morea, where only Patras, Nauplia, and one or two lesser fortresses remained to the Turks.

Meanwhile, north of the Isthmus, the fortunes of war had been less one-sided. In the west Khurshid's lieutenant, Omar Vrioni (a Mussulman Greek of the race of the Palaeologi), had inflicted a series of defeats on the insurgents, recaptured Levadia, and on the 30th of June relieved the Acropolis; but the rout of the troops which Mahommed Pasha was bringing to his aid by the Greeks in the defile of Mount Oeta, and the news of the fall of Tripolitsa, forced him to retreat, and the campaign of 1821 ended with the retirement of the Turks into Thessaly.

The month of April had witnessed the revolt of the principal Greek islands, Spetsae on the 7th, Psara on the 23rd, Hydra on the 28th and Samos on the 30th. Their fleets were divided into squadrons, of which one, under Tombazes, was deputed to watch for the entrance of the Ottomans into the archipelago, while the other under Andreas Miaoulis (*q.v.*) sailed to blockade Patras and watch the coasts of Epirus. At sea, as on land, the Greeks opened the campaign with hideous atrocities, almost their first exploit being the capture of a vessel carrying to Mecca the sheik-ul-Islam and his family, whom they murdered with every aggravation of outrage.

These inauspicious beginnings, indeed, set the whole tone of the war, which was frankly one of mutual extermination. On both sides the combatants were barbarians, without discipline or competent organization. At sea the Greeks rapidly developed into mere pirates, and even of the *General character* *Miaoulis*, for all his high character and courage, was often unable to prevent his captains from sailing home at critical moments, when pay or booty failed. On land the presence of a few educated Phanariots, such as Demetrios Ypsilanti or Alexander Mavrocordato, was powerless to inspire the rude hordes with any sense of order or of humanity in warfare; while every lull in the fighting, due to a temporary check to the Turks, was the signal for internecine conflicts due to the rivalry of leaders who, with rare exceptions, thought more of their personal power and profit than of the cause of Greece.

This cause, indeed, was helped more by the impolitic reprisals of the Turks than by the heroism of the insurgents. All Europe stood aghast at the news of the execution of the Patriarch Gregorios of Constantinople (April 22, 1821), *Turkish reprisals.* and the wholesale massacres that followed, culminating as these did in the extermination of the prosperous community of Scio (Chios) in March 1822. The cause of Greece was now that of Christendom, of the Catholic and Protestant West, as of the Orthodox East. European Liberalism, too, gagged and fettered under Metternich's "system," recognized in the Greeks the champions of its own cause; while even conservative statesmen, schooled in the memories of ancient Hellas, saw in the struggle a fight of civilization against barbarism. This latter belief, which was, moreover, flattering to their vanity, the Greek leaders were astute enough to foster; the propaganda of Adamantios Corais (*q.v.*) had done its

Outbreak of the insurrection.

Turkish reprisals.

Europe and the rising Philhellenism.

work; and wily brigands, like Odysseus of Ithaka, assuming the style and trappings of antiquity, posed as the champions of classic culture against the barbarian. All Europe, then, hailed with joy the exploit of Constantine Kanaris, who on the night of June 18-19 succeeded in steering a fire-ship among the Turkish squadron off Scio, and burned the flag-ship of the capudan-pasha with 3000 souls on board.

Meanwhile Sultan Mahmud, now wide awake to the danger, had been preparing for a systematic effort to suppress the rising. The threatened breach with Russia had been avoided by Metternich's influence on the tsar Alexander; the death of Ali of Iannina had set free the army of Khurshid Pasha, who now, as *seraskier* of Rumelia, was charged with the task of reducing the Morea. In the spring of 1822 two Turkish armies advanced southwards: one, under Omar Vrioni, along the coast of Western Hellas, the other, under Ali, pasha of Drama (Dramali), through Bœotia and Attica. Omar was held in check by the mud rampsarts of Missolonghi; but Dramali, after exacting fearful vengeance for the massacre of the Turkish garrison of the Acropolis at Athens, crossed the Isthmus and with the over-confidence of a conquering barbarian advanced to the relief of the hard-pressed garrison of Nauplia. He crossed the perilous defile of Dervenaki unopposed; and at the news of his approach most of the members of the Greek government assembled at Argos fled in panic terror. Demetrios Ypsilanti, however, with a few hundred men joined the Mainote Karayanni in the castle of Larissa, which crowns the acropolis of ancient Argos. This held Dramali in check, and gave Kolokotrones time to collect an army. The Turks, in the absence of the fleet which was to have brought them supplies, were forced to retreat (August 6); the Greeks, inspired with new courage, awaited them in the pass of Dervenaki, where the undisciplined Ottoman host, thrown into confusion by an avalanche of boulders hurled upon them, was annihilated. In Western Greece the campaign had an outcome scarcely less disastrous for the Turks. The death of Ali of Iannina had been followed by the suppression of the insurgent Suliotes and the advance of Omar Vrioni southwards to Missolonghi; but the town held out gallantly, a Turkish surprise attack, on the 6th of January 1823, was beaten off, and Omar Vrioni had to abandon the siege and retire northwards over the pass of Makrynoros.

The victorious outcome of the year's fighting had a disastrous effect upon the Greeks. Their victories had been due mainly to the guerrilla tactics of the leaders of the type of Kolokotrones; Mavrocordato, whose character and antecedents had marked him out as the natural head of the new Greek state, in spite of his successful defence of Missolonghi, had been discredited by failures elsewhere; and the Greeks thus learned to despise their civilized advisers and to underrate the importance of discipline. The temporary removal of the common peril, moreover, let loose all the sectional and personal jealousies, which even in face of the enemy had been with difficulty restrained, and the year 1823 witnessed the first civil war between the Greek parties. These internecine feuds might easily have proved fatal to the cause of Greece. In the Archipelago Hydriotes and Spetsiotes were at daggers drawn; the men of Psara were at open war with those of Samos; all semblance of discipline and cohesion had vanished from the Greek fleet. Had Khosrev, the new Ottoman admiral, been a man of enterprise, he might have regained the command of the sea and, with it, that of the whole situation. But the fate of his predecessor had filled him with a lively terror of Kanaris and his fire-ships; he contented himself with a cruise round the coasts of Greece, and was happy to return to safety under the guns of the Dardanelles without having accomplished anything beyond throwing supplies and troops into Coron, Modon and Patras. On land, meanwhile, the events of the year before practically repeated themselves. In the west an army of Mussulman and Catholic Albanians, under Mustai Pasha, advanced southwards. On the night of the 21st of August occurred the celebrated exploit of Marko Botzaris and his Suliotes: a successful surprise

Expedition of Dramali, 1822.

Civil war among the Greeks.

Campaign of 1823.

attack on the camp of the Ottoman vanguard, in which the Suliote leader fell. The jealousy of the Aetolian militia for the Suliotes, however, prevented the victory being decisive; and Mustai advanced to the siege of Anatoliko, a little town in the lagoons near Missolonghi. Here he was detained until, on the 11th of December, he was forced to raise the siege and retire northwards. His colleague, Yussuf Pasha, in East Hellas fared no better; here, too, the Turks gained some initial successes, but in the end the harassing tactics of Kolokotrones and his guerilla bands forced them back into the plain of the Kephissos. At the end of the year the Greeks were once more free to renew their internecine feuds.

Just when these feuds were at their height, in the autumn of 1823, the most famous of the Philhellenes who sacrificed themselves for the cause of Greece, Lord Byron, arrived in Greece.

The year 1824 was destined to be a fateful one for the Greek cause. The large loans raised in Europe, the first instalment of which Byron had himself brought over, while providing the Greeks with the sinews of war, provided them also with fresh material for strife. To the struggle for power was added a struggle for a share of this booty, and a second civil war broke out, Kolokotrones leading the attack on the forces of the government. Early in 1825 the government was victorious; Kolokotrones was in prison; and Odysseus, the hero of so many exploits and so many crimes, who had ended by turning traitor and selling his services to the Turks, had been captured, imprisoned in the Acropolis, and finally assassinated by his former lieutenant Gouras (July 16, 1824). But a new and more terrible danger now threatened Greece. Sultan Mahmud, despairing of suppressing the insurrection by his own power, had reluctantly summoned to his aid Mehemet Ali, pasha of Egypt, whose well-equipped fleet and disciplined army were now thrown into the scale against the Greeks. Already, in June 1823, the pasha's son-in-law Hussein Bey had landed in Crete, and by April of the following year had reduced the insurgent islanders to submission. Crete now became the base of operations against the Greeks. On the 19th of June Hussein appeared before Kasos, a nest of pirates of evil reputation, which he captured and destroyed. The same day the Egyptian fleet, under Ibrahim Pasha, sailed from Alexandria. Khosrev, too, emboldened by this new sense of support, ventured to sea, surprised and destroyed Psara (July 2), and planned an attack on Samos, which was defeated by Miaoulis and his fire-ships (August 16, 17). On the 1st of September, however, Khosrev succeeded in effecting a junction with Ibrahim off Budrun, and two indecisive engagements followed with the united Greek fleet on the 9th and 10th. The object of Ibrahim was to reach Suda Bay with his transports, which the Greeks should at all costs have prevented. A first attempt was defeated by Miaoulis on the 16th of November, and Ibrahim was compelled to retire and anchor off Rhodes; but the Greek admiral was unable to keep his fleet together, the season was far advanced, his captains were clamouring for arrears of pay, and the Greek fleet sailed for Nauplia, leaving the sea unguarded. On the 5th of December Ibrahim again set sail, and reached Suda without striking a blow. Here he completed his preparations, and, on the 24th of February 1825, landed at Modon in the Morea with a force of 4000 regular infantry and 500 cavalry. The rest followed, without the Greeks making any effort to intercept them.

The conditions of the war were now completely changed. The Greeks, who had been squandering the money provided by the loans in every sort of senseless extravagance, affected to despise the Egyptian invaders, but they were soon undeceived. On the 21st of March Ibrahim had laid siege to Navarino, and after some delay a Greek force under Skourti, a Hydriote sea-captain, was sent to its relief. The Greeks had in all some 7000 men, Suliotes, Albanians, *armatoli* from Rumelia, and some irregular Bulgarian and Vlach cavalry. On the 19th of April they were met by

Second civil war, 1824.

Intervention of Mehemet Ali.

Ibrahim in the Morea.

Ibrahim at Kromomydi with 2000 regular infantry, 400 cavalry and four guns. The Greek entrenchments were stormed at the point of the bayonet by Ibrahim's fellahin at the first onset; the defenders broke and fled, leaving 600 dead on the field. The news of this disaster, and of the fall of Pylos and Navarino that followed, struck terror into the Greek government; and in answer to popular clamour Kolokotronis was taken from prison and placed at the head of the army. But the guerilla tactics of the wily klepht were powerless against Ibrahim, who marched northward, and, avoiding Nauplia for the present, seized Tripolitsa, and made this the base from which his columns marched to devastate the country far and wide.

Meanwhile from the north the Ottomans were making another supreme effort. The command of the army that was to operate in west Hellas had been given to Reshid "Kutahia," Reshid "Kutahia" pasha of Iannina, an able general and a man of determined character. On the 6th of April, after bribing the Albanian clansmen to neutrality, he passed the defile of Makrynoros, which the Greeks had left undefended, and on the 7th of May opened the second siege of Missolonghi. For twelve months the population held out, repulsing the attacks of the enemy, refusing every offer of honourable capitulation. This resistance was rendered possible by the Greek command of the sea, Miaoulis from time to time entering the lagoons with supplies; it came to an end when this command was lost. In September 1825 Ibrahim, at the order of the sultan, had joined Reshid before the town; piecemeal the outlying forts and defences now fell, until the garrison, reduced by starvation and disease, determined to hazard all on a final sortie. This took place on the night of the 22nd of April 1826; but a mistaken order threw the ranks of the Greeks into disorder, and the Turks entered the town pell-mell with the retreating crowd. Only a remnant of the defenders succeeded in gaining the forests of Mount Zygos, where most of them perished.

The fall of Missolonghi, followed as this was by the submission of many of the more notable chiefs, left Reshid free to turn his attention to East Hellas, where Gouras had been ruling as a practically independent chief and in the spirit of a brigand. The peasants of the open country welcomed the Turks as deliverers, and Reshid's conciliatory policy facilitated his march to Athens, which fell at the first assault on the 25th of August, siege being at once laid to the Acropolis, where Gouras and his troops had taken refuge. Round this the war now centred; for all recognized that its fall would involve that of the cause of Greece. In these straits the Greek government entrusted the supreme command of the troops to Karaiskakis, an old retainer of Ali of Iannina, a master of the art of guerilla war, and, above all, a man of dauntless courage and devoted patriotism. A first attempt to relieve the Acropolis, with the assistance of some disciplined troops under the French Colonel Fabvier, was defeated at Chaidari by the Turks. The garrison of the Acropolis was hard pressed, and the death of Gouras (October 13th) would have ended all, had not his heroic wife taken over the command and inspired the defenders with new courage. For months the siege dragged on, while Karaiskakis fought with varying success in the mountains, a final victory at Distomo (February 1827) over Omar Vrioni securing the restoration to the Greek cause of all continental Greece, except the towns actually held by the Turks.

It was at this juncture that the Greek government, reinforced by a fresh loan from Europe, handed over the chief command at sea to Lord Cochrane (earl of Dundonald, *q.v.*), and that of the land forces to General (afterwards Sir Richard) Church, both Miaoulis and Karaiskakis consenting without demur to serve under them.

Cochrane and Church at once concentrated their energies on the task of relieving the Acropolis. Already, on the 5th of February, General Gordon had landed and entrenched himself on the hill of Munychia, near the ancient Piræus, and the efforts of the Turks to dislodge him had failed, mainly owing to the fire of the steamer "Karteria" commanded by Captain Hastings. When Church and Cochrane arrived, a general assault on the

Ottoman camp was decided on. This was preceded, on the 25th of April, by an attack, headed by Cochrane, on the Turkish troops established near the monastery of St Spiridon, the result of which was to establish communications between the Greeks at Munychia and Phalerum and isolate Reshid's vanguard on the promontory of the Piræus. The monastery held out for two days longer, when the Albanian garrison surrendered on terms, but were massacred by the Greeks as they were marching away under escort. For this miserable crime Church has, by some historians, been held responsible by default; it is clear, however, from his own account that no blame rests upon him (see his *MS. Narrative*, vol. i. chap. ii. p. 34). The assault on the Turkish main camp was fixed for the 6th of May; but, unfortunately, a chance skirmish brought on an engagement the day before, in the course of which Karaiskakis was killed, an irreparable loss in view of his prestige with the wild *armatoli*. The assault on the following day was a disastrous failure. The Greeks, advancing prematurely over broken ground and in no sort of order, were fallen upon in flank by Reshid's horsemen, and fled in panic terror. The English officers, who in vain tried to rally them, themselves only just escaped by scrambling into their boats and putting off to the war-vessels, whose guns checked the pursuit and enabled a remnant of the fugitives to escape. Church held Munychia till the 27th, when he sent instructions for the garrison of the Acropolis to surrender. On the 5th of June the remnant of the defenders marched out with the honours of war, and continental Greece was once more in the power of the Turks. Had Reshid at once advanced over the Isthmus, the Morea also must have been subdued; but he was jealous of Ibrahim, and preferred to return to Iannina to consolidate his conquests.

The fate of Greece was now in the hands of the Powers, who after years of diplomatic wrangling had at last realized that intervention was necessary if Greece was to be saved for European civilization. The worst enemy of the Greeks was their own incurable spirit of faction; in the very crisis of their fate, during the siege of Missolonghi, rival presidents and rival assemblies struggled for supremacy, and a third civil war had only been prevented by the arrival of Cochrane and Church. Under their influence a new National Assembly met at Troezen in March 1827 and elected as president Count Capo d'Istria (*q.v.*), formerly Russian minister for foreign affairs; at the same time a new constitution was promulgated which, when the very life of the insurrection seemed on the point of flickering out, set forth the full ideal of Pan-Hellenic dreams. Anarchy followed; war of Rumeliotis against Moreotes, of chief against chief; rival factions bombarded each other from the two forts at Nauplia over the stricken town, and in derision of the impotent government. Finally, after months of inaction, Ibrahim began once more his systematic devastation of the country. To put a stop to this the Powers decided to intervene by means of a joint demonstration of their fleets, in order to enforce an armistice and compel Ibrahim to evacuate the Morea (Treaty of London, July 6, 1827). The refusal of Ibrahim to obey, without special instruction from the sultan, led to the entrance of the allied British, French and Russian fleet into the harbour of Navarino and the battle of the 20th of October 1827 (see NAVARINO). This, and the two campaigns of the Russo-Turkish war of 1828-29, decided the issue.

AUTHORITIES.—There is no trustworthy history of the war, based on all the material now available, and all the existing works must be read with caution, especially those by eye-witnesses, who were too often prejudiced or the dupes of the Greek factions. The best-known works are: G. Finlay, *Hist. of the Greek Revolution* (2 vols., London, 1861); T. Gordon, *Hist. of the Greek Revolution* (London, 1833); C. W. P. Mendelssohn-Bartholdy, *Geschichte Griechenlands, etc. (Staatengeschichte der neuesten Zeit)* (2 vols., Leipzig, 1870-1874); F. C. H. L. Pouqueville, *Histoire de la régénération de la Grèce, etc.* (4 vols., Paris, 1824).—The author was French resident at the court of Ali of Iannina and afterwards consul at Patras; Count A. Prokesch-Osten, *Geschichte des Abfalls der Griechen vom türkischen Reich, etc.* (6 vols., Vienna, 1867), the last four volumes consisting of *pièces justificatives* of much value. See also W. Alison Phillips, *The War of Greek Independence* (London and New York,

Greek
defeat at
Athens.

Renewed
anarchy.

Reshid
"Kutahia"
besieges
Misso-
longhi.

Karaiskakis.

Cochrane
and
Church.

1897), a sketch compiled mainly from the above-mentioned works: Spiridonos Tricoupi, *Ἱστορία τῆς Ἑλλάδος ἐκαστοῦ αἰῶνος* (Athens, 1853); J. Philémon, *Δοκίμιον Ἱστορίας τῆς Ἑλλάδος ἐκαστοῦ αἰῶνος* (Athens, 1859), in four parts: (1) History of the Heteria Philike, (2) The breaking of the war and the rising under Ypsilanti, (3 and 4) The insurrection in Greece to 1822, with many documents. Of great value also are the 29 volumes of Correspondence and Papers of Sir Richard Church, now in the British Museum (Add MSS. 36,543-36,571). Among these is a Narrative by Church of the war in Greece during his tenure of the command (vols. xxi-xxiii., Nos. 36,563-36,568), which contains the material for correcting many errors repeated in most works on the war, notably the strictures of Finlay and others on Church's conduct before Athens. For further references see the bibliography appended to W. Alison Phillips's chapter on "Greece and the Balkan Peninsula" in the *Cambridge Modern History*, x. 803. (W. A. P.)

GREEK LANGUAGE. Greek is one of the eight main branches into which the Indo-European languages (g.9.) are divided. The area in which it is spoken has been curiously constant throughout its recorded history. These limits are, roughly speaking, the shores of the Aegean, on both the European and the Asiatic side, and the intermediate islands (one of the most archaic of Greek dialects being found on the eastern side in the island of Cyprus), and the Greek peninsula generally from its southern promontories as far as the mountains which shut in Thessaly to the north. Beyond Mt. Olympus and the Cambunian mountains lay Macedonia, in which a closely kindred dialect was spoken, so closely related, indeed, that O. Hoffmann has argued (*Die Makedonen*, Göttingen, 1906) that Macedonian is not only Greek, but a part of the great Aeolic dialect which included Thessalian to the south and Lesbian to the east. In the north-west, Greek included many rude dialects little known even to the ancient Greeks themselves, and it extended northwards beyond Aetolia and Ambracia to southern Epirus and Thesprotia. In the Homeric age the great shrine of Pelagian Zeus was at Dodona, but, by the time of Thucydides, Aetolia and all north of it had come to be looked upon as the most backward of Greek lands, where men lived a savage life, speaking an almost unintelligible language, and eating raw flesh (*ἀγρωστότατοι δὲ γλώσσαν καὶ ὠμόθυγοι*, Thuc. iii. 94, of the Aetolian Eurytanes). The Greeks themselves had no memory of how they came to occupy this land. Their earliest legends connected the origin of their race with Thessaly and Mt. Pindus, but Athenians and Arcadians also boasted themselves of autochthonous race, inhabiting a country wherein no man had preceded their ancestors. The Greek language, at any rate as it has come down to us, is remarkably perfect, in vowel sounds being the most primitive of any of the Indo-European languages, while its verb system has no rival in completeness except in the earliest Sanskrit of the Vedic literature. Its noun system, on the other hand, is much less complete, its cases being more broken down than those of the Aryan, Armenian, Slavonic and Italic families.

The most remarkable characteristic of Greek is one conditioned by the geographical aspect of the land. Few countries are so broken up with mountains as Greece. Not only do mountain ranges as elsewhere on the European continent run east and west, but other ranges cross them from north to south, thus dividing the portions of Greece at some distance from the sea into hollows without outlet, every valley being separated for a considerable part of the year from contact with every other, and inter-communication at all seasons being rendered difficult. Thus till external coercion from Macedonia came into play it was never possible to establish a great central government controlling the Greek mainland. The geographical situation of the islands in the Aegean equally led to the isolation of one little territory from another. To these geographical considerations may be added the inveterate desire of the Greeks to make the πόλις, the city state, everywhere and at all times an independent unit, a desire which, originating in the geographical conditions, even accentuated the isolating effect of the natural features of the country. Thus at one time in the little island of Amorgos there were no less than three separate and independent political units. The inevitable result of geographical and political division was the maintenance of a great number of local characteristics in language, differentiating in this respect also each political community from its nearest neighbours. It was only natural that the inhabitants of a country so little adapted to maintain a numerous population should have early sent off swarms to other lands. The earliest stage of colonization lies in the borderland between myth and history. The Greeks themselves knew that a population had preceded them in the islands of the Cyclades which they identified

with the Carians of Asia Minor (Herodotus i. 171; Thucydides i. 4. 8). The same population indeed appears to have preceded them on the mainland of Greece, for there are similar place-names in Caria and in Greece which have no etymology in Greek. Thus the endings of words like Parnassus and Halicarnassus seem identical, and the common ending of place-names in -*αἶον*, *Κάρουλον*, *Προβάλαρον*, &c., seems to be the same in origin with the common ending of Asiatic names in -*nda*, Alinda, Karyanda, &c. Probably the earliest portion of Asia Minor to be colonized by the Greeks was the north-west, to which came settlers from Thessaly, when the early inhabitants were driven out by the Thesprotians, who later controlled Thessaly. The name Aeolis, which after times gave to the N.W. of Asia Minor, was the old name for Thessaly (Hdt. vii. 176). These Thesprotians were of the same stock as the Dorians, to whose invasion of the Peloponnese the later migration, which carried the Ionians to Asia and the Cypriot Greeks to Cyprus, in all probability was due. From the north Aegean probably the Dorians reached Crete, where alone their existence is recorded by Homer (*Odyssey*, xix. 175 ff.; Diodorus Siculus v. 80. 2); cp. Fick, *Vorgriechische Ortsnamen* (1906).

Among the Greeks of the pre-Dorian period Herodotus distinguishes various stocks. Though the name is not Homeric, both Herodotus and Thucydides recognize an Aeolian stock which must have spread over Thessaly and far to the west till it was suppressed and absorbed by the Dorian stock which came in from the north-west. The name of Aeolis still attached in Thucydides' time to the western area of Calydon between the mountains and the N. side of the entrance to the Corinthian gulf (iii. 102). In Boeotia the same stock survived (Thuc. vii. 57. 3), overlaid by an influx of Dorians, and it came down to the isthmus; for the Corinthians, though speaking in historical times a Doric dialect, were originally Aeolians (Thuc. iv. 42). In the Peloponnese Herodotus recognizes (viii. 73) three original stocks, the Arcadians, the Ionians of Cyauria, and the Achaeans. In Arcadia there is little doubt that the pre-Dorian population maintained itself and its language, just as in the mountains of Wales, the Scottish Highlands and Connemara the Celtic language has maintained itself against the Saxon invaders. By Herodotus' time the Cynurians had been doricized, while the Ionians, along the south side of the Corinthian gulf, were expelled by the Achaeans (vii. 94, viii. 73), apparently themselves driven from their own homes by the Dorian invasion (Strabo viii. p. 333 ff.). However this may be, the Achaeans of historical times spoke a dialect akin to that of northern Elis and of the Greeks on the north side of the Corinthian gulf. How close the relation may have been between the language of the Achaeans of the Peloponnese in the Homeric age and their contemporaries in Thessaly we have no means of ascertaining definitely, the documentary evidence for the history of the dialects being all very much later than Homeric times. Even in the Homeric catalogue Agamemnon has to lend the Arcadians ships to take them to Troy (*Iliad*, ii. 612). But a population speaking the same or a very similar dialect was probably seated on the eastern coast, and migrated at the beginning of the Doric invasion to Cyprus. As this population wrote not in the Greek alphabet but in a peculiar syllabary and held little communication with the rest of the Greek world, it succeeded in preserving in Cyprus a very archaic dialect very closely akin to that of Arcadia, and also containing a considerable number of words found in the Homeric vocabulary but lost or modified in later Greek elsewhere.

On this historical foundation alone it is possible to understand clearly the relation of the dialects in historical times. The prehistoric movements of the Greek tribes can to some extent be realized in their dialects, as recorded in their inscriptions, though all existing inscriptions belong to a much later period. Thus from the ancient Aeolis of northern Greece sprang the historical dialects of Thessaly and Lesbos with the neighbouring coast of Asia Minor. At an early period the Dorians had invaded and to some extent affected the character of the southern Thessalian and to a much greater extent that of the Boeotian dialect. The dialects of Locris, Phocis and Aetolia were a somewhat uncouth and unlitary form of Doric. According to accepted tradition, Elis had been colonized by Oxyilus the Aetolian, and the dialect of the more northerly part of Elis, as already pointed out, is, along with the Achaean of the south side of the Corinthian gulf, closely akin to those dialects north of the Isthmus. The most southerly part of Elis—Triphylia—has a dialect akin to Arcadian. Apart from Arcadian the other dialects of the Peloponnese in historical times are all Doric, though in small details they differ among themselves. Though we are unable to check the statements of the historians as to the area occupied by Ionic in prehistoric times, it is clear from the legends of the close connection between Athens and Troezen that the same dialect had been spoken on both sides of the Saronic gulf, and may well have extended, as Herodotus says, along the eastern coast of the Peloponnese and the south side of the Corinthian gulf. According to legend, the Ionians expelled from the Peloponnese collected at Athens before they started on their migrations to the coast of Asia Minor. Be that as it may, legend and language alike connected the Athenians with the Ionians, though by the 5th century B.C. the Athenians no longer cared to be known by the name (Hdt. i. 143). Lesbos, Imbros and Scyros, which had long belonged to Athens, were Athenian also in language. The great island of Euboea and all the islands of the central Aegean between Greece and Asia were Ionic. Chios, the most

northerly Ionic island on the Asiatic coast, seems to have been originally Aeolic, and its Ionic retained some Aeolic characteristics. The most southerly of the mainland towns which were originally Aeolic was Smyrna, but this at an early date became Ionic (Hdt. i. 149). The last important Ionic town to the south was Miletus, but at an early period Ionic widened its area towards the south also and took in Halicarnassus from the Dorians. According to Herodotus, there were four kinds of Ionic (χαλαρῆς ἢ ἄσπης ἴσπης, i. 142). Herodotus tells us the areas in which these dialects were spoken, but nothing of the differences between them. They were (1) Samos, (2) Chios and Erythrac, (3) the towns in Lydia, (4) the towns in Caria. The language of the inscriptions unfortunately is a κοινή, a conventional literary language which reveals no differences of importance. Only recently has the characteristic so well known in Herodotus of *α* appearing in certain words where other dialects have *η* (δύμης for δῦμης, κῆρ for κῆρ, &c.) been found in any inscription. It is, however, clear that this was a popular characteristic not considered to be sufficiently dignified for official documents. We may conjecture that the native languages spoken on the Lydian and Carian coasts had affected the character of the language spoken by the Greek immigrants, more especially the settlers from Athens married Carian women, while the settlers in the other towns were a mixture of Greek tribes, many of them not Ionic at all (Hdt. i. 146).

The more southerly islands of the Aegean and the most southerly peninsula of Asia Minor were Doric. In the Homeric age Dorians were only one of many peoples in Crete, but in historical times, though the dialects of the eastern and the western ends of the island differ from one another and from the middle whence our most valuable documents come, all are Doric. By Melos and Thera Dorians carried their language to Cos, Calymnus, Cnidus and Rhodes.

These settlements, Aeolic, Ionic and Doric, grew and prospered, and like flourishing hives themselves sent out fresh swarms to other lands. Most prosperous and energetic of all was Miletus, which established its trading posts in the Black Sea to the north and in the delta of the Nile (Naukratis) to the south. The islands also sent off their colonies, carrying their dialects with them, Paros to Thasos, Euboea to the peninsula of Chalcidice; the Dorians of Megara guarded the entrance to the Black Sea at Chalcidion and Byzantium. While Achæan influence spread out to the more southerly Ionian islands, Corinth carried her dialect with her colonies to the coast of Acarnania, Leucas and Coreyra. But the greatest of all Corinthian colonies was much farther to the west—at Syracuse in Sicily. Unfortunately the continuous occupation of the same or adjacent sites has led to the loss of almost all that is early from Corinth and from Syracuse. Coreyra has bequeathed to us some interesting grave inscriptions from the 6th century B.C. Southern Italy and Sicily were early colonized by Greeks. According to tradition Cumæ was founded not long after the Trojan War; even if we bring the date nearer the founding of Syracuse in 735 B.C., we have apparently no record earlier than the first half of the 5th century B.C., though it is still the earliest of Chalcidian inscriptions. Tarentum was a Laconian foundation, but the longest and most important document from a Laconian colony in Italy comes from Heraclea about the end of the 4th century B.C.—the report of a commission upon and the lease of temple lands with description and conditions almost of modern precision. To Achæa belonged the south Italian towns of Croton, Metapontum and Sybaris. The ancestry of the Greek towns of Sicily has been explained by Thucydides (vi. 2-5). Selinus, a colony of Megara, bewrays its origin in its dialect. Gela and Agrigentum so less clearly show their descent from Rhodes. According to tradition the great city of Cyrene in Africa was founded from Thera, itself an offshoot from Sparta.

CHIEF CHARACTERISTICS OF THE GREEK DIALECTS

1. *Arcadian and Cyprian.*—As Cyprian was written in a syllabary which could not represent a consonant by itself, did not distinguish between voiced, unvoiced and aspirated consonants, did not represent at all a nasal before another consonant, and did not distinguish between long and short vowels, the interpretation of the symbols is of the nature of a conundrum and the answer is not always certain. Thus the same combination of two symbols would have to stand for *νόη*, *νὴη*, *νὴη*, *νὴη*, *νὴη*, *νὴη*, *νὴη*, *νὴη*. No inscription of more than a few words in length is found in either dialect earlier than the 5th century B.C. In both dialects the number of important inscriptions is steadily increasing. Both dialects change final *ο* to *υ*, *ἀρὸ* passing into *ἀρὺ*. Arcadian changes the verb ending *-ας* into *-α*. Arcadian uses *θ* or *τ* for an original *gw*-sound, which appears in Attic Greek as *β*: *πέλλα*, Attic *πέλας*, "throw." In inflection both agree in changing *-ας* of masculine *-α* stems into *ου* (Arcadian carries this form also into the feminine *-α* stems), and in using locatives in *-α* and *-οι* for the dative, such locatives being governed by the prepositions *ἐν* and *ἐκ* (before a consonant *ἐκ* in Arcadian). Verbs in *-ου*, *-ου* and *-ου* are declined not as *-ου*, but as *-μ* verbs. The final *ι* of the ending of the 3rd plural present changes the preceding *τ* to *σ*: *φάσμεν*, cp. Laconian (Doric) *φάσμεν*, Attic *φάσμεν*, Lesbian *φάσμεν*. Instead of the Attic *τίς*, the interrogative pronoun appears as *τίς*, the initial *ε* in Arcadian being written with a special symbol *ϵ*. The pronunciation is not certain. The original sound was *gw*, as in Latin *quis*, whence Attic *τις* and Thessalian *τίς*. In Arcadian *κα* the Aeolic particle *κα* and the Ionic *αυ* seem to be combined.

2. *Aeolic.*—Though Boeotian is overlaid with a Doric element, it nevertheless agrees with Thessalian and Lesbian in some characteristics. Unlike Greek generally, they represent the original *gw* of the word for four by *τ* before *α*, where Attic and other dialects have *τ*: *τίτταρες*, Attic *τίτταρες*. The corresponding voiced and aspirated sounds are similarly treated: *βήφαρος* the adjective in Thessalian to *Δελφός*, and *θῆρ* for *θήρ*. They all tend to change *ο* to *υ*: *ἄνωμα*, "name"; *οἷ* for *ω* in Thessalian: *Ἄνωμα*, "Apollo"; and *υ* in Boeotian for *α*: *ἄνεια* (*οἰκία*), "house." They also make the dative plural of the third declension in *-ουσι*, and the perfect participle active is declined like a present participle in *-ου*. Instead of the Athenian method of giving the father's name in the genitive when a citizen is described, these dialects (especially Thessalian) tend to make an adjective: thus instead of the Attic *Ἀριστομένης Ἀριστομένηου*, Aeolic would rather have *Ἀ. Ἀριστομένηου*. Thessalian stands midway between Lesbian and Boeotian, agreeing with Lesbian in the use of double consonants, where Attic has a single consonant, with or without lengthening of the previous syllable: *ἔμμε*, Attic *ἐμμῆ* for an original **εμμί*; *στέλλα*, Attic *στῆλα*; *έτρος* for an earlier **ετρος*, Attic *έτρος*, Ionic *έτρος*, Doric *έτρος*. Where Attic has *-ας* from an earlier **-ασ* or **-αστ*, Lesbian has *-αυ*: *πῆς* *ἄρχαια* accusative in Lesbian for older **πῆς* *ἄρχαια*. Lesbian has no oxyton words according to the grammarians, the accent being carried back to the penult or antepenultimate syllable. It has also no "rough breathing," but this characteristic it shared with the Ionic of Asia Minor, and in the course of time with other dialects. The characteristic particle of the dialects is *ε*, which is used like the Doric *κα*, the Arcadian *κα*, and the Attic and Ionic *κα*. Thessalian and Lesbian agree in making their long vowels close, *η* belonging *εε* (a close *ε*, not a diphthong), *πατήρ*, "father." The *υ* sound did not become *υ* as in Attic and Ionic, and hence when the Ionic alphabet was introduced it was spelt *ου*, or when in contact with dentals *ουσ*, as in *δούλωμα* = *δύλωμα*, "name," *τύχουα* = *τύχη*, "chance"; the pronunciation, therefore, must have been like the English sound in *power*, *uncle*. Boeotian developed earlier than other dialects the changes in the vowels which characterize modern Greek: *αι* became *ε*, *και* passing into *αι*; compare *κατέρι* and *φαίλα* above: *αι* became *ι* in *εχί*, "has." Thessalian shows some examples of the Homeric genitive in *-ου*: *πυλόροσ*, &c.; its ordinary genitive of *ο*-stems is in *-ου*.

There are some points of connection between this group and Arcadian-Cyprian: in both Thessalian and Cyprian the characteristic *πῆς* (*Attic*, &c., *πῆς*) and *έτρος* for *έτρος* are found, and both groups form the "contracting verbs" not in *-ου* but in *-μ*. In the second group as in the first there is little that precedes the 5th century B.C. Future additions to our materials may be expected to lessen the gap between the two groups and Homer.

3. *Ionic-Attic.*—One of the earliest of Greek inscriptions—of the 7th century, at least—is the Attic inscription written in two lines from right to left upon a wine goblet (*οὐρεχέτι*) given as a prize: *ἔτι τῷ ἄρχαιῶν πάντων ἀπαιτήτων παίζει τῶτο δοῦν μῦ*. The last words are uncertain. Till lately early inscriptions in Ionic were few, but recently an early inscription has been found at Ephesus and a later copy of a long early inscription at Miletus.

The most noticeable characteristic of Attic and Ionic is the change of *ā* into *η* which is universal in Ionic but does not appear in Attic after another vowel or *ρ*. Thus both dialects used *μήτηρ*, *τιμήρ*, from an earlier *μάτηρ*, *τιμάτ*, but Attic had *μήτρα*, *μήτρα* and *χόρη*, not *σφήη*, *σφήη* and *χόρη* as in Ionic. The apparent exception *αἰρη* is explained by the fact that in this word a digamma *f* has been lost after *η*, in Doric *αἰρη*. That the change took place after the Ionians came into Asia is shown by the word *Μέδοι*, which in Cyprian is *Μέδοι*; the *Μέδοι* were certainly not known to the Greeks till long after the conquest of Ionia. While Aeolic and the greater part of Doric kept *τ*, this symbol and the sound *w* represented by it had disappeared from both Ionic and Attic before existing records begin—in other words, were certainly not in use after 800 B.C. The symbol was known and occurs in a few isolated instances. Both dialects agreed in changing *ω* into *υ*, so that a *ω* sound has to be represented by *ου*. The short *ο* tended towards *ι*, so that the contraction of *ο* + *ο* gave *ου*. In the same way short *ε* tended towards *ι*, so that the contraction of *ε* + *ε* gave *αι*, which was not a diphthong but a close *ε*-sound. In Attic these contractions were represented by *Ο* and *Ε* respectively till the official adoption of the Ionic alphabet at Athens in 403 B.C. So also were the lengthened syllables which represent in their length the loss of an earlier consonant, as *έμων* and *έμωμ*, Aeolic *έμωμ*, *έμωμ*, which stand for a prehistoric **έμωμ* and **έμωμ*, containing the *-ω* of the first present, and *έμωμ*, *έμωμ*, *έμωμ*, representing an earlier **έμωμ*, *έμωμ*, *έμωμ* (*ε* pl. present) or **έμωμ* (dative pl. of present participle). Both dialects also agreed in changing *τ* before *ι* into *σ* (like Aeolic), as in *έχωμαι* above, and in the 3rd person singular of *-μ* verbs, *τῆσθε*, *δίδωσθε*, &c., and in noun stems, as in *δέδωκ* for an earlier **δέδωκ*. Neither dialect used the particle *εε* or *εα*, but both have *εε* instead. One of the effects of the change of *ā* into *η* was that the combination *εο* changed in both dialects to *ηο*, which in all Attic records and in the later Ionic has become *ω* by a metathesis in the quantity of the vowels: *πῆς*, earlier *πῆς*, "temple," is in Homeric Greek *πῆς*, in later Ionic and Attic *πῆς*. In the dative (locative) plural of the *-α* stems, Ionic has generally *-μυ* on the analogy of the singular; Attic had first the old locative form in *-μυ*, *-μυ*, which survived

in forms which became adverbs like Ἀθήραι and ἑσπέραι; but after 430 B.C. these were replaced by -αι, ἑσπέραι, &c. The Ionic of Asia Minor showed many changes earlier than that of the Cyclades and Euboea. It lost the aspirate very early: hence in the Ionic alphabet Η is θ, not ἥ; it changed ω and ω into ω and ω, and very early replaced to a large extent the -μ by the -ν verbs. This confusion can be seen in progress in the Attic literature of the 5th and 4th centuries B.C.; δέλεμα gradually giving way to δελμα, while the literature generally uses forms like δέμα for δέμα (impf.). In Attica also the aspiration which survived in the Ionic of Euboea and the Cyclades ceased by the end of the 5th century. The Ionic of Asia Minor has -αι as the genitive of ι-stems; the other forms of Ionic have -ιδων.

Doric.—As already mentioned, the dialects of the North-West differ in several respects from Doric elsewhere. As general characteristics of Doric may be noted the contractions of α+α into η, and of α+ο into ω into ε, while the results in Attic and Ionic of these contractions are ε and ω respectively: δέμα from δέμα, Attic δέμα; τιμήμα τ pl. pres. from τιμήμα, Attic τιμήμα; τιμήν gen. pl. of τιμή "honour," Attic τιμήν. In inflection the most noticeable points are the pronominal adverbs in locative form: τούθεν, τούθεν (this from a stem limited to a few Doric dialects and the Boeotic Poets), τοῦθεν, ὅθεν, &c.; the nom. pl. of the article τοί, τὰ, not οἱ, αἱ, and so τούτοι in Selinus and Rhodes; the 1st pl. of the verb in -μεν, not in -μεν, cp. the Latin -mus; the aorist and future in -ε, where other dialects have -ε, or contraction from presents in -τω; δέμα, δέμα, Doric δέμα, &c.; the future passive with active endings, ἐπιμαθήσομεν (Rhodes), found as yet only in the Doric islands and in the Doric prose of Archimedes; the particles αἰ "if" and κα with a similar value to the Aeolic αἰ and the Attic-Ionic εἰ. Doric had an accentuation system different both from Aeolic and from Ionic-Attic, but the details of the system are very imperfectly known.

In older works Doric is often divided into a *dialectus superior* and a *dialectus inferior*. But the difference is one of time rather than of place, the peculiarities of Doric being gradually softened down till it was ultimately merged in the *lingua franca*, the κοινή, which in time engulfed all the local dialects except the descendant of Spartan, Teakonian. Here it is possible to mention its varieties only in the briefest form. (a) The southern dialects are well illustrated in the inscriptions of Laconia recently much increased in number by the excavations of the British School at Athens. Apart from some brief dedications, the earliest inscription of importance is the list of names placed on a bronze column soon after 479 B.C. to commemorate the tribes which had repulsed the Persians. The column, originally at Delphi, is now at Constantinople. The most striking features of the dialect are the retention of F at the beginning of words, as in the dedication from the 6th century *Favaiθnos* (*Annals of British School*, xiv. 144). The dialect changed -ε- between vowels into -ε-, μῆμα for μῆμα "muse." Later it changed θ into a sound like the English th, which was represented by σ. Before ο-sounds -ε- here and in some other Doric dialects changed to ι: θῆμα, ἴδα for θῆμα "god." The result of contraction and "compensatory lengthening" was not ε and ω as in Attic and Ionic, but η and ω: ἴμα infinitive = ἴμα from ἴμα; gen. sing. of ο-stems in ω: θῆμα, acc. pl. in -ω: θῆμα; ἴμα was represented by θ, not θ, as in Attic-Ionic; μῆμα = μῆμα. The dialect has many strange words, especially in connexion with the state education and organization of the boys and young men. The Heracleian tables from a Laconian colony in S. Italy have curious forms in -αισι for the dat. pl. of the participle *επαυδόντων* = Attic *επαυδόντων*. Of the dialect of Messenia we know little, the long inscription about mysteries from Andania being only about 100 B.C. From Argolis there are a considerable number of early inscriptions, and in a later form of the dialect the cures recorded at the temple of Asclepius at Epidaurus present many points of interest. There is also an inscription of the 6th century B.C. from the temple of Aphaia in Aegina. F survives in the old inscriptions: *Fεραμῆμα* (= *εραμῆμα*); *μ*, whether original or arising by sound change from -μ, persists till the 2nd century B.C.: *μῆμα* = *μῆμα* = *μῆμα*, *μῆμα* *μῆμα* = *μῆμα* = *μῆμα*. The dialect of the Isthmus valley seems to resemble Laconian more closely than does that of the rest of the Argolic area. Corinth and her colonies in the earliest inscriptions preserve F and Q (= Latin Q) before ο and υ sounds, and write ξ and ψ by γξ and φξ, the symbols which are used also for this purpose in old Attic. In the Corthyraean and Sicilian forms of the dialect, λ before a dental appears as ρ: *φῆμα* = *φῆμα*; and in Sicilian the perfect-active was treated as a present: *δέμα* for *δέμα*, &c. From Megara has come lately an obscure inscription from the beginning of the 5th century; its colony Selinus has inscriptions from the middle of the same century; the inscriptions from Byzantium and its other Pontic colonies date only from Hellenistic times. In Crete, which shows a considerable variety of subdialects, the most important document is the great inscription from Gortyn containing twelve tables of family law, which was discovered in 1884. The local alphabet has no separate symbols for ρ and φ, and these sounds are therefore written with κ and π. As in Argive the combination -μ was kept both medially and finally except before words beginning with a consonant; -μ was represented by ρ, later by -ρ-, as in Thessalian and Boeotian: *δέρμα*, Attic *δέρμα*; and finally by -θ-, λ combined with a preceding vowel into an *psu*-diphthong: *θῆμα*, Attic *θῆμα*, cp. the English

pronunciation of *talk*, &c. In Gortyn and some other towns -θ- was assimilated to -θ-, where θ must have been a spirant like the English *th* in *thin*; ρ of Attic Greek is represented initially by θ, medially by θ, but in some towns by ρ and ρ: *θῆμα* (= *θῆμα*), *δέρμα* (= *δέρμα*). Final consonants are generally assimilated to the beginning of the next word. In inflection there are many local peculiarities. In Melos and Thera some very old inscriptions have been found written in an alphabet without symbols for φ, χ, ψ, ξ, which are therefore written as πθ, κθ or ρ θ, πθ, κθ. The contractions of ε+ε and of ο+ο are represented by E and O respectively. The old rock inscriptions of Thera are among the most archaic yet discovered. The most characteristic feature of Rhodian Doric is the infinitive in -μεν: *δέμα*, &c. (= Attic *δέμα*), which passed also to Gela and Agrigentum. The inscriptions from Cos are numerous, but too late to represent the earliest form of the dialect.

(b) The dialects of N.W. Doric, Locrian, Phocian, Aetolian, with which go Elean and Achaean, present a more uncouth appearance than the other Doric dialects except perhaps Cretan. Only from Locris and Phocis come fairly old inscriptions; later a κοινή was developed, in which the documents of the Aetolian league are written, and of which the most distinctive mark is the dative plural of consonant stems in -αι: *δέμα* (= Attic *δέμα*), *δέμα* (= Attic *δέμα*), &c. Phocian and the Locrian of Opus have also forms like Aeolic in -αι. In place of the dative in -αι, locatives in -αι are used in Locrian and Phocian. Generally north of the Corinthian gulf the middle present participle from -ω-verbs ends in -μενος; similar forms are found also in Elean. Locrian changed ε before ρ into α: *πῆμα* for *πῆμα*; cf. English *Kerr* and *Carr*, *sergeant* and *Sargeant*. σρ appears for σθ, and P and F are still much in use in the 5th century B.C. Many thousands of inscriptions were found in the French excavations at Delphi, but nothing earlier than the 5th century B.C. In the older inscriptions the Aeolic influence—datives in -αι, *δέμα* for *δέμα*—is better marked than later. In the Laws of the Labyad phratry (about 400 B.C.) the genitive is in ω, but a form in -ω is also found, *πῆμα*, which seems to be an old ablative fossilized as an adverb. The nom. pl. *δέμα* is used for the acc.; similar forms are found in Elean and Achaean.

The more important of the older materials for Achaean come from the Achaean colonies of S. Italy, and being scanty give us only an imperfect view of the dialect, but it is clearly in its main features Doric. Much more remarkable is the Elean dialect known chiefly from inscriptions found at Olympia, some of which are as early as the beginning of the 6th century. The native dialect was replaced first by a Doric and then by the Attic κοινή, but under the Caesars the archaic dialect was restored. Many of its characteristics it shares with the dialects north of the Corinthian gulf, but it changes original θ to δ: *μῆμα*, &c.; δ was apparently a spirant, as in modern Greek (= θ in English *the*, *thine*), and is represented by ρ in some of the earliest inscriptions. Final -ε became -ε; this is found also in Laconian; -ε became -ε, but was not simplified as in Attic to -ε: Attic *δέμα*.

As we have seen, Ionians, Aetolians and Dorians tended to level local peculiarities and make a generally intelligible dialect in which treaties and other important records were framed. The language of literature is always of necessity to some extent a κοινή; with some Greek writers the use of a κοινή was especially necessary. The local dialect of Boeotia was not easily intelligible in other districts, and a writer like Pindar, whose patrons were mostly not Boeotians, had perforce to write in a dialect that they could understand. Hence he writes in a conventional Doric with Aeolic elements, which forms a strong contrast to that of Corinna, who kept more or less closely to the Boeotian dialect. For different literary purposes Greek had different *κοιναι*. A poet who would write an epic must adopt a form of language modelled on that of Homer and Hesiod; Alcæus and Sappho were the models for the love lyric, which was therefore Aeolic; Stesichorus was the founder of the triumphal ode, which, as he was a Dorian of Sicily, must henceforth be in Doric, though Pindar was an Aetolian, and its other chief representatives, Simonides and Bacchylides, were Ionians from Ceos. The choral ode of tragedy was always conventional Doric, and in the iambics also are Doric words like *δέμα*, *μῆμα*, &c. Elegy and epigram were founded on epic; the satirical iambics of Hipponax and his late disciple Herondas are Ionic. The first Greek prose was developed in Ionia, of which an excellent example has been preserved to us in Herodotus. Thucydides was not an Ionian, but he could not shake himself free of the tradition: he therefore writes *δέμα*, *δέμα*, &c., with -ε, which was Ionic, but is never found in Attic inscriptions nor in the writers who imitate the language of common life—Aristophanes (when not parodying tragedy, or other forms of literature or dialect), Plato and the Orators (with the partial exception of Antiphon, who ordinarily has -ε, but in the one speech actually intended for the law-courts -ε). Similarly Hippocrates and his medical school in Cos wrote in Ionic, not, however, in the Ionic of Herodotus, but in a language more akin to the Ionic κοινή of the inscriptions; and this dialect continued to be used in medicine later, much as doctors now use Latin for their prescriptions. The first literary document written in Attic prose is the treatise on the *Constitution of Athens*, which is generally printed amongst the minor works of Xenophon, but really belongs to about 425 B.C. From the fragment of Aristophanes

Demosthenes and from the first speech of *Lysias* "Against Theonnestos" it is clear that the Attic dialect had changed rapidly in the 6th and 5th centuries B.C., and that much of the phraseology of Solon's laws was no longer intelligible by 400 B.C. Among the most difficult of the literary dialects to trace is the earliest—the Homeric dialect. The Homeric question cannot be discussed here, and on that question it may be said *quod homines lot sententiae*. To the present writer, however, it seems probable that the poems were composed in Chios as tradition asserted; the language contains many Aeolisms, and the heroes sung are, except for the Athenians (very briefly referred to), and possibly Telamonian Ajax, not of the Ionic stock. Chios was itself an Ionized Aeolic colony (Diodorus v. 81. 7). The hypothesis of a great poet writing on the basis of earlier Aeolic lays (*ἄλκιυ κλέων*), in Chios seems to explain the main peculiarities of the Homeric language, which, however, was modified to some extent in later times first under Ionic and afterwards under Athenian influence.

Of Dorian literature we know little. The works of Archimedes written in the Syracusan dialect were much altered in language by the late copyists. The most striking development of the late classical age in Doric lands is that of pastoral poetry, which, like Spenser, is "writ in no language," but, on a basis of Syracusan and possibly Coan Doric, has in its structure many elements borrowed from the Aeolic love lyric and from epic.

From the latter part of the 5th century B.C. Athens became ever more important as a literary centre, and Attic prose became the model for the later *κοινή*, which grew up as a consequence of the decay of the local dialects. For this decay there were several reasons. If the Athenian empire had survived the Peloponnesian War, Attic influence would no doubt soon have permeated the whole of that empire. This consummation was postponed. Attic became the court language of Macedonia, and, when Alexander's conquests led to the foundation of great new towns, like Alexandria, filled with inhabitants from all parts of the Greek world, this dialect furnished a basis for common intercourse. Naturally, the resultant dialect was not pure Attic. There were in it considerable traces of Ionic. In Attic itself the dialect was less uniform than elsewhere even in the 5th century B.C., because Athens was a centre of empire, literature and commerce. Like every other language which is not under the dominion of the schoolmaster, it borrowed the names of foreign objects which it imported from foreign lands, not only from those of Greek-speaking peoples, but also from Egypt, Persia, Lydia, Phoenicia, Thrace and elsewhere. The Ionians were great seafarers, and from them Athens borrowed words for seacraft and even for the tides: *ἔμβριος* "ebb," *ἄλκιον* "high tide," an Ionic word *ἄλκιον* spelt in Attic fashion. From the Dorians it borrowed words connected with war and sport: *ἀρχαίος*, *κωνάριον*, &c. A soldier of fortune like Xenophon, who spent most of his life away from Athens, introduced not only strange words but strange grammatical constructions also into his literary compositions. With Aristotle, not a born Athenian but long resident in Athens, the *κοινή* may be said to have begun. Some characteristics of Attic foreigners found it hard to acquire—its subtle use of particles and its accent. Hence in Hellenistic Greek particles are comparatively rare. According to Cicero, Theophrastus, who came from an near Attika as Eretria in Euboea, was easily detected by a market-woman as not an Athenian after he had lived thirty years in Athens. Theocritus, an Athenian, who was taken prisoner in the Peloponnesian War and lived for many years in Epirus as a slave, was unable to recover the Athenian accent on his return, and his family lay under the suspicion that they were an alien's children, as his son tells us in Demosthenes' speech "Against Eubulides." In the *κοινή* there were several divisions, though the line between them is faint and irregular. There was a *κοινή* of literary men like Polybius and of carefully prepared state documents, as at Magnesia or Pergamum; and a different *κοινή* of the vulgar which is represented to us in its Egyptian form in the Pentateuch, in a later and at least partially Palestinian form in the Gospels. Still more corrupt is the language which we find in the ill-written and ill-spelt private letters found amongst the Egyptian papyri. Not out of the old dialects but out of this *κοινή* arose modern Greek, with a variety of dialects no less bewildering than that of ancient Greek. In one place more rapidly, in another more slowly, the characteristics of modern Greek begin to appear. As we have seen, in Boeotia the vowels and diphthongs began to pass into the characteristic sounds of modern Greek four centuries before Christ. Dorian dialects illustrate early the passing of the old aspirate *ϕ*, the sound of which was like the final *t* in English *bit*, into a sound like the English *h* in *thin*, *ϕῆ*, which it still retains in modern Greek. The change of *ϕ* between vowels into a *y* sound was charged by the comic poets against Hyperbolicus the demagogue about 415 B.C. Only when the Attic sound changes stood isolated amongst the Greek dialects did they give way in the *κοινή* to Ionic. Thus the forms with *-σ-* instead of *-τ-* won the day, while modern Greek shows that sometimes the *-σσ-* which Attic shared with some Doric dialects and Arcadian was retained, and that sometimes the Ionic *-σσ-*, which was also Lesbian and partly Doric, took its place. In other cases, where Ionic and Attic did not agree, forms came in which were different from either: the genitives of masculine *δ* stems were now formed as in Doric with *δ*, but the analogy of the other cases may have been the effective force. The form *ἱεῖον* "temple," instead of

Ionic *ἱεῖον*, Attic *ἱεῖον*, can only be Doric.¹ In the first five centuries of the Christian era came in the modern Greek characteristics of Itacism and vowel contraction, of the pronunciation of *μ* and *ν* as *m* and *n* and many other sound changes, the loss of the dative and the confusion of the 1st with the 3rd declension, the dropping of the *-μ* conjugation, the loss of the optative and the assimilation of the imperfect and second aorist endings to those of the first aorist.² There were meantime spasmodic attempts at the revival of the old language. Lucian wrote Attic dialogue with a facility almost equal to Plato; the old dialect was revived in the inscriptions of Sparta; Balbilla, a lady-in-waiting on Hadrian's empress, wrote epigrams in Aeolic, and there were other attempts of the same kind. But they were only *tour de force*, *εἴρων* *Ἀδωνίαν*, whose flowers had no root in the spoken language and therefore could not survive. Even in the hands of a cultivated man like Plutarch the *κοινή* of the 1st century A.D. looks entirely different from Attic Greek. Apart from non-Attic constructions, which are not very numerous, the difference consists largely in the new vocabulary of the philosophical schools since Aristotle, whose jargon had become part of the language of educated men in Plutarch's time, and made a difference in the language not unlike that which has been brought about in English by the development of the natural sciences. It is hardly necessary to say that these changes, whether of the *κοινή* or of modern Greek, did not of necessity impair the powers of the language as an organ of expression; if elaborate inflection were a necessity for the highest literary merit, then we must prefer *Cædmon* to Milton and *Cynwulf* to Shakespeare.

The Chief Characteristics of Greek.

As is obvious from the foregoing account of the Greek dialects, it is not possible to speak of the early history of Greek as handed down to us as that of a single uniform tongue. From the earliest times it shows much variety of dialect accentuated by the geographical characteristics of the country, but arising, at least in part, from the fact that the Greeks came into the country in separate waves divided from one another by centuries. For the history of the language it is necessary to take as a beginning the form of the Indo-European language from which Greek descended, so far as it can be reconstructed from a comparison of the individual I.E. languages (see INDO-EUROPEAN LANGUAGES). The sounds of this language, so far as at present ascertained, were the following:—

- (a) 11 vowels: *a, ā, e, ē, i, ī, o, ō, u, ū, y* (a short indistinct vowel).
- (b) 14 diphthongs: *ai, ai, ei, ei, oi, oi, ou, ou, ai, ai, ai, ai, ai, ai, ai, ai*.
- (c) 20 stop consonants. Labials: *p, b, ph, bh* (*ph* and *bh* being *p* and *b* followed by an audible breath, not *f* and *v*). Dentals: *t, d, th, dh* (*th* and *dh* not spirants like the two English sounds in *thin* and *then*, but aspirated *t* and *d*). Palatals: *k, g, kh, gh* (*kh* and *gh* aspirates as explained above). Velars: *q, g, qh, gh* (velars differ from palatals by being produced against the soft palate instead of the roof of the mouth). Labio-velars: *q', g', qh', gh'* (these differ from the velars by being combined with a slight labial *w*-sound).
- (d) Spirants—Labial: *w*. Dental: *s, z, s, post-dental ʃ, ʒ, interdental possibly ʃ, ʒ*. Palatal: *x* (Scottish *ch*), *y*. Velar: *x* (a deeply guttural *x*, heard now in Swiss dialects), *ʒ*. Closely akin to *w* and *y* and often confused with them were the semi-vowels *ɥ* and *ʝ*.
- (e) Liquids: *l, r*.
- (f) Nasals: *m* (labial), *n* (dental), *ɲ* (palatal), *ŋ* (velar), the last three in combination with similar consonants.
- (g) As far as the vowels are concerned, Greek retains the original state of things more accurately than any other language. The sounds of short *e* and short *o* in Attic and Ionic were close, so that *e* + *e* contracted to a long close *e* represented by *ai*, *o* + *o* to a long close *o* represented by *ou*. In these dialects *u*, both long and short, was modified to *ū*, and they changed the long *ā* to *ā*, though Attic has *ā* after *ε*, *ι* and *υ*. In Greek *ϕ* appeared regularly as *ϕ*, but under the influence of analogy often as *ϕ* and *ϕ*.
- (h) The short diphthongs as a whole remained unchanged before a following consonant. Before a following vowel the diphthong was divided between the two syllables, the *i* or *υ* forming a consonant at the beginning of the second syllable, which ultimately disappeared. Thus from a root *θεσ-* "run" comes a verb *θεω* for *θε-θε*, from an earlier **θευ-ω*. The corresponding adjective is *θεός* "swift," for *θε-θε-ω*, from an earlier **θευ-ω*. The only dialect which kept the whole diphthong in one syllable was Aeolic. The long diphthongs, except at the ends of words, were shortened in Attic. Some of these appear merely as long vowels, having lost their second element in the prothetic period. Apparent long diphthongs like those in *ἄφροσύνη*, *αἴψα* arise by contraction of two syllables.
- (i) The consonants suffered more extensive change. The voiced aspirates became unvoiced, so that *bh, dh, gh, qh, qh* are confused with original *ph, th, kh, qh*: I.E. **bhros* (Skt. *bhrōṣi*) is Gr. *φρός*; I.E. **dhānos* (Skt. *dhānos*), Gr. *φώνη*; I.E. **ghimo-* (Skt. *ghimā-*).

¹ Thumb, *Die griechische Sprache im Zeitalter des Hellenismus* (1901), pp. 242-243.

² Thumb, *op. cit.* p. 249.

kima-, Gr. (*hwo*)-*χίμα-ς*: I.E. **stigh-* (Skt. *stigh-*), Gr. *στίγχις*: I.E. **ghem-* (Skt. *han-*), Gr. *θέλω* (probably), *φένω*. The palatal and velar series cannot be distinguished in Greek; for the differences between them resort must be had to languages of the *satem*-group, such as Sanskrit, Zend or Slavonic, where the palatals appear as sibilants (see INDO-EUROPEAN LANGUAGES). The labio-velar series presents a great variety of forms in the different Greek dialects, and in the same dialect before different sounds. Thus in Attic before *o* vowels, nasals and liquids, the series appears as *τ*, *β*, *φ*; before *e* and *i* vowels as *τ*, *β*(*δ*), *θ*; in combination with *σ*, which led to loss of the *τ* by dissimilation, *ς*, *γ*, *χ*. Thus *ἔσσημα* corresponds to the Latin *sequo-r*, apart from the ending; *βόσ* to Latin *bos* (borrowed from Sabine), English *cow*; *φόνος* *σφαγή*, old Irish *gonim*, "I wound." Parallel to these forms with *β* are forms in the Italic languages except Latin and Faliscan, and in the Cymric group of the Celtic languages. The dental forms *τ*, *δ*, *θ* stand by themselves. Thus *τίς* (from the same root as *τοδ*, *τοδ*, *πόδ*, etc.) is parallel to the Latin *quis*, the Oscan *pit*, old Irish *cia*, Welsh *pyr*, "who?" "what?"; Attic *τίτρας*, Ionic *τίσσορες* "four" is parallel to Latin *quattuor*, Oscan *teroras*, old Irish *ceithir*, old Welsh *pegiar*; *τίσις* is from the same root as *τοσφ*. For the voiced sound, *β* is much more common than *δ* before *e* and *i* sounds; thus *βίος* "life," from the same root as Skt. *βhōas*, Latin *vīvus*; *βόσ* "boasting," Skt. *bhū*, &c. In Arcado-Cyprian and Aeolic, *τ* and *β* often precede *e* and *i* sounds. Thus parallel to Attic *τίτρας* Lesbian has *τίσσορες*, Homer *τίσσορες*, Boeotian *τίτταρες*; Thesalian *βίλλομα*, Boeotian *βίλλομα* alongside of Attic *βίλλομα*, Lesbian *βίλλομα*, Doric *βίλλομα* and also *βήλομα*. In Arcadian and Cyprian the form corresponding to *τίς* was *est*, in Thessalian *eu*, where the labialization was lost (see the article on Q).

A great variety of changes in the stopped consonants arose in combination with other sounds, especially *γ* (a semivowel of the nature of English *y*), *κ* (*w*) and *ς*; *τγ*, *κγ* became first *σγ* and later *σ* in Attic Greek, *ττ* in Boeotian (the precise pronunciation of *σγ* and *ττ* is uncertain): Attic *δ-στίος*, earlier *δ-στίος*, Boeotian *δ-στίος*, from the same stem as the Latin *quōs*, *quōtiens*; Homeric *μίσσος*, Attic *μίσος* from *μίσσος*, Latin *medius*; *στ*, *κτ* became *σ*, Attic *σττ*: *στέρνα* "pitch," Attic *στέρνα* from *στέρνα*, cp. Latin *pit*, *picis*, *δάσσαν*, Attic *δάσσαν* comparative to *δάσσει*. *κτ* and *κτ* became *γ*: *ζέλις* (Skt. *Dyāus*) *δαλίσις* from *δαλίσις*, stem *δαρίδ-hope*, *μαρίτις* from *μαρίτις*, stem *μαρίτις*, "lash."

(d) The sound *γ* was represented in the Greek alphabet by *ζ*, the "digamma," but in Attic and Ionic the sound was lost very early. In Aeolic, particularly Boeotian and Lesbian, it was persistent, and so also in many Doric dialects, especially at the beginning of words. When the Ionic alphabet was adopted by districts which had retained *ζ*, it was represented by *β*: *βήτορ* Aeolic for *βήτορ*, *β. βήτορ*. In Attic it disappeared, leaving no trace; in Ionic it lengthened the preceding syllable; thus in Homer *βρόδων* is scanned with *o* long because the root of the verb contained *β*: *βήτορ*. Attic has *βίσις*, but Ionic *βίσις* for *βήτορ*. Its combination with *τ* became *σ*. Attic and Boeotian *ττ*, in *τίσσορες*, *τίτταρες*, *τίτταρες* for I.E. *stigh-*.

But the most effective of all elements in changing the appearance of Greek words was the sound *σ*. Before vowels at the beginning, or between vowels in the middle of words, it passed into an *h* sound, the "rough breathing." Thus *ἄρᾱ* is the same word as the Latin *septem*, English *seven*; *ἄλ-ς* has the same stem as the Latin *sal*, English *sal-ς*; *ἄω* for *ἄω* is the same as the Latin *uro* ("eused"). Combined with *τ* or *κ* also it passes into *κ*: *ἄκω*, Skt. *śyūman*, "band"; *ἄβω*, Doric *ἄβω*, Latin *mad(d)is*, English *sweet*; cp. *ἄω* for *ἄω*, *ἄω*, Lesbian *ἄω* "temple," through *ἄω* from *ἄω*-*τ* connected with *ἄω* "dwell." Before nasals and liquids *σ* was assimilated: *μσ-δω*, Latin *mi-ru-s*, English *smile*; *ἄβω*, Latin *uivem*, English *stomach*; *ἄβω*, Latin *laxus*, English *slack*; *ἄω* from *ἄω*-*δ* of the same origin as English *straw* (where *τ* is a later insertion), imperfect *ἄβω* for *ἄω*; cp. also *ἄω*, *ἄω*, *ἄω*.

After nasals *σ* is assimilated except finally; when assimilated, in all dialects except Aeolic the previous syllable is lengthened if not already long: Attic *ἄω*, *ἄω* for the first aorist *ἄω*, *ἄω*; but *ἄω*, *ἄω*, &c., of the accusative pl. either remained or became in Aeolic *ἄω*, *ἄω*, in Ionic and Attic *ἄω*, *ἄω*, in Doric *ἄω*, *ἄω*; cp. *ἄω* for *ἄω*, *ἄω* for *ἄω*, *ἄω* "one" for *ἄω*, then by analogy of the neuter *ἄω*. Assimilation of *σ* to preceding *ρ* and *λ* is a matter of dialect: Ionic *ἄω*, but Attic *ἄω*, and so also the Doric of Thera: *ἄω*, but *ἄω* for *ἄω*. With nasals *σ* affected the previous syllable: *ἄω*, where *σ* is the nasal of the stem *ἄω*, itself forming a syllable (see the article N for these so-called sonant nasals). Before *τ* original *σ* becomes *τ*; hence *ἄω* with *σ*, though from the same root as English *come*. Original *σ* does not survive in Greek, but is represented by the aspirate at the beginning of words, *ἄω*=Skt. *śyūmas*; medially after consonants it disappears, affecting the preceding consonant or syllable where a consonant precedes; between vowels it disappears. A sound of the same kind is indicated in Cyprian and some other dialects as a glide or transition sound between two vowels.

(e) The most remarkable feature in the treatment of the nasals is that when *σ* or *μ* forms a syllable by itself its consonant character disappears altogether and it is represented by the vowel *α* only:

α, Latin *tentus*, *α-* negative particle, Latin *est*, English *as*; *α-ῥῶ* has the same prefix as the Latin *sim-plex* (sup). The liquids in similar cases show *λα* or *αλ* and *πα* or *απ*: *α-ῥῶ*, *α-ῥῶ*, *α-ῥῶ*; *ἄω*, *ἄω*, *ἄω*.

The ends of words were modified in appearance by the loss of all stop-consonants and the change of final *σ* to *α*, *ἄω*, Latin *stis*; *ἄω*, Latin *ingem*.

Accent.—The vowel system of Greek has been so well preserved because it shows till late times very little in the way of stress accent. As in early Sanskrit the accent was predominantly a pitch accent (see ACCENT).

Noun System.—The I.E. noun had three numbers, but the dual was limited to pairs, the two hands, the two horses in the chariot, and was so little in use that the original form of the oblique cases cannot be restored with certainty. Ionic has no dual. The I.E. noun had the following cases: Nominative, Accusative, Genitive, Ablative, Instrumental, Locative and Dative. The vocative was not properly a case, because it usually stands outside the syntactical construction of the sentence; when a distinctive form appears, it is the bare stem, and there is no form (separate from the nominative) for the plural. Greek has confused genitive and ablative (the distinction between them seems to have been derived from the pronouns), except for the solitary *τοῦ*=*αὐτοῦ* in an inscription of Delphi. The instrumental, locative and dative are mixed in one case, partly for phonetic, partly for syntactical reasons. In Arcadian, Elean, Boeotian, and later widely in N. Greece, the locative *-ου* is used for the dative. The masculine *σ*-stems make the nom. in most dialects in *-ου*. The genitive is in *-ου* (with *σ* borrowed from the *σ*-stems), which remains in Homer and Boeotian, appears in Arcado-Cyprian as *-ου*, and with metathesis of quantity *-ου* in Ionic. The Attic form in *-ου* is borrowed directly from the *σ*-stems. In the plural the *-α* and *-ου* stems follow the article in making their nominatives in *-αι* and *-ου* instead of the original *-αι* and *-ου*. The neuter plural was in origin a collective singular, and for this reason takes a singular verb; the plural of *ἄω* "yoke" was originally *ἄω*, and declined like any other *σ*-stem. But through the influence of the masculine and feminine forms the neuter took the same oblique cases, and like its own singular made the accusative the same as the nominative. In the plural of *-αι* and *-ου* stems, the locative in *-ου*, *-ου* was long kept apart from the instrumental-dative form in *-ου*, *-ου*.

The Verb System.—The verb system of Greek is more complete than that of any of the other I.E. languages. Its only rival, the early Vedic verb system, is already in decay when history begins, and when the classical period of Sanskrit arrives the moods have broken down, and the aorist, perfect, and imperfect tenses are syntactically confused. Throughout the Greek classical period the moods are maintained, but in the period of the *σ*-stem the optative occurs less and less and finally disappears. The original I.E. had two voices, an active and a middle, and to these Greek has added a third, the passive, distinguished from the middle in many verbs by separate forms for the future and aorist, made with a syllable *-θη*, *ἄω*, *ἄω*, though in this instance, *ἄω*, the future middle, is often used with a passive sense. Other forms which Greek has added to the original system are the pluperfect—in form a past of the perfect stem with aorist endings. It merely expressed the perfect action in past time, and, except as derived from the context, did not possess the notion of relative time (past at a time already past), which attaches to the Latin forms with the same name. The future optative was also a new formation, betraying its origin in the fact that it is almost entirely limited to *Ορατί* Obliqua. The aorist imperatives were also new; the history of some of them, as the second sing. act. *ἄω*, is not very clear. The whole verb system is affected by the distinction between *-αι* and *-ου* verbs; the former or thematic verbs have a so-called "thematic vowel" between the root and the personal suffix, while the *-ου* verbs attach the suffixes directly to the root. The distinction is really one between monosyllabic and disyllabic roots. The history of the personal endings is not altogether clear; the *-αι* verbs have in the present forms for the 2nd and 3rd person in *-αι* and *-ου*, which are not yet elucidated. In the middle, Greek does not entirely agree with Sanskrit in its personal endings, and the original forms cannot all be restored with certainty. The endings of the primary tenses differed from those of the secondary, but there has been a certain amount of confusion between them.

The syntax of the verb is founded on the original I.E. distinction of the verb forms, not by time (tense), but by forms of action, progressive action (present and imperfect), consummated action (aorist), abate arising from action, emphatic or repeated action (perfect). For the details of this see INDO-EUROPEAN LANGUAGES.

BIBLIOGRAPHY.—(1.) A grammar of Greek, which will deal fully with the whole material of the language, is at present a desideratum, and is hardly possible so long as new dialect material is being constantly added and while comparatively so little has been done on the syntax of the dialects. The greatest collection of material is to be found in the new edition of Kühner's *Griechische Grammatik*, *Lesb. und Formeln*, by Blass (2 vols., 1890-1892); *Syntax*, by Geuth (2 vols., 1896, 1900). Blass's part is useful only for the explanations being entirely antiquated. The only full historical account of the language (sounds, forms and syntax) at present in existence is K. Brugmann's *Griechische Grammatik* (3rd ed., 1900),

Gustav Meyer's *Griechische Grammatik* (nothing on accent or syntax), which did excellent pioneer work when it first appeared in 1880, was hardly brought up to date in its 3rd edition (1895), but is still useful for the dialect and bibliographical material collected. See also H. Hirt, *Handbuch der griech. Laut- und Formenlehre* (1902). Of smaller grammars in English perhaps the most complete is that of J. Thompson (London, 1902). The grammar of Homer was handled by D. B. Monro (2nd ed., Oxford, 1891). The syntax has been treated in many special works, amongst which may be mentioned W. W. Goodwin, *Syntax of the Greek Moods and Tenses* (new ed., 1889); B. L. Gildersleeve and C. W. E. Miller, *Syntax of Classical Greek from Homer to Demosthenes*, pt. i. (New York, 1901— and following); J. M. Stahl, *Kritisch-historische Syntax des griechischen Verbums* (1907); F. E. Thompson, *Attic Greek Syntax* (1907). (ii.) The relations between Greek and the other I.E. languages are very well brought out in P. Kretschmer's *Einleitung in die Geschichte der griechischen Sprache* (Göttingen, 1896). For comparative grammar see K. Brugmann and B. Delbrück, *Grundriss der vergleichenden Grammatik der indogermanischen Sprachen* (the 2nd ed., begun 1897, is still incomplete) and Brugmann's *Kurze vergleichende Grammatik* (1902-1903); A. Meillet, *Introduction à l'étude comparative des langues indo-européennes* (2nd ed. 1908). Greek compared with Latin and English: P. Giles, *A Short Manual of Comparative Philology for Classical Students* (2nd ed., 1907, with an appendix containing a brief account and specimens of the dialects); Riemann and Goelzer, *Grammaire comparative du Grec et du Latin* (1901), a parallel grammar in 2 vols., specially valuable for syntax. (iii.) For the dialects two works have recently appeared, both covering in brief space the whole field: A. Thumb, *Handbuch der griechischen Dialekte* (with bibliographies for each dialect, 1909); C. D. Buck, *Introduction to the Study of the Greek Dialects, Grammar, Selected Inscriptions, Glossary* (Boston, 1910). Works on a larger scale have been undertaken by R. Meister, by O. Hoffmann and by H. W. Smyth. For the *κοινή* may be specially mentioned A. Thumb, *Die griech. Sprache in Zeitalter des Hellenismus* (1901); E. Mayser, *Grammatik der griechischen Papyri aus der Ptolemäerzeit: Laut- und Wortlehre* (1906); H. St. J. Thackeray, *A Grammar of the Old Testament in Greek*, vol. i. (1909); Blass, *Grammar of New Testament Greek*, trans. by Thackeray (1898); J. H. Moulton, *A Grammar of New Testament Greek. I. Prolegomena* (3rd ed., 1906). (iv.) For the development from the *κοινή* to modern Greek: A. N. Jannaris, *An Historical Greek Grammar, chiefly of the Attic Dialect, as written or spoken from Classical Antiquity down to the Present Time* (1901); C. N. Hatzidakis, *Einleitung in die neuere griechische Grammatik* (1892); A. Thumb, *Handbuch der neuere griechischen Volkssprache* (2nd ed. 1910). (v.) The inscriptions are collected in *Inscriptiones Graecae* in the course of publication by the Berlin Academy, those important for dialect in the *Sammlung der griech. Dialektinschriften*, edited by Collitz and Bechtel. The earlier parts of this collection are to some extent superseded by later volumes of the *Inscr. Graecae*, containing better readings and new inscriptions. A good selection (too brief) is Solmsen's *Inscriptiones Graecae ad illustrandam dialectos selectae* (3rd ed., 1910). A serviceable lexicon for dialect words is van Herwerden's *Lexicon Graecum supplementum ad dialecticum* (2nd ed., much enlarged, 2 vols. 1910). (vi.) The historical basis for the distribution of the Greek dialects is discussed at length in the histories of E. Meyer (*Geschichte des Altertums*, ii.) and G. Busolt (*Griechische Geschichte*, i.); by Professor Ridgway, *Early Age of Greece*, i. (1901), and P. Kretschmer in *Glotta*, i. 9 ff. See also A. Fick, *Die vorgriechischen Ortsnamen* (1905). (vii.) Bibliographies containing the new publications on Greek, with some account of their contents, appear from time to time in *Indogermanische Forschungen: Anzeiger* (Strassburg: Trübner), annually in *Glotta* (Göttingen, Vandenhoeck und Ruprecht), and *The Year's Work in Classical Studies* (London, Murray). (P. G.)

GREEK LAW. Ancient Greek law is a branch of comparative jurisprudence the importance of which has been long ignored. Jurists have commonly left its study to scholars, who have generally refrained from comparing the institutions of the Greeks with those of other nations. Greek law has, however, been partially compared with Roman law, and has been incidentally illustrated with the aid of the primitive institutions of the Germanic nations. It may now be studied in its earlier stages in the laws of Gortyn; its influence may be traced in legal documents preserved in Egyptian papyri; and it may be recognized as a consistent whole in its ultimate relations to Roman law in the eastern provinces of the Roman empire.

The existence of certain panhellenic principles of law is implied by the custom of settling a difference between two Greek states, or between members of a single state, by resorting to external arbitration. The general unity of Greek law is mainly to be seen in the laws of inheritance and adoption, in laws of commerce and contract, and in the publicity uniformly given to legal agreements.

No systematic collection of Greek laws has come down to us. Our knowledge of some of the earliest notions of the subject is derived from the Homeric poems. For the details of Attic law we have to depend on *ex parte* statements in the speeches of the Attic orators, and we are sometimes enabled to check those statements by the trustworthy, but often imperfect, aid of inscriptions. Incidental illustrations of the laws of Athens may be found in the *Laws* of Plato, who deals with the theory of the subject without exercising any influence on actual practice. The *Laws* of Plato are criticized in the *Politics* of Aristotle, who, besides discussing laws in their relation to constitutions, reviews the work of certain early Greek lawgivers. The treatise on the *Constitution of Athens* includes an account of the jurisdiction of the various public officials and of the machinery of the law courts, and thus enables us to dispense with the second-hand testimony of grammarians and scholiasts who derived their information from that treatise (see CONSTITUTION OF ATHENS). The works of Theophrastus *On the Laws*, which included a recapitulation of the laws of various barbaric as well as Grecian states, are now represented by only a few fragments (Nos. 97-106, ed. Wimmer).

Our earliest evidence is to be sought in the Homeric poems. In the primitive society of the heroic age (as noticed by Plato) written laws were necessarily unknown; for, "in that early period, they had no letters; they lived by habit and by the customs of their ancestors" (*Laws*, 680 a). We find a survival from a still more primitive time in the savage Cyclops, who is "unfamiliar with dooms of law, or rules of right" (*ὄβρη δίκας ἐδ' ἐλόβρα ὄβρη θεμιστας*, *Od.* ix. 215 and 212 f.).

Dikē (*δική*), assigned by Curtius (*Elym.* 134) to the same root as *telereus*, primarily means a "way pointed out," a "course prescribed by usage," hence "way" or "fashion," "manner" or "precedent." In the Homeric poems it sometimes signifies a "doom" of law, a legal "right," a "lawsuit"; while it is rarely synonymous with "justice," as in *Od.* xiv. 84, where "the gods honour justice," *ἵκεται δίκην*.

Various senses of "right" are expressed in the same poems by *themis* (*θέμις*), a term assigned (*ib.* 254) to the same root as *ritus*. In its primary sense *themis* is that which "has been laid down"; hence a particular decision or "doom." The plural *themistes* implies a body of such precedents, "rules of right," which the king receives from Zeus with his sceptre (*Il.* ix. 99). *Themis* and *dikē* have sometimes been compared with the Roman *fas* and *ius* respectively, the former being regarded as of divine, the latter of human origin; and this is more satisfactory than the latest view (that of Hirtzel), which makes "counsel" the primary meaning of *themis*.

Themis (*θεμίστη*), an ordinance (from the same root as *themis*), is not found in "Homer," except in the last line of the original form of the *Odyssey* (xiii. 296), where it probably refers to the "ordinance" of wedlock. The common term for law, *nomos*, is first found in Hesiod, but not in a specially legal sense (e.g. *Op.* 276).

A trial for homicide is one of the scenes represented on the shield of Achilles (*Il.* xviii. 497-508). The folk are here to be seen thronging the market-place, where a strife has arisen between two men as to the price of a man that has been slain. The slayer vows that he has paid all (*εὐχέρο πάντ' ἀποδοῦναι*), the kinsman of the slain protests that he has received nothing (*ἀναίετρο μὴδὲν Διόσθεα*); both are eager to join issue before an umpire, and both are favoured by their friends among the folk, who are kept back by the heralds. The cause is tried by the elders, who are seated on polished stones in a sacred circle, and in the midst thereof lie two talents of gold, "to give to him who, among them all, sets forth the cause most rightly" (*τὴν δὲ δίκην ὅς μετὰ τοῖσιν δίκην ὕμνεται εἶναι*).

The discussions of the above passage have chiefly turned on two points: (1) the legal questions at issue; and (2) the destination of the "two talents." (1) In the ordinary view (a), it is solely a question whether the fine or blood-money, corresponding to the *Wergeld* (see WERGELD, TRUTONIC PEOPLES, BRITAIN: Anglo Saxons) of the old Germanic law (Grimm, *Rechtswörterbuch*, 661 f.), has been paid or not. (This is accepted by Thonissen, Lipsius, Sidgwick and Ridgway.) In the other view (b), it is held that the slayer "claimed to pay" the fine, and the kinsman of the slain "refused to accept any compensation" (so Passow and Leaf, approved by Pollock). (2) The "two talents" (shown by Ridgway to be a small sum, equal in

Original authorities.

Law in Homer.

Dikē.

Themis.

Themis.

The trial scene.

value to two oxen) are awarded either (a) to the litigant who "pleads his cause most justly before them" (so Thonissen, Shilleto and Lipsius, in accordance with the Attic use of phrases like *κλέω δίκην*), or (b) to the judge "who, among all the elders, gives the most righteous judgment" (so Maine, approved by Sidgwick, Pollock, Leaf and Ridgeway).

On this controversy, cf. Maine's *Ancient Law*, chap. x. pp. 385 f., 405 f., ed. Pollock; Thonissen, *Droit pénal* (1875), 27; F. M. Laurence (on Shilleto's view) in *Journal of Philology*, viii. (1879), 125 f.; Ridgeway, *ib. x.* (1882), 30 f., and *Journal of Hellenic Studies*, viii. (1887), 133 f.; and Leaf, *ib. viii.* 122 f., and in his *Commentary on *Iliad**, ii. (1902), 610-614; also J. H. Lipsius in *Leipziger Studien*, xiii. (1890), 225-231, criticized by H. Sidgwick in *Classical Review*, viii. (1894), 1-4.

We are told elsewhere in Homer that sometimes a man accepted blood-money from the slayer of his brother or his son, and that the slayer remained in the land after paying this penalty (*Il.* ix. 633). As a rule the slayer found it safest to flee (*Od.* xxiii. 118 f.), but even so, he might be pursued by the friends of the slain (*Od.* xv. 272-278). If he remained, the land was not (as in later ages) deemed to be polluted by his presence. In Homer, Orestes does not slay Clytemnestra, and he needs no "purification" for slaying Agisthus.

The laws of Sparta are ascribed to the legislation of Lycurgus, whose traditional date is 884 B.C. Written laws are said to have been expressly forbidden by Lycurgus (Plutarch, *Lycurgus at Sparta*, 13); hence the "laws of Sparta" are simply a body of traditional observances. We learn that all trials for homicide came before the Council of Elders and lasted for several days, and that all civil causes were tried by the ephors (q.v.). We are also told that originally the land was equally divided among the citizens of Sparta, and that this equality was enforced by law (Polybius vi. 45-46). Early in the 4th century the ephor Epitadeus, owing to a disagreement with his son, enacted that every Spartan should be allowed to transfer his estate and his allotment to any other person (Plutarch, *Agis*, 5), while Aristotle, in a much-debated passage of the *Politics* (ii. 9. 14-15), criticizes the Spartan constitution for allowing the accumulation of property in a few hands, an evil aggravated by the large number of "heiresses"; "a man (he adds) may bestow his heiress on any one he pleases; and, if he dies intestate, this privilege descends to his heir."

Law was first reduced to writing in the 7th century B.C. A written code is a necessary condition of just judgment, and such a code was the first concession which the people in the Greek cities extorted from the ruling aristocracies. The change was generally effected with the aid of a single legislator entrusted with complete authority to draw up a code.

The first communities to reach this stage of progress were the Greek colonies in the West. The Epizephyrian Locrians, near the extreme south of Italy, received the earliest written code from Zaleucus (663 B.C.), whose strict and severe legislation put an end to a period of strife and confusion, though we know little of his laws, except that they attached definite penalties to each offence, and that they strictly protected the rights of property. Two centuries later, his code was adopted even by the Athenian colony of Thurii in south Italy (443 B.C.). Charondas, the "disciple" of Zaleucus, became the lawgiver, not only of his native town of Catana on the east coast of Sicily, but also of other Chalcidian colonies in Sicily and Italy. The laws of Charondas were marked by a singular precision, but there was nothing (says Aristotle) that he could claim as his own except the special procedure against false witnesses (*Politics*, ii. 12. 11).

In the case of judges who neglected to serve in the law courts, he inflicted a large fine on the rich and a small fine on the poor (*ib.* vi. (iv.) 13. 2). Androdamos of Rhegium gave laws on homicide and on heiresses to the Chalcidians of Thrace, while Philolaus of Corinth provided the Thebans with "laws of adoption" with a view to preventing any change in the number of the allotments of land (*ib.* ii. 12. 8-14).

Local legislation in Crete is represented by the laws of the important city of Gortyn, which lies to the south of Ida in a plain watered by the Lethæus. Part of that stream forms a sluice for a water-mill, and at or near this mill some fragmentary inscriptions were found by French archaeologists in 1857 and 1879. The great inscription, to which most of our knowledge of the laws is due, was not discovered until 1884. It had been preserved on a wall 27 ft. long and 5 ft. high, the larger part of which was buried in the ground, while its farthest extremity passed obliquely athwart the bed of the mill-stream. It was necessary to divert the water before the last four columns could be transcribed by the Italian scholar, Federico Halbherr, whose work was completed in the same year by the excavation and transcription of the first eight columns by the German scholar, E. Fabricius. In the following year Halbherr discovered more than eighty small fragments on the neighbouring site of a former temple of the Pythian Apollo.

These fragments, which are far earlier than the great inscription above-mentioned, have been assigned to about 650 B.C. They precede the introduction of coined money into Crete, the penalties being reckoned, not in coins, but in caldrons. They deal with the powers of the magistrates and the observances of religion, but are mainly concerned with private matters of barter and sale, dowry and adoption, inheritance and succession, fines for trespass and questions of blood-money. As in the code of Zaleucus, we have a fixed scale of penalties, including the fine of a single tripod, and ranging from one to a hundred caldrons.

The great inscription is perhaps two centuries later (c. 450 B.C.). It consists of a number of amendments or additions to an earlier code, and it deals exclusively with private law, in which the family and family property occupy the largest part. The procedure is entirely oral; oaths and other oral testimony are alone admitted; there are no documentary proofs, and no record of the verdict except in the memory of the judge or of his "remembrancer." All the causes are tried before a single judge, who varies according to the nature of the suit. Where the law specially enjoins it, he is bound to give judgment (*δικάζειν*) in accordance with the law and the "witnesses or oaths," but, in other cases, he is permitted to take oath and decide (*επιδικάζει*) in view of "the contentions of the parties," as distinguished from "the declarations of the witnesses." Offences against the person are treated as matters of private compensation according to a carefully graduated tariff. In certain cases the defendant may clear himself by an "oath of purgation" with the support of "cojurors" (*συμωδοί*), the *Eidshelfer* of old German law (Grimm 859 f.), who have no necessary knowledge of the facts. There is no interference with the exposure of infants, except in the interest of the father (if the child is free-born) or of the lord (in the case of serfs). The law of debt is primitive, though less severe than that of the early Romans. In contrast with these primitive elements we have others which are distinctly progressive. The estates of husband, wife and sons are regarded as absolutely distinct. Wills are unknown, even in their most restricted form. Elaborate provisions are made to secure with all speed the marriage of an "heiress"; she is bound to marry the eldest of her paternal uncles or to surrender part of her estate, and it is only if there are no paternal uncles that she is permitted to marry one (and that the eldest) of their sons. Adoption is made by the simple procedure of mounting a block of stone in the market-place and making a public announcement at a time when the citizens are assembled. The adopted son does not inherit any larger share than that of a daughter. Any one who desires to repudiate his adopted son makes a public announcement as before, and the person repudiated receives, by way of nominal compensation, the gift of a small number of staters. In these later "laws of Gortyna" we have reached the time when payments are made, not in "caldrons," but in coins. In the inscription itself the laws are simply described as "these writings."

The text of the great inscription was first published by E. Fabricius in *Ath. Mitt.* ix. (1885), 362-384; there is a cast of the whole in the Cambridge Museum of Classical Archaeology. Cf. Comparetti's *Leggi di Gortyna* (1893); Bücheler and Zittelmann in *Rhein. Mus.* xl. (1885); Dareste, Haussoullier and Th. Reinach, *Inscr. juridiques grecques*, iii. (1894), 352-493 (with the literature there quoted). Eng. trans. by Roby in *Law Quarterly Review* (1886), 135-152; see also E. S. Roberts, *Gk. Epigraphy*, i. 39 f., 52 f., 325-332; J. W. Headlam in *Journal of Hellenic Studies*, xiii. (1892-1893), 48-69; P. Gardner and F. B. Jevons, *Greek Antiquities* (1895), 560-574; W. Wyse in Whibley's *Companion to Greek Studies* (1905), 378-383; and Hermann Lipsius, *Zum Recht von Gortyna* (Leipzig, 1909).

A Roman writer ascribes to the Athenians the very invention of lawsuits (Aelian, *Var. Hist.* iii. 38), and the Athenians themselves regarded their tribunals of homicide as institutions of immemorial antiquity (Laoc. *Paneg.* 40).

The laws of Gortyna.

Greek law-givers: Lycurgus at Sparta.

Era of written laws.

Zaleucus at Locri Epizephyria.

Charondas at Catana, etc.

Androdamos of Rhegium.

Philolaus of Corinth.

Athens.

On the abolition of the single decennial archon¹ in 683 B.C., his duties were distributed over several officials holding office for one year only. The judicial duties thenceforth discharged by the chief archon (*ho archon*), in the case of citizens, were discharged by the polemarch in the case of foreign settlers or metics (*metrouoi*); while the king-archon, who succeeded to the religious functions of the ancient kings, decided cases connected with religious observances (see ARCHON). He also presided over the primitive council of the state, which was identical with the council of the Areopagus. It was possibly with a view to the recognition of the rights of the lower classes that, about the middle of the 7th century B.C., the three archons were raised to the number of nine by the institution of the joint board of the six *thesmothetai*, who superintended the judicial system in general, kept a record of all legal decisions, and drew attention to any defects in the laws. It is probable that in their title we have the earliest example in Attic Greek of the use of *thesmos* in the sense of "law."

The constitution was at this time thoroughly oligarchical. With a view, however, to providing a remedy for the conflict between the several orders of the state, the first code of Athenian law was drawn up and published by Draco (strictly Dracon), who is definitely described as a *thesmochetes* (621). His laws were known as *thesmoi*. The distinctive part of his legislation was the law of homicide, which was held in such high esteem that it was left unaltered in the legislation of Solon and in the democratic restoration of 411 B.C. It is partly preserved in an inscription of 400, which has been restored with the aid of quotations from the orators (*C.I.A.* i. 61; *Inscr. jurid. grecques*, ii. t. 1-24; and Hicks, *Gk. Hist. Inscr.* No. 59). It drew a careful distinction between different kinds of homicide. Of the rest of Draco's legislation we only know that Aristotle (*Politics*, ii. 12, 13) was struck by the severity of the penalties, and that the creditor was permitted to seize the person of the debtor as security for his debt.

The conflict of the orders was not allayed until both parties agreed in choosing Solon as mediator and as archon (594 B.C.).

Solon cancelled all mortgages and debts secured on the person of the debtor, set free all who had become slaves for debt, and forbade such slavery for the future (see SOLON). Thenceforth every citizen had also "the right of appeal to the law-courts," and the privilege of claiming legal satisfaction on behalf of any one who was wronged. Cases of constitutional law (*inter alia*) came before large law-courts numbering hundreds of jurors, and the power of voting in these law-courts made the people masters of the constitution (Aristotle's *Constitution of Athens*, c. 9). Solon's legislation also had an important effect on the law of property. In primitive times, on a man's death, his money or lands remained in the family, and, even in the absence of direct descendants, the owner could not dispose of his property by will. Permission to execute a will was first given to Athenian citizens by the laws of Solon. But "the Athenian Will was only an inchoate Testament" (Maine's *Ancient Law*, c. vi.); for this permission was expressly limited to those citizens who had no direct male descendants (Dem. *Lept.* 102; Plutarch, *Solon*, 21; cf. *Wyle on Isæus*, p. 325).

The law of intestate succession is imperfectly preserved in [Dem.] 43, § 51 (cf. *Wyle*, *ib.* p. 562 f.). In the absence of direct male descendants, a daughter who survived her father was known as an *epikleros*, not an "heiress," but a "person who went with the estate"; and, in the absence of a will, the right or duty of marrying the daughter followed (with certain obvious exceptions) the same rules as the right of succession to the estate (cf. *Wyle*, *ib.* p. 348 f.).

Among the reforms of Cleisthenes (508) was the law of ostracism (*g.n.*). The privileges of the Areopagus were curtailed (while its right to try certain cases of homicide was left untouched) by the reforms of Ephialtes (462),

¹ For further information as to the evolution of the Athenian constitution see ARCHON, AREOPAGUS, BOULÉ, ECCLESIA, STRATEGUS, and articles on all the chief legislators.

and of Pericles, who also restored the thirty "local justicæ" (453), limited the franchise to those of citizen-blood by both parents (451), and was the first to assign to jurors a fee for their services in the law-courts, which was raised to three obols by Cleon (425).

In contrast to legislative reforms brought about by lawgivers entrusted with special authority, such as Draco, Solon and Cleisthenes, there was the regular and normal course of public legislation. The legislative power was not exercised directly by the popular assembly (see ECCLESIA), but the preliminary consent of that body was necessary for the appointment of a legislative commission.

In the 5th century (e.g. in 450 and 446 B.C.) certain commissioners called *συγγραφεῖς* were appointed to draw up laws which, after approval by the council, were submitted to the assembly. The same term was still in use in March 411 (Thuc. viii. 61). But in October, on the overthrow of the Four Hundred, the commissioners are for the first time called *νομοθεταί* (*ib.* 97).

The procedure in ordinary legislation was as follows. At the first meeting of the assembly in the year, the people was asked whether it would permit motions to be made for altering or supplementing the existing laws. A debate ensued, and, if such permission were granted, any citizen who wished to make a motion to the above effect was required to publish his proposals in the market-place, and to hand them to the secretary of the council (Boulé) to be read aloud at more than one meeting of the assembly. At the third regular meeting the people appointed the legislative commissioners, who were drawn by lot from the whole number of those then qualified to act as jurors. The number, and the duration of the commission, were determined in each case by the people. The proceedings before the commission were conducted exactly in the manner of a lawsuit. Those who desired to see old laws repealed, altered or replaced by new laws came forward as *accusers* of those laws; those of the contrary opinion, as *defenders*; and the defence was formally entrusted to public advocates specially appointed for the purpose (*συγγράμναι*). The number of the commissioners varied with the number or importance of the laws in question; there is evidence for the number 1001 (Dem. xxiv. 27). If a law approved by the commission was deemed to be unconstitutional, the proposer was liable to be prosecuted (by a *γραφὴ παρανόμων*), just as in the case of the proposer of an unconstitutional decree in the public assembly. Formal proceedings might also be instituted against laws on the sole ground of their inexpediency (see note on Aristotle's *Constitution of Athens*, p. 219, ed. Sandys). A prosecutor who (like Aeschines in his indictment of Ctesiphon) failed to obtain one-fifth of the votes was fined 1000 *drachmae* (440), and lost the right to adopt this procedure in future. When a year had elapsed, the proposer of a law or a decree was free from personal responsibility. This was the case with Leptines, but the law itself could still be attacked, and, in this event, five advocates were appointed to defend it (*σίνδοι*), cf. Dem. *Lept.* 144, 146.

Limits of space make it impossible to include in the present article any survey of the purport of the extant remains of the laws of Athens. Such a survey would begin with the laws of the family, including laws of marriage, adoption and inheritance, followed by the law of property and contracts, and the laws for the protection of life, the protection of the person, and the protection of the constitution. The texts have been collected and classified in Tély's *Corpus juris Attici* (1867), a work which can be supplemented or corrected with the aid of Aristotle's *Constitution of Athens*; while some of the recent expositions of the subject are mentioned in the bibliography at the end of this article. We now proceed to notice the law of homicide, but solely in connexion with jurisdiction.

The general term for a tribunal is *δικαστήριον* (from *δικάω*), Anglicized "dicastery." Of all the tribunals of Athens those for the trial of homicide were at once the most primitive and the least liable to suffer change through lapse of time. In the old Germanic law all trials whatsoever were held in the open air (Grimm 793 f.). At Athens this custom was characteristic of all the five primitive courts of homicide, the object being to prevent the prosecutor and the judges from coming under the same roof as one who was charged with the shedding of blood (Antiphon, *De caede Herodis*, 11). The place where the trial was held depended on the nature of the charge.

Pericles
Cleon.

Ordinary
course of
legisla-
tion.

Syn-
graphists.
Nomo-
thetai.

The laws
of Athens.

Jurisdic-
tion; the
five primi-
tive tri-
bunals for
the trial of
homicide.

Cleis-
thenes,
Ephialtes.

1. The rock of the Acropolis, outside the earliest of the city-walls, was the proper place for the trial of persons charged with premeditated homicide, or with wounding with intent to kill. **On the Areopagus.** The penalty for the former crime was death; for the latter exile; and, in either case, the property was confiscated. If the votes were equal, the person accused was acquitted. The proceedings lasted for three days, and each side might make two speeches. After the first speech the person accused of premeditated homicide was mercifully permitted to go into exile, in which case his property was confiscated, and in the ordinary course he remained in exile for the rest of his life.

2. Charges of unpremeditated homicide, or of instigating another to inflict bodily harm on a third person, or of killing a slave or a resident alien or a foreigner, were tried at the Palladion, the ancient shrine of Pallas, east of the city-walls. **At the Palladion.** The punishment for unpremeditated homicide was exile (without confiscation) until such time as the criminal had propitiated the relatives of the person slain, or (failing that) for some definite time. The punishment for instigating a crime was the same as for actually committing it.

3. Trials at the Delphinion, the shrine of Apollo Delphinios, in the same quarter, were reserved for special cases of either accidental or justifiable homicide.

4. If a man already in exile for unpremeditated homicide were accused of premeditated homicide, or of wounding with intent to kill, provision was made for this rare contingency by permitting him to approach the shore of Attica and conduct his defence on board a boat, while his judges heard the cause on shore, at a "place of pits" called Phreatto, near the harbour of Zea. If the accused were found guilty, he incurred the proper penalty; if acquitted, he remained in exile.

5. The court in the precincts of the Prytaneum, to the north of the Acropolis, was only of ceremonial importance. It "solemnly heard and condemned undiscovered murderers, and animals or inanimate objects that had caused the loss of life."¹

The writ ran "against the doer of the deed," and any instrument of death that was found guilty was thrown across the frontier. The trial was held by the four "tribe-kings" (*φολοβασιλῆες*), an archaic survival from before the time of Cleisthenes. (On these five courts see Aristotle's *Constitution of Athens*, c. 57, and Dem. *Aristocr.* 65-79.)

In all the courts of homicide the president was the archon-basileus, or king-archon, who on these occasions laid aside his crown. Originally all these courts were under the jurisdiction of the *ephetæ*, an ancient body of judges called the *ephetæ* (*ἐφεταί*), whose institution was ascribed to Draco. The transfer of the first of the above courts to the council of the Areopagus is attributed to Solon. In practice the jurisdiction of the *ephetæ* (see also AREOPAGUS) was probably confined to the courts at the Palladion and Delphinion; but even there the rights of this primitive body became obsolete, for trials "at the Palladion" sometimes came before an ordinary tribunal of 500 or 700 jurors (Isocr. c. *Callim.* 52, 54; [Dem.] c. *Næeram*, 10).

Except in the case of the primitive courts of homicide, the right of jurisdiction was entrusted to the several archons until the date of Solon (594). When the direct jurisdiction of the archons was impaired by Solon's institution

The presidents of the tribunals. of the "right of appeal to the law-courts," the dignity of those officials was recognized by their having the privilege of presiding over the new tribunals (*ἡγεμονία δικαστηρίου*). A similar position was assigned to the other executive officers, such as the strategi (generals), the board of police called the "Eleven," and the financial officers, all of whom presided over cases connected with their respective departments. In their new position as presidents of the several courts, the archons received

The chief archon. complaints, obtained from both parties the evidence which they proposed to present, formally presided at the trial, and gave instructions for the execution of the sentence. The choice of the presiding magistrate in each case was determined by the normal duties of his office. Thus the chief archon, the official guardian of orphans and widows, presided in all cases, public or private, connected with the family property of citizens (Aristotle, *U.S.* c. 56). The king-archon had charge of all offences against religion, e.g. indictments for impiety, disputes within the family as to the right to hold a particular priesthood, and all actions for homicide (c. 57). The third

The king-archon.

The polemarch.

The strateg.

archon, the polemarch, discharged in relation to resident aliens all such legal duties as were discharged by the chief archon in relation to citizens (c. 58). The trial of military offences was under the presidency of the strategi, who were assisted by the other military officers in preparing the case for the court. The six junior archons, the *thesmochetai*, acted as a board which was responsible for all cases not specially assigned to any other officials (details in c. 59).

The Forty, who were appointed by lot, four for each of the ten tribes, acted as sole judges in petty cases where the damages claimed did not exceed ten *drachmae*. Claims beyond that amount they handed over to the arbitrators. **The Forty.**

The four representatives of any given tribe received notice of such claims brought against members of that tribe. It seems probable that they dealt with all private suits not otherwise assigned, but, unlike the archons, they did not prepare any case for the court but referred it, in the first instance, to a public arbitrator appointed by lot (c. 53).²

The public arbitrators (*διαιτητα*) were a body including all Athenian citizens in the sixtieth year of their age. The arbitrator, on receiving the case from the four representatives of the Forty, first endeavoured to bring the parties to an agreement. If this failed, he heard the evidence and gave a decision. If the decision were accepted, the case was at an end, but, if either of the two parties insisted on appealing to a law-court, the arbitrator placed in two caskets (one for each party) copies of all the depositions, oaths and challenges, and of all the laws quoted in the case, sealed them up, and, after attaching a copy of his own decision, handed them over to the four representatives of the Forty, who brought the case into court and presided over the trial. Documents which had not been brought before the arbitrator could not be produced in court. The court consisted of 201 jurors where the sum in question was not more than 1000 *drachmae* (440); in other cases the number of jurors was 401 (c. 53).

A small board of five appointed by lot, one for each pair of tribes, and known as the "introducers" (*εἰσαγωγῆς*), brought up certain of the cases that had to be decided within a month (*ἐμπαροὶ δίκαι*), such as actions for restitution of dowry, repayment of capital for setting up a business, and cases connected with banking. **The public arbitrators.**

The largest and most important of the legal tribunals, the "dicastery" (*par excellence*), was known as the *heliaca*. The name, which is of uncertain origin,³ denotes not only the place where the court was held but also the members of the court,—the *heliastæ* of Aristophanes, the *dicastæ*, or *ἑλιδῆς δικασταί*, of the Attic orators. During the palmy days of the Athenian democracy, in the interval between the Persian and the Peloponnesian wars, the total number liable to serve as jurors is said to have been 6000 (Aristotle, *U.S.* c. 24, 3), and this number was never exceeded (Aristoph. *Vesp.* 661 f.). Any Athenian citizen in full possession of his rights, and over thirty years of age, was entitled to be placed on the list (Aristotle, *U.S.* c. 63, 3). At the beginning of the year the whole body of jurors assembled on the hill of Ardettos looking down on the Panathenaic Stadium, and there took a solemn oath to the effect that they would judge according to the laws and decrees of the Athenian people and of the council of the Five Hundred (Boule), and that, in cases where there were no laws, they would decide to the best of their judgment; that they would hear both sides impartially, and vote on the case actually before the court.

It has been suggested that, as the normal number of a court was 500, the maximum number of 6000 jurors was probably divided into ten sections of 500 each, with 1000 reserves. There is evidence in the 4th century for courts of 200, 400, 500, 700 and

Heliaca.

Heliastæ.

Dicastæ.

² Cf. R. J. Bonner, in *Classical Philology* (Chicago, 1907), 407-418, who urges that only cases belonging to the Forty were subject to public arbitration.

³ Connected either with *ἑλιδῆς*, "to assemble," or *ἥλιος*, or *ἥλιος* (cf. Curt Wachsmuth, *Stadt Athen*, ii. (1) 359-364). The first is possibly right (cf. Rogers on Aristoph. *Wasps*, viii. 1.); the second implies that this large court was held in the open air (Lipsius, *Alt. Recht*, 172).

(In important political trials) various multiples of 500, namely, 1000, 1500, 2000 or 2500. To some of these numbers one juror is added; it was probably added to all, to obviate the risk of the votes being exactly equal.

The evidence as to the organization of the jurors in the early part of the 4th century is imperfect. Passages in Aristophanes (*Ecclesiazusae*, 682-688; *Plutus*, 1166 f.) imply that in 392-388 B.C. the total number was divided into ten sections distinguished by the first ten letters of the Greek alphabet, A to K. Every juror, on his first appointment, received a ticket of boxwood (or of bronze) bearing his name with that of his father and his deme, and with one of the above letters in the upper left-hand corner. Of the bronze tickets many have been found (see notes on Aristotle's *Constitution of Athens*, c. 63, and fig. 1 in frontispiece, ed. Sandys). These tickets formed part of the machinery for allotting the jurors to the several courts. To guard against the possibility of bribery or other undue influence, the allotment did not take place until immediately before the hearing of the case. Each court contained an equal number of jurors from each of the ten tribes, and thus represented the whole body of the state. The juror, on entering the court assigned him, received a counter (see fig. 3 in frontispiece, *u.s.*), on presenting which at the end of the day he received his fee. The machinery for carrying out the above arrangements is minutely described at the end of Aristotle's *Constitution of Athens* (for details, cf. Gilbert, 397-399, Eng. trans., or Wyse in Whibley's *Companion to Greek Studies*, 387 f.).

The law-courts gradually superseded most of the ancient judicial functions of the council and the assembly, but the council continued to hold a strict scrutiny (*δοκιμασία*) of candidates for office or for other privileges, while the council itself, as well as all other officials, had to give account (*εἰθύνα*) on ceasing to hold office. The council also retained the right to deal with extraordinary crimes against the state. It was open to any citizen to bring such crimes to the knowledge of the council in writing. The technical term for this information, denunciation or impeachment was *eisangelia* (*εἰσαγγελία*).

The council could inflict a fine of 500 *drachmae* (L20), or, in important cases, refer the matter either to a law-court, as in the trial of Antiphon (Thuc. viii. 68), or to the ecclesia, as in that of Alcibiades (415 B.C.), and the strategi in command at Arginusae (406; Xen. *Hell.* i. 7. 19). The term *eisangelia* was also applied to denunciations brought against persons who wronged the orphan or the widow, or against a public arbitrator who had neglected his duty (Dem. *Meidias*, 86 f.).

A "presentation" of criminal information (*προβολή*) might be laid before the assembly with a view to obtaining its preliminary sanction for bringing the case before a judicial tribunal. Such was the mode of procedure adopted against persons who had brought malicious, groundless or vexatious accusations, or who had violated the sanctity of certain public festivals. The leading example of the former is the trial of the accusers who prompted the people to put to death the generals who had won the Battle of Arginusae (Xen. *Hell.* i. 7. 34); and, of the latter, the proceedings of Demosthenes against Meidias.

Legal actions (*δίκαι*) were classified as private (*ἴδιαι*) or public (*δημόσιαι*). The latter were also described as *γραφαί* or "prosecutions," but some *γραφαί* were called "private," when the state was regarded as only indirectly injured by a wrong done to an individual citizen (Dem. xxi. 47).

A private suit could only be brought by the man directly interested, or, in the case of a slave, a ward or an alien, by the master, guardian or patron respectively; and, if the suit were successful, the sum claimed generally went to the plaintiff. Public actions may be divided into ordinary criminal cases, and offences against the state. As a rule they could be instituted by any person who possessed the franchise, and the penalty was paid to the state. If the prosecutor failed to obtain one-fifth of the votes, he had to pay a fine of 1000 *drachmae* (L40), and lost the right of ever bringing a similar action.

Jurisdiction of the council and assembly.

Eisangelia.

Probolē.

Classes of legal actions.

Lawsuits, whether public or private, were also distinguished as *δίκαι κατά τινας* or *πρός τινας*, according as the defeated party could or could not be personally punished. Actions (*δῶνες*) were also distinguished as *ἀγῶνες τιμητοί* ("to be assessed"), in which the amount of damages had to be determined by the court, because it had not been fixed by law, and *ἀτιμητοί* ("not to be assessed"), in which the damages had not to be determined by the court, because they had already been fixed by law or by special agreement.

Among special kinds of action were *ἀπαγωγή*, *ἐπίγρησις* and *ἐνδειξις*. These could only be employed when the offence was patent and could not be denied. In the first, the person accused was summarily arrested by the prosecutor and haled into the presence of the proper official. In the second, the accuser took the officer with him to arrest the culprit (Dem. xxii. 26). In the third, he lodged an information with the official, and left the latter to effect the capture. *Φάσις*, a general term for many kinds of legal "information," was a form of procedure specially directed against those who injured the fiscal interests of the state, and against guardians who neglected the pecuniary interests of their wards. *Ἀπογραφή* was an action for confiscating property in private hands, which was claimed as belonging to the state, the term being derived from the claimants' written inventory of the property in question.

The ordinary procedure in all lawsuits, public or private; began with a personal summons (*πρόσκλησις*) of the defendant by the plaintiff accompanied by two witnesses (*ἀλητῆρες*). If the defendant failed to appear in court, these witnesses gave proof of the summons, and judgment went by default.

The action was begun by presenting a written statement of the case to the magistrate who presided over trials of the class in question. If the statement were accepted, court-fees were paid by both parties in a private action, and by the prosecutor alone in a public action. The magistrate fixed a day for the preliminary investigation (*ἀνάκρισις*), and, whenever several causes were instituted at the same time, he drew lots to determine the order in which they should be taken. Hence the plaintiff was said "to have a suit assigned him by lot" (*λαγχάνειν δίκην*), a phrase practically equivalent to "obtaining leave to bring an action." At the *ἀνάκρισις* the plaintiff and defendant both swore to the truth of their statements. If the defendant raised no formal protest, the trial proceeded in regular course (*εἰθυδαία*), but he might contend that the suit was inadmissible, and, to prove his point, might bring witnesses to confront those on the side of the plaintiff (*διαμαρτυρία*), or he might rely on argument without witnesses by means of a written statement traversing that of the plaintiff (*παραγραφή*). The person who submitted the special plea in bar of action naturally spoke first, and, if he gained the verdict, the main suit could not come on, or, at any rate, not in the way proposed or before the same court. A cross-action (*ἀντιγραφή*) might be brought by the defendant, but the verdict did not necessarily affect that of the original suit.

In the preliminary examination copies of the laws or other documents bearing on the case were produced. If any such document were in the hands of a third person, he could be compelled to produce it by an action for that purpose (*εἰς ἐμφανῶν κατάσσειν*). The depositions were ordinarily made before the presiding officer and were taken down in his presence. If a witness were compelled to be absent, a certified copy of his deposition might be sent (*ἐκμαρτυρία*). The depositions of slaves were not accepted, unless made under torture, and for receiving such evidence the consent of both parties was required. Either party could challenge the other to submit his slaves to the test (*πρόκλησις εἰς βίβανον*), and, in the event of the challenge being refused, could comment on the fact when the case came before the court. Either party could also challenge the other to take an oath (*πρόκλησις εἰς ὄρκον*), and, if the oath were declined, could similarly comment on the fact.

Ordinary legal procedure.

Documents.

Challenges.

Mercantile cases had to be decided within the interval of a month; others might be postponed for due cause. If, on the day of trial, one of the parties was absent, his representative had to show cause under oath (*ὕψωμοσία*); if the other party objected, he did so under oath (*ἀνθροπομοσία*). If the plea for delay were refused by the court, and it were the defendant who failed to appear, judgment went by default; in the absence of the plaintiff, the case was given in favour of the defendant.

The official who had conducted the preliminary inquiry also presided at the trial. The proceedings began with a solemn sacrifice. The plea of the plaintiff and the formal reply of the defendant were then read by the clerk. The court was next addressed first by the plaintiff, next by the defendant; in some cases there were two speeches on each side. Every litigant was legally required to conduct his own case. The speeches were often composed by professional experts for delivery by the parties to the suit, who were required to speak in person, though one or more unprofessional supporters (*συνήγοροι*) might subsequently speak in support of the case. The length of the speeches was in many cases limited by law to a fixed time recorded by means of a water-clock (clepsydra). Documents were not regarded as part of the speech, and, while these were being read, the clock was stopped (Goethe found a similar custom in force in Venice in October 1786). The witnesses were never cross-examined, but one of the litigants might formally interrogate the other. The case for the defence was sometimes finally supported by pathetic appeals on the part of relatives and friends.

When the speeches were over, the votes were taken. In the 5th century mussel-shells (*χορδίναι*) were used for the purpose. Each of the jurors received a shell, which he placed in one of the two urns, in that to the front if he voted for acquittal; in that to the back if he voted for condemnation. If a second vote had to be taken to determine the amount of the penalty, wax tablets were used, on which the juror drew a long line, if he gave the heavy penalty demanded by the plaintiff; a short one, if he decided in favour of the lighter penalty proposed by the defendant.

In the 4th century the mussel-shells were replaced by disks of bronze. Each disk (inscribed with the words ΨΗΦΟΣ ΔΗΜΟΣΙΑ) was about 1 in. in diameter, with a short tube running through the centre. This tube was either perforated or closed (see figs. 6 and 7 in frontispiece to Aristotle's *Constitution of Athens*, ed. Sandys). One of each kind was given to every juror, who was required to use the perforated or the closed disk, according as he voted for the plaintiff or for the defendant. On the platform there were two urns, one of bronze and one of wood. The juror placed in the hollow of his hand the disk that he proposed to use, and closed his fingers on the extremity of the tube, so that no one could see whether it were a perforated disk or not, and then deposited it in the bronze urn, and (with the same precaution to ensure secrecy) dropped the unused disk into the wooden urn. The votes were sorted by persons appointed by lot, and counted by the president of the court, and the result announced by the herald. For any second vote the same procedure was adopted (Aristotle, *u.s.*, c. 68 of Kenyon's Berlin text).

Pecuniary penalties were inflicted both in public and in private suits; personal penalties, in public suits only. Personal penalties included sentences of death or exile, or different degrees of disfranchisement (*ἀρῆτα*) with or without confiscation. Imprisonment before trial was common, and persons mulcted in penalties might be imprisoned until the penalties were paid, but imprisonment was never inflicted as the sole penalty after conviction. Foreigners alone could be sold into slavery. Sentences of death were carried out under the supervision of the board of police called the "Eleven." In ancient times a person condemned was hurled into a deep pit (the barathrum) in a north-western suburb of Athens. In later times he was compelled to drink the fatal draught of hemlock. Common malefactors were beaten to death with clubs. Fines were collected and confiscated property

sold by special officials, called *πράκτορες* and *πωληταί* respectively. In private suits the sentence was executed by the state if the latter had a share in any fine imposed, or if imprisonment were part of the penalty. Otherwise, the execution of the sentence was left to the plaintiff, who had the right of distraint, or, if this failed, could bring an action of ejection (*δίκη ἐξώτης*).

From the verdict of the heliaea there was no appeal. But, if judgment had been given by default, the person condemned might bring an action to prove that he was not responsible for such default, *τὴν ἔρημον* (*sc. δίκην*) ἀντιλαγχάνειν. The corresponding term for challenging the award of an arbitrator was *τὴν μὴ ὁσαν ἀντιλαγχάνειν*. He might also bring an action for false evidence (*δίκη ψευδομαρτυριῶν*) against his opponent's witnesses, and, on their conviction, have the sentence annulled. This "denunciation" of false evidence was technically called *ἐπισκήψις* and *ἐπισκίπτειν*.

The large number of the jurors made bribery difficult, but, as was first proved by Anytus (in 409), not impossible. It also diminished the feeling of personal responsibility, while it increased the influence of political motives. In addressing such a court, the litigants were not above appealing to the personal interests of the general public. We have a striking example of this in the terms in which Lysias makes one of his clients close a speech in prosecution of certain retail corn-dealers who have incurred the penalty of death by buying more than 75 bushels of wheat at one time: "If you condemn these persons, you will be doing what is right, and will pay less for the purchase of your corn; if you acquit them, you will pay more" (xxii. § 22).

Speakers were also tempted to take advantage of the popular ignorance by misinterpreting the enactments of the law, and the jurors could look for no aid from the officials who formally presided over the courts. The latter were not necessarily experts, for they owed their own original appointment to the caprice of the lot. Almost the only officials specially elected as experts were the strategoi, and these presided only in their own courts. Again, there was every temptation for the informer to propose the confiscation of the property of a wealthy citizen, who would naturally prefer paying blackmail to running the risk of having his case tried before a large tribunal which was under every temptation to decide in the interests of the treasury. In conclusion we may quote the opinions on the judicial system of Athens which have been expressed by two eminent classical scholars and English lawyers.

A translator of Aristophanes, Mr. B. Rogers, records his opinion "that it would be difficult to devise a judicial system less adapted for the due administration of justice" (Preface to *Wasps*, xxxv. f.), while a translator of Demosthenes, Mr. C. R. Kennedy, observes that the Athenian jurors "were persons of no legal education or learning; taken at haphazard from the whole body of citizens, and mostly belonging to the lowest and poorest class. On the other hand, the Athenians were naturally the quickest and cleverest people in the world. Their wits were sharpened by the habit . . . of taking an active part in important debates, and hearing the most splendid orators. There was so much litigation at Athens that they were constantly either engaged as jurors, or present as spectators in courts of law" (*Private Orations*, p. 36).

AUTHORITIES.—1. Greek Law. B. W. Leist, *Gräco-italische Rechtsgeschichte* (Jena, 1884); L. Mitteis, *Reichsrecht und Volksrecht in den östlichen Provinzen des römischen Kaiserreichs, mit Beiträgen zur Kenntnis des griechischen Rechts* (Leipzig, 1891); J. H. Lipsius, *Von der Bedeutung des griechischen Rechts* (Leipzig, 1893); G. Gilbert, "Zur Entwicklungsgeschichte des . . . griechischen Rechtes" in *Jahrb. für kl. Philologie* (Leipzig, 1896); H. J. Hitzig, *Die Bedeutung des altgriechischen Rechtes für die vergleichende Rechtswissenschaft* (Stuttgart, 1906); R. Hirzel, *Thema, Dike und Verwandtes* (Leipzig, 1907); J. J. Thoinsson, *Le Droit criminel de la Grèce légendaire*, followed by *Le Droit pénal de la république athénienne* (Brussels, 1875).

2. Attic Law. (a) Editions of Greek texts: I. B. Telly, *Corpus Juris Attici* (Pest and Leipzig, 1868); Aristotle's *Constitution of Athens*, ed. Kenyon (London, 1891, &c., and esp. ed. 4, Berlin, 1903); ed. 4, Blass (Leipzig, 1903); text with critical and explanatory notes, ed. Sandys (London, 1893); Lysias, ed. Frobergger (Leipzig, 1856-61); Isæus, ed. Wyse (Cambridge, 1904); Demosthenes, *Private Orations*, ed. Paley and Sandys, ed. 2 (Cambridge, 1896-1898); *Against Midias*, ed. Goodwin (Cambridge, 1906); Dareste, Hausoullet, Th. Reinach, *Inscr. juridiques grecques* (Paris, 1891-1904). (b) Modern treatises: K. F. Hermann, *De vestigiis institutorum*

Character
of the
Athenian
tribunals.

... *Atticorum per Platonis de legibus libros indagandis* (Marburg, 1836); *Staatsaltertümer*, ed. 6, Thunser (Freiburg, 1892); *Rechtsaltertümer*, ed. 3, Thalheim (Freiburg, 1884); G. Busolt, *Staats- und Rechtsaltertümer*, ed. 2 (Munich, 1892); U. von Wilamowitz-Möllendorf, *Aristoteles und Athen* (Berlin, 1893); G. Gilbert, *Gk. Constitutional Antiquities* (vol. 1, Eng. trans., pp. 376-416, London, 1895); J. H. Lipsius, (1) new ed. of Meier and Schömann, *Der attische Process* (Berlin, 1883-1887); (2) ed. 4 of Schömann, *Gr. Altertümer* (Berlin, 1897-1902); (3) *Das attische Recht und Rechtsverfahren* (Leipzig, 1905); Darenberg and Saglio, *Dictionnaire des antiquités* (Paris, 1877); G. Cloze, *La Solidarité de la famille dans le droit criminel en Grèce* (Paris, 1904); L. Beauchet, *Droit privé de la Grèce* (4 vols., Paris, 1897); C. R. Kennedy, *Appendices to transl. of Dem.* vols. iii. and iv. (1856-1861); *Smith's Dictionary of Antiquities*, ed. 3 (1891); F. B. Jevons, in Gardner and Jevons, *Greek Antiquities* (1895, pp. 526-597); W. Wyse, in Whibley's *Companion to Greek Studies* (Cambridge, 1905), pp. 377-402. (J. E. S. *)

GREEK LITERATURE.—The literature of the Greek language is broadly divisible into three main sections: (1) Ancient, (2) Byzantine, (3) Modern. These are dealt with below in that order.

I. THE ANCIENT GREEK LITERATURE

The ancient literature falls into three periods: (A) *The Early Literature*, to about 475 B.C.; epic, elegiac, iambic and lyric poetry; the beginnings of literary prose. (B) *The Attic Literature* 475-300 B.C.; tragic and comic drama; historical, oratorical and philosophical prose. (C) *The Literature of the Decline*, 300 B.C. to A.D. 529; which may again be divided into the Alexandrian period, 300-146 B.C., and the Graeco-Roman period, 146 B.C. to A.D. 529.

For details regarding particular works or the lives of their authors reference should be made to the separate articles devoted to the principal Greek writers. The object of the following pages is to sketch the literary development as a whole, to show how its successive periods were related to each other, and to mark the dominant characteristics of each.

(A) *The Early Literature.*—A process of natural growth may be traced through all the best work of the Greek genius. The Greeks were not literary imitators of foreign models; the forms of poetry and prose in which they attained to such unequalled excellence were first developed by themselves. Their literature had its roots in their political and social life; it is the spontaneous expression of that life in youth, maturity and decay; and the order in which its several fruits are produced is not the result of accident or caprice. Further, the old Greek literature has a striking completeness, due to the fact that each great branch of the Hellenic race bore a characteristic part in its development. Ionians, Aeolians, Dorians, in turn contributed their share. Each dialect corresponded to a certain aspect of Hellenic life and character. Each found its appropriate work.

The Ionians on the coast of Asia Minor—a lively and genial people, delighting in adventure, and keenly sensitive to everything bright and joyous—created artistic epic poetry out of the lays in which Aeolic minstrels sang of the old Achæan wars. And among the Ionians arose elegiac poetry, the first variation on the epic type. These found a fitting instrument in the harmonious Ionic dialect, the flexible utterance of a quick and versatile intelligence. The Aeolians of Lesbos next created the lyric of personal passion, in which the traits of their race—its chivalrous pride, its bold but sensuous fancy—found a fitting voice in the fiery strength and tenderness of Aeolic speech. The Dorians of the Peloponnesus, Sicily and Magna Graecia then perfected the choral lyric for festivals and religious worship; and here again an earnest faith, a strong pride in Dorian usage and renown had an apt interpreter in the massive and sonorous Doric. Finally, the Attic branch of the Ionian stock produced the drama, blending elements of all the other kinds, and developed an artistic literary prose in history, oratory and philosophy. It is in the Attic literature that the Greek mind receives its most complete interpretation.

A natural affinity was felt to exist between each dialect and that species of composition for which it had been specially used. Hence the dialect of the Ionian epic poets would be adopted with more or less thoroughness even by epic or elegiac poets who

were not Ionians. Thus the Aeolian Hesiod uses it in epos, the Dorian Theognis in elegy, though not without alloy. Similarly, the Dorian Theocritus wrote love-songs in Aeolic. All the faculties and tones of the language were thus gradually brought out by the co-operation of the dialects. Old Greek literature has an essential unity—the unity of a living organism; and this unity comprehends a number of distinct types, each of which is complete in its own kind.

Extant Greek literature begins with the Homeric poems. These are works of art which imply a long period of antecedent poetical cultivation. Of the pre-Homeric poetry we have no remains, and very little knowledge. Such glimpses as we get of it connect it with two different stages in the religion of the prehistoric Hellenes. The first of these stages is that in which the agencies or forms of external nature were personified indeed, yet with the consciousness that the personal names were only symbols. Some very ancient Greek songs of which mention is made may have belonged to this stage—as the songs of Linus, Ialampus and Hylas. Linus, the fair youth killed by dogs, seems to be the spring passing away before Sirius. Such songs have been aptly called "songs of the seasons."

The second stage is that in which the Hellenes have now definitively personified the powers which they worship. Apollo, Demeter, Dionysus, Cybele, have now become to them beings with clearly conceived attributes. To this second stage belong the hymns connected with the names of the legendary bards, such as Orpheus, Musæus, Eumolpus, who are themselves associated with the worship of the Pierian Muses and the Attic ritual of Demeter. The seats of this early sacred poetry are not only "Thracian"—i.e. on the borders of northern Greece—but also "Phrygian" and "Cretan." It belongs, that is, presumably to an age when the ancestors of the Hellenes had left the Indo-European home in central Asia, but had not yet taken full possession of the lands which were afterwards Hellenic. Some of their tribes were still in Asia; others were settling in the islands of the Aegean; others were passing through the lands on its northern seaboard. If there was a period when the Greeks possessed no poetry but hymns forming part of a religious ritual, it may be conjectured that it was not of long duration. Already in the *Iliad* a secular character belongs to the marriage hymn and to the dirge for the dead, which in ancient India were chanted by the priest. The bent of the Greeks was to claim poetry and music as public joys; they would not long have suffered them to remain sacerdotal mysteries. And among the earliest themes on which the lay artist in poetry was employed were probably war-ballads, sung by minstrels in the houses of the chiefs whose ancestors they celebrated.

Such war-ballads were the materials from which the earliest epic poetry of Greece was constructed. By an "epic" poem the Greeks meant a narrative of heroic action in hexameter verse. The term *ἔπος* meant at first simply "verses"; it acquired its special meaning only when *μῆλη*, lyric songs set to music, came to be distinguished from *ἔπη*, verses not set to music, but merely recited. Epic poetry is the only kind of extant Greek poetry which is older than about 700 B.C. The early epos of Greece is represented by the *Iliad* and the *Odyssey*, Hesiod and the Homeric hymns; also by some fragments of the "Cyclic" poets.

After the Dorian conquest of the Peloponnesus, the Aeolian emigrants who settled in the north-west of Asia Minor brought with them the warlike legends of their chiefs, the Achæan princes of old. These legends lived in the ballads of the Aeolic minstrels, and from them passed southward into Ionia, where the Ionian poets gradually shaped them into higher artistic forms. Among the seven places which claimed to be the birthplace of Homer, that which has the best title is Smyrna. Homer himself is called "son of Meles"—the stream which flowed through old Smyrna, on the border between Aeolia and Ionia. The tradition is significant in regard to the origin and character of the *Iliad*, for in the *Iliad* we have Achæan ballads worked up by Ionian art. A preponderance

Pre-Homeric poetry.

Songs of the seasons.

Hymns.

Epos.

The "Iliad" and the "Odyssey."

of evidence is in favour of the view that the *Odyssey* also, at least in its earliest form, was composed on the Ionian coast of Asia Minor. According to the Spartan account, Lycurgus was the first to bring to Greece a complete copy of the Homeric poems, which he had obtained from the Creophylidae, a clan or guild of poets in Samos. A better authenticated tradition connects Athens with early attempts to preserve the chief poetical treasure of the nation. Peisistratus is said to have charged some learned men with the task of collecting all "the poems of Homer"; but it is difficult to decide how much was comprehended under this last phrase, or whether the province of the commission went beyond the mere task of collecting. Nor can it be determined what exactly it was that Solon and Hipparchus respectively did for the Homeric poems. Solon, it has been thought, enacted that the poems should be recited from an authorized text (ἐξ ὁρισμένης); Hipparchus, that they should be recited in a regular order (ἐξ ἰσοψηφίας). At any rate, we know that in the 6th century B.C. a recitation of the poems of Homer was one of the established competitions at the Panathenaea, held once in four years. The reciter was called a *rhapsodist*—properly one who weaves a long, smoothly-flowing chant, then an epic poet who chants his own or another's poem. The rhapsodist did not, like the early minstrel, use the accompaniment of the harp; he gave the verses in a flowing recitative, bearing in his hand a branch of laurel, the symbol of Apollo's inspiration. In the 5th century B.C. we find that various Greek cities had their own editions (ἀι παλαιοὶ, κατὰ πόλεις or ἐκ πόλεων ἐκδόσεις) of the poems, for recitation at their festivals. Among these were the editions of Massilia, of Chios and of Argolis. There were also editions bearing the name of the individual editor (ἀι κατ' ἀνδρά)—the best known being that which Aristotle prepared for Alexander. The recension of the poems by Aristarchus (156 B.C.) became the standard one, and is probably that on which the existing text is based. The oldest Homeric MS. extant, Venetus A of the *Iliad*, is of the 10th century; the first printed edition of Homer was that edited by the Byzantine Demetrius Chalcondyles (Florence, 1483).

The ancient Greeks were almost unanimous in believing the *Iliad* and the *Odyssey* to be the work of one man, Homer, to whom they also ascribed some extant hymns, and probably much more besides. Aristotle and Aristarchus seem to have put Homer's date about 1044 B.C., Herodotus about 850 B.C. It is not till about 170 B.C. that the grammarians Hellanicus and Xenon put forward the view that Homer was the author of the *Iliad*, but not of the *Odyssey*. Those who followed them in assigning different authors to the two poems were called the Separators (*Chorizontes*). Aristarchus combated "the paradox of Xenon," and it does not seem to have had much acceptance in antiquity. Giovanni Battista Vico, a Neapolitan (1668-1744), seems to have been the first modern to suggest the composite authorship and oral tradition of the Homeric poems; but this was a pure conjecture in support of his theory that the names of ancient lawgivers and poets are often mere symbols. F. A. Wolf, in the *Prolegomena* to his edition (1795), was the founder of a scientific scepticism. The *Iliad*, he said (for he recognized the comparative unity and consistency of the *Odyssey*), was pieced together from many small unwritten poems by various hands, and was first committed to writing in the time of Peisistratus. This view was in harmony with the tone of German criticism at the time; it was welcomed as a new testimony to the superiority of popular poetry, springing from fresh natural sources, to elaborate works of art; and it at once found enthusiastic adherents. For the course of Homeric controversy since Wolf the reader is referred to the article HOMER.

The Ionian school of epos produced a number of poems founded on the legends of the Trojan war, and intended as introductions or continuations to the *Iliad* and the *Odyssey*. The grammarian Proclus (A.D. 140) has preserved the names and subjects of some of these; but the fragments are very scanty. The *Nostoi* or *Homeward Voyages*, by Agias (or Hagias) of Troezen, filled up the gap of

ten years between the *Iliad* and the *Odyssey*; the *Lay of Telegonus*, by Eugammon of Cyrene, continued the story of the *Odyssey* to the death of Odysseus by the hand of Telegonus, the son whom Circe bore to him. Similarly the *Cyprian Lays* by Stasinus of Cyprus, ascribed by others to Hegesias (or Hegecinus) of Salamis or Halicarnassus, was introductory to the *Iliad*; the *Aethiopsis* and the *Sack of Troy*, by Arctinus of Miletus, and the *Little Iliad*, by Lesches of Mytilene, were supplementary to it. These and many other names of lost epics—some taken also from the Theban myths (*Thebais*, *Epigoni*, *Oedipodea*)—serve to show how prolific was that epic school of which only two great examples remain. The name of *epic cycle* was properly applied to a prose compilation of abstracts from these epics, pieced together in the order of the events. The compilers were called "cyclic" writers; and the term has now been transferred to the epic poets whom they used.¹

The epic poetry of Ionia celebrated the great deeds of heroes in the old wars. But in Greece proper there arose another school of epos, which busied itself with religious lore and ethical precepts, especially in relation to the rural life of Boeotia. This school is represented by the name of Hesiod. The legend spoke of him as vanquishing Homer in a poetical contest of Chalcis in Euboea; and it expresses the fact that, to the old Greek mind, these two names stood for two contrasted epic types. Nothing is certainly known of his date, except that it must have been subsequent to the maturity of Ionian epos. He is conjecturally placed about 850-800 B.C.; but some would refer him to the early part of the 7th century B.C. His home was at Ascra, a village in a valley under Helicon, whither his father had migrated from Cyme in Aegolis on the coast of Asia Minor. In Hesiod's *Works and Days* we have the earliest example of a didactic poem. The seasons and the labours of the Boeotian farmer's year are followed by a list of the days which are lucky or unlucky for work. The *Theogony*, or "Origin of the Gods," describes first how the visible order of nature arose out of chaos; next, how the gods were born. Though it never possessed the character of a sacred book, it remained a standard authority on the genealogies of the gods. So far as a corrupt and confused text warrants a judgment, the poet was piecing together—not always intelligently—the fragments of a very old cosmogonic system, using for this purpose both the hymns preserved in the temples and the myths which lived in folklore. The epic lay in 480 lines called the *Shield of Heracles*—partly imitated from the 18th book of the *Iliad*—is the work of an author or authors later than Hesiod. In the Hesiodic poetry, as represented by the *Works and Days* and the *Theogony*, we see the influence of the temple at Delphi. Hesiod recognizes the existence of *δαίμονες*—spirits of the departed who haunt the earth as the invisible guardians of justice; and he connects the office of the poet with that of the prophet. The poet is one whom the gods have authorized to impress doctrine and practical duties on men. A religious purpose was essentially characteristic of the Hesiodic school. Its poets treated the old legends as relics of a sacred history, and not merely, in the Ionian manner, as subjects of idealizing art. Such titles as the *Maxims of Cheiron* and the *Lay of Melampus*, the seer—lost poems of the Hesiodic school—illustrate its ethical and its mystic tendencies.

The *Homeric Hymns* are a collection of pieces, some of them very short, in hexameter verse. Their traditional title is—*Hymns or Preludes of Homer and the Homeridae*. The second of the alternative designations is the true one. The pieces are not "hymns" used in formal worship, but "preludes" or prefatory addresses (*προοίμια*) with which the rhapsodists ushered in their recitations of epic poetry. The "prelude" might be addressed to the presiding god of the festival, or to any local deity whom the reciter wished to honour. The pieces (of which there are 33) range in date perhaps from 750 to 500 B.C. (though some authorities assign dates as late as the 3rd and 4th centuries A.D.; see ed. by Sikes and Allen, e.g. p. 228), and it is probable that the collection was

¹ For authorities and criticisms see T. W. Allen in *Classical Quarterly* (Jan. and April 1908).

formed in Attica, for the use of rhapsodists. The style is that of the Ionian or Homeric epos; but there are also several traces of the Hesiodic or Boeotian school. The principal "hymns" are (1) to Apollo (generally treated as two or more hymns combined in one); (2) to Hermes; (3) to Aphrodite; and (4) to Demeter. The hymn to Apollo, quoted by Thucydides (iii. 104) as Homer's, is of peculiar interest on account of the lines describing the Ionian festival at Delos. Two celebrated pieces of a sportive kind passed under Homer's name. The *Margites*—a comic poem on one "who knew many things but knew them all badly"—is regarded by Aristotle as the earliest germ of comedy, and was possibly as old as 700 B.C. Only a few lines remain. The *Batracho(myo)machia*, or *Battle of the Frogs and Mice* probably belongs to the decline of Greek literature, perhaps to the 2nd century B.C.¹ About 300 verses of it are extant.

In the *Iliad* and the *Odyssey* the personal opinions or sympathies of the poet may sometimes be conjectured, but they are not declared or even hinted. Hesiod, indeed, sometimes gives us a glimpse of his own troubles or views, but yet Hesiod is, on the whole, essentially a prophet. The message which he delivers is not from himself; the truths which he imparts have not been discovered by his own search. He is the mouthpiece of the Delphian Apollo. Personal opinion and feeling may tinge his utterance, but they do not determine its general complexion. The egotism is a single thread; it is not the basis of the texture. Epic poetry was in Greece the foundation of all other poetry; for many centuries no other kind was generally cultivated, no other could speak to the whole people. Politically, the age was monarchical or aristocratic; intellectually, it was too simple for the analysis of thought or emotion. Kings and princes loved to hear of the great deeds of their ancestors; common men loved to hear of them too, for they had no other interest. The mind of Greece found no subject of contemplation so attractive as the warlike past of the race, or so useful as that lore which experience and tradition had bequeathed. But in the course of the 8th century B.C. the rule of hereditary princes began to disappear. Monarchy gave place to oligarchy, and this—often after the intermediate phase of a tyrannis—to democracy. Such a change was necessarily favourable to the growth of reflection. The private citizen is no longer a mere cipher, the Homeric *πῆρ*, a unit in the dim multitude of the king-ruled folk; he gains more power of independent action, his mental horizon is widened, his life becomes fuller and more interesting. He begins to feel the need of expressing the thoughts and feelings that are stirred in him. But as yet a prose literature does not exist; the new thoughts, like the old heroic stories, must still be told in verse. The forms of verse created by this need were the Elegiac and the Iambic.

The elegiac metre is, in form, a simple variation on the epic metre, obtained by docking the second of two hexameters so as to make it a verse of five feet or measures. But the poetical capabilities of the elegiac couplet are of a wholly different kind from those of heroic verse. *Ελεγος* seems to be the Greek form of a name given by the Carians and Lydians to a lament for the dead. This was accompanied by the soft music of the Lydian flute, which continued to be associated with Greek elegy. The non-Hellenic origin of elegy is indicated by this very fact. The flute was to the Greeks an Asiatic instrument—string instruments were those which they made their own—and it would hardly have been wedded by them to a species of poetry which had arisen among themselves. The early elegiac poetry of Greece was by no means confined to mourning for the dead. War, love, politics, proverbial philosophy, were in turn its themes; it dealt, in fact, with the chief interest of the poet and his friends, whatever that might be at the time. It is the direct expression of the poet's own thoughts, addressed to a sympathizing society. This is its first characteristic. The second is that, even when most pathetic or most spirited, it still preserves, on the whole, the tone of conversation or of

¹ Others attribute it, as well as the *Margites*, to Pigres of Halicarnassus, the supposed brother of the Carian queen Artemisia, who fought on the side of Xerxes at the battle of Salamis.

narrative. Greek elegy stops short of lyric passion; English elegy, whether funereal as in Dryden and Pope, or reflective as in Gray, is usually true to the same normal type. Roman elegy is not equally true to it, but sometimes tends to trench on the lyric province. For Roman elegy is mainly amatory or sentimental; and its masters imitated, as a rule, not the early Greek elegists, not Tyrtaeus or Theognis, but the later Alexandrian elegists, such as Callimachus or Philetas. Catullus introduced the metre to Latin literature, and used it with more fidelity than his followers to its genuine Greek inspiration.

Elegy, as we have seen, was the first slight deviation from epos. But almost at the same time another species arose which had nothing in common with epos, either in form or in spirit. This was the iambic. The word *ἰαμβος*, *iambus* (*ἰάμβος*, to dart or shoot) was used in reference to the licensed raillery at the festivals of Demeter; it was the maiden Iambe, the myth said, who drew the first smile from the mourning goddess. The iambic metre was at first used for satire; and it was in this strain that it was chiefly employed by its earliest master of note, Archilochus of Paros (670 B.C.). But it was adapted to the expression generally of any pointed thought. Thus it was suitable to fables. Elegiac and iambic poetry both belong to the borderland between epic and lyric. While, however, elegy stands nearer to epos, iambic stands nearer to the lyric. Iambic poetry can express the personal feeling of the poet with greater intensity than elegy does; on the other hand, it has not the lyric flexibility, self-abandonment or glow. As we see in the case of Solon, iambic verse could serve for the expression of that deeper thought, that more inward self-communing, for which the elegiac form would have been inappropriate.

But these two forms of poetry, both Ionian, the elegiac and the iambic, belong essentially to the same stage of the literature. They stand between the Ionian epos and the lyric poetry of the Aeolians and Dorians. The earliest of the Greek elegists, Callinus and Tyrtaeus, use elegy to rouse a warlike spirit in sinking hearts. Archilochus too wrote warlike elegy, but used it also in other strains, as in lament for the dead. The elegy of Mimnermus of Smyrna or Colophon is the plaintive farewell of an ease-loving Ionian to the days of Ionian freedom. In Solon elegy takes a higher range; it becomes political and ethical.² Theognis represents the maturer union of politics with a proverbial philosophy. Another gnomic poet was Phocylides of Miletus; an admonitory poem extant under his name is probably the work of an Alexandrine Jewish Christian. Xenophanes gives a philosophic strain to elegy. With Simonides of Ceos it reverts, in an exquisite form, to its earliest destination, and becomes the vehicle of epitaph on those who fell in the Persian Wars. Iambic verse was used by Simonides (or Semonides) of Amorgus, as by Archilochus, for satire—but satire directed against classes rather than persons. Solon's iambics so far preserve the old associations of the metre that they represent the polemical or controversial side of his political poetry. Hipponax of Ephesus was another iambic satirist—using the *κρόβητος* ("limping") or choliambic verse, produced by substituting a spondee for an iambus in the last place. But it was not until the rise of the Attic drama that the full capabilities of iambic verse were seen.

The lyric poetry of early Greece may be regarded as the final form of that effort at self-expression which in the elegiac and iambic is still incomplete. The lyric expression is deeper and more impassioned. Its intimate union with music and with the rhythmical movement of the dance gives to it more of an ideal character. At the same time the continuity of the music permits pauses to the voice—pauses necessary as reliefs after a climax. Before lyric poetry could be effective, it was necessary that some progress should have been made in the art of music. The instrument used by the Greeks to accompany the voice was the four-stringed lyre, and the first great epoch in Greek music was when Terpander of Lesbos (660 B.C.), by adding three strings, gave the lyre the

² The extant fragments of Solon have been augmented by lengthy quotations in the *Constitution of Athens*.

compass of the octave. Further improvements are ascribed to Olympus and Thaletas. By 500 B.C. Greek music had probably acquired all the powers of expression which the lyric poet could demand. The period of Greek lyric poetry may be roughly defined as from 670 to 440 B.C. Two different parts in its development were taken by the Aeolians and the Dorians.

The lyric poetry of the Aeolians—especially of Lesbos—was essentially the utterance of personal feeling, and was usually intended for a single voice, not for a chorus. Lesbos, in the 7th century B.C., had attained some naval and commercial importance. But the strife of oligarchy and democracy was active; the Lesbian nobles were often driven by revolution to exchange their luxurious home-life for the hardships of exile. It is such a life of contrasts and excitements, working on a sensuous and fiery temperament, that is reflected in the fragments of Alcaeus. In these glimpses of war and love, of anxiety for the storm-tossed state and of careless festivity, there is much of the cavalier spirit; if Archilochus is in certain aspects a Greek Byron, Alcaeus might be compared to Lovelace. The other great representative of the Aeolian lyric is Sappho, the only woman of Greek race who is known to have possessed poetical genius of the first order. Intensity and melody are the characteristics of the fragments that remain to us.¹ Probably no poet ever surpassed Sappho as an interpreter of passion in exquisitely subtle harmonies of form and sound. Anacreon of Teos, in Ionia, may be classed with the Aeolian lyricists in so far as the matter and form of his work resembled theirs, though the dialect in which he wrote was mainly the Ionian. A few fragments remain from his hymns to the gods, from love-poems and festive songs. The collection of sixty short pieces which passes current under his name date only from the 10th century. The short poems which it comprises are of various age and authorship, probably ranging in date from c. 200 B.C. to A.D. 400 or 500. They have not the pure style, the flexible grace, or the sweetness of the classical fragments; but the verses, though somewhat mechanical, are often pretty.

Aeolian school.

The Dorian lyric poetry, in contrast with the Aeolian, had more of a public than of a personal character, and was for the most part choral. Hymns or choruses for the public worship of the gods, and odes to be sung at festivals on occasions of public interest, were its characteristic forms. Its central inspiration was the pride of the Dorians in the Dorian past, in their traditions of worship, government and social usage. The history of the Dorian lyric poetry does not present us with vivid expressions of personal character, like those of Alcaeus and Sappho, but rather with a series of artists whose names are associated with improvements of form. Thus Alcman (the Doric form of Alcmaeon; 660 B.C.) is said to have introduced the balanced movement of strophe and antistrophe. Stesichorus, of Himera in Sicily, added the epode, sung by the chorus while stationary after these movements; Arion of Methymna in Lesbos gave a finished form to the choral hymn ("dithyramb") in honour of Dionysus, and organized the "cyclic" or circular chorus which sang it at the altar. Ibycus of Rhegium (c. 540) wrote choral lyrics after Stesichorus and glowing love-songs in the Aeolic style.

The culmination of the lyric poetry is marked by two great names, Simonides and Pindar. Simonides (556-468) was an Ionian of the island of Ceos, but his lyrics belonged by form to the choral Dorian school. Many of his subjects were taken from the events of the Persian wars: his epitaphs on those who fell at Thermopylae and Salamis were celebrated. In him the lyric art of the Dorians is interpreted by Ionian genius, and Athens—where part of his life was passed—is the point at which they meet. Simonides is the first Greek

Simonides and Pindar.

¹ Since the above was written, four considerable fragments generally assigned to Sappho have been discovered: a prayer to the Nereids for the safe return of her brother Charaxus; the leave-taking of a favourite pupil; a greeting to Atthis, one of her friends, in Lydia; the fourth, much mutilated, addressed to another pupil, Gongyla. They are of great beauty and throw considerable light on the personality of Sappho and the language and metre of her poems.

lyricist whose significance is not merely Aeolian or Dorian but Panhellenic. The same character belongs even more completely to his younger contemporary. Pindar (518-c. 443) was born in Boeotia of a Dorian stock; thus, as Ionian and Dorian elements meet in Simonides, so Dorian and Aeolian elements meet in Pindar. Simonides was perhaps the most tender and most exquisite of the lyric poets. Pindar was the boldest, the most fervid and the most sublime. His extant fragments² represent almost every branch of the lyric art. But he is known to us mainly by forty-four *Epinicia*, or odes of victory, for the Olympian, Pythian, Nemean and Isthmian festivals. The general characteristic of the treatment is that the particular victory is made the occasion of introducing heroic legends connected with the family or city of the victor, and of inculcating the moral lessons which they teach. No Greek lyric poetry can be completely appreciated apart from the music, now lost, to which it was set. Pindar's odes were, further, essentially occasional poems; they abound in allusions of which the effect is partly or wholly lost on us; and the glories which they celebrate belong to a life which we can but imperfectly realize. Of all the great Greek poets, Pindar is perhaps the one to whom it is hardest for us to do justice; yet we can at least recognize his splendour of imagination, his strong rapidity and his soaring flight.

Bacchylides of Ceos (c. 504-430), the youngest of the three great lyric poets and nephew of Simonides, was known only by scanty fragments until the discovery of nineteen poems on an Egyptian papyrus in 1896. They consist of thirteen (or fourteen) *epinicia*, two of which celebrate the same victories as two odes of Pindar. The papyrus also contains six odes for the festivals of gods or heroes. The poems contain valuable information on the court life of the time and legendary history. Bacchylides, the little "Cean nightingale," is inferior to his great rival Pindar, "the Swan of Dirce," in originality and splendour of language, but he writes simply and elegantly, while his excellent *ῥήματα* attracted readers of a philosophical turn of mind, amongst them the emperor Julian.

Similarly, the scanty fragments of Timotheus of Miletus (d. 357), musical composer and poet, and inventor of the eleven-stringed lyre, were increased by the discovery in 1902 of some 250 lines of his "nome" the *Persae*, written after the manner of Terpander. The beginning is lost; the middle describes the battle of Salamis; the end is of a personal nature. The papyrus is the oldest Greek MS. and belongs to the age of Alexander the Great. The language is frequently very obscure, and the whole is a specimen of lyric poetry in its decline.

(B) *The Attic Literature.*—The Ionians of Asia Minor, the Aeolians and the Dorians had now performed their special parts in the development of Greek literature. Epic poetry had interpreted the heroic legends of warlike deeds done by Zeus-nourished kings and chiefs. Then, as the individual life became more and more elegiac and iambic poetry had become the social expression of that life in all its varied interests and feelings. Lastly, lyric poetry had arisen to satisfy a twofold need—to be the more intense utterance of personal emotion, or to give choral voice, at stirring moments, to the faith or fame, the triumph or the sorrow, of a city or a race. A new form of poetry was now to be created, with elements borrowed from all the rest. And this was to be achieved by the people of Attica, in whose character and language the distinctive traits of an Ionian descent were tempered with some of the best qualities of the Dorian stock.

The drama (*q.v.*) arose from the festivals of Dionysus, the god of wine, which were held at intervals from the beginning of winter to the beginning of spring. A troop of rustic worshippers would gather around the altar of the god, and sing a hymn in his honour, telling of his victories or sufferings in his progress over the earth. "Tragedy" meant "the goat-song," a goat (*τράγος*) being sacrificed to Dionysus before the hymn was sung. "Comedy," "the village-song," is the same hymn regarded as an occasion for

Origin of drama.

Tragedy.

² Recently increased by specimens of the *Parthenica* (choral songs for maidens) and *paiana*.

rustic jest. Then the leader of the chorus would assume the part of a messenger from Dionysus, or even that of the god himself, and recite an adventure to the worshippers, who made choral response. The next step was to arrange a dialogue between the leader (*αρχαῖος, coryphaeus*) and one chosen member of the chorus, hence called "the answerer" (*ἀποκρίτης, hypocritēs*, afterwards the ordinary word for "actor"). This last improvement is ascribed to the Attic Thespis (about 536 B.C.). The elements of drama were now ready. The choral hymn to Dionysus (the "dithyramb") had received an artistic form from the Dorians; dialogue, though only between the leader of the chorus and a single actor, had been introduced in Attica. Phrynichus, an Athenian, celebrated in this manner some events of the Persian Wars; but in his "drama" there was still only one actor. Choerilus of Athens and Pratinas of Phlius, who belonged to the same period, developed the satyric drama; Pratinas also wrote tragedies, dithyrambs, and *hyporchemata* (lively choral odes chiefly in honour of Apollo).

Aeschylus (born 525 B.C.) became the real founder of tragedy by introducing a second actor, and thus rendering the dialogue independent of the chorus. At the same time the choral song—hitherto the principal part of the performance—became subordinate to the dialogue; and drama was mature. Aeschylus is also said to have made various improvements of detail in costume and the like; and it was early in his career that the theatre of Dionysus under the acropolis was commenced—the first permanent home of Greek drama, in place of the temporary wooden platforms which had hitherto been used. The system of the "trilogy" and the "tetralogy" is further ascribed to Aeschylus,—the "trilogy" being properly a series of three tragedies connected in subject, such as the *Agamemnon*, *Choëphori*, *Eumenides*, which together form the *Oresteia*, or Story of Orestes. The "tetralogy" is such a triad with a "satyric drama" added—that is, a drama in which "satyrs," the grotesque woodland beings who attended on Dionysus, formed the chorus, as in the earlier dithyramb from which drama sprang. The *Cyclops* of Euripides is the only extant specimen of a satyric drama. In the seven tragedies which alone remain of the seventy which Aeschylus is said to have composed, the forms of kings and heroes have a grandeur which is truly Homeric; there is a spirit of Panhellenic patriotism such as the Persian Wars in which he fought might well quicken in a soldier-poet; and, pervading all, there is a strain of speculative thought which seeks to reconcile the apparent conflicts between the gods of heaven and of the underworld by the doctrine that both alike, constrained by necessity, are working out the law of righteousness. Sophocles, who was

born thirty years after Aeschylus (495 B.C.), is the most perfect artist of the ancient drama. No one before or after him gave to Greek tragedy so high a degree of ideal beauty, or appreciated so finely the possibilities and the limitations of its sphere. He excels especially in drawing character; his *Antigone*, his *Ajax*, his *Oedipus*—indeed, all the chief persons of his dramas—are typical studies in the great primary emotions of human nature. He gave a freer scope to tragic dialogue by adding a third actor; and in one of his later plays, the *Oedipus at Colonus*, a fourth actor is required. From the time when he won the tragic prize against Aeschylus in 468 to his death in 405 B.C. he was the favourite dramatist of Athens; and for us he is not only a great dramatist, but also the most spiritual representative of the age of Pericles. The distinctive interest of Euripides is of

another kind. He was only fifteen years younger than Sophocles; but when he entered on his poetical career, the old inspirations of tragedy were already failing. Euripides marks a period of transition in the tragic art, and is, in fact, the mediator between the classical and the romantic drama. The myths and traditions with which the elder dramatists had dealt no longer commanded an unquestioning faith. Euripides himself was imbued with the new intellectual scepticism of the day; and the speculative views which were conflicting in his own mind are reflected in his plays. He had much picturesque and pathetic power; he was a master of expression; and he shows ingenuity

in devising fresh resources for tragedy—especially in his management of the choral songs. Aeschylus is Panhellenic, Sophocles is Athenian, Euripides is cosmopolitan. He stands nearer to the modern world than either of his predecessors; and though with him Attic tragedy loses its highest beauty, it acquires new elements of familiar human interest.

In Attica, as in England, a period of rather less than fifty years sufficed for the complete development of the tragic art. The two distinctive characteristics of Athenian drama are its originality and its abundance. The Greeks of Attica were not the only inventors of drama, but they were the first people who made drama a complete work of art. And the great tragic poets of Attica were remarkably prolific. Aeschylus was the reputed author of 70 tragedies, Sophocles of 113, Euripides of 92; and there were others whose productiveness was equally great.

Comedy represented the lighter side, as tragedy the graver side, of the Dionysiac worship; it was the joy of spring following the gloom of winter. The process of growth was nearly the same as in tragedy; but the Dorians, not the Ionians of Attica, were the first who added dialogue to the comic chorus. Susarion, a Dorian of Megara, exhibited, about 580 B.C., pieces of the kind known as "Megarian farces." Epicharmus of Cos (who settled at Syracuse) gave literary form to the Doric farce, and treated in burlesque style the stories of gods and heroes, and subjects taken from everyday life. His Syracuse contemporary Sophron (c. 450) was a famous writer of mimes, chiefly scenes from low-class life. The most artistic form of comedy seems, however, to have been developed in Attica. The greatest names before Aristophanes are those of Cratinus and Eupolis; but from about 470 B.C. there seems to have been a continuous succession of comic dramatists, amongst them Plato Comicus, the author of 28 comedies, political satires and parodies after the style of the Middle Comedy.

Aristophanes came forward as a comic poet in 427 B.C., and retained his popularity for about forty years. He presents a perhaps unique union of bold fancy, exquisite humour, critical acumen and lyrical power. His eleven extant comedies may be divided into three groups, according as the licence of political satire becomes more and more restricted. In the *Acharnians*, *Knights*, *Clouds*, *Wasps* and *Peace* (425-421) the poet uses unrestrained freedom. In the *Birds*, *Lysistrata*, *The Frogs* (414-405) a greater reserve may be perceived. Lastly, in the *Ecclesiazusae* and the *Plutus* (392-388) personal satire is almost wholly avoided. The same general tendency continued. The so-called "Middle Comedy" (390-320) represents the transition from the Old Comedy, or political satire, to satire of a literary or social nature; its chief writers were Antiphanes of Athens and Alexis of Thuri. The "New Comedy" (320-250) resembled the modern "comedy of manners."

Its chief representative was Menander (342-291), the author of 105 comedies. Fragments have been discovered of seven of these, of sufficient length to give an idea of their dramatic action. His plays were produced on the stage as late as the time of Plutarch, and his *tyrannus*, distinguished by worldly wisdom, were issued in the form of anthologies, which enjoyed great popularity. Other prominent writers of this class were Diphilus, Philemon, Posidippus and Apollodorus of Carystus. About 330 B.C. Rhinthon of Tarentum revived the old Doric farce in his *Hilarotragediaë* or travesties of tragic stories. These successive periods cannot be sharply or precisely marked off. The change which gradually passed over the comic drama was simply the reflection of the change which passed over the political and social life of Athens. The Old Comedy, as we see it in the earlier plays of Aristophanes, was probably the most powerful engine of public criticism that has ever existed in any community. Unsparring personality was its essence. The comic poet used this recognized right on an occasion at once festive and sacred, in a society where every man of any note was known by name and sight to the rest. The same thousands who heard a policy or a character denounced or lauded in the theatre might be required to pass sentence on it in the popular assembly or in the courts of law.

The development of Greek poetry had been completed before a prose literature had begun to exist. The earliest name in extant Greek prose literature is that of Herodotus; and, when he wrote, the Attic drama had already passed its prime. There had been, indeed, writers of prose before Herodotus; but there had not been, in the proper sense of the term, a prose literature. The causes of this comparatively late origin of Greek literary prose are independent of the question as to the time at which the art of writing began to be generally used for literary purposes. Epic poetry exercised for a very long period a sovereign spell over the Greek mind. In it was deposited all that the race possessed of history, theology, philosophy, oratory. Even after an age of reflection had begun, elegiac poetry, the first offshoot of epic, was, with iambic verse, the vehicle of much which among other races would have been committed to prose. The basis of Greek culture was essentially poetical. A political cause worked in the same direction. In the Eastern monarchies the king was the centre of all, and the royal records afforded the elements of history from a remote date. The Greek nation was broken up into small states, each busied with its own affairs and its own men. It was the collision between the Greek and the barbarian world which first provided a national subject for a Greek historian. The work of Herodotus, in its relation to Greek prose, is so far analogous to the *Iliad* in its relation to Greek poetry, that it is the earliest work of art, and that it bears a Panhellenic stamp.

The sense and the degree in which Herodotus was original may be inferred from what is known of earlier prose-writers.

For about a century before Herodotus there had been a series of writers in philosophy, mythology, geography and history. The earliest, or among the earliest, of the philosophical writers were Pherecydes of Syros (550 B.C.) and the Ionian Anaximenes and Anaximander. It is doubtful whether Cadmus of Miletus, supposed to have been the first prose writer, was an historical personage. The Ionian writers, especially called *λογογράφοι*, "narrators in prose" (as distinguished from *ἑρμηνεῖς*, makers of verse), were those who compiled the myths, especially in genealogies, or who described foreign countries, their physical features, usages and traditions. Hecataeus of Miletus (500 B.C.) is the best-known representative of the *logographi* in both these branches. Hellanicus of Mytilene (450 B.C.), among whose works was a history of Attica, appears to have made a nearer approach to the character of a systematic historian. Other *logographi* were Charon of Lampsacus; Pherecydes of Leros, who wrote on the myths of early Attica; Hippys of Rhegium, the oldest writer on Italy and Sicily; and Acusilaus of Argos in Boeotia, author of genealogies (see LOGOGRAPHI, and GREECE: *Ancient History*, "Authorities").

Herodotus was born in 484 B.C.; and his history was probably not completed before the beginning of the Peloponnesian War (431 B.C.). His subject is the struggle between Greece and Asia, which he deduces from the legendary rape of the Argive Io by Phoenicians, and traces down to the final victory of the Greeks over the invading host of Xerxes. His literary kinship with the historical or geographical writers who had preceded him is seen mainly in two things. First, though he draws a line between the mythological and the historical age, he still holds that myths, as such, are worthy to be reported, and that in certain cases it is part of his duty to report them. Secondly, he follows the example of such writers as Hecataeus in describing the natural and social features of countries. He seeks to combine the part of the geographer or intelligent traveller with his proper part as historian. But when we turn from these minor traits to the larger aspects of his work, Herodotus stands forth as an artist whose conception and whose method were his own. His history has an epic unity. Various as are the subordinate parts, the action narrated is one, great and complete; and the unity is due to this, that Herodotus refers all events of human history to the principle of divine Nemesis. If Sophocles had told the story of Oedipus in the *Oedipus Tyrannus* alone, and had not added to it the *Oedipus at Colonus*,

it would have been comparable to the story of Xerxes as told by Herodotus. Great as an artist, great too in the largeness of his historical conception, Herodotus fails chiefly by lack of insight into political cause and effect, and by a general silence in regard to the history of political institutions. Both his strength and his weakness are seen most clearly when he is contrasted with that other historian who was strictly his contemporary and who yet seems divided from him by centuries.

Thucydides was only thirteen years younger than Herodotus; but the intellectual space between the men is so great that they seem to belong to different ages. Herodotus is the first artist in historical writing; Thucydides is the first thinker. Herodotus interweaves two threads of causation—human agency, represented by the good or bad qualities of men, and divine agency, represented by the vigilance of the gods on behalf of justice. Thucydides concentrates his attention on the human agency (without, however, denying the other), and strives to trace its exact course. The subject of Thucydides is the Peloponnesian War. In resolving to write its history, he was moved, he says, by these considerations. It was probably the greatest movement which had ever affected Hellas collectively. It was possible for him as a contemporary to record it with approximate accuracy. And this record was likely to have a general value, over and above its particular interest as a record, seeing that the political future was likely to resemble the political past. This is what Thucydides means when he calls his work "a possession for ever." The speeches which he ascribes to the persons of the history are, as regards form, his own essays in rhetoric of the school to which Antiphon belongs. As regards matter, they are always so far dramatic that the thoughts and sentiments are such as he conceived possible for the supposed speaker. Thucydides abstains, as a rule, from moral comment; but he tells his story as no one could have told it who did not profoundly feel its tragic force; and his general claim to the merit of impartiality is not invalidated by the possible exceptions—difficult to estimate—in the cases of Cleon and Hyperbolus.

Strong as is the contrast between Herodotus and Thucydides, their works have yet a character which distinguish both alike from the historical work of Xenophon in the *Anabasis* and the *Hellenica*. Herodotus gives us a vivid drama with the unity of an epic. Thucydides takes a great chapter of contemporary history and traces the causes which are at work throughout it, so as to give the whole a scientific unity. Xenophon has not the grasp either of the dramatist or of the philosopher. His work does not possess the higher unity either of art or of science. The true distinction of Xenophon consists in his thorough combination of the practical with the literary character. He was an accomplished soldier, who had done and seen much. He was also a good writer, who could make a story both clear and lively. But the several parts of the story are not grouped around any central idea, such as a divine Nemesis is for Herodotus, or such as Thucydides finds in the nature of political man. The seven books of the *Hellenica* form a supplement to the history of Thucydides, beginning in 411 and going down to 362 B.C. The chief blot on the *Hellenica* is the author's partiality to Sparta, and in particular to Agesilaus. Some of the greatest achievements of Epaminondas and Pelopidas are passed over in silence. On the whole, Xenophon is perhaps seen at his best in his narrative of the *Retreat of the Ten Thousand*—a subject which exactly suits him. The *Cyropaedia* is a romance of little historical worth, but with many good passages. The *Recollections of Socrates*, on the other hand, derive their principal value from being uniformly matter-of-fact. In his minor pieces on various subjects Xenophon appears as the earliest essayist. It may be noted that one of the essays erroneously ascribed to him—that *On the Athenian Polity*—is probably the oldest specimen in existence of literary Attic prose.

His contemporaries Ctesias of Cnidus and Philistus of Syracuse wrote histories of Persia and Sicily. In the second half of the 4th century a number of histories were compiled by literary men of little practical knowledge, who had been trained in the

rhetorical schools. Such were Ephorus of Cyme and Theopompus of Chios, both pupils of Isocrates; and the writers of *Alkibiades* (chronicles of Attic history), the chief of whom were Androtion and Philochorus. Timæus of Tauromenium was the author of a great work on Sicily, and introduced the system of reckoning by Olympiads.

The steps by which an Attic prose style was developed, and the principal forms which it assumed, can be traced most clearly in the Attic orators. Every Athenian citizen who

Oratory. aspired to take part in the affairs of the city, or even to be qualified for self-defence before a law-court, required to have some degree of skill in public speaking; and an Athenian audience looked upon public debate, whether political or forensic, as a competitive trial of proficiency in a fine art. Hence the speaker, no less than the writer, was necessarily a student of finished expression; and oratory had a more direct influence on the general structure of literary prose than has ever perhaps been the case elsewhere. A systematic rhetoric took its rise in Sicily, where Corax of Syracuse (466 B.C.) devised his *Art of Words* to assist those who were pleading before the law-courts; and it was brought to Athens by his disciple Tisias. The teaching of the Sophists, again, directed attention, though in a superficial and imperfect way, to the elements of grammar and logic; and Gorgias of Leontini—whose declamation, however turgid, must have been striking—gave an impulse at Athens to the taste for elaborate rhetorical brilliancy.

Antiphon represents the earliest, and what has been called the grand, style of Attic prose; its chief characteristics are

The Attic orators. a grave, dignified movement, a frequent emphasis on verbal contrasts, and a certain austere elevation.

The interest of Andocides is mainly historical; but he has graphic power. Lysias, the representative of the "plain style," breaks through the rigid mannerism of the elder school, and uses the language of daily life with an ease and grace which, though the result of study, do not betray their art. He is, in his own way, the canon of an Attic style; and his speeches, written for others, exhibit also a high degree of dramatic skill. Isocrates, whose manner may be regarded as intermediate between that of Antiphon and that of Lysias, wrote for readers rather than for hearers. The type of literary prose which he founded is distinguished by ample periods, by studied smoothness and by the temperate use of rhetorical ornament. From the middle of the 4th century B.C. the Isocratic style of prose became general in Greek literature. From the school of Rhodes, in which it became more florid, it passed to Cicero, and through him it has helped to shape the literary prose of the modern world. The speeches of Isæus in will-cases are interesting,—apart from their bearing on Attic life,—because in them we see, as Dionysius says, "the seeds and the beginnings" of that technical mastery in rhetorical argument which Demosthenes carries to perfection.

Demosthenes. Isæus has also, in a degree, some of the qualities of Lysias. Demosthenes excels all other masters of

Greek prose not only in power but in variety; his political speeches, his orations in public or private causes, show his consummate and versatile command over all the resources of the language. In him the development of Attic prose is completed, and the best elements in each of its earlier phases are united. The modern world can more easily appreciate Demosthenes as a great natural orator than as an elaborate artist. But, in order to apprehend his place in the history of Attic prose, we must remember that the ancients felt him to be both; and that he was even reproached by detractors with excessive study of effect. Aeschines is the most theatrical of the Greek orators; he is vehement, and often brilliant, but seldom persuasive. Hyperides was, after Demosthenes, probably the most effective; he had much of the grace of Lysias, but also a wit, a fire and a pathos which were his own. Portions of six of his speeches, found in Egypt between 1847 and 1800, are extant. The one oration of Lycurgus which remains to us is earnest and stately, reminding us both of Antiphon and of Isocrates. Dinarchus was merely a bad imitator of Demosthenes. There seems more reason to regret that Demades is not represented by larger

fragments. The decline of Attic oratory may be dated from Demetrius of Phalerum (318 B.C.), the pupil of Aristotle, and the first to introduce the custom of making speeches on imaginary subjects as practised in the rhetorical schools. Cicero names him as the first who impaired the vigour of the earlier eloquence, "preferring his own sweetness to the weight and dignity of his predecessors." He forms a connecting link between Athens and Alexandria, where he found refuge after his downfall and promoted the foundation of the famous library.

In later times oratory chiefly flourished in the coast and island settlements of Asia Minor, especially Rhodes. Here a new, florid style of oration arose, called the "Asiatic," which owed its origin to Hegesias of Magnesia (c. 250 B.C.).

The place of Plato in the history of Greek literature is as unique as his place in the history of Greek thought. The literary genius shown in the dialogues is many-sided: it includes dramatic power, remarkable skill in parody, a subtle faculty of satire, and, generally, a command over the finer tones of language. In passages of continuous exposition, where the argument rises into the higher regions of discussion, Plato's prose takes a more

decidedly poetical colouring—never florid or sentimental, however, but lofty and austere. In Plato's later works—such, for instance, as the *Leues*, *Timæus*, *Critias*—we can perceive that his style did not remain unaffected by the smooth literary prose which contemporary writers had developed. Aristotle's influence on the form of Attic prose literature would probably have been considerable if his *Rhetoric* had been published while Attic oratory had still a vigorous life before it. But in this, as in other departments of mental effort, it was Aristotle's lot to set in order what the Greek intellect had done in that creative period which had now come to an end. His own chief contribution to the original achievements of the race was the most fitting one that could have been made by him in whose lifetime they were closed. He bequeathed an instrument by which analysis could be carried further, he founded a science of reasoning, and left those who followed him to apply it in all those provinces of knowledge which he had mapped out.¹ Theophrastus, his pupil and his successor in the Lyceum, opens the new age of research and scientific classification with his extant works on botany, but is better known to modern readers by his lively *Characters*, the prototypes of such sketches in English literature as those of Hall, Overbury and Earle.

(C) *The Literature of the Decadence.*—The period of decadence in Greek literature begins with the extinction of free political life in the Greek cities. So long as the Greek commonwealths were independent and vigorous, Greek life rested on the identity of the man with the citizen.

The city state was the highest unit of social organisation; the whole training and character of the man were viewed relatively to his membership of the city. The market-place, the assembly, the theatre were places of frequent meeting, where the sense of citizenship was quickened, where common standards of opinion or feeling were formed. Poetry, music, sculpture, literature, art, in all their forms, were matters of public interest. Every citizen had some degree of acquaintance with them, and was in some measure capable of judging them. The poet and the musician, the historian and the sculptor, did not live a life of studious seclusion or engrossing professional work. They were, as a rule, in full sympathy with the practical interests of their time. Their art, whatever its form might be, was the concentrated and ennobled expression of their political existence. Aeschylus breathed into tragedy the inspiration of one who had himself fought the great fight of national liberation. Sophocles was the colleague of Pericles in a high military command. Thucydides describes the operations of the Peloponnesian War with the practical knowledge of one who had been in charge of a fleet. Ictinus and Phedias gave shape in stone, not to mere visions of the studio, but to the more glorious, because more

¹ His *Constitution of Athens* (q.v.), of which a papyrus MS. was found in Egypt and published in 1891, forms part of a larger work on the constitution of 138 Greek and foreign cities.

Philosophical prose—
Plato and Aristotle.

Character of the creative age.

real and vivid, perceptions which had been quickened in them by a living communion with the Athenian spirit, by a daily contemplation of Athenian greatness, in the theatre where tragic poets idealized the legends of the past, in the ecclesia where every citizen had his vote on the policy of the state, or in that free and gracious society, full of beauty, yet exempt from venetous constraint, which belonged to the age of Pericles. The tribunal which judged these works of literature or art was such as was best fitted to preserve the favourable conditions under which they arose. Criticism was not in the hands of a literary clique or of a social caste. The influence of jealousy or malevolence, and the more fatal influence of affectation, had little power to affect the verdict. The verdict was pronounced by the whole body of the citizens. The success or failure of a tragedy was decided, not by the minor circumstance that it gained the first or second prize, but by the collective opinion of the citizens assembled in the theatre of Dionysus. A work of architecture or sculpture was approved or condemned, not by the sentence of a few whom the multitude blindly followed, but by the general judgment of some twenty thousand persons, each of whom was in some degree qualified by education and by habit to form an independent estimate. The artist worked for all his fellow-citizens, and knew that he would be judged by all. The soul of his work was the fresh and living inspiration of nature; it was the ennobled expression of his own life; and the public opinion before which it came was free, intelligent and sincere.

Philip of Macedon did not take away the municipal independence of the Greek cities, but he dealt a death-blow to the old political life. The Athenian poet, historian, artist might still do good work, but he could never again have that which used to be the very mainspring of all such activity—the daily experience and consciousness of participation in the affairs of an independent state. He could no longer breathe the invigorating air of constitutional freedom, or of the social intercourse to which that freedom lent dignity as well as grace. Then came Alexander's conquests; Greek civilization was diffused over Asia and the East by means of Greek colonies in which Asiatic and Greek elements were mingled. The life of such settlements, under the monarchies into which Alexander's empire broke up, could not be animated by the spirit of the Greek commonwealths in the old days of political freedom. But the externals of Greek life were there—the temples, the statues, the theatres, the porticos. Ceremonies and festivals were conducted in the Greek manner. In private life Greek usages prevailed. Greek was the language most used; Greek books were in demand. The mixture of races would always in some measure distinguish even the outward life of such a community from that of a pure Greek state; and the facility with which Greek civilization was adopted would vary in different places. Syria, for example, was rapidly and completely Hellenized. Judaea resisted the process to the last. In Egypt a Greek aristocracy of office, birth and intellect existed side by side with a distinct native life. But, viewed in its broadest aspect, this new civilization may be called Hellenism. Hellenism (*q. s.*) means the adoption of Hellenic ways; and it is properly applied to a civilization, generally Hellenic in external things, pervading people not necessarily or exclusively Hellenic by race. What the Hellenic literature was to Hellas, that the Hellenistic literature was to Hellenism. The literature of Hellenism has the Hellenic form without the Hellenic soul. The literature of Hellas was creative; the literature of Hellenism is derivative.

Alexandria was the centre of Greek intellectual activity from Alexander to Augustus. Its "Museum," or college, and its library, both founded by the first Ptolemy (Soter), gave it such attractions for learned men as no other city could rival. The labours of research or arrangement are those which characterize the Alexandrian period. Even in its poetry spontaneous motive was replaced by erudite skill, as in the hymns, epigrams and elegies of Callimachus, in the enigmatic verses of Lycophron, in the highly finished epic of Apollonius Rhodius, and in the versified lore, astronomical or medical, of Aratus and

Nicanter. The mimes of Herodas (or Herondas) of Cos (*c.* 200 B.C.), written in the Ionic dialect and choliambic verse, represent scenes from everyday life. The papyrus (published in 1891) contains seven complete poems and fragments of an eighth. They are remarkably witty and full of shrewd observations, but at times coarse. The pastoral poetry of the age—Dorian by origin—was the most pleasing; for this, if it is to please at all, must have its spring in the contemplation of nature. Theocritus is not exempt from the artificialism of the Hellenizing literature; but his true sense of natural beauty entitles him to a place in the first rank of pastoral poets. Bion of Ionia and Moschus of Syracuse also charm by the music and often by the pathos of their bucolic verse. Excavations on the site of the temple of Asclepius at Epidaurus have brought to light two hexameter poems and a paean (in Ionic metre) on Apollo and Asclepius by a local poet named Isyllus, who flourished about 280. Tragedy was represented by the poets known as the Alexandrian *Pleiad*. But it is not for its poetry of any kind that this period of Greek literature is memorable. Its true work was in erudition and science. Aristarchus (136 B.C.), the greatest in a long line of Alexandrian critics, set the example of a more thorough method in revising and interpreting the ancient texts, and may in this sense be said to have become the founder of scientific scholarship. The critical studies of Alexandria, carried on by the followers of Aristarchus, gradually formed the basis for a science of grammar. The earliest Greek grammar is that of Dionysius Thrax (born *c.* 166), a pupil of Aristarchus. Translation was another province of work which employed the learned of Alexandria—where the Septuagint version of the Old Testament was begun, probably about 300-250 B.C. Chronology was treated scientifically by Eratosthenes, and was combined with history by Manetho in his chronicles of Egypt, and by Berossus in his chronicles of Chaldaea. Euclid was at Alexandria in the reign of Ptolemy Soter. Herophilus and Erasistratus were distinguished physicians and anatomists, and the authors of several medical works. The general results of the Alexandrian period might perhaps be stated *Summary*, thus. Alexandria produced a few eminent men of science, some learned poets (in a few cases, of great literary merit) and many able scholars. The preservation of the best Greek literature was due chiefly to the unremitting care of the Alexandrian critics, whose appreciation of it partly compensated for the decay of the old Greek perceptions in literature and art, and who did their utmost to hand it down in a form as free as possible from the errors of copyists. On the whole, the patronage of letters by the Ptolemies had probably as large a measure of success as was possible under the existing conditions; and it was afforded at a time when there was special danger that a true literary tradition might die out of the world.

The Græco-Roman period in the literature of Hellenism may be dated from the Roman subjugation of Greece. "Greece made a captive of the rough conqueror," but it did not follow from this intellectual conquest that Athens became once more the intellectual centre of the world. Under the empire, indeed, the university of Athens long enjoyed a pre-eminent reputation. But Rome gradually became the point to which the greatest workers in every kind were drawn. Greek literature had already made a home there before the close of the 2nd century B.C. Sulla brought a Greek library from Athens to Rome. Such men as Cicero and Atticus were indefatigable collectors and readers of Greek books. The power of speaking and writing the Greek language became an indispensable accomplishment for highly educated Romans. The library planned by Julius Caesar and founded by Augustus had two principal departments, one for Latin, the other for Greek works. Tiberius, Vespasian, Domitian and Trajan contributed to enlarge the collection. Rome became more and more the rival of Alexandria, not only as possessing great libraries, but also as a seat of learning at which Greek men of letters found appreciation and encouragement. Greek poetry, especially in its higher forms, rhetoric and literary criticism, history and philosophy, were all cultivated by Greek writers at Rome.

Erudition and science.

The transition to Hellenism.

The Græco-Roman period.

The Alexandrian period.

Poetry.

The first part of the Græco-Roman period may be defined as extending from 146 B.C. to the close of the Roman republic.

First part
146-30
B.C.
At its commencement stands the name of one who had more real affinity than any of his contemporaries with the great writers of old Athens, and who, at the same time, saw most clearly how the empire of the world was passing to Rome. The subject of Polybius (c. 205-120) was the history of Roman conquest from 204 to 146 B.C. His style, plain and straightforward, is free from the florid rhetoric of the time. But the distinction of Polybius is that he is the last Greek writer who in some measure retains the spirit of the old citizen-life. He chose his subject, not because it gave scope to learning or literary skill, but with a motive akin to that which prompted the history of Thucydides—namely, because, as a Greek citizen, he felt intensely the political importance of those wars which had given Rome the mastery of the world. The chief historical work which the following century produced—the *Universal History* of Diodorus Siculus (d. c. 50 B.C.)—resembled that of Polybius in recognizing Rome as the political centre of the earth, as the point on which all earlier series of events converged. In all else Diodorus represents the new age in which the Greek historian had no longer the practical knowledge and insight of a traveller, a soldier or a statesman, but only the diligence, and usually the dullness, of a laborious compiler.

The Greek literature of the Roman empire, from Augustus to Justinian, was enormously prolific. The area over which the Greek language was diffused—either as a medium of intercourse or as an established branch of the higher education—was co-extensive with the empire itself. An immense store of materials had now been accumulated, on which critics, commentators, compilers, imitators, were employed with incessant industry. In very many of its forms, the work of composition or adaptation had been reduced to a mechanical knack. If there is any one characteristic which broadly distinguishes the Greek literature of these five centuries, it is the absence of originality either in form or in matter. Lucian is, in his way, a rare exception; and his great popularity—he is the only Greek writer of this period, except Plutarch, who has been widely popular—illustrates the flatness of the arid level above which he stands out. The sustained abundance of literary production under the empire was partly due to the fact that there was no open political career. Never, probably, was literature so important as a resource for educated men; and the habit of reciting before friendly or obsequious audiences swelled the number of writers whose taste had been cultivated to a point just short of perceiving that they ought not to write.

In the manifold prose work of this period, four principal departments may be distinguished. (1) *History*, with *Biography*, *Departments of*
prose
literature. *History* is represented by Dionysius of Halicarnassus—also memorable for his criticisms on the orators and his effort to revive a true standard of Attic prose—by Cassius Dio, Josephus, Arrian, Appian, Herodian, Eusebius and Zosimus. In biography, the foremost names are Plutarch, Diogenes Laërtius and Philostratus; in geography, Hipparchus of Nicaea, Strabo, Ptolemy and Pausanias. (2) *Erudition and Science*. The learned labours of the Alexandrian schools were continued in all their various fields. Under this head may be mentioned such works as the lexicons of Julius Pollux, Harpocration and Hesychius, Hephaestion's treatise on metre, and Herodian's system of accentuation; the commentaries of Galen on Plato and on Hippocrates; the learned miscellanies of Athenæus, Aelian and Stobæus; and the *Stratagems* of Polyænus. (3) *Rhetoric and Belles-Lettres*. The most popular writers on the theory of rhetoric were Hermagoras, Hermogenes, Aphthonius and Cassius Longinus—the last the reputed author of the essay *On Sublimity*. Among the most renowned teachers of rhetoric—now distinctively called "Sophists," or rhetoricians—were Dio Chrysostom, Aelius Aristides, Themistius, Himerius, Libanius and Hærodes Atticus. Akin to the rhetorical exercises were

various forms of ornamental or imaginative prose—dialogues, letters, essays or novels. Lucian, in his dialogues, exhibits more of the classical style and of the classical spirit than any writer of the later age; he has also a remarkable affinity with the tone of modern satire, as in Swift or Voltaire. His Attic prose, though necessarily artificial, was at least the best that had been written for four centuries. The emperor Julian was the author both of orations and of satirical pieces. The chief of the Greek novelists (the forerunner of whom was Aristides of Miletus, c. 100 B.C., in his *Milesian Tales*) are Xenophon of Ephesus and Longus, representing a purely Greek type of romance, and Heliodorus—with his imitators Achilles Tatius and Chariton—representing a school influenced by Oriental fiction. There were also many Christian romances in Greek, usually of a religious tendency. Alciphron's fictitious *Letters*—founded largely on the New Comedy of Athens—represent the same kind of industry which produced the letters of Phalaris, Aristænetus and similar collections. (4) *Philosophy* is represented chiefly by Epictetus and Marcus Aurelius, in both of whom the Stoic element is the prevailing one; by the Neoplatonists, such as Plotinus, Porphyry, Iamblichus; and by Proclus, of that eclectic school which arose at Athens in the 5th century A.D.

The Greek poetry of this period presents no work of high merit. Babrius versified the *Aesopic Fables*; Oppian (or two poets of this name) wrote didactic poems on fishing *Verses* and hunting; Nonnus and Quintus Smyrnaeus made elaborate essays in epic verse; and the Orphic lore inspired some poems and hymns of a mystic character. The so-called *Sibylline Oracles*, in hexameter verse, range in date from about 170 B.C. to A.D. 700, and are partly the expression of the Jewish longings for the restoration of Israel, partly predictions of the triumph of Christianity. By far the most pleasing compositions in verse which have come to us from this age *The Anthology*, are some of the short poems in the Greek Anthology, which includes some pieces as early as the beginning of the 5th century B.C. and some as late as the 6th century of the Christian era.

The 4th century may be said to mark the beginning of the last stage in the decay of literary Hellenism. From that point the decline was rapid and nearly continuous. The attitude of the church towards it was no longer that which had been held by Clement of Alexandria, by Justin Martyr or by Origen. There was now a Christian Greek literature, and a Christian Greek eloquence of extraordinary power. The laity became more and more estranged from the Greek literature—however intrinsically pure and noble—of the pagan past. At the same time the Greek language—which had maintained its purity in Italian seats—was becoming corrupted in the new Greek Rome of the East. In A.D. 529 Justinian put forth an edict by which the schools of heathen philosophy were formally closed. The act had at least a symbolical meaning. It is necessary to guard against the supposition that such assumed landmarks in political or literary history always mark a definite transition from one order of things to another. But it is practically convenient, or necessary, to use such landmarks.

BIBLIOGRAPHY.—The first attempt at a connected history of Greek literature was the monumental and still indispensable work of J. A. Fabricius (14 vols., 1705-1728; new ed. in 12 vols. by G. C. Harless, 1790-1809); this was followed by F. Schöll's *Hist. de la littérature grecque* (1813). Both these works begin with the earliest times and go down to the latest period of the Byzantine empire. Of more modern and recent works the following may be mentioned: G. Bernhardt, *Grundriss der griechischen Literatur* (1836-1845; 4th ed., 1876-1880; 5th ed. of vol. I., by R. Volkmann, 1892), chiefly confined to the poets; C. O. Müller, *History of Greek Literature* (unfinished), written for the London Society for the Diffusion of Useful Knowledge, and published in English in 1840, the translation being by G. Cornwell Lewis and J. W. Donaldson (the latter completed the work to the end of the Byzantine period for the edition of 1858; the German text was published by E. Müller in 1841; 4th ed. by E. Heitz, 1882-1884); W. Mure, *Critical History of the Language and Literature of Ancient Greece* (1850-1857); T. Bergk, *Griechische Literaturgeschichte* (1872-1894, vols. 2, 3, ed. C. Hinrichs, vol. 4 by R. Feppmüller) containing epics,

lyric, drama down to Euripides, and the beginnings of prose; R. Nicolai, *Griechische Literaturgeschichte* (2nd ed., 1873-1878), useful for bibliography, but in other respects unsatisfactory; J. P. Mahaffy, *Hist. of Classical Greek Literature* (4th ed., 1903); A. and M. Croiset, *Hist. de la littérature grecque* (1887-1899, 2nd ed. 1896); W. Christ, *Geschichte der griechischen Literatur bis auf die Zeit Justinians* (4th ed., 1905; 5th ed., pt. i., by O. Stählin and W. Schmid, 1908), by far the most serviceable handbook for the student. F. Susemihl's *Geschichte der griechischen Literatur in der Alexandrinerzeit* (1891-1892) is especially valuable for its notes. Of smaller manuals the following will be found most useful: G. G. Murray, *History of Ancient Greek Literature* (1897); F. B. Jevons, *History of Greek Literature* (3rd ed., 1900) down to the time of Demosthenes; A. and M. Croiset, *Manuel d'hist. de la littérature grecque* (1900; Eng. trans. by G. F. Heffelbower, N.Y., 1904); also the general sketches by U. von Wilamowitz-Möllendorf in *Die Kultur der Gegenwart*, i. 9 (1905), by A. Gercke in the *Sammlung Göschke* (Leipzig, 2nd ed., 1905), and by R. C. Jobb in *Companion to Greek Studies* (Cambridge, 1908). Other works generally connected with the subject are: E. Hübner, *Bibliographie der klassischen Altertumswissenschaft* (2nd ed., 1889), pp. 161-171; W. Engelmann, *Bibliotheca scriptorum classicorum* (8th ed., by E. Preuss, 1880); J. B. Mayor, *Guide to the Choice of Classical Books* (1896), p. 86; W. Kroll, *Die Altertumswissenschaft im letzten Vierteljahrhundert 1875-1900* (1905), p. 465 foll.; J. E. Sandys, *History of Classical Scholarship* (1906-1908); "Bibliotheca philologica classica," in C. Bursian's *Jahresbericht über die Fortschritte der klassischen Altertumswissenschaft*; articles in Pauly-Wissowa's *Realencyclopädie der klassischen Altertumswissenschaft* (1894-).

(R. C. J.; X.)

II. BYZANTINE LITERATURE.

By "Byzantine literature" is generally meant the literature, written in Greek, of the so-called Byzantine period. There is no justification whatever for the inclusion of Latin works of the time of the East Roman empire. The close of the Byzantine period is clearly marked by the year 1453, at which date, with the fall of the Eastern empire, the peculiar culture and literary life of the Byzantines came to an end. It is only as regards the beginning of the Byzantine period that any doubts exist. There are no sufficient grounds for dating it from Justinian, as was formerly often done. In surveying the whole development of the political, ecclesiastical and literary life and of the general culture of the Roman empire, and particularly of its eastern portion, we arrive, on the contrary, at the conclusion that the actual date of the beginning of this new era—i.e. the Christian-Byzantine, in contradistinction to the Pagan-Greek and Pagan-Roman—falls within the reign of Constantine the Great. By the foundation of the new capital city of Constantinople (which lay amid Greek surroundings) and by the establishment of the Christian faith as the state religion, Constantine finally broke with the Roman-Pagan tradition, and laid the foundation of the Christian-Byzantine period of development. Moreover, in the department of language, so closely allied with that of literature, the 4th century marks a new epoch. About this time occurred the final disappearance of a characteristic of the ancient Greek language, important alike in poetry and in rhythmic prose, the difference of "quantity." Its place was henceforth taken by the accent, which became a determining principle in poetry, as well as for the rhythmic conclusion of the prose sentence. Thus the transition from the old musical language to a modern conversational idiom was complete.

The reign of Constantine the Great undoubtedly marks the beginning of a new period in the most important spheres of national life, but it is equally certain that in most of them ancient tradition long continued to exercise an influence. Sudden breaches of continuity are less common in the general culture and literary life of the world than in its political or ecclesiastical development. This is true of the transition from pagan antiquity to the Christian middle ages. Many centuries passed before the final victory of the new religious ideas and the new spirit in public and private intellectual and moral life. The last noteworthy remnants of paganism disappeared as late as the 6th and 7th centuries. The last great educational establishment which rested upon pagan foundations—the university of Athens—was not abolished till A.D. 529. The Hellenizing of the seat of empire and of the state, which was essential to the independent development of Byzantine

literature, proceeds yet more slowly. The first purely Greek emperor was Tiberius II. (578-582); but the complete Hellenizing of the character of the state had not been accomplished until the 7th century. We shall, therefore, regard the period from the 4th to the 7th century as that of the transition between ancient times and the middle ages. This period coincides with the rise of a new power in the world's history—Islam. But though, in this transitional period, the old and the new elements are both to a large extent present and are often inextricably interwoven, yet it is certain that the new elements are, both as regards their essential force and their influence upon the succeeding period, of infinitely greater moment than the decrepit and mostly artificial survivals of the antique.

In order to estimate rightly the character of Byzantine literature and its distinctive peculiarities, in contradistinction to ancient Greek, it is imperative to examine the great difference between the civilizations that produced them. The Byzantine did not possess the homogeneous, organically constructed system of the ancient civilization, but was the outcome of an amalgamation of which Hellenism formed the basis. For, although the Latin character of the empire was at first completely retained, even after its final division in 395, yet the dominant position of Greek in the Eastern empire gradually led to the Hellenizing of the state. The last great act of the Latin tradition was the codification, in the Latin language, of the law by Justinian (527-565). But it is significant that the *Novels* of Justinian were composed partly in Greek, as were all the laws of the succeeding period. Of the emperors in the centuries following Justinian, many of course were foreigners, Isaurians, Armenians and others; but in language and education they were all Greeks. In the last five centuries of the empire, under the Comneni and the Palaeologi, court and state are purely Greek.

In spite of the dominant position of Greek in the Eastern empire, a linguistic and national uniformity such as formed the foundation of the old Latin *Imperium Romanum* never existed there. In the West, with the expansion of Rome's political supremacy, the Latin language and Latin culture were everywhere introduced—first into the non-Latin provinces of Italy, later into Spain, Gaul and North Africa, and at last, even into certain parts of the Eastern empire. This Latinizing was so thorough that it weathered all storms, and in the countries affected by it, was the parent of new and vigorous nationalities, the French, the Spaniards, the Portuguese and the Rumanians. Only in Africa did "Latinism" fail to take root permanently. From the 6th century that province relapsed into the hands of the native barbarians and of the immigrant Arabs, and both the Latin and the Greek influences (which had grown in strength during the period of the Eastern empire) were, together with Christianity, swept away without leaving a trace behind. It might have been expected that the Hellenizing of the political system of the Eastern empire would have likewise entailed the Hellenizing of the non-Greek portions of the empire. Such, however, was not the case; for all the conditions precedent to such a development were wanting. The non-Greek portions of the Eastern empire were not, from the outset, gradually incorporated into the state from a Greek centre, as were the provinces in the West from a Latin centre. They had been acquired in the old period of the homogeneous Latin *Imperium*. In the centuries immediately following the division of the empire, the idea of Hellenizing the Eastern provinces could not take root, owing to the fact that Latin was retained, at least in principle, as the state language. During the later centuries, in the non-Greek parts, centrifugal tendencies and the destructive inroads of barbarians began on all sides; and the government was too much occupied with the all but impossible task of preserving the political unity of the empire to entertain seriously the wider aim of an assimilation of language and culture. Moreover, the Greeks did not possess that enormous political energy and force which enabled the Romans to assimilate foreign races; and, finally, they were confronted by sturdy Oriental, mostly Semitic, peoples, who were by no means so easy to subjugate as

Mixed character of Byzantine culture.

were the racially related inhabitants of Gaul and Spain. Their impotence against the peoples of the East will be still less hardly judged if we remember the fact already mentioned, that even the Romans were within a short period driven back and overwhelmed by the North African Semites who for centuries had been subjected to an apparently thorough process of Latinization.

The influence of Greek culture then, was very slight; how little indeed it penetrated into the oriental mind is shown by the fact that, after the violent Arab invasion in the south-east corner of the Mediterranean, the Copts and Syrians were able to retain their language and their national characteristics, while Greek culture almost completely disappeared. The one great instance of assimilation of foreign nationalities by the Greeks is the Hellenizing of the Slavs, who from the 6th century had migrated into central Greece and the Peloponnese. All other non-Greek tribes of any importance which came, whether for longer or for shorter periods, within the sphere of the Eastern empire and its civilization—such as the Copts, Syrians, Armenians, Georgians, Rumanians, Serbs, Bulgarians, Albanians—one and all retained their nationality and language. The complete Latinizing of the West has, accordingly, no counterpart in a similar Hellenizing of the East. This is clearly shown during the Byzantine period in the progress of Christianity. Everywhere in the West, even among the non-Romanized Anglo-Saxons, Irish and Germans, Latin maintained its position in the church services and in the other branches of the ecclesiastical system; down to the Reformation the church remained a complete organic unity. In the East, at the earliest period of its conversion to Christianity, several foreign tongues competed with Greek, i.e. Syrian, Coptic, Armenian, Georgian, Gothic, Old-Bulgarian and others. The sacred books were translated into these languages and the church services were held in them and not in Greek. One noticeable effect of this linguistic division in the church was the formation of various sects and national churches (cf. the Coptic Nestorians, the Syrian Monophysites, the Armenian and, in more recent times, the Slavonic national churches). The Church of the West was characterized by uniformity in language and in constitution. In the Eastern Church parallel to the multiplicity of languages developed also a corresponding variety of doctrine and constitution.

Though the character of Byzantine culture is mainly Greek, and Byzantine literature is attached by countless threads to ancient Greek literature, yet the Roman element forms a very essential part of it. The whole political character of the Byzantine empire is, despite its Greek form and colouring, genuinely Roman. Legislation and administration, the military and naval traditions, are old Roman work, and as such, apart from immaterial alterations, they continued to exist and operate, even when the state in head and limbs had become Greek. It is strange, indeed, how strong was the political conception of the Roman state (*Staatsgedanke*), and with what tenacity it held its own, even under the most adverse conditions, down to the latter days of the empire. The Greeks even adopted the name "Romans," which gradually became so closely identified with them as to supersede the name "Hellenes"; and thus a political was gradually converted into an ethnographical and linguistic designation. *Rhomaioi* was the most common popular term for Greeks during the Turkish period, and remains so still. The old glorious name "Hellenes" was used under the empire and even during the middle ages in a contemptuous sense—"Heathen"—and has only in quite modern times, on the formation of the kingdom of "Hellas," been artificially revived. The vast organization of the Roman political system could not but exercise in various ways a profound influence upon Byzantine civilization; and it often seemed as if Roman political principles had educated and nerved the unpolitical Greek people to great political enterprise. The Roman influence has left distinct traces in the Greek language, Greek of the Byzantine and modern period is rich in Latin terms for conceptions connected with the departments of justice, administration and the imperial court. In literature such

"barbarisms" were avoided as far as possible, and were replaced by Greek periphrases.

But by far the most momentous and radical change wrought on the old Hellenism was effected by Christianity; and yet the transition was, in fact, by no means so abrupt as one might be led to believe by comparing the Pagan-Hellenic culture of Plato's day with the Christian-Byzantine of the time of Justinian. For the path had been most effectually prepared for the new religion by the crumbling away of the ancient belief in the gods, by the humane doctrine of the Stoics, and, finally, by the mystic intellectual tendencies of Neoplatonism. Moreover, in many respects Christianity met paganism halfway by adapting itself to popular usages and ideas and by adopting important parts of the pagan literature. The whole educational system especially, even in Christian times, was in a very remarkable manner based almost entirely on the methods and material inherited from paganism. Next to the influences of Rome and of Christianity, that of the East was of importance in developing the Byzantine civilization, and in lending Byzantine literature its distinctive character. Much that was oriental in the Eastern empire dates

back to ancient times, notably to the period of Alexander the Great and his successors. Since the Greeks had at that period Hellenized the East to the widest extent, and had already founded everywhere flourishing cities, they themselves fell under the manifold influences of the soil they occupied. In Egypt, Palestine and Syria, in Asia Minor as far inland as Mesopotamia, Greek and oriental characteristics were often blended. In respect of the wealth and the long duration of its Greek intellectual life, Egypt stands supreme. It covers a period of nearly a thousand years from the foundation of Alexandria down to the conquest of Egypt by the Arabs (A.D. 643). The real significance of Egyptian Hellenism during this long period can be properly estimated only if a practical attempt be made to eliminate from the history of Greek literature and science in pagan and in Christian times all that owed its origin to the land of the Nile. The soil of Egypt proved itself especially productive of Greek literature under the Cross (Origen, Athanasius, Arius, Synesius), in the same way as the soil of North Africa was productive of Latin literature (Tertullian, Cyprian, Lactantius, Augustine). Monastic life, which is one of the chief characteristic elements of Christian-Byzantine civilization, had its birth in Egypt.

Syria and Palestine came under the influence of Greek civilization at a later date than Egypt. In these, Greek literature and culture attained their highest development between the 3rd and the 8th centuries of the Christian era. Antioch rose to great influence, owing at first to its pagan school of rhetoric and later to its Christian school of exegesis. Gaza was renowned for its school of rhetoric; Berytus for its academy of law. It is no mere accident that sacred poetry, aesthetically the most valuable class of Byzantine literature, was born in Syria and Palestine.

In Asia Minor, the cities of Tarsus, Caesarea, Nicaea, Smyrna, Ephesus, Nicopolis, &c., were all influential centres of Greek culture and literature. For instance, the three great fathers of Cappadocia, Basil, Gregory of Nyssa, and Gregory of Nazianzus all belonged to Asia Minor.

If all the greater Greek authors of the first eight centuries of the Christian era, i.e. the period of the complete development of Byzantine culture, be classified according to the countries of their birth, the significant fact becomes evident that nine-tenths come from the African and Asiatic districts, which were for the most part opened up only after Alexander the Great, and only one-tenth from European Greece. In other words, the old original European Greece was, under the emperors, completely outstripped in intellectual productive force by the newly founded African and Asiatic Greece. This huge tide of conquest which surged from Greece over African and Syrian territories occupied largely by foreign races and ancient civilizations, could not fail to be fraught with serious consequences for the Greeks themselves. The experience of the

Romans in their conquest of Greece (*Græcia capta ferum victorem cepit*) repeated itself in the conquest of the East by Greece, though to a minor extent and in a different way. The whole literature of Egypt, Syria and Asia Minor cannot, despite its international and cosmopolitan character, disavow the influence of the Oriental soil on which it was nourished. Yet the growth of too strong a local colouring in its literature was repressed, partly by the checks imposed by ancient Greek tradition, partly by the spirit of Christianity which reconciled all national distinctions. Even more clearly and unmistakably is Oriental influence shown in the province of Byzantine art, as Joseph Strzygowski has conclusively proved.

The greater portion of Greek literature from the close of ancient times down to the threshold of modern history was written in a language identical in its principal features with the common literary language, the so-called *Koinè*, which had its origin in the Alexandrian age. This is the literary form of Greek as a universal language, though a form that scintillates with many facets, from an almost Attic diction down to one that approaches the language of everyday life such as we have, for instance, in the New Testament. From what has been already said, it follows that this stable literary language cannot always have remained a language of ordinary life. For, like every living tongue, the vernacular Greek continually changed in pronunciation and form, as well as in vocabulary and grammar, and thus the living language surely and gradually separated itself from the rigid written language. This gulf was, moreover, considerably widened owing to the fact that there took place in the written language a retrograde movement, the so-called "Atticism." Introduced by Dionysius of Halicarnassus in the 1st century before Christ, this linguistic-literary fashion attained its greatest height in the 2nd century A.D., but still continued to flourish in succeeding centuries, and, indirectly, throughout the whole Byzantine period. It is true that it often seemed as though the living language would be gradually introduced into literature; for several writers, such as the chronicler Malalas in the 6th century, Leontius of Neapolis (the author of *Lives of Saints*) in the 7th century, the chronicler Theophanes at the beginning of the 9th century, and the emperor Constantine Porphyrogenitus in the 10th century, made in their writings numerous concessions to the living language. This progressive tendency might well have led, in the 11th and 12th centuries, to the founding in the Greek vernacular of a new literary language similar to the promising national languages and literature which, at that period, in the Romance countries, developed out of the despised popular idiom. In the case of the Byzantines, unfortunately, such a radical change never took place. All attempts in the direction of a popular reform of the literary language, which were occasionally made in the period from the 6th to the 10th centuries, were in turn extinguished by the resuscitation of classical studies, a movement which, begun in the 9th century by Photius and continued in the 11th by Psellus, attained its full development under the Comneni and the Palaeologi. This classical renaissance turned back the literary language into the old ossified forms, as had previously happened in the case of the Atticism of the early centuries of the empire. In the West, humanism (so closely connected with the Byzantine renaissance under the Comneni and the Palaeologi) also artificially reintroduced the "Ciceronian" Latin, but was unable seriously to endanger the development of the national languages, which had already attained to full vitality. In Byzantium, the humanistic movement came prematurely, and crushed the new language before it had fairly established itself. Thus the language of the Byzantine writers of the 11th-15th centuries is almost Old Greek in colour; artificially learnt by grammar, lexicon and assiduous reading, it followed Attic models more and more slavishly; to such an extent that, in determining the date of works, the paradoxical principle holds good that the more ancient the language, the more recent the author.

Owing to this artificial return to ancient Greek, the contrast that had long existed with the vernacular was now for the first

time fully revealed. The gulf between the two forms of language could no longer be bridged; and this fact found its expression in literature also. While the vulgarizing authors of the 6th-10th centuries, like the Latin-writing Franks (such as Gregory of Tours), still attempted a compromise between the language of the schools and that of conversation, we meet after the 12th century with authors who freely and naturally employed the vernacular in their literary works. They accordingly form the Greek counterpart of the oldest writers in Italian, French and other Romance languages. That they could not succeed like their Roman colleagues, and always remained the pariahs of Greek literature, is due to the all-powerful philological-antiquarian tendency which existed under the Comneni and the Palaeologi. Yet once more did the vernacular attempt to assert its literary rights, i.e. in Crete and some other islands in the 16th and 17th centuries. But this attempt also was foiled by the classical reaction of the 19th century. Hence it comes about that Greek literature even in the 20th century employs grammatical forms which were obsolete long before the 10th century. Thus the Greeks, as regards their literary language, came into a *cul de sac* similar to that in which certain rigidly conservative Oriental nations find themselves, e.g. the Arabs and Chinese, who, not possessing a literary language suited to modern requirements, have to content themselves with the dead Old-Arabic or the ossified Mandarin language. The divorce of the written and spoken languages is the most prominent and also the most fatal heritage that the modern Greeks have received from their Byzantine forefathers.

The whole Byzantine intellectual life, like that of the Western medieval period, is dominated by theological interests. Theology accordingly, in literature too, occupies the chief place, in regard to both quantity and quality. Next to it comes the writing of history, which the Byzantines cultivated with great conscientiousness until after the fall of the empire. All other kinds of prose writing, e.g. in geography, philosophy, rhetoric and the technical sciences, were comparatively neglected, and such works are of value for the most part only in so far as they preserve and interpret old material. In poetry, again, theology takes the lead. The poetry of the Church produced works of high aesthetic merit and enduring value. In secular poetry, the writing of epigrams especially was cultivated with assiduity and often with ability. In popular literature poetry predominates, and many productions worthy of notice, new both in matter and in form, are here met with.

The great classical period of Greek theological literature is that of the 4th century. Various factors contributed to this result—some of them positive, particularly the establishment of Christianity as the official religion and the protection accorded to it by the state, others negative, i.e. the heretical movements, especially Arianism, which at this period arose in the east of the empire and threatened the unity of the doctrine and organization of the church. It was chiefly against these that the subtle Athanasius of Alexandria directed his attacks. The learned Eusebius founded a new department of literature, church history. In Egypt, Antonius (St Anthony) founded the Greek monastic system; Synesius of Cyrene, like his greater contemporary Augustine in the West, represents both in his life and in his writings the difficult transition from Plato to Christ. At the centre, in the forefront of the great intellectual movement of this century, stand the three great Cappadocians, Basil the Great, the subtle dogmatist, his brother Gregory of Nyssa, the philosophically trained defender of the Christian faith, and Gregory of Nazianzus, the distinguished orator and poet. Closely allied to them was St Chrysostom, the courageous champion of ecclesiastical liberty and of moral purity. To modern readers the greater part of this literature appears strange and foreign; but, in order to be appreciated rightly, it must be regarded as the outcome of the period in which it was produced, a period stirred to its depths by religious emotions. For the times in which they lived and for their readers, the Greek fathers reached the highest attainable; though, of course, they produced nothing of such general human

General
character
of By-
zantine
literature.

Theology.

interest, nothing so deep and true, as the *Confessions* of St Augustine, with which the poetical autobiography of Gregory of Nazianzus cannot for a moment be compared.

The glorious bloom of the 4th century was followed by a perceptible decay in theological intellectual activity. Independent production was in succeeding centuries almost solely prompted by divergent dogmatical views and heresies, for the refutation of which orthodox authors were impelled to take up the pen. In the 5th and 6th centuries a more copious literature was called into existence by the Monophysites, who maintained that there was but *one* nature in Christ; in the 7th century by the Monothelites, who acknowledged but *one* will in Christ; in the 8th century by the Iconoclasts and by the new teaching of Mahomet. One very eminent theologian, whose importance it has been reserved for modern times to estimate aright—Leontius of Byzantium (6th century)—was the first to introduce Aristotelian definitions into theology, and may thus be called the first scholastic. In his works he attacked the heretics of his age, particularly the Monophysites, who were also assailed by his contemporary Anastasius of Antioch. The chief adversaries of the Monothelites were Sophronius, patriarch of Jerusalem (whose main importance, however, is due to his work in other fields, in hagiography and homiletics), Maximus the Confessor, and Anastasius Sinaites, who also composed an interpretation of the *Hexameron* in twelve books. Among writers in the departments of critical interpretation and asceticism in this period must be enumerated Procopius of Gaza, who devoted himself principally to the exegesis of the Old Testament; Johannes Climax (6th century), named after his much-read ascetic work *Klimax* (Jacob's ladder); and Johannes Moschus (d. 619), whose chief work *Leimon* ("spiritual pasture") describes monastic life in the form of statements and narratives of their experiences by monks themselves. The last great heresy, which shook the Greek Church to its very foundations, the Iconoclast movement, summoned to the fray the last great Greek theologian, John of Damascus (Johannes Damascenus). Yet his chief merits lie not so much in his polemical speeches against the Iconoclasts, and in his much admired but over-refined poetry, as in his great dogmatic work, *The Fountain of Knowledge*, which contains the first comprehensive exposition of Christian dogma. It has remained the standard work on Greek theology down to the present day. Just as the internal development of the Greek Church in all essentials reached its limit with the Iconoclasts, so also its productive intellectual activity ceased with John of Damascus. Such theological works as were subsequently produced, consisted mostly in the interpretation and revision of old materials. An extremely copious, but unfruitful, literature was produced by the disputes about the reunion of the Greek and Roman Churches. Of a more independent character is the literature which in the 14th century centred round the dimensions of the Hesychasts.

Among theologians after John of Damascus must be mentioned: the emperor Leo VI., the Wise (886-911), who wrote numerous homilies and church hymns, and Theodorus of Studium (759-826), who in his numerous writings affords us instructive glimpses of monastic life. Pre-eminent stands the figure of the patriarch Photius. Yet his importance consists less in his writings, which often, to a remarkable extent, lack independence of thought and judgment, than in his activity as a prince of the church. For he it was who carried the differences which had already repeatedly arisen between Rome and Constantinople to a point at which reconciliation was impossible, and was mainly instrumental in preparing the way for the separation of the Greek and Latin Churches accomplished in 1054 under the patriarch Michael Cerularius. In the 11th century the polyhistor Michael Pselus also wrote polemics against the Euchites, among whom the Syrian Gnosis was reviving. All literature, including theology, experienced a considerable revival under the Comneni. In the reign of Alexius I. Comnenus (1081-1118), Euthymius Zigabenus wrote his great dogmatic work, the *Dogmatic Panoply*, which, like *The Fountain of Knowledge* of John of Damascus in earlier times, was partly positive, furnishing an armoury of

theology, partly negative and directed against the sects. In addition to attacking the dead and buried doctrines of the Monothelites, Iconoclasts, &c., to fight which was at this time a mere tilting at windmills, Zigabenus also carried on a polemic against the heretics of his own day, the Armenians, Bogomils and Saracens. Zigabenus's *Panoply* was continued and enlarged a century later by the historian Nicetas Acominatus, who published it under the title *Treasure of Orthodoxy*. To the writings against ancient heresies were next added a flood of tracts, of all shapes and sizes, "against the Latins," i.e. against the Roman Church, and among their authors must also be enumerated an emperor, the gifted Theodore II. Lascaris (1254-1258). The chief champion of the union with the Roman Church was the learned Johannes Beccus (patriarch of Constantinople 1275-1282). Of his opponents by far the most eminent was Gregory of Cyprus, who succeeded him on the patriarchal throne. The fluctuations in the fortunes of the two ecclesiastical parties are reflected in the occupation of the patriarchal throne. The battles round the question of the union, which were waged with southern passion, were for a while checked by the dissensions aroused by the mystic tendency of the Hesychasts. The impetus to this great literary movement was given by the monk Barlaam, a native of Calabria, who came forward in Constantinople as an opponent of the Latins and was in 1339 entrusted by Andronicus III. with a mission to Pope Benedict XII. at Avignon. He condemned the doctrine of the Hesychasts, and attacked them both orally and in writing. Among those who shared his views are conspicuous the historian Nicephorus Gregoras and Gregorius Acindynus, the latter of whom closely followed Thomas Aquinas in his writings. In fact the struggle against the Hesychasts was essentially a struggle between sober western scholasticism and dreamy Graeco-Oriental mysticism. On the side of the Hesychasts fought Gregorius Palamas, who tried to give a dogmatic foundation to the mysticism of the Hesychasts, Cabasilas, and the emperor John VI. Cantacuzenus who, after his deposition, sought, in the peaceful retreat of a monastery, consolation in theological studies, and in his literary works refuted the Jews and the Mahomedans. For the greatest Byzantine "apologia" against Islamism we are indebted to an emperor, Manuel II. Palaeologus (1391-1425), who by learned discussions tried to make up for the deficiency in martial prowess shown by the Byzantines in their struggle with the Turks. On the whole, theological literature was in the last century of the empire almost completely occupied with the struggles for and against the union with Rome. The reason lay in the political conditions. The emperors saw more and more clearly that without the aid of the West they would no longer be able to stand their ground against the Turks, the vanguard of the armies of the Crescent; while the majority of Byzantine theologians feared that the assistance of the West would force the Greeks to unite with Rome, and thereby to forfeit their ecclesiastical independence. Considering the supremacy of the theological party in Byzantium, it was but natural that religious considerations should gain the day over political; and this was the view almost universally held by the Byzantines in the later centuries of the empire; in the words of the chronicler Ducas: "it is better to fall into the hands of the Turks than into those of the Franks." The chief opponent of the union was Marcus Eugenicus, metropolitan of Ephesus, who, at the Council of Florence in 1439, denounced the union with Rome accomplished by John VIII. Palaeologus. Conspicuous there among the partisans of the union, by reason of his erudition and general literary merit, was Bessarion, afterwards cardinal, whose chief activity already falls under the head of Graeco-Italian humanism.

Hagiography, i.e. the literature of the acts of the martyrs and the lives of the saints, forms an independent group and one comparatively unaffected by dogmatic struggles. The main interest centres here round the objects Hagiography. described, the personalities of the martyrs and saints themselves. The authors, on the other hand—the *Acts of the Martyrs* are mostly anonymous—keep more in the background than in other branches of literature. The man whose name is

mainly identified with Greek hagiography, Symeon Metaphrastes, is important not as an original author, but only as an editor. Symeon revised in the 10th century, according to the rhetorical and linguistic principles of his day, numerous old *Acts of the Martyrs*, and incorporated them in a collection consisting of several volumes, which was circulated in innumerable copies, and thus to a great extent superseded the older original texts. These *Acts of the Martyrs*, in point of time, are anterior to our period; but of the *Lives of Saints* the greater portion belong to Byzantine literature. They began with biographies of monks distinguished for their saintly living, such as were used by Palladius about 420 in his *Historia Lausiaca*. The most famous work of this description is that by Athanasius of Alexandria, viz. the biography of St Anthony, the founder of monachism. In the 6th century Cyril of Scythopolis wrote several lives of saints, distinguished by a simple and straightforward style. More expert than any one else in reproducing the naive popular style was Leontius of Neapolis in Cyprus who, in the 7th century, wrote, among other works, a life of St John the Merciful, archbishop of Alexandria, which is very remarkable as illustrating the social and intellectual conditions of the time. From the popular *Lives of Saints*, which for the reading public of the middle ages formed the chief substitute for modern "belles lettres," it is easy to trace the transition to the religious novel. The most famous work of this class is the history of BARLAAM AND JOSAPHRAT (q.v.).

The religious poetry of the Greeks primarily suffered from the influence of the ancient Greek form, which was fatal to original development. The oldest work of this class is the hymn, composed in anapaestic monometers and dimeters, which was handed down in the manuscripts with the *Pasdagogus* of Clement of Alexandria (d. about 215), but was probably not his work. The next piece of this class is the famous "Maidens' Song" in the *Banquet* of St Methodius (d. about 311), in which many striking violations of the old rules of quantity are already apparent. More faithful to the tradition of the schools was Gregory of Nazianzus. But, owing to the fact that he generally employed antiquated versification and very erudite language, his poems failed to reach the people or to find a place in the services of the church. Just as little could the artificial paraphrase of the Psalms composed by the younger Apollinarius, or the subtle poems of Synesius, become popular. It became more and more patent that, with the archaic metre which was out of keeping with the character of the living language, no genuine poetry suited to the age could possibly be produced. Fortunately, an entirely new form of poetical art was discovered, which conferred upon the Greek people the blessings of an intelligible religious poetry—the rhythmic poem. This no longer depended on difference of quantity in the syllables, which had disappeared from the living language, but on the accent. Yet the transition was not effected by the substitution of accent for the old long syllables; the ancient verse form was entirely abandoned, and in its stead new and variously constructed lines and strophes were formed. In the history of the rhythmic sacred poetry three periods are clearly marked—the preparatory period; that of the hymns; and that of the *Canones*. About the first period we know, unfortunately, comparatively little. It appears that in it church music was in the main confined to the insertion of short songs between the Psalms or other portions of Holy Writ and the acclamations of the congregation. The oldest rhythmic songs date from Gregory of Nazianzus—his "Maidens' Song" and his "Evening Hymn." Church poetry reached its highest expression in the second period, in the grand development of the hymns, i.e. lengthy songs comprising from twenty to thirty similarly constructed strophes, each connected with the next in acrostic fashion. Hymnology, again, attained its highest perfection in the first half of the 6th century with Romanos, who in the great number and excellence of his hymns dominated this species of poetry, as Homer did the Greek epic. From this period dates, moreover, the most famous song of the Greek Church, the so-called *Acatistis*, an anonymous hymn of praise to the Virgin Mary, which has

sometimes, but erroneously, been attributed to the patriarch Sergius.

Church poetry entered upon a new stage, characterized by an increase in artistic finish and a falling off in poetical vigour, with the composition of the *Canones*, songs artfully built up out of eight or nine lyrics, all differently constructed. Andreas, archbishop of Crete (c. 650-720), is regarded as the inventor of this new class of song. His chief work, "the great Canon," comprises no less than 250 strophes. The most celebrated writers of *Canones* are John of Damascus and Cosmas of Jerusalem, both of whom flourished in the first half of the 8th century. The "vulgar" simplicity of Romanos was regarded by them as an obsolete method; they again resorted to the classical style of Gregory of Nazianzus, and John of Damascus even took a special delight in the most elaborate tricks of expression. In spite of this, or perhaps on that very account, both he and Cosmas were much admired in later times, were much read, and—as was very necessary—much commented. Later, sacred poetry was more particularly cultivated in the monastery of the Studium at Constantinople by the abbot Theodorus and others. Again, in the 9th century, Joseph, "the hymn-writer," excelled as a writer of songs, and, finally, John Mauropus (11th century), bishop of Euchaita, John Zonaras (12th century), and Nicephorus Blemmydes (13th century), were also distinguished as authors of sacred poems, i.e. *Canones*. The Basilian Abbey of Grotta Ferrata near Rome, founded in 1004, and still existing, was also a nursery of religious poetry. As regards the rhythmic church poetry, it may now be regarded as certain that its origin was in the East. Old Hebrew and Syrian models mainly stimulated it, and Romanos (q.v.) was especially influenced by the metrical homilies of the great Syrian father Ephraem (d. about 373).

In profane literature the writing of history takes the first place, as regards both form and substance. The Greeks have always been deeply interested in history, and they have never omitted, amid all the vicissitudes of their existence, to hand down a record to posterity. Thus, they have produced a literature extending from the Ionian logographers and Herodotus down to the times of Sultan Mahommed II. In the Byzantine period all historical accounts fall under one of two groups, entirely different, both in form and in matter, (1) historical works, the authors of which described, as did most historians of ancient times, a period of history in which they themselves had lived and moved, or one which only immediately preceded their own times; and (2) chronicles, shortly recapitulating the history of the world. This latter class has no exact counterpart in ancient literature. The most clearly marked stage in the development of a Christian-Byzantine universal history was the chronicle (unfortunately lost) written by the Hellenized Jew, Justus of Tiberias, at the beginning of the 2nd century of the Christian era; this work began with the story of Moses.

Byzantine histories of contemporary events do not differ substantially from ancient historical works, except in their Christian colouring. Yet even this is often very faint and blurred owing to close adherence to ancient methods. Apart from this, neither a new style nor a new critical method nor any radically new views appreciably altered the main character of Byzantine historiography. In their style most Byzantine compilers of contemporary history followed the beaten track of older historians, e.g. Herodotus, Thucydides, and, in some details, also Polybius. But, in spite of their often excessive tendency to imitation, they displayed considerable power in the delineation of character and were not wanting in independent judgment. As regards the selection of their matter, they adhered to the old custom of beginning their narrative where their predecessors left off.

The outstripping of the Latin West by the Greek East, which after the close of the 4th century was a self-evident fact, is reflected in historiography also. After Constantine the Great, the history of the empire, although its Latin character was maintained until the 6th century, was mostly written by Greeks;

Religious poetry.

Profane literature Historical accounts.

e.g. Eusebius (c. 400), Olympiodorus (c. 490), Priscus (c. 450), Malchus (c. 490), and Zosimus, the last pagan historian (c. 500), all of whom, with the exception of Zosimus, are unfortunately preserved to us only in fragments. Historiography received a great impulse in the 6th century. The powerful Procopius and Agathias (q.v.), tinged with poetical rhetoric, described the stirring and eventful times of Justinian, while Theophanes of Byzantium, Menander Protector, Johannes of Epiphania and Theophylactus of Simocatta described the second half of the 6th century. Towards the close of the 6th century also flourished the last independent ecclesiastical historian, Evagrius, who wrote the history of the church from 431 to 593. There now followed, however, a lamentable falling off in production. From the 7th to the 10th century the historical side is represented by a few chronicles, and it was not until the 10th century that, owing to the revival of ancient classical studies, the art of writing history showed some signs of life. Several historical works are associated with the name of the emperor Constantine VII. Porphyrogenitus. To his learned circle belonged also Joseph Genesius, who at the emperor's instance compiled the history of the period from 813 to 886. A little work, interesting from the point of view of historical and ethnographical science, is the account of the taking of Thessalonica by the Cretan Corsairs (A.D. 904), which a priest, Johannes Cameniata, an eyewitness of the event, has bequeathed to posterity. There is also contained in the excellent work of Leo Diaconus (on the period from 959 to 975) a graphic account of the bloody wars of the Byzantines with the Arabs in Crete and with the Bulgarians. A continuation was undertaken by the philosopher Michael Psellus in a work covering the period from 976 to 1077. A valuable supplement to the latter (describing the period from 1034 to 1079) was supplied by the jurist Michael Attaliata. The history of the Eastern empire during the Crusades was written in four considerable works, by Nicephorus Bryennius, his learned consort Anna Comnena, the "honest Aetolian," Johannes Cinnamus, and finally by Nicetas Acominatus in an exhaustive work which is authoritative for the history of the 4th Crusade. The melancholy conditions and the ever increasing decay of the empire under the Palaeologi (13th-15th centuries) are described in the same lofty style, though with a still closer following of classical models. The events which took place between the taking of Constantinople by the Latins and the restoration of Byzantine rule (1203-1261) are recounted by Georgius Acropolita, who emphasizes his own share in them. The succeeding period was written by the versatile Georgius Pachymeres, the erudite and high-principled Nicephorus Gregoras, and the emperor John VI. Cantacuzenus. Lastly, the death-struggle between the East Roman empire and the mighty rising power of the Ottomans was narrated by three historians, all differing in culture and in style, Laonicus Chalcocondyles, Ducas and Georgius Phrantzes. With them may be classed a fourth (though he lived outside the Byzantine period), Critobulus, a high-born Greek of Imbros, who wrote, in the style of the age of Pericles, the history of the times of the sultan Mahommed II. (down to 1467).

The essential importance of the Byzantine chronicles (mostly chronicles of the history of the world from the Creation) consists in the fact that they in part replace older lost works, and thus fill up many gaps in our historical survey (e.g. for the period from about 600 to 800 of which very few records remain). They lay no claim to literary merit, but are often serviceable for the history of language. Many such chronicles were furnished with illustrations. The remains of one such illustrated chronicle on papyrus, dating from the beginning of the 5th century, has been preserved for us by the soil of Egypt.¹ The authors of the chronicles were mostly monks, who wished to compile handbooks of universal history for their brethren and for pious laymen; and this explains the strong clerical and popular tendency of these works. And it is due to

¹ See Ad. Bauer and J. Strzygowski, "Eine alexandrinische Weltchronik" (1905) (*Denkschrift der kaiserlich. Akademie der Wissenschaften*, ii.).

these two qualities that the chronicles obtained a circulation abroad, both in the West and also among the peoples Christianized from Byzantium, e.g. the Slavs, and in all of them sowed the seeds of an indigenous historical literature. Thus the chronicles, despite the jejune nature of their style and their uncritical treatment of material were for the general culture of the middle ages of far greater importance than the erudite contemporary histories designed only for the highly educated circles in Byzantium. The oldest Byzantine chronicle of universal history preserved to us is that of Malalas (6th century), which is also the purest type of this class of literature. In the 7th century was completed the famous *Easter or Paschal Chronicle* (*Chronicon Paschale*). About the end of the 8th or the beginning of the 9th century Georgius Syncellus compiled a concise chronicle, which began with the Creation and was continued down to the year 884. At the request of the author, when on his death-bed, the continuation of this work was undertaken by Theophanes Confessor, who brought down the account from A.D. 884 to his own times (A.D. 813). This exceedingly valuable work of Theophanes was again continued (from 813-961) by several anonymous chroniclers. A contemporary of Theophanes, the patriarch Nicephorus, wrote, in addition to a *Short History* of the period from 602 to 769, a chronological sketch from Adam down to the year of his own death in 829. Of great influence on the age that followed was Georgius Monachus, only second in importance as chronicler of the early Byzantine period, who compiled a chronicle of the world's history (from Adam until the year 843, the end of the Iconoclast movement), far more theological and monkish in character than the work of Theophanes. Among later chroniclers Johannes Scylitza stands out conspicuously. His work (covering the period from 811 to 1057), as regards the range of its subject-matter, is something between a universal and a contemporary history. Georgius Cedrenus (c. 1100) embodied the whole of Scylitza's work, almost unaltered, in his *Universal Chronicle*. In the 12th century the general increase in literary production was evident also in the department of chronicles of the world. From this period dates, for instance, the most distinguished and learned work of this class, the great universal chronicle of John Zonaras. In the same century Michael Glycas compiled his chronicle of the world's history, a work written in the old popular style and designed for the widest circles of readers. Lastly, in the 12th century, Constantine Manasses wrote a universal chronicle in the so-called "political" verse. With this verse-chronicle must be classed the imperial chronicle of Ephraem, written in Byzantine trimeters at the beginning of the 14th century.

Geography and topography, subjects so closely connected with history, were as much neglected by the Byzantines as by their political forerunners, the Romans. Of purely practical importance are a few handbooks of navigation, itineraries, guides for pilgrims, and catalogues of provinces and cities, metropolitan sees and bishoprics. The geographical work of Stephanus of Byzantium, which dates from Justinian's time, has been lost. To the same period belongs the only large geographical work which has been preserved to us, the *Christian Topography* of Cosmas Indicopleustes. For the topography of Constantinople a work entitled *Ancient History (Patria) of Constantinople*, which may be compared to the medieval *Mirabilia urbis Romae*, and in late manuscripts has been wrongly attributed to a certain Codinus, is of great importance.

Ancient Greek philosophy under the empire sent forth two new shoots—Neopythagoreanism and Neoplatonism. It was the latter with which moribund paganism essayed to stem the advancing tide of Christianity. The last great exponent of this philosophy was Proclus in Athens (d. 485). The dissolution, by order of Justinian, of the school of philosophy at Athens in 529 was a fatal blow to this nebulous system, which had long since outlived the conditions that made it a living force. In the succeeding period philosophical activity was of two main kinds; on the one hand, the old philosophy, e.g. that of Aristotle, was employed to systematize Christian

Geo-
graphy.

Philosophy.

doctrine, while, on the other, the old works were furnished with copious commentaries and paraphrases. Leontius of Byzantium had already introduced Aristotelian definitions into Christology; but the real founder of medieval ecclesiastical philosophy was John of Damascus. Owing, however, to his having early attained to canonical authority, the independent progress of ecclesiastical philosophy was arrested; and to this it is due that in this respect the later Byzantine period is far poorer than is the West. Byzantium cannot boast a scholastic like Thomas Aquinas. In the 11th century philosophical studies experienced a satisfactory revival, mainly owing to Michael Psellus, who brought Plato as well as Aristotle again into fashion.

Ancient rhetoric was cultivated in the Byzantine period with greater ardour than scientific philosophy, being regarded as an indispensable aid to instruction. It would be difficult to imagine anything more tedious than the numerous theoretical writings on the subject and the examples of their practical application: mechanical school essays, which here count as "literature," and innumerable letters, the contents of which are wholly insignificant. The evil effects of this were felt beyond the proper sphere of rhetoric. The anxious attention paid to the laws of rhetoric and the unrestricted use of its withered flowers were detrimental to a great part of the rest of Byzantine literature, and greatly hampered the development of any individuality and simplicity of style. None the less, among the rhetorical productions of the time are to be found a few interesting pieces, such as the *Philopatris*, in the style of Lucian, which gives us a remarkable picture of the times of Nicephorus Phocas (10th century). In two other smaller works a journey to the dwellings of the dead is described, after the pattern of Lucian's *Nekyomanteia*, viz. in *Timarion* (12th century) and in Mazaris' *Journey to the Underworld* (c. 1414). A very charming representative of Byzantine rhetoric is Michael Acominatus, who, in addition to theological works, wrote numerous occasional speeches, letters and poems.

In the field of scientific production, which can be accounted literature in the modern acceptance of the term only in a limited sense, Byzantium was dominated to an extravagant and even grotesque extent by the rules of what in modern times is termed "classical scholarship."

The numerous works which belong to this category, such as grammars, dictionaries, commentaries on ancient authors, extracts from ancient literature, and metrical and musical treatises, are of little general interest, although of great value for special branches of philological study, e.g. for tracing the influences through which the ancient works handed down to us have passed, as well as for their interpretation and emendation; for information about ancient authors now lost; for the history of education; and for the underlying principles of intellectual life in Byzantium. The most important monument of Byzantine philology is, perhaps, the *Library* of the patriarch Photius. The period from about 650 to 850 is marked by a general decay of culture. Photius, who in the year 850 was about thirty years of age, now set himself with admirable energy to the task of making ancient literature, now for the most part dead and forgotten, known once more to his contemporaries, thus contributing to its preservation. He gave an account of all that he read, and in this way composed 280 essays, which were collected in what is commonly known as the *Library* or *Myriobiblon*. The character of the individual sketches is somewhat mechanical and formal; a more or less complete account of the contents is followed by critical discussion, which is nearly always confined to the linguistic form. With this work may be compared in importance the great *Lexikon* of Suidas, which appeared about a century later, a sort of encyclopaedia, of which the main feature was its articles on the history of literature. A truly sympathetic figure is Eustathius, the famous archbishop of Thessalonica (12th century). His voluminous commentaries on Homer, however, rivet the attention less than his enthusiastic devotion to science, his energetic action on behalf of the preservation of the literary works of antiquity, and last, not least, his frank and heroic character, which had

nothing in it of the Byzantine. If, on the other hand, acquaintance with a caricature of Byzantine philology be desired, it is afforded by Johannes Tzetzes, a contemporary of Eustathius, a Greek in neither name nor spirit, narrow-minded, angular, superficial, and withal immeasurably conceited and ridiculously coarse in his polemics. The transition to Western humanism was effected by the philologists of the period of the Palaeologi, such as Maximus Planudes, whose translations of numerous works renewed the long-broken ties between Byzantium and the West; Manuel Moschopoulos, whose grammatical works and commentaries were, down to the 16th century, used as school text-books; Demetrius Triclinius, distinguished as a textual critic; the versatile Theodorus Metochites, and others.

Originally, as is well known, Latin was the exclusive language of Roman law. But with Justinian, who codified the laws in his *Corpus juris*, the Hellenizing of the legal language also began. The *Institutes* and the *Digest* were translated into Greek, and the *Novels* also were issued in a Greek form. Under the Macedonian dynasty there began, after a long stagnation, the resuscitation of the code of Justinian. The emperor Basilus I. (867-886) had extracts made from the existing law, and made preparations for the codifying of all laws. But the whole work was not completed till the time of Leo VI. the Wise (886-912), and Constantine VII. Porphyrogenitus (912-959), when it took the form of a grand compilation from the *Digests*, the *Codex*, and the *Novels*, and is commonly known as the *Basilica* (*Ἡ Βασιλική*). In the East it completely superseded the old Latin *Corpus juris* of Justinian. More that was new was produced, during the Byzantine period, in canon law than in secular legislation. The purely ecclesiastical rules of law, the *Canones*, were blended with those of civil law, and thus arose the so-called *Nomocanon*, the most important edition of which is that of Theodorus Bestes in 1090. The alphabetical handbook of canon law written by Mattheus Blastares about the year 1335 also exercised a great influence.

In the province of mathematics and astronomy the remarkable fact must be recorded that the revival among the Greeks of these long forgotten studies was primarily due to Perso-Arabian influence. The *Great Synaxis* of Ptolemy operated in the oriental guise of the *Almagest*. The most important direct source of this intellectual loan was not Arabia, however, but Persia. Towards the close of the 13th century the Greeks became acquainted with Persian astronomy. At the beginning of the 14th century Georgius Chrysococca and Isaac Argyrus wrote astronomical treatises based on Persian works. Then the Byzantines themselves, notably Theodorus Metochites and Nicephorus Gregoras, at last had recourse to the original Greek sources.

The Byzantines did much independent work in the field of military science. The most valuable work of the period on this subject is one on tactics, which has come down to posterity associated with the name of Leo VI., the Wise.

Of profane poetry—in complete contrast to sacred poetry—the general characteristic was its close imitation of the antique in point of form. All works belonging to this category reproduce the ancient style and are framed after ancient models. The metre is, for the most part, either the Byzantine regular twelve-syllable trimeter, or the "political" verse; more rarely the heroic and Anacreontic measures.

Epic popular poetry, in the ancient sense, begins only with the vernacular Greek literature (see below); but among the literary works of the period there are several which can be compared with the epics of the Alexandrine age. Nonnus (c. 400) wrote, while yet a pagan, a fantastic epic on the triumphal progress of the god Dionysus to India, and, as a Christian, a voluminous commentary on the gospel of St. John. In the 7th century, Georgius Pisides sang in several lengthy iambic poems the martial deeds of the emperor Heraclius, while the deacon Theodosius (10th century) immortalized in extravagant language the victories of the brave Nicephorus Phocas.

Rhetoric.

Jurisprudence.

The sciences.

Mathematics and astronomy.

Military science.

Profane poetry.

Epic.

From the 11th century onwards, religious, grammatical, astrological, medical, historical and allegorical poems, framed partly in duodecasyllables and partly in "political" verse, made their appearance in large quantities. Didactic religious poems were composed, for example, by Philippus (*ὁ Μωβρῶπος*, Sofitarius, c. 1100), grammatico-philological poems by Johannes Tzetzes, astrological by Johannes Camaterus (12th century), others on natural science by Manuel Philes (14th century) and a great moral, allegorical, didactic epic by Georgius Laphites (14th century).

To these may be added some voluminous poems, which in style and matter must be regarded as imitations of the ancient Greek romances. They all date from the 12th century, a fact evidently connected with the general revival of culture which characterizes the period of the Comneni. Two of these romances are written in the duodecasyllable metre, viz. the story of Rodanthe and Dosicles by Theodorus Prodromus, and an imitation of this work, the story of Drusilla and Charicles by Nicetas Eugenianus; one in "political" verse, the love story of Aristander and Callithea by Constantine Manasses, which has only been preserved in fragments, and lastly one in prose, the story of Hysmine and Hysminias, by Eustathius (or Eumathius) Macrembolita, which is the most insipid of all.

The objective point of view which dominated the whole Byzantine period was fatal to the development of a profane lyrical poetry. At most a few poems by Johannes Lyrica. Geometres and Christophorus of Mytilene and others, in which personal experiences are recorded with some show of taste, may be placed in this category. The dominant form for all subjective poetry was the epigram, which was employed in all its variations from playful trifles to long elegiac and narrative poems. Georgius Pisides (7th century) treated the most diverse themes. In the 9th century Theodorus of Studium had lighted upon the happy idea of immortalizing monastic life in a series of epigrams. The same century produced the only poetess of the Byzantine period, Casia, from whom we have several epigrammatic productions and church hymns, all characterized by originality. Epigrammatic poetry reached its highest development in the 10th and 11th centuries, in the productions of Johannes Geometres, Christophorus of Mytilene and John Mauropus. Less happy are Theodorus Prodromus (12th century) and Manuel Philes (14th century). From the beginning of the 10th century also dates the most valuable collection of ancient and of Byzantine epigrammatic poems, the *Anthologia Palatina* (see ANTHOLOGY).

Dramatic poetry, in the strict sense of the term, was as completely lacking among the Byzantine Greeks as was the condition precedent to its existence, namely, public performance. Apart from some moralizing allegorical dialogues (by Theodorus Prodromus, Manuel Philes and others), we possess only a single work of the Byzantine period that, at least in external form, resembles a drama: the *Sufferings of Christ* (*Χριστὸς Πάσχω*). This work, written probably in the 12th century, or at all events not earlier, is a cento, i.e. is in great measure composed of verses culled from ancient writers, e.g. Aeschylus, Euripides and Lycophron; but it was certainly not written with a view to the dramatic production.

The vernacular literature stands alone, both in form and in contents. We have here remarkable originality of conception and probably also entirely new and genuinely medieval matter. While in the artificial literature prose is pre-eminent, in the vernacular literature, poetry, both in quantity and quality, takes the first place, as was also the case among the Latin nations, where the vulgar tongue first invaded the field of poetry and only later that of prose. Though a few preliminary attempts were made (proverbs, acclamations addressed by the people to the emperor, &c.), the Greek vernacular was employed for larger works only from the 12th century onwards; at first in poems, of which the major portion were cast in "political" verse, but some in the trochaic eight-syllabled line. Towards the close of the 15th century rhyme came into use. The subjects treated in this vernacular

poetry are exceedingly diverse. In the capital city a mixture of the learned and the popular language was first used in poems of admonition, praise and supplication. In this oldest class of "vulgar" works must be reckoned the *Spangas*, an admonitory poem in imitation of the letter of Pseudo-Isocrates addressed to Demonicus; a supplicatory poem composed in prison by the chronicler Michael Glycas, and several begging poems of Theodorus Prodromus (Ptochoprodromos). In the succeeding period erotic poems are met with, such as the Rhodian love songs preserved in a MS. in the British Museum (ed. W. Wagner, Leipzig, 1879), fairy-tale like romances such as the *Story of Ptocholeon*, oracles, prayers, extracts from Holy Writ, lives of saints, &c. Great epic poems, in which antique subjects are treated, such as the legends of Troy and of Alexander, form a separate group. To these may be added romances in verse after the manner of the works written in the artificial classical language, e.g. *Callimachus* and *Chrysochoros*, *Bethandrus* and *Chrysausa*, *Lybistrus* and *Rhodanne*, also romances in verse after the Western pattern, such as *Phlorius* and *Platsiaphora* (the old French story of *Florie et Blanche fleur*). Curious are also sundry legends connected with animals and plants, such as an adaptation of the famous medieval animal fables of the *Physiologus*, a history of quadrupeds, and a book of birds, both written with a satirical intention, and, lastly, a rendering of the story of Reynard the Fox. Of quite peculiar originality also are several legendary and historical poems, in which famous heroes and historical events are celebrated. There are, for instance, poems on the fall of Constantinople, the taking of Athens and Trebizond, the devastating campaign of Timur, the plague in Rhodes in 1498, &c. In respect of importance and antiquity the great heroic epic of Digenis Akritas stands pre-eminent.

Among prose works written in the vulgar tongue, or at least in a compromise with it, may be mentioned the Greek rendering of two works from an Indian source, the *Book of the Seven Wise Masters* (as *Syntipas the Philosopher* by Michael Andreopolus), and the *Hypodera* or *Mirror of Princes* (through the Arabic *Kalilah and Dimnah* by Simeon Sethus as *Στεφανῆρος καὶ Ἰωνῆδῆρος*), a fish book, a fruit book (both skits on the Byzantine court and official circles). To these must be added the Greek laws of Jerusalem and of Cyprus of the 12th and 13th centuries, chronicles, &c. In spite of many individual successes, the literature written in the vulgar tongue succumbed, in the race for existence, to its elder sister, the literature written in classical and polished Greek. This was mainly due to the continuous employment of the ancient language in the state, the schools and the church.

The importance of Byzantine culture and literature in the history of the world is beyond dispute. The Christians of the East Roman empire guarded for more than a thousand years the intellectual heritage of antiquity against the violent onslaught of the barbarians. They also called into life a peculiar medieval culture and literature. They communicated the treasures of the old pagan as well as of their own Christian literature to neighbouring nations; first to the Syrians, then to the Copts, the Armenians, the Georgians; later, to the Arabians, the Bulgarians, the Serbs and the Russians. Through their teaching they created a new East European culture, embodied above all in the Russian empire, which, on its religious side, is included in the Orthodox Eastern Church, and from the point of view of nationality touches the two extremes of Greek and Slav. Finally the learned men of the dying Byzantine empire, fleeing from the barbarism of the Turks, transplanted the treasures of old Hellenic wisdom to the West, and thereby fertilized the Western peoples with rich germs of culture.

BIBLIOGRAPHY.—1. General sources: K. Krumbacher, *Geschichte der byzantinischen Literatur* (2nd ed., 1897), supplemented in *Die byzantinische Zeitschrift* (1892 seq.), and the *Byzantinisches Archiv* (1898 seq.), which is intended for the publication of more exhaustive matter. The Russian works in this department are comprised in the *Vizantijsky Vremennik* (1894 seq.).

2. Language: Grammar: A. N. Janmaris (Ghanaris). A

Historical Greek Grammar (1897); A. Dieterich, "Untersuchungen zur Geschichte der griechischen Sprache von der hellenistischen Zeit bis zum toten Jahrhundert," in *Byzant. Archiv*, i. (1898). Glossary: Ducauge, *Glossarium ad scriptores medios et infimae Graecitatis* (1688), in which particular attention is paid to the vulgar language; E. A. Sophocles, *Greek Lexicon of the Roman and Byzantine Periods* (3rd ed., 1888).

3. Theology: Chief work, A. Ehrhard in Krumbacher's *Geschichte der byz. Lit.* pp. 1-218. For the ancient period, cf. the works on Greek patology (under article FATHERS OF THE CHURCH). Collective edition of the Fathers (down to the 15th century); *Patrologia, series Graeca* (ed. by Migne, 161 vols., 1857-1866). Church poetry: A collection of Greek Church hymns was published by W. Christ and M. Parantikas, entitled *Anthologia Graeca carminum Christianorum* (1871). Many unedited texts, particularly the songs of Romanos, were published by Cardinal J. B. Pitra, under the title *Analecta sacra spicilegio Silesimensi parata* (1876). A complete edition of the hymns is edited by K. Krumbacher.

4. Historical literature: A collective edition of the Byzantine historians and chroniclers was begun under Louis XIV., and continued later (1648-1819); called the *Paris Corpus*. This whole collection was on B. G. Niebuhr's advice republished with some additions (Bonn, 1828-1878), under the title *Corpus scriptorum historiae Byzantinae*. The most important authors have also appeared in the *Bibliotheca Teubneriana*. A few Byzantine and oriental historical works are also contained in the collection edited by J. B. Bury (1898 seq.).

5. Vernacular Greek literature: The most important collective editions are: W. Wagner, *Medieval Greek Texts* (1870), *Carmina Graeca Mediae Aevi* (1874), *Trois Poemes grecs du moyen age* (1881); E. Legrand, *Collection de monuments pour servir à l'étude de la langue néo-hellénique* (in 26 parts, 1869-1875), *Bibliothèque grecque vulgaire* (in 8 vols., 1880-1896). (K. Kr.)

III. MODERN GREEK LITERATURE (1453-1908)

After the capture of Constantinople, the destruction of Greek national life and the almost total effacement of Greek civilization naturally involved a more or less complete cessation of Greek literary production in the regions subjected to the rule of a barbarous conqueror. Learned Greeks found a refuge away from their native land; they spoke the languages of foreign people, and when they wrote books they often used those languages, but in most cases they also wrote in Greek. The fall of Constantinople must not therefore be taken as indicating a break in the continuity of Greek literary history. Nor had that event so decisive an influence as has been supposed on the revival of learning in western Europe. The crusades had already brought the Greeks and Westerners together, and the rule of the Franks at Constantinople and in the Levant had rendered the contact closer. Greeks and Latins had keenly discussed the dogmas which divided the Eastern and Western Churches; some Greeks had adopted the Latin faith or had endeavoured to reconcile the two communions, some had attained preferment in the Roman Church. Many had become connected by marriage or other ties with the Italian nobles who ruled in the Aegean or the Heptanesos, and circumstances led them to settle in Italy. Of the writers who thus found their way to the West before the taking of Constantinople the most prominent were Leon or Leontios Pilatos, Georgius Gemistus, or Pletho, Manuel and John Chrysoloras, Theodore Gazes, George of Trebizond and Cardinal Bessarion.

The Ottoman conquest had reduced the Christian races in the plains to a condition of serfdom, but the spirit of liberty continued to breathe in the mountains, where groups of desperate men, the Klephts and the Haiduks, maintained the struggle against alien tyranny. The adventurous and romantic life of these champions of freedom, spent amid the noblest solitudes of nature and often tinged with the deepest tragedy, naturally produced a poetry of its own, fresh, spontaneous and entirely indigenous. The Klephtic ballads, all anonymous and composed in the language of the people, are unquestionably the best and most genuine Greek poetry of this epoch. They breathe the aroma of the forests and mountains; like the early rhapsodies of antiquity, which peopled nature with a thousand forms, they lend a voice to the trees, the rocks, the rivers and to the mountains themselves, which sing the prowess of the Klepht, bewail his death and comfort his disconsolate wife or mother. Olympia boasts to

The Klephtic poetry.

Ossa that the footstep of the Turk has never desecrated its valleys; the standard of freedom floats over its springs; there is a Klepht beneath every tree of its forests; an eagle sits on its summit with the head of a warrior in its talons. The dying Klepht bids his companions make him a large and lofty tomb that he may stand therein and load his musket: "Make a window in the side that the swallows may tell me that spring has come, that the nightingales may sing me the approach of flowery May." The wounded Vervos is addressed by his horse: "Rise, my master, let us go and find our comrades." "My bay horse, I cannot rise; I am dying: dig me a tomb with thy silver-shod hoof; take me in thy teeth and lay me therein. Bear my arms to my companions and this handkerchief to my beloved, that she may see it and lament me." Another type of the popular poetry is presented by the folk-songs of the Aegean islands and the maritime population of the Asiatic coast. In many of the former the influence of the Frankish conquest is apparent. Traces of the ancient mythology are often to be found in the popular songs. Death is commonly personified by Charon, who struggles with his victim; Charon is sometimes worsted, but as a rule he triumphs in the conflict.

In Crete, which for nearly two centuries after the fall of Constantinople remained under Venetian rule, a school of Greek poetry arose strongly impressed with Italian influences.

The language employed is the dialect of the Candiotis, with its large admixture of Venetian words. The first product of this somewhat hybrid literature was *Erotocritos*, an epic poem in five cantos, which relates the love story of Areté, daughter of Hercules, king of Athens, and Erotocritos, the son of his minister. The poem presents an interesting picture of Greece under the feudal Frankish princes, though professing to describe an episode of the classical epoch; notwithstanding some tedious passages, it possesses considerable merit and contains some charming scenes. The metre is the rhymed alexandrine. Of the author, Vicence Cornaro, who lived in the middle or end of the 16th century, little is known; he probably belonged to the ducal family of that name, from which Tasso was descended. The second poem is the *Erophile* of George Chortakis, a Cretan, also written in the Candiotis dialect. It is a tragic drama, the scene of which is laid in Egypt. The dialogue is poor, but there are some fine choral interludes, which perhaps are by a different hand. Chortakis, who was brought up at Retimo, lived at the end of the 16th and beginning of the 17th centuries. The third Cretan poem worthy of notice is the *Shepherdess*, a charming and graceful idyll written by Nicolas Drimyticos, a native of Apokorona, early in the 17th century. Other Cretan poets were J. Gregoropoulos and G. Melissinos (1500), who wrote epigrams, and Maroulos (1493), who endeavoured to write Pindaric odes.

Among the Greeks who were prominent in spreading a knowledge of Greek in Europe after the fall of Constantinople were John Argyropoulos, Demetrius Chalcondyles, Constantine and John Lascaris and Marcus Musurus, a Cretan. These men wrote in the accepted literary language; in general, however, they were rather employed about literature than engaged in producing it. They taught Greek; several of them wrote Greek grammars; they transcribed and edited Greek classical writers, and they collected manuscripts. Their stores enriched the newly founded libraries of St. Mark at Venice, of the Escorial, of the Vatican and of the National Library in Paris. But none of them accomplished much in literature strictly so called. The question which most deeply interested them was that of the rival merits of the Platonic and Aristotelian philosophies, over which a controversy of extraordinary bitterness broke out towards the close of the 15th century. The dispute was in reality theological rather than philosophical; the cause of Plato was championed by the advocates of a union between the Eastern and Western Churches, that of Aristotle was upheld by the opposing party, and all the fury of the old Byzantine dogmatic controversies was revived. The patriarch, George Kurtesios or Gennadius, whom Mahommed II. had appointed after the capture of

Cretean poets.

Literary activity after the fall of Constantinople.

Constantinople, wrote a treatise in favour of Aristotle and excommunicated Gemistus Pletho, the principal writer among the Platonists. On the other hand, George of Trebizond, who attacked Pletho with unmeasured virulence, was compelled to resign his post of secretary to Pope Nicholas V. and was imprisoned by Pope Paul I. Scholarship was not wholly extinct in Greece or among the Greeks for a considerable time after the Turkish conquest. Arsenius, who succeeded Musurus as bishop of Mousermvasia (1510), wrote commentaries on Aristophanes and Euripides; his father, Apostolos, made a collection of Greek proverbs. Aemilius Portos, a Cretan, and Leo Allatios (1600-1650) of Chios edited a number of works of the classical and later periods with commentaries and translations; Allatios also wrote Greek verses showing skill and cleverness. Constantine Rhodokanakes, physician to Charles II. of England, wrote verses on the return of that monarch to England. About the time of the fall of Constantinople we meet with some versifiers who wrote poems in the spoken dialect on historical subjects; among these were Paspaspondylos Zoticos (1444), Georgilas Limenitis (1450-1500) and Jacobos Trivoles (beginning of the 16th century); their poems have little merit, but are interesting as specimens of the popular language of the day and as illustrating the manners and ideas of contemporary Greeks.

Among the prose writers of the 16th century were a number of chroniclers. At the end of the 15th, Kritobulos of Imbros, who had been private secretary of Mahommed II., wrote the history of his master, Emmanuel Melaxos a history of the patriarchate, and Phranzes a history of the Palaeologi. Theodosius Zygomalas (1580) wrote a history of Constantinople from 1301 to 1578. In the 17th century Demetrius Cantemir, a Moldavian by birth, wrote a history of the Ottoman empire, and G. Kontares tales of ancient Athens. Others composed chronicles of Cyprus and Crete, narratives of travels and biographies of saints. Most of these works are written in the literary language, the study of which was kept alive by the patriarchate and the schools which it maintained at Constantinople and elsewhere. Various theological and philosophical works, grammars and dictionaries were written during this period, but elegant literature practically disappears.¹

A literary revival followed in the 18th century, the precursor of the national uprising which resulted in the independence of Greece. The efforts of the great Phanariote families at Constantinople, the educational zeal of the higher Greek clergy and the munificence of wealthy Greeks in the provinces, chiefly merchants who had acquired fortunes by commerce, combined to promote the spread of education among a people always eager for instruction. The Turks, indifferent to educational matters, failed to discern the significance of the movement. Schools were established in every important Greek town, and school-books and translations from Western languages issued from the presses of Venice, Trieste, Vienna and other cities where the Greeks possessed colonies. Young men completed their studies in the Western universities and returned to the East as the missionaries of modern civilization. For the greater part of the 18th century the literature was mainly theological. Notable theological writers of this epoch were Elias Miniates, an elegant preacher, whose sermons are written in the popular language, and Meletios of Iannina, metropolitan of Athens, whose principal works were an ecclesiastical history, written in ancient Greek, and a descriptive geography of Greece in the modern language, composed, like the work of Pausanias, after a series of tours. The works of two distinguished prelates, both natives of Corfu and both ardent partisans of Russia, Nikephoros Theotokos (1737?-1800) and Eugenios Bulgares (1715-1806), mark the beginning of the national and literary renaissance. They wrote much in defence

¹ The patriarch Cyrillos Lucaras (1572-1638), who had studied for a time in England and whose sympathies with Protestantism made him many enemies, established a Greek printing-press at Constantinople, from which he had the temerity to issue a work condemning the faith of Mahomet; he was denounced to the Turks by the Jesuits, and his printing-press was suppressed.

of Greek orthodoxy against Latin heresy. Theotokos, famous as a preacher, wrote, besides theological and controversial works, treatises on mathematics, geography and physics. Bulgares was a most prolific author; he wrote numerous translations and works on theology, archaeology, philosophy, mathematics, physics and astronomy; he translated the *Aeneid* and *Georgics* of Virgil into Homeric verse at the request of Catherine II. His writings exercised a considerable influence over his contemporaries.

The poets of the earlier period of the Greek revival were Constantinos Rhigas (q.v.), the Alcman of the revolutionary movement, whose songs fired the spirit of his fellow-countrymen; Christopoulos (1772-1847), a Phanariote, who wrote some charming Anacreontics, and Jacobos Rizos Neroulos (1778-1850), also a Phanariote, author of tragedies, comedies and lyrics, and of a work in French on modern Greek literature. They are followed in the epoch of Greek independence by the brothers Panagiotos and Alexander Soutzos (1800-1868 and 1803-1863) and Alexander Rhizos Rhangabes (Rhankaves, 1810-1892), all three Phanariotes. Both Soutzos had a rich command of musical language, were highly ideal in their conceptions, strongly patriotic and possessed an ardent love of liberty. Both imitated to some extent Byron, Lamartine and Béranger; they tried various forms of poetry, but the genius of Panagiotos was essentially lyrical, that of Alexander satirical. The other great poet of the Greek revival, Alexander Rizos Rhangabes, was a writer with a fine poetic feeling, exquisite diction and singular beauty and purity of thought and sentiment. Besides numerous odes, hymns, ballads, narrative poems, tragedies and comedies, he wrote several prose works, including a history of ancient Greece, a history of modern Greek literature, several novels and works on ancient art and archaeology. Among the numerous dramatic works of this time may be mentioned the *Μαρία Δοξιαρη* of Demetrius Bernardakes, a Cretan, the scene of which is laid in the Morea at the time of the crusades.

In prose composition, as in poetry, the national revival was marked by an abundant output. Among the historians the greatest is Spiridon Trikoupis, whose *History of the Revolution* is a monumental work. It is distinguished by beauty of style, clearness of exposition and an impartiality which is all the more remarkable as the author played a leading part in the events which he narrates. Almost all the chiefs of the revolutionary movement left their memoirs; even Kolokotronis, who was illiterate, dictated his recollections. John Philemon, of Constantinople, wrote a history of the revolution in six volumes. He was an ardent partisan of Russia, and as such was opposed to Trikoupis, who was attached to the English party. K. Paparrhegopoulos's *History of the Greek Nation* is especially valuable in regard to the later periods; in regard to the earlier he largely follows Gibbon and Grote. With him may be mentioned Moustoxides of Corfu, who wrote on Greek history and literature; Sakellaris, who dealt with the topography and history of Cyprus; N. Dragoumes, whose historical memoirs treat of the period which followed the revolution; K. Assopios, who wrote on Greek literature and history. In theology Oeconomos fills the place occupied by Miniates in the 17th century as a great preacher. Kontogones is well known by his *History of Patristic Literature of the First Three Centuries* and his *Ecclesiastical History*, and Philotheos Bryennios, bishop of Serres, by his elaborate edition of *Clemens Romanus*. Kastorches wrote well on Latin literature. Great literary activity in the domains of law, political economy, mathematics, the physical sciences and archaeology displayed itself in the generation after the establishment of the Greek kingdom.

But the writer who at the time of the national revival not only exercised the greatest influence over his contemporaries but even to a large extent shaped the future course of Greek literature was Adamantios Korais (Korais) of Chios. This remarkable man, who devoted his life to philological studies, was at the same time an ardent patriot, and in the prolegomena to his numerous editions of the classical

Poets of the Greek revival.

Historical works.

The literary revival.

Prose writers of the revival.

Korais.

writers, written in Greek or French, he strove to awake the interest of his countrymen in the past glories of their race or administered to them sage counsels, at the same time addressing ardent appeals to civilized Europe on their behalf. The great importance of Coraïs, however, lies in the fact that he was practically the founder of the modern literary language.

In contemporary Greek literature two distinct forms of the modern language present themselves—the vernacular (ἡ καθομιλουμένη) and the purified (ἡ καθαρὴ γλῶσσα). The former is the oral language, spoken by the whole Greek world, with local dialectic variations; the latter is based on the Greek of the Hellenistic writers, modified, but not essentially altered, in successive ages by the popular speech. At the time of the War of Independence the enthusiasm of the Greeks and the Philhellenes was fired by the memory of an illustrious past, and at its close a classical reaction followed: the ancient nomenclature was introduced in every department of the new state, towns and districts received their former names, and children were christened after Greek heroes and philosophers instead of the Christian saints. In the literary revival which attended the national movement, two schools of writers made their appearance—the purists, who, rejecting the spoken idiom as degenerate and corrupt, aimed at the restoration of the classical language, and the vulgarists, who regarded the vernacular or "Romaic" as the genuine and legitimate representative of the ancient tongue. A controversy which had existed in former times was thus revived, with the result that a state of confusion still prevails in the national literature. The classical scholar who is as yet unacquainted with modern Greek will find, in the pages of an ordinary periodical or newspaper, specimens of the conventional literary language which he can read with ease side by side with poems or even prose in the vernacular which he will be altogether unable to interpret.

The vernacular or oral language is never taught, but is universally spoken. It has been evolved from the ancient language by a natural and regular process, similar to that which has produced the Romance languages from the Latin, or the Russian, Bulgarian and Servian from the old Slavonic. It has developed on parallel lines with the modern European languages, and in obedience to the same laws; like them, it might have grown into a literary language had any great writers arisen in the middle ages to do for it what Dante and his successors of the *trecento* did for Italian. But the effort to adapt it to the requirements of modern literature could hardly prove successful. In the first place, the national sentiment of the Greeks prompts them to imitate the classical writers, and so far as possible to appropriate their diction. The beauty and dignity of the ancient tongue possesses such an attraction for cultivated writers that they are led insensibly to adopt its forms and borrow from its wealth of phrase and idiom. In the next place, a certain literary tradition and usage has already been formed which cannot easily be broken down. For more than half a century the generally accepted written language, half modern half ancient, has been in use in the schools, the university, the parliament, the state departments and the pulpit, and its influence upon the speech of the more educated classes is already noticeable. It largely owes its present form—though a fixed standard is still lacking—to the influence and teaching of Coraïs. As in the time of the decadence a *κοινή ἀόλιτος* stood midway between the classical language and the popular speech, so at the beginning of the 19th century there existed a common literary dialect, largely influenced by the vernacular, but retaining the characteristics of the old Hellenistic, from which it was derived by an unbroken literary tradition. This written language Coraïs took as the basis of his reforms, purging it of foreign elements, preserving its classical remnants and enlarging its vocabulary with words borrowed from the ancient lexicon or, in case of need, invented in accordance with a fixed principle. He thus adopted a middle course, discountenancing alike the pedantry of the purists and the over-confident optimism of the vulgarists, who found in the uncouth popular

speech all the material for a *langue savante*. The language which he thus endeavoured to shape and reconstruct is, of course, conventional and artificial. In course of time it will probably tend to approach the vernacular, while the latter will gradually be modified by the spread of education. The spoken and written languages, however, will always be separated by a wide interval.

Many of the best poets of modern Greece have written in the vernacular, which is best adapted for the natural and spontaneous expression of the feelings. Dionysios Solomos (1798–1857), the greatest of them all, employed the dialect of the Ionian Islands. Of his lyrics, which are full of poetic fire and inspiration, the most celebrated is his "Ode to Liberty." Other poets, of what may be described as the Ionic school, such as Andreas Kalvos (1796–1869), Julius Typaldos (1814–1883), John Zampelios (1787–1856), and Gerasimos Markoras (b. 1826), followed his example in using the Heptanesian dialect. On the other hand, Georgios Terzetes (1806–1874), Aristotle Valaorites (1824–1879) and Gerasimos Mavrogiannes, though natives of the Ionian Islands, adopted in their lyrics the language of the Klephtic ballads—in other words, the vernacular of the Pindus range and the mountainous district of Epirus. This dialect had at least the advantage of being generally current throughout the mainland, while it derived distinction from the heroic exploits of the champions of Greek liberty. The poems of Valaorites, which are characterized by vivid imagination and grace of style, have made a deep impression on the nation. Other poets who largely employed the Epirotic dialect and drew their inspiration from the Klephtic songs were John Vilaras (1771–1823), George Zalokostas (1805–1857) in his lyric pieces, and Theodore Aphentoulas, a Cretan (d. 1893). With the poems of this group may be classed those of Demetrios Bikelas (b. 1835). The popular language has been generally adopted by the younger generation of poets, among whom may be mentioned Aristomenes Problegios (b. 1850), George Bizyenos (1853–1896), George Drosines, Kostas Palamas (b. 1859), John Polèmes, Argyres Epthalotes, and Jacob Polyas (d. 1896).

Contemporary with the first-mentioned or Ionic group, there existed at Constantinople a school of poets who wrote in the accepted literary language, and whose writings serve as models for the later group which gathered at Athens after the emancipation of Greece. The literary traditions founded by Alexander Rizos Rhangabés (1810–1892) and the brothers Alexander and Panagiotis Soutzos (1803–1863 and 1800–1868), who belonged to Phanariot families, were maintained in Athens by Spiridion Basiliades (1843–1874) Angelos Vlachos (b. 1838), John Karasoutzas (1824–1873), Demetrios Paparrhegopoulos (1843–1873), and Achilles Paraschos (b. 1838). The last, a poet of fine feeling, has also employed the popular language. In general the practice of versification in the conventional literary language has declined, though sedulously encouraged by the university of Athens, and fostered by annual poetic competitions with prizes provided by patriotic citizens. Greek lyric poetry during the first half of the century was mainly inspired by the patriotic sentiment aroused by the struggle for independence, but in the present generation it often shows a tendency towards the philosophic and contemplative mood under the influence of Western models.

There has been an abundant production of dramatic literature in recent years. In succession to Alexander Rhangabés, John Zampelios and the two Soutzos, who belong to the past generation, Kleon Rhangabés, Angelos Vlachos, Demetrios Koromelas, Basiliades and Bernadakes are the most prominent among modern dramatic writers. Numerous translations of foreign masterpieces have appeared, among which the metrical versions of *Roméo and Juliet*, *Othello*, *King Lear*, *Hamlet*, *Macbeth* and *The Merchant of Venice*, by Demetrios Bikelas, deserve mention as examples of artistic excellence. Goethe's *Faust* has been rendered into verse by Problegios, and *Hamlet*, *Antony and Cleopatra*, *Coriolanus* and *Julius Caesar*, into prose by Damirolas.

The modern literary language.

Reforms of Coraïs.

Poetical writers in the vernacular.

Poetical writers in the conventional language.

Dramatists and artists.

Among recent satirists, George Soares (b. 1853) occupies a unique position. He reviews social and political events in the *Ψαφίος*, a witty little newspaper written entirely in verse, which is read with delight by all classes of the population.

Almost all the prose writers have employed the literary language. In historical research the Greeks continue to display much activity and erudition, but no great work comparable to Spiridion Trikoupi's *History of the Revolution* has appeared in the present generation.

A history of the Greek nation from the earliest times to the present day, by Spiridion Lampros, and a general history of the 19th century by Karolides, have recently been published. The valuable *Μεταίχμια* of Sathas, the *μυθάρια Βυζαντινών τόπων* of Spiridion Zampelios and Mavrogiannes's *History of the Ionian Islands* deserve special mention, as well as the essays of Bikelas, which treat of the Byzantine and modern epochs of Greek history. Some of the last-named were translated into English by the late marquis of Bute. Among the writers on jurisprudence are Peter Paparrhizopoulos, Kalligas, Basileios Oekonomedes and Nikolaos Sariopolos. Brailas-Armenes and John Skaltsounes, the latter an opponent of Darwin, have written philosophical works. The *Ecclesiastical History* of Diomedes Kyriakos and the *Theological Treatises* of Archbishop Latas should be noted. The best-known writers of philological works are Constantine Kontos, a strong advocate of literary purism, George Hatzidakis, Theodore Papademetrakopoulos and John Psichari; in archaeology, Stephen Koumanoudes, Panagiotis Kavvadias and Christos Tsountas have won a recognized position among scholars. John Svoronos is a high authority on numismatics. The works of John Hatzidakis on mathematics, Anast. Christomanos on chemistry, and Demetrios Aeginetes on astronomy are well known.

The earlier works of fiction, written in the period succeeding the emancipation of Greece, were much affected by foreign influence. Modern Greece has not produced any great novelist. The *Κρητικοί γάμοι* of Spiridion Zampelios, the scene of which is laid in Crete, and the *Thanos Blachas* of Kalligas are interesting, the former for accuracy of historical detail, the latter as a picture of peasant life in the mountains of Greece. Original novel writing has not been much cultivated, but translations of foreign romances abound. In later times the short story has come into vogue through the example of D. Bikelas, whose tales have acquired great popularity; one of them, *Loukhis Laras*, has been translated into many languages. The example of Bikelas has been followed by Drosinos Karkavitzas, Ephthaliotis, Xenopoulos and many others.

The most distinguished of the writers who adhere to the vernacular in prose is John Psichari, professor of the *École des Hautes Études* in Paris. He is the recognized leader of the vulgarists. Among the best known of his works are *Τὸ ταξίδι μου*, a narrative of a journey in Greek lands, *Τὸν εὖρο τοῦ Γρανίου*, *Ἡ Ζούλα*, and *ὁ Μάγος*. The tales of Karkavitzas and Ephthaliotis are also in the vernacular. Among the younger of M. Psichari's followers is M. Falli, who has recently published a translation of the *Iliad*. Owing to the limited resources of the popular language, the writers of this school are sometimes compelled to employ strange and little-known words borrowed from the various dialects. The vernacular has never been adopted by writers on scientific subjects, owing to its inherent unsuitability and the incongruity arising from the introduction of technical terms derived from the ancient language. Notwithstanding the zeal of its adherents, it seems unlikely to maintain its place in literature outside the domain of poetry; nor can any other result be expected, unless its advocates succeed in reforming the system of public instruction in Greece.

Many periodicals are published at Athens, among which may be mentioned the *Athens*, edited by Constantine Kontos, the *Ethnikḗ Agoge*, a continuation of the old *Hestia*, the *Harmonia* and the *Διάπλασις τῶν παίδων*, an educational review. The Parnassos, the Archaeological Society and other

learned bodies issue annual or quarterly reports. The Greek journals are both numerous and widely read. They contain much clever writing, which is often marred by inaccuracy and a deficient sense of responsibility. Their tendency to exaggerated patriotic sentiment sometimes borders on the ludicrous. For many years the *Nea Héméra* of Trieste exerted a considerable influence over the Greek world, owing to the able political reviews of its editor, Anastasios Byzantios (d. 1898), a publicist of remarkable insight and judgment.

Periodicals and Journals.

AUTHORITIES.—Constantine Sathas, *Νεολληνικὴ φιλολογία* (Athens, 1868); D. Bikelas, *Περὶ νεοελληνικῆς φιλολογίας δοκίμιον* (London, 1871), reprinted in *Διαλέξεις καὶ ἐκταυρῆσεις* (Athens, 1893); J. S. Blackie, *Horae Hellenicae* (London, 1874); R. Nicolai, *Geschichte der neugriechischen Literatur* (Leipzig, 1876); A. R. Rhangabé, *Histoire littéraire de la Grèce moderne* (Paris, 1877); C. Gidel, *Études sur la littérature grecque moderne* (Paris, 1878); E. Legrand, *Bibliothèque grecque vulgaire* (vol. i., Paris, 1880); J. Lamber, *Poètes grecs contemporains* (Paris, 1881); Kontos, *Πνευματικὰ παραρτήματα* (Athens, 1882); Rhangabé and Sanders, *Geschichte der neugriechischen Literatur von ihren Anfängen bis auf die neueste Zeit* (Leipzig, 1885); J. Psichari, *Essais de grammaire historique néo-grecque* (2 vols., Paris, 1886 and 1889); *Études de philologie néo-grecque* (Paris, 1892); F. Blass, *Die Aussprache des Griechischen* (3rd ed., Berlin, 1888); Παπαδμετρακόπουλος, *Βήματα ἰστορικῆς προφορῆς* (Athens, 1889); M. Konstantinides, *Neo-hellenica (Dialogues in Modern Greek, with Appendix on the Cypriot Dialect)* (London, 1892); Rhoides, *Τὰ ἔθνη. Ἐπιστολὴ μὲτὰ μίσην* (Athens, 1893); Politis, *Μελέται περὶ τοῦ βίου καὶ τῆς γλώσσης τῆς Ἑλληνικῆς λέξου* (2 vols., Athens, 1892).

For the Klephtic ballads and folk-songs: C. Faurel, *Chants populaires de la Grèce moderne* (Paris, 1824, 1826); Passow, *Popularia carmina Graeciae recentioris* (Leipzig, 1860); von Hahn, *Griechische und albanesische Märchen* (Leipzig, 1864); *Τετραλογον. Λαογραφία* (2nd ed., Athens, 1868); E. Legrand, *Recueil de chansons populaires grecques* (Paris, 1874); *Recueil de contes populaires grecs* (Paris, 1881); Paul de Lagarde, *Neugriechisches aus Kleinasien* (Göttingen, 1886); A. Jannaris, *Ἄσματα Κρητικὰ (Kreta's Volkslieder)* (Leipzig, 1876); A. Sakellariou, *Τὰ Κυπριακὰ* (Athens, 1891); *Ζωγραφικὸν Ἄγιον*, published by the Ἑλληνοεὐρωπαϊκὸν εὐλαγωγὸν (Constantinople, 1891). Translations: L. Garnett, *Greek Folk-songs from the Turkish Provinces of Greece* (London, 1885); E. M. Geldart, *Folklore of Modern Greece* (London, 1884). Lexicons: A. N. Jannaris, *A Concise Dictionary of the English and Modern Greek Languages* (English-Greek) (London, 1895); Byzantios (Skarlatos D.), *Λεξικὸν τῆς Ἑλληνικῆς γλώσσης* (Athens, 1895); A. Sakellario, *Λεξικὸν τῆς Ἑλληνικῆς γλώσσης* (5th ed., Athens, 1892); S. Koumanoudes, *Συναγωγὴ λέξεων Ἑλλήνων* (Athens, 1900). Grammars: Mitsotakes, *Praktische Grammatik der neugriechischen Schrift- und Umgangssprache* (Stuttgart, 1891); M. Gardner, *A Practical Modern Greek Grammar* (London, 1892); G. N. Hatzidakis, *Einführung in die neugriechische Grammatik* (Leipzig, 1892); E. Vincent and T. G. Dickson, *Handbook to Modern Greek* (London, 1893); A. Thumb, *Handbuch der neugriechischen Volkssprache* (Strassburg, 1895); C. Wied, *Die Kunst der neugriechischen Volkssprache durch Selbstunterricht schnell und leicht zu lernen* (2nd ed., undated, Vienna); A. N. Jannaris, *Historical Greek Grammar* (London, 1897).

GREEK RELIGION. The recent development of anthropological science and of the comparative study of religions has enabled us at last to assign to ancient Greek religion its proper place in the classification of creeds and to appreciate its importance for the history of civilization. In spite of all the diversities of local cults we may find a general definition of the theological system of the Hellenic communities, and with sufficient accuracy may describe it as an anthropomorphic polytheism, preserving many traces of a pre-anthropomorphic period, unchecked by any exacting dogma or tradition of revelation, and therefore pliantly adapting itself to all the changing circumstance of the social and political history of the race, and easily able to assimilate alien ideas and forms. Such a religion, continuing in whole or in part throughout a period of at least 2000 years, was more capable of progress than others, possibly higher, that have crystallized at an early period into a fixed dogmatic type; and as, owing to its essential character, it could not be convulsed by any inner revolution that might obliterate the deposits of its earlier life, it was likely to preserve the imprints of the successive ages of culture, and to reveal more clearly than any other testimony the evolution of the race from savagery to civilization. Hence it is that Greek religion appears to teem with incongruities, the highest forms of religious life being often confronted with the most primitive. And for this reason the student of savage

anthropology and the student of the higher religions of the world are equally rewarded by its study.

Modern ethnology has arrived at the conviction that the Hellenic nation, like others that have played great parts in history, was the product of a blend of populations, the conquering tribes of Aryan descent coming from the north and settling among and upon certain pre-Hellenic Mediterranean stocks. The conclusion that is naturally drawn from this is that Hellenic religion is also the product of a blend of early Aryan or Indo-Germanic beliefs with the cult-ideas and practices of the Mediterranean area that were from of old indigenous in the lands which the later invaders conquered. But to disentangle these two component parts of the whole, which might seem to be the first problem for the history of the development of this religion, is by no means an easy task; we may advance further towards its solution, when the mysterious pre-Hellenic Mediterranean language or group of languages, of which traces remain in Hellenic place-names, and which may be lying uninterpreted on the brick-tablets of the palace of Cnossus, has found its interpreter. For the first question is naturally one of language. But the comparative study of the Indo-European speech-group, great as its philological triumphs have been, has been meagre in its contributions to our positive knowledge of the original belief of the primitive stock. It is not possible to reconstruct a common Indo-European religion. The greater part of the separate Aryan cult-systems may have developed after the diffusion and may have been the result of contact in prehistoric days with non-Aryan peoples. And many old religious etymological equations, such as *Óþarwós* = Sanskrit Varuna, *Épwpós* = Saraméyás, Athena = Ahana, were uncritically made and have been abandoned. The chief fact that philology has revealed concerning the religious vocabulary of the Aryan peoples is that many of them are found to have designated a high god by a word derived from a root meaning "bright," and which appears in Zeus, Jupiter, Sanskrit *Dyáus*. This is important enough, but we should not exaggerate its importance, nor draw the unwarranted inference that therefore the primitive Indo-Europeans worshipped one supreme God, the Sky-Father. Besides the word "Zeus," the only other names of the Hellenic pantheon that can be explained wholly or partly as words of Aryan formation are Poseidon, Demeter, Hestia, Dionysus (whose name and cult were derived from the Aryan stock of the Thracio-Phrygians) and probably Pan. But other names, such as Athena, Ares, Apollo, Artemis, Hera, Hermes, have no discovered affinities with other Aryan speech-groups; and yet there is nothing suspiciously non-Aryan in the formation of these words, and they may all have belonged to the earliest Hellenic-Aryan vocabulary. In regard to others, such as Rhea, Hephaestus and Aphrodite, it is somewhat more probable that they belonged to an older pre-Hellenic stock that survived in Crete and other islands, and here and there on the mainland; while we know that Zeus derived certain unintelligible titles in Cretan cult from the indigenous Eteo-Cretan speech.

A minute consideration of a large mass of evidence justifies the conclusion that the main tribes of the Aryan Hellenes, pushing down from the north, already possessed certain deities in common such as Zeus, Poseidon and Apollo with whom they associated certain goddesses, and that they maintained the cult of Hestia or "Holy Hearth." Further, a comparison of the developed religions of the respective Aryan peoples suggests that they tended to give predominance to the male divinity, although we have equally good reason to assert that the cult of goddesses, and especially of the earth-goddess, is a genuinely "Aryan" product. But when the tribes of this family poured into the Greek peninsula, it is probable that they would find in certain centres of a very ancient civilization, such as Argolis and Crete, the dominant cult of a female divinity.¹ The recent

excavations on the site of the Hera temple at Argos prove that a powerful goddess was worshipped here many centuries before it is probable that the Hellenic invader appeared. He may have even found the name Hera there, or may have brought it with him and applied it to the indigenous divinity. Again, we are certain that the great mother-goddess of Crete, discovered by Dr Arthur Evans, is the ancestress of Rhea and of the Greek "Mother of the gods"; and it is a reasonable conjecture that she accounts for many of the forms of Artemis and perhaps for Athena. But the evidence by no means warrants us in assuming as an axiom that wherever we find a dominant goddess-cult, as that of Demeter at Eleusis, we are confronted with a non-Hellenic religious phenomenon. The very name "Demeter" and the study of other Aryan religions prove the prominence of the worship of the earth-goddess in our own family of the nations. Finally, we must reckon with the possibility that the other great nations which fringed the Mediterranean, Hittite, Semitic and Egyptian peoples, left their impress on early Greek religion, although former scholars may have made rash use of this hypothesis.²

Recognizing then the great perplexity of these problems concerning the ethnic origins of Hellenic religion, we may at least reduce the tangle of facts to some order by *Animism*, distinguishing its lower from its higher forms, and thus provide the material for some theory of evolution. We may collect and sift the phenomena that remain over from a pre-anthropomorphic period, the imprints of a savage past, the beliefs and practices that belong to the animistic or even the pre-animistic period, fetishism, the worship of animals, human sacrifice. We shall at once be struck with the contrast between such civilized cults as those of Zeus, Athena, Apollo, high personal divinities to whom the attributes of a progressive morality could be attached, and practices that long survived in backward communities, such as the Arcadian worship of the thunder and the winds, the cult of Zeus *Κεραυτός* "the thunder" at Mantinea and Zeus *Κακρόρας* in Laconia, who is none other than the mysterious meteoric stone that falls from heaven. These are examples of a religious view in which certain natural phenomena or objects are regarded as mysteriously divine or sacred in their own right and a personal divinity has not yet emerged or been separated from them. A noteworthy product of primitive animistic feeling is the universally prevalent cult of Hestia, who is originally "Holy Hearth" pure and simple, and who even under the developed polytheism, in which she played no small part, was never established as a separate anthropomorphic personage.

The animistic belief that certain material objects can be charged with a divine potency or spirit gives rise to fetishism, a term which properly denotes the worshipful or superstitious use of objects made by art and invested *Fetichism* with mysterious power, so as to be used like amulets for the purposes of protective magic or for higher purposes of communion with the divinity. From the earliest discoverable period down to the present day fetishism has been a powerful factor in the religion of the Graeco-Roman world. The importance of the sacred stone and pillar in the "Mycenaean" or "Minoan" period which preceded Homer has been impressively shown by Dr Arthur Evans, and the same fetishistic worship continued throughout the historic ages of classic paganism, the rude anconic emblem of pillar or tree-trunk surviving often by the side of the iconic masterpiece. It is a reasonable conjecture that the earliest anthropomorphic images of divinities, which were beginning to make their appearance by the time of Homer, were themselves evolved by slow transformation from the upright sacred column. And the altar itself may have arisen as another form of this; the simple heap of stones, such

¹ This has often been explained as a result of *Mutterrecht*, or reckoning descent through the female: for reasons against this hypothesis see L. R. Farnell in *Archiv für vergleichende Religionswissenschaft* (1904); cf. A. J. Evans, "Mycenaean Tree and Pillar Cult," in *Journ. of Hellenic Studies* (1907).

² V. Bérard has recently revived the discredited theory of a prevalent Phoenician influence in his ingenious but uncritical work, *L'Origine des cultes arcadiens*. M. P. Foucart believes in very early borrowing from Egypt, as explaining much in the religion of Demeter and Dionysus; see *Les Grands Mystères d'Eleusis* and *Le Culte de Dionysos en Attique*.

as those erected to Hermes by the way-side and called Ἐρμῆος Ἄλφοι, may have served both as a place of worship and as an *agalma* that could attract and absorb a divine potency into itself. Hence the fetishistic power of the altar was fully recognized in Greek ritual, and hence also in the cult of Apollo Agyieus the god and the altar are called by the same name.

It has been supposed that the ancestors of the historic Greeks, before they were habituated to conceive of their divinities as in human form, may have been accustomed to invest them with animal attributes and traits. We must not indeed suppose it to be a general law of religious evolution that "theriomorphism" must always precede anthropomorphism and that the latter transcends and obliterates the former. The two systems can exist side by side, and savages of low religious development can conceive of their deities as assuming at one time human, at another bestial, shape. Now the developed Greek religion was devotedly anthropomorphic, and herein lay its strength and its weakness; nevertheless, the advanced Hellene could imagine his Dionysus entering temporarily into the body of the sacrificial bull or goat, and the men of Phigalia in Arcadia were attached to their horse-headed Demeter, and the primitive Laconians possibly to a ram-headed Apollo. Theriolatry in itself, *i.e.* the worship of certain animals as of divine power in their own right, apart from any association with higher divinities, can scarcely be traced among the Greek communities at any period. They are not found to have paid reverence to any species, though individual animals could acquire temporarily a divine character through communion with the altar or with the god. The wolf might at one time have been regarded as the incarnation of Apollo, the wolf-god, and here and there we find faint traces of a wolf-sacrifice and of offerings laid out for wolves. But the occasional propitiation of wild beasts may fall short of actual worship. The Athenian who slew a wolf might give it a sumptuous funeral, probably to avoid a blood-feud with the wolf's relatives, yet the Athenian state offered rewards for a wolf's head. Nor did any Greek individual or state worship flies as a class, although a small oblation might be thrown to the flies before the great sacrifice to Apollo on the Leucadian rock, to please them and to persuade them not to worry the worshippers at the great solemnity, where the reek of roast flesh would be likely to attract them.

Theriolatry suggests totemism; and though we now know that the former can arise and exist quite independently of the latter, recent anthropologists have interpreted the apparent sanctity or prestige of certain animals in parts of Greek mythology and religion as the deposit of an earlier totemistic system. But this interpretation, originated and maintained with great acumen by Andrew Lang and W. Robertson Smith, appears now somewhat hazardous; and as a scientific hypothesis there are many flaws in it. The more observant study of existing totem-tribes has weakened our impression of the importance of totemism as a primitive religious phenomenon. It is in reality more important as a social than as a religious factor. If indeed we choose to regard totemism as a mere system of nomenclature, by which a tribe names itself after some animal or plant, then we might quote a few examples of Hellenic tribes totemistic in this sense. But totemism is a fact of importance only when it affects the tribal marriage laws or the tribal religion. And the tribal marriage laws of ancient Greece, so far as they are known, betray no clear mark of totemistic arrangements; nor does the totemism of contemporary savages appear to affect their religion in any such way as to suggest a natural explanation for any of the peculiar phenomena of early Hellenic polytheism. Here and there we have traces of a snake-tribe in Greece, the Ὀφθαίης in Aetolia, the Ὀφιογενεῖς in Cyprus and Parium, but we are not told that these worshipped the snake, though the latter clan were on terms of intimacy with it. Where the snake was actually worshipped in Hellenic cult—the cases are few and doubtful—it may have been regarded as the incarnation of the ancestor or as the *swalar* of the under-world divinity.

xii 9*

Finally, among the primitive or savage phenomena the practice of human sacrifice looms large. Encouraged at one time by the Delphic oracle, it was becoming rare and repellent to the conscience by the 6th century B.C.; but it was not wholly extinct in the Greek world even by the time of Porphyry. The facts are very complex and need critical handling, and a satisfying scientific explanation of them all is still to be sought.

We can now observe the higher aspects of the advanced polytheism. And at the outset we must distinguish between mythology and religion strictly understood, between the stories about the divinities and the private or public religious service. No doubt the former are often a reflection of the latter, in many cases being suggested by the ritual which they may have been invented to interpret, and often envisaging important cult-ideas. Such for example are the myths about the purification and trial of Orestes, Theseus, Ixion, the story of Demeter's sorrow, of the sufferings and triumph of Dionysus, and those about the abolition of human sacrifice. Yet Greek mythology as a whole was irresponsible, without reserve, and unchecked by dogma or sacerdotal prohibition; and frequently it sank below the level of the current religion, which was almost free from the impurities which shock the modern reader of Hellenic myths. Nor again did any one feel himself called upon to believe any particular myth; in fact, faith, understood in the sense in which the term is used in Christian theology, as the will to believe certain dogmatic statements about the nature and action of divinity, is a concept which was neither named nor recognized in Hellenic ethics or religious doctrine; only, if a man proclaimed his disbelief in the existence of the gods and refused to join in the ritual of the community, he would become "suspect," and might at times be persecuted by his fellows. Greek religion was not so much an affair of doctrine as of ritual, religious formulae of which the cult-titles of the divinities were an important component, and prayer; and the most illuminative sources of our knowledge of it are the ritual-inscriptions and other state-documents, the private dedications; the monuments of religious art and certain passages in the literature, philology and archaeology being equally necessary to the equipment of the student.

We are tempted to turn to Homer as the earliest authority. And though Homer is not primitive and does not present even an approximately complete account of Greek religion, we can gather from his poems a picture of an advanced polytheism which in form and structure at least is that which was presented to the world of Aeschylus.

We discern a pantheon already to some extent systematized, a certain hierarchy and family of divinities in which the supremacy of Zeus is established as incontestable. And the anthropomorphic impulse, the strongest trend in the Greek religious imagination, which filled the later world with fictitious personages, generating transparent shams such as an Ampidromus for the ritual of the Ampidromia, Amphiction for the Amphictiones, a hero Κεραμος for the guild of potters, is already at its height in the Homeric poems. The deities are already clear-cut, individual personalities of distinct ethos, plastically shaped figures such as the later sculpture and painting could work upon, not vaguely conceived *numina* like the forms of the old Roman religion. Nor can we call them for the most part nature-deities like the personages of the Vedic system, thinly disguised "personifications" of natural phenomena. Athena is not the blue sky nor Apollo the sun; they are simply Athena and Apollo, divine personages with certain powers and character, as real for their people as Christ and the Virgin for Christendom. By the side of these, though generally in a subordinate position, we find that Homer recognized certain divinities that we may properly call nature-powers, such as Helios, Gaia and the river-deities, forms descending probably from a remote animistic period, but maintaining themselves within the popular religion till the end of Paganism. Again, though Homer may talk and think at times with levity and *banalité* about his deities, his deeper utterances impute an advanced morality to the supreme

Human
sacrifice

Religion
in
Homer.

God. His Zeus is on the whole a power of righteousness, dealing with men by a righteous law of nemesis, never being himself the author of evil—an idea revealed in the opening passage of the *Odyssey*—but protecting the good and punishing the wicked. Vengeance, indeed, was one of the attributes of divinity both for Homer and the average Greek of the later period, as it is in Judaic and Christian theology, though Plato and Euripides protested strongly against such a view. But the Homeric Zeus is equally a god of pity and mercy, and the man who neglects the prayers of the sorrowful and afflicted, who violates the sanctity of the suppliant and guest, or oppresses the poor or the wanderer, may look for divine punishment. Though not regarded as the physical author of the universe or the Creator, he is in a moral sense the father of gods and men. And though the sense of sin and the need of piacular sacrifice are expressed in the Homeric poems, the relations between gods and men that they reveal are on the whole genial and social; the deity sits unseen at the good man's festal sacrifice, and there is a simple apprehension of the idea of divine communion. There is also indeed a glimmering of the dark background of the nether world, and the chthonian powers that might send up the Erinyes to fulfil the curse of the wronged. Yet on the whole the religious atmosphere is generally cheerful and bright; freer than that of the later ages from the taint of magic and superstition; nor is Homer troubled much about the life after death; he scarcely recognizes the cult of the dead,¹ and is not oppressed by fear of the ghost-world.

If we look now broadly over the salient facts of the Greek public and private worship of the historic period we find much in it that agrees with Homeric theology. His "Olympian" system retains a certain life almost to the end of Paganism, and it is a serious mistake to suppose that it had lost its hold upon the people of the 5th and 4th century B.C. We find it, indeed, enriched in the post-Homeric period with new figures of prestige and power; Dionysus, of whom Homer had only faintly heard, becomes a high god with a worship full of promise for the future. Demeter and Kore, the mother and the girl, whom Homer knew well enough but could not use for his epic purposes, attract the ardent affections and hopes of the people; and Asclepius, whom the old poet did not recognize as a god, wins a conspicuous place in the later shrines. But much that has been said of the Homeric may be said of the later classical theology. The deities remain anthropomorphic, and appear as clearly defined individuals. A certain hierarchy is recognized; Zeus is supreme, even in the city of Athens, but each of the higher divinities played many parts, and local enthusiasm could frustrate the departmental system of divine functions; certain members of the pantheon had a preference for the life of the fields, but as the *polis* emerged from the village communities, Demeter, Hermes, Artemis and others, the gods and goddesses of the husbandmen and shepherds, become powers of the council-chamber and the market-place. The moral ideas that we find in the Homeric religion are amply attested by cult-records of the later period. The deities are regarded on the whole as beneficent, though revengeful if wronged or neglected; the cult-titles used in prayer, which more than any other witnesses reveal the thought and wish of the worshipper, are nearly always euphemistic, the doubtful title of Demeter Erinyes being possibly an exception. The important cults of Zeus *Iktovos* and *Προσφραυος*, the suppliant's protecting deity, embody the ideas of pity and mercy that mark advanced religion; and many momentous steps in the development of morality and law were either suggested or assisted by the state-religion. For example, the sanctity of the oath, the main source of the secular virtue of truthfulness, was originally a religious sanction, and though the Greek may have been prone to perjury, yet the Hellenic like the Hebraic religious ethics regarded it as a heinous sin. The sanctity of

¹ This became very powerful from the 7th century onward, and there are reasons for supposing that it existed in the pre-Homeric, or Mycenaean, period; *vide* Rohde's *Psyche* (new edition), Tsountas and Maass, *The Mycenaean Age*.

family duties, the sacredness of the life of the kinsman, were ideas fostered by early Hellenic religion before they generated principles of secular ethics. In the post-Homeric period, the development of the doctrine of purity, which was associated with the Apolline religion, combining with a growing dread of the ghost-world, stimulated and influenced in many important ways the evolution of the Greek law concerning homicide.² And the beginnings of international law and morality were rooted in religious sanctions and taboo. In fact, Greek state-life was indebted in manifold ways to Greek religion, and the study of the Greek oracles would alone supply sufficient testimony of this. In many cases the very origin of the state was religious, the earliest *polis* sometimes having arisen under the shadow of the temple.

Yet as Greek religion was always in the service of the state, and the priest a state-official, society was the reverse of theocratic. Secular advance, moral progress and the march of science, could never long be thwarted by religious tradition; on the contrary, speculative thought and artistic creation were considered as attributes of divinity. We may say that the religion of Hellas penetrated the whole life of the people, but rather as a servant than as a master.

Distinct and apart from these public worship and those of the clan and family were the mystic cults of Eleusis, Andania and Samothrace, and the private services of the mystic brotherhoods. The latter were scattered broadcast over Hellas, and the influence of the former was strengthened and their significance intensified by the wave of mysticism that spread at first from the north from the beginning of the 7th century onwards, and derived its strength from the power of Dionysus and the Orphic brotherhoods. New ideals and hopes began to stir in the religious consciousness, and we find a strong salvationist tendency, the promise of salvation relying on mystic communion with the deity. Also a new and vital principle is at work; Orphism is the only force in Greek religion of a clear apostolic purpose, for it broke the barriers of the old tribal and civic cults, and preached its message to bond and free, Hellene and barbarian.

The later history of Greek paganism is mainly concerned with its gradual penetration by Oriental ideas and worship, and the results of this *theopoeia* are discerned in an ever increasing mysticism and a tendency towards monotheism. Obliterated as the old Hellenic religion appeared to be by Christianity, it nevertheless retained a certain life, though transformed, under the new creed to which it lent much of its hieratic organization and religious terminology. The indebtedness of Christianity to Hellenism is one of the most interesting problems of comparative religion; and for an adequate estimate a minute knowledge of the ritual and the mystic cults of Hellas is one of the essential conditions.

BIBLIOGRAPHY.—Older Authorities: A. Maury, *Histoire des religions de la Grèce antique* (3 vols., 1857-1859); Welcker, *Griechische Götterlehre* (3 vols., 1857-1863); Preller, *Griechische Mythologie*, 2 vols. (4th edition by C. Robert, 1887), all antiquated in regard to theory, but still of some value for collection of materials. Recent Literature:—(a) General Treatises: O. Gruppe, "Griechische Mythologie und Religionsgeschichte" in Iwan von Müller's *Handbuch der klassischen Altertumswissenschaft*, v. 2, 2 (1902-1906); L. R. Farnell's *Cults of the Greek States*, 4 vols. (1896-1906, vol. 5, 1908); Miss Jane Harrison's *Prolegomena to the Study of Greek Religion* (ed. 1908); Chantepie de la Saussaye's *Lehrbuch der Religionsgeschichte* (Greek section, 1904); (b) Special Works or Dissertations: articles in Roscher's *Ausführliches Lexikon der griechischen und römischen Mythologie*, and Pauly-Wissowa *Encyclopädie* (1894-); Immerwahr, *Kulte und Mythen Arkadiens* (1891); Wide, *Lakonische Kulte* (1893); de Visser, *De Graecorum diis non referentibus speciem humanam* (Leiden, 1900). Greek Ritual and Festivals—A. Mommsen, *Feste der Stadt Athen* (1898); P. Stengel, "Die griechischen Sacral-altertümer" in Iwan von Müller's *Handbuch*, v. 3 (1898); W. H. D. Rouse, *Greek Votive Offerings* (1902). Greek Religious Thought and Speculation—L. Campbell's *Religion in Greek Literature* (1898); Ducharme, *La Critique des traditions religieuses chez les Grecs des origines au temps de Platon* (Paris, 1904). See also articles on individual deities, and cf. ROMAN RELIGION; MYSTERIES; MITHRAS. (L. R. F.)

² See L. R. Farnell, *Evolution of Religion* (Hibbert Lectures, 1905), pp. 139-152.

GREELEY, HORACE (1811-1872), American statesman and man of letters, was born at Amherst, New Hampshire, on the 3rd of February 1811. His parents were of Scottish-Irish descent, but the ancestors of both had been in New England for several generations. He was the third of seven children. His father, Zaccheus Greeley, owned a farm of 50 acres of stony, sterile land, from which a bare support was wrung. Horace was a feeble and precocious lad, taking little interest in the ordinary sports of childhood, learning to read before he was able to talk plainly, and the prodigy of the neighbourhood for accurate spelling. Before Horace was ten years old (1820), his father became bankrupt, his home was sold by the sheriff, and Zaccheus Greeley himself fled the state to escape arrest for debt. The family soon removed to West Haven, Vermont, where, all working together, they made a scanty living as day labourers. Horace from childhood desired to be a printer, and, when barely eleven years old, tried to be taken as an apprentice in an office at Whitehall, New York, but was rejected on account of his youth. After three years more with the family as a day labourer at West Haven, he succeeded, with his father's consent, in being apprenticed in the office of *The Northern Spectator*, at East Poultney, Vermont. Here he soon became a good workman, developed a passion for politics and especially for political statistics, came to be depended upon for more or less of the editing of the paper, and was a figure in the village debating society. He received only \$40 a year, but he sent most of his money to his father. In June 1830 *The Northern Spectator* was suspended. Meantime his father had removed to a small tract of wild land in the dense forests of Western Pennsylvania, 30 m. from Erie. The released apprentice now visited his parents, and worked for a little time with them on the farm, meanwhile seeking employment in various printing offices, and, when he got it, giving nearly all his earnings to his father. At last, with no further prospect of work nearer home, he started for New York. He travelled on foot and by canal-boat, entering New York in August 1831, with all his clothes in a bundle carried over his back with a stick, and with but \$10 in his pocket. More than half of this sum was exhausted while he made vain efforts to find employment. Many refused to employ him, in the belief that he was a runaway apprentice, and his poor, ill-fitting apparel and rustic look were everywhere greatly against him. At last he found work on a 32mo New Testament, set in agate, double columns, with a middle column of notes in pearl. It was so difficult and so poorly paid that other printers had all abandoned it. He barely succeeded in making enough to pay his board bill, but he finished the task, and thus found subsequent employment easier to get.

In January 1833 Greeley formed a partnership with Francis V. Story, a fellow-workman. Their combined capital amounted to about \$150. Procuring their type on credit, they opened a small office, and undertook the printing of the *Morning Post*, the first cheap paper published in New York. Its projector, Dr Horatio D. Shepard, meant to sell it for one cent, but under the arguments of Greeley he was persuaded to fix the price at two cents. The paper failed in less than three weeks, the printers losing only \$50 or \$60 by the experiment. They still had a *Bank Note Reporter* to print, and soon got the printing of a tri-weekly paper, the *Constitutionalist*, the organ of some lottery dealers. Within six months Story was drowned, but his brother-in-law, Jonas Winchester, took his place in the firm. Greeley was now asked by James Gordon Bennett to go into partnership with him in starting *The Herald*. He declined the venture, but recommended the partner whom Bennett subsequently took. On the 2nd of March 1834, Greeley and Winchester issued the first number of *The New Yorker*, a weekly literary and news paper, the firm then supposing itself to be worth about \$3000. Of the first number they sold about 100 copies; of the second, nearly 200. There was an average increase for the next month of about 100 copies per week. The second volume began with a circulation of about 4550 copies, and with a loss on the first year's publication of \$3000. The second year ended with 7000 subscribers and a further loss of \$2000. By the end of the third year *The New*

Yorker had reached a circulation of 9500 copies, and had sustained a total loss of \$7000. It was published seven years (until the 20th of September 1841), and was never profitable, but it was widely popular, and it gave Greeley, who was its sole editor, much prominence. On the 5th of July 1836 Greeley married Miss Mary Y. Cheney, a Connecticut school teacher, whom he had met in a Grahamite (vegetarian) boarding-house in New York.

During the publication of *The New Yorker* he added to the scanty income which the job printing brought him by supplying editorials to the short-lived *Daily Whig* and various other publications. In 1838 he had gained such standing as a writer that he was selected by Thurlow Weed, William H. Seward, and other leaders of the Whig Party, for the editorship of a campaign paper entitled *The Jeffersonian*, published at Albany. He continued *The New Yorker*, and travelled between Albany and New York each week to edit the two papers. *The Jeffersonian* was a quiet and instructive rather than a vehement campaign sheet, and the Whigs believed that it had a great effect upon the elections of the next year. When, on the 2nd of May 1840, some time after the nomination by the Whig party of William Henry Harrison for the Presidency, Greeley began the publication of a new weekly campaign paper, *The Log Cabin*, it sprang at once into a great circulation; 40,000 copies of the first number were sold, and it finally rose to 80,000. It was considered a brilliant political success, but it was not profitable, and in September 1841 was merged in the *Weekly Tribune*. On the 3rd of April 1841, Greeley announced that on the following Saturday (April 10th) he would begin the publication of a daily newspaper of the same general principles, to be called *The Tribune*. He was now entirely without money. From a personal friend, James Coggeshall, he borrowed \$1000, on which capital and the editor's reputation *The Tribune* was founded. It began with 500 subscribers. The first week's expenses were \$525 and the receipts \$92. By the end of the fourth week it had run up a circulation of 6000, and by the seventh reached 11,000, which was then the full capacity of its press. It was alert, cheerful and aggressive, was greatly helped by the attacks of rival papers, and promised success almost from the start.

From this time Greeley was popularly identified with *The Tribune*, and its share in the public discussion of the time is his history. It soon became moderately prosperous, and his assured income should have placed him beyond pecuniary worry. His income was long above \$15,000 per year, frequently as much as \$35,000 or more. But he lacked business thrift, inherited a disposition to endorse for his friends, and was often unable to distinguish between deserving applicants for aid and adventurers. He was thus frequently straitened, and, as his necessities pressed, he sold successive interests in his newspaper. At the outset he owned the whole of it. When it was already firmly established (in July 1841), he took in Thomas McElrath as an equal partner, upon the contribution of \$2000 to the common fund. By the 1st of January 1849 he had reduced his interest to 31½ shares out of 100; by July 2nd, 1860, to 15 shares; in 1868 he owned only 9; and in 1872, only 6. In 1867 the stock sold for \$6500 per share, and his last sale was for \$9600. He bought wild lands, took stock in mining companies, desiccated egg companies, patent looms, photo-lithographic companies, gave away profusely, lent to plausible rascals, and was the ready prey of every new inventor who chanced to find him with money or with property that he could readily convert into money.

In September 1841 Greeley merged his weekly papers, *The Log Cabin* and *The New Yorker*, into *The Weekly Tribune*, which soon attained as wide circulation as its predecessors, and was much more profitable. It rose in a time of great political excitement to a total circulation of a quarter of a million, and it sometimes had for successive years 140,000 to 150,000. For several years it was rarely much below 100,000. Its subscribers were found throughout all quarters of the northern half of the Union from Maine to Oregon, large packages going to remote districts beyond the Mississippi or Missouri, whose only connexion with the outside world was through a weekly or semi-weekly mail. The readers of this weekly paper acquired a personal affection for

its editor, and he was thus for many years the American writer most widely known and most popular among the rural classes. The circulation of *The Daily Tribune* was never proportionately great—its advocacy of a protective tariff, prohibitory liquor legislation and other peculiarities, repelling a large support which it might otherwise have commanded in New York. It rose within a short time after its establishment to a circulation of 20,000, reached 50,000 and 60,000 during the Civil War, and thereafter ranged at from 30,000 to 45,000. After May 1845 a semi-weekly edition was also printed, which ultimately reached a steady circulation of from 15,000 to 25,000.

From the outset it was a cardinal principle with Greeley to hear all sides, and to extend a special hospitality to new ideas. In March 1842 *The Tribune* began to give one column daily to a discussion of the doctrines of Charles Fourier, contributed by Albert Brisbane. Gradually Greeley came to advocate some of these doctrines editorially. In 1846 he had a sharp discussion upon them with a former subordinate, Henry J. Raymond, then employed upon a rival journal. It continued through twelve articles on each side, and was subsequently published in book form. Greeley became personally interested in one of the Fourierite associations, the North American Phalanx, at Red Bank, N. J. (1843-1855), while the influence of his discussions doubtless led to or gave encouragement to other socialistic experiments, such as that at Brook Farm. When this was abandoned, its leader George Ripley, with one or two other members, sought employment from Greeley upon *The Tribune*. Greeley dissented from many of Fourier's propositions, and in later years was careful to explain that the principle of association for the common good of working men and the elevation of labour was the chief feature which attracted him. Co-operation among working men he continued to urge throughout his life. In 1850 the Fox Sisters, on his wife's invitation, spent several weeks in his house. His attitude towards their "rappings" and "spiritual manifestations" was one of observation and inquiry; and in his *Recollections* he wrote concerning these manifestations: "That some of them are the result of juggle, collusion or trick I am confident; that others are not, I decidedly believe."

From boyhood he had believed in a protective tariff, and throughout his active life he was its most trenchant advocate and propagandist. Besides constantly urging it in the columns of *The Tribune*, he appeared as early as 1843 in a public debate on "The Grounds of Protection," with Samuel J. Tilden and Parke Godwin as his opponents. A series of popular essays on the subject were published over his own signature in *The Tribune* in 1869, and subsequently republished in book form, with a title-page describing protection to home industry as a system of national co-operation for the elevation of labour. He opposed woman suffrage on the ground that the majority of women did not want it and never would, and declared that until woman should "emancipate herself from the thralldom to etiquette," he "could not see how the 'woman's rights theory' is ever to be anything more than a logically defensible abstraction." He aided practical efforts, however, for extending the sphere of woman's employments. He opposed the theatres, and for a time refused to publish their advertisements. He held the most rigid views on the sanctity of marriage and against easy divorce, and vehemently defended them in controversies with Robert Dale Owen and others. He practised and pertinaciously advocated total abstinence from spirituous liquors, but did not regard prohibitory laws as always wise. He denounced the repudiation of state debts or the failure to pay interest on them. He was zealous for Irish repeal, once held a place in the "Directory of the Friends of Ireland," and contributed liberally to its support. He used the occasion of Charles Dickens's first visit to America to urge international copyright, and was one of the few editors to avoid alike the flunkeyism with which Dickens was first received, and the ferocity with which he was assailed after the publication of his *American Notes*. On the occasion of Dickens's second visit to America, Greeley presided at the great banquet given him by the press of the country. He made the first elaborate reports

of popular scientific lectures by Louis Agassiz and other authorities. He gave ample hearing to the advocates of phonography and of phonographic spelling. He was one of the most conspicuous advocates of the Pacific railroads, and of many other internal improvements.

But it is as an anti-slavery leader, and as perhaps the chief agency in educating the mass of the Northern people to that opposition through legal forms to the extension of slavery which culminated in the election of Abraham Lincoln and the Civil War, that Greeley's main work was done. Incidents in it were his vehement opposition to the Mexican War as a scheme for more slavery territory, the assault made upon him in Washington by Congressman Albert Rust of Arkansas in 1856, an indictment in Virginia in the same year for circulating incendiary documents, perpetual denunciation of him in Southern newspapers and speeches, and the hostility of the Abolitionists, who regarded his course as too conservative. His anti-slavery work culminated in his appeal to President Lincoln, entitled "The Prayer of Twenty Millions," in which he urged "that all attempts to put down the rebellion and at the same time uphold its inciting cause" were preposterous and futile, and that "every hour of deference to slavery" was "an hour of added and deepened peril to the Union." President Lincoln in his reply said: "My paramount object is to save the Union, and not either to save or destroy slavery.... What I do about slavery and the coloured race, I do because I believe it helps to save this Union; and what I forbear, I forbear because I do not believe it would help to save the Union.... I have here stated my purpose according to my views of official duty; and I intend no modification of my oft-expressed personal wish that all men everywhere could be free." Precisely one month after the date of this reply the Emancipation Proclamation was issued.

Greeley's political activity, first as a Whig, and then as one of the founders of the Republican party, was incessant; but he held few offices. In 1848-1849 he served a three months' term in Congress, filling a vacancy. He introduced the first bill for giving small tracts of government land free to actual settlers, and published an exposure of abuses in the allowance of mileage to members, which corrected the evil, but brought him much personal obloquy. In the National Republican Convention in 1860, not being sent by the Republicans of his own state on account of his opposition to William Seward as a candidate, he was made a delegate for Oregon. His active hostility to Seward did much to prevent the success of that statesman, and to bring about instead the nomination of Abraham Lincoln. This was attributed by his opponents to personal motives, and a letter from Greeley to Seward, the publication of which he challenged, was produced, to show that in his struggling days he had been wounded at Seward's failure to offer him office. In 1861 he was a candidate for United States senator, his principal opponent being William M. Evarts. When it was clear that Evarts could not be elected, his supporters threw their votes for a third candidate, Ira Harris, who was thus chosen over Greeley by a small majority. At the outbreak of the war he favoured allowing the Southern states to secede, provided a majority of their people at a fair election should so decide, declaring "that he hoped never to live in a Republic wherof one section was pinned to the other by bayonets." When the war began he urged the most vigorous prosecution of it. The "On to Richmond" appeal, which appeared day after day in *The Tribune*, was incorrectly attributed to him, and it did not wholly meet his approval; but after the defeat in the first battle of Bull Run he was widely blamed for it. In 1864 he urged negotiations for peace with representatives of the Southern Confederacy in Canada, and was sent by President Lincoln to confer with them. They were found to have no sufficient authority. In 1864 he was one of the Lincoln Presidential electors for New York. At the close of the war, contrary to the general feeling of his party, he urged universal amnesty and impartial suffrage as the basis of reconstruction. In 1867 his friends again wished to elect him to the Senate of the United

States, and the indications were all in his favour. But he refused to be elected under any misapprehension of his attitude, and with what his friends thought unnecessary candour re-stated his obnoxious views on universal amnesty at length, just before the time for the election, with the certainty that this would prevent his success. Some months later he signed the bail bond of Jefferson Davis, and this provoked a torrent of public indignation. He had written a popular history of the late war, the first volume having an immense sale and bringing him unusually large profits. The second was just issued, and the subscribers, in their anger, refused by thousands to receive it. An unsuccessful attempt was also made to expel him from the Union League Club of New York.

In 1867 he was a delegate-at-large to the convention for the revision of the state constitution, and in 1869 and 1870 he was the Republican candidate for controller of the state and member of Congress respectively, but in each case was defeated.

He was dissatisfied with General Grant's administration, and became its sharp critic. The discontent which he did much to develop ended in the organization of the Liberal Republican party, which held its National Convention at Cincinnati in 1872, and nominated Greeley for the presidency. For a time the tide of feeling ran strongly in his favour. It was first checked by the action of his life-long opponents, the Democrats, who also nominated him at their National Convention. He expected their support, on account of his attitude toward the South and hostility to Grant, but he thought it a mistake to give him their formal nomination. The event proved his wisdom. Many Republicans who had sympathized with his criticisms of the administration, and with the declaration of principles adopted at the first convention, were repelled by the coalition. This feeling grew stronger until the election. His old party associates regarded him as a renegade, the Democrats gave him a half-hearted support. The tone of the canvass was one of unusual bitterness, amounting sometimes to actual ferocity. In August, on representations of the alarming state of the contest, he took the field in person, and made a series of campaign speeches, beginning in New England and extending throughout Pennsylvania, Ohio and Indiana, which aroused great enthusiasm, and were regarded at the time by both friends and opponents as the most brilliant continuous exhibition of varied intellectual power ever made by a candidate in a presidential canvass. General Grant received in the election 3,597,070 votes, Greeley 2,834,070. The only states Greeley carried were Georgia, Kentucky, Maryland, Missouri, Tennessee and Texas.

He had resigned his editorship of *The Tribune* immediately after the nomination; he now resumed it cheerfully; but it was soon apparent that his powers had been overstrained. For years he had suffered greatly from sleeplessness. During the intense excitement of the campaign the difficulty was increased. Returning from his campaign tour, he went immediately to the bedside of his dying wife, and for some weeks had practically no sleep at all. This resulted in an inflammation of the upper membrane of the brain, delirium and death. He expired on the 29th of November 1872. His funeral was a simple but impressive public pageant. The body lay in state in the City Hall, where it was surrounded by crowds of many thousands. The ceremonies were attended by the President and Vice-President of the United States, the Chief-Justice of the Supreme Court, and a large number of eminent public men of both parties, who followed the hearse in a solemn procession, preceded by the mayor and other civic authorities, down Broadway. He had been the target of constant attack during his life, and his personal foibles, careless dress and mental eccentricities were the theme of endless ridicule. But his death revealed the high regard in which he was generally held as a leader of opinion and faithful public servant. "Our later Franklin" Whittier called him, and it is in some such light his countrymen remember him.

In 1851 Greeley visited Europe for the first time, serving as a jurymen at the Crystal Palace Exhibition, appearing before a committee of the House of Commons on newspaper taxes,

and urging the repeal of the stamp duty on advertisements. In 1855 he made a second trip to Europe. In Paris he was arrested on the suit of a sculptor, whose statue had been injured in the New York World's Fair (of which he had been a director), and spent two days in Clichy, of which he gave an amusing account. In 1859 he visited California by the overland route, and had numerous public receptions. In 1871 he visited Texas, and his trip through the southern country, where he had once been so hated, was an ovation. About 1852 he purchased a farm at Chappaqua, New York, where he afterwards habitually spent his Saturdays, and experimented in agriculture. He was in constant demand as a lecturer from 1843, when he made his first appearance on the platform, always drew large audiences, and, in spite of his bad management in money matters, received considerable sums, sometimes \$6000 or \$7000 for a single winter's lecturing. He was also much sought for as a contributor, over his own signature, to the weekly newspapers, and was sometimes largely paid for these articles. In religious faith he was from boyhood a Universalist, and for many years was a conspicuous member of the leading Universalist church in New York.

His published works are: *Hints Toward Reforms* (1850); *Glances at Europe* (1851); *History of the Struggle for Slavery Extension* (1856); *Overland Journey to San Francisco* (1860); *The American Conflict* (2 vols., 1864-1866); *Recollections of a Busy Life* (1868; new edition, with appendix containing an account of his later years, his argument with Robert Dale Owen on Marriage and Divorce, and Miscellanies, 1873); *Essays on Political Economy* (1870); and *What I know of Farming* (1871). He also assisted his brother-in-law, John F. Cleveland, in editing *A Political Text-book* (1860), and supervised for many years the annual issues of *The Whig Almanac* and *The Tribune Almanac*, comprising extensive political statistics.

The best Lives of Greeley are those by James Parton (New York, 1855; new ed., Boston, 1872) and W. A. Linn (N.Y. 1903). Lives have also been written by L. U. Reavis (New York, 1872), and L. D. Ingersoll (Chicago, 1873); and there is a *Memorial of Horace Greeley* (New York, 1873). (W. R.)

GREELEY, a city and the county-seat of Weld county, Colorado, U.S.A., about 50 m. N. by E. of Denver. Pop. (1890) 2395; (1900) 3023 (286 foreign-born); (1910) 8179. It is served by the Union Pacific and the Colorado & Southern railways. In 1908 a franchise was granted to the Denver & Greeley Electric railway. The city is the seat of the State Normal School of Colorado (1889). There are rich coal-fields near the city. The county is naturally arid and unproductive, and its agricultural importance is due to an elaborate system of irrigation. In 1899 Weld county had under irrigation 226,613 acres, representing an increase of 102.2% since 1889, and a much larger irrigated area than in any other county of the state. Irrigation ditches are supplied with water chiefly from the Cache la Poudre, Big Thompson and South Platte rivers, near the foothills. The principal crops are potatoes, sugar beets, onions, cabbages and peas; in 1899 Weld county raised 2,821,285 bushels of potatoes on 23,195 acres (53% of the potato acreage for the entire state). The manufacture of beet sugar is a growing industry, a large factory having been established at Greeley in 1902. Beets are also grown as food for live stock, especially sheep. Peas, tomatoes, cabbages and onions are canned here. Greeley was founded in 1870 by Nathan Cook Meeker (1817-1879), agricultural editor of the New York *Tribune*. With the support of Horace Greeley (in whose honour the town was named), he began in 1869 to advocate in *The Tribune* the founding of an agricultural colony in Colorado. Subsequently President Hayes appointed him Indian agent at White River, Colorado, and he was killed at what is now Meeker, Colorado, in an uprising of the Ute Indians. Under Meeker's scheme, which attracted mainly people from New England and New York state, most of whom were able to contribute at least a little capital, the Union Colony of Colorado was organized and chartered, and bought originally 11,000 acres of land, each member being entitled to buy from it one residence lot, one business lot, and a tract of farm land.

The funds thus acquired were, to a large extent, expended in making public improvements. A clause inserted in all deeds forbade the sale of intoxicating liquors on the land concerned, under pain of the reversion of such property to the colony. The initiation fees (\$5) were used for the expenses of locating the colony, and the membership certificate fees (\$1.50) were expended in the construction of irrigating ditches, as was the money received from the sale of town lots, except about \$13,000 invested in a school building (now the Meeker Building). Greeley was organized as a town in 1871, and was chartered as a city of the second class in 1886. The "Union Colony of Colorado" still exists as an incorporated body and holds reversionary rights in streets, alleys and public grounds, and in all places "where intoxicating liquors are manufactured, sold or given away, as a beverage."

See Richard T. Ely, "A Study of a 'Decreed' Town," *Harper's Magazine*, vol. 106 (1902-1903), p. 390 sqq.

GREEN, ALEXANDER HENRY (1832-1896), English geologist, son of the Rev. Thomas Sheldon Green, master of the Ashby Grammar School, was born at Maidstone on the 10th of October 1832. He was educated partly at his father's school, Ashby-de-la-Zouch, and afterwards at Gonville and Caius College, Cambridge, where he graduated as sixth wrangler in 1855 and was elected a fellow of his college. In 1861 he joined the Geological Survey of Great Britain, and surveyed large areas of the midland counties, Derbyshire and Yorkshire. He wrote (wholly or in part) memoirs on the Geology of Banbury (1864), of Stockport (1866), of North Derbyshire (1869, 2nd ed. 1887), and of the Yorkshire Coal-field (1878). In 1874 he retired from the Geological Survey, having been appointed professor of geology in the Yorkshire College at Leeds; in 1885 he became also professor of mathematics, while for many years he held the lectureship on geology at the school of military engineering at Chatham. He was elected F.R.S. in 1886, and two years later was chosen professor of geology in the university of Oxford. His manual of *Physical Geology* (1876, 3rd ed. 1882) is an excellent book. He died at Boar's Hill, Oxford, on the 19th of August 1896.

A portrait of him, with brief memoir, was published in *Proc. Yorksh. Geol. and Polytechnic Soc.* xiii. 232.

GREEN, DUFF (1791-1875), American politician and journalist, was born in Woodford county, Kentucky, on the 15th of August 1791. He was a school teacher in his native state, served during the War of 1812 in the Kentucky militia, and then settled in Missouri, where he worked as a schoolmaster and practised law. He was a member of the Missouri Constitutional Convention of 1820, and was elected to the state House of Representatives in 1820 and to the state Senate in 1822, serving one term in each house. Becoming interested in journalism, he purchased and for two years edited the *St. Louis Enquirer*. In 1825 he bought and afterwards edited in Washington, D.C., *The United States Telegraph*, which soon became the principal organ of the Jackson men in opposition to the Adams administration. Upon Andrew Jackson's election to the presidency, the *Telegraph* became the principal mouthpiece of the administration, and received printing patronage estimated in value at \$50,000 a year, while Green became one of the coterie of unofficial advisers of Jackson known as the "Kitchen Cabinet." In the quarrel between Jackson and John C. Calhoun, Green supported the latter, and through the columns of the *Telegraph* violently attacked the administration. In consequence, his paper was deprived of the government printing in the spring of 1831. Green, however, continued to edit it in the Calhoun interest until 1835, and gave vigorous support to that leader's nullification views. From 1835 to 1838 he edited *The Reformation*, a radically partisan publication, devoted to free trade and the extreme states' rights theory. In 1841-1843 he was in Europe on behalf of the Tyler administration, and he is said to have been instrumental in causing the appointment of Lord Ashburton to negotiate in Washington concerning the boundary dispute between Maine and Canada. In January 1843 Green established in New York City a short-lived journal, *The Republic*, to combat the spoils system and to advocate free trade. In September 1844 Calhoun, then secretary of state, sent Green to Texas ostensibly as consul at Galveston,

but actually, it appears, to report to the administration, then considering the question of the annexation of Texas, concerning the political situation in Texas and Mexico. After the close of the war with Mexico Green was sent to that country in 1849 by President Taylor to negotiate concerning the moneys which, by the treaty of Guadalupe Hidalgo, the United States had agreed to pay; and he saved his country a considerable sum by arranging for payment in exchange instead of in specie. Subsequently Green was engaged in railway building in Georgia and Alabama. On the 10th of June 1875 he died in Dalton, Georgia, a city which in 1848 he had helped to found.

GREEN, JOHN RICHARD (1837-1883), English historian, was born at Oxford on 12th December 1837, and educated at Magdalen College School and at Jesus College, where he obtained an open scholarship. On leaving Oxford he took orders and became the incumbent of St. Philip's, Stepney. His preaching was eloquent and able; he worked diligently among his poor parishioners and won their affection by his ready sympathy. Meanwhile he studied history in a scholarly fashion, and wrote much for the *Saturday Review*. Partly because his health was weak and partly because he ceased to agree with the teaching of the Church of England, he abandoned clerical life and devoted himself to history; in 1868 he took the post of librarian at Lambeth, but his health was already breaking down and he was attacked by consumption. His *Short History of the English People* (1874) at once attained extraordinary popularity, and was afterwards expanded in a work of four volumes (1877-1880). Green is pre-eminently a picturesque historian; he had a vivid imagination and a keen eye for colour. His chief aim was to depict the progressive life of the English people rather than to write a political history of the English state. In accomplishing this aim he worked up the results of wide reading into a series of brilliant pictures. While generally accurate in his statement of facts, and showing a firm grasp of the main tendency of a period, he often builds more on his authorities than is warranted by their words, and is apt to overlook points which would have forced him to modify his representations and lower the tone of his colours. From his animated pages thousands have learned to take pleasure in the history of their own people, but could scarcely learn to appreciate the complexity inherent in all historical movement. His style is extremely bright, but it lacks sobriety and presents some affectations. His later histories, *The Making of England* (1882) and *The Conquest of England* (1883), are more soberly written than his earlier books, and are valuable contributions to historical knowledge. Green died at Mentone on the 7th of March 1883. He was a singularly attractive man, of wide intellectual sympathies and an enthusiastic temperament; his good-humour was unflinching and he was a brilliant talker; and his work was done with admirable courage in spite of ill-health. It is said that Mrs. Humphry Ward's *Robert Elsmere* is largely a portrait of him. In 1877 Green married Miss Alice Stopford; and Mrs. Green, besides writing a memoir of her husband, prefixed to the 1888 edition of his *Short History*, has herself done valuable work as an historian, particularly in her *Henry II.* in the "English Statesmen" series (1888), her *Town Life in the 15th Century* (1894), and *The Making of Ireland and its Undoing* (1908).

See the *Letters of J. R. Green* (1901), edited by Leslie Stephen.

(W. HU.)

GREEN, MATTHEW (1696-1737), English poet, was born of Nonconformist parents. He had a post in the custom house, and the few anecdotes that have been preserved of him show him to have been as witty as his poems would lead one to expect. He died unmarried at his lodging in Nag's Head Court, Gracechurch Street, in 1737. His *Grotto*, a poem on Queen Caroline's grotto at Richmond, was printed in 1732; and his chief poem, *The Spleen*, in 1737 with a preface by his friend Richard Glover. These and some other short poems were printed in Dodsley's collection (1748), and subsequently in various editions of the British poets. They were edited in 1796 with a preface by Dr. Aikin and in 1883 by R. E. A. Willmott with the poems of Gray and others. *The Spleen* is an epistle to Mr. Cuthbert Jackson,

advocating cheerfulness, exercise and a quiet content as remedies. It is full of witty sayings. Thomas Gray said of it: "There is a profusion of wit everywhere; reading would have formed his judgment, and harmonized his verse, for even his wood-notes often break out into strains of real poetry and music."

GREEN, THOMAS HILL (1836-1882), English philosopher, the most typical English representative of the school of thought called *Neo-Kantian*, or *Neo-Hegelian*, was born on the 7th of April 1836 at Birkin, a village in the West Riding of Yorkshire, of which his father was rector. On the paternal side he was descended from Oliver Cromwell, whose honest, sturdy independence of character he seemed to have inherited. His education was conducted entirely at home until, at the age of fourteen, he entered Rugby, where he remained five years. In 1855 he became an undergraduate member of Balliol College, Oxford, of which society he was, in 1860, elected fellow. His life, henceforth, was devoted to teaching (mainly philosophical) in the university—first as college tutor, afterwards, from 1878 until his death (at Oxford on the 26th of March 1882) as Whyte's Professor of Moral Philosophy. The lectures he delivered as professor form the substance of his two most important works, viz. the *Prolegomena to Ethics* and the *Lectures on the Principles of Political Obligation*, which contain the whole of his positive constructive teaching. These works were not published until after his death, but Green's views were previously known indirectly through the *Introduction* to the standard edition of Hume's works by Green and T. H. Grose (d. 1906), fellow of Queen's College, in which the doctrine of the "English" or "empirical" philosophy was exhaustively examined.

Hume's empiricism, combined with a belief in biological evolution (derived from Herbert Spencer), was the chief feature in English thought during the third quarter of the 19th century. Green represents primarily the reaction against doctrines which, when carried out to their logical conclusion, not only "rendered all philosophy futile," but were fatal to practical life. By reducing the human mind to a series of unrelated atomic sensations, this teaching destroyed the possibility of knowledge, and further, by representing man as a "being who is simply the result of natural forces," it made conduct, or any theory of conduct, unmeaning; for life in any human, intelligible sense implies a personal self which (1) *knows* what to do, (2) *has power* to do it. Green was thus driven, not theoretically, but as a practical necessity, to raise again the whole question of man in relation to nature. When (he held) we have discovered what man in himself is, and what his relation to his environment, we shall then know his function—what he is fitted to do. In the light of this knowledge we shall be able to formulate the moral code, which, in turn, will serve as a criterion of actual civic and social institutions. These form, naturally and necessarily, the objective expression of moral ideas, and it is in some civic or social whole that the moral ideal must finally take concrete shape.

To ask "What is man?" is to ask "What is experience?" for experience means that of which I am conscious. The facts of consciousness are the only facts which, to begin with, we are justified in asserting to exist. On the other hand, they are valid evidence for whatever is necessary to their own explanation, i.e. for whatever is logically involved in them. Now the most striking characteristic of man, that in fact which marks him specially, as contrasted with other animals, is *self-consciousness*. The simplest mental act into which we can analyse the operations of the human mind—the act of sense-perception—is never merely a *change*, physical or psychical, but is the *consciousness* of a change. Human experience consists, not of processes in an animal organism, but of these processes recognized as such. That which we perceive is from the outset an apprehended fact—that is to say, it cannot be analysed into isolated elements (so-called sensations) which, as such, are not constituents of consciousness at all, but exists from the first as a synthesis of relations in a consciousness which keeps distinct the "self" and the various elements of the "object," though holding all together in the unity of the act of perception. In other words, the whole mental structure we call knowledge consists, in its simplest equally with

its most complex constituents, of the "work of the mind." Locke and Hume held that the work of the mind was *eo ipso* unreal because it was "made by" man and not "given to" man. It thus represented a subjective creation, not an objective fact. But this consequence follows only upon the assumption that the work of the mind is arbitrary, an assumption shown to be unjustified by the results of exact science, with the distinction universally recognized, which such science draws between truth and falsehood, between the real and "mere ideas." This (obviously valid) distinction logically involves the consequence that the object, or content, of knowledge, viz. reality, is an intelligible ideal reality, a system of thought relations, a spiritual cosmos. How is the existence of this ideal whole to be accounted for? Only by the existence of some "principle which renders all relations possible and is itself determined by none of them"; an eternal self-consciousness which knows in whole what we know in part. To God the world *is*, to man the world *becomes*. Human experience is God gradually made manifest.

Carrying on the same analytical method into the special department of moral philosophy, Green held that ethics applies to the peculiar conditions of social life that investigation into man's nature which metaphysics began. The faculty employed in this further investigation is no "separate moral faculty," but that same reason which is the source of all our knowledge—ethical and other. Self-reflection gradually reveals to us human capacity, human function, with, consequently, human responsibility. It brings out into clear consciousness certain potentialities in the realization of which man's true good must consist. As the result of this analysis, combined with an investigation into the surroundings man lives in, a "content"—a moral code—becomes gradually evolved. Personal good is perceived to be realizable only by making actual the conceptions thus arrived at. So long as these remain potential or ideal, they form the motive of action; motive consisting always in the idea of some "end" or "good" which man presents to himself as an end in the attainment of which he would be satisfied, that is, in the realization of which he would find his true self. The determination to realize the self in some definite way constitutes an "act of will," which, as thus constituted, is neither arbitrary nor externally determined. For the motive which may be said to be its cause lies *in* the man himself, and the identification of the self with such a motive is a *self-determination*, which is at once both rational and free. The "freedom of man" is constituted, not by a supposed ability to do anything he may choose, but in the power to identify himself with that true good which reason reveals to him as *his* true good. This good consists in the realization of personal character; hence the final good, i.e. the moral ideal, as a whole, can be realized only in some society of persons who, while remaining ends to themselves in the sense that their individuality is not lost but rendered more perfect, find this perfection attainable only when the separate individualities are integrated as part of a social whole. Society is as necessary to form persons as persons are to constitute society. Social union is the indispensable condition of the development of the special capacities of the individual members. Human self-perfection cannot be gained in isolation; it is attainable only in inter-relation with fellow-citizens in the social community.

The law of our being, so revealed, involves in its turn civic or political duties. Moral goodness cannot be limited to, still less constituted by, the cultivation of self-regarding virtues, but consists in the attempt to realize in practice that moral ideal which self-analysis has revealed to us as *our* ideal. From this fact arises the ground of political obligation, for the institutions of political or civic life are the concrete embodiment of moral ideas in terms of our day and generation. But, as society exists only for the proper development of persons, we have a criterion by which to test these institutions, viz. do they, or do they not, contribute to the development of moral character in the individual citizens? It is obvious that the final moral ideal is not realized in any body of civic institutions actually existing, but the same analysis which demonstrates this deficiency points out the direction which a true development will take. Hence arises the

conception of rights and duties which *should* be maintained by law, as opposed to those actually maintained; with the further consequence that it may become occasionally a moral duty to rebel against the state in the interest of the state itself, that is, in order better to subserve that end or function which constitutes the *raison d'être* of the state. The state does not consist in any definite concrete organization formed once for all. It represents a "general will" which is a desire for a common good. Its basis is not a coercive authority imposed upon the citizens from without, but consists in the spiritual recognition, on the part of the citizens, of that which constitutes their true nature. "Will, not force, is the basis of the state."

Green's teaching was, directly and indirectly, the most potent philosophical influence in England during the last quarter of the 19th century, while his enthusiasm for a common citizenship, and his personal example in practical municipal life, inspired much of the effort made, in the years succeeding his death, to bring the universities more into touch with the people, and to break down the rigour of class distinctions.

Of his philosophical doctrine proper, the most striking characteristic is Integration, as opposed to Disintegration, both in thought and in reality. "That which is" is a *whole*, not an *aggregate*; an organic complex of parts, not a mechanical mass; a "whole," too not material but spiritual, a "world of thought-relations." On the critical side this teaching is now admittedly valid against the older empiricism, and the cogency of the reasoning by which his constructive theory is supported is generally recognized. Nevertheless, Green's statement of his conclusions presents important difficulties. Even apart from the impossibility of conceiving a whole of relations which are relations and nothing else (this objection is perhaps largely verbal), no explanation is given of the fact (obvious in experience) that the spiritual entities of which the Universe is composed *appear* material. Certain elements present themselves in feeling which seem stubbornly to resist any attempt to explain them in terms of thought. While, again, legitimately insisting upon personality as a fundamental constituent in any true theory of reality, the relation between human individualities and the divine Person is left vague and obscure; nor is it easy to see how the existence of several individualities—human or divine—in *one* cosmos is theoretically possible. It is at the solution of these two questions that philosophy in the immediate future may be expected to work.

Green's most important treatise—the *Prolegomena to Ethics*—practically complete in manuscript at his death—was published in the year following, under the editorship of A. C. Bradley (4th ed., 1899). Shortly afterwards R. L. Nettleship's standard edition of his *Works* (exclusive of the *Prolegomena*) appeared in three volumes: vol. i. containing reprints of Green's criticism of Hume, Spinoza, and Lewes; vol. ii. Lectures on Kant, on Logic, on the Principles of Political Obligation; vol. iii. Miscellanies, preceded by a full *Memoir* by the Editor. The *Principles of Political Obligation* was afterwards published in separate form. A criticism of *Neo-Hegelianism* will be found in Andrew Seth (Pringle Pattison), *Hegelianism and Personality*. See also articles in *Mind* (January and April 1884) by A. J. Balfour and Henry Sidgwick, in the *Academy* (xxviii. 242 and xxv. 297) by S. Alexander, and in the *Philosophical Review* (vi., 1897) by S. S. Laurie; W. H. Fairbrother, *Philosophy of T. H. Green* (London and New York, 1896); D. G. Ritchie, *The Principles of State Interference* (London, 1891); H. Sidgwick, *Lectures on the Philosophy of Kant* (London, 1905); J. H. Muirhead, *The Service of the State: Four Lectures on the Political Teaching of T. H. Green* (1908); A. W. Benn, *English Rationalism in the XIXth Century* (1906), vol. ii., pp. 401 foll. (W. H. F. * X.)

GREEN, VALENTINE (1730–1813), British engraver, was born at Halesowen. He was placed by his father in a solicitor's office at Evesham, where he remained for two years; but ultimately he decided, on his own responsibility, to abandon the legal profession and became a pupil of a line engraver at Worcester. In 1765 he migrated to London and began work as a mezzotint engraver, having taught himself the technicalities of this art, and quickly rose to a position in absolutely the front rank of British engravers. He became a member of the Incorporated Society of Artists in 1767, an associate-engraver of the Royal Academy in 1775, and for some forty years he followed his profession with the greatest success. The exclusive right of engraving and publishing plates from the pictures in the Düsseldorf gallery was granted him by the duke of Bavaria in 1789, but, after he had issued more than twenty of these plates, the siege of that city by the French put an end to this undertaking and caused him serious financial loss. From this cause, and through the failure of certain other speculations, he was reduced to poverty; and in consequence he took the post of keeper of the British Institution

in 1805, and continued in this office for the remainder of his life. During his career as an engraver he produced some four hundred plates after portraits by Reynolds, Romney, and other British artists, after the compositions of Benjamin West, and after pictures by Van Dyck, Rubens, Murillo, and other old masters. It is claimed for him that he was one of the first engravers to show how admirably mezzotint could be applied to the translation of pictorial compositions as well as portraits, but at the present time it is to his portraits that most attention is given by collectors. His engravings are distinguished by exceptional richness and subtlety of tone, and by very judicious management of relations of light and shade; and they have, almost without exception, notable freshness and grace of handling.

See *Valentine Green*, by Alfred Whitman (London, 1902).

GREEN, WILLIAM HENRY (1825–1900), American Hebrew scholar, was born in Groveville, near Bordentown, New Jersey, on the 27th of January 1825. He was descended in the sixth generation from Jonathan Dickinson, first president of the College of New Jersey (now Princeton University), and his ancestors had been closely connected with the Presbyterian church. He graduated in 1840 from Lafayette College, where he was tutor in mathematics (1840–1842) and adjunct professor (1843–1844). In 1846 he graduated from Princeton Theological Seminary, and was instructor in Hebrew there in 1846–1849. He was ordained in 1848 and was pastor of the Central Presbyterian church of Philadelphia in 1849–1851. From August 1851 until his death, in Princeton, New Jersey, on the 10th of February 1900, he was professor of Biblical and Oriental Literature in Princeton Theological Seminary. From 1859 the title of his chair was Oriental and Old Testament Literature. In 1868 he refused the presidency of Princeton College; as senior professor he was long acting head of the Theological Seminary. He was a great Hebrew teacher: his *Grammar of the Hebrew Language* (1861, revised 1888) was a distinct improvement in method on Gesenius, Roediger, Ewald and Nordheimer. All his knowledge of Semitic languages he used in a "conservative Higher Criticism," which is maintained in the following works: *The Pentateuch Vindicated from the Aspersions of Bishop Colenso* (1863), *Moses and the Prophets* (1883), *The Hebrew Feasts in their Relation to Recent Critical Hypotheses Concerning the Pentateuch* (1885), *The Unity of the Book of Genesis* (1895), *The Higher Criticism of the Pentateuch* (1895), and *A General Introduction to the Old Testament*, vol. i. *Canon* (1898), vol. ii. *Text* (1899). He was the scholarly leader of the orthodox wing of the Presbyterian church in America, and was moderator of the General Assembly of 1891. Green was chairman of the Old Testament committee of the Anglo-American Bible revision committee.

See the articles by John D. Davis in *The Biblical World*, new series, vol. xv., pp. 406–413 (Chicago, 1900), and *The Presbyterians and Reformed Review*, vol. xi. pp. 377–396 (Philadelphia, 1900).

GREENAWAY, KATE (1846–1901), English artist and book illustrator, was the daughter of John Greenaway, a well-known draughtsman and engraver on wood, and was born in London on the 17th of March 1846. After a course of study at South Kensington, at "Heatherley's" life classes, and at the Slade School, Kate Greenaway began, in 1868, to exhibit water-colour drawings at the Dudley Gallery, London. Her more remarkable early work, however, consisted of Christmas cards, which, by reason of their quaint beauty of design and charm of draughtsmanship, enjoyed an extraordinary vogue. Her subjects were, in the main, young girls, children, flowers, and landscape; and the air of artless simplicity, freshness, humour, and purity of these little works so appealed to public and artists alike that the enthusiastic welcome habitually accorded to them is to be attributed to something more than love of novelty. In the line she had struck out Kate Greenaway was encouraged by H. Stacy Marks, R.A., and she refused to listen to those friends who urged her to return to a more conventional manner. Thenceforward her illustrations for children (such as for *Little Folks*, 1873, *et seq.*) attracted much attention. In 1877 her drawings at the Dudley Gallery were sold for £54, and her Royal Academy picture for eighteen guineas; and in the same year she began to draw for the

Illustrated London News. In the year 1879 she produced *Under the Window*, of which 150,000 copies are said to have been sold, and of which French and German editions were also issued. Then followed *The Birthday Book*, *Mother Goose*, *Little Ann*, and other books for children which were appreciated not less by adults, and were to be found on sale in the bookshops of every capital in Europe and in the cities of America. The extraordinary success achieved by the young girl may be estimated by the amounts paid to her as her share of the profits: for *Under the Window* she received £1130; for *The Birthday Book*, £1290; for *Mother Goose*, £905; and for *Little Ann*, £567. These four books alone produced a clear return of £8000. "Toy-books" though they were, these little works created a revolution in illustration, and so were of real importance; they were loudly applauded by John Ruskin (*Art of England and Fors Clavigera*), by Ernest Chesneau and Arsène Alexandre in France, by Dr Muther in Germany, and by leading art-critics throughout the world. In 1890 Kate Greenaway was elected a member of the Royal Institute of Painters in Water Colours, and in 1897, 1894 and 1898 she exhibited water-colour drawings, including illustrations for her books, at the gallery of the Fine Art Society (by which a representative selection was exhibited in 1902), where they surprised the world by the infinite delicacy, tenderness, and grace which they displayed. A leading feature in Miss Greenaway's work was her revival of the delightfully quaint costume of the beginning of the 19th century; this lent humour to her fancy, and so captivated the public taste that it has been said, with poetic exaggeration, that "Kate Greenaway dressed the children of two continents." Her drawings of children have been compared with Stothard's for grace and with Reynolds's for naturalness, and those of flowers with the work of van Huysum and Botticelli. From 1883 to 1897, with a break only in 1896, she issued a series of *Kate Greenaway's Almanacs*. Although she illustrated *The Pied Piper of Hamelin* and other works, the artist preferred to provide her own text; the numerous verses which were found among her papers after her death prove that she might have added to her reputation with her pen. She had great charm of character, but was extremely shy of public notice, and not less modest in private life. She died at Hampstead on the 6th of November 1905.

See the *Life*, by M. H. Spielmann and G. S. Layard (1905).

(M. H. S.)

GREENBACKS, a form of paper currency in the United States, so named from the green colour used on the backs of the notes.—They are treasury notes, and were first issued by the government in 1862, "as a question of hard necessity," to provide for the expenses of the Civil War. The government, following the example of the banks, had suspended specie payment. The new notes were therefore for the time being an inconvertible paper currency, and, since they were made legal tender, were really a form of fiat money. The first act, providing for the issue of notes to the amount of \$250,000,000, was that of the 25th February 1862; the acts of 11th July 1862 and 3rd March 1863 each authorized further issues of \$150,000,000. The notes soon depreciated in value, and at the lowest were worth only 35 cents on the dollar. The act of 12th April 1866 authorized the retirement of \$10,000,000 of notes within six months and of \$4,000,000 per month thereafter; this was discontinued by act of 4th February 1868. On 1st January 1879 specie payment was resumed, and the nominal amount of notes then stood at \$346,681,000, which is still outstanding.

The so-called *Greenback party* (also called the *Independent*, and the *National party*) first appeared in a presidential campaign in 1876, when its candidate, Peter Cooper, received 81,740 votes. It advocated increasing the volume of greenbacks, forbidding bank issues, and the paying in greenbacks of the principal of all government bonds not expressly payable in coin. In 1878 the party, by various fusions, cast over 1,000,000 votes and elected 14 Congressmen; and in 1880 there was fusion with labour reformers and it cast 308,578 votes for its presidential candidate, J. B. Weaver, and elected 8 Congressmen. In 1884, their candidate Benjamin F. Butler (also the candidate of the Anti-Monopoly party) received 175,370 votes. Subsequently the party went out of existence.

GREEN BAY, a city and the county-seat of Brown county, Wisconsin, U.S.A., at the S. extremity of Green Bay, at the

mouth of the Fox river, 114 m. N. of Milwaukee. Pop. (1890) 9069; (1900) 18,584, of whom 4029 were foreign-born and 33 were negroes; (1910 census) 25,236. The city is served by the Chicago & North-Western, the Chicago, Milwaukee & St Paul, the Kewaunee, Green Bay & Western, and the Green Bay & Western railways, by an inter-urban electric railway connecting with other Fox River Valley cities, and by lake and river steamboat lines. Green Bay lies on high level ground on both sides of the river, which is here crossed by several bridges. The city has the Kellogg Public Library, the Brown County Court House, two high schools, a business college, several academies, two hospitals, an orphan asylum and the State Odd Fellows' Home. It is the seat of a Roman Catholic cathedral, the bishopric being the earliest established in the North-west. The so-called "Tank Cottage," now in Washington Park, is said to be the oldest house in Wisconsin; it was built on the W. bank of the river near its mouth by Joseph Roy, a French-Canadian voyageur, in 1766, was subsequently somewhat modified, and in 1908 was bought and removed to its present site by the Green Bay Historical Society. Midway between Green Bay and De Pere (5 m. S.W. of Green Bay) is the state reformatory, opened in 1899-1901. Green Bay's fine harbour accommodates a considerable lake commerce, and the city is the most important railway and wholesale distributing centre in N.E. Wisconsin. Its manufactures include lumber and lumber products, furniture, wagons, woodenware, farm implements and machinery, flour, beer, canned goods, brick and tile and dairy products; and it has lumber yards, grain elevators, fish warehouses and railway repair shops. The total value of the factory product in 1905 was \$4,873,037, an increase of 79.9% since 1900. The first recorded visit of a European to the vicinity of what is now Green Bay is that of Jean Nicolet, who was sent west by Champlain in 1634, and found, probably at the Red Banks, some 10 m. below the present city, a village of Winnebago Indians, who he thought at first were Chinese. Between 1654 and 1658 Radisson and Groseilliers and other *coureurs des bois* were at Green Bay. Claude Jean Allouez, the Jesuit missionary, established a mission on the W. shore of the bay, about 30 m. from the present city. Later he removed his mission to the Red Banks, and in the winter of 1671-1672 established it permanently 5 m. above the present city, at Rapides des Pères, on the E. shore of the Fox river. In 1673 Joliet and Marquette visited the spot. In 1683-1685 Le Sueur and Nicholas Perrot traded with the Indians here. In 1718-1720 Fort St Francis was erected at the mouth of the river on the W. bank, and after being several times deserted was permanently re-established in 1732. About 1745 Augustin de Langlade established a trading post at La Baye and later brought his family there from Mackinac. This was the first permanent settlement at Green Bay and in Wisconsin. The British garrison which occupied the fort from 1761 to 1763, during which time the fort received the name of Fort Edward Augustus, was removed at the time of Pontiac's rising, and the fort was never re-garrisoned by the English, except for a short time during the War of 1812. The inhabitants of La Baye were, however, acknowledged subjects of Great Britain, the jurisdiction of the United States being practically a dead letter until the American fort (Fort Howard) was garrisoned in 1816. As early as 1810 fur traders, employed by John Jacob Astor, were stationed here; about 1820 Astor erected a warehouse and other buildings; and for many years Green Bay consisted of two distinct settlements, Astor and Navarino, which were finally united in 1839 as Green Bay. The city was chartered in 1854. In 1893 Fort Howard was consolidated with it. The *Green Bay Intelligencer*, the first newspaper in Wisconsin, began publication here in 1833.

See Neville and Martin, *Historic Green Bay* (Green Bay, 1893); and Martin and Beaumont, *Old Green Bay* (Green Bay, 1900).

GREENCASTLE, a city and the county-seat of Putnam county, Indiana, U.S.A., about 38 m. W. by S. of Indianapolis and on the Big Walnut river. Pop. (1900) 3661; (1910) 3790; it is served by the Cleveland, Cincinnati, Chicago & St. Louis,

the Chicago, Indianapolis & Louisville, the Vandalia, and the Terre Haute, Indianapolis & Eastern (electric) railways. It has manufactures of some importance, including lumber, pumps, kitchen-cabinets, drag-saws, lightning-rods and tin-plate, is in the midst of a blue grass region, and is a shipping point for beef cattle. The city has a Carnegie library and is the seat of the de Pauw University (co-educational), a Methodist Episcopal institution, founded as Indiana Asbury University in 1837, and renamed in 1884 in honour of Washington Charles de Pauw (1822-1887), a successful capitalist, banker and glass manufacturer. The total gifts of Mr de Pauw and his family to the institution amount to about \$600,000. Among the presidents of the university have been Bishop Matthew Simpson, Bishop Thomas Bowman (b. 1817), and Bishop Edwin Holt Hughes (b. 1866), all of the Methodist Episcopal church. The university comprises the Asbury College of Liberal Arts, a School of Music, a School of Art and an Academy, and had in 1909-1910 43 instructors, a library of 37,000 volumes, and 1017 students. Greencastle was first settled about 1820, and was chartered as a city in 1861.

GREENE, GEORGE WASHINGTON (1811-1883), American historian, was born at East Greenwich, Rhode Island, on the 8th of April 1811, the grandson of Major-General Nathanael Greene. He entered Brown University in 1824, left in his junior year on account of ill-health, was in Europe during the next twenty years, except in 1833-1834, when he was principal of Kent Academy at East Greenwich, and was the United States consul at Rome from 1837 to 1845. He was instructor in modern languages in Brown University from 1848 to 1852; and in 1871-1875 was non-resident lecturer in American history in Cornell University. He died at East Greenwich, Rhode Island, on the 2nd of February 1883. His published works include French and Italian text-books; *Historical Studies* (1850); *Biographical Studies* (1860); *Historical View of the American Revolution* (1865); *Life of Nathanael Greene* (3 vols., 1867-1871); *The German Element in the War of American Independence* (1876); and a *Short History of Rhode Island* (1877).

GREENE, MAURICE (1695-1755) English musical composer, was born in London. He was the son of a clergyman in the city, and soon became a chorister of St Paul's cathedral, where he studied under Charles King, and subsequently under Richard Brind, organist of the cathedral from 1707 to 1718, whom, on his death in the last-named year, he succeeded. Nine years later he became organist and composer to the chapel royal, on the death of Dr Croft. In 1730 he was elected to the chair of music in the university of Cambridge, and had the degree of doctor of music conferred on him. Dr Greene was a voluminous composer of church music, and his collection of *Forty Select Anthems* became a standard work of its kind. He wrote a "Te Deum," several oratorios, a masque, *The Judgment of Hercules*, and a pastoral opera, *Phoebe* (1748); also glee and catches; and a collection of *Catches and Canons for Three and Four Voices* is amongst his compositions. In addition he composed many occasional pieces for the king's birthday, having been appointed master of the king's band in 1735. But it is as a composer of church music that Greene is chiefly remembered. It is here that his contrapuntal skill and his sound musical scholarship are chiefly shown. With Handel, Greene was originally on intimate terms, but his equal friendship for Buononcini, Handel's rival, estranged the German master's feelings from him, and all personal intercourse between them ceased. Greene, in conjunction with the violinist Michael Christian Festing (1727-1752) and others, originated the Society of Musicians, for the support of poor artists and their families. He died on the 1st of December 1755.

GREENE, MATHANAE (1742-1786), American general, son of a Quaker farmer and smith, was born at Potowomut, in the township of Warwick, Rhode Island, on the 7th of August (not, as has been stated, 6th of June) 1742. Though his father's sect discouraged "literary accomplishments," he acquired a large amount of general information, and made a special study of mathematics, history and law. At Coventry, R.I., whither

he removed in 1770 to take charge of a forge built by his father and his uncle, he was the first to urge the establishment of a public school; and in the same year he was chosen a member of the legislature of Rhode Island, to which he was re-elected in 1771, 1772 and 1775. He sympathized strongly with the Whig, or Patriot, element among the colonists, and in 1774 joined the local militia. At this time he began to study the art of war. In December 1774 he was on a committee appointed by the assembly to revise the militia laws. His zeal in attending to military duty led to his expulsion from the Society of Friends.

In 1775, in command of the contingent raised by Rhode Island, he joined the American forces at Cambridge, and on the 22nd of June was appointed a brigadier by Congress. To him Washington assigned the command of the city of Boston after it was evacuated by Howe in March 1776. Greene's letters of October 1775 and January 1776 to Samuel Ward, then a delegate from Rhode Island to the Continental Congress, favoured a declaration of independence. On the 9th of August 1776 he was promoted to be one of the four new major-generals and was put in command of the Continental troops on Long Island; he chose the place for fortifications (practically the same as that picked by General Charles Lee) and built the redoubts and entrenchments of Fort Greene on Brooklyn Heights. Severe illness prevented his taking part in the battle of Long Island. He was prominent among those who advised a retreat from New York and the burning of the city, so that the British might not use it. Greene was placed in command of Fort Lee, and on the 25th of October succeeded General Israel Putnam in command of Fort Washington. He received orders from Washington to defend Fort Washington to the last extremity, and on the 11th of October Congress had passed a resolution to the same effect; but later Washington wrote to him to use his own discretion. Greene ordered Colonel Magaw, who was in immediate command, to defend the place until he should hear from him again, and reinforced it to meet General Howe's attack. Nevertheless, the blame for the losses of Forts Washington and Lee was put upon Greene, but apparently without his losing the confidence of Washington, who indeed himself assumed the responsibility. At Trenton Greene commanded one of the two American columns, his own, accompanied by Washington, arriving first; and after the victory here he urged Washington to push on immediately to Princeton, but was over-ruled by a council of war. At the Brandywine Greene commanded the reserve. At Germantown Greene's command, having a greater distance to march than the right wing under Sullivan, failed to arrive in good time—a failure which Greene himself thought (without cause) would cost him Washington's regard; on this, with the affair of Fort Washington, Bancroft based his unfavourable estimate of Greene's ability. But on their arrival, Greene and his troops distinguished themselves greatly.

At the urgent request of Washington, on the 2nd of March 1778, at Valley Forge, he accepted the office of quartermaster-general (succeeding Thomas Mifflin), and of his conduct in this difficult work, which Washington heartily approved, a modern critic, Colonel H. B. Carrington, has said that it was "as good as was possible under the circumstances of that fluctuating uncertain force." He had become quartermaster-general on the understanding, however, that he should retain the right to command troops in the field; thus we find him at the head of the right wing at Monmouth on the 28th of June. In August Greene and Lafayette commanded the land forces sent to Rhode Island to co-operate with the French admiral d'Estaing, in an expedition which proved abortive. In June 1780 Greene commanded in a skirmish at Springfield, New Jersey. In August he resigned the office of quartermaster-general, after a long and bitter struggle with Congress over the interference in army administration by the Treasury Board and by commissions appointed by Congress. Before his resignation became effective it fell to his lot to preside over the court which, on the 29th of September, condemned Major John André to death.

On the 14th of October he succeeded Gates as commander-in-chief of the Southern army, and took command at Charlotte, N.C.,

on the 2nd of December. The army was weak and badly equipped and was opposed by a superior force under Cornwallis. Greene decided to divide his own troops, thus forcing the division of the British as well, and creating the possibility of a strategic interplay of forces. This strategy led to General Daniel Morgan's victory of Cowpens (just over the South Carolina line) on the 17th of January 1781, and to the battle at Guilford Court House, N.C. (March 15), in which after having weakened the British troops by continual movements, and drawn in reinforcements for his own army, Greene was defeated indeed, but only at such cost to the victor that Tarleton called it "the pledge of ultimate defeat." Three days after this battle Cornwallis withdrew toward Wilmington. Greene's generalship and judgment were again conspicuously illustrated in the next few weeks, in which he allowed Cornwallis to march north to Virginia and himself turned swiftly to the reconquest of the inner country of South Carolina. This, in spite of a reverse sustained at Lord Rawdon's hands at Hobkirk's Hill (3 m. N. of Camden) on the 25th of April, he achieved by the end of June, the British retiring to the coast. Greene then gave his forces a six weeks' rest on the High Hills of the Santee, and on the 8th of September, with 2600 men, engaged the British under Lieut.-Colonel James Stuart (who had succeeded Lord Rawdon) at Eutaw Springs; the battle, although tactically drawn, so weakened the British that they withdrew to Charleston, where Greene penned them during the remaining months of the war. Greene's Southern campaign abounded remarkable strategic features that remind one of those of Turenne, the commander whom he had taken as his model in his studies before the war. He excelled in dividing, eluding and tiring his opponent by long marches, and in actual conflict forcing him to pay for a temporary advantage a price that he could not afford. He was greatly assisted by able subordinates, including the Polish engineer, Tadeusz Kosciuszko, the brilliant cavalry captains, Henry ("Light-Horse Harry") Lee and William Washington, and the partisan leaders, Thomas Sumter and Francis Marion.

South Carolina and Georgia voted Greene liberal grants of lands and money. The South Carolina estate, Boone's Barony, S. of Edisto in Bamberg County, he sold to meet bills for the rations of his Southern army. On the Georgia estate, Mulberry Grove, 14 m. above Savannah, on the river, he settled in 1785, after twice refusing (1781 and 1784) the post of secretary of war, and there he died of sunstroke on the 10th of June 1786. Greene was a singularly able, and—like other prominent generals on the American side—a self-trained soldier, and was second only to Washington among the officers of the American army in military ability. Like Washington he had the great gift of using small means to the utmost advantage. His attitude towards the Tories was humane and even kindly, and he generously defended Gates, who had repeatedly intrigued against him, when Gates's conduct of the campaign in the South was criticised. There is a monument to Greene in Savannah (1829). His statue, with that of Roger Williams, represents the state of Rhode Island in the National Hall of Statuary in the Capitol at Washington; in the same city there is a bronze equestrian statue of him by H. K. Brown.

See the *Life of Nathaniel Greene* (3 vols., 1867-1871), by his grandson, George W. Greene, and the biography (New York, 1893), by Brig.-Gen. F. V. Greene, in the "Great Commanders Series.

GREENE, ROBERT (c. 1560-1592), English dramatist and miscellaneous writer, was born at Norwich about 1560. The identity of his father has been disputed, but there is every reason to believe that he belonged to the tradesmen's class and had small means. It is doubtful whether Robert Greene attended Norwich grammar school; but, as an eastern counties man (to one of whose plays, *Friar Bacon*, the Norfolk and Suffolk borderland owes a lasting poetic commemoration) he naturally found his way to Cambridge, where he entered St John's College as a sizar in 1575 and took his B.A. thence in 1579, proceeding M.A. in 1583 from Clare Hall. His life at the university was, according to his own account, spent "among wags as lewd as himself, with whom he consumed the flower of his youth." In

1588 he was incorporated at Oxford, so that on some of his title-pages he styles himself "utriusque Academiae in Artibus Magister"; and Nashe humorously refers to him as "utriusque Academiae Robertus Greene." Between the years 1578 and 1583 he had travelled abroad, according to his own account very extensively, visiting France, Germany, Poland and Denmark, besides learning at first-hand to "hate the pride of Italie" and to know the taste of that poet's fruit, "Spanish mirabolones." The grounds upon which it has been suggested that he took holy orders are quite insufficient; according to the title-page of a pamphlet published by him in 1585 he was then a "student in phisicke." Already, however, after taking his M.A. degree, he had according to his own account begun his London life, and his earliest extant literary production was in hand as early as 1580. He now became "an author of playes and a penner of love-pamphlets, so that I soone grew famous in that qualitie, that who for that trade growne so ordinary about London as Robin Greene?" "Glad was that printer," says Nashe, "that might bee so blest to pay him deare for the very dregs of his wit." By his own account he rapidly sank into the worst debaucheries of the town, though Nashe declares that he never knew him guilty of notorious crime. He was not without passing impulses towards a more righteous and sober life, and was derided in consequence by his associates as a "Puritane and Presizian." It is possible that he, as well as his bitter enemy, Gabriel Harvey, exaggerated the looseness of his conduct. His marriage, which took place in 1585 or 1586, failed to steady him; if Francesco, in Greene's pamphlet *Never too late to mend* (1590), is intended for the author himself, it had been a runaway match; but the fiction and the autobiographical sketch in the *Repentance* agree in their account of the unfaithfulness which followed on the part of the husband. He lived with his wife, whose name seems to have been Dorothy ("Doll"; and cf. Dorothea in *James IV.*), for a while; "but forasmuch as she would perswade me from my wilful wickednes, after I had a child by her, I cast her off, having spent up the marriage-money which I obtained by her. Then left I her at six or seven, who went into Lincolnshire, and I to London," where his reputation as a playwright and writer of pamphlets of "love and vaine fantasies" continued to increase, and where his life was a feverish alternation of labour and debauchery. In his last years he took it upon himself to make war on the cutpurses and "conny-catchers" with whom he came into contact in the alms, and whose doings he fearlessly exposed in his writings. He tells us how at last he was friendless "except it were in a few alehouses," where he was respected on account of the score he had run up. When the end came he was a dependant on the charity of the poor and the pitying love of the unfortunate. Henri Murger has drawn no picture more sickening and more pitiful than the story of Greene's death, as told by his Puritan adversary, Gabriel Harvey—a veracious though a far from unprejudiced narrator. Greene had taken up the cudgels provided by the Harvey brothers on their intervention in the Marprelate controversy, and made an attack (immediately suppressed) upon Gabriel's father and family in the prose-tract *A Quisp for an Upstart Courtier, or a Quaint Dispute between Velvet Breeches and Cloth Breeches* (1592). After a banquet where the chief guest had been Thomas Nashe—an old associate and perhaps a college friend of Greene's, any great intimacy with whom, however, he seems to have been anxious to disclaim—Greene had fallen sick "of a surfeit of pickle herringe and Rennish wine." At the house of a poor shoemaker near Dowgate, deserted by all except his compassionate hostess (Mrs Isam) and two women—one of them the sister of a notorious thief named "Cutting Ball," and the mother of his illegitimate son, Fortunatus Greene—he died on the 3rd of September 1592. Shortly before his death he wrote under a bond for £10 which he had given to the good shoemaker, the following words addressed to his long-forsaken wife: "Doll, I charge thee, by the love of our youth and by my soules rest, that thou wilt see this man paid; for if hee and his wife had not succoured me, I had died in the streets.—Robert Greene."

Four Letters and Certain Sonnets, Harvey's attack on Greene.

appeared almost immediately after his death, as to the circumstances of which his relentless adversary had taken care to inform himself personally. Nashe took up the defence of his dead friend and ridiculed Harvey in *Strange News* (1593); and the dispute continued for some years. But, before this, the dramatist Henry Chettle published a pamphlet from the hand of the unhappy man, entitled *Greene's Groat's-worth of Wit bought with a Million of Repentance* (1592), containing the story of Roberto, who may be regarded, for practical purposes, as representing Greene himself. This ill-starred production may almost be said to have done more to excite the resentment of posterity against Greene's name than all the errors for which he professed his repentance. For in it he exhorted to repentance three of his *quondam* acquaintances. Of these three Marlowe was one—to whom and to whose creation of "that Atheist Tamburlaine" he had repeatedly alluded. The second was Peele, the third probably Nashe. But the passage addressed to Peele contained a transparent allusion to a fourth dramatist, who was an actor likewise, as "an upstart crow beautified with our feathers, that with his *Tygres heart wrapt in a player's hyde* supposes hee is as well able to bombast out a blanke-verse as the best of you; and being an absolute Iohannes-fac-totum, is in his owne conceyt the onely shake-scene in a countrey." The phrase italicized parodies a passage occurring in *The True Tragedie of Richard, Duke of York*, &c., and retained in Part III. of *Henry VI.* If Greene (as many eminent critics have thought) had a hand in *The True Tragedie*, he must here have intended a charge of plagiarism against Shakespeare. But while it seems more probable that (as the late R. Simpson suggested) the upstart crow beautified with the feathers of the three dramatists is a sneering description of the actor who declaimed their verse, the *animus* of the whole attack (as explained by Dr Ingleby) is revealed in its concluding phrases. This "shake-scene," i.e. this actor had ventured to intrude upon the domain of the regular staff of playwrights—their monopoly was in danger!

Two other prose pamphlets of an autobiographical nature were issued posthumously. Of these, *The Repentance of Robert Greene, Master of Arts* (1592), must originally have been written by him on his death-bed, under the influence, as he says, of Father Parsons's *Booke of Resolution (The Christian Directorie, appertaining to Resolution, 1582)*, republished in an enlarged form, which became very popular, in 1585; but it bears traces of having been improved from the original; while *Greene's Vision* was certainly not, as the title-page avers, written during his last illness.

Altogether not less than thirty-five prose-tracts are ascribed to Greene's prolific pen. Nearly all of them are interspersed with verses; in their themes they range from the "misticall" wonders of the heavens to the familiar but "pernitious sleights" of the sharpers of London. But the most widely attractive of his prose publications were his "love-pamphlets," which brought upon him the outcry of Puritan censors. The earliest of his novels, as they may be called, *Mamillia*, was licensed in 1593. This interesting story may be said to have accompanied Greene through life; for even part II., of which, though probably completed several years earlier, the earliest extant edition bears the date 1593, had a sequel, *The Anatomie of Love's Platteries*, which contains a review of suitors recalling Portia's in *The Merchant of Venice*. *The Myrrour of Modestie* (the story of Susanna) (1584); *The Historie of Arkasto, King of Denmarke* (1584); *Morando, the Tritameron of Love* (a rather tedious imitation of the *Decameron*) (1584); *Planiomachia* (1585) (a contention in story-telling between Venus and Saturn); *Penelope's Web* (1587) (another string of stories); *Alcida, Greene's Metamorphosis* (1588), and others, followed. In these popular productions he appears very distinctly as a follower of John Lyly; indeed, the first part of *Mamillia* was entered in the Stationers' Registers in the year of the appearance of *Euphues*, and two of Greene's novels are by their titles announced as a kind of sequel to the parent romance: *Euphues his Censure to Philautus* (1587), *Menaphon. Camilla's Alarum to Slumbering Euphues* (1589), named in some later editions *Greene's Arcadia*. This pastoral

romance, written in direct emulation of Sidney's, with a heroine called Samila, contains St Sephestia's charming lullaby, with its refrain "Father's sorowe, father's joy." But, though Greene's style copies the balanced oscillation, and his diction the ornateness (including the proverbial philosophy) of Lyly, he contrives to interest by the matter as well as to attract attention by the manner of his narratives. Of his highly moral intentions he leaves the reader in no doubt, since they are exposed on the title-pages. The full title of the *Myrrour of Modestie* for instance continues: "wherein appeareth as in a perfect glasse how the Lord delivereth the innocent from all imminent perils, and plagueth the blood-thirsty hypocrites with deserved punishments," &c. On his *Pandosto, The Triumph of Time* (1588) Shakespeare founded *A Winter's Tale*; in fact, the novel contains the entire plot of the comedy, except the device of the living statue; though some of the subordinate characters in the play, including Autolycus, were added by Shakespeare, together with the pastoral fragrance of one of its episodes.

In Greene's *Never too Late* (1590), announced as a "Powder of Experience: sent to all youthfull gentlemen" for their benefit, the hero, Francoesco, is in all probability intended for Greene himself, the sequel or second part is, however, pure fiction. This episodical narrative has a vivacity and truthfulness of manner which savour of an 18th century novel rather than of an Elizabethan tale concerning the days of "Palmerin, King of Great Britain." Philador, the prodigal of *The Morning Garment* (1590), is obviously also in some respects a portrait of the writer. The experiences of the Roberto of *Greene's Groat's-worth of Wit* (1592) are even more palpably the experiences of the author himself, though they are possibly overdrawn—for a born rhetorician exaggerates everything, even his own sins. Besides these and the posthumous pamphlets on his repentance, Greene left realistic pictures of the very disreputable society to which he finally descended, in his pamphlets on "conny-catching": *A Notable Discovery of Cosmage* (1591), *The Blacke Bookes Messenger. Laying open the Life and Death of Ned Browne, one of the most Notable Culpurses, Crossbiters, and Conny-catchers that ever lived in England* (1592). Much in Greene's manner, both in his romances and in his pictures of low life, anticipated what proved the slow course of the actual development of the English novel; and it is probable that his true *métier*, and that which best suited the bright fancy, ingenuity and wit of which his genius was compounded, was pamphlet-spinning and story-telling rather than dramatic composition. It should be added that, cuphuist as Greene was, few of his contemporaries in their lyrics warbled wood-notes which like his resemble Shakespeare's in their native freshness.

Curiously enough, as Mr Churton Collins has pointed out, Greene, except in the two pamphlets written just before his death, never refers to his having written plays; and before 1592 his contemporaries are equally silent as to his labours as a playwright. Only four plays remain to us of which he was indisputably the sole author. The earliest of these seems to have been the *Comicall History of Alphonus, King of Arragon*, of which Henslowe's *Diary* contains no trace. But it can hardly have been first acted long after the production of Marlowe's *Tamburlaine*, which had, in all probability, been brought on the stage in 1587. For this play, "comical" only in the negative sense of having a happy ending, was manifestly written in emulation as well as in direct imitation of Marlowe's tragedy. While Greene cannot have thought himself capable of surpassing Marlowe as a tragic poet, he very probably wished to outdo him in "business," and to equal him in the rant which was sure to bring down at least part of the house. *Alphonus* is a history proper—a dramatized chronicle or narrative of warlike events. Its fame could never equal that of Marlowe's tragedy; but its composition showed that Greene could seek to rival the most popular drama of the day, without falling very far short of his model.

In the *Honourable History of Friar Bacon and Friar Bungay* (not known to have been acted before February, 1592, but probably written in 1589) Greene once more attempted to emulate

Marlowe; and he succeeded in producing a masterpiece of his own. Marlowe's *Doctor Faustus*, which doubtless suggested the composition of Greene's comedy, reveals the mighty tragic genius of its author; but Greene resolved on an altogether distinct treatment of a cognate theme. Interweaving with the popular tale of Friar Bacon and his wondrous doings a charming idyl (so far as we know, of his own invention), the story of Prince Edward's love for the Fair Maid of Fressingfield, he produced a comedy brimful of amusing action and genial fun. *Friar Bacon* remains a dramatic picture of English Elizabethan life with which *The Merry Wives* alone can vie; and not even the ultra-classicism in the similes of its diction can destroy the naturalness which constitutes its perennial charm. *The History of Orlando Furioso, one of the Twelve Peeres of France* has an unsatisfactory evidence been dated as before 1586, and is known to have been acted on the 21st of February 1592. It is a free dramatic adaptation of Ariosto, Harington's translation of whom appeared in 1591, and who in one passage is textually quoted; and it contains a large variety of characters and a superabundance of action. Fairly lucid in arrangement and fluent in style, the treatment of the madness of Orlando lacks tragic power. Very few dramatists from Sophocles to Shakespeare have succeeded in subordinating the grotesque effect of madness to the tragic; and Greene is not to be included in the list.

In *The Scottish Historie of James IV.* (acted 1592, licensed for publication 1594) Greene seems to have reached the climax of his dramatic powers. The "historical" character of this play is pure pretence. The story is taken from one of Giraldi Cinthio's tales. Its theme is the illicit passion of King James for the chaste lady Ida, to obtain whose hand he endeavours, at the suggestion of a villain called Ateukin, to make away with his own wife. She escapes in doublet and hose, attended by her faithful dwarf; but, on her father's making war upon her husband to avenge her wrongs, she brings about a reconciliation between them. Not only is this well-constructed story effectively worked out, but the characters are vigorously drawn, and in Ateukin there is a touch of Iago. The fooling by Slipper, the clown of the piece, is unexceptionable; and, lest even so the play should hang heavy on the audience, its action is carried off by a "pleasant comedie"—i.e. a prelude and some dances between the acts—"presented by Oboram, King of Fayeries," who is, however, a very different person from the Oberon of *A Midsummer Night's Dream*.

George-a-Greene the Pinner of Wakefield (acted 1593, printed 1599), a delightful picture of English life fully worthy of the author of *Friar Bungay*, has been attributed to him; but the external evidence is very slight, and the internal unconvincing. Of the comedy of *Fair Em*, which resembles *Friar Bacon* in more than one point, Greene cannot have been the author; the question as to the priority between the two plays is not so easily solved. The conjecture as to his supposed share in the plays on which the second and third parts of *Henry VI.* are founded has been already referred to. He was certainly joint author with Thomas Lodge of the curious drama called *A Looking Glasse for London and England* (acted in 1592 and printed in 1594)—a dramatic apologue conveying to the living generation of Englishmen the warning of Nineveh's corruption and prophesied doom. The lesson was frequently repeated in the streets of London by the "Ninevitical motions" of the puppets; but there are both fire and wealth of language in Greene and Lodge's oratory. The comic element is not absent, being supplied in abundance by Adam, the clown of the piece, who belongs to the family of Slipper, and of Friar Bacon's servant, Miles.

Greene's dramatic genius has nothing in it of the intensity of Marlowe's tragic muse; nor perhaps does he ever equal Peete at his best. On the other hand, his dramatic poetry is occasionally animated with the breezy freshness which no artifice can simulate. He had considerable constructive skill, but he has created no character of commanding power—unless Ateukin be excepted; but his personages are living men and women, and marked out from one another with a vigorous but far from rude hand. His comic humour is undeniable, and he had the gift of light and

graceful dialogue. His diction is overloaded with classical ornament, but his versification is easy and fluent, and its cadence is at times singularly sweet. He creates his best effects by the simplest means; and he is indisputably one of the most attractive of early English dramatic authors.

Greene's dramatic works and poems were edited by Alexander Dyce in 1831 with a life of the author. This edition was reissued in one volume in 1858. His complete works were edited for the Huth Library by A. B. Grosart. This issue (1881-1886) contains a translation of Nicholas Storojhenko's monograph on Greene (Moscow, 1878). Greene's plays and poems were edited with introductions and notes by J. Churton Collins in 2 vols. (Oxford, 1905); the general introduction to this edition has superseded previous accounts of Greene and his dramatic and lyrical writings. An account of his pamphlets is to be found in J. J. Jusserand's *English Novel in the Time of Shakespeare* (Eng. trans., 1890). See also W. Bernhardt, *Robert Greenes Leben und Schriften* (1874); F. M. Bodenstedt, in *Shakespeare's Zeitgenossen und ihre Werke* (1858); and an introduction by A. W. Ward to *Friar Bacon and Friar Bungay* (Oxford, 1886, 4th ed., 1901). (A. W. W.)

GREENFIELD, a township and the county-seat of Franklin county, in N.E. Massachusetts, U.S.A., including an area of 20 sq. m. of meadow and hill country, watered by the Green and Deerfield rivers and various small tributaries. Pop. (1890) 5252, (1900) 7927, of whom 1431 were foreign-born; (1910 census) 10,427. The principal village, of the same name as the township, is situated on the N. bank of the Deerfield river, and on the Boston & Maine railway and the Connecticut Valley street railway (electric). Among Greenfield's manufactures are cutlery, machinery, and taps and dies. Greenfield, originally part of Deerfield, was settled about 1682, was established as a "district" in 1753, and on the 23rd of August 1775 was, by a general Act, separated from Deerfield and incorporated as a separate township, although it had assumed full township rights in 1774 by sending delegates to the Provincial Congress. In 1793 part of it was taken to form the township of Gill; in 1838 part of it was annexed to Bernardston; and in 1896 it annexed a part of Deerfield. It was much disaffected at the time of Shays's Rebellion.

See F. M. Thompson, *History of Greenfield* (2 vols., Greenfield, 1904).

GREENFINCH (Ger. *Grünflink*), or **GREEN LINNET**, as it is very often called, a common European bird, the *Fringilla chloris* of Linnæus, ranked by many systematists with one section of hawfinches, *Coccothraustes*, but apparently more nearly allied to the other section *Hesperiphona*, and perhaps justifiably deemed the type of a distinct genus, to which the name *Chloris* or *Ligurinus* has been applied. The cock, in his plumage of yellowish-green and yellow is one of the most finely coloured of common English birds, but he is rather heavily built, and his song is hardly commended. The hen is much less brightly tinted. Throughout Britain, as a rule, this species is one of the most plentiful birds, and is found at all seasons of the year. It pervades almost the whole of Europe, and in Asia reaches the river Ob. It visits Palestine, but is unknown in Egypt. It is, however, abundant in Mauritania, whence specimens are so brightly coloured that they have been deemed to form a distinct species, the *Ligurinus aurantiiventris* of Dr Cabanis, but that view is now generally abandoned. In the north-east of Asia and its adjacent islands occur two allied species—the *Fringilla sinica* of Linnæus and the *F. kamurahiba* of Temminck. (A. N.)

GREENHEART, one of the most valuable of timbers, the produce of *Nectandra Rodiaei*, natural order Lauraceæ, a large tree, native of tropical South America and the West Indies. The Indian name of the tree is *sipiri* or *bibiru*, and from its bark and fruits is obtained the febrifuge principle bilirine. Greenheart wood is of a dark-green colour, sap wood and heart wood being so much alike that they can with difficulty be distinguished from each other. The heart wood is one of the most durable of all timbers, and its value is greatly enhanced by the fact that it is proof against the ravages of many marine borers which rapidly destroy piles and other submarine structures of most other kinds of wood available for such purposes. In the Kelvingrove Museum, Glasgow, there are two pieces of planking from a wreck submerged during eighteen years on the west coast of Scotland.

The one specimen—greenheart—is merely slightly pitted on the surface, the body of the wood being perfectly sound and untouched, while the other—teak—is almost entirely eaten away. Greenheart, tested either by transverse or by tensile strain, is one of the strongest of all woods, and it is also exceedingly dense, its specific gravity being about 1.150. It is included in the second line of Lloyd's Register for shipbuilding purposes, and it is extensively used for keelsons, beams, engine-bearers and planking, &c., as well as in the general engineering arts, but its excessive weight unfits it for many purposes for which its other properties would render it eminently suitable.

GREENLAND (Danish, &c., *Grønland*); a large continental island, the greater portion of which lies within the Arctic Circle, while the whole is arctic in character. It is not connected with any portion of Europe or America except by suboceanic ridges; but in the extreme north it is separated only by a narrow strait from Ellesmere Land in the archipelago of the American continent. It is bounded on the east by the North Atlantic, the Norwegian and Greenland Seas—Jan Mayen, Iceland, the Faeroe Islands and the Shetlands being the only lands between it and Norway. Denmark Strait is the sea between it and Iceland, and the northern Norwegian Sea or Greenland Sea separates it from Spitsbergen. On the west Davis Strait and Baffin Bay separate it from Baffin Land. The so-called bay narrows northward into the strait successively known as Smith Sound, Kane Basin, Kennedy Channel and Robeson Channel. A submarine ridge, about 300 fathoms deep at its deepest, unites Greenland with Iceland (across Denmark Strait), the Faeroes and Scotland. A similar submarine ridge unites it with the Cumberland Peninsula of Baffin Land, across Davis Strait. Two large islands (with others smaller) lie probably off the north coast, being apparently divided from it by very narrow channels which are not yet explored. If they be reckoned as integral parts of Greenland, then the north coast, fronting the polar sea, culminates about 83° 40' N. Cape Farewell, the most southerly point (also on a small island), is in 59° 45' N. The extreme length of Greenland may therefore be set down at about 1650 m., while its extreme breadth, which occurs about 77° 30' N., is approximately 800 m. The area is estimated at 827,275 sq. m. Greenland is a Danish colony, inasmuch as the west coast and also the southern east coast belong to the Danish crown. The scattered settlements of Europeans on the southern parts of the coasts are Danish, and the trade is a monopoly of the Danish government.

The southern and south-western coasts have been known, as will be mentioned later, since the 10th century, when Norse settlers appeared there, and the names of many famous arctic explorers have been associated with the exploration of Greenland. The communication between the Norse settlements in Greenland and the motherland Norway was broken off at the end of the 14th and the beginning of the 15th century, and the Norsemen's knowledge about their distant colony was gradually more or less forgotten. The south and west coast of Greenland was then re-discovered by John Davis in July 1585, though previous explorers, as Cortereal, Frobisher and others, had seen it, and at the end of the 16th and the beginning of the 17th century the work of Davis (1586-1588), Hudson (1610) and Baffin (1616) in the western seas afforded some knowledge of the west coast. This was added to by later explorers and by whalers and sealers. Among explorers who in the 19th century were specially connected with the north-west coast may be mentioned E. A. Inglefield (1852) who sailed into Smith's Sound, Elisha Kent Kane (1853-1855) who worked northward through Smith Sound into Kane Basin, and Charles Francis Hall (1871) who explored the strait (Kennedy Channel and Robeson Channel) to the north of this.¹

The northern east coast was sighted by Hudson (1607) in about 73° 30' N. (C. Hold with Hope), and during the 17th century and

later this northern coast was probably visited by many Dutch whalers. The first who gave more accurate information was the Scottish whaler, Captain William Scoresby, jun. (1822), who, with his father, explored the coast between 69° and 75° N., and gave the first fairly trustworthy map of it.² Captains Edward Sabine and Clavering (1823) visited the coast between 72° 5' and 75° 12' N. and met the only Eskimo ever seen in this part of Greenland. The second German polar expedition in 1870, under Carl Christian Koldewey³ (1837-1908), reached 77° N. (Cape Bismarck); and the duke of Orleans, in 1905, ascertained that this point was on an island (the Dove Bay of the German expedition being in reality a strait) and penetrated farther north, to about 78° 16'. From this point the north-east coast remained unexplored, though a sight was reported in 1670 by a whaler named Lambert, and again in 1775 as far north as 79° by Daines Barrington, until a Danish expedition under Mylius Eriksen in 1906-1908 explored it, discovering North-East Foreland, the easternmost point (see POLAR REGIONS and map). The southern part of the east coast was first explored by the Dane Wilhelm August Graah (1820-1830) between Cape Farewell and 65° 16' N.⁴ In 1883-1885 the Danes G. Holm and T. V. Garde carefully explored and mapped the coast from Cape Farewell to Angmagssalik, in 66° N.⁵ F. Nansen and his companions also travelled along a part of this coast in 1888.⁶ A. E. Nordenskiöld, in the "Sophia," landed near Angmagssalik, in 65° 36' N., in 1883.⁷ Captain C. Ryder, in 1891-1892, explored and mapped the large Scoresby Sound, or, more correctly, Scoresby Fjord.⁸ Lieutenant G. Amtrup, in 1890, explored the coast from Angmagssalik north to 67° 22' N.⁹ A part of this coast, about 67° N., had also been seen by Nansen in 1882.¹⁰ In 1899 Professor A. G. Nathorst explored the land between Franz Josef Fjord and Scoresby Fjord, where the large King Oscar Fjord, connecting Davy's Sound with Franz Joseph Fjord, was discovered.¹¹ In 1900 Lieutenant Amtrup explored the still unknown east coast from 69° 10' N. south to 67° N.¹²

From the work of explorers in the north-west it had been possible to infer the approximate latitude of the northward termination of Greenland long before it was definitely known. Towards the close of the 19th century several explorers gave attention to this question. Lieutenant (afterwards Admiral) L. A. Beaumont (1876), of the Nares Expedition, explored the coast north-east of Robeson Channel to 82° 20' N.¹³ In 1882 Lieut. J. B. Lockwood and Sergeant (afterwards Captain) D. L. Brainard, of the U.S. expedition to Lady Franklin Bay,¹⁴ explored the north-west coast beyond Beaumont's farthest to a promontory in 83° 24' N. and 40° 46' E. and they saw to the north-east Cape Washington, in about 83° 38' N. and 39° 30' E., the most northerly point of land till then observed. In July 1892 R. E. Peary and E. Astrup, crossing by land from Inglefield Gulf, Smith Sound, discovered Independence Bay on the north-east coast in 81° 37' N. and 34° 5' W.¹⁵ In May 1895 it

¹ *Journal of a Voyage to the Northern Whale Fishery* (1823).

² *Die zweite deutsche Nordpolarfahrt* (1873-1875).

³ *Reise til Østkysten af Grønland* (1832; trans. by G. Gordon Macdougall, 1837).

⁴ *Meddelelser om Grønland*, parts ix. and x. (Copenhagen, 1888).

⁵ *The First Crossing of Greenland*, vol. i. (London, 1890). H. Mohr and F. Nansen: "Wissenschaftliche Ergebnisse von Dr. F. Nansen Durchquerung von Grønland" (1888), Ergänzungsheft No. 105 zu *Petermanns Mitteilungen* (Gotha, 1892).

⁶ A. F. Nordenskiöld, *Den andra Dicksonska Expeditionen til Grønland* (Stockholm, 1885).

⁷ *Meddelelser om Grønland*, pts. xvii.-xix. (Copenhagen, 1895-1896).

⁸ *Geografisk Tidsskrift*, xv. 53-71 (Copenhagen, 1899).

⁹ *Ibid.* vii. 76-79 (Copenhagen, 1884).

¹⁰ *The Geographical Journal*, xiv. 534 (1899); xvii. 48 (1901); *Två Semestr i Norra Ishafset* (Stockholm, 1901).

¹¹ *Meddelelser om Grønland*, parts xvii.-xxvii.

¹² Nares, *Voyage to the Polar Sea* (2 vols. London, 1877). See also Blue Book, journals, &c., (Nares) Expedition, 1875-1876 (London, 1877).

¹³ A. W. Greeley, *Report on the Proceedings of the United States Expedition to Lady Franklin Bay, Grinnell Land*, vols. i. and ii. (Washington, 1885); *Three Years of Arctic Service* (2 vols. London, 1886).

¹⁴ R. E. Peary, *Northward over the "Great Ice"* (2 vols. New York, 1898); E. Astrup, *Blandt Nordpolens Næbber* (Christiania, 1895).

¹ Inglefield, *Summer Search for Franklin* (London, 1853).

² *Second Grinnell Expedition* (2 vols., Philadelphia, 1856).

³ Davis, *Polaris (Hall's) North Polar Expedition* (Washington, 1876). See also Besenla, *Die amerikanische Nordpol-Expedition* (Leipzig, 1879).

was revisited by Peary, who supposed this bay to be a sound communicating with Victoria Inlet on the north-west coast. To the north Heilprin Land and Melville Land were seen stretching northwards, but the probability seemed to be that the coast soon trended north-west. In 1901 Peary rounded the north point, and penetrated as far north as 83° 50' N. The scanty exploration of

from the western margin, in 62° 50' N.¹ Nordenskiöld penetrated in 1883 about 70 m. inland in 68° 20' N., and two Lapps of his expedition went still farther on skis, to a point nearly under 45° W. at an elevation of 6600 ft. Peary and Maigaard reached in 1886 about 100 m. inland, a height of 7500 ft. in 69° 30' N. Nansen with five companions in 1888 made the first complete

crossing of the inland ice, working from the east coast to the west, about 64° 25' N., and reached a height of 8922 ft. Peary and Astrup, as already indicated, crossed in 1892 the northern part of the inland ice between 78° and 82° N., reaching a height of about 8000 ft., and determined the northern termination of the ice-covering. Peary made very nearly the same journey again in 1895. Captain T. V. Garde explored in 1893 the interior of the inland ice between 61° and 62° N. near its southern termination, and he reached a height of 7080 ft. about 60 m. from the margin.²

Coasts.—The coasts of Greenland are for the most part deeply indented with fjords, being intensely glaciated. The coast-line of Melville Bay (the northern part of the west coast) is to some degree an exception, though the fjords may here be somewhat filled with glaciers, and, for another example, it may be noted that Peary observed a marked contrast on the north coast. Eastward as far as Cape Morris Jesup there are precipitous headlands and islands, as elsewhere, with deep water close inshore. East of the same cape there is an abrupt change; the coast is unbroken, the mountains recede inland, and there is shoal-water for a considerable distance from the coast. Numerous islands lie off the coasts where they are indented; but these are in no case large, excepting those off the north coast, and that of Disco off the west, which is crossed by the parallel of 70° N. This island, which is separated by Waigat Strait from the Nugsuak peninsula, is lofty, and has an area of 3005 sq. m. Steenstrup in 1898 discovered in it the warmest spring known in Greenland, having a temperature of 66° F.

The unusual glaciation of the east coast is evidently owing to the north polar current carrying the ice masses from the north polar basin south-westward along the land, and giving it an entirely arctic climate down to Cape Farewell. In some parts the interior ice-covering extends down to the outer coast, while in other parts its margin is situated more inland, and the ice-free coast-land is deeply intersected by fjords extending far into the interior, where they are blocked by enormous glaciers or "ice-currents" from the interior ice-covering which discharge masses of icebergs into them. The east coast of Greenland is in this respect highly interesting. All coasts in the world which are much intersected by deep fjords have, with very few exceptions, a western exposure, e.g. Norway, Scotland, British Columbia and Alaska, Patagonia and Chile, and even Spitsbergen and Novaya Zemlya, whose west coasts are far more indented than their east ones. Greenland forms the most prominent exception, its eastern coast being quite as much indented as its western. The reason is to be found in its geographical position, a cold ice-covered polar current running south along the land, while not far outside there is an open warmer sea, a circumstance which, while producing a cold climate, must also give rise to much precipitation, the land being thus exposed to the alternate erosion of a rough atmosphere and large glaciers. On the east coast of Baffin Land and Labrador there are similar conditions. The result is that the east

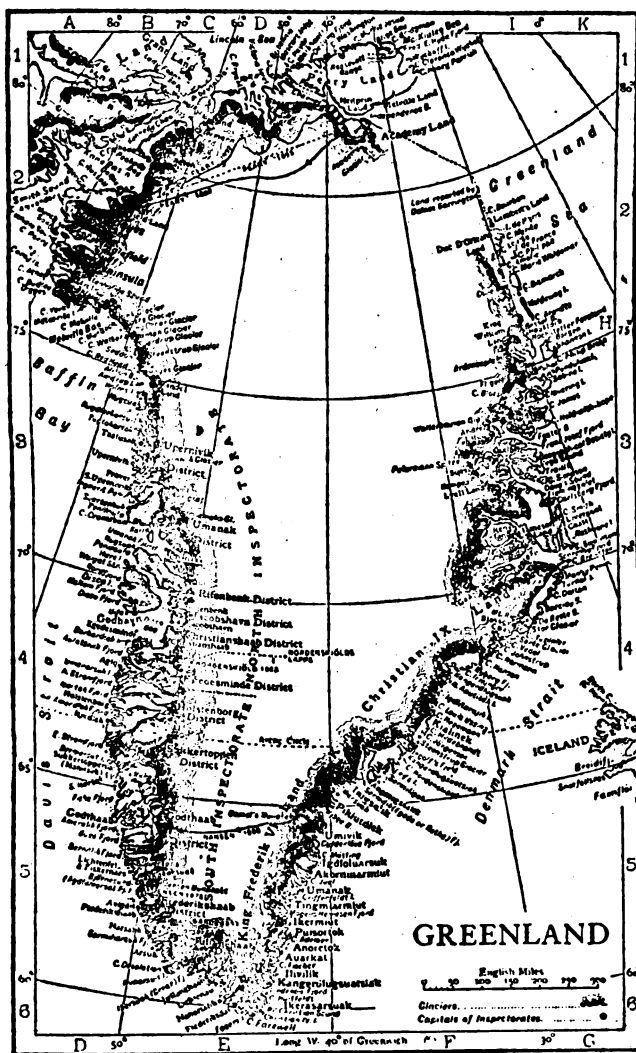

the great ice-cap, or inland ice, which may be asserted to cover the whole of the interior of Greenland, has been prosecuted chiefly from the west coast. In 1751 Lars Dalager, a Danish trader, took some steps in this direction from Frederikshaab. In 1870 Nordenskiöld and Berggren walked 35 m. inland from the head of Aulatsivik Fjord (near Disco Bay) to an elevation of 2200 ft. The Danish captain Jens Arnold Dietrich Jensen reached, in 1878, the Jensen Nunataks (5400 ft. above the sea), about 45 m.

coast of Greenland has the largest system of typical fjords known on the earth's surface. Scoresby Fjord has a length of about 180 m. from the outer coast to the point where it is blocked by the glaciers, and with its numerous branches covers an enormous area. Franz Josef Fjord, with its branch King Oscar Fjord, communicating with Davy's Sound, forms a system of fjords on a similar scale. These fjords are very deep; the greatest depth

¹ *Meddelelser om Grønland*, part i. (Copenhagen, 1879).

² *Ibid.* part xvi. (Copenhagen, 1896).

found by Ryder in Scoresby Sound was 300 fathoms, but there are certainly still greater depths; like the Norwegian fjords they have, however, probably all of them, a threshold or sill, with shallow water, near their mouths. A few soundings made outside this coast seem to indicate that the fjords continue as deep submarine valleys far out into the sea. On the west coast there are also many great fjords. One of the best known from earlier days is the great Godthaab Fjord (or Baals Kviær) north of 64° N. Along the east coast there are many high mountains, exceeding 6000 and 7000 ft. in height. One of the highest peaks hitherto measured is at Timingertok, on the Lindenov Fjord, in $60^{\circ} 35'$ N., which is 7340 ft. high. At the bottom of Mogens Heinesen Fjord, $62^{\circ} 30'$ N., the peaks are 6300 ft., and in the region of Umanak, 63° N., they even exceed 6600 ft. At Umivik, where Nansen began his journey across the inland ice, the highest peak projecting through the ice-covering was Gamel's Nunatak, 6440 ft., in $64^{\circ} 34'$ N. In the region of Angmagssalik, which is very mountainous, the mountains rise to 6500 ft., the most prominent peak being Ingoll's Field, in $66^{\circ} 20'$ N., about 6000 ft., which is seen from far out at sea, and forms an excellent landmark. This is probably the Blaaserk (i.e. Blue Sark or blue shirt) of the old Norsemen, their first landmark on their way from Iceland to the Æster Bygd, the present Julianehaab district, on the south-west coast of Greenland. A little farther north the coast is much lower, rising only to heights of 2000 ft., and just north of $67^{\circ} 10'$ N. only to 500 ft. or less.¹ The highest mountains near the inner branches of Scoresby Fjord are about 7000 ft. The Petermann Spitze, near the shore of Franz Josef Fjord, measured by Payer and found to be 11,000 ft., has hitherto been considered to be the highest mountain in Greenland, but according to Nathorst it "is probably only two-thirds as high as Payer supposed," perhaps between 8000 and 9000 ft.

Along the west coast of Greenland the mountains are generally not quite so high, but even here peaks of 5000 and 6000 ft. are not uncommon. As a whole the coasts are unusually mountainous, and Greenland forms in this respect an interesting exception, as there is no other known land of such a size so filled along its coasts on all sides with high mountains and deep fjords and valleys.

The Inland Ice.—The whole interior of Greenland is completely covered by the so-called inland ice, an enormous glacier forming a regular shield-shaped expanse of snow and glacier ice, and burying all valleys and mountains far below its surface. Its area is about 715,400 sq. m., and it is by far the greatest glacier of the northern hemisphere. Only occasionally there emerge lofty rocks, isolated but not completely covered by the ice-cap; such rocks are known as *nunataks* (an Eskimo word). The inland ice rises in the interior to a level of 9000, and in places perhaps 10,000 ft. or more, and descends gradually by extremely gentle slopes towards the coasts or the bottom of the fjords on all sides, discharging a great part of its yearly drainage or surplus of precipitation in the form of icebergs in the fjords, the so-called ice-fjords, which are numerous both on the west and on the east coast. These icebergs float away, and are gradually melted in the sea, the temperature of which is thus lowered by cold stored up in the interior of Greenland. The last remains of these icebergs are met with in the Atlantic south of Newfoundland. The surface of the inland ice forms in a transverse section from the west to the east coast an extremely regular curve, almost approaching an arc of a wide circle, which along Nansen's route has its highest ridge somewhat nearer the east than the west coast. The same also seems to be the case farther south. The curve shows, however, slight irregularities in the shape of undulations. The angle of the slope decreases gradually from the margin of the inland ice, where it may be 1° or more, towards the interior, where it is 0° . In the interior the surface of the inland ice is composed of dry snow which never melts, and is constantly packed and worked smooth by the winds. It extends as a completely even plain of snow, with long, almost imperceptible, undulations or waves, at a height of 7000 to 10,000 ft., obliterating the features of the underlying land, the mountains and valleys of which are completely interred. Over the deepest valleys of the land in the interior this ice-cap must be at least 6000 or 7000 ft. thick or more. Approaching the coasts from the interior, the snow of the surface gradually changes its structure. At first it becomes more coarse-grained, like the *Firn Schnee* of the Alps, and is moist by melting during the summer. Nearer the coast, where the melting on the surface is more considerable, the wet snow freezes hard during the winter and is more or less transformed into ice, on the surface of which rivers and lakes are formed, the water of which, however, soon finds its way through crevasses and holes in the ice down to its under surface, and reaches the sea as a sub-glacial river. Near its margin the surface of the inland ice is broken up by numerous large crevasses, formed by the outward motion of the glacier covering the underlying land. The steep ice-walls at the margin of the inland ice show, especially where the motion of the ice is slow, a distinct striation, which indicates the strata of annual precipitation with the intervening thin seams of dust (Nordenfjöld's kryokonite). This is partly dust blown on

¹ See C. Kruse in *Geografisk Tidsskrift*, xv. 61 (Copenhagen, 1896). See also F. Nansen, "Die Ostküste Grönlands," *Ergänzungsheft No. 105 zu Petermanns Mitteilungen* (Gotha, 1892), p. 55 and pl. iv., sketch No. 11.

to the surface of the ice from the ice-bare coast-land and partly the dust of the atmosphere brought down by the falling snow and accumulated on the surface of the glacier's covering by the melting during the summer. In the rapidly moving glaciers of the ice-fjords this striation is not distinctly visible, being evidently obliterated by the strong motion of the ice masses.

The ice-cap of Greenland must to some extent be considered as a viscous mass, which, by the vertical pressure in its interior, is pressed outwards and slowly flows towards the coasts, just as a mass of pitch placed on a table and left to itself will in the course of time flow outwards towards all sides. The motion of the outwards-creeping inland ice will naturally be more independent of the configurations of the underlying land in the interior, where its thickness is so enormous, than near the margin where it is thinner. Here the ice converges into the valleys and moves with increasing velocity in the form of glaciers into the fjords, where they break off as icebergs. The drainage of the interior of Greenland is thus partly given off in the solid form of icebergs, partly by the melting of the snow and ice on the surface of the ice-cap, especially near its western margin, and to some slight extent also by the melting produced on its under side by the interior heat of the earth. After Professor Amund Holland had, in July 1875, discovered the amazingly great velocity, up to 64½ ft. in twenty-four hours, with which the glaciers of Greenland move into the sea, the margin of the inland ice and its glaciers was studied by several expeditions. K. J. V. Steenstrup during several years, Captain Hammer in 1879-1880, Captain Ryder in 1886-1887, Dr Drygalski in 1891-1893,² and several American expeditions in later years, all examined the question closely. The highest known velocities of glaciers were measured by Ryder in the Upernivik glacier (in 73° N.), where, between the 13th and 14th of August of 1886, he found a velocity of 125 ft. in twenty-four hours, and an average velocity during several days of 101 ft. (Danish).³ It was, however, ascertained that there is a great difference between the velocities of the glaciers in winter and in summer. For instance, Ryder found that the Upernivik glacier had an average velocity of only 33 ft. in April 1887. There seem to be periodical oscillations in the extension of the glaciers and the inland ice similar to those that have been observed on the glaciers of the Alps and elsewhere. But these interesting phenomena have not hitherto been subject to systematic observation, and our knowledge of them is therefore uncertain. Numerous glacial marks, however, such as polished striated rocks, moraines, erratic blocks, &c., prove that the whole of Greenland, even the small islands and skerries outside the coast, has once been covered by the inland ice.

Numerous raised beaches and terraces, containing shells of marine mollusca, &c., occur along the whole coast of Greenland, and indicate that the whole of this large island has been raised, or the sea has sunk, in post-glacial times, after the inland ice covered its now ice-bare outskirts. In the north along the shores of Smith Sound these traces of the gradual upheaval of the land, or sinking of the sea, are very marked; but they are also very distinct in the south, although not found so high above sea-level, which seems to show that the upheaval has been greater in the north. In Ukuvaqut Fjord ($72^{\circ} 30'$ N.) the highest terrace is 480 ft. above the sea.⁴ On Manisok ($65^{\circ} 30'$ N.) the highest raised beach was 360 ft. above the sea.⁵ In the Isortok Fjord ($69^{\circ} 11'$ N.) the highest raised beach is 380 ft. above sea-level.⁶ In the Ameralik Fjord ($64^{\circ} 14'$ N.) the highest marine terrace is about 340 ft. above sea-level, and at Ilivertalik ($63^{\circ} 14'$ N.) north of Fiskerøes, the highest terrace is about 325 ft. above the sea. At Kaktarsuak, near the Bjørnesund ($62^{\circ} 50'$ N.), a terrace is found at 615 ft. above the sea, but it is doubtful whether this is of marine origin.⁷ In the Julianehaab district, between 62° and 61° N., the highest marine terraces are found at about 160 ft. above the sea.⁸ The highest marine terrace observed in Scoresby Fjord, on the east coast, was 240 ft. above sea level.⁹ There is a common belief that during quite recent times the west and south-west coast, within the Danish possessions, has been sinking. Although there are many indications which may make this probable, none of them can be said to be quite decisive.¹⁰

Geology.—So far as made out, the structure of explored Greenland is as follows:

1. *Laurentian gneiss* forms the greatest mass of the exposed rocks of the country bare of ice. They are found on both sides of Smith Sound, rising to heights of 2000 ft., and underlie the Miocene and Cretaceous rocks of Disco Island, Noursoak Peninsula and the

² E. v. Drygalski, *Grönland-Expedition der Gesellschaft für Erdkunde zu Berlin, 1891-1893* (2 vols., Berlin, 1897).

³ *Meddelelser om Grönland*, part viii. pp. 203-270 (Copenhagen, 1886).

⁴ *Ibid.*, part iv. p. 230 (Copenhagen, 1883); see also part xiv. pp. 317 et seq., 323.

⁵ *Ibid.*, part xiv. p. 323 (Copenhagen, 1898).

⁶ *Ibid.*, part ii. pp. 181-188 (Copenhagen, 1881).

⁷ *Ibid.*, part i. pp. 99-101 (Copenhagen, 1879).

⁸ *Ibid.*, part ii. p. 39 (Copenhagen, 1881); part xvi. pp. 150-151 (1896).

⁹ *Ibid.*, part xix. p. 175 (1896).

¹⁰ *Ibid.*, part i. p. 34; part ii. p. 40; part xiv. pp. 343-347; part iv. p. 237; part viii. p. 26.

Oolites of Fendulum Island in East Greenland. Ancient schists occur on the east coast south of Angmagssalik, and basalts and schists are found in Scoresby Fjord. It is possible that some of these rocks are also of Huronian age, but it is doubtful whether the rocks so designated by the geologists of the "Alert" and "Discovery" expedition are really the rocks so known in Canada, or are a continuous portion of the fundamental or oldest gneiss of the north-west of Scotland and the western isles.

2. **Silurian.**—Upper Silurian, having a strong relation to the Wenlock group of Britain, but with an American facies, and Lower Silurian, with a succession much the same as in British North America, are found on the shores of Smith Sound, and Nathorst has discovered them in King Oscar Fjord, but not as yet so far south as the Danish possessions.

3. **Devonian** rocks are believed to occur in Igafiko and Tunndiorbik Fjords, in S.W. Greenland, but as they are unfossiliferous sandstone, rapidly disintegrating, this cannot be known. It is, however, likely that this formation occurs in Greenland, for in Dana Bay, Captain Feilden found a species of *Spirifera* and *Prodactus mesolobus* or *costatus*, though it is possible that these fossils represent the "Urso stage" (Heer) of the Lower Carboniferous. A few Devonian forms have also been recorded from the Parry Archipelago, and Nathorst has shown the existence of Old Red Sandstone facies on Devonian in Traill Island, Geographical Society Islands, Ymer Island and Gauss Peninsula.

Carboniferous.—In erratic blocks of sandstone, found on the Disco shore of the Waigat, have been detected a *Sigillaria* and a species of either *Pecopteris* or *Gleichenia*, perhaps of this age; and probably much of the extreme northern coast of Ellesmere Land, and therefore, in all likelihood, the opposite Greenland shore, contains a clearly developed Carboniferous Limestone fauna, identical with that so widely distributed over the North American continent, and referable also to British and Spitzbergen species. Of the Coal Measures above these, if they occur, we know nothing at present. Capt. Feilden notes as suggestive that, though the explorers have not met with this formation on the northern shores of Greenland, yet it was observed that a continuation of the direction of the known strike of the limestones of Feilden peninsula, carried over the polar area, passes through the neighbourhood of Spitzbergen, where the formation occurs, and contains certain species identical with those of the Grinnell Land rocks of this horizon. The facies of the fossils is, according to Mr Etheridge, North American and Canadian, though many of the species are British. The corals are few in number, but the *Holiscania* (*Polysoa*) are more numerous in species and individuals. No Secondary rocks have been discovered in the extreme northern parts of West Greenland, but they are present on the east and west coasts in more southerly latitudes than Smith Sound.

5. **Jurassic.**—These do not occur on the west coast, but on the east coast the German expedition discovered marls and sandstones on Kuhn Island, resembling those of the Russian Jurassic, characterized by the presence of the genus *Aucella*, *Olcostephanus Payeri*, *O. striolatus*, *Belemnitites Panderianus*, *B. volgensis*, *B. absolutus*, and a *Cyprina* near to *C. zysoloea*. On the south coast of the same island are coarse-grained, brownish micaceous and light-coloured calcareous sandstone and marls, containing fossils, which render it probable that they are of the same age as the coal-bearing Jurassic rocks of Brora (Scotland) and the Middle Dogger of Yorkshire. There is also coal on Kuhn Island.

The Danish expeditions of 1899-1900 have added considerably to our knowledge of the Jurassic rocks of East Greenland. Rhaetic-Elias plants have been described by Dr Harts from Cape Stewart and Vardeløkk. Dr Madsen has recognized fossils that correspond with those from the Inferior oolite, Cornbrash and Callovian of England. Upper Kimmeridge and Portlandian beds also occur.

6. **Cretaceous.**—Beds of this age, consisting of sandstones and coal, are found on the northern coast of Disco Island and the southern side of the Noursoak Peninsula, the beds in the former locality, "the Kome strata" of Nordenkiöld, being the oldest. They reach 1000 ft. in thickness, occupying undulating hollows in the underlying gneiss, and dip towards the Noursoak Peninsula at 20°, when the overlying Atanakerluk strata come in. Both these series contain numerous plant remains, evergreen oaks, magnolias, aralias, &c., and seams of lignite (coal), which is burnt; but in neither occur the marine beds of the United States. Still, the presence of dicotyledonous leaves, such as *Magnolia alternans*, in the Atanakerluk strata, proves their close alliance with the Dakota series of the United States. The underlying Kome beds are not present in the American series. They are characterized by fine cycads (*Zamia arctica* and *Glossosaurus Hoheneggeri*), which also occur in the Urgonian strata of Wermsdorff.

7. **Miocene.**—This formation, one of the most widely spread in polar lands, though the most local in Greenland, is also the best known feature in its geology. It is limited to Disco Island, and perhaps to a small part of the Noursoak Peninsula, and the neighbouring country, and consists of numerous thin beds of sandstone, shale and coal—the siltic shale containing immense quantities of leaves, stems, fruit, &c., as well as some insects, and the coal pieces of retinite. The study of these plant and insect remains shows that forests containing a vegetation very similar to that of

California and the southern United States, in some instances even the species of trees being all but identical, flourished in 70° N. during geological periods comparatively recent. These beds, as well as the Cretaceous series, from which they are as yet only imperfectly distinguished, are associated with sheets of basalt, which penetrate them in great dikes, and in some places, owing to the wearing away of the softer sedimentary rocks, stand out in long walls running across the beds. These Miocene strata have not been found farther north on the Greenland shore than the region mentioned; but in Lady Franklin Bay, on the Grinnell Land side of Smith Sound, they again appear, so that the chances are they will be found on the opposite coast, though doubtless the great disintegration Greenland has undergone and is undergoing has destroyed many of the softer beds of fossiliferous rocks. On the east coast, more particularly in Hochstetter Foreland, the Miocene beds again appear, and we may add that there are traces of them even on the west coast, between Sonntag Bay and Foulke Fjord, at the entrance to Smith Sound. It thus appears that since early Tertiary times there has been a great change in the climate of Greenland.

Nathorst has suggested that the whole of Greenland is a "horst," in the subordinate folds of which, as well as in the deeper "graben," the younger rocks are preserved, often with a covering of Tertiary or later lava flows. [A. H.]

Native Iron.—Native iron was found by Nordenkiöld at Ovifak, on Disco Island, in 1870, and brought to Sweden (1871) as meteorites. The heaviest nodule weighed over 20 tons. Similar native iron has later been found by K. J. V. Steenstrup in several places on the west coast enclosed as smaller or larger nodules in the basalt. This iron has very often beautiful Widmannstätten figures like those of iron meteorites, but it is obviously of telluric origin.³ In 1895 Peary found native iron at Cape York; since John Ross's voyage in 1818 it has been known to exist there, and from it the Eskimo got iron for their weapons. In 1897 Peary brought the largest nodule to New York; it was estimated to weigh nearly 100 tons. This iron is considered by several of the first authorities on the subject to be of meteoric origin,⁴ but no evidence hitherto given seems to prove decisively that it cannot be telluric. That the nodules found were lying on gneissic rock, with no basaltic rocks in the neighbourhood, does not prove that the iron may not originate from basalt, for the nodules may have been transported by the glaciers, like other erratic blocks, and will stand erosion much longer than the basalt, which may long ago have disappeared. This iron seems, however, in several respects to be unlike the celebrated large nodules of iron found by Nordenkiöld at Ovifak, but appears to resemble much more closely the softer kind of iron nodules found by Steenstrup in the basalt; it stands exposure to the air equally well, and has similar Widmannstätten figures very sharp, as is to be expected in such a large mass. It contains, however, more nickel and also phosphorus. A few other minerals may be noticed, and some have been worked to a small extent—graphite is abundant, particularly near Upernivik; cryolite is found almost exclusively at Ivigtut; copper has been observed at several places, but only in nodules and laminae of limited extent; and coal of poor quality is found in the districts about Disco Bay and Umanak Fjord. Steatite or soapstone has long been used by the natives for the manufacture of lamps and vessels.

Climate.—The climate is very uncertain, the weather changing suddenly from bright sunshine (when mosquitos often swarm) to dense fog or heavy falls of snow and icy winds. At Julianehaab in the extreme south-west the winter is not much colder than that of Norway and Sweden in the same locality; but its mean temperature for the whole year probably approximates to that on the Norwegian coast 600 m. farther north. The climate of the interior has been found to be of a continental character, with large ranges of temperature, and with an almost permanent anti-cyclonic region over the interior of the inland ice, from which the prevailing winds radiate towards the coasts. On the 64th parallel the mean annual temperature at an elevation of 6560 ft. is supposed to be -13° F., or reduced to sea-level 5° F. The mean annual temperature in the interior farther north is supposed to be -10° F. reduced to sea-level. The mean temperature of the warmest month, July, in the interior should be, reduced to sea-level, on the 64th parallel 32° F., and that of the coldest month, January, about -22° F., while in North Greenland it is probably -40° reduced to sea-level. Here we may probably find the lowest temperatures of the northern hemisphere. The interior of Greenland contains both summer and winter a pole of cold, situated in the opposite longitude to that of Siberia, with which it is well able to compete in extreme severity. On Nansen's expedition temperatures of about -49° F. were experienced during

¹ See A. G. Nathorst, "Bidrag till nordöstra Grönlands geologi," with map. *Geologiska Föreningens i Stockholm Förhandlingar*, No. 257, Bd. 23, Häft 4, 1901; O. Heer, *Flora fossiliis Arctica* (7 vols., 1868-1883), and especially *Meddelelser om Grönland* for numerous papers on the geology and palaeontology.

² *Medd. om Grönl.*, part iv. pp. 115-131 (Copenhagen, 1883).

³ See Peary, *Northward over the "Great Ice,"* ll. 604 et seq. (New York, 1898).

⁴ See *loc. cit.* pp. 127-128.

the nights in the beginning of September, and the minimum during the winter may probably sink to -90° F. in the interior of the inland ice. These low temperatures are evidently caused by the radiation of heat from the snow-surface in the rarefied air in the interior. The daily range of temperature is therefore very considerable, sometimes amounting to 40° . Such a range is elsewhere found only in deserts, but the surface of the inland ice may be considered to be an elevated desert of snow.¹ The climate of the east coast is on the whole considerably more arctic than that of the west coast on corresponding latitudes; the land is much more completely snow-covered, and the snow-line goes considerably lower. The probability also is that there is more precipitation, and that the mean temperatures are lower.² The well-known strangely warm and dry John-winds of Greenland occur both on the west and the east coast; they are more local than was formerly believed, and are formed by cyclonic winds passing either over mountains or down the outer slope of the inland ice.³ Mirage and similar phenomena and the aurora are common.

Fauna and Flora.—It was long a common belief that the fauna and flora of Greenland were essentially European, a circumstance which would make it probable that Greenland has been separated by sea from America during a longer period of time than from Europe. The correctness of this hypothesis may, however, be doubted. The land mammals of Greenland are decidedly more American than European; the musk-ox, the banded lemming (*Cuniculus torquatus*), the white polar wolf, of which there seems to have been a new invasion recently found on the northern part of the country to the east coast, the Eskimo and the dog—probably also the reindeer—have all come from America, while the other land mammals, the polar fox, the Arctic hare, the stoat (*Muscula erminea*), are perfectly circumpolar forms. The species of seals and whales are, if anything, more American than European and so to some extent are the fishes. The bladder-nose seal (*Cystophora cristata*), for instance, may be said to be a Greenland-American species, while a Scandinavian species, such as the grey seal (*Halichoerus grypus*), appears to be very rare both in Greenland and America. Of the sixty-one species of birds breeding in Greenland, eight are European-Asiatic, four are American, and the rest circumpolar or North Atlantic and North Pacific in their distribution.⁴ About 310 species of vascular plants are found, of which about forty species are American, forty-four European-Asiatic, fifteen endemic, and the rest common both to America and Europe or Asia. We thus see that the American and the European-Asiatic elements of the flora are nearly equivalent; and if the flora of Arctic North America were better known, the number of plants common to America might be still more enlarged.⁵

In the south, a few goats, sheep, oxen and pigs have been introduced. The whaling industry was formerly prolific off the west coast but decayed when the right whale nearly disappeared. The white whale fishery of the Eskimo, however, continued, and sealing is important; walrus are also caught and sometimes narwhal. There are also important fisheries for cod, caplin, halibut, red fish (*Sebastes*) and *sepisak* (*Cyclopterus lumpus*); a shark (*Somniosus microcephalus*) is taken for the oil from its liver; and sea-trout are found in the streams and small lakes of the south. On land reindeer were formerly hunted, to their practical extinction in the south, but in the districts of Godthaab, Sukkertoppen and Holstensborg there are still many reindeer. The eider-duck, guillemot and other sea-birds are in some parts valuable for food in winter, and so is the ptarmigan. Eggs of sea-birds are collected and eider-down. Valuable fur is obtained from the white and blue fox, the skin of the eider-duck and the polar bear.

At Tasiuak ($73^{\circ} 22' N.$), the most northern civilized settlement in the world, gardening has been attempted without success, but several plants do well in forcing frames. At Umanak ($70^{\circ} 40' N.$) is the most northern garden in the world. Broccoli and radishes grow well, turnips (but not every year), lettuce and chervil succeed sometimes, but parsley cannot be reared. At Jacobshavn

¹ H. Mohn, "The Climate of the Interior of Greenland," *The Scott. Geogr. Magazine*, vol. ix. (Edinburgh, 1893), pp. 142-145, 199; H. Mohn and F. Nansen, "Wissenschaftliche Ergebnisse," &c. *Ergänzungsheft No. 105 zu Petermanns Mitteilungen* (1892), p. 51.

² On the climate of the east coast of Greenland see V. Willaume-Jantzen, *Meddelelser om Grønland*, part ix. (1889), pp. 285-310, part xvii. (1895), pp. 171-180.

³ See A. Paulsen, *Meteorolog. Zeitschrift* (1889), p. 241; F. Nansen, *The First Crossing of Greenland* (London, 1890), vol. ii. pp. 496-497; H. Mohn and F. Nansen, "Wissenschaftliche Ergebnisse," &c. *Ergänzungsheft No. 105 zu Petermanns Mitteilungen* (1892), p. 51.

⁴ H. Winge, "Grønlands Fugte," *Meddelelser om Grønland*, part xxi, pp. 62-63 (Copenhagen, 1899).

⁵ See J. Lange, "Conspicua florae Groenlandicae," *Meddelelser om Grønland*, part iii. (Copenhagen, 1880 and 1887); E. Warming, "Om Grønlands Vegetation," *Meddelelser om Grønland*, part xii. (Copenhagen, 1888); and in *Botanische Jahrbücher*, vol. x. (1888-1889). See also A. Blytt, *Englers Jahrbücher*, ii. (1882), pp. 1-50; A. G. Nathorst, *Översigt af K. Vetensk. Akad. Förhandl.* (Stockholm, 1884); "Kritische Bemerkungen über die Geschichte der Vegetation Grønlands," *Botanische Jahrbücher*, vol. xiv. (1891).

($69^{\circ} 12' N.$), only some 15 m. from the inland ice, gardening succeeds very well; broccoli and lettuce grow willingly; the spinach produces large leaves; chervil, pepper-grass, leeks, parsley and turnips grow very well; the radishes are sown and gathered twice during the summer (June to August). In the south, in the Julianehaab district, even flowering plants, such as aster, nemophila and mignonette, are cultivated, and broccoli, spinach, sorrel, chervil, parsley, rhubarb, turnips, lettuce, radishes grow well. Potatoes give fair results when they are taken good care of, carrots grow to a thickness of 1½ in., while cabbage does poorly. Strawberries and cucumbers have been ripened in a forcing frame. In the "Kongespeil" (King's mirror) of the 13th century it is stated that the old Norwegians tried in vain to raise barley.

The wild vegetation in the height of summer is, in favourable situations, profuse in individual plants, though scanty in species. The plants are of the usual arctic type, and identical with or allied to those found in Lapland or on the summits of the highest British hills. Forest there is none in all the country. In the north, where the lichen-covered or ice-shaven rocks do not protrude, the ground is covered with a carpet of mosses, creeping dwarf willows, crowberries and similar plants, while the flowers most common are the andromeda, the yellow poppy, pedicularis, pyrola, &c. besides the flowering mosses; but in South Greenland there is something in the shape of bush, the dwarf birches even rising a few feet in very sheltered places, the willows may grow higher than a man, and the vegetation is less arctic and more abundant.

Government and Trade.—The trade of Greenland is a monopoly of the Danish crown, dating from 1774, and is administered in Copenhagen by a government board (*Kongelige Grønlandske Handel*) and in the country by various government officials. In order to meet the double purposes of government and trade the west coast, up to nearly $74^{\circ} N.$, is divided into two inspectorates, the southern extending to $65^{\circ} 40' N.$, the northern comprising the rest of the country; the respective seats of government being at Godthaab and Godhavn. These inspectorates are ruled by two superior officials or governors responsible to the director of the board in Copenhagen. Each of the inspectorates is divided into districts, each district having, in addition to the chief settlement or *coloni*, several outlying posts and Eskimo hunting stations, each presided over by an *odigger*, who is responsible to the *colonibestyrer*, or superintendent of the district. These trading settlements, which dot the coast for a distance of 1000 m., are about sixty in number. From the Eskimo hunting and fishing stations blubber is the chief article received, and is forwarded in casks to the *coloni*, where it is boiled into oil, and prepared for being despatched to Copenhagen by means of the government ships which arrive and leave between May and November. For the rest of the year navigation is stopped, though the winter months form the busy seal-killing season. The principle upon which the government acts is to give the natives low prices for their produce, but to sell them European articles of necessity at prime cost, and other stores, such as bread, at prices which will scarcely pay for the purchase and freight, while no merchandise is charged, on an average, more than 20% over the cost price in Denmark. In addition the Greenlanders are allowed to order goods from private dealers on paying freight for them at the rate of 2½d. per 10 lb. or 1s. 6d. per cub. ft. The prices to be paid for European and native articles are fixed every year, the prices current in Danish and Eskimo being printed and distributed by the government. Out of the payment five-sixths are given to the sellers, and one-sixth devoted to the Greenlanders' public fund, spent in "public works," in charity, and on other unforeseen contingencies. The object of the monopoly is solely for the good of the Greenlanders—to prevent spirits being sold to them, and the vice, disease and misery which usually attend the collision between natives and civilization of the trader's type being introduced into the primitive arctic community. The inspectors, in addition to being trade superintendents, are magistrates, but serious crime is very rare. Though the officials are all-powerful, local councils or *parissaaet* were organized in 1857 in every district. To these parish parliaments delegates are sent from every station. These *parissaaet*, elected at the rate of about one representative to 120 voters, wear a cap with a badge (a bear rampant), and aid the European members of the council in distributing the surplus profit apportioned to each district, and generally in advising as to the welfare of that part of Greenland under their partial

control. The municipal council has the disposal of 20% of the annual profits made on produce purchased within the confines of each district. It holds two sessions every year, and the discussions are entirely in the Eskimo language. In addition to their functions as guardians of the poor, the parish members have to investigate crimes and punish misdemeanours, settle litigations and divide inheritances. They can impose fines for small offences not worth sending before the inspector, and, in cases of high misdemeanour, have the power of inflicting corporal punishment.

A Danish *coloni* in Greenland might seem to many not to be a cheerful place at best; though in the long summer days they would certainly find some of those on the southern fjords comparatively pleasant. The fact is, however, that most people who ever lived some time in Greenland always long to go back. There are generally in a *coloni* three or four Danish houses, built of wood and pitched over, in addition to storehouses and a blubber-boiling establishment. The Danish residents may include, besides a *coloni-bestyrelse* and his assistant, a *missionair* or clergyman, at a few places also a doctor, and perhaps a carpenter and a schoolmaster. In addition there are generally from twenty to several hundred Eskimo, who live in huts built of stone and turf, each entered by a short tunnel. Lately their houses in the *colonis* have also to some extent been built of imported wood. Following the west coast northward, the trading centres are these: in the south inspectorate, Julianehaab, near which are remains of the early Norse settlements of Eric the Red and his companions (the *Öster-Bygd*); Frederikshaab, in which district are the cryolite mines of Ivigtut; Godthaab, the principal settlement of all, in the neighbourhood of which are also early Norse remains (the *Vester-Bygd*); Sukkertoppen, a most picturesque locality; and Holstenborg. In the north inspectorate the centres are: Egedesminde, on an inlet at the mouth of Disco Bay; Christianshaab, one of the pleasantest settlements in the north, and Jacobshavn, on the inner shores of the same bay; Godhavn (or Lieveby) on the south coast of Disco Island, formerly an important seat of the whaling industry; Ritenbenk, Umanak, and most northerly of all, Upernivik. On the east coast there is but one *coloni*, Angmagssalik, in 65° 30' N., only established in 1894. For ecclesiastical purposes Danish Greenland is reckoned in the province of the bishop of Zealand. The Danish mission in Greenland has a yearly grant of £2000 from the trading revenue of the colony, besides a contribution of £880 from the state. The Moravian mission, which had worked in Greenland for a century and a half, retired from the country in 1900. The trade of Greenland has on the whole much decreased in modern times, and trading and missions cost the Danish state a comparatively large sum (about £11,000 every year), although this is partly covered by the income from the royalty of the cryolite mines at Ivigtut. There is, however, a yearly deficiency of more than £6000. The decline in the value of the trade, which was formerly very profitable, has to a great extent been brought about by the fall in the price of seal-oil. It might be expected that there should be a decrease in the Greenland seal fisheries, caused by the European and American sealers catching larger quantities every year, especially along the coasts of Newfoundland and Labrador, and so actually diminishing the number of the animals in the Greenland seas. The statistics of South Greenland, however, do not seem to demonstrate any such decrease. The average number of seals killed annually is about 33,000.¹ The

¹ Owing to representations of the Swedish government in 1874 as to the killing of seals at breeding time on the east coast of Greenland, and the consequent loss of young seals left to die of starvation, the Seal Fisheries Act 1875 was passed in England to provide for the establishment of a close time for seal fishery in the seas in question. This act empowered the crown, by order in council, to put its provisions in force, when any foreign state, whose ships or subjects were engaged in the seal fishery in the area mentioned in the schedule thereto, had made, or was about to make, similar provisions with respect to its ships and subjects. An order in council under the act, declaring the season to begin on the 3rd of April in each year, was issued February 8, 1876. Rescinded February 15, 1876, it was re-enacted on November 28, 1876, and is still operative.

annual value of imports, consisting of manufactured goods, foodstuffs, &c., may be taken somewhat to exceed £40,000. The chief articles of export (together with those that have lapsed) have been already indicated; but they may be summarized as including seal-oil, seal, fox, bird and bear skins, fish products and eiderdown, with some quantity of worked skins. Walrus tusks and walrus hides, which in the days of the old Norse settlements were the chief articles of export, are now of little importance.

Population.—The area of the entire Danish colony is estimated at 45,000 sq. m., and its population in 1901 was 11,893. The Europeans number about 300. The Eskimo population of Danish Greenland (west coast) seems to have decreased since the middle of the 18th century. Hans Egede estimated the population then at 30,000, but this is probably a large over-estimate. The decrease may chiefly have been due to infectious diseases, especially a very severe epidemic of smallpox. During the last half of the 19th century there was on the whole a slight increase of the native population. The population fluctuates a good deal, owing, to some extent, to an immigration of natives from the east to the west coast. The population of the east coast seems on the whole to be decreasing in number, several hundreds chiefly living at Angmagssalik. In the north part of the east coast, in the region of Scoresby Fjord and Franz Josef Fjord, numerous ruins of Eskimo settlements are found, and in 1823 Clavering met Eskimo there, but now they have either completely died out or have wandered south. A little tribe of Eskimo living in the region of Cape York near Smith Sound—the so-called "Arctic Highlanders" or Smith Sound Eskimo—number about 240.

History.—In the beginning of the 10th century the Norwegian Gunnbjörn, son of Ulf Kráka, is reported to have found some islands to the west of Iceland, and he may have seen, without landing upon it, the southern part of the east coast of Greenland. In 982 the Norwegian Eric the Red sailed from Iceland to find the land which Gunnbjörn had seen, and he spent three years on its south-western coasts exploring the country. On his return to Iceland in 985 he called the land Greenland in order to make people more willing to go there, and reported so favourably on its possibilities that he had no difficulty in obtaining followers. In 986 he started again from Iceland with 25 ships, but only 14 of them reached Greenland, where a colony was founded on the south-west coast, in the present Julianehaab district. Eric built his house at Brattalid, near the inner end of the fjord Tunugdliarfik, just north of the present Julianehaab. Other settlers followed and in a few years two colonies had been formed, one called Österbygd in the present district of Julianehaab comprising later about 190 farms, and another called Vesterbygd farther north on the west coast in the present district of Godthaab, comprising later about 90 farms. Numerous ruins in the various fjords of these two districts indicate now where these colonies were. Wooden coffins, with skeletons wrapped in coarse hairy cloth, and both pagan and Christian tombstones with runic inscriptions have been found. On a voyage from Norway to Greenland Leif Ericsson (son of Eric the Red) discovered America in the year 1000, and a few years later Torfinn Karlsefne sailed with three ships and about 150 men, from Greenland to Nova Scotia to form a colony, but returned three years later (see VINLAND).

When the Norsemen came to Greenland they found various remains indicating, as the old sagas say, that there had been people of a similar kind as those they met with in Vinland, in America, whom they called *Skræling* (the meaning of the word is uncertain, it means possibly weak people); but the sagas do not report that they actually met the natives then. But somewhat later they have probably met with the Eskimo farther north on the west coast in the neighbourhood of Disco Bay, where the Norsemen went to catch seals, walrus, &c. The Norse colonists penetrated on these fishing expeditions at least to 73° N., where a small runic stone from the 14th century has been found. On a voyage in 1267 they penetrated even still farther north into the Melville Bay.

Christianity was introduced by Leif Ericsson at the instance of Olaf Trygvasson, king of Norway, in 1000 and following years. In the beginning of the 12th century Greenland got its own bishop, who resided at Garolar, near the present Eskimo station Igoliko, on an isthmus between two fjords, Igaliksfjord (the old Einarsfjord) and Tunugdliarfik (the old Eriksfjord), inside the present colony Julianehaab. The Norse colonies had twelve churches, one monastery and one nunnery in the Österbygd, and four churches in the Vesterbygd. Greenland, like Iceland, had a republican organization up to the years 1247 to 1261, when the Greenlanders were induced to swear allegiance to the king of Norway. Greenland belonged to the Norwegian crown till 1814, when, at the dissolution of the union between Denmark and Norway, neither it nor Iceland and the Faeroes were mentioned, and they, therefore, were kept by the Danish king and thus came to Denmark. The settlements were called respectively *Öster Bygd* (or eastern settlement) and *Vester* (western) *Bygd*, both being now known to be on the south and west coast (in the districts of Julianehaab and Godthaab respectively), though for long the view was persistently held that the first was on the east coast, and numerous expeditions have been sent in search of these "lost colonies" and their imaginary survivors. These settlements at the height of their prosperity are estimated to have had 10,000 inhabitants, which, however, is an over-estimate, the number having probably been nearer one-half or one-third of that number. The last bishop appointed to Greenland died in 1540, but long before that date those appointed had never reached their sees; the last bishop who resided in Greenland died there in 1377. After the middle of the 14th century very little is heard of the settlements, and their communication with the motherland, Norway, evidently gradually ceased. This may have been due in great part to the fact that the shipping and trade of Greenland became a monopoly of the king of Norway, who kept only one ship sailing at long intervals (of years) to Greenland; at the same time the shipping and trade of Norway came more and more in the hands of the Hanseatic League, which took no interest in Greenland. The last ship that is known to have visited the Norse colony in Greenland returned to Norway in 1410. With no support from home the settlements seem to have decayed rapidly. It has been supposed that they were destroyed by attacks of the Eskimo, who about this period seem to have become more numerous and to have extended southwards along the coast from the north. This seems a less feasible explanation; it is more probable that the Norse settlers intermarried with the Eskimo and were gradually absorbed. About the end of the 15th or the beginning of the 16th century it would appear that all Norse colonization had practically disappeared. When in 1585 John Davis visited it there was no sign of any people save the Eskimo, among whose traditions are a few directly relating to the old Norsemen, and several traces of Norse influence.¹ For more than two hundred years Greenland seems to have been neglected, almost forgotten. It was visited by whalers, chiefly Dutch, but nothing in the form of permanent European settlements was established until the year 1721, when the first missionary, the Norwegian clergyman Hans Egede, landed, and established a settlement near Godthaab. Amid many hardships and discouragements he persevered; and at the present day the native race is civilized and Christianized. Many of the colonists of the 18th century were convicts and other offenders; and in 1750 the trade became a monopoly in the hands of a private company. In 1733-1734 there was a dreadful epidemic of smallpox, which destroyed a great number of the people. In 1774 the trade ceased to be profitable as a private monopoly, and to prevent it being abandoned the government took it over. Julianehaab was founded in the following year. In 1807-1814, owing to the war, communication was cut off with Norway and Denmark; but subsequently the colony prospered in a languid fashion.

Authorities.—As to the discovery of Greenland by the Norsemen and its early history see Konrad Maurer's excellent paper, "Geschichte der Entdeckung Ostgrönlands" in the report of *Die zweite*

¹ Cf. F. Nansen, *Eskimo Life* (London, 1893).

deutsche Nordpolarfahrt 1869-1870 (Leipzig, 1874), vol. i.; G. Storm, *Studies on the "Vineland" Voyages* (Copenhagen, 1889); *Extraits des Mémoires de la Société Royale des Antiquaires du Nord* (1888); K. J. V. Steenstrup, "Om Österbygdens," *Meddelelser om Grönland*, part ix. (1882), pp. 1-51; Finnur Jónsson, "Grönlands gamle Topografi efter Kilderne" in *Meddelelser om Grönland*, part xx. (1899), pp. 265-329; Joseph Fischer, *The Discoveries of the Norsemen in America*, translated from German by B. H. Soulsby (London, 1903). As to the general literature on Greenland, a number of the more important modern works have been noticed in footnotes. The often-quoted *Meddelelser om Grönland* is of especial value: it is published in parts (Copenhagen) since 1879, and is chiefly written in Danish, but each part has a summary in French. In part xiii. there is a most valuable list of literature about Greenland up to 1880. See also *Geographical Journal*, passim.

Amongst other important books on Greenland may be mentioned: Hans Egede, *Description of Greenland* (London, 1745); Crantz, *History of Greenland* (2 vols., London, 1820); *Grönlands historiske Mindesmerker* (3 vols., Copenhagen, 1838-1845); H. Rink, *Danish Greenland* (London, 1877); H. Rink, *Tales of the Eskimo* (London, 1875); (see also same, "Eskimo Tribes" in *Meddelelser om Grönland*, part xi.); Johnstrup, *Giesecke's Mineralogische Reise i Grönland* (Copenhagen, 1878). (F. N.)

GREENLAW (a "grassy hill"), a town of Berwickshire, Scotland. Pop. (1901) 611. It is situated on the Blackadder, 6½ m. S.E. of Edinburgh by the North British railway company's branch line from Reston Junction to St Boswells. The town was built towards the end of the 17th century, to take the place of an older one, which stood about a mile to the S.E. It was the county town from 1696 to 1853, when for several years it shared this dignity with Duns, which, however, is now the sole capital. The chief manufactures are woollens and agricultural implements. About 3 m. to the S. the ruin of Hume Castle, founded in the 13th century, occupies a commanding site. Captured by the English in 1547, in spite of Lady Home's gallant defence, it was retaken two years afterwards, only to fall again in 1569. After its surrender to Cromwell in 1650 it gradually decayed. Towards the close of the 18th century the 3rd earl of Marchmont had the walls rebuilt out of the old stones, and the castle, though a mere shell of the original structure, is now a picturesque ruin.

GREENLEAF, SIMON (1785-1853), American jurist, was born at Newburyport, Massachusetts, on the 5th of December 1783. When a child he was taken by his father to Maine, where he studied law, and in 1806 began to practise at Standish. He soon removed to Gray, where he practised for twelve years, and in 1818 removed to Portland. He was reporter of the supreme court of Maine from 1820 to 1832, and published nine volumes of *Reports of Cases in the Supreme Court of Maine* (1822-1835). In 1833 he became Royall professor, and in 1846 succeeded Judge Joseph Story as Dane professor of law in Harvard University; in 1848 he retired from his active duties, and became professor emeritus. After being for many years president of the Massachusetts Bible Society, he died at Cambridge, Mass., on the 6th of October 1853. Greenleaf's principal work is a *Treatise on the Law of Evidence* (3 vols., 1842-1853). He also published *A Full Collection of Cases Overruled, Denied, Doubted, or Limited in their Application, taken from American and English Reports* (1821), and *Examination of the Testimony of the Four Evangelists by the Rules of Evidence administered in the Courts of Justice, with an account of the Trial of Jesus* (1846; London, 1847). He revised for the American courts William Cruise's *Digest of Laws respecting Real Property* (3 vols., 1849-1850).

GREEN MONKEY, a West African representative of the typical group of the guenon monkeys technically known as *Cercopithecus callitrichus*, taking its name from the olive-greenish hue of the fur of the back, which forms a marked contrast to the white whiskers and belly.

GREENOCK, a municipal and police burgh and seaport of Renfrewshire, Scotland, on the southern shore of the Firth of Clyde, 23 m. W. by N. of Glasgow by the Caledonian and the Glasgow & South-Western railways, 21 m. by the river and firth. Pop. (1901) 68,142. The town has a water frontage of nearly 4 m. and rises gradually to the hills behind the town in which are situated, about 3 m. distant, Loch Thom and Loch Gryfe, from both of which is derived the water supply for domestic use, and for driving several mills and factories. The streets are

laid out on the comparatively level tract behind the firth, the older thoroughfares and buildings lying in the centre. The west end contains numerous handsome villas and a fine esplanade, 1½ m. long, running from Prince's Pier to Fort Matilda, which is supplied with submarine mines for the defence of the river. The capacious bay, formerly known as the Bay of St Lawrence from a religious house long since demolished, is protected by a sandbank that ends here, and is hence known as the Tail of the Bank. The fairway between this bank, which begins to the west of Dumbarton, and the southern shore constitutes the safest anchorage in the upper firth. There is a continuous line of electric tramways, connecting with Port Glasgow on the east and Gourock on the west, a total distance of 7½ m. The annual rainfall amounts to 64 in. and Greenock thus has the reputation of being the wettest town in Scotland.

Many of the public buildings are fine structures. The municipal buildings, an ornate example of Italian Renaissance, with a tower 244 ft. high, were opened in 1887. The custom house on the old steamboat quay, in classic style with a Doric portico, dates from 1818. The county buildings (1867) have a tower and spire 112 ft. high. The Watt Institution, founded in 1837 by a son of the famous engineer, James Watt, contains the public library (established in 1783), the Watt scientific library (presented in 1826 by Watt himself), and the marble statue of James Watt by Sir Francis Chantry. Adjoining it are the museum and lecture hall, the gift of James McLean, opened in 1876. Other buildings are the sheriff court house, and the Spence Library, founded by the widow of William Spence the mathematician. In addition to numerous board schools there are the Greenock academy for secondary education, the technical college (1900), the school of art, and a school of navigation and engineering. The charitable institutions include the infirmary; the cholera hospital; the eye infirmary; the fever reception house; Sir Gabriel Wood's mariners' asylum, an Elizabethan building erected in 1851 for the accommodation of aged merchant seamen; and the Smithson poorhouse and lunatic asylum, built beyond the southern boundary in 1879. Near Albert Harbour stands the old west tower the north parish church (a Gothic edifice dating from 1591) containing some stained-glass windows by William Morris; in its kirkyard Burns's "Highland Mary" was buried (1786). The west parish church in Nicholson Street (1839) is in the Italian Renaissance style and has a campanile. The middle parish church (1759) in Cathcart Square is in the Classic style with a fine spire. Besides burial grounds near the infirmary and attached to a few of the older churches, a beautiful cemetery, 90 acres in extent, has been laid out in the south-western district. The parks and open spaces include Wellington Park, Well Park in the heart of the town (these were the gift of Sir Michael Shaw-Stewart), Whin Hill, Lyle Road—a broad drive winding over the heights towards Gourock, constructed as a "relief work" in the severe winter of 1879-1880.

Greenock is under the jurisdiction of a town council with provost and bailies. It is a parliamentary burgh, represented by one member. The corporation owns the supplies of water (the equipment of works and reservoirs is remarkably complete), gas, electric light and power, and the tramways (leased to a company). The staple industries are shipbuilding (established in 1760) and sugar refining (1765). Greenock-built vessels have always been esteemed, and many Cunard, P. & O. and Allan liners have been constructed in the yards. The town has been one of the chief centres of the sugar industry. Other important industries include the making of boilers, steam-engines, locomotives, anchors, chain-cables, sailcloth, ropes, paper, woollen and worsted goods, besides general engineering, an aluminium factory, a flax-spinning mill, distilleries and an oil-refinery. The seal and whale fisheries, once vigorously prosecuted, are extinct, but the fishing-fleets for the home waters and the Newfoundland grounds are considerable. Till 1772 the town leased the first harbour (finished in 1710) from Sir John Shaw, the superior, but acquired it in that and the following year, and a graving dock was opened in 1786. Since then additions and improvements have been periodically in progress, and there are now several

tidal harbours—among them Victoria harbour, Albert harbour, the west harbour, the east harbour, the northern tidal harbour, the western tidal harbour, the great harbour and James Watt dock (completed in 1886 at a cost of £650,000 with an area of 2000 ft. by 400 ft. with a depth at low water of 32 ft.), Garvel graving dock and other dry docks. The quayside exceeds 200 acres in area and the quay walls are over 3 m. in length. Both the Caledonian and the Glasgow & South-Western railways (in Prince's Pier the latter company possesses a landing-stage nearly 1400 ft. long) have access to the quays. From first to last the outlay on the harbour has exceeded £1,500,000.

In the earlier part of the 17th century Greenock was a fishing village, consisting of one row of thatched cottages. A century later there were only six slated houses in the place. In 1635 it was erected by Charles I. into a burgh of barony under a charter granted to John Shaw, the government being administered by a baron-bailie, or magistrate, appointed by the superior. Its commercial prosperity received an enormous impetus from the Treaty of Union (1707), under which trade with America and the West Indies rapidly developed. The American War of Independence suspended progress for a brief interval, but revival set in in 1783, and within the following seven years shipping trebled in amount. Meanwhile Sir John Shaw—to whom and to whose descendants, the Shaw-Stewarts, the town has always been indebted—by charter (dated 1741 and 1751) had empowered the householders to elect a council of nine members, which proved to be the most liberal constitution of any Scots burgh prior to the Reform Act of 1832, when Greenock was raised to the status of a parliamentary burgh with the right to return one member to parliament. Greenock was the birthplace of James Watt, William Spence (1777-1815) and Dr John Caird (1820-1898), principal of Glasgow University, who died in the town and was buried in Greenock cemetery. John Galt, the novelist, was educated in Greenock, where he also served some time in the custom house as a clerk. Rob Roy is said to have raided the town in 1715.

GREENOCKITE, a rare mineral composed of cadmium sulphide, CdS, occurring as small, brilliant, honey-yellow crystals or as a canary-yellow powder. Crystals are hexagonal with hemimorphic development, being differently terminated at the two ends. The faces of the hexagonal prism and of the numerous hexagonal pyramids are deeply striated horizontally. The crystals are translucent to transparent, and have an adamantine to resinous lustre; hardness 3-3½; specific gravity 4.9. Crystals have been found only in Scotland, at one or two places in the neighbourhood of Glasgow, where they occur singly on prehnite in the amygdaloidal cavities of basaltic igneous rocks—a rather unusual mode of occurrence for a metallic sulphide. The first, and largest crystal (about ¼ in. across) was found, about the year 1810, in the dolerite quarry at Bowling in Dumbartonshire, but this was thought to be blende. A larger number of crystals, but of smaller size, were found in 1840 during the cutting of the Bishopton tunnel on the Glasgow & Greenock railway; they were detected by Lord Greenock, afterwards the 2nd earl of Cathcart, after whom the mineral was named. A third locality is the Boyleston quarry near Barrhead. At all other localities—Pražbram in Bohemia, Laurion in Greece, Joplin in Missouri, &c.—the mineral is represented only as a powder dusted over the surface of zinc minerals, especially blende and calamine, which contain a small amount of cadmium replacing zinc.

Isomorphous with greenockite is the hexagonal zinc sulphide (ZnS) known as wurtzite. Both minerals have been prepared artificially, and are not uncommon as furnace products. Previous to the recent discovery in Sardinia of cadmium oxide as small octahedral crystals, greenockite was the only known mineral containing cadmium as an essential constituent. (L. J. S.).

GREENORE, a seaport and watering-place of county Louth, Ireland, beautifully situated at the north of Carlingford Lough on its western shore. It was brought to importance by the action of the London & North-Western railway company of England, which owns the pier and railways joining the Great Northern system at Dundalk (12½ m.) and Newry (14 m.). A regular

service of passenger steamers controlled by the company runs to Holyhead, Wales, 80 m. S.E. A steam ferry crosses the Lough to Greencastle, for Killeel, and the southern watering-places of county Down. The company also owns the hotel, and laid out the golf links. In the vicinity a good example of raised beach, some 10 ft. above present sea-level, is to be seen.

GREENOUGH, GEORGE BELLAS (1778-1855), English geologist, was born in London on the 18th of January 1778. He was educated at Eton, and afterwards (1795) entered Pembroke College, Oxford, but never graduated. In 1798 he proceeded to Göttingen to prosecute legal studies, but having attended the lectures of Blumenbach he was attracted to the study of natural history, and, coming into the possession of a fortune, he abandoned law and devoted his attention to science. He studied mineralogy at Freiberg under Werner, travelled in various parts of Europe and the British Isles, and worked at chemistry at the Royal Institution. A visit to Ireland aroused deep interest in political questions, and he was in 1807 elected member of parliament for the borough of Gattou, continuing to hold his seat until 1812. Meanwhile his interest in geology increased, he was elected F.R.S. in 1807, and he was the chief founder with others of the Geological Society of London in 1807. He was the first chairman of that Society, and in 1811, when it was more regularly constituted, he was the first president: and in this capacity he served on two subsequent occasions, and did much to promote the advancement of geology. In 1819 he published *A Critical Examination of the First Principles of Geology*, a work which was useful mainly in refuting erroneous theories. In the same year was published his famous *Geological Map of England and Wales*, in six sheets; of which a second edition was issued in 1839. This map was to a large extent based on the original map of William Smith; but much new information was embodied. In 1843 he commenced to prepare a geological map of India, which was published in 1854. He died at Naples on the 2nd of April 1855.

GREENOUGH, HORATIO (1805-1852), American sculptor, son of a merchant, was born at Boston, on the 6th of September 1805. At the age of sixteen he entered Harvard, but he devoted his principal attention to art, and in the autumn of 1825 he went to Rome, where he studied under Thorwaldsen. After a short visit in 1826 to Boston, where he executed busts of John Quincy Adams and other people of distinction, he returned to Italy and took up his residence at Florence. Here one of his first commissions was from James Fenimore Cooper for a group of Chanting Cherubs; and he was chosen by the American government to execute the colossal statue of Washington for the national capital. It was unveiled in 1843, and was really a fine piece of work for its day; but in modern times it has been sharply criticized as unworthy and incongruous. Shortly afterwards he received a second government commission for a colossal group, the "Rescue," intended to represent the conflict between the Anglo-Saxon and Indian races. In 1851 he returned to Washington to superintend its erection, and in the autumn of 1852 he was attacked by brain fever, of which he died in Somerville near Boston on the 18th of December. Among other works of Greenough may be mentioned a bust of Lafayette, the Medora and the Venus Victrix in the gallery of the Boston Athenaeum. Greenough was a man of wide culture, and wrote well both in prose and verse.

See H. T. Tuckerman, *Memoir of Horatio Greenough* (New York, 1853).

GREENOUGH, JAMES BRADSTREET (1833-1901), American classical scholar, was born in Portland, Maine, on the 4th of May 1833. He graduated at Harvard in 1856, studied one year at the Harvard Law School, was admitted to the Michigan bar, and practised in Marshall, Michigan, until 1865, when he was appointed tutor in Latin at Harvard. In 1873 he became assistant professor, and in 1883 professor of Latin, a post which he resigned hardly six weeks before his death at Cambridge, Massachusetts, on the 11th of October 1901. Following the lead of Goodwin's *Moods and Tenses* (1860), he set himself to study Latin historical syntax, and in 1870 published *Analysis*

of the Latin Subjunctive, a brief treatise, privately printed, of much originality and value, and in many ways coinciding with Berthold Delbrück's *Gebrauch des Conjunctivus und Optativus in Sanskrit und Griechischen* (1871), which, however, quite overshadowed the *Analysis*. In 1872 appeared *A Latin Grammar for Schools and Colleges, founded on Comparative Grammar*, by Joseph A. Allen and James B. Greenough, a work of great critical carefulness. His theory of *cum*-constructions is that adopted and developed by William Gardner Hale. In 1872-1880 Greenough offered the first courses in Sanskrit and comparative philology given at Harvard. His fine abilities for advanced scholarship were used outside the classroom in editing the Allen and Greenough Latin Series of text-books, although he occasionally contributed to *Harvard Studies in Classical Philology* (founded in 1889 and endowed at his instance by his own class) papers on Latin syntax, prosody and etymology—a subject on which he planned a long work—on Roman archaeology and on Greek religion at the time of the New Comedy. He assisted largely in the founding of Radcliffe College. An able English scholar and an excellent etymologist, he collaborated with Professor George L. Kittredge on *Words and their Ways in English Speech* (1901), one of the best books on the subject in the language. He wrote clever light verse, including *The Blackbirds*, a comediotta, first published in *The Atlantic Monthly* (vol. xxxix. 1877); *The Rose and the Ring* (1880), a pantomime adapted from Thackeray; *The Queen of Hearts* (1885), a dramatic fantasia; and *Old King Cole* (1880), an operetta.

See the sketch by George L. Kittredge in *Harvard Studies in Classical Philology*, vol. xiv. (1903), pp. 1-17 (also printed in *Harvard Graduates' Magazine*, vol. x., Dec. 1901, pp. 196-201).

GREEN RIBBON CLUB, one of the earliest of the loosely combined associations which met from time to time in London taverns or coffee-houses for political purposes in the 17th century. It had its meeting-place at the King's Head tavern at Chancery Lane End, and was therefore known as the "King's Head Club." It seems to have been founded about the year 1675 as a resort for members of the political party hostile to the court, and as these associates were in the habit of wearing in their hats a bow, or "bob," of green ribbon, as a distinguishing badge useful for the purpose of mutual recognition in street brawls, the name of the club became changed, about 1679, to the Green Ribbon Club. The frequenters of the club were the extreme faction of the country party, the men who supported Titus Oates, and who were concerned in the Rye House Plot and Monmouth's rebellion. Roger North tells us that "they admitted all strangers that were confidently introduced, for it was a main end of their institutions to make proselytes, especially of the raw estated youth newly come to town." According to Dryden (*Absalom and Achitophel*) drinking was the chief attraction, and the members talked and organized sedition over their cups. Thomas Dangerfield supplied the court with a list of forty-eight members of the Green Ribbon Club in 1679; and although Dangerfield's numerous perjuries make his unsupported evidence worthless, it receives confirmation as regards several names from a list given to James II. by Nathan Wade in 1685 (*Harleian MSS.* 6845), while a number of more eminent personages are mentioned in *The Cabal*, a satire published in 1680, as also frequenting the club. From these sources it would appear that the duke of Monmouth himself, and statesmen like Halifax, Shaftesbury, Buckingham, Macclesfield, Cavendish, Bedford, Grey of Warke, Herbert of Chisbury, were among those who fraternized at the King's Head Tavern with third-rate writers such as Scroop, Mulgrave and Shadwell, with remnants of the Cromwellian régime like Falconbridge, Henry Ireton and Claypole, with such profligates as Lord Howard of Escrick and Sir Henry Blount, and with scoundrels of the type of Dangerfield and Oates. An allusion to Dangerfield, notorious among his other crimes and treacheries for a seditious paper found in a meal-tub, is found in connexion with the club in *The Loyal Subjects' Litany*, one of the innumerable satires of the period, in which occur the lines:

From the dark-lantern Plot, and the Green Ribbon Club
From brewing sedition in a sanctified Tub,
Libera nos, Domine.

The club was the headquarters of the Whig opposition to the court, and its members were active promoters of conspiracy and sedition. The president was either Lord Shaftesbury or Sir Robert Peyton, M.P. for Middlesex, who afterwards turned informer. The Green Ribbon Club served both as a debating society and an intelligence department for the Whig faction. Questions under discussion in parliament were here threshed out by the members over their tobacco and ale; the latest news from Westminster or the city was retailed in the tavern, "for some or others were continually coming and going," says Roger North, "to import or export news and stories." Slander of the court or the Tories was invented in the club and sedulously spread over the town, and measures were there concerted for pushing on the Exclusion Bill, or for promoting the pretensions of the duke of Monmouth. The popular credulity as to Catholic outrages in the days of the Popish Plot was stimulated by the scandalmongers of the club, whose members went about in silk armour, supposed to be bullet proof, "in which any man dressed up was as safe as a house," says North, "for it was impossible to strike him for laughing"; while in their pockets, "for street and crowd-work," they carried the weapon of offence invented by Stephen College and known as the "Protestant Flail."

The genius of Shaftesbury found in the Green Ribbon Club the means of constructing the first systematized political organization in England. North relates that "every post conveyed the news and tales legitimated there, as also the malign constructions of all the good actions of the government, especially to places where elections were depending, to shape men's characters into fit qualifications to be chosen or rejected." In the general election of January and February 1679 the Whig interest throughout the country was managed and controlled by a committee sitting at the club in Chancery Lane. The club's organizing activity was also notably effective in the agitation of the Petitioners in 1679. This celebrated movement was engineered from the Green Ribbon Club with all the skill and energy of a modern caucus. The petitions were prepared in London and sent down to every part of the country, where paid canvassers took them from house to house collecting signatures with an air of authority that made refusal difficult. The great "pope-burning" processions in 1680 and 1681, on the anniversary of Queen Elizabeth's accession, were also organized by the club. They ended by the lighting of a huge bon-fire in front of the club windows; and as they proved an effective means of inflaming the religious passions of the populace, it was at the Green Ribbon Club that the *mobile vulgus* first received the nickname of "the mob." The activity of the club was, however, short-lived. The failure to carry the Exclusion Bill, one of the favourite projects of the faction, was a blow to its influence, which declined rapidly after the flight of Shaftesbury, the confiscation of the city of London's charter, and the discovery of the Rye House Plot, in which many of its members were implicated. In 1685 John Ayloff, who was found to have been "a clubber at the King's Head Tavern and a green-ribbon man," was executed in front of the premises on the spot where the "pope-burning" bon-fires had been kindled; and although the tavern was still in existence in the time of Queen Anne, the Green Ribbon Club which made it famous did not survive the accession of James II. The precise situation of the King's Head Tavern, described by North as "over against the Inner Temple Gate," was at the corner of Fleet Street and Chancery Lane, on the east side of the latter thoroughfare.

See Sir George Sitwell, *The First Whig* (Scarborough, 1894), containing an illustration of the Green Ribbon Club and a pope-burning procession; Roger North, *Examen* (London, 1740); Anchtell Grey, *Debates of the House of Commons, 1667-1684*, vol. viii. (10 vols., London, 1769); Sir John Bramston, *Autobiography* (Camden Soc., London, 1845). (R. J. M.)

GREENSAND, in geology, the name that has been applied to no fewer than three distinct members of the Cretaceous System, viz. the Upper Greensand (see GAULT), the Lower Greensand and the so-called Cambridge Greensand, a local phase of the base of the Chalk (q.v.). The term was introduced by the early English geologists for certain sandy rocks which frequently

exhibited a greenish colour on account of the presence of minute grains of the green mineral glauconite. Until the fossils of these rocks came to be carefully studied there was much confusion between what is now known as the Upper Greensand (Selbornian) and the Lower Greensand. Here we shall confine our attention to the latter.

The Lower Greensand was first examined in detail by W. H. Fitton (*Q.J.G.S.* iii., 1847), who, in 1845, had proposed the name "Vectine" for the formation. The name was revived under the form "Vectian" in 1885 by A. J. Jukes-Browne, because, although sands and sandstones prevail, the green colour has often changed by oxidation of the iron to various shades of red and brown, and other lithological types, clays and limestones represent this horizon in certain areas. The Lower Greensand is typically developed in the Wealden district, in the Isle of Wight, in Dorsetshire about Swanage, and it appears again beneath the northern outcrop of the Chalk in Berkshire, Oxfordshire and Bedfordshire, and thence it is traceable through Norfolk and Lincolnshire into east Yorkshire. It rests conformably upon the Wealden formation in the south of England, but it is clearly separable from the beds beneath by the occurrence of marine fossils, and by the fact that there is a marked overlap of the Lower Greensand on the Weald in Wiltshire, and derived pebbles are found in the basal beds. The whole series is 800 ft. thick at Atherfield in the Isle of Wight, but it thins rapidly westward. It is usually clearly marked off from the overlying Gault.

In the Wealden area the Lower Greensand has been subdivided as follows, although the several members are not everywhere recognizable:—

Isle of Wight.

Folkestone Beds (70-100 ft.) . Carstone and Sand rock series.
Sandgate Beds (75-100 ft.) . Ferruginous Sands (Shanklin sands).
Hythe Beds (80-300 ft.) . Ferruginous Sands (Walpen sands).
Atherfield Clay (20-90 ft.) . Atherfield Clay.

The Atherfield Clay is usually a sandy clay, fossiliferous. The basal portion, 5-6 ft., is known as the "Perna bed" from the abundance of *Perna Mulleti*; other fossils are *Hoplites Deshayesi*, *Exogyra sinuata*, *Ancylloceras Mathesonianum*. The Hythe beds are interstratified thin limestones and sandstones; the former are bluish-grey in colour, compact and hard, with a certain amount of quartz and glauconite. The limestone is known locally as "rag"; the Kentish Rag has been largely employed as a building stone and roadstone; it frequently contains layers of chert (known as Sevenoaks stone near that town). The sandy portions are very variable; the stone is often clayey and calcareous and rarely hard enough to make a good building stone; locally it is called "hassock" (or Calkstone). The two stones are well exposed in the Iguanodon Quarry near Maidstone (so called from the discovery of the bones of that reptile). Southwest of Dorking sandstone and grit become more prevalent, and it is known there as "Bargate stone," much used around Godalming. Pulborough stone is another local sandstone of the Hythe beds. Fuller's earth occurs in parts of this formation in Surrey. The Sandgate beds, mainly dark, argillaceous sand and clay, are well developed in east Kent, and about Midhurst, Pulborough and Petworth. At Nutfield the celebrated fuller's earth deposits occur on this horizon; it is also found near Maidstone, at Bletchingley and Red Hill. The Folkestone beds are light-coloured, rather coarse sands, enclosing layers of siliceous limestone (Folkestone stone) and chert; a phosphatic bed is found near the top. These beds are well seen in the cliffs at Folkestone and near Reigate. At Igham there is a fine, hard, white sandstone along with a green, quartzitic variety (Igham stone). In Sussex the limestone and chert are usually lacking, but a ferruginous grit, "carstone," occurs in lenticular masses and layers, which is used for road metal at Pulborough, Fittleworth, &c.

The Lower Greensand usually forms picturesque, healthy country, as about Leith Hill, Hindhead, Midhurst, Petworth, at Woburn, or at Shanklin and Sandown in the Isle of Wight. Outside the southern area the Lower Greensand is represented by the Faringdon sponge-bearing beds in Berkshire, the Sandy and

Potton beds in Bedfordshire, the Shotover iron sands of Oxfordshire, the sands and fuller's earth of Woburn, the Leighton Buzzard sands, the brick clays of Snettisham, and perhaps the Sandringham sands of Norfolk, and the carstone of that county and Lincolnshire. The upper ironstone, limestone and clay of the Lincolnshire Tealby beds appear to belong to this horizon along with the upper part of the Speeton beds of Yorkshire. The sands of the Lower Greensand are largely employed for the manufacture of glass, for which purpose they are dug at Aylesford, Godstone, near Reigate, Hartshill, near Aylesbury and other places; the ferruginous sand is worked as an iron ore at Seend.

This formation is continuous across the channel into France, where it is well developed in Boulonnais. According to the continental classification the Atherfield Clay is equivalent to the Urganian or Barremian; the Sandgate and Hythe beds belong to the Aptian (q.v.); while the upper part of the Folkestone beds would fall within the lower Albian (q.v.).

See the *Memoirs of the Geological Survey*, "Geology of the Weald" (1875), "Geology of the Isle of Wight" (2nd ed., 1889), "Geology of the Isle of Purbeck" (1898), and the *Records of Excursions*, Geologists' Association (London, 1891). (J. A. H.)

GREENSBORO, a city and the county-seat of Guilford county, North Carolina, U.S.A., about 80 m. N.W. of Raleigh. Pop. (1890) 3317, (1900) 10,035, of whom 4086 were negroes; (1910 census), 15,895. Greensboro is served by several lines of the Southern railway. It is situated in the Piedmont region of the state and has an excellent climate. The city is the seat of the State Normal and Industrial College (1892) for girls; of the Greensboro Female College (Methodist Episcopal, South; chartered in 1838 and opened in 1846), of which the Rev. Charles F. Deems was president in 1850-1854, and which, owing to the burning of its buildings, was suspended from 1863 to 1874; and of two institutions for negroes—a State Agricultural and Mechanical College, and Bennett College (Methodist Episcopal, co-educational, 1873). Another school for negroes, Immanuel Lutheran College (Evangelical Lutheran, co-educational), was opened at Concord, N.C., in 1903, was removed to Greensboro in 1905, and in 1907 was established at Lutherville, E. of Greensboro. About 6 m. W. of Greensboro is Guilford College (co-educational; Friends), founded as "New Garden Boarding School" in 1837 and re-chartered under its present name in 1888. Greensboro has a Carnegie library, St Leo hospital and a large auditorium. It is the shipping-point for an agricultural, lumbering and trucking region, among whose products Indian corn, tobacco and cotton are especially important; is an important insurance centre; has a large wholesale trade; and has various manufactures, including cotton goods¹ (especially blue denim), tobacco and cigars, lumber, furniture, sash, doors and blinds, machinery, foundry products and terra-cotta. The value of the factory products increased from \$925,411 in 1900 to \$1,828,837 in 1905, or 97.6%. The municipality owns and operates the water-works. Greensboro was named in honour of General Nathanael Greene, who on the 15th of March 1781 fought with Cornwallis the battle of Guilford Court House, about 6 m. N.W. of the city, where there is now a Battle-Ground Park of 100 acres (including Lake Wilfong); this park contains a Revolutionary museum, and twenty-nine monuments, including a Colonial Column, an arch (1906) in memory of Brig.-General Francis Nash (1720-1777), of North Carolina, who died in October 1777 of wounds received at Germantown, and Davidson Arch (1905), in honour of William Lee Davidson (1746-1781), a brigadier-general of North Carolina troops, who was killed at Catawba and in whose honour Davidson College, at Davidson, N.C., was named. Greensboro was founded and became the county-seat in 1808, was organized as a town in 1829, and was first chartered as a city in 1870.

¹One of the first cotton mills in the South and probably the first in this state was established at Greensboro in 1832. It closed about 20 years afterwards, and in 1889 new mills were built. Three very large mills were built in the decade after 1895, and three mill villages, Proximity, Revolution and White Oak, named from these three mills, lie immediately N. of the city; in 1908 their population was estimated at 8000. The owners of these mills maintain schools for the children of operatives and carry on "welfare work" in these villages.

GREENSBURG, a borough and the county-seat of Westmoreland county, Pennsylvania, U.S.A., 31 m. E.S.E. of Pittsburgh. Pop. (1890) 4202; (1900) 6508 (484 foreign-born); (1910) 5420. It is served by two lines of the Pennsylvania railway. It is an important coal centre, and manufactures engines, iron and brass goods, flour, lumber and bricks. In addition to its public school system, it has several private schools, including St Mary's Academy and St Joseph's Academy, both Roman Catholic. About 3 m. N.E. of what is now Greensburg stood the village of Hanna's Town, settled about 1770 and almost completely destroyed by the Indians on the 13th of July 1782; here what is said to have been the first court held west of the Alleghenies opened on the 6th of April 1773, and the county courts continued to be held here until 1787. Greensburg was settled in 1784-1785, immediately after the opening of the state road, not far from the trail followed by General John Forbes on his march to Fort Duquesne in 1758; it was made the county-seat in 1787, and was incorporated in 1799. In 1905 the boroughs of Ludwick (pop. in 1900, 901), East Greensburg (1900), and South-east Greensburg (620) were merged with Greensburg.

See John N. Boucher's *History of Westmoreland County, Pa.* (3 vols., New York, 1906).

GREENSHANK, one of the largest of the birds commonly known as sandpipers, the *Totanus glottis* of most ornithological writers. Some exercise of the imagination is however needed to see in the dingy olive-coloured legs of this species a justification of the English name by which it goes, and the application of that name, which seems to be due to Pennant, was probably by way of distinguishing it from two allied but perfectly distinct species of *Totanus* (*T. calidris* and *T. fuscus*) having red legs and usually called redshanks. The greenshank is a native of the northern parts of the Old World, but in winter it wanders far to the south, and occurs regularly at the Cape of Good Hope, in India and thence throughout the Indo-Malay Archipelago to Australia. It has also been recorded from North America, but its appearance there must be considered accidental. Almost as bulky as a woodcock, it is of a much more slender build, and its long legs and neck give it a graceful appearance, which is enhanced by the activity of its actions. Disturbed from the moor or marsh, where it has its nest, it rises swiftly into the air, conspicuous by its white back and rump, and uttering shrill cries round the intruder. It will perch on the topmost bough of a tree, if a tree be near, to watch his proceedings, and the cock exhibits all the astounding gesticulations in which the males of so many other *Limicolae* indulge during the breeding-season—with certain variations, however, that are peculiarly its own. It breeds in no small numbers in the Hebrides, and parts of the Scottish Highlands from Argyllshire to Sutherland, as well as in the more elevated or more northern districts of Norway, Sweden and Finland, and probably also thence to Kamchatka. In North America it is represented by two species, *Totanus semipalmatus* and *T. melanoleucus*, there called willets, telltales or tattlers, which in general habits resemble the greenshank of the Old World. (A. N.)

GREENVILLE, a city and the county-seat of Washington county, Mississippi, U.S.A., on the E. bank of the Mississippi river, about 75 m. N. of Vicksburg. Pop. (1890) 6658; (1900) 7642 (4987 negroes); (1910) 9610. Greenville is served by the Southern and the Yazoo & Mississippi Valley railways, and by various passenger and freight steamboat lines on the Mississippi river. It is situated in the centre of the Yazoo Delta, a rich cotton-producing region, and its industries are almost exclusively connected with that staple. There are large warehouses, compresses and gins, extensive cotton-seed oil works and sawmills. Old Greenville, about 1 m. S. of the present site, was the county seat of Jefferson county until 1825 (when Fayette succeeded it), and later became the county-seat of Washington county. Much of the old town caved into the river, and during the Civil War it was burned by the Federal forces soon after the capture of Memphis. The present site was then adopted. The town of Greenville was incorporated in 1870; in 1886 it was chartered as a city.

GREENVILLE, a city and the county-seat of Darke county, Ohio, U.S.A., on Greenville Creek, 36 m. N.W. of Dayton. Pop. (1900) 5502; (1910) 6237. It is served by the Pittsburg, Cincinnati, Chicago & St. Louis and the Cincinnati Northern railways, and by interurban electric railways. It is situated about 1050 ft. above sea-level and is the trade centre of a large and fertile agricultural district, producing cereals and tobacco. It manufactures lumber, foundry products, canned goods and creamery products and has grain elevators and tobacco warehouses. In the city is a Carnegie library, and 3 m. distant there is a county Children's Home and Infirmary. The municipality owns and operates its water-works. Greenville occupies the site of an Indian village and of Fort Greenville (built by General Anthony Wayne in 1793 and burned in 1796). Here, on the 3rd of August 1795, General Wayne, the year after his victory over the Indians at Fallen Timbers, concluded with them the treaty of Greenville, the Indians agreeing to a cessation of hostilities and ceding to the United States a considerable portion of Ohio and a number of small tracts in Indiana, Illinois and Michigan (including the sites of Sandusky, Toledo, Defiance, Fort Wayne, Detroit, Mackinac, Peoria and Chicago), and the United States agreeing to pay to the Indians \$20,000 worth of goods immediately and an annuity of goods, valued at \$9500, for ever. The tribes concerned were the Wyandots, the Delawares, the Shawnees, the Ottawas, the Chippewas, the Pottawatomies, the Miamis, the Weeas, the Kickapoos, the Piankashas, the Kaskaskias and the Eel-river tribe Tecumseh lived at Greenville from 1805 to 1809, and a second Indian treaty was negotiated there in July 1814 by General W. H. Harrison and Lewis Cass, by which the Wyandots, the Delawares, the Shawnees, the (Ohio) Senecas and the Miamis agreed to aid the United States in the war with Great Britain. The first permanent white settlement of Greenville was established in 1808 and the town was laid out in the same year. It was made the county-seat of the newly erected county in 1809, was incorporated as a town in 1838 and chartered as a city in 1887.

GREENVILLE, a city and the county-seat of Greenville county, South Carolina, U.S.A., on the Reedy river, about 140 m. N.W. of Columbia, in the N.W. part of the state. Pop. (1890) 8607; (1900) 11,860, of whom 5414 were negroes; (1910, census) 15,741. It is served by the Southern, the Greenville & Knoxville and the Charleston & Western Carolina railways. It lies 976 ft. above sea-level, near the foot of the Blue Ridge Mountains, its climate and scenery attracting summer visitors. It is in an extensive cotton-growing and cotton-manufacturing district. Greenville's chief interest is in cotton, but it has various other manufactures, including carriages, wagons, iron and fertilizers. The total value of the factory products of the city in 1905 was \$1,676,774, an increase of 73.5% since 1900. The city is the seat of Furman University, Chicora College for girls (1893; Presbyterian), and Greenville Female College (1854; Baptist), which in 1907-1908 had 379 students, and which, besides the usual departments, has a conservatory of music, a school of art, a school of expression and physical culture and a kindergarten normal training school. Furman University (Baptist; opened in 1852) grew out of the "Furman Academy and Theological Institution," opened at Edgefield, S. C., in 1827, and named in honour of Richard Furman (1755-1825), a well-known Baptist clergyman of South Carolina, whose son, James C. Furman (1809-1891), was long president of the University. In 1907-1908 the university had a faculty of 15 and 250 students, of whom 101 were in the Furman Fitting School. Greenville was laid out in 1797, was originally known as Pleasantburg and was first chartered as a city in 1868.

GREENVILLE, a city and the county-seat of Hunt county, Texas, U.S.A., near the headwaters of the Sabine river, 48 m. N.E. of Dallas. Pop. (1900) 6860, of whom 114 were foreign-born and 1751 were negroes; (1910) 8850. It is served by the Missouri, Kansas & Texas, the St. Louis South-Western and the Texas Midland railways. It is an important cotton market, has gins and compresses, a large cotton seed oil refinery, and other manufactories, and is a trade centre for a rich agri-

cultural district. The city owns and operates its electric-lighting plant. It is the seat of Burleson College (Baptist), founded in 1893, and 3 m. from the city limits, in the village of Peniel (pop. 1908, about 500), a community of "Holiness" people, are the Texas Holiness University (1896), a Holiness orphan asylum and a Holiness press. Greenville was settled in 1844, and was chartered as a city in 1875. In 1907 the Texas legislature granted to the city a new charter establishing a commission government similar to that of Galveston.

GREENWICH, a township of Fairfield county, Connecticut, U.S.A., on Long Island Sound, in the extreme S.W. part of the state, about 28 m. N.E. of New York City. It contains a borough of the same name and the villages of Cos Cob, Riverside and Sound Beach, all served by the New York, New Haven & Hartford Railway; the township has steamboat and electric railway connexions with New York City. Pop. of the township (1900) 12,172, of whom 3271 were foreign-born; (1910) 16,463; of the borough (1910) 3886. Greenwich is a summer resort, principally for New Yorkers. Among the residents have been Edwin Thomas Booth, John Henry Twachtman, the landscape painter, and Henry Osborne Havemeyer (1847-1907), founder of the American Sugar Company. There are several fine churches in the township; of one in Sound Beach the Rev. William H. H. Murray (1840-1904), called "Adirondack Murray," from his *Camp Life in the Adirondack Mountains* (1868), was once pastor. In the borough are a public library, Greenwich Academy (1827; co-educational), the Brunswick School for boys (1901), with which Betts Academy of Stamford was united in 1908, and a hospital. The principal manufactures are belting, woollens, tinners' hardware, iron and gasoline motors. Oysters are shipped from Greenwich. The first settlers came from the New Haven Colony in 1640; but the Dutch, on account of the exploration of Long Island Sound by Adrian Blok in 1614, laid claim to Greenwich, and as New Haven did nothing to assist the settlers, they consented to union with New Netherland in 1642. Greenwich then became a Dutch manor. By a treaty of 1650, which fixed the boundary between New Netherland and the New Haven Colony, the Dutch relinquished their claim to Greenwich, but the inhabitants of the town refused to submit to the New Haven Colony until October 1656. Six years later Greenwich was one of the first towns of the New Haven Colony to submit to Connecticut. The township suffered severely during the War of Independence on account of the frequent quartering of American troops within its borders, the depredations of bands of lawless men after the occupation of New York by the British in 1778 and its invasion by the British in 1779 (February 25) and 1781 (December 5). There was also a strong loyalist sentiment. On the old post-road in Greenwich is the inn, built about 1720, at which Israel Putnam was surprised in February 1779 by a force under General Tryon; according to tradition he escaped by riding down a flight of steep stone steps. The inn was purchased in 1901 by the Daughters of the American Revolution, who restored it and made it a Putnam Memorial. The township government of Greenwich was instituted in the colonial period. The borough of Greenwich was incorporated in 1858.

See D. M. Mead, *History of the Town of Greenwich* (New York, 1857).

GREENWICH, a south-eastern metropolitan borough of London, England, bounded N. by the River Thames, E. by Woolwich, S. by Lewisham and W. by Deptford. Pop. (1901) 95,770. Area, 3851.7 acres. It has a river-frontage of 4½ m., the Thames making two deep bends, enclosing the Isle of Dogs on the north and a similar peninsula on the Greenwich side. Greenwich is connected with Poplar on the north shore by the Greenwich tunnel (1902), for foot-passengers, to the Isle of Dogs (Cubitt Town), and by the Blackwall Tunnel (1897) for street traffic, crossing to a point between the East and West India Docks (see POPLAR). The main thoroughfares from W. to E. are Woolwich and Shooter's Hill Roads, the second representing the old high road through Kent, the Roman Watling Street. Greenwich is first noticed in the reign of Ethelred, when it was a station of the Danish fleet (1012-1014).

The most noteworthy buildings are the hospital and the observatory. Greenwich Hospital, as it is still called, became in 1873 a Royal Naval College. Upon it or its site centre nearly all the historical associations of the place. The noble buildings, contrasting strangely with the wharves adjacent and opposite to it, make a striking picture, standing on the low river-bank with a background formed by the wooded elevation of Greenwich Park. They occupy the site of an ancient royal palace called Greenwich House, which was a favourite royal residence as early as 1300, but was granted by Henry V to Thomas Beaufort, duke of Exeter, from whom it passed to Humphrey, duke of Gloucester, who largely improved the property and named it *Placentia*. It did not revert to the crown till his death in 1447. It was the birthplace of Henry VIII., Queen Mary and Queen Elizabeth, and here Edward VI. died. The building was enlarged by Edward IV., by Henry VIII., who made it one of his chief residences, by James I. and by Charles I., who erected the "Queen's House" for Henrietta Maria. The tenure of land from the crown "as of the manor of East Greenwich" became at this time a recognized formula, and occurs in a succession of American colonial charters from those of Virginia in 1606, 1609 and 1612 to that of New Jersey in 1674. Along with other royal palaces Greenwich was at the Revolution appropriated by the Protector, but it reverted to the crown on the restoration of Charles II., by whom it was pulled down, and the west wing of the present hospital was erected as part of an extensive design which was not further carried out. In its unfinished state it was assigned by the patent of William and Mary to certain of the great officers of state, as commissioners for its conversion into a hospital for seamen; and it was opened as such in 1705. The building consists of four blocks. Behind a terrace 860 ft. in length, stretching along the river side, are the buildings erected in the time of Charles II. from Inigo Jones's designs, and in that of Queen Anne from designs by Sir Christopher Wren; and behind these buildings are on the west those of King William and on the east those of Queen Mary, both from Wren's designs. In the King William range is the painted hall. Here in 1806 the remains of Nelson lay in state before their burial in St Paul's Cathedral. Its walls and ceiling were painted by Sir James Thornhill with various emblematic devices, and it is hung with portraits of the most distinguished admirals and paintings of the chief naval battles of England. In the Queen Anne range is the Royal Naval Museum, containing models, relics of Nelson and of Franklin, and other objects. In the centre of the principal quadrangle of the hospital there is a statue of George II. by Rysbrack, sculptured out of a single block of marble taken from the French by Admiral Sir George Rooke. In the upper quadrangle is a bust of Nelson by Chantrey, and there are various other memorials and relics. The oldest part of the building was in some measure rebuilt in 1811, and the present chapel was erected to replace one destroyed by fire in 1779. The endowments of the hospital were increased at various periods from bequests and forfeited estates. Formerly 2700 retired seamen were boarded within it, and 5000 or 6000 others, called out-pensioners, received stipends at various rates out of its funds; but in 1865 an act was passed empowering the Admiralty to grant liberal pensions in lieu of food and lodging to such of the inmates as were willing to quit the hospital, and in 1869 another act was passed making their leaving on these conditions compulsory. It was then devoted to the accommodation of the students of the Royal Naval College, the Infirmary being granted to the Seamen's Hospital Society. Behind the College is the Royal Hospital School, where 1000 boys, sons of petty officers and seamen, are boarded.

To the south of the hospital is Greenwich Park (185 acres), lying high, and commanding extensive views over London, the Thames and the plain of Essex. It was enclosed by Humphrey, duke of Gloucester, and laid out by Charles II., and contains a fine avenue of Spanish chestnuts planted in his time. In it is situated the Royal Observatory, built in 1675 for the advancement of navigation and nautical astronomy. From it the exact time is conveyed each day at one o'clock by electric signal to

the chief towns throughout the country; British and the majority of foreign geographers reckon longitude from its meridian. A standard clock and measures are seen at the entrance. A new building was completed in 1899, the magnetic pavilion lying some 400 yds. to the east, so placed to avoid the disturbance of instruments which would be occasioned by the iron used in the principal building. South of the park lies the open common of Blackheath, mainly within the borough of Lewisham, and in the east the borough includes the greater part of Woolwich Common.

At Greenwich an annual banquet of cabinet ministers, known as the whitebait dinner, formerly took place. This ceremony arose out of a dinner held annually at Dagenham, on the Essex shore of the Thames, by the commissioners for engineering works carried out there in 1705-1720—a remarkable achievement for this period—to save the lowlands from flooding. To one of these dinners Pitt was invited, and was subsequently accompanied by some of his colleagues. Early in the 19th century the venue of the dinner, which had now become a ministerial function, was transferred to Greenwich, and though at first not always held here, was later celebrated regularly at the "Ship," an hotel of ancient foundation, closed in 1908. The banquet continued till 1868, was revived in 1874-1880, and was held for the last time in 1894.

The parish church of Greenwich, in Church Street, is dedicated to St Alphege, archbishop, who was martyred here by the Danes in 1012. In the church Wolfe, who died at Quebec (1759), and Tallis, the musician, are buried. A modern stained-glass window commemorates Wolfe.

The parliamentary borough of Greenwich returns one member. Two burgesses were returned in 1577, but it was not again represented till the same privilege was conferred on it in 1832. The borough council consists of a mayor, five aldermen and thirty councillors.

GREENWOOD, FREDERICK (1830-1909), English journalist and man of letters, was born in April 1830. He was one of three brothers—the others being James and Charles—who all gained reputation as journalists. Frederick started life in a printing house, but at an early age began to write in periodicals. In 1853 he contributed a sketch of Napoleon III. to a volume called *The Napoleon Dynasty* (2nd ed., 1855). He also wrote several novels: *The Loves of an Apothecary* (1854), *The Path of Roses* (1859) and (with his brother James) *Under a Cloud* (1860). To the second number of the *Cornhill Magazine* he contributed "An Essay without End," and this led to an introduction to Thackeray. In 1862, when Thackeray resigned the editorship of the *Cornhill*, Greenwood became joint editor with G. H. Lewes. In 1864 he was appointed sole editor, a post which he held until 1868. While at the *Cornhill* he wrote an article in which he suggested, to some extent, how Thackeray might have intended to conclude his unfinished work *Denis Duval*, and in its pages appeared *Margaret Demail's History*, Greenwood's most ambitious work of fiction, published in volume form in 1864. At that time Greenwood had conceived the idea of an evening newspaper, which, while containing "all the news proper to an evening journal," should, for the most part, be made up "of original articles upon the many things which engage the thoughts, or employ the energies, or amuse the leisure of mankind." Public affairs, literature and art, "and all the influences which strengthen or dissipate society" were to be discussed by men whose independence and authority were equally unquestionable. Canning's *Anti-Jacobin* and the *Saturday Review* of 1864 were the joint models Greenwood had before him. The idea was taken up by Mr George Smith, and the *Poll Mall Gazette* (so named after Thackeray's imaginary paper in *Pendennis*) was launched in February 1865, with Greenwood as editor. Within a few years he had come to exercise a great influence on public affairs. His views somewhat rapidly ripened from what was described as philosophic Liberalism into Conservatism. No minister in Great Britain, Mr Gladstone declared, ever had a more able, a more zealous, a more effective supporter for his policy than Lord Beaconsfield

had in Greenwood. It was on the suggestion of Greenwood that Beaconsfield purchased in 1875 the Suez Canal shares of the Khedive Ismail; the British government being ignorant, until informed by Greenwood, that the shares were for sale and likely to be bought by France. It was characteristic of Greenwood that he declined to publish the news of the purchase of the shares in the *Pall Mall* before the official announcement was made.

Early in 1880 the *Pall Mall* changed owners, and the new proprietor required it to support Liberal policy. Greenwood at once resigned his editorship, but in May a new paper, the *St James's Gazette*, was started for him by Mr Henry Hucks Gibbs (afterwards Lord Aldenham), and Greenwood proceeded to carry on in it the tradition which he had established in the *Pall Mall*. At the *St James's* Greenwood remained for over eight years, continuing to exercise a marked influence upon political affairs, notably as a pungent critic of the Gladstone administration (1880-1885) and an independent supporter of Lord Salisbury. His connexion with the paper ceased in August 1888, owing to disagreements with the new proprietor, Mr E. Steinkopf, who had bought the *St James's* at Greenwood's own suggestion. In January 1891 Greenwood brought out a weekly review which he named the *Anti-Jacobin*. It failed, however, to gain public support, the last number appearing in January 1892. In 1893 he published *The Lover's Lexicon* and in 1894 *Imagination in Dreams*. He continued to express his views on political and social questions in contributions to newspapers and magazines, writing frequently in the *Westminster Gazette*, the *Pall Mall*, *Blackwood*, the *Cornhill*, &c. Towards the end of his life his political views reverted in some respects to the Liberalism of his early days.

In the words of George Meredith "Greenwood was not only a great journalist, he had a statesman's head. The national interests were always urgent at his heart." He was remarkable for securing for his papers the services of the ablest writers of the day, and for the gift of recognizing merit in new writers, such, for instance, as Richard Jeffries and J. M. Barrie. His instinct for capacity in others was as sure as was his journalistic judgment. In 1905, on the occasion of his 75th birthday, a dinner was given in his honour by leading statesmen, journalists, and men of letters (with John Morley—who had succeeded him as editor of the *Pall Mall*—in the chair). In May 1907 he contributed to *Blackwood* an article on "The New Journalism," in which he drew a sharp contrast between the old and the new conditions under which the work of a newspaper writer is conducted. He died at Sydenham on the 14th of December 1909.

See *Honouring Frederick Greenwood*, being a report of the speeches at the dinner on the 8th of April 1905 (London, privately printed, 1905); "Birth and Infancy of the *Pall Mall Gazette*," an article contributed by Greenwood to the *Pall Mall* of the 14th of April 1897; "The Blowing of the Trumpet" in the introduction to the *St James's* (May 31, 1880); obituary notices in the *Athenaeum* (Dec. 25, 1909) and *The Times* (Dec. 17, 1909).

GREENWOOD, JOHN (d. 1593), English Puritan and Separatist (the date and place of his birth are unknown), entered as a sizar at Corpus Christi College, Cambridge, on the 18th of March 1577-1578, and commenced B.A. 1581. Whether he was directly influenced by the teaching of Robert Browne (q.v.), a graduate of the same college, is uncertain; in any case he held strong Puritan opinions, which ultimately led him to Separatism of the most rigid type. In 1581 he was chaplain to Lord Rich, at Rochford, Essex. At some unspecified time he had been made deacon by John Aylmer, bishop of London, and priest by Thomas Cooper, bishop of Lincoln; but ere long he renounced this ordination as "wholly unlawful." Details of the next few years are lacking; but by 1586 he was the recognized leader of the London Separatists, of whom a considerable number had been imprisoned at various times since 1567. Greenwood was arrested early in October 1586, and the following May was committed to the Fleet prison for an indefinite time, in default of bail for conformity. During his imprisonment he wrote some controversial tracts in conjunction with his fellow-prisoner Henry Barrowe (q.v.). He is understood to have been at liberty in the autumn of 1588; but this may have been merely "the

liberty of the prison." However, he was certainly at large in September 1592, when he was elected "teacher" of the Separatist church. Meanwhile he had written (1590) "An Answer to George Gifford's pretended Defence of Read Prayers." On the 5th of December he was again arrested; and the following March was tried, together with Barrowe, and condemned to death on a charge of "devising and circulating seditious books." After two respites, one at the foot of the gallows, he was hanged on the 6th of April 1593.

AUTHORITIES.—H. M. Dexter, *Congregationalism during the last three hundred years; The England and Holland of the Pilgrims*; F. J. Powicke, *Henry Barrowe and the Exiled Church of Amsterdam*; B. Brook, *Lives of the Puritans*; C. H. Cooper, *Athenae Cantabrigiae*, vol. II.

GREGG, WILLIAM RATHBONE (1809-1881), English essayist, the son of a merchant, was born at Manchester in 1809. He was educated at the university of Edinburgh and for a time managed a mill of his father's at Bury, and in 1832 began business on his own account. He entered with ardour into the struggle for free trade, and obtained in 1842 the prize offered by the Anti-Corn Law League for the best essay on "Agriculture and the Corn Laws." He was too much occupied with political, economical and theological speculations to give undivided attention to his business, which he gave up in 1850 to devote himself to writing. His *Creed of Christendom* was published in 1851, and in 1852 he contributed no less than twelve articles to four leading quarters. Disraeli praised him; Sir George Cornewall Lewis bestowed a Commissionership of Customs upon him in 1856; and in 1864 he was made Comptroller of the Stationery Office. Besides contributions to periodicals he produced several volumes of essays on political and social philosophy. The general spirit of these is indicated by the titles of two of the best known, *The Enigmas of Life* (1872) and *Rocks Ahead* (1874). They represent a reaction from the high hopes of the author's youth, when wise legislation was assumed to be a remedy for every public ill. Gregg was a man of deep moral earnestness of character and was interested in many philanthropic works. He died at Wimbledon on the 15th of November 1881. His brother, **ROBERT HYDE GREG** (1795-1875), was an economist and antiquary of some distinction. Another brother, **SAMUEL GREG** (1804-1876), became well known in Lancashire by his philanthropic efforts on behalf of the working-people. **PERCY GREG** (1836-1889), son of William Rathbone Gregg, also wrote, like his father, on politics, but his views were violently reactionary. His *History of the United States to the Reconstruction of the Union* (1887) is a polemic rather than a history.

GREGARINES (mod. Lat. *Gregarina*, from *gregarius*, collecting in a flock or herd, *grex*) a large and abundant order of Sporozoa Ectospora, in which a very high degree of morphological specialization and cytological differentiation of the cell-body is frequently found. On the other hand, the life-cycle is, in general, fairly simple. Other principal characters which distinguish Gregarines from allied Sporozoan parasites are as follows:—The fully-grown adult (trophozoite) is always "free" in some internal cavity, i.e. it is extracellular; in nearly all cases prior to sporulation two Gregarines (associates) become attached to one another, forming a couple (syzygy), and are surrounded by a common cyst; inside the cyst the body of each associate becomes segmented up into a number of sexual elements (gametes, primary sporoblasts), which then conjugate in pairs; the resulting copula (zygote, definitive sporoblast) becomes usually a spore by the secretion of spore-membranes (sporocyst), its protoplasm (sporoplasm) dividing up to form the germs (sporozoites).

F. Redi (1684) is said to have been the first to observe a Gregarine parasite, but his claim to this honour is by no means certain. Much later (1787) Cavolini described *Monocystis* and figured an indubitable Gregarine (probably the form now known as *Aggregata conformis*) from a Crustacean (*Pachygrapsus*), which, however, he regarded as a tapeworm. Leon Dufour, who in his researches on insect anatomy came across several species of these parasites, also considered them as allied to the worms and proposed the generic name of *Gregarina*.

The unicellular nature of Gregarines was first realized by A. von Kölliker, who from 1845-1848 added considerably to our knowledge of the frequent occurrence and wide distribution of these organisms. Further progress was due to F. Stein who demonstrated about this time the relation of the "pseudonavicellae" (spores) to the reproduction of the parasites.

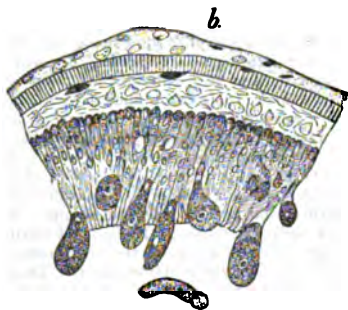
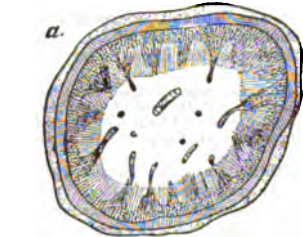

From Wasielewski's *Sporozoenkunde*, after Pfeiffer.

FIG. 1.—a, Transverse Section of Intestine of Mealworm, infected with *Gregarina (Clepsydrina) polymorpha*;¹ b, Part of a highly magnified.

of our knowledge regarding the relations of the parasites to the cells of their host during their early development.

Gregarines are essentially parasites of Invertebrates; they are not known to occur in any true Vertebrate although met with in Ascidians. By far the greatest number of hosts is furnished by the Arthropods. Many members of the various groups of worms (especially the Annelids) also harbour the parasites, and certain very interesting forms are found in Echinoderms; in the other classes, they either occur only sporadically or else are absent. Infection is invariably of the accidental (casual) type, by way of the alimentary canal, the spores being usually swallowed by the host when feeding; a novel variation of this method has been described by Woodcock (31) in the case of a Gregarine parasitic in *Cucumaria*, where the spores are sucked up through the cloaca into the respiratory trees, by the inhalant current.

The favourite habitat is either the intestine (fig. 1) or its diverticula (e.g. the Malpighian tubules), or the body-cavity.

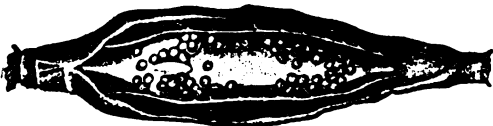

From Wasielewski, after Léger.

FIG. 2.—Cysts of a Coelomic Gregarine, in the body-cavity of a larva of *Tipula*.

In the latter case, after infection has occurred, the liberated germs at once traverse the intestinal epithelium. They may come to rest in the connective tissue of the sub-mucosa (remain-

¹ Figures 1, 2, 6, 7, 10, 11, 12 and 16 are redrawn from Wasielewski's *Sporozoenkunde*, by permission of the author and of the publisher, Gustav Fischer, Jena.

ing, however, extracellular), grow considerably in that situation, and ultimately fall into the body-cavity (e.g. *Diplocystis*); or they may pass straightway into the body-cavity and there come into relation with some organ or tissue (e.g. *Monocystis* of the earthworm, which is for a time intracellular in the spermatoblasts (fig. 4, c). In the case of intestinal Gregarines, the behaviour of the young trophozoite with respect to the epithelial cells of its host varies greatly. The parasite may remain only attached to the host-cell, never becoming actually intracellular (e.g. *Pteroccephalus*); more usually it penetrates partially into it, the extracellular portion of the Gregarine, however, giving rise subsequently to most of the adult (e.g. *Gregarina*); or lastly, in a few forms, the early development is entirely intracellular (e.g. *Lankesteria*, *Stenophora*).

The effects on the host are confined to the parasitized cells. These generally undergo at first marked hypertrophy and alteration in character; this condition is succeeded by one of atrophy, when the substance of the cell becomes in one way or another practically absorbed by the growing parasite (cf. also COCCIDIA). Since, however, the Gregarines never overrun their hosts in the way that many other Sporozoa do (because of their lack, in general, of the power of endogenous multiplication), the number of cells of any tissue attacked, even in the case of a strong infection, is only a

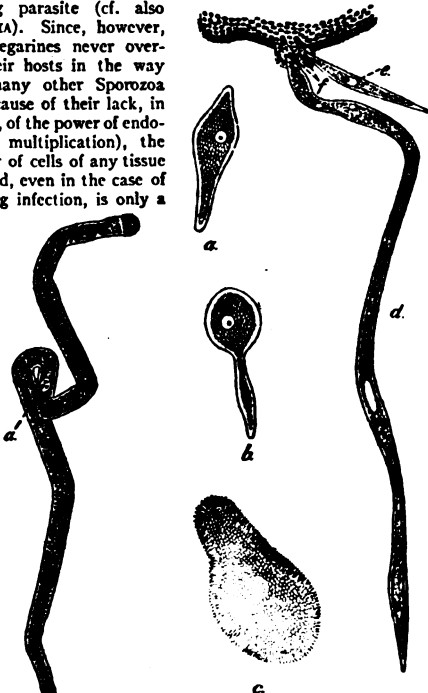

From Lankester.

FIG. 3.—*Porospora gigantea* f. (E. van Ben.), from the intestine of the lobster. a, Nucleus.

From Lankester, after various authors.

FIG. 4.

a-c, Trophozoites of *Monocystis agilis*. a and b, Young individuals showing changes of body-form. c, Older individual, still enveloped in a coat of spermatozoa. d, e, Trophozoites of *M. magna* attached to seminal funnel of *Lumbricus*. Goblet-shaped epithelial cells, in which the extremity of the parasite is inserted.

very small percentage of the whole. In short the hosts do not, as a rule, suffer any appreciable inconvenience from the presence of the parasites.

The body of a Gregarine is always of a definite shape, usually oval

or elongated; in one or two instances (e.g. *Diplodina*) it is spherical, and, on the other hand, in *Perospora* (fig. 3) it is greatly drawn out and vermiform. In many adult Gregarines, the body is divided into two distinct but unequal regions or halves, the anterior part being known as the *protomerite*, the hinder, generally the larger, as the *deutomerite*. This feature is closely associated with another important morphological character, one which is observable, however, only during the earlier stages of growth and development, namely, the presence of a definite organ, the *epimerite*, which serves for the attachment of the parasite to the host-cell (fig. 6).



After Siedlecki, from Lankester's *Treatise on Zoology*.

FIG. 5.—Part of a section through the apparatus of fixation of a *Ptercephalus*, showing root-like processes extending from the Gregarine between the epithelial cells. g, Head of Gregarine; r, Root-like processes; ep, Epithelial cells.

In those Gregarines (most intestinal forms) which become attached to an epithelial cell, the attachment occurs by means of a minute projection or beak (rostrum) at the anterior end of the sporozoite, which pushes through the cell, followed by the first part of the growing germ. This portion of the body increases in size much quicker at first than the rest (the extracellular part), more or less fills up the host-cell, and forms the well-developed epimerite or secondary attaching organella. The extracellular part of the Gregarine next grows rapidly, and a transverse septum is formed at a short distance away from (outside) the point where the body penetrates into the cell (fig. 6); this marks off the large deutomerite posteriorly (distally). Léger thinks that this partition most likely owes its origin to trophic considerations, i.e. to the slightly different manner in which the two halves of the young parasite (the proximal, largely intracellular part, and the distal, extracellular one) may be supposed to obtain their nutriment. In the case of the one half, the host-cell supplies the nutriment, in that of the other, the intestinal liquid; and the septum is, as it were, the expression of the conflicting limit between these two methods. Nevertheless, the present writer does not think that mechanical considerations should be altogether left out of account. The septum may also be, to some extent, an adaptation for strengthening the body of the fixed parasite against lateral thrusts or strains, due to the impact of foreign bodies (food, &c.) in the intestine.

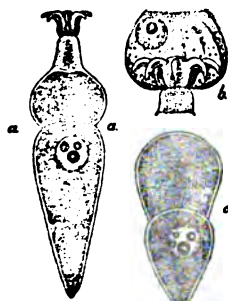

From Wasilewski, after Léger.

FIG. 6.—*Corycella armata*, Léger. a, Cephalont; b, Epimerite in host-cell; c, Sporont.

In other Gregarines, however, those, namely, which pass inwards, ultimately becoming "coelomic," as well as those which become entirely intracellular, no epimerite is ever developed, and, further, the body remains single or unseptate. These forms, which include, for instance, *Monocystis* (fig. 4), *Lankesteria*, *Diplocystis*, are distinguished, as *Acephalina* or *Aseptata* (*Haploecyta*, *Monocystida*), according to which character is referred to, from the others, termed *Cephalina* or *Septata* (*Polycystida*).

The two sets of terms are not, however, completely identical or interchangeable, for there are a few forms which possess an epimerite, but which lack the division into protomerite and deutomerite, and are hence known as *Pseudomonocystida*; this condition may be primitive (*Doliocystis*) or (possibly) secondary, the partition having in course of time disappeared. Again, *Stenophora* is a septate form

which has become, secondarily, completely intracellular during the young stages, and, doubtless correlated with this, shows no sign of an epimerite.

With regard to the epimerites themselves, they are of all variety of form and shape and need not be described in detail (fig. 7). In one or two cases, however, another variety of attaching organella is met with. Thus in *Ptercephalus*, only the rostrum of the sporozoite

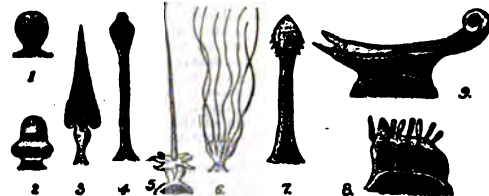

From Wasilewski, after Léger.

- FIG. 7.—Forms of Epimerites.
 1, *Gregarina longa*.
 2, *Syca inopinata*.
 3, *Pileocephalus hecchi*.
 4, *Stylorhynchus longicollis*.
 5, *Beloides firmus*.
 6, *Comeloides crinitus*.
 7, *Geneiorhynchus monnieri*.
 8, *Echinomera hispida*.
 9, *Ptercephalus nobilis*.

penetrates into the host-cell, and no epimerite is formed. Instead, a number of fine root-like processes are developed from near the anterior end, which pass in between the host-cells (fig. 5) and thus anchor the parasite firmly. Similarly, in the curious *Schiogregarinae*, the anterior end of the (unseptate) body forms a number of stiff, irregular processes, which perform the same function (fig. 8). It is to be noted that these processes are non-motile, and not in any way comparable to pseudopodia, to which they were formerly likened.

A very interesting and remarkable morphological peculiarity has been recently described by Léger (18) in the case of a new Gregarine, *Taeniocystis*. In this form the body is elongated and metamericly segmented, recalling that of a segmented worm, the adult trophozoites possessing numerous partitions or segments (each corresponding to the septum between the proto- and deutomerite in an ordinary Polycystid), which divide up the cytoplasm into roughly equal compartments. Léger thinks only the deutomerite becomes thus segmented, the protomerite remaining small and undivided. The nucleus remains single, so that there is no question as to the unicellular or individual nature of the entire animal.

The general cytoplasm usually consists of distinct ectoplasm and endoplasm, and is limited by a membrane or cuticle (epicyte), secreted by the former. The cuticle varies considerably in thickness, being well developed in active, intestinal forms, but very thin and delicate in non-motile coelomic forms (e.g. *Diplodina*). In the former case it may show longitudinal striations. The cuticle also forms the hooks or spines of many epimerites. The ectoplasm usually shows (fig. 9A) a differentiation into two layers, an outer, firmer layer, clear and hyaline, the sarcocyte, and an inner layer, the myocyte, which is formed of a network of muscle-fibrillae (mainly longitudinal and transverse, fig. 9B). The sarcocyte alone constitutes the septum, traversing the endoplasm, in septate Gregarines. The myonemes are undoubtedly the agents responsible for the active "gregarinoid" movements (of flexion and contraction) to be observed in many forms. The peculiar gliding movements were formerly thought to be produced by the extrusion of a gelatinous thread posteriorly, but Crawley (8) has recently ascribed them to a complicated succession of wave-like contractions of the myocyte layer. This view is supported by the fact that certain coelomic forms, like *Diplodina* and others, which either lack muscle-fibrils or else show no ectoplasmic differentiation at all, are non-motile. The endoplasm, or nutritive plasm, consists of a semi-fluid matrix in which are embedded vast numbers of grains and spherules of various kinds and of all sizes, representing an accumulation of food-material which is being stored up prior to reproduction. The largest and most abundant grains are of a substance termed para-glycogen, a carbohydrate; in addition, flattened

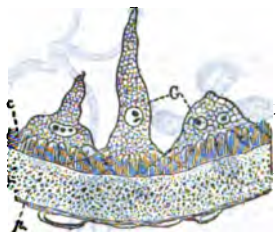

After Léger and Hagenmüller, from Lankester's *Treatise on Zoology*.

FIG. 8.—Three Individuals (G) of *Ophryocystis schneideri*, attached to wall of Malpighian tubule of *Blaps* sp. p, Syncytial protoplasm of the tubule; c, Cilia lining the lumen.

has recently ascribed them to a complicated succession of wave-like contractions of the myocyte layer. This view is supported by the fact that certain coelomic forms, like *Diplodina* and others, which either lack muscle-fibrils or else show no ectoplasmic differentiation at all, are non-motile. The endoplasm, or nutritive plasm, consists of a semi-fluid matrix in which are embedded vast numbers of grains and spherules of various kinds and of all sizes, representing an accumulation of food-material which is being stored up prior to reproduction. The largest and most abundant grains are of a substance termed para-glycogen, a carbohydrate; in addition, flattened

lenticular platelets, of an albuminoid character, and highly-refringent granules often occur.

The nucleus is always lodged in the endoplasm, and, in the septate forms, in the deutomeritic half of the body. It is normally spherical and always limited by a distinct nuclear membrane, which itself often contains chromatin. The most characteristic feature of the nucleus is the deeply-staining, more or less vacuolated spherical karyosome (consisting of chromatin intimately bound up with a plastinoid basis) which is invariably present. In one or two instances (e.g. *Diplocystis schneidersi*) the nucleus has more than one karyosome. All the chromatin of the nucleus is not, however, confined to the karyosome, some being in the form of grains in the nuclear sap; and in some cases at any rate (e.g. *Diplodina Lankesteria*) there is a well-marked

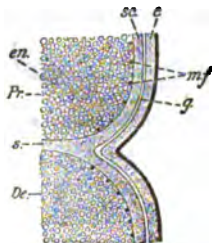

After Schewiakoff, from Lankester's *Treatise on Zoology*.

FIG. 9A.—Longitudinal section of a Gregarine in the region of the septum between protomerite and deutomerite. Pr, Protomerite. De, Deutomerite. s, Septum. em, Endoplasm. sc, Sarcocyst. c, Cuticle. mf, Myocyte fibrils (cut across). g, Gelatinous layer.



FIG. 9B.—*Gregarina wuelleri*, showing the network of myocyte fibrillae.

nuclear reticulum which is impregnated with granules and dots of chromatin.

A sexual multiplication (schizogony) is only known certainly to occur in a few cases, one being in a Monocystid form, a species of *Gonospora*, which is for a long time intracellular (Caulley and Measil [4]), the rest among the *Schizogregarinae*, so named for this reason, in which schizogony takes place regularly during the free, trophic condition. Usually, the body divides up, by a process of multiple fission (fig. 10), into a few (up to eight) daughter-individuals; but in a new genus (*Eiuleteroschizus*), Brasil (3) finds that a great number of little merozoites are formed, and a large amount of vacuolated cytoplasm is left over unused.

In the vast majority of Gregarines, however, the life-cycle is limited to gametogony and sporogony. A very general, if not indeed universal, prelude to gametogony is the characteristic and important feature of the order, known as association, the biological significance of which has only lately been fully brought out (see H. M. Woodcock [31]). In normal association, two individuals which are to be regarded as of opposite sex, come into close contact with each other and remain thus attached. The manner in which the parasites join varies in different



From Wasieleski, after A. Schneider.

FIG. 10.—Schizogony in *Ophryocystis francisci*. a, Rosette of small individuals, produced from a schizont which has just divided; b, A later stage, the daughter-individuals about to separate and assuming the characters of the adult.

forms; the association may be end-to-end (terminal), either by like or by unlike poles, or it may be side-to-side (lateral) (fig. 12). The couple (zygy) thus formed may proceed forthwith to encystment and sporoblast-formation (*Lankesteria*, *Monocystis*), or may continue in the trophic phase for some time longer (*Gregarina*). In one or two instances (*Zygocystis*), association occurs as soon as the

trophozoites become adult. This leads on to the interesting phenomenon of precocious association (neogamy), found in non-motile, coelomic Gregarines (e.g. *Cystobia*, *Diplodina* and *Diplocystis*), in which the parasitism is most advanced. Woodcock (*loc. cit.*) has described and compared the different methods adopted to ensure a permanent union, and the degree of neogamy attained, in these forms. Here it must suffice to say that, in the extreme condition (seen, for instance, in *Diplodina minchissi*) the union takes place very early in the life-history, between individuals which are little more than sporozoites, and is of a most intimate character, the actual cytoplasm

of the two associates joining. In such cases, there is absolutely nothing to indicate the "double" nature of the growing trophozoite, but the presence of the two nuclei which remain quite distinct.

There can be little doubt that, in the great majority, if not in all Gregarines, association is necessary for subsequent sporulation to take place; i.e. that the cytostatic attraction imparts a developmental stimulus to both partners, which is requisite for the formation of primary sporoblasts (gametes). This association is usually permanent; but in one or two cases (perhaps *Gonospora sp.*) temporary association may suffice. While association has fundamentally a reproductive (sexual) significance, in some cases, this union of two and three Gregarines; 4, function may be delayed Chain of five parasites; 5, or, as it were, temporarily suspended, the cytostatic attraction serving meanwhile a subsidiary purpose in trophic life. Thus, probably, are to be explained the curious multiple associations and long chains of Gregarines (fig. 11) sometimes met with (e.g. *Eirmocystis*, *Clepsydrina*).

Encystment is nearly always double, i.e. of an associated couple. Solitary encystment has been described, but whether successful independent sporulation results, is uncertain; if it does, the encystment in such cases is, in all probability, only after prior (temporary) association. In the case of free parasites, a well-developed cyst is secreted by the syzygy, which rotates and gradually becomes spherical. A thick, at first gelatinous, outer cyst-membrane (*ectocyst*) is laid down, and then a thin, but firm internal one (*endocyst*). The cyst once formed, further development is quite independent of the host, and, in fact, often proceeds outside it. In certain coelomic Gregarines, on the other hand, which remain in very close relation with the host's tissues, little or nothing of an encystment-process on the part of the parasites is recognizable, the cyst-wall being formed by an enclosing layer of the host (*Diplodina*).

The nuclear changes and multiplication which precede sporoblast-formation vary greatly in different Gregarines and can only be outlined here. In the formation of both sets of sexual elements (gametes) there is always a comprehensive nuclear purification or maturation. This elimination of a part of the nuclear material (to be distinguished as trophic or somatic, from the functional or germinal portion, which forms the sexual nuclei) may occur at widely-different periods. In some cases (*Lankesteria*, *Monocystis*), a large part of the original (sporont-) nucleus of each associate is at once got rid of, and the resulting (segmentation-) nucleus, which is highly-specialized, represents the sexual part. In other cases, again, the entire sporont-nucleus proceeds to division, and the distinction between somatic and germinal portions does not become manifest until after nuclear multiplication has continued for some little time, when certain of the daughter-nuclei become altered in character, and ultimately degenerate, the remainder giving rise to the sporoblast-nuclei (*Diplodina*, *Stylorhynchus*). Even after the actual sporoblasts (sex-cells) themselves are constituted, their nuclei may yet undergo a final maturation (e.g. *Clepsydrina ovalis*); and in *Monocystis*, indeed, Brasil (2) finds that what is apparently a similar process is delayed until after conjugation and formation of the zygote (definitive sporoblast).

Nuclear multiplication is usually indirect, the mitosis being, as a

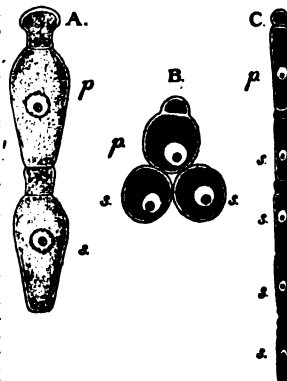

From Wasieleski, after Leger.

FIG. 11.—*Eirmocystis spp.* a, b, Association, in some cases, this union of two and three Gregarines; c, function may be delayed Chain of five parasites; 5, or, as it were, temporarily suspended, the cytostatic attraction serving meanwhile a subsidiary purpose in trophic life.



From Wasieleski, after Leger.

FIG. 12.—Associations of *Gonospora sparsa*.

rule, more elaborate in the earlier than in the later divisions. The attraction-spheres are generally large and conspicuous, sometimes consisting of a well-developed centrosphere, with or without centrosomic granules, at other times of very large centrosomes with a few astral rays. In those cases where the karyosome is retained, and the sporont-nucleus divides up as a whole, however, the earliest nuclear divisions are direct; the daughter-nuclei being formed either by a process of simple constriction (e.g. *Diplodina*), or by a kind of multiple fission or fragmentation (*Gregarina* and *Selenidium* spp.). Nevertheless, the later divisions, at any rate in *Diplodina*, are indirect.

By the time nuclear multiplication is well advanced or completed, the bodies of the two parent-Gregarines (associates) have usually become very irregular in shape, and produced into numerous lobes and processes. While in some forms (e.g. *Monocystis*, *Urospora*, *Stylorhynchus*) the two individuals remain fairly separate and independent of each other, in others (*Lankesteria*) they become intertwined and interlocked, often to a remarkable extent (*Diplodina*). The sexual nuclei next pass to the surface of the processes and segments, where they take up a position of uniform distribution. Around each, a small area of cytoplasm becomes segregated, the whole often projecting as a little bud or hillock from the general surface. These uninuclear protuberances are at length cut off as the sporoblasts or gametes. Frequently a large amount of the general protoplasm of each parent-individual is left over unused, constituting two cystal residua, which may subsequently fuse; in *Diplodina*, however, practically the whole cytoplasm is used up in the formation of the gametes.

The sporoblasts themselves show all gradations from a condition of marked differentiation into male and female (anisogamy), to one of complete equality (isogamy). Anisogamy is most highly developed in *Pteroccephalus*. Here, the male elements (microgametes) are minute, elongated and spindle-like in shape, with a minute rostrum anteriorly and a long flagellum posteriorly, and very active; the female elements (megagametes) are much larger, oblong to ovoid, and quite passive. In *Stylorhynchus* the difference between the conjugating gametes is not quite so pronounced (fig. 13), the male elements being of about the same bulk as the females, but pyriform

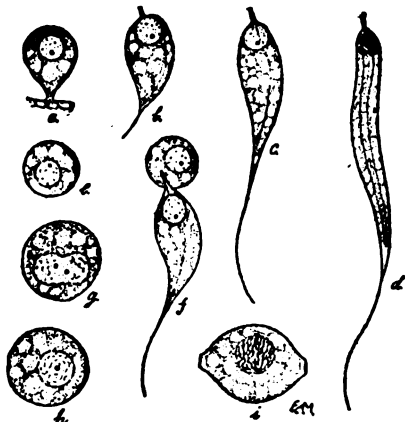

After Léger, from Lankester's *Treatise on Zoology*.

FIG. 13.—Development of the Gametes and Conjugation in *Stylorhynchus longicollis*.

- a. Undifferentiated gamet, f, g. Stages in conjugation and nuclear union of the two parent-individual.
 b, d. Stages in development of motile male gamete. h. Zygote (copula).
 c. Mature female gamete. i. Spore, still with single nucleus and undivided sporoplasm.

instead of round, and possessing a distinct flagellum; a most interesting point about this parasite is that certain highly motile and spermatozoon-like male gametes are formed (fig. 13), which are, however, quite sterile and have acquired a subsidiary function. In other cases, again, the two kinds of element exhibit either very slight differences (*Monocystis*) or none (*Urospora*, *Gonospora*), in size and appearance, the chief distinction being in the nuclei, those of the male elements being smaller and chromatically denser than those of the females.

Lastly, in *Lankesteria*, *Gregarina*, *Clepydrina*, *Diplocystis* and *Diplodina* complete isogamy is found, there being no apparent

difference whatever between the conjugating elements. Nevertheless, these forms are also to be regarded as instances of binary sexuality and not merely of exogamy; for it is practically certain that this condition of isogamy is derived from one of typical anisogamy, through a stage such as is seen in *Gonospora*, &c. And, similarly, just as in all instances where the formation of differentiated gametes has been observed, the origin of the two conjugates is from different associates (parent-sporonts), and all the elements arising from the same parent are of the same sex, so it is doubtless the case here.

The actual union is brought about or facilitated by the well-known phenomenon termed the *danse des sporoblastes*, which is due to various

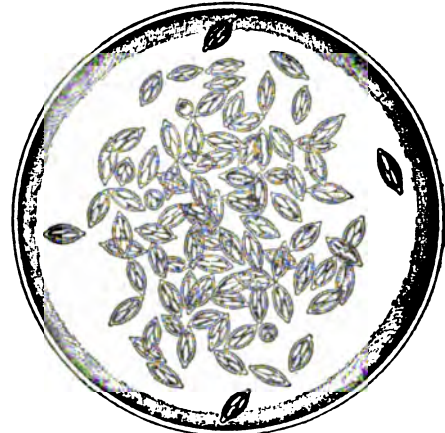

FIG. 14.—Cyst of *Monocystis agilis*, the common Gregarine of the Earthworm, showing ripe spores and absence of any residual protoplasm in the cyst. (From Lankester.)

causes. In the case of highly-differentiated gametes (*Pteroccephalus*), the actively motile microgametes rush about here and there, and seek out the female elements. In *Stylorhynchus*, Léger has shown that the function of the sterile male gametes is to bring about, by their vigorous movements, the *mille sexuelle*. In the forms where the gametes are isogamous or only slightly differentiated and (probably) not of themselves motile, other factors aid in producing the necessary commingling. Thus in *Gregarina* sp. from the mealworm, the unused somata or cystal residua become amoeboid and send out processes which drive the peripherally-situated gametes round in the cyst; in some cases where the residual soma becomes liquefied (*Urospora*) the movements of the host are considered to be sufficient; and lastly, in *Diplodina*, owing to the extent to which the intertwining process is carried, if each gamete is not actually contiguous to a suitable fellow-conjugant, a very slight movement or mutual attraction will bring two such, when liberated, into contact.

An unusual modification of the process of sporoblast-formation and conjugation, which occurs in *Ophryocystis*, must be mentioned. Here encystment of two associates takes place as usual; the sporont-nucleus of each, however, only divides twice, and one of the daughter-nuclei resulting from each division degenerates. Hence only one sporoblast-nucleus, representing a quarter of the original nuclear-material, persists in each half. Around this some of the cytoplasm condenses, the rest forming a residuum. The sporoblast or gamete thus formed is completely isogamous and normally conjugates with the like one from the other associate, when a single zygote results which becomes a spore containing eight sporozoites, in the ordinary manner. Sometimes, however, the septum between the two halves of the cyst does not break down, in which case parthenogenesis occurs, each sporoblast developing by itself into a small spore.

The two conjugating elements unite completely, cytoplasm with cytoplasm and nucleus with nucleus, to form the definitive sporoblast or zygote. The protoplasm assumes a definite outline, generally that of an ovoid or barrel, and secretes a delicate membrane, the ectospor. This subsequently becomes thickened, and often produced into rims, spines or processes, giving rise to the characteristic appearance of the Gregarine spore. Internal to the ectospor, another, thinner membrane, the endocyst, is also laid down. These two membranes form the spore-wall (sporocyst). Meanwhile the contents of the spore have been undergoing division. By successive divisions, usually mitotic, the zygote-nucleus gives rise to eight daughter-nuclei, each of which becomes the nucleus of a sporozoite. Next, the sporoplasm becomes split longitudinally, around each nucleus, and thus eight sickle-shaped (falci-form) sporozoites are formed. There is usually a

certain amount of unused sporoplasm left over in the centre of the spore, constituting the sporal residuum. It is important to note that in all known Gregarines, with one exception, the number of sporozoites in the spore is eight; the exception is *Selenidium*, in many ways far from typical, where the number is half, viz. four.

Hitherto a variation from the general mode of spore-formation has been considered to occur in certain Crustacean Gregarines, the

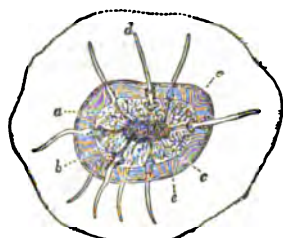

FIG. 15.—Ripe Cyst of *Gregarina blattearum*, partially emptied. (From Lankester.) a, Channels leading to the sporozoites; b, Mass of spores still left in the cyst; c, Endocyst; d, The everted sporoducts; e, Gelatinous ectocyst.

Gregarine *Porospora* (as known in the trophic condition) have really no connexion with it, but represent the schizogonous generation of some other form, similar to *Aggregata*; in which case the true spores of *Porospora* have yet to be identified.

In the intestine of a fresh host the cysts rupture and the spores are liberated. This is usually largely brought about by the swelling of the residual protoplasm. Sometimes (e.g. *Gregarina*) long tubular outgrowths, known as sporoducts (fig. 15), are developed from the residual protoplasm, for the passage of the spores to the exterior.

The Gregarines are extremely numerous, and include several families, characterized, for the most part, by the form of the spores (fig. 16). The specialized *Schizogregarinae* are usually separated off from the rest as a distinct sub-order.

Classification.
SUB-ORDER I.—*Schizogregarinae*.
Forms in which schizogony reproduction is of general occurrence during the extra-cellular, trophic phase. Three genera, *Ophryocystis*, *Schizocystis* and *Eleutheroschizon*, different peculiarities of which have been referred to above. Mostly parasitic in the intestine

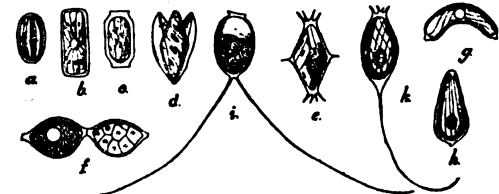

From Wasiedewski, after Léger.

FIG. 16.—Spores of various Gregarines.

a, *Eimocystis*, *Sphaerocystis*, &c. f, *Stylorhynchidae* (type of).
b, *Echinomera*, *Pteroccephalus*, &c. g, *Menosporidae*.
c, *Gregarina*, &c. h, *Gonospora teretellus*.
d, *Beloides*. i, *Ceratospira*.
e, *Ancyrophora*. k, *Urospora synaptae*.
In (this type of parasite, as exemplified by *Ophryocystis*, the body was formerly wrongly considered as amoeboid, and hence this genus was placed in a special order, the *Amoebosporidae*.)

SUB-ORDER II.—Eugregarinae.
Schizogony very exceptional, only occurring during the intracellular phase, if at all. Gregarines fall naturally into two tribes, described as cephalont and septate, or as acephalont and aseptate (haplocytic), respectively. In strictness, however, as already mentioned, these two sets of terms do not agree absolutely, and whichever set is adopted, the other must be taken into account in estimating the proper position of certain parasites. Here the cephalont or acephalont condition is regarded as the more primary and fundamental.

Tribe A.—*Cephalinae* (practically equivalent to *Septata*).
Save exceptionally, the body possesses an epimerite, at any rate during the early stages of growth, and is typically septate. Mostly intestinal parasites of Arthropods.

The chief families, with representative genera, are as follows: *Porosporidae*, with *Porospora gigantea*, at present thought to be gymnosporous; *Gregarinidae* (*Clepyridinidae*), with *Gregarina*, *Clepydrina*, *Esmocystis*, *Hyalospora*, *Cmesidospira*, *Stenophora*; *Didymophyidae*, with *Didymophyes*; *Dactylophoridae*, with *Dactylophorus*, *Pteroccephalus*, *Echinomera*, *Rhopalonia*; *Acinoccephalidae* with *Acinoccephalus*, *Pyxinia*, *Colerhynchus*, *Stephanophora*, *Legeria*; *Stictosporidae*, with *Stictospora*, *Pleoccephalus*, *Sciadophora*; *Acanthosporidae* with *Acanthospora*, *Corycella*, *Comeloides*; *Menosporidae* with *Menospora*, *Hoplorynchus*; *Stylorhynchidae*, with *Stylorhynchus*, *Lophoccephalus*; *Dolioscystidae* with *Dolioscystis*; and *Taenioctystidae*, with *Taenioctystis*. The curious genus *Selenidium* is somewhat apart.

Tribe B.—*Acephalinae* (practically equivalent to *Aseptata*, *Haplocyta*).
The body never possesses an epimerite and is non-septate. Chiefly coelomic parasites of "worms," Holothurians and insects.

The *Aseptata* have not been so completely arranged in families as the *Septata*. Léger has distinguished two well-marked ones, but the remaining genera still want classifying more in detail. Fam. *Gonosporidae*, with *Gonospora*, *Diplodina*; and *Urosporidae*, with *Urospora*, *Cystobia*, *Lithocystis*, *Ceratospira*; the genera *Monocystis*, *Diplocystis* *Lankesteria* and *Zygocystis* probably constitute another; *Pterospora* and, again, *Synocystis* are distinct; lastly, certain forms, e.g. *Zygosoma*, *Anchora* (*Anchorina*), are incompletely known.

There remains for mention the remarkable parasite, recently described by J. Nusbbaum (24) under the appropriate name of *Schausinnella henleae*, which inhabits the intestine of *Hemiteles leptocera*. Briefly enumerated, the principal features in the life-cycle are as follows. The young trophozoites (aseptate) are attached to the intestinal cells, but practically entirely extracellular. Association is very primitive in character and indiscriminate; it takes place indifferently between individuals which will give rise to gametes of the same or opposite sex. Often it is only temporary; at other times it is multiple, several adults becoming more or less enclosed in a gelatinous investment. Nevertheless, in no case does true encystment occur, the sex-cells being developed practically free. The female gametes are large and egg-like; the males, minute and sickle-like, but with no flagellum and apparently non-motile. While many of the zygotes ("amphions") resulting from copulation pass out to the exterior, to infect a new host, others, possessing a more delicate investing-membrane, penetrate in between the intestinal cells, producing a further infection (auto-infection). Numerous sporozoites are formed in each zygote. It will be seen that *Schausinnella* is a practically unique form. While, on the one hand, it recalls the Gregarines in many ways, on the other hand it differs widely from them in several characteristic features, being primitive in some respects, but highly specialized in others, so that it cannot be properly included in the order. *Schausinnella* rather represents a primitive Ectosporan parasite, which has proceeded upon a line of its own, intermediate between the Gregarines and Coecidia.

BIBLIOGRAPHY.—Among the important papers relating to Gregarines are the following: 1. A. Berndt, "Beitrag zur Kenntnis der . . . Gregarinen," *Arch. Protistenk.* 1, p. 375, 3 pls. (1902); 2. L. Brasil, "Recherches sur la reproduction des Gregarines monocystidées," *Arch. zool. exp.* (4) 3, p. 17, pl. 2 (1905), and *op. cit.* 4, p. 69, 2 pls. (1905); 3. L. Brasil, "*Eleutheroschizon duboscqi*, parasite nouveau, &c.," *op. cit.* (N. et R.) (4), p. xvii, 5 figs. (1906); 4. M. Caullery and F. Mesnil, "Sur une Grégarine . . . présentant . . . une phase de multiplication asporulée," *C.R. Ac. Sci.* 126, p. 262 (1898); 5. M. Caullery and F. Mesnil, "Le Parasitisme intracellulaire des Grégarines," *op. cit.* 132, p. 220 (1901); 6. M. Caullery and F. Mesnil, "Sur une mode particulière de division nucléaire chez les Grégarines," *Arch. anat. microsc.* 3, p. 146, 1 pl. (1900); 7. M. Caullery and F. Mesnil, "Sur quelques parasites internes des Annélides," *Misc. biol. (Trav. Stat. Wimmerus)*, 9, p. 80, 1 pl. (1899); 7a. J. Ceconi, "Sur l'*Anchorina sagittata*, &c.," *Arch. Protistenk.* 6, p. 230, 2 pls. (1905); 8. H. Crawley, "Progressive Movement of Gregarines," *P. Ac. Philad.* 54, p. 4, 2 pls. (1902), also *op. cit.* 57, p. 80 (1905); 9. H. Crawley, "List of the Polycystid Gregarines of the U.S.," *op. cit.* 55, pp. 41, 63, 4 pls. (1903); 10. L. Cuenot, "Recherches sur l'évolution et la conjugaison des Grégarines," *Arch. biol.* 17, p. 581, 4 pls. (1901); 11. A. Laveran and F. Mesnil, "Sur quelques particularités de l'évolution d'une Grégarine et la réaction de la cellule-hôte," *C.R. Soc. Biol.* 52, p. 554, 9 figs. (1900); 12. L. Léger, "Recherches sur les Grégarines," *Trib. zool.* 3, p. i., 22 pls. (1892); 13. L. Léger, "Contribution à la connaissance des Sporozoaires, &c.," *Bull. Sci. France*, 30, p. 240, 3 pls. (1897); 14. L. Léger, "Sur un nouveau Sporozoaire (*Schizocystis*), &c.," *C.R. Ac. Sci.* 131, p. 722 (1900); 15. L. Léger, "La Reproduction sexuée chez les Ophryocystis," *l. c.* p. 761 (1900); 16. L. Léger, "Sur une nouvelle Grégarine (*Aggregata caelomica*), &c.," *op. cit.* 132, p. 1343 (1901); 17. L. Léger, "La Reproduction sexuée chez les Stylorhynchus," *Arch. Protistenk.* 3, p. 304, 2 pls. (1904); 18. L. Léger, "Étude sur *Taenioctystis mira* (Léger), &c.," *op. cit.* 7, p. 307, 2 pls. (1906); 19. L. Léger and O. Duboscq, "La Reproduction sexuée chez *Pteroccephalus*," *Arch. zool. exp.* (N. et R.) (4) 1, p. 141, 11 figs. (1903); 20. L. Léger and O. Duboscq, "*Aggregata vagans*, n. sp., &c.," *l. c.* p. 147, 6 figs. (1903); 21. L. Léger and O. Duboscq, "Les Grégarines et l'épithélium intestinal, &c.," *Arch. parasitol.* 6, p. 377, 4 pls. (1908); 22. L. Léger and O. Duboscq, "Nouvelles Recherches sur

les Grégarines, &c." *Arch. Protistenk.* 4, p. 333, 2 pls. (1904); 23. M. Lübe, "Bau und Entwicklung der Gregarinen." *J. c.* p. 88, several figs. (1904); 24. J. Nusbbaum, "Über die . . . Fortpflanzung einer . . . Gregarine, *Schaudinella henleae*." *Zeit. wiss. Zool.* 75, p. 281, pl. 22 (1903); 25. F. Paehler, "Über die Morphologie, Fortpflanzung . . . von *Gregarina ovata*." *Arch. Protistenk.* 4, p. 64, 2 pls. (1904); 26. S. Prosznauk, "Zur Entwicklung der Gregarinen." *op. cit.*, 1, p. 297, pl. 9 (1902); 27. A. Schneider (Various memoirs on Gregarines), *Tabl.ool.* 1 and 2 (1886-1892); 28. H. Schnitzler, "Über die Fortpflanzung von *Clepsydrina ovata*." *Arch. Protistenk.* 6, p. 309, 2 pls. (1905); 29. M. Siedlecki, "Über die geschlechtliche Vermehrung der *Monocystis ascidiae*." *Bull. Ac. Cracovie*, p. 515, 2 pls. (1900); 30. M. Siedlecki, "Contribution à l'étude des changements cellulaires provoqués par les Grégarines." *Arch. anat. microsc.* 4, p. 87, 9 figs. (1901); 31. H. M. Woukuck, "The Life-Cycle of *Cystobia irregularis*, &c." *Q.J.M. Sci.* 50, p. 1, 6 pls. (1906). (H. M. Wo.)

GRÉGOIRE, HENRI (1750-1831), French revolutionist and constitutional bishop of Blois, was born at Vého near Lunéville, on the 4th of December 1750, the son of a peasant. Educated at the Jesuit college at Nancy, he became curé of Embermenil and a teacher at the Jesuit school at Pont-à-Mousson. In 1783 he was crowned by the academy of Nancy for his *Eloge de la poésie*, and in 1788 by that of Metz for an *Essai sur la régénération physique et morale des Juifs*. He was elected in 1789 by the clergy of the bailliage of Nancy to the states-general, where he soon became conspicuous in the group of clerical and lay deputies of Jansenist or Gallican sympathies who supported the Revolution. He was among the first of the clergy to join the third estate, and contributed largely to the union of the three orders; he presided at the permanent sitting of sixty-two hours while the Bastille was being attacked by the people, and made a vehement speech against the enemies of the nation. He subsequently took a leading share in the abolition of the privileges of the nobles and the Church. Under the new civil constitution of the clergy, to which he was the first priest to take the oath (December 27, 1790), he was elected bishop by two departments. He selected that of Loire-et-Cher, taking the old title of bishop of Blois, and for ten years (1791-1801) ruled his diocese with exemplary zeal. An ardent republican, it was he who in the first session of the National Convention (September 27, 1792) proposed the motion for the abolition of the kingship, in a speech in which occurred the memorable phrase that "kings are in the moral order what monsters are in the natural." On the 15th of November he delivered a speech in which he demanded that the king should be brought to trial, and immediately afterwards was elected president of the Convention, over which he presided in his episcopal dress. During the trial of Louis XVI., being absent with other three colleagues on a mission for the union of Savoy to France, he along with them wrote a letter urging the condemnation of the king, but omitting the words *à mort*; and he endeavoured to save the life of the king by proposing in the Convention that the penalty of death should be suspended.

When on the 7th of November 1793 Gobel, bishop of Paris, was intimidated into resigning his episcopal office at the bar of the Convention, Grégoire, who was temporarily absent from the sitting, hearing what had happened, hurried to the hall, and in the face of a howling mob of deputies refused to abjure either his religion or his office. He was prepared to face the death which he expected; but his courage, a rare quality at that time, won the day, and the hubbub subsided in cries of "Let Grégoire have his way!" Throughout the Terror, in spite of attacks in the Convention, in the press, and on placards posted at the street corners, he appeared in the streets in his episcopal dress and daily read mass in his house. After Robespierre's fall he was the first to advocate the reopening of the churches (speech of December 21, 1794). He also exerted himself to get measures put in execution for restraining the vandalistic fury against the monuments of art, extended his protection to artists and men of letters, and devoted much of his attention to the reorganization of the public libraries, the establishment of botanic gardens, and the improvement of technical education. He had taken during the Constituent Assembly a great interest in Negro emancipation, and it was on his motion that men of colour in the French colonies were admitted to the same rights as whites.

On the establishment of the new constitution, Grégoire was elected to the Council of 500, and after the 18th Brumaire he became a member of the Corps Législatif, then of the Senate (1801). He took the lead in the national church councils of 1797 and 1801; but he was strenuously opposed to Napoleon's policy of reconciliation with the Holy See, and after the signature of the concordat he resigned his bishopric (October 8, 1801). He was one of the minority of five in the Senate who voted against the proclamation of the empire, and he opposed the creation of the new nobility and the divorce of Napoleon from Josephine; but notwithstanding this he was subsequently created a count of the empire and officer of the Legion of Honour. During the later years of Napoleon's reign he travelled in England and Germany, but in 1814 he had returned to France and was one of the chief instigators of the action that was taken against the empire.

To the clerical and ultra-royalist faction which was supreme in the Lower Chamber and in the circles of the court after the second Restoration, Grégoire, as a revolutionist and a schismatic bishop, was an object of double loathing. He was expelled from the Institute and forced into retirement. But even in this period of headlong reaction his influence was felt and feared. In 1814 he had published a work, *De la constitution française de l'an 1814*, in which he commented on the Charter from a Liberal point of view, and this reached its fourth edition in 1819. In this latter year he was elected to the Lower Chamber by the department of Isère. By the powers of the Quadruple Alliance this event was regarded as of the most sinister omen, and the question was even raised of a fresh armed intervention in France under the terms of the secret treaty of Aix-la-Chapelle. To prevent such a catastrophe Louis XVIII. decided on a modification of the franchise; the Dessolle ministry resigned; and the first act of Decazes, the new premier, was to carry a vote in the chamber annulling the election of Grégoire. From this time onward the ex-bishop lived in retirement, occupying himself in literary pursuits and in correspondence with most of the eminent savants of Europe; but as he had been deprived of his pension as a senator he was compelled to sell his library to obtain means of support. He died on the 20th of May 1831.

To the last Grégoire remained a devout Catholic, exactly fulfilling all his obligations as a Christian and a priest; but he refused to budge an inch from his revolutionary principles. During his last illness he confessed to his parish curé, a priest of Jansenist sympathies, and expressed his desire for the last sacraments of the Church. These the archbishop of Paris would only concede on condition that he would retract his oath to the civil constitution of the clergy, which he peremptorily refused to do. Thereupon, in defiance of the archbishop, the abbé Baradère gave him the *viaticum*, while the rite of extreme unction was administered by the abbé Guillon, an opponent of the civil constitution, without consulting the archbishop or the parish curé. The attitude of the archbishop roused great excitement in Paris, and the government had to take precautions to avoid a repetition of the riots which in the preceding February had led to the sacking of the church of St Germain l'Auxerrois and the archiepiscopal palace. On the day after his death Grégoire's funeral was celebrated at the church of the Abbaye-aux-Bois; the clergy of the church had absented themselves in obedience to the archbishop's orders, but mass was sung by the abbé Grieu assisted by two clergy, the catafalque being decorated with the episcopal insignia. After the hearse set out from the church the horses were unyoked, and it was dragged by students to the cemetery of Montparnasse, the cortege being followed by a sympathetic crowd of some 20,000 people.

Whatever his merits as a writer or as a philanthropist, Grégoire's name lives in history mainly by reason of his whole-hearted effort to prove that Catholic Christianity is not irreconcilable with modern conceptions of political liberty. In this effort he was defeated, mainly because the Revolution, for lack of experience in the right use of liberty, changed into a military despotism which allied itself with the spiritual despotism of Rome; partly because, when the Revolution was overthrown,

the parties of reaction sought salvation in the "union of altar and throne." Possibly Grégoire's Gallicanism was fundamentally irreconcilable with the Catholic idea of authority. At least it made their traditional religion possible for those many French Catholics who clung passionately to the benefits the Revolution had brought them; and had it prevailed, it might have spared France and the world that fatal gulf between Liberalism and Catholicism which Pius IX.'s Syllabus of 1864 sought to make impassable.

Besides several political pamphlets, Grégoire was the author of *Histoire des sociétés religieuses, depuis le commencement du siècle dernier jusqu'à l'époque actuelle* (2 vols., 1810); *Essai historique sur les libertés de l'église gallicane* (1818); *De l'influence du Christianisme sur la condition des femmes* (1821); *Histoire des confesseurs des empereurs, des rois, et d'autres princes* (1824); *Histoire du mariage des prêtres en France* (1826). *Grégoireana, ou résumé général de la conduite, des actions, et des écrits de M. le comte Henri Grégoire*, preceded by a biographical notice by Cousin d'Avalon, was published in 1821; and the *Mémoires . . . de Grégoire*, with a biographical notice by H. Carnot, appeared in 1837 (2 vols.). See also A. Debidour, *L'Abbé Grégoire* (1881); A. Gazier, *Études sur l'histoire religieuse de la Révolution Française* (1883); L. Maggiolo, *La Vie et les œuvres de l'abbé Grégoire* (Nancy, 1884), and numerous articles in *La Révolution Française*; E. Meaume, *Étude hist. et biog. sur les Lorrains révolutionnaires* (Nancy, 1882); and A. Gazier, *Études sur l'histoire religieuse de la Révolution Française* (1887).

GREGORAS, NICEPHORUS (c. 1295-1360), Byzantine historian, man of learning and religious controversialist, was born at Heraclea in Pontus. At an early age he settled at Constantinople, where his reputation for learning brought him under the notice of Andronicus II., by whom he was appointed Chartophylax (keeper of the archives). In 1326 Gregoras proposed (in a still extant treatise) certain reforms in the calendar, which the emperor refused to carry out for fear of disturbances; nearly two hundred years later they were introduced by Gregory XIII. on almost the same lines. When Andronicus was de-throned (1328) by his grandson Andronicus III., Gregoras shared his downfall and retired into private life. Attacked by Barlaam, the famous monk of Calabria, he was with difficulty persuaded to come forward and meet him in a war of words, in which Barlaam was worsted. This greatly enhanced his reputation and brought him a large number of pupils. Gregoras remained loyal to the elder Andronicus to the last, but after his death he succeeded in gaining the favour of his grandson, by whom he was appointed to conduct the unsuccessful negotiations (for a union of the Greek and Latin churches) with the ambassadors of Pope John XXII. (1353). Gregoras subsequently took an important part in the Hesychast controversy, in which he violently opposed Gregorius Palamas, the chief supporter of the sect. After the doctrines of Palamas had been recognized at the synod of 1351, Gregoras, who refused to acquiesce, was practically imprisoned in a monastery for two years. Nothing is known of the end of his life. His chief work is his *Roman History*, in 37 books, of the years 1204 to 1359. It thus partly supplements and partly continues the work of George Pachymeres. Gregoras shows considerable industry, but his style is pompous and affected. Far too much space is devoted to religious matters and dogmatic quarrels. This work and that of John Cantacuzene supplement and correct each other, and should be read together. The other writings of Gregoras, which (with a few exceptions) still remain unpublished, attest his great versatility. Amongst them may be mentioned a history of the dispute with Palamas; biographies of his uncle and early instructor John, metropolitan of Heraclea, and of the martyr Codratus of Antioch; funeral orations for Theodore Metochita, and the two emperors Andronicus; commentaries on the wanderings of Odysseus and on Synesius's treatise on dreams; tracts on orthography and on words of doubtful meaning; a philosophical dialogue called *Florentinus or Concerning Wisdom*; astronomical treatises on the date of Easter and the preparation of the astrolabe; and an extensive correspondence.

Editions: in Bonn *Corpus scriptorum hist. Byz.*, by L. Schopen and J. Bekker, with life and list of works by J. Boivin (1829-1855); J. P. Migne, *Patrologia graeca*, cxlviii., cxlix.; see also C. Krumbacher, *Geschichte der byzantinischen Litteratur* (1897).

GREGOROVIVS, FERDINAND (1821-1891), German historian, was born at Neidenburg on the 10th of January 1821, and studied at the university of Königsberg. After spending some years in teaching he took up his residence in Italy in 1852, remaining in that country for over twenty years. He was made a citizen of Rome, and he died at Munich on the 21st of May 1891. Gregorovius's interest in and acquaintance with Italy and Italian history is mainly responsible for his great book, *Geschichte der Stadt Rom im Mittelalter* (Stuttgart, 1859-1872, and other editions), a work of much erudition and interest, which has been translated into English by A. Hamilton (13 vols., 1894-1900), and also into Italian at the expense of the Romans (Venice, 1874-1876). It deals with the history of Rome from about A.D. 400 to the death of Pope Clement VII. in 1534, and in the words of its author it describes "how, from the time of Charles the Great to that of Charles V., the historic system of the papacy remained inseparable from that of the Empire." The other works of Gregorovius include: *Geschichte des Kaisers Hadrian und seiner Zeit* (Königsberg, 1851), English translation by M. E. Robinson (1898); *Corsica* (Stuttgart, 1854), English translation by R. Martineau (1855); *Lucrcia Borgia* (Stuttgart, 1874), English translation by J. L. Garner (1902); *Die Grabdenkmäler der Päpste* (Leipzig, 1881), English translation by R. W. Seton-Watson (1903); *Wanderjahre in Italien* (5 vols., Leipzig, 1888-1892); *Geschichte der Stadt Athen im Mittelalter* (1889); *Kleine Schriften zur Geschichte der Kultur* (Leipzig, 1887-1892); and *Urban VIII. im Widerspruch zu Spanien und dem Kaiser* (Stuttgart, 1879). This last work was translated into Italian by the author himself (Rome, 1879). Gregorovius was also something of a poet; he wrote a drama, *Der Tod des Tiberius* (1851), and some *Gedichte* (Leipzig, 1891).

His *Römische Tagebücher* were edited by F. Althaus (Stuttgart, 1892), and were translated into English as the *Roman Journals of F. Gregorovius*, by A. Hamilton (1907).

GREGORY, ST (c. 213-c. 270), surnamed in later ecclesiastical tradition Thaumaturgus (the miracle-worker), was born of noble and wealthy pagan parents at Neocaesarea in Pontus, about A.D. 213. His original name was Theodorus. He took up the study of civil law, and, with his brother Athenodorus, was on his way to Berytus to complete his training when at Caesarea he met Origen, and became his pupil and then his convert (A.D. 233). In returning to Cappadocia some five years after his conversion, it had been his original intention to live a retired ascetic life (Eus. *H.E.* vi. 30), but, urged by Origen, and at last almost compelled by Phaedimus of Amasia, his metropolitan, neither of whom was willing to see so much learning, piety and masculine energy practically lost to the church, he, after many attempts to evade the dignity, was consecrated bishop of his native town (about 240). His episcopate, which lasted some thirty years, was characterized by great missionary zeal, and by so much success that, according to the (doubtless somewhat rhetorical) statement of Gregory of Nyssa, whereas at the outset of his labours there were only seventeen Christians in the city, there were at his death only seventeen persons in all who had not embraced Christianity. This result he achieved in spite of the Decian persecution (250-251), during which he had felt it to be his duty to absent himself from his diocese, and notwithstanding the demoralizing effects of an irruption of barbarians (Goths and Boranians) who laid waste the diocese in A.D. 253-254. Gregory, although he has not always escaped the charge of Sabellianism, now holds an undisputed place among the fathers of the church; and although the turn of his mind was practical rather than speculative, he is known to have taken an energetic part in most of the doctrinal controversies of his time. He was active at the first synod of Antioch (A.D. 264-265), which investigated and condemned the heresies of Paul of Samosata; and the rapid spread in Pontus of a Trinitarianism approaching the Nicene type is attributed in large measure to the weight of his influence. Gregory is believed to have died in the reign of Aurelian, about the year 270, though perhaps an earlier date is more probable. His festival (semiduplex) is observed by the Roman Catholic Church on the 17th of November.

For the facts of his biography we have an outline of his early years in his eulogy on Origen, and incidental notices in the writings of Eusebius, of Basil of Caesarea and Jerome. Gregory of Nyssa's untrustworthy panegyric represents him as having wrought miracles of a very startling description; but nothing related by him comes near the astounding narratives given in the *Martyrologies*, or even in the *Breviarium Romanum*, in connexion with his name.

The principal works of Gregory Thaumaturgus are the *Panegyricus in Origenem* (Ἐπιθῆσις πανηγυρικός Ὀρίγου), which he wrote when on the point of leaving the school of that great master (it contains a valuable minute description of Origen's mode of instruction), a *Metaphrasis in Ecclesiasten*, characterized by Jerome as "short but useful"; and an *Epistola canonica*, which treats of the discipline to be undergone by those Christians who under pressure of persecution had relapsed into paganism, but desired to be restored to the privileges of the Church. It gives a good picture of the conditions of the time, and shows Gregory to be a true shepherd (cf. art. PENANCE). The *Edoicus sermo* (*Expositio fidei*), a short creed usually attributed to Gregory, and traditionally alleged to have been received by him immediately in vision from the apostle John himself, is probably authentic. A sort of Platonic dialogue of doubtful authenticity "on the impassivity and the passivity of God" in Syriac is in the British Museum.

Editions: Gerhard Voss (Mainz, 1604), Fronto Ducius (Paris, 1622), Migne, *Patr. Graec.* x. 963.

Translations: S. D. F. Salmond in *Anti-Nicene Fathers*, vi. 1. *Lives*, by Pallavicini (Rome, 1644); J. L. Boye (Jena, 1709); H. R. Reynolds (*Dicit. Chr. Biog.* ii.); G. Krüger, *Early Chr. Lit.* 226; Herzog-Hauck, *Realencyk.* vii. (where full bibliographies are given).

GREGORY, ST. OF NAZIANZUS (329-389), surnamed Theologus, one of the four great fathers of the Eastern Church, was born about the year A.D. 329, at or near Nazianzus, Cappadocia. His father, also named Gregory, had lately become bishop of the diocese; his mother, Nonna, exercised a powerful influence over the religious convictions of both father and son. Gregory visited successively the two Caesareas, Alexandria and Athens, as a student of grammar, mathematics, rhetoric and philosophy; at Athens he had for fellow-students Basil (q.v.), who afterwards became bishop of Caesarea, and Julian, afterwards emperor. Shortly after his return to his father's house at Nazianzus (about the year 360) Gregory received baptism. He resolved to give himself to the service of religion; but for some time, and indeed more or less throughout his whole life, was in a state of hesitation as to the form which that service ought to take. Strongly inclined by nature and education to a contemplative life spent among books and in the society of congenial friends, he was continually urged by outward circumstances, as well as by an inward call, to active pastoral labour. The spirit of refined intellectual monasticism, which clung to him through life and never ceased to struggle for the ascendancy, was about this time strongly encouraged by his intercourse with Basil, who induced him to share the exalted pleasures of his retirement in Pontus. To this period belongs the preparation of the *Φυλακάλια*, a sort of chrestomathy compiled by the two friends from the writings of Origen. But the events which were stirring the political and ecclesiastical life of Cappadocia, and indeed of the whole Roman world, made a career of learned leisure difficult if not impossible to a man of Gregory's position and temperament. The emperor Constantius, having by intrigue and intimidation succeeded in thrusting a semi-Arian formula upon the Western bishops assembled at Ariminum in Italy, had next attempted to follow the same course with the Eastern episcopate. The aged bishop of Nazianzus having yielded to the imperial threats, a great storm arose among the monks of the diocese, which was only quelled by the influence of the younger Gregory, who shortly afterwards (about 361) was ordained to the priesthood. After a vain attempt to evade his new duties and responsibilities by flight, he appears to have continued to act as a presbyter in his father's diocese without interruption for some considerable time; and it is probable that his two *Insectives* against Julian are to be assigned to this period. Subsequently (about 372), under a pressure which he somewhat resented, he allowed himself to be nominated by Basil as bishop of Sasima, a miserable little village some 32 m. from Tyanas; but he seems hardly, if at all, to have assumed the duties of this diocese, for after another interval of "flight" we find him once

more (about 372-373) at Nazianzus, assisting his aged father, on whose death (374) he retired to Seleucia in Isauria for a period of some years. Meanwhile a more important field for his activities was opening up. Towards 378-379 the small and depressed remnant of the orthodox party in Constantinople sent him an urgent summons to undertake the task of resuscitating their cause, so long persecuted and borne down by the Arians of the capital. With the accession of Theodosius to the imperial throne, the prospect of success to the Nicene doctrine had dawned, if only it could find some courageous and devoted champion. The fame of Gregory as a learned and eloquent disciple of Origen, and still more of Athanasius, pointed him out as such a defender; nor could he resist the appeal made to him, although he took the step reluctantly. Once arrived in Constantinople, he laboured so zealously and well that the orthodox party speedily gathered strength; and the small apartment in which they had been accustomed to meet was soon exchanged for a vast and celebrated church which received the significant name of Anastasia, the Church of the Resurrection. Among the hearers of Gregory were to be found, not only churchmen like Jerome and Evagrius, but also heretics and pagans; and it says much for the sound wisdom and practical tact of the preacher that he set himself to build up and defend a doctrinal position than to urge his flock to the cultivation of the loving Christian spirit which cherishes higher aims than mere heresy hunting or endless disputation. Doctrinal, nevertheless, he was, as is abundantly shown by the famous five discourses on the Trinity, which earned for him the distinctive appellation of *θεολόγος*. These orations are the finest exposition of the Catholic doctrine of the Trinity as conceived by the orthodox teachers of the East, and they were directed especially against the Eunomians and Macedonians. "There is perhaps no single book in Greek patristic literature to which the student who desires to gain an exact and comprehensive view of Greek theology can be more confidently referred." With the arrival of Theodosius in 380 came the visible triumph of the orthodox cause; the metropolitan see was then conferred upon Gregory, and after the assembling of the second ecumenical council in 381 he received consecration from Meletius. In consequence, however, of a spirit of discord and envy which had manifested itself in connexion with this promotion, he soon afterwards resigned his dignity and withdrew into comparative retirement. The rest of his days were spent partly at Nazianzus in ecclesiastical affairs, and partly on his neighbouring patrimonial estate at Arianus, where he followed his favourite literary pursuits, especially poetical composition, until his death, which occurred in 389 or 390. His festival is celebrated in the Eastern Church on the 25th and 30th of January, in the Western on the 9th of May (duplex).

His extant works consist of poems, epistles and orations. The poems, which include epigrams, elegies and an autobiographical sketch, have been frequently printed, the *editio princeps* being the Aldine (1504). Other editions are those of Tollius (1696) and Muratori (1709); a volume of *Carmina selecta* also has been edited by Dronke (1840). The tragedy entitled *Χριστός πάσχω* usually included is certainly not genuine. Gregory's poetry did not absorb his best energies; it was adopted in his later years as a recreation rather than as a serious pursuit; thus it is occasionally delicate, graphic, beautiful, but it is not sustained. Of the hymns none have passed into ecclesiastical use. The letters are entitled to a higher place in literature. They are always easy and natural; and there is nothing forced in the manner in which their acute, witty and profound sayings are introduced. Those to Basil introduce us to the story of a most romantic friendship, though to Cledonius have theological value for their bearing on the Apollinarian controversy. As an orator he was so facile, vigorous and persuasive, that men forgot his small stature and emaciated countenance. Forty-five orations are extant. Gregory was less an independent theologian than an interpreter. He was influenced by Athanasius in his Christology, by Origen in his anthropology, for, though teaching original sin and deriving human mortality from the Fall, he insists on the ability of the human will to choose the good and to co-operate in the work of salvation with the will of God. Though possessed neither of Basil's gift of government nor of Gregory of Nyssa's power of speculative thought, he worthily takes a place in that triumvirate of Cappadocians whom the Catholic Church gratefully recognises as having been, during the critical struggles in the latter half of the 4th century, the best defenders of its faith. The *Opera omnia* were

first published by Hervagius (Basel, 1550); the subsequent editions have been those of Billius (Paris, 1609, 1611; aucta ex interpretatione Morelli, 1630), of the Benedictines (begun in 1778, but interrupted by the French Revolution and not completed until 1840, Caillau being the final editor) and of Migne. The *Theological Orations* (edited by A. J. Mason) were published separately at Cambridge in 1899.

Scattered notices of the life of Gregory Nazianzen are to be found in the writings of Socrates, Sozomen, Theodoret and Rufinus, as well as in his own letters and poems. The data derived from these sources do not always harmonize with the account of Suidas. The earlier modern authorities, such as Tillemont (*Mém. Eccl.* t. ix.) and Leclerc (*Bib. Univ.* t. xviii.), were used by Gibbon. See also C. Ullmann, *Gregorius von Nazianz, der Theologe* (1835; Eng. trans. by G. F. Coxe, M.A., 1857); A. Benoît, *St Grégoire de Nazianze; sa vie, ses œuvres, et son époque* (1877); Montaut, *Revue critique de quelques questions historiques se rapportant à St Grégoire de Nazianze* (1879); F. W. Farrar, *Lives of the Fathers*, i. 491-582, and F. Loofs in Hauck-Herzog's *Realencyk. für prot. Theologie*, vii. 138.

GREGORY, ST. OF NYSSA (c. 331-c. 396), one of the four great fathers of the Eastern Church, designated by one of the later ecumenical councils as "a father of fathers," was a younger brother of Basil (the Great), bishop of Caesarea, and was born (probably at Neocæsarea about A.D. 331. For his education he was chiefly indebted to his elder brother. At a comparatively early age he entered the church, and held for some time the office of anagnost or reader; subsequently he manifested a desire to devote himself to the secular life as a rhetorician, an impulse which was checked by the earnest remonstrances of Gregory of Nazianzus. Finally, in 370 or 372 he was ordained by his brother Basil to the bishopric of Nyssa, a small town in Cappadocia. Here he is usually said (but on inadequate data) to have adopted the opinion then gaining ground in favour of the celibacy of the clergy, and to have separated from his wife Theosebia, who became a deaconess in the church. His strict orthodoxy on the subject of the Trinity and the Incarnation, together with his vigorous eloquence, combined to make him peculiarly obnoxious to the Arian faction, which was at that time in the ascendant through the protection of the emperor Valens; and in 375, the synod of Ancyra, convened by Demetrius the Arian governor of Pontus, condemned him for alleged irregularities in his election and in the administration of the finances of his diocese. In 376 he was deprived of his see, and Valens sent him into exile, whence he did not return till the publication of the edict of Gratian in 378. Shortly afterwards he took part in the proceedings of the synod which met at Antioch in Caria, principally in connexion with the Meletian schism. At the great ecumenical council held at Constantinople in 381, he was a conspicuous champion of the orthodox faith; according to Nicephorus, indeed, the additions made to the Nicene creed were entirely due to his suggestion, but this statement is of doubtful authority. That his eloquence was highly appreciated is shown by the facts that he pronounced the discourse at the consecration of Gregory of Nazianzus, and that he was chosen to deliver the funeral oration on the death of Meletius the first president of the council. In the following year, moreover (382), he was commissioned by the council to inspect and set in order the churches of Arabia, in connexion with which mission he also visited Jerusalem. The impressions he gathered from this journey may, in part at least, be gathered from his famous letter *De civitate Hierosolyma*, in which an opinion strongly unfavourable to pilgrimages is expressed. In 383 he was probably again in Constantinople; where in 385 he pronounced the funeral orations of the princess Pulkheria and afterwards of the empress Placidia. Once more we read of him in 394 as having been present in that metropolis at the synod held under the presidency of Nectarius to settle a controversy which had arisen among the bishops of Arabia; in the same year he assisted at the consecration of the new church of the apostles at Chalcedon, on which occasion there is reason to believe that his discourse commonly but wrongly known as that *Εἰς τὴν αὐτοῦ χειροτονίαν* was delivered. The exact date of his death is unknown; some authorities refer it to 376, others to 400. His festival is observed by the Greek Church on the 10th of January; in the Western martyrologies he is commemorated on the 9th of March.

Gregory of Nyssa was not so firm and able an administrator as his brother Basil, nor so magnificent an orator as Gregory of Nazianzus, but he excelled them both, alike as a speculative and constructive theologian, and in the wide extent of his acquirements. His teaching, though strictly trinitarian, shows considerable freedom and originality of thought; in many points his mental and spiritual affinities with Origen show themselves with advantage, as in his doctrine of *ἀνομιόνοια* or final restoration. There are marked pantheistic tendencies, e.g. the inclusion of sin as a necessary part of the cosmical process, which make him akin to the pantheistic monophysites and to some modern thinkers.

His style has been frequently praised by competent authorities for sweetness, richness and elegance. His numerous works may be classified under five heads: (1) Treatises in doctrinal and polemical theology. Of these the most important is that *Against Eunomius* in twelve books. Its doctrinal thesis (which is supported with great philosophic acumen and rhetorical power) is the divinity and consubstantiality of the Word; incidentally the character of Basil, which Eunomius had aspersed, is vindicated, and the heretic himself is held up to scorn and contempt. This is the work which, most probably in a shorter draft, was read by its author when at Constantinople before Gregory Nazianzen and Jerome in 381 (Jerome, *De vir. ill.* 128). To the same class belong the treatise *To Ablavius*, against the tritheists; *On Faith*, against the Arians; *On Common Notions*, in explanation of the terms in current employment with regard to the Trinity; *Ten Syllogisms*, against the Manichæans; *To Theophilus*, against the Apollinarians; an *Antirhetic* against the same; *Against Fate*, a disputation with a heathen philosopher; *De anima et resurrectione*, a dialogue with his dying sister Macrina; and the *Oratio catechetica magna*, an argument for the incarnation as the best possible form of redemption, intended to convince educated pagans and Jews. (2) Practical treatises. To this category belong the tracts *On Virginity* and *On Pilgrimages*; as also the *Canonical Epistle upon the rules of penance*. (3) Expository and homiletical works, including the *Hexæmeron*, and several series of discourses *On the Workmanship of Man*, *On the Inscriptions of the Psalms*, *On the Sixth Psalm*, *On the first three Chapters of Ecclesiastes*, *On Canticles*, *On the Lord's Prayer* and *On the Eight Beatitudes*. (4) Biographical, consisting chiefly of funeral orations. (5) Letters.

The only complete editions of the whole works are those by Fronton le Due (Fronto Duclius, Paris, 1615; with additions, 1618 and 1638) and by Migne. G. H. Forbes began an excellent critical edition, but only two parts of the first volume appeared (Bursatinsland, 1855 and 1861) containing the *Explicatio apologetica in hexæmeron* and the *De officio hominis*. Of the new edition projected by F. Oehler only the first volume, containing the *Opera dogmatica*, has appeared (1865). There have been numerous editions of several single treatises, as for example of the *Oratio catechetica* (J. G. Krabinger, Munich, 1838; J. H. Crawley, Cambridge, 1903), *De precatione* and *De anima et resurrectione*.

See F. W. Farrar, *Lives of the Fathers*, ii. 56-83, the monograph by J. Rupp (*Gregors, des Bischofs von Nyssa, Leben und Meinungen*, Leipzig, 1834), and compare P. Heyns (*Disputatio historico-theologica de Greg. Nyss.*, 1835), C. W. Müller (*Gregorius Nyss. doctrinam de hominis natura et illustravit et cum Origeniana comparavit*, 1854) and J. N. Stigler, *Die Psychologie des h. Gregors von Nyssa* (Regensburg, 1857), and many smaller monographs cited in Hauck-Herzog's *Realencyk. für prot. Theol.* vii. 149.

GREGORY, ST. OF TOURS (538-594), historian of the Franks, was born in the chief city of the Arverni (the modern Clermont-Ferrand) on the 30th of November 538. His real name was Georgius Florentius, Georgius being his grandfather's name and Florentius his father's. He was called Gregory after his maternal great-grandfather, the bishop of Langres. Gregory belonged to an illustrious senatorial family, many of whose members held high office in the church and bear honoured names in the history of Christianity. He was descended, it is said, from Vettius Epagathus, who was martyred at Lyons in 177 with St Pothinus; his paternal uncle, Gallus, was bishop of Clermont; his maternal grand-uncle, Nicetius (St Nizier), occupied the see of Lyons; and he was a kinsman of Euphronius, bishop of Tours.

Gregory lost his father early, and his mother Armentaria settled in the kingdom of Burgundy on an estate belonging to her near Cavallion, where her son often visited her. Gregory was brought up at Clermont-Ferrand by his uncle Gallus and by his successor, Avitus, and there he received his education. Among profane authors he read the first six books of the *Aeneid* and Sallust's history of the Catiline conspiracy, but his education was mainly religious. The principles of religion he learnt from

the Bible, Sulpicius Severus and some lives of saints, but to patristic literature and the subtleties of theology he remained a stranger. In 563, at the age of twenty-five, he was ordained deacon. Falling seriously ill, he went to Tours to seek a cure at the tomb of St Martin. At Tours he lived with Euphronius, and so great was the young man's popularity that, on the death of Euphronius in 573, the people unanimously designated him bishop.

At that time Tours belonged to Austrasia, and King Sigebert hastened to confirm Gregory's election. After the assassination of Sigebert (575), the province was ruled by Chilperic for nine years, during which period Gregory displayed the greatest energy in protecting his town and church from the Frankish king. He had to contend with Count Leudast, the governor of Tours; despite all the king's threats, he refused to give up Chilperic's son Meroving, who had sought refuge from his father's wrath at the sanctuary of St Martin; and he defended Bishop Pretextatus against Chilperic, by whom he had been condemned for celebrating the marriage of Merovech and Queen Brunhilda. In 580 Gregory was himself accused before a council at Berny of using abusive language against Queen Fredegond, but he cleared himself of the charge by an oath and was acquitted. On the death of Chilperic, Tours remained for two years (584-585) in the hands of Guntram, but when Guntram adopted his nephew Childebert, Sigebert's son, it again became Austrasia. This change was welcome to Gregory, who often visited the court. In 586 he was at Coblenz, and on his return to Yvois (the modern Carignan) visited the stylite Wulfilaic; in 588 we hear of him at Metz and also at Chalon-sur-Saône, whither he was sent to obtain from King Guntram the ratification of the pact of Andelot; in 593 he was at Orleans, where Childebert had just succeeded his uncle Guntram. In the intervals of these journeys he governed Tours with great firmness, repressing disorders and reducing the monks and nuns to obedience. He died on the 17th of November 594.

Gregory left many writings, of which he himself gives an enumeration at the end of his *Historia Francorum*: "Decem libros Historiarum, septem Miraculorum, unum de Vita Patrum scripti; in Esalterii tractatu librum unum commentatus sum; de Curibus etiam ecclesiasticis unum librum condidi." The ten books of history are discussed below. The seven books of miracles are divided into the *De gloria martyrum*, the *De virtutibus sancti Juliani*, four books of *Miraculis sancti Martini*, and the *De gloria confessorum*, the last dealing mainly with confessor who had dwelt in the cities of Tours and Clermont. The *Vitae patrum* consists of twenty biographies of bishops, abbots and hermits belonging to Gaul. The commentary on the Psalms is lost, the preface and the titles of the chapters alone being extant. The treatise *De curibus ecclesiasticis*, discovered in 1853, is a liturgical manual for determining the hour of divers nocturnal offices by the position of the stars. Gregory also left a life of St Andrew, translated from the Greek, and a history of the Seven Sleepers of Ephesus, translated from Syriac.

His most important work, however, is the *Historia Francorum*, which is divided into three parts. The first four books, which were composed at one time, cover the period from the creation of the world to the death of Sigebert in 575. The first book, which is a mere compilation from the chronicles of St Jerome and Orosius, is of no value. The second book, from 357 to 511, deals with the invasions of the Franks, and is based on the histories of Sulpicius Alexander and Renatus Profuturus Frigeridus, now lost; on the catalogues of the bishops of Clermont and Tours; on some lives of saints, e.g. Remigius and Maxentius, now lost; on the annals of Arles and Angers, now lost; and on legends, either collected by Gregory himself from oral tradition, or cantilenes or epics written in the Latin and Germanic languages. In the third and fourth books the earlier part is based on materials collected from men older than himself; of the later events he was himself an eye-witness. The fifth and sixth books, up to the death of Chilperic (584), deal with matters within his own experience. The first six books are often separate in the MSS., and it was these alone that were used by the

chronicler Fredegarius in his abridgment of Gregory's history. To the first six books Gregory subsequently added chapters on the bishops Salonius and Sagittarius, and on his quarrels with Felix of Nantes. The authenticity of these chapters has been undeservedly attacked by Catholic writers. Books vii. to x., from 584 to 591, were written in the form of a diary; of each important event, as it occurred, he inserted an account in his book. The last six books are of great historical value.

Gregory had an intimate knowledge of contemporary events. He was frequently at court, and he found Tours an excellent place for collecting information. The shrine of St Martin attracted the sick from all quarters, and the basilica of the saint was a favourite sanctuary for political refugees. Moreover, Tours was on the high road between the north and south of France, and was a convenient stage for travellers, the ambassadors going to and from Spain frequently halting there. Gregory plied every one with questions, and in this way gathered a great mass of detailed information. He was, besides, at great pains to be an impartial writer, but was not always successful. His devotion to Austrasia made him very bitter against, and perhaps unjust to, the sovereigns of Neustria, Chilperic and Fredegond. As an orthodox Christian, he had no good word for the Arians. He excuses the crimes of kings who protected the church, such as Clovis, Clotaire I. and Guntram, but had no mercy for those who violated ecclesiastical privileges. This attitude, no doubt, explains his hatred for Chilperic. But if Gregory's historical judgments are suspect, he at least concealed nothing and invented nothing; and we can correct his judgments by his own narrative. His history is a curious compound of artlessness and shrewdness. He was ignorant of the rules of grammar, confused genders and cases, and wrote in the vernacular Latin of his time, apart from certain passages which are especially elaborated and filled with poetical and elegant expressions. But in spite of his shortcomings he is an exceedingly attractive writer, and his mastery of the art of narrative has earned for him the name of the Herodotus of the barbarians.

T. Ruinart brought out a complete edition of Gregory's works at Paris in 1699. The best modern complete edition is that of W. Arndt and B. Krusch in *Mon. Germ. hist. script. rer. Merov.* (vol. i., 1885). Of the many editions of the *Historia Francorum* may be mentioned those of Guadet and Taranne in the *Soc. de l'hist. de France* (4 vols., with French translation, 1836-1838), of Omont (the first six books; a reproduction of the Corvey MS.) and of G. Collon (the last four books; a reproduction of the Brussels MS. No. 9, 403); Gregory's hagiographic works were published by H. Bordier in the *Soc. de l'hist. de France* (4 vols., with French translation, 1857-1864). Cf. J. W. Lößel, *Gregor von Tours und seine Zeit* (2nd ed., Leipzig, 1868); G. Monod, "Études critiques sur les sources de l'histoire mérovingienne" in the *Bibl. de l'École des Hautes Études* (1872); G. Kurth, "Grégoire de Tours et les études classiques au VI^e siècle" in the *Revue des questions historiques* (xiv. 586 seq., 1878); Max Bonnet, *Le Latin de Grégoire de Tours* (Paris, 1890). For details, see Ulysse Chevalier, *Bibliographie* (2nd ed.). (C. Fr.)

GREGORY THE ILLUMINATOR, the reputed founder of the Armenian Church. His legend is briefly as follows. His father Anak, head of the Parthian clan of Suren, was bribed about the time of his birth (c. 257) by the Sassanid king of Persia to assassinate the Armenian king, Chosroes, who was of the old Arsacid dynasty, and father of Tiridates or Trdat, first Christian king of Armenia. Anak was slain by his victim's soldiers; Gregory was rescued by his Christian nurse, carried to Caesarea in Cappadocia, and brought up a Christian. Grown to manhood he took service under Tiridates, now king of Armenia, in order by his own fidelity to atone for his father's treachery. Presently, at a feast of Anahite Gregory refused to assist his sovereign in offering pagan sacrifice, and his parentage being now revealed, was thrown into a deep pit at Artashat, where he languished for fourteen years, during which persecution raged in Armenia.

The scene of the legend now shifts to Rome, where Diocletian falls in love with a lovely nun named Ripaimé; she, rather than gratify his passion, flees with her abbess Galana and several priests to Armenia. Diocletian asks her back of Tiridates, who meanwhile has fallen in love with her herself. He too is flouted, and in his rage tortures and slays her and her companions. The traditional date of this massacre is the 5th of October,

A.D. 301. Providence, incensed at such cruelty, turns Tiridates into a wild boar, and afflicts his subjects with madness; but his sister, Chosrowidukht, has a revelation to bring Gregory back out of his pit. The king consents, the saint is acclaimed, the bodies of the thirty-seven martyrs solemnly interred, and the king, after fasting five, and listening to Gregory's homilies for sixty days, is healed. This all took place at Valarshapat, where Gregory, anxious to fix a site on which to build shrines for the relics of Ripsimé and Gaiana, saw the Son of God come down in a sheen of light, the stars of heaven attending, and smite the earth with a golden hammer till the nether world resounded to his blows. Three chapels were built on the spot, and Gregory raised his cross there and elsewhere for the people to worship, just as St Nino was doing about the same time in Georgia. There followed a campaign against the idols whose temples and books were destroyed. The time had now come for Gregory, who was still a layman and father of two sons, to receive ordination; so he went to Caesarea, where Leontius ordained and consecrated him catholicos or vicar-general of Armenia. This was sometime about 290, when Leontius may have acceded, though we first hear of him as bishop in 314.

Gregory's ordination at Caesarea is historical. The vision at Valarshapat was invented later by the Armenians when they broke with the Greeks, in order to give to their church the semblance, if not of apostolic, at least of divine origin.

According to Agathangelus, Tiridates went to Rome with Gregory, Aristaces, son of Gregory, and Albanos, head of the other priestly family, to make a pact with Constantine, newly converted to the faith, and receive a pallium from Silvester. The better sources make Sardica the scene of meeting and name Eusebius (of Nicomedia) as the prelate who attended Constantine. There is no reason to doubt that some such visit was made about the year 315, when the death of Maximin Daza left Constantine supreme. Eusebius testifies (*H.E.* ix. 8) that the Armenians were ardent Christians, and ancient friends and allies of the Roman empire when Maximin attacked them about the year 308. The conversion of Tiridates was probably a matter of policy. His kingdom was honeycombed with Christianity, and he wished to draw closer to the West, where he foresaw the victory of the new faith, in order to fortify his realm against the Sassanids of Persia. Following the same policy he sent Aristaces in 325 to the council of Nice. Gregory is related to have added a clause to the creed which Aristaces brought back; he became a hermit on Mount Sebu about the year 332, and died there.

Is the Ripsimé episode mere legend? The story of the conversion of Georgia by St Nino in the same age is so full of local colour, and coheres so closely with the story of Ripsimé and Gaiana, that it seems over-sceptical to explain the latter away as a mere doublet of the legend of Prisca and Valeria. The historians Faustus of Byzant and Lazar of Pharp in the 5th century already attest the reverence with which their memory was invested. We know from many sources the prominence assigned to women prophets in the Phrygian church. Nino's story reads like that of such a female missionary, and something similar must underlie the story of her Armenian companions.

The history of Gregory by Agathangelus is a compilation of about 450, which was rendered into Greek 550. Professor Marr has lately published an Arabic text from a MS. in Sinai which seems to contain an older tradition. A letter of Bishop George of Arabia to Jesu, a priest of the town Anab, dated 714 (edited by Dashian, Vienna, 1897), contains an independent tradition of Gregory, and styles him a Roman by birth.

In spite of legendary accretions we can still discern the true outlines and significance of his life. He did not really illumine or convert great Armenia, for the people were in the main already converted by Syrian missionaries to the Adoptionist or Ebonite type of faith which was dominant in the far East, and was afterwards known as Nestorianism. Marcionites and Montanists had also worked in the field. Gregory persuaded Tiridates to destroy the last relics of the old paganism, and carried out in the religious sphere his sovereign's policy of detaching Great

Armenia from the Sassanid realm and allying it with the Graeco-Roman empire and civilization. He set himself to Hellenise or Catholicise Armenian Christianity, and in furtherance of this aim set up a hierarchy officially dependent on the Cappadocian. He in effect turned his country into a province of the Greek see of Cappadocia. This hierarchical tie was soon snapped, but the Hellenizing influence continued to work, and bore its most abundant fruit in the 5th century. His career was thus analogous to that of St Patrick in Ireland.

AUTHORITIES.—S. Weber, *Die Catholische Kirche in Armenien* (Freiburg, 1903, with bibliography); Bollandii, *Acta sanctorum sept.* tom. 8; A. Carrière, *Les Hauts Sanctuaires de l'Arménie* (Paris, 1899); "Chrysostom" in Migne, *P. Gr.* tom. 63, col. 943 foll.; C. Fortescue, *The Armenian Church* (London, 1872); H. Gelzer, *Die Anfänge der armenischen Kirche* (Leipzig, 1895) (*Sächs. Gesells. der Wissensch.*); and s.v. "Armenien" in Herzog-Hauck (Leipzig, 1897); v. Gutschmid, *Kleine Schriften* (Leipzig, 1892); Himpel, *Gregor der Erleuchter*, Kl. v.; Issaverdenz, *Hist. of Arm. Church* (Venice, 1875); de Lagarde, *Agathangelos* (Göttingen, 1888); Arshak Ter Mikelian, *Die arm. Kirche* (Leipzig, 1892); Palmieri, "La Conversione ufficiale degli Iberi," *Oriens Christ.* (Rome, 1902); Ryssel, *Ein Brief Gregors, übersetzt, Studien und Kritiken*, 56, Bd. (1883); Samuelian, *Bekehrung Armeniens* (Vienna, 1844); Vetter, "Die arm. Väter," in Nischl's *Lehrbuch der Patrol.* iii. 215-262, (Mainz, 1881-1885); Malan, *S. Gregory the Illuminator* (Rivingtons, 1868).

(F. C. C.)

GREGORY (Gregorius), the name of sixteen popes and one anti-pope.

SAINT GREGORY, surnamed the Great (c. 540-604), the first pope of that name, and the last of the four doctors of the Latin Church, was born in Rome about the year 540. His father was Gordianus "the regionary," a wealthy man of senatorial rank, owner of large estates in Sicily and of a palace on the Caelian Hill in Rome; his mother was Silvia, who is commemorated as a saint on the 3rd of November. Of Gregory's early period we know few details, and almost all the dates are conjectural. He received the best education to be had at the time, and was noted for his proficiency in the arts of grammar, rhetoric and dialectic. Entering on a public career he held, about 573, the high office of prefect of the city of Rome; but about 574, feeling irresistibly attracted to the "religious" life, he resigned his post, founded six monasteries in Sicily and one in Rome, and in the last—the famous monastery of St Andrew—became himself a monk. This grateful seclusion, however, he was not permitted long to enjoy. About 578 he was ordained "seventh deacon" (or possibly archdeacon) of the Roman Church, and in the following spring Pope Pelagius II. appointed him "apocrisiarius," or resident ambassador, at the imperial court in Constantinople. Here he represented the interests of his church till about 586, when he returned to Rome and was made abbot of St Andrew's monastery. His rule, though popular, was characterized by great severity, as may be inferred from the story of the monk Justus, who was denied Christian burial because he had secreted a small sum of money. About this time Gregory completed and published his well-known exposition of the book of Job, commenced in Constantinople; he also delivered lectures on the Heptateuch, the books of Kings, the Prophets, the book of Proverbs and the Song of Songs. To this period, moreover, Bede's incident of the English slave-boys (if indeed it be accepted as historical) ought to be assigned. Passing one day through the Forum, Gregory saw some handsome slaves offered for sale, and inquired their nation. "Angles," was the reply. "Good," said the abbot, "they have the faces of angels, and should be coheirs with the angels in heaven. From what province do they come?" "From Deira." "Deira. Yea, verily, they shall be saved from God's ire (*de ira*) and called to the mercy of Christ. How is the king of that country named?" "Ella." "Then must Allelulia be sung in Ella's land." Gregory determined personally to undertake the conversion of Britain, and with the pope's consent actually set out upon the mission, but on the third day of his journey he was overtaken by messengers recalling him to Rome. In the year 590 Pelagius II. died of the plague that was raging in the city; whereupon the clergy and people unanimously chose Gregory as his successor. The abbot did his best to avoid the dignity, petitioned the emperor Maurice not

to ratify his election, and even meditated going into hiding; but, "while he was preparing for flight and concealment, he was seized and carried off and dragged to the basilica of St. Peter," and there consecrated bishop, on the 3rd of September 590.

The fourteen years of Gregory's pontificate were marked by extraordinary vigour and activity. "He never rested," writes a biographer, "he was always engaged in providing for the interests of his people; or in writing some composition worthy of the church, or in searching out the secrets of heaven by the grace of contemplation." His mode of life was simple and ascetic in the extreme. Having banished all lay attendants from his palace, he surrounded himself with clerics and monks, with whom he lived as though he were still in a monastery. To the spiritual needs of his people he ministered with pastoral zeal, frequently appointing "stations" and delivering sermons; nor was he less solicitous in providing for their physical necessities. Deaconries (offices of alms) and guest-houses were liberally endowed, and free distributions of food were made to the poor in the convents and basilicas. The funds for these and similar purposes were supplied from the Patrimony of St. Peter—the papal estates in Italy, the adjacent islands, Gaul, Dalmatia and Africa. These extensive domains were usually administered by specially appointed agents,—rectors and defensors,—who resided on the spot; but the general superintendence devolved upon the pope. In this sphere Gregory manifested rare capacity. He was one of the best of the papal landlords. During his pontificate the estates increased in value, while at the same time the real grievances of the tenants were redressed and their general position was materially improved. Gregory's principal fault as a man of business was that he was inclined to be too lavish of his revenues. It is said that he even impoverished the treasury of the Roman Church by his unlimited charities.

Within the strict bounds of his patriarchate, i.e. the churches of the suburbicarian provinces and the islands, it was Gregory's policy to watch with particular care over the election and discipline of the bishops. With wise toleration he was willing to recognize local deviations from Roman usage (e.g. in the ritual of baptism and confirmation), yet he was resolute to withstand any unauthorized usurpation of rights and privileges. The following rules he took pains to enforce: that clerics in holy orders should not cohabit with their wives or permit any women, except those allowed by the canons, to live in their houses; that clerics accused on ecclesiastical or lesser criminal charges should be tried only in the ecclesiastical courts; that clerics in holy orders who had lapsed should "utterly forfeit their orders and never again approach the ministry of the altar"; that the revenues of each church should be divided by its bishop into four equal parts, to be assigned to the bishop, the clergy, the poor and the repair of the fabric of the church.

In his relations with the churches which lay outside the strict limits of his patriarchate, in northern Italy, Spain, Gaul, Africa and Illyricum and also in the East, Gregory consistently used his influence to increase the prestige and authority of the Roman See. In his view Rome, as the see of the Prince of the Apostles, was by divine right "the head of all the churches." The decrees of councils would have no binding force "without the authority and consent of the apostolic see"; appeals might be made to Rome against the decisions even of the patriarch of Constantinople: all bishops, including the patriarchs, if guilty of heresy or uncanonical proceedings, were subject to correction by the pope. "If any fault is discovered in a bishop," Gregory wrote, "I know of no one who is not subject to the apostolic see." It is true that Gregory respected the rights of metropolitans and disapproved of unnecessary interference within the sphere of their jurisdiction canonically exercised; also that in his relations with certain churches (e.g. those in Africa) he found it expedient to abstain from any obtrusive assertion of Roman claims. But of his general principle there can be no doubt. His sincere belief in the apostolic authority of the see of St. Peter, his outspoken assertion of it, the consistency and firmness with which in practice he maintained it (e.g. in his controversies with the

bishops of Ravenna concerning the use of the pallium, with Maximus the "usurping" bishop of Salona, and with the patriarchs of Constantinople in respect of the title "ecumenical bishops"), contributed greatly to build up the system of papal absolutism. Moreover this consolidation of spiritual authority coincided with a remarkable development of the temporal power of the papacy. In Italy Gregory occupied an almost regal position. Taking advantage of the opportunity which circumstances offered, he boldly stepped into the place which the emperors had left vacant and the Lombard kings had not the strength to seize. For the first time in history the pope appeared as a political power, a temporal prince. He appointed governors to cities, issued orders to generals, provided munitions of war, sent his ambassadors to negotiate with the Lombard king and actually dared to conclude a private peace. In this direction Gregory went farther than any of his predecessors: he laid the foundation of a political influence which endured for centuries. "Of the medieval papacy," says Milman, "the real father is Gregory the Great."

The first monk to become pope, Gregory was naturally a strong supporter of monasticism. He laid himself out to diffuse the system, and also to carry out a reform of its abuses by enforcing a strict observance of the Rule of St. Benedict (of whom, it may be noted, he was the earliest biographer). Two slight innovations were introduced: the minimum age of an abbot was fixed at sixty, and the period of novitiate was prolonged from one year to two. Gregory sought to protect the monks from episcopal oppression by issuing *privilegia*, or charters in restraint of abuses, in accordance with which the jurisdiction of the bishops over the monasteries was confined to spiritual matters, all illegal aggressions being strictly prohibited. The documents are interesting as marking the beginning of a revolution which eventually emancipated the monks altogether from the control of their dioceses and brought them under the direct authority of the Holy See. Moreover Gregory strictly forbade monks to minister in parish churches, ordaining that any monk who was promoted to such ecclesiastical cure should lose all rights in his monastery and should no longer reside there. "The duties of each office separately are so weighty that no one can rightly discharge them. It is therefore very improper that one man should be considered fit to discharge the duties of both, and that by this means the ecclesiastical order should interfere with the monastic life, and the rule of the monastic life in turn interfere with the interests of the churches."

Once more, Gregory is remembered as a great organizer of missionary enterprise for the conversion of heathens and heretics. Most important was the two-fold mission to Britain—of St. Augustine in 596, of Mellitus, Paulinus and others in 601; but Gregory also made strenuous efforts to uproot paganism in Gaul, Italy, Sicily, Sardinia and Corsica, Arianism in Spain, Donatism in Africa, Manichaeism in Sicily, the heresy of the Three Chapters in Istria and northern Italy. In respect of the methods of conversion which he advocated he was not less intolerant than his contemporaries. Towards the Jews, however, he acted with exceptional lenity, protecting them from persecution and securing them the enjoyment of their legal privileges. The so-called "simoniacal heresy," particularly prevalent in Gaul, Illyricum and the East, he repeatedly attacked; and against the Gallican abuse of promoting laymen to bishoprics he protested with vigour.

The extent and character of Gregory's works in connexion with the liturgy and the music of the church is a subject of dispute. If we are to credit a 9th century biographer, Gregory abbreviated and otherwise simplified the Sacramentary of Gelasius, producing a revised edition with which his own name has become associated, and which represents the groundwork of the modern Roman Missal. But though it is certain that he introduced three changes in the liturgy itself (viz. the addition of some words in the prayer *Hanc igitur*, the recitation of the *Pater Noster* at the end of the Canon immediately before the fraction of the bread, and the chanting of the Alleluia after the Gradual at other times besides the season of Easter) and two

others in the ceremonial connected therewith (forbidding deacons to perform any musical portion of the service except the chanting of the gospel, and subdeacons to wear chasubles), neither the external nor the internal evidence appears to warrant belief that the Gregorian Sacramentary is his work. Ecclesiastical tradition further ascribes to Gregory the compilation of an Antiphony, the revision and rearrangement of the system of church music, and the foundation of the Roman *schola cantorum*. It is highly doubtful, however, whether he had anything to do either with the Antiphony or with the invention or revival of the *cantus planus*; it is certain that he was not the founder of the Roman singing-school, though he may have interested himself in its endowment and extension.

Finally, as Fourth Doctor of the Latin Church, Gregory claims the attention of theologians. He is the link between two epochs. The last of the great Latin Fathers and the first representative of medieval Catholicism he brings the dogmatic theology of Tertullian, Ambrose and Augustine into relation with the Scholastic speculation of later ages. "He connects the Græco-Roman with the Romano-Germanic type of Christianity." His teaching, indeed, is neither philosophical, systematic nor truly original. Its importance lies mainly in its simple, popular summarization of the doctrine of Augustine (whose works Gregory had studied with infinite care, but not always with insight), and in its detailed exposition of various religious conceptions which were current in the Western Church, but had not hitherto been defined with precision (e.g. the views on angelology and demonology, on purgatory, the Eucharistic Sacrifice, and the efficacy of relics). In his exposition of such ideas Gregory made a distinct advance upon the older theology and influenced profoundly the dogmatic development of the future. He imparted a life and impulse to prevailing tendencies, helping on the construction of the system hereafter to be completed in Scholasticism. He gave to theology a tone and emphasis which could not be disregarded. From his time to that of Anselm no teacher of equal eminence arose in the Church.

Gregory died on the 12th of March 604, and was buried the same day in the portico of the basilica of St Peter, in front of the sacristy. Translations took place in the 9th, 15th and 17th centuries, and the remains now rest beneath the altar in the chapel of Clement VIII. In respect of his character, while most historians agree that he was a really great man, some deny that he was also a great saint. The worst blot on his fair fame is his adulatory congratulation of the murderous usurper Phocas; though his correspondence with the Frankish queen Brunhilda, and the series of letters to and concerning the renegade monk Venantius also present problems which his admirers find difficult of solution. But while it may be admitted that Gregory was inclined to be unduly subservient to the great, so that at times he was willing to shut his eyes to the vices and even the crimes of persons of rank; yet it cannot fairly be denied that his character as a whole was singularly noble and unselfish. His life was entirely dominated by the religious motive. His sole desire was to promote the glory of God and of his church. At all times he strove honestly to live up to the light that was in him. "His goal," says Lau, "was always that which he acknowledged as the best." Physically, Gregory was of medium height and good figure. His head was large and bald, surrounded with a fringe of dark hair. His face was well-proportioned, with brown eyes, aquiline nose, thick and red lips, high-coloured cheeks, and prominent chin sparsely covered with a tawny beard. His hands, with tapering fingers, were remarkable for their beauty.

Gregory's Works.—The following are now universally admitted to be genuine:—*Epistolarum libri xiv.*, *Moralium libri xxxv.*, *Regulæ pastoralis libri, Dialogorum libri vi.*, *Homiliarum in Esaiam prophetam libri ii.*, *Homiliarum in Evangelia libri ii.* These are all printed in Migne's *Patrologia Latina*. The *Epistolæ*, however, have been published separately by P. Ewald and L. M. Hartmann in the *Monumenta Germaniæ historica* (Berlin, 1887-1899), and this splendid edition has superseded all others. The question of the chronological reconstruction of the *Register* is dealt with by Ewald in his celebrated article in the *Neues Archiv der Gesellschaft für ältere deutsche Geschichtskunde*, iii. pp. 433-625; and briefly by T. Hodgkin, *Italy and her Invaders*, v. 333-343. For

information about these writings of Gregory, consult especially G. J. T. Lau, *Gregor I. der Grosse*, pt. ii, chap. i. *Die Schriften Gregors* and F. Homes Dudden, *Gregory the Great* (see Index II. B.). In addition to the above-mentioned works there are printed under Gregory's name in Migne's *Patrologia Latina*, vol. lxxxix, the following:—*Super Cantico Cantorum expositio, In librum primum Regum variarum expositionum libri vi.*, *In septem psalmos poenitentiales expositio* and *Concordia quorundam testimoniorum s. scripturæ*. But (with the possible exception of the first) none of these treatises are of Gregorian authorship. See the discussions in Migne, Lau and Dudden.

AUTHORITIES.—(a) The principal ancient authorities for the life and works of Gregory are given in their chronological order. They are: Gregory of Tours, *Historia Francorum*, x. 1; *Liber pontificalis*, "Vita Gregorii Magni"; Isidore of Seville, *De vir. illustr.* 40, and Ildelphous of Toledo, *De vir. illustr.* 7; an anonymous *Vita Gregorii* (of English authorship) belonging to the monastery of St Gall, discovered by Ewald and published by F. A. Gasquet, *A Life of Pope St Gregory the Great* (1904); Bede, *Historia ecclesiastica*, ii. c. 1; Paul the Deacon, *Vita Gregorii Magni* (770-780); John the Deacon, *Vita Gregorii* (877-882). (b) Recent literature: J. Barmby, *Gregory the Great* (1892); T. Bonmann, *Gregor I. der Grosse, ein Lebensbild* (1896); F. Homes Dudden, *Gregory the Great: his place in History and Thought* (2 vols., 1905); G. J. T. Lau, *Gregor I. der Grosse nach seinem Leben und seiner Lehre geschildert* (1845); C. Wollgruber, *Gregor der Grosse* (1897). See also F. Gregorovius, *Rome in the Middle Ages* (Eng. trans.) ii. 16-103; T. Hodgkin, *Italy and her Invaders*, v. cc. 7-10; H. K. Mann, *The Lives of the Popes*, i. 1-250; F. W. Kellelt, *Pope Gregory the Great and his Relations with Gaul*; L. Pingaud, *La Politique de Saint Grégoire le Grand*; W. Wisbaum, *Die wichtigsten Richtungen und Ziele der Tätigkeit des Papstes Gregors des Grossen*; W. Hohaus, *Die Bedeutung Gregors des Grossen als liturgischer Schriftsteller*; E. G. P. Wyatt, *St Gregory and the Gregorian Music*; and the bibliographies of Gregory in Chevalier, *Répertoire des sources historiques du moyen âge*, and A. Potthast, *Bibliotheca historica. medio ævo.* (F. H. D.)

GREGORY II., pope from 715 to 731, succeeded Constantine I., whom he accompanied from Constantinople in 710. Gregory did all in his power to promote the spread of Christianity in Germany, and gave special encouragement to the mission of St Boniface, whom he consecrated bishop in 722. He was a staunch adherent of the East Roman empire, which still exercised sovereignty over Rome, Ravenna and some other parts of Italy, and he impeded as far as possible the progress of the Lombards. About 726, however, he became involved in a conflict with the emperor Leo the Isaurian on account of the excessive taxation of the Italians, and, later, on the question of image worship, which had been proscribed by the government of Constantinople. Leo endeavoured to rid himself of the pope by violence, but Gregory, supported by the people of Rome and also by the Lombards, succeeded in eluding the emperor's attacks, and died peacefully on the 11th of February 731.

GREGORY III., pope from 731 to 741. He condemned the iconoclasts at a council convened at Rome in November 731, and, like his predecessor Gregory II., stimulated the missionary labours of St Boniface, on whom he conferred the pallium. Towards the Lombards he took up an imprudent attitude, in support of which he in vain invoked the aid of the Frankish prince Charles Martel.

GREGORY IV., pope from 827 to 844, was chosen to succeed Valentinus in December 827, on which occasion he recognized the supremacy of the Frankish emperor in the most unequivocal manner. His name is chiefly associated with the quarrels between Lothair and Louis the Pious, in which he espoused the cause of the former, for whom, in the *Campus Mendacii* (*Lügenfeld*; field of lies), as it is usually called (833), he secured by his treachery a temporary advantage. The institution of the feast of All Saints is usually attributed to this pope. He died on the 25th of January 844, and was succeeded by Sergius II.

GREGORY V. (Bruno), pope from 996 to 999, a great-grandson of the emperor Otto the Great, succeeded John XV. when only twenty-four years of age, and until the council of Pavia (997) had a rival in the person of the anti-pope John XVI., whom the people of Rome, in revolt against the will of the youthful emperor Otto III., had chosen after having expelled Gregory. The most memorable acts of his pontificate were those arising out of the contumacy of the French king, Robert, who was ultimately brought to submission by the rigorous infliction of a sentence

of excommunication. Gregory died suddenly, and not without suspicion of foul play, on the 18th of February 999. His successor was Silvester II.

GREGORY VI., pope from 1045 to 1046. As Johannes Gratianus has had earned a high reputation for learning and probity, and in 1045 he bought the Roman pontificate from his godson Benedict IX. At a council held by the emperor Henry III. at Sutri in 1046, he was accused of simony and deposed. He was banished into Germany, where he died in 1047. He was accompanied into exile by his young protégé Hildebrand (afterwards pope as Gregory VII.), and was succeeded by Clement II. (L. D.*)

GREGORY VII., pope from 1073 to 1085. Hildebrand (the future pope) would seem to have been born in Tuscany—perhaps Ravacum—early in the third decade of the 11th century. The son of a plain citizen, Bunicus or Bonizo, he came to Rome at an early age for his education; an uncle of his being abbot of the convent of St Mary on the Aventine. His instructors appear to have included the archpriest Johannes Gratianus, who, by disbursing a considerable sum to Benedict IX., smoothed his way to the papal throne and actually ascended it as Gregory VI. But when the emperor Henry III., on his expedition to Rome (1046), terminated the scandalous *impasse* in which three popes laid claim to the chair of Peter by deposing all three, Gregory VI. was banished to Germany, and Hildebrand found himself obliged to accompany him. As he himself afterwards admitted, it was with extreme reluctance that he crossed the Alps. But his residence in Germany was of great educative value, and full of significance for his later official activity. In Cologne he was enabled to pursue his studies; he came into touch with the circles of Lorraine where interest in the elevation of the Church and her life was highest, and gained acquaintance with the political and ecclesiastical circumstances of that country which was destined to figure so largely in his career. Whether, on the death of Gregory VI. in the beginning of 1048, Hildebrand proceeded to Cluny is doubtful. His brief residence there, if it actually occurred, is to be regarded as no more than a visit; for he was never a monk of Cluny. His contemporaries indeed describe him as a monk; but his entry into the convent must be assigned to the period preceding or following his German travels and presumably took place in Rome. He returned to that city with Bishop Bruno of Toul, who was nominated pope under the title of Leo IX. (1048-1054). Under him Hildebrand found his first employment in the ecclesiastical service, becoming a sub-deacon and steward in the Roman Church. He acted, moreover, as a legate in France, where he was occupied *inter alia* with the question of Berengarius of Tours, whose views on the Lord's Supper had excited opposition. On the death of Leo IX. he was commissioned by the Romans as their envoy to the German court, to conduct the negotiations with regard to his successor. The emperor pronounced in favour of Bishop Gebhard of Eichstätt, who, in the course of his short reign as Victor II. (1055-1057), again employed Hildebrand as his legate to France. When Stephen IX. (Frederick of Lorraine) was raised to the papacy, without previous consultation with the German court, Hildebrand and Bishop Anselm of Lucca were despatched to Germany to secure a belated recognition, and he succeeded in gaining the consent of the empress Agnes. Stephen, however, died before his return, and, by the hasty elevation of Bishop Johannes of Velletri, the Roman aristocracy made a last attempt to recover their lost influence on the appointment to the papal throne—a proceeding which was charged with peril to the Church as it implied a renewal of the disastrous patrician régime. That the crisis was surmounted was essentially the work of Hildebrand. To Benedict X., the aristocratic nominee, he opposed a rival pope in the person of Bishop Gerhard of Florence, with whom the victory rested. The reign of Nicholas II. (1059-1061) was distinguished by events which exercised a potent influence on the policy of the Curia during the next two decades—the *rapprochement* with the Normans in the south of Italy, and the alliance with the democratic and, subsequently, anti-German movement of the Pataraens in the north. It was also under his pontificate (1059) that the law was enacted which transferred the

papal election to the College of Cardinals, thus withdrawing it from the nobility and populace of Rome and thrusting the German influence on one side. It would be too much to maintain that these measures were due to Hildebrand alone, but it is obvious that he was already a dominant personality on the Curia, through he still held no more exalted office than that of arch-deacon, which was indeed only conferred on him in 1059. Again, when Nicholas II. died and a new schism broke out, the discomfiture of Honorius II. (Bishop Cadalus of Parma) and the success of his rival (Anselm of Lucca) must be ascribed principally, if not entirely, to Hildebrand's opposition to the former. Under the sway of Alexander II. (1061-1073) this man loomed larger and larger in the eye of his contemporaries as the soul of the Curial policy. It must be confessed the general political conditions, especially in Germany, were at that period exceptionally favourable to the Curia, but to utilize them with the sagacity actually shown was nevertheless no slight achievement, and the position of Alexander at the end of his pontificate was a brilliant justification of the Hildebrandine statecraft.

On the death of Alexander II. (April 21, 1073), Hildebrand became pope and took the style of Gregory VII. The mode of his election was bitterly assailed by his opponents. True, many of the charges preferred are obviously the emanations of scandal and personal dislike, liable to suspicion from the very fact that they were not raised to impugn his promotion till several years had elapsed (c. 1076); still it is plain from his own account of the circumstances of his elevation that it was conducted in extremely irregular fashion, and that the forms prescribed by the law of 1059 were not observed. But the sequel justified his election—of which the worst that can be said is that there was no general suffrage. And this sequel again owed none of its success to chance, but was the fruit of his own exertions. In his character were united wide experience and great energy tested in difficult situations. It is proof of the popular faith in his qualifications that, although the circumstances of his election invited assault in 1073, no sort of attempt was then made to set up a rival pontiff. When, however, the opposition which took head against him had gone so far as to produce a pretender to the chair, his long and undisputed possession tended to prove the original legality of his papacy; and the appeal to irregularities at its beginning not only lost all cogency but assumed the appearance of a mere biased attack. On the 22nd of May he received sacerdotal ordination, and on the 30th of June episcopal consecration; the empress Agnes and the duchess Beatrice of Tuscany being present at the ceremony, in addition to Bishop Gregory of Vercelli, the chancellor of the German king, to whom Gregory would thus seem to have communicated the result of the election.

The focus of the ecclesiastico-political projects of Gregory VII. is to be found in his relationship with Germany. Since the death of Henry III. the strength of the monarchy in that country had been seriously impaired, and his son Henry IV. had to contend with great internal difficulties. This state of affairs was of material assistance to the pope. His advantage was still further accentuated by the fact that in 1073 Henry was but twenty-three years of age and by temperament inclined to precipitate action. Many sharp lessons were needful before he learned to bridle his impetuosity, and he lacked the support and advice of a disinterested and experienced statesman. Such being the conditions, a conflict between Gregory VII. and Henry IV. could have only one issue—the victory of the former.

In the two following years Henry was compelled by the Saxon rebellion to come to amicable terms with the pope at any cost. Consequently in May 1074 he did penance at Nuremberg in presence of the legates to expiate his continued intimacy with the members of his council banned by Gregory, took an oath of obedience, and promised his support in the work of reforming the Church. This attitude, however, which at first won him the confidence of the pope, he abandoned so soon as he gained the upper hand of the Saxons: this he achieved by his victory at Hohenburg on the Unstrut (June 9, 1075). He now attempted to reassert his rights of suzerain in upper Italy without delay.

He sent Count Eberhard to Lombardy to combat the Patrenes; nominated the cleric Tedaldo to the archbishopric of Milan, thus settling a prolonged and contentious question; and finally endeavoured to establish relations with the Normans duke, Robert Guiscard. Gregory VII. answered with a rough letter, dated December 8, in which—among other charges—he reproached the German king with breach of his word and with his further countenance of the excommunicated councillors; while at the same time he sent by word of mouth a brusque message intimating that the enormous crimes which would be laid to his account rendered him liable, not only to the ban of the church, but to the deprivation of his crown. Gregory ventured on these audacious measures at a time when he himself was confronted by a reckless opponent in the person of Cencius, who on Christmas-night did not scruple to surprise him in church and carry him off as a prisoner, though on the following day he was obliged to surrender his captive. The reprimands of the pope, couched as they were in such an unprecedented form, infuriated Henry and his court, and their answer was the hastily convened national council in Worms, which met on the 24th of January 1076. In the higher ranks of the German clergy Gregory had many enemies, and a Roman cardinal, Hugo Candidus, once on intimate terms with him but now at variance, had made a hurried expedition to Germany for the occasion and appeared at Worms with the rest. All the gross scandals with regard to the pontiff that this prelate could utter were greedily received by the assembly, which committed itself to the ill-considered and disastrous resolution that Gregory had forfeited his papal dignity. In a document full of accusations the bishops renounced their allegiance. In another King Henry pronounced him deposed, and the Romans were required to choose a new occupant for the vacant chair of St Peter. With the utmost haste two bishops were despatched to Italy in company with Count Eberhard under commission of the council, and they succeeded in procuring a similar act of deposition from the Lombard bishops in the synod of Piacenza. The communication of these decisions to the pope was undertaken by the priest Roland of Parma, and he was fortunate enough to gain an opportunity for speech in the synod, which had barely assembled in the Lateran church, and there to deliver his message announcing the deposition of the pontiff. For the moment the members were petrified with horror, but soon such a storm of indignation was aroused that it was only due to the moderation of Gregory himself that the envoy was not cut down on the spot. On the following day the pope pronounced the sentence of excommunication against the German king with all formal solemnity, divested him of his royal dignity and absolved his subjects from the oaths they had sworn to him. This sentence purported to eject the king from the church and to strip him of his crown. Whether it would produce this effect, or whether it would remain an idle threat, depended not on the author of the verdict, but on the subjects of Henry—before all, on the German princes. We know from contemporary evidence that the excommunication of the king made a profound impression both in Germany and Italy. Thirty years before, Henry III. had deposed three popes, and thereby rendered a great and acknowledged service to the church. When Henry IV. attempted to copy this summary procedure he came to grief, for he lacked the support of the people. In Germany there was a speedy and general revulsion of sentiment in favour of Gregory, and the particularism of the princes utilized the auspicious moment for prosecuting their anti-royal policy under the cloak of respect for the papal decision. When at Whitsuntide the king proposed to discuss the measures to be taken against Gregory in a council of his nobles at Mainz, only a few made their appearance; the Saxons snatched at the golden opportunity for renewing their insurrection and the anti-royalist party grew in strength from month to month. The situation now became extremely critical for Henry. As a result of the agitation, which was zealously fostered by the papal legate Bishop Altmann of Passau, the princes met in October at Tribur to elect a new German king, and Henry, who was stationed at Oppenheim on the left bank of the Rhine, was only saved from

the loss of his sceptre by the failure of the assembled princes to agree on the question of his successor. Their dissension, however, merely induced them to postpone the verdict. Henry, they declared, must make reparation to the pope and pledge himself to obedience; and they settled that, if, on the anniversary of his excommunication, he still lay under the ban, the throne should be considered vacant. At the same time they determined to invite Gregory to Augsburg, there to decide the conflict. These arrangements showed Henry the course to be pursued. It was imperative, under any circumstances and at any price, to secure his absolution from Gregory before the period named, otherwise he could scarcely foil his opponents in their intention to pursue their attack against himself and justify their measures by an appeal to his excommunication. At first he attempted to attain his ends by an embassy, but when Gregory rejected his overtures he took the celebrated step of going to Italy in person. The pope had already left Rome, and had intimated to the German princes that he would expect their escort for his journey on January 8 in Mantua. But this escort had not appeared when he received the news of the king's arrival. Henry, who travelled through Burgundy, had been greeted with wild enthusiasm by the Lombards, but resisted the temptation to employ force against Gregory. He chose instead the unexpected and unusual, but, as events proved, the safest course, and determined to compel the pope to grant him absolution by doing penance before him at Canossa, where he had taken refuge. This occurrence was quickly embellished and inwoven by legend, and great uncertainty still prevails with regard to several important points. The reconciliation was only effected after prolonged negotiations and definite pledges on the part of the king, and it was with reluctance that Gregory at length gave way, for, if he conferred his absolution, the diet of princes in Augsburg, in which he might reasonably hope to act as arbitrator, would either be rendered purposeless, or, if it met at all, would wear an entirely different character. It was impossible, however, to deny the penitent re-entrance into the church, and the politician had in this case to be subordinated to the priest. Still the removal of the ban did not imply a genuine reconciliation, and no basis was gained for a settlement of the great questions at issue—notably that of investiture. A new conflict was indeed inevitable from the very fact that Henry IV. naturally considered the sentence of deposition repealed with that of excommunication; while Gregory on the other hand, intent on reserving his freedom of action, gave no hint on the subject at Canossa.

That the excommunication of Henry IV. was simply a pretext—not a motive—for the opposition of the rebellious German nobles is manifest. For not only did they persist in their policy after his absolution, but they took the more decided step of setting up a rival king in the person of Duke Rudolph of Swabia (Forchheim, March 1077). At the election the papal legates present observed the appearance of neutrality, and Gregory himself sought to maintain this attitude during the following years. His task was the easier in that the two parties were of fairly equal strength, each endeavouring to gain the upper hand by the accession of the pope to their side. But his hopes and labours, with the object of receiving an appeal to act as arbitrator in the dynastic strife, were fruitless, and the result of his non-committal policy was that he forfeited in large measure the confidence of both parties. Finally he decided for Rudolph of Swabia in consequence of his victory at Flarchheim (January 27, 1080). Under pressure from the Saxons, and misinformed as to the significance of this battle, Gregory abandoned his waiting policy and again pronounced the excommunication and deposition of King Henry (March 7, 1080), unloosing at the same time all oaths sworn to him in the past or the future. But the papal censure now proved a very different thing from the papal censure four years previously. In wide circles it was felt to be an injustice, and men began to put the question—so dangerous to the prestige of the pope—whether an excommunication pronounced on frivolous grounds was entitled to respect. To make matters worse, Rudolph of Swabia died on the 16th of October of the

same year. True, a new claimant—Hermann of Luxemburg—was put forward in August 1081, but his personality was ill adapted for a leader of the Gregorian party in Germany, and the power of Henry IV. was in the ascendant. The king, who had now been schooled by experience, took up the struggle thus forced upon him with great vigour. He refused to acknowledge the ban on the ground of illegality. A council had been summoned at Brixen, and on the 25th of June 1080 it pronounced Gregory deposed and nominated the archbishop Guibert of Ravenna as his successor—a policy of anti-king, anti-pope. In 1081 Henry opened the conflict against Gregory in Italy. The latter had now fallen on evil days, and he lived to see thirteen cardinals desert him, Rome surrendered by the Romans to the German king, Guibert of Ravenna enthroned as Clement III. (March 24, 1084), and Henry crowned emperor by his rival, while he himself was constrained to flee from Rome.

The relations of Gregory to the remaining European states were powerfully influenced by his German policy; for Germany, by engrossing the bulk of his powers, not infrequently compelled him to show to other rulers that moderation and forbearance which he withheld from the German king. The attitude of the Normans brought him a rude awakening. The great concessions made to them under Nicholas II. were not only powerless to stem their advance into central Italy but failed to secure even the expected protection for the papacy. When Gregory was hard pressed by Henry IV., Robert Guiscard left him to his fate, and only interfered when he himself was menaced with the German arms. Then, on the capture of Rome, he abandoned the city to the tender mercies of his warriors, and by the popular indignation evoked by his act brought about the banishment of Gregory.

In the case of several countries, Gregory attempted to establish a claim of suzerainty on the part of the see of St. Peter, and to secure the recognition of its self-asserted rights of possession. On the ground of "immemorial usage" Corsica and Sardinia were assumed to belong to the Roman Church. Spain and Hungary were also claimed as her property, and an attempt was made to induce the king of Denmark to hold his realm as a fief from the pope. Philip I. of France, by his simony and the violence of his proceedings against the church, provoked a threat of summary measures; and excommunication, deposition and the interdict, appeared to be imminent in 1074. Gregory, however, refrained from translating his menaces into actions, although the attitude of the king showed no change, for he wished to avoid a dispersion of his strength in the conflict soon to break out in Germany. In England, again, William the Conqueror derived no less benefit from this state of affairs. He felt himself so safe that he interfered autocratically with the management of the church, forbade the bishops to visit Rome, filled bishoprics and abbey, and evinced little anxiety when the pope expatiated to him on the different principles which he entertained as to the relationship of church and state, or when he prohibited him from commerce or commanded him to acknowledge himself a vassal of the apostolic chair. Gregory had no power to compel the English king to an alteration in his ecclesiastical policy, so chose to ignore what he could not approve, and even considered it advisable to assure him of his particular affection.

Gregory, in fact, established relations—if no more—with every land in Christendom; though these relations did not invariably realize the ecclesiastico-political hopes connected with them. His correspondence extended to Poland, Russia and Bohemia. He wrote in friendly terms to the Saracen king of Mauretania in north Africa, and attempted, though without success, to bring the Armenians into closer contact with Rome. The East, especially, claimed his interest. The ecclesiastical rupture between the bishops of Rome and Byzantium was a severe blow to him, and he laboured hard to restore the former amicable relationship. At that period it was impossible to suspect that the schism implied a definite separation, for prolonged schisms had existed in past centuries, but had always been surmounted in the end. Both sides, moreover, had an

interest in repairing the breach between the churches. Thus, immediately on his accession to the pontificate, Gregory sought to come into touch with the emperor Michael VII. and succeeded. When the news of the Saracenic outrages on the Christians in the East filtered to Rome, and the political embarrassments of the Byzantine emperor increased, he conceived the project of a great military expedition and exhorted the faithful to participation in the task of recovering the sepulchre of the Lord (1074). Thus the idea of a crusade to the Holy Land already floated before Gregory's vision, and his intention was to place himself at the head. But the hour for such a gigantic enterprise was not yet come, and the impending struggle with Henry IV. turned his energies into another channel.

In his treatment of ecclesiastical policy and ecclesiastical reform, Gregory did not stand alone; but on the contrary found powerful support. Since the middle of the 11th century the tendency—mainly represented by Cluny—towards a stricter morality and a more earnest attitude to life, especially on the part of the clergy, had converted the papacy; and, from Leo IX. onward, the popes had taken the lead in the movement. Even before his election, Gregory had gained the confidence of these circles, and, when he assumed the guidance of the church, they laboured for him with extreme devotion. From his letters we see how he fostered his connexion with them and stimulated their zeal, how he strove to awake the consciousness that his cause was the cause of God and that to further it was to render service to God. By this means he created a personal party, unconditionally attached to himself, and he had his confidants in every country. In Italy Bishop Arnulfo of Lucca, to take an example, belonged to their number. Again, the duchess Beatrice of Tuscany and her daughter the Margravine Matilda, who put her great wealth at his disposal, were of inestimable service. The empress Agnes also adhered to his cause. In upper Italy the Patavines had worked for him in many ways, and all who stood for their objects stood for the pope. In Germany at the beginning of his reign the higher ranks of the clergy stood aloof from him and were confirmed in their attitude by some of his regulations. But Bishop Altmann of Passau, who has already been mentioned, and Archbishop Gebhard of Salzburg, were among his most zealous followers. That the convent of Hirschau in Swabia was held by Gregory was a fact of much significance, for its monks spread over the land as itinerant agitators and accomplished much for him in southern Germany. In England Archbishop Lanfranc of Canterbury probably stood closest to him; in France his champion was Bishop Hugo of Die, who afterwards ascended the archiepiscopal chair of Lyons.

The whole life-work of Gregory VII. was based on his conviction that the church has been founded by God and entrusted with the task of embracing all mankind in a single society in which His will is the only law; that, in her capacity as a divine institution, she outtops all human structures; and that the pope, *quis* head of the church, is the vice-regent of God on earth, so that disobedience to him implies disobedience to God—or, in other words, a defection from Christianity. Elaborating an idea discoverable in St. Augustine, he looked on the worldly state—a purely human creation—as an unhallowed edifice whose character is sufficiently manifest from the fact that it abolishes the equality of man, and that it is built up by violence and injustice. He developed these views in a famous series of letters to Bishop Hermann of Metz. But it is clear from the outset that we are only dealing with reflections of strictly theoretical importance; for any attempt to interpret them in terms of action would have bound the church to annihilate not merely a single definite state, but all states. Thus Gregory, as a politician desirous of achieving some result, was driven in practice to adopt a different standpoint. He acknowledged the existence of the state as a dispensation of Providence, described the coexistence of church and state as a divine ordinance, and emphasized the necessity of union between the *sacerdotium* and the *imperium*. But at no period would he have dreamed of putting the two powers on an equality; the superiority of church to state was to him a fact which admitted

of no discussion and which he had never doubted. Again, this very superiority of the church implied in his eyes a superiority of the papacy, and he did not shrink from drawing the extreme conclusions from these premises. In other words, he claimed the right of excommunicating and deposing incapable monarchs, and of confirming the choice of their successors. This habit of thought needs to be appreciated in order to understand his efforts to bring individual states into feudal subjection to the chair of St Peter. It was no mere question of formality, but the first step to the realization of his ideal theocracy comprising each and every state.

Since this papal conception of the state involved the exclusion of independence and autonomy, the history of the relationship between church and state is the history of one continued struggle. In the time of Gregory it was the question of appointment to spiritual offices—the so-called *investitures*—which brought the theoretical controversy to a head. The preparatory steps had already been taken by Leo IX., and the subsequent popes had advanced still further on the path he indicated; but it was reserved for Gregory and his enactments to provoke the outbreak of the great conflict which dominated the following decades. By the first law (1075) the right of investiture for churches was in general terms denied to the laity. In 1078 neglect of this prohibition was made punishable by excommunication, and, by a further decree of the same year, every investiture conferred by a layman was declared invalid and its acceptance pronounced liable to penalty. It was, moreover, enacted that every layman should restore, under pain of excommunication, all lands of the church, held by him as fiefs from princes or clerics; and that, henceforward, the assent of the pope, the archbishop, &c., was requisite for any investiture of ecclesiastical property. Finally in 1080 the forms regulating the canonical appointment to a bishopric were promulgated. In case of a vacancy the election was to be conducted by the people and clergy under the auspices of a bishop nominated by the pope or metropolitan; after which the consent of the pope or archbishop was to be procured; if any violation of these injunctions occurred, the election should be null and void and the right of choice pass to the pope or metropolitan. In so legislating, Gregory had two objects: in the first place, to withdraw the appointment to episcopal offices from the influence of the king; in the second, to replace that influence by his own. The intention was not to increase the power of the metropolitan: he simply desired that the nomination of bishops by the pope should be substituted for the prevalent nomination of bishops by the king. But in this course of action Gregory had a still more ambitious goal before his eyes. If he could once succeed in abolishing the lay investiture the king would, *ipso facto*, be deprived of his control over the great possessions assigned to the church by himself and his predecessors, and he could have no security that the duties and services attached to those possessions would continue to be discharged for the benefit of the Empire. The bishops in fact were to retain their position as princes of the Empire, with all the lands and rights of supremacy pertaining to them in that capacity, but the bond between them and the Empire was to be dissolved: they were to owe allegiance not to the king, but to the pope—a non-German sovereign who, in consequence of the Italian policy of the German monarchy, found himself in perpetual opposition to Germany. Thus, by his ecclesiastical legislation, Gregory attempted to shake the very foundations on which the constitution of the German empire rested, while completely ignoring the historical development of that constitution (see INVESTITURE).

That energy which Gregory threw into the expansion of the papal authority, and which brought him into collision with the secular powers, was manifested no less in the internal government of the church. He wished to see all important matters of dispute referred to Rome; appeals were to be addressed to himself, and he arrogated the right of legislation. The fact that his laws were usually promulgated by Roman synods which he convened during Lent does not imply that these possessed an independent position; on the contrary, they were entirely dominated by his influence,

and were no more than the instruments of his will. The centralisation of ecclesiastical government in Rome naturally involved a curtailment of the powers of the bishops and metropolitans. Since these in part refused to submit voluntarily and attempted to assert their traditional independence, the pontificate of Gregory is crowded with struggles against the higher ranks of the prelacy. Among the methods he employed to break their power of resistance, the despatch of legates proved peculiarly effective. The regulation, again, that the metropolitans should apply at Rome in person for the pallium—pronounced essential to their qualifications for office—served to school them in humility.

This battle for the foundation of papal omnipotence within the church is connected with his championship of compulsory celibacy among the clergy and his attack on simony. Gregory VII. did not introduce the celibacy of the priesthood into the church, for even in antiquity it was enjoined by numerous laws. He was not even the first pope to renew the injunction in the 11th century, for legislation on the question begins as early as in the reign of Leo IX. But he took up the struggle with greater energy and persistence than his predecessors. In 1074 he published an encyclical, requiring all to renounce their obedience to those bishops who showed indulgence to their clergy in the matter of celibacy. In the following year he commanded the laity to accept no official ministrations from married priests and to rise against all such. He further deprived these clerics of their revenues. Wherever these enactments were proclaimed they encountered tenacious opposition, and violent scenes were not infrequent, as the custom of marriage was widely diffused throughout the contemporary priesthood. Other decrees were issued by Gregory in subsequent years, but were now couched in milder terms, since it was no part of his interest to increase the numbers of the German faction. As to the objectionable nature of simony—the transference or acquisition of a spiritual office for monetary considerations—no doubt could exist in the mind of an earnest Christian, and no theoretical justification was ever attempted. The practice, however, had attained great dimensions both among the clergy and the laity, and the sharp campaign, which had been waged since the days of Leo IX., had done little to limit its scope. The reason was that in many cases it had assumed an extremely subtle form, and detection was difficult when the simony took the character of a tax or an honorarium. The fact, again, that lay investiture was described as simony, inevitably brought with it an element of confusion, and, in the case of a charge of simoniacal practices, enormously accentuates the difficulty of determining the actual state of affairs. The war against simony in its original form was undoubtedly necessary, but it led to highly complicated and problematic issues. Was the priest or bishop, whose ordination was due to simony, actually in the possession of the sacerdotal or episcopal power or not? If the answer was in the affirmative; it would seem possible to try the Holy Ghost; if in the negative, then obviously all the official acts of the respective priest or bishop—which, according to the doctrine of the church, presupposed the possession of a spiritual quality—were invalid. And, since the number of simoniacal bishops was at that period extremely large, incalculable consequences resulted. The difficulty of the problem accounts for the diversity of solutions propounded. The perplexity of the situation was aggravated by the fact that, if the stricter view was adopted, it followed that the sacrament of ordination must be pronounced invalid, even in the cases where it had been unconsciously sought at the hands of a simoniac, for the dispenser was in point of fact no bishop, although he exercised the episcopal functions and his transgressions were unknown, and consequently it was impossible for him to ordain others. In the time of Gregory the conflict was still awaiting to and fro, and he himself in 1078 declared consecration by a simoniac null and void.

The pontificate of Gregory VII. came to a melancholy close, for he died in Salerno; the Romans and a number of his most trusted coadjutors had renounced him, and the faithful band in Germany had shrunk to scant proportions. Too much

the politician, too rough in his methods, too exclusively the representative of the Roman see and its interests, he had gained more enemies than friends. He was of course a master of statecraft; he had pursued political ends with consummate skill, causing them to masquerade as requirements of religion; but he forgot that incitement to civil war, the preaching of rebellion, and the release of subjects from their oaths, were methods which must infallibly lead to moral anarchy, and tend, with justice, to stifle the confidence once felt in him. The more he accustomed his contemporaries to the belief that any and every measure—so long as it opened up some prospect of success—was good in his sight, no matter how dangerous the fruits it might mature, the fainter grew their perception of the fact that he was not only a statesman but primarily the head of the Christian Church. That the frail bonds of piety and religious veneration for the chair of St Peter had given way in the struggle for power was obvious to all, when he himself lost that power and the star of his opponent was in the ascendant. He had given the rein to his splendid gifts as a ruler, and in his capacity of pope he omitted to provide an equivalent counterpoise. We are told that he was once an impressive preacher, and he could write to his faithful countesses in terms which prove that he was not wanting in religious feeling; but in the whirlpool of secular politics this phase of his character was never sufficiently developed to allow the vice-gerent of Christ to be heard instead of the hierarch in his official acts.

But to estimate the pontificate of Gregory by the disasters of its closing years would be to misconceive its significance for the history of the papacy entirely. On the contrary, his reign forms an important chapter in the history of the popedom as an institution; it contains the germs of far-reaching modifications of the church, and it gave new impulses to both theory and practice, the value of which may indeed be differently estimated, but of which the effects are indubitable. It was he who conceived and formulated the ideal of the papacy as a structure embracing all peoples and lands. He took the first step towards the codification of ecclesiastical law and the definite ratification of the claims of the apostolic chair as corner-stones in the church's foundation. He educated the clergy and the lay world in obedience to Rome; and, finally, it was due to his efforts that the duty of the priest with regard to sexual abstinence was never afterwards a matter of doubt in the Catholic Christianity of the West.

On the 25th of May 1085 he died, unbroken by the misfortunes of his last years, and unshaken in his self-certainty. *Dilecti iustitiam et odium iniquitatem: propterea morior in exilio*—are said to have been his last words. In 1584 Gregory XIII. received him into the *Martyrologium Romanum*; in 1606 he was canonized by Paul V. The words dedicated to him in the *Breviarium Romanum*, for May 25, contain such an apotheosis of his pontificate that in the 18th and 19th centuries they were prohibited by the governments of several countries with Roman Catholic populations.

BIBLIOGRAPHY.—A comprehensive survey of the sources and literature for the history of Gregory VII. is given by C. Mirbt, s.v. "Gregor VII.," in Herzog-Hauck, *Realencyclopädie*, 3rd ed. vol. vii, pp. 96 sqq. The main source for the reign of Gregory consists of his letters and decrees, the greater part of which are collected in the *Registrum* (ed. P. Jaffé, *Bibliotheca rerum Germanicarum*, ii., Berlin, 1865). The letters preserved in addition to this official collection are also reprinted by Jaffé under the title of *Epistolae collectae*. The *Dictatus Papae*—a list of twenty-seven short sentences on the rights of the pope,—which is given in the *Registrum*, is not the work of Gregory VII., but should probably be ascribed to Cardinal Deusdedit. Further: A. Potthast, *Bibliotheca historica mediæ ævi*, i. (2nd ed., Berlin, 1896), pp. 541 sq., ii. 1351; P. Jaffé, *Regesta pontificum* (2nd ed., 1865), tome i. pp. 594-649, Nr. 4771-5313, tome ii. p. 751. The most important letters and decrees of Gregory VII. are reprinted by C. Mirbt, *Quellen zur Geschichte des Papsttums* (2nd ed., Tübingen, 1901), Nr. 183 sqq., pp. 100 sqq. The oldest life of Gregory is that by Paul von Bernward, reprinted, e.g. by Watterich, *Vitae pontificum*, i. 474-546. Among the historians the following are of especial importance: Barthold., Bernold, Lambert von Hersfeld, Bruno, Marianus Scotus, Leo of Ostia, Peter of Martine Cassino, Sieber of Gembloux, Hugo of Flavigny, Arnulph and Landulf of Milan, Donizo—their works being reprinted in the section "Scriptores" in the *Monumenta Germaniae historica*, vols. v., vi., vii., viii., xii. The struggles which broke out under Gregory VII.

and were partially continued in the subsequent decades gave rise to a pamphlet literature which is of extreme importance for their internal history. The extant materials vary greatly in extent, and display much diversity from the literary-historical point of view. Most of them are printed in the *Monumenta Germaniae*, under the title, *Libelli de lite imperatorum et pontificum saeculis XI. et XII. conscripti*, tome i. (Hanover, 1891), tome ii. (1892), tome iii. (1897). The scientific investigation of the Gregorian age has received enormous benefit from the critical editions of the sources in the *Monumenta Germaniae*, so that the old literature is for the most part antiquated. This is true even of the great monograph on this pope—A. F. Gröner, *Papst Gregorius VII. und sein Zeitalter* (7 vols., Schaffhausen, 1859-1861), which must be used with extreme caution. The present state of criticism is represented by the following works: G. Meyer von Knonau, *Jahrbücher des deutschen Reichs unter Heinrich IV. und Heinrich V.*, vol. I. (Leipzig, 1896), ii. (1894), iii. (1900), iv. (1903); W. Martens, *Gregor VII., sein Leben und Werke* (2 vols., Leipzig, 1904); C. Mirbt, *Die Publizistik im Zeitalter Gregors VII.* (Leipzig, 1894); A. Hauck, *Kirchengeschichte Deutschlands* (3 vols., Leipzig, 1894). The special literature on individual events during the Gregorian pontificate is so extensive that no list can be given here. On Gregory's elevation to the chair, cf. C. Mirbt, *Die Wahl Gregors VII.* (Marburg, 1892). See also A. H. Mathew, D.D., *Life and Times of Hildebrand, Pope Gregory VII.* (1910). (C. M.)

GREGORY VIII. (Mauritius Burdinus), antipope from 1118 to 1121, was a native of southern France, who had crossed the Pyrenees while young and had later been made archbishop of Braga. Suspended by Paschal II. in 1114 on account of a dispute with the Spanish primate and papal legate, the archbishop of Toledo, he went to Rome and regained favour to such an extent that he was employed by the pope on important legations. He opposed the extreme Hildebrandine policy, and, on the refusal of Gelasius II. to concede the emperor's claim to investiture, he was proclaimed pope at Rome by Henry V. on the 8th of March 1118. He was not universally recognized, however, and never fully enjoyed the papal office. He was excommunicated by Gelasius II. in April 1118, and by Calixtus II. at the synod of Reims (October 1119). He was driven from Rome by the latter in June 1121, and, having been surrendered by the citizens of Sutri, he was forced to accompany in ridiculous guise the triumphal procession of Calixtus through Rome. He was exiled to the convent of La Cava, where he died.

The life of Gregory VIII. by Baluzius in *Baluzii miscellanea*, vol. 1, ed. by J. D. Mansi (Lucca, 1761), is an excellent vindication of an antipope. The chief sources are in *Monumenta Germaniae historica*, *Scriptores*, vols. 5 and 20, and in J. M. Watterich, *Pontif. Roman. vitae*, vol. 2. See C. Mirbt, *Die Publizistik im Zeitalter Gregors VII.* (Leipzig, 1894); J. Langen, *Geschichte der römischen Kirche von Gregor VII. bis Innocenz III.* (Bonn, 1893); Jaffé, *Regesta pontif. Roman.*, 2nd ed., (1885-1888); K. J. von Helele, *Concilien-geschichte*, Bd. 5, 2nd ed., F. Gregorovius, *Rome in the Middle Ages*, vol. 4, trans. by Mrs G. W. Hamilton (London, 1900-1902); P. B. Gams, *Kirchengeschichte von Spanien*, vol. 3 (Regensburg, 1876).

GREGORY VIII. (Alberto de Moro), pope from the 21st of October to the 17th of December 1187, a native of Benevento and Praemonstratensian monk, successively abbot of St Martin at Laon, cardinal-deacon of San' Adriano al Foro, cardinal-priest of San Lorenzo in Lucina, and chancellor of the Roman Church, was elected to succeed Urban III. Of amiable disposition, he hastened to make peace with Henry VI. and promised not to oppose the latter's claim to Sicily. He addressed general letters both to the bishops, reminding them of their duties to the Roman Church, especially of their required visits *ad limina*, and to the whole Christian people, urging a new crusade to recover Jerusalem. He died at Pisa while engaged in making peace between the Pisans and Genoa in order to secure the help of both cities in the crusade. His successor was Clement III.

His letters are in J. P. Migne, *Patrol. Lat.* vol. 202. Consult also J. M. Watterich, *Pontif. Roman. vitae*, vol. 2 (Leipzig, 1862), and Jaffé-Wattenbach, *Regesta pontif. Roman.* (1885-1888). See J. Langen, *Geschichte der römischen Kirche von Gregor VII. bis Innocenz III.* (Bonn, 1893); P. Nadig, *Gregors VIII. 570jähriges Pontifikat* (Basel, 1890); P. Scheffer-Boichorst, *Friedrichs I. letzter Streit mit der Kurie* (Berlin, 1866); F. Gregorovius, *Rome in the Middle Ages*, vol. 4, trans. by Mrs G. W. Hamilton (London, 1896).

GREGORY IX. (Ugolino Conti de Segni), pope from the 19th of March 1227, to the 22nd of August 1241, was a nobleman of Anagni and probably a nephew of Innocent III. He studied

at Paris and Bologna, and, having been successively archpriest of St Peter's, papal chaplain, cardinal-deacon of Sant' Eustachio, cardinal-bishop of Ostia, the first protector of the Franciscan order, and papal legate in Germany under Innocent III., and Honorius III., he succeeded the latter in the papacy. He had long been on friendly terms with the emperor Frederick II., but now excommunicated him (29th of September 1227) for continued neglect of his vows and refusal to undertake the crusade. When Frederick finally set out the following June without making submission to the pope, Gregory raised an insurrection against him in Germany, and forced him in 1230 to beg for absolution. The Romans, however, soon began a very bitter war against the temporal power and exiled the pope (1st of June 1231). Hardly had this contest been brought to an end favourable to the papacy (May 1235) when Gregory came into fresh conflict with Frederick II. He again excommunicated the emperor and released his subjects from their allegiance (24th of March 1239). Frederick, on his side, invaded the Papal States and prevented the assembling of a general council convoked for Easter 1241. The work of Gregory, however, was by no means limited to his relations with emperor and Romans. He systematized the Inquisition and entrusted it to the Dominicans; his rules against heretics remained in force until the time of Sixtus V. He supported Henry III. against the English barons, and protested against the Pragmatic Sanction of Louis IX. of France. He sent monks to Constantinople to negotiate with the Greeks for church unity, but without result. He canonized Saints Elizabeth of Thuringia, Dominic, Anthony of Padua and Francis of Assisi. He permitted free study of the Aristotelian writings, and issued (1234), through his chaplain, Raymond of Pennaforte, an important new compilation of decretals which he prescribed in the bull *Rex pacificus* should be the standard text-book in canon law at the universities of Bologna and Paris. Gregory was famed for his learning and eloquence, his blameless life, and his great strength of character. He died on the 22nd of August 1241, while Frederick II. was advancing against him, and was succeeded by Celestine IV.

For the life of Gregory IX., consult his Letters in *Monumenta Germaniae historica, Epistolae saeculi XIII. e regestis pontif. Roman. selectae* (Berlin, 1883); "Les Registres de Grégoire IX.," ed. L. Auvray in *Bibliothèque des écoles françaises d'Athènes et de Rome* (Paris, 1890-1905); A. Pottstast, *Regesta pontif. Roman.* (Berlin, 1875) and "Registri dei Cardinali Ugolino d'Ostia et Ottaviano degli Ubaldini," ed. G. Levi in *Ponti per la storia d'Italia* (1890). See J. Felten, *Papst Gregor IX.* (Freiburg i. B., 1886); J. Marx, *Die Vita Gregorius IX. Quellenkritisch untersucht* (1899); P. Balan, *Storia di Gregorio IX e dei suoi tempi* (3 vols., Modena, 1872-1873); F. Gregorovius, *Rome in the Middle Ages*, vol. 5, trans. by Mrs G. W. Hamilton (London, 1900-1902); H. H. Milman, *Latin Christianity*, vol. 5 (London, 1899); R. Honig, *Rapporti tra Federico II e Gregorio IX rispetto alla spedizione in Palestina* (1896); P. T. Mascetti, *I Pontefici Onorio III, Gregorio IX ed Innocenzo IV a fronte dell' Imperatore Federico II nel secolo XIII* (1884); T. Frantz, *Der grosse Kampf zwischen Kaiserthum u. Papstthum zur Zeit des Hohenstaufen Friedrich II.* (Berlin, 1903); W. Norden, *Das Papstthum u. Byzanz* (Berlin, 1903). An exhaustive bibliography and an excellent article on Gregory by Carl Mirbt are to be found in Hauck's *Realencyclopädie*, 3rd edition.

GREGORY X. (*Tebaldo Visconti*), pope from the 1st of September 1271, to the 10th of January 1276, was born at Piacenza in 1208, studied for the church, and became archdeacon of Liège. The eighteen cardinals who met to elect a successor to Clement IV. were divided into French and Italian factions, which wrangled over the election for nearly three years in the midst of great popular excitement, until finally, stirred by the eloquence of St Bonaventura, the Franciscan monk, they entrusted the choice to six electors, who hit on Visconti, at that time accompanying Edward of England on the crusade. He returned to Rome and was ordained priest on the 19th of March 1272, and consecrated on the 27th. He at once summoned the fourteenth general council of the Catholic Church, which met at Lyons in 1274, with an attendance of some 1600 prelates, for the purpose of considering the eastern schism, the condition of the Holy Land, and the abuses in the church. The Greeks were persuaded, thanks to St Bonaventura, to consent to a union with Rome for the time being, and Rudolph of Habsburg renounced at the

council all imperial rights in the States of the Church. The most celebrated among the many reform decrees issued by Gregory was the constitution determining for the first time the form of conclave at papal elections, which in large measure has remained ever since the law of the church. Gregory was on his way to Rome to crown Rudolph and send him out on a great crusade in company with the kings of England, France, Aragon and Sicily, when he died at Arezzo on the 10th of January 1276. He was a nobleman, fond of peace and actuated by the consciousness of a great mission. He has been honoured as a saint by the inhabitants of Arezzo and Piacenza. His successor in the papacy was Innocent V.

The registers of Gregory X. have been published by J. Guiraud in the *Bibliothèque des écoles françaises d'Athènes et de Rome* (Paris, 1892-1898). See K. J. von Hefele, *Concilien-geschichte*, vol. 5, 2nd edition (1873-1890); H. Finke, *Kreuzstudien z. Gesch. des 13ten Jahrhunderts* (Münster, 1891); P. Piacenza, *Compendio della storia del b. Gregorio X. papa* (Piacenza, 1876); F. Gregorovius, *Rome in the Middle Ages*, vol. 5, trans. by Mrs G. W. Hamilton (London, 1900-1902); H. Otto, *Die Beziehungen Rudolfs von Habsburg zu Papst Gregor X.* (Innsbruck, 1895); A. Zisterer, *Gregor X. u. Rudolf von Habsburg in ihren gegenseitigen Beziehungen* (Freiburg i. B., 1891); F. Walter, *Die Politik der Kurie unter Gregor X.* (Berlin, 1894); A. Pottstast, *Regesta pontif. Roman.* vol. 2 (Berlin, 1875); W. Norden, *Das Papstthum und Byzanz* (Berlin, 1903); J. Loserth, "Akten über die Wahl Gregors X.," in *Neues Archiv*, xii. (1895); A. von Hirsch-Gereuth, "Die Kreuzzugspolitik Gregors X.," in *Studien z. Gesch. d. Kreuzzüge nach den Kreuzzügen* (Munich, 1896). There is an excellent article by Carl Mirbt in Hauck's *Realencyclopädie*, 3rd edition.

GREGORY XI. (*Pierre Roger de Beaumont*), pope from the 30th of December 1370 to the 27th of March 1378, born in Limousin in 1330, created cardinal-deacon of Sta Maria Nuova by his uncle, Clement VI., was the successor of Urban V. His efforts to establish peace between France and England and to aid the Eastern Christians against the Turks were fruitless, but he prevented the Visconti of Milan from making further encroachments on the States of the Church. He introduced many reforms in the various monastic orders and took vigorous measures against the heresies of the time. His energy was stimulated by the stirring words of Catherine of Siena, to whom in particular the transference of the papal see back to Italy (17th of January 1377) was almost entirely due. Whilst at Rome he issued several bulls to the archbishop of Canterbury, the king of England, and the university of Oxford, commanding an investigation of Wycliffe's doctrines. Gregory was meditating a return to Avignon when he died. He was the last of the French popes who for some seventy years had made Avignon their see, a man learned and full of zeal for the church, but irresolute and guilty of nepotism. The great schism, which was to endure fifty years, broke out soon after the election of his successor, Urban VI.

See H. J. Tomaseth, "Die Register u. Secretäre Urbans V. u. Gregors XI.," in *Mitteilungen des Instituts für österreichische Geschichtsforschung* (1898); Baluzius, *Vitae pap. Avenion.* vol. 1 (Paris, 1693); L. Pastor, *History of the Popes*, vol. 1, trans. by F. I. Antrobus (London, 1899); F. Gregorovius, *Rome in the Middle Ages*, vol. 6, trans. by Mrs G. W. Hamilton (London, 1900-1902); J. P. Kirch, *Die Rückkehr der Päpste Urban V. u. Gregor XI. von Avignon nach Rom* (Paderborn, 1898); J. B. Christophe, *Histoire de la papauté pendant le XIV^e siècle*, vol. 2 (Paris, 1853). There is a good article by J. N. Brischar in the *Kirchenlexikon*, 2nd edition.

GREGORY XII. (*Angelo Coriario, or Correr*), pope from the 30th of November 1406, to the 4th of July 1415, was born of a noble family at Venice about 1326. Successively bishop of Castello, Latin patriarch of Constantinople, cardinal-priest of San Marco, and papal secretary, he was elected to succeed Innocent VII., after an interregnum of twenty-four days, under the express condition that, should the antipope Benedict XIII. at Avignon renounce all claim to the papacy, he also would renounce his, so that the long schism might be terminated. As pope, he concluded a treaty with his rival at Marseilles, by which a general council was to be held at Savona in September, 1408, but King Ladislaus of Naples, who opposed the plan from policy, seized Rome and brought the negotiations to nought. Gregory had promised not to create any more cardinals, and when he did so, in 1408, his former cardinals deserted him and, together with the Avignon cardinals, convoked the council of

Pisa, which, despite its irregularity, proclaimed in June 1409 the deposition of both popes and the election of Alexander V. Gregory, still supported by Naples, Hungary, Bavaria, and by Rupert, king of the Romans, found protection with Ladislaus, and in a synod at Cividale del Friuli banned Benedict and Alexander as schismatical, perjured and scandalous. John XXIII., having succeeded to the claims of Alexander in 1410, concluded a treaty with Ladislaus, by which Gregory was banished from Naples on the 31st of October 1411. The pope then took refuge with Carlo Malatesta, lord of Rimini, through whom he presented his resignation to the council of Constance on the 4th of July 1415. A weak and easily-influenced old man, his resignation was the noblest act of his pontificate. The rest of his life was spent in peaceful obscurity as cardinal-bishop of Porto and legate of the mark of Ancona. He died at Recanati on the 18th of October 1417. Some writers reckon Alexander V. and John XXIII. as popes rather than as antipopes, and accordingly count Gregory's pontificate from 1406 to 1409. Roman Catholic authorities, however, incline to the other reckoning.

See L. Pastor, *History of the Popes*, vol. i., trans. by F. I. Antrobus (London, 1899); M. Creighton, *History of the Papacy*, vol. 1 (London, 1899); N. Valois, *La France et le grand schisme d'Occident* (Paris, 1896-1902); Louis Gayet, *Le Grand Schisme d'Occident* (Paris, 1898); J. von Haller, *Papsttum u. Kirchenreform* (Berlin, 1903); J. Loserth, *Geschichte des späteren Mittelalters* (1903); *Theoderici de Nyem de schismate libri tres*, ed. by G. Erler (Leipzig, 1890). There is an excellent article by J. N. Brichar in the *Kirchenlexikon* 2nd ed., vol. 5. (C. H. H. A.)

GREGORY XIII. (*Ugo Buoncompagno*), pope from 1572 to 1585, was born on the 7th of January 1502, in Bologna, where he received his education, and subsequently taught, until called to Rome (1539) by Paul III., who employed him in various offices. He bore a prominent part in the council of Trent, 1562-1563. In 1564 he was made cardinal by Pius IV., and, in the following year, sent to Spain as legate. On the 13th of May 1572 he was chosen pope to succeed Pius V. His previous life had been rather worldly, and not wholly free from spot; but as pope he gave no occasion of offence. He submitted to the influence of the rigorists, and carried forward the war upon heresy, though not with the savage vehemence of his predecessor. However, he received the news of the massacre of St Bartholomew (23rd of August 1572) with joy, and publicly celebrated the event, having been led to believe, according to his apologists, that France had been miraculously delivered, and that the Huguenots had suffered justly as traitors. Having failed to rouse Spain and Venice against the Turks, Gregory attempted to form a general coalition against the Protestants. He subsidized Philip II. in his wars in the Netherlands; aided the Catholic League in France; incited attacks upon Elizabeth by way of Ireland. With the aid of the Jesuits, whose privileges he multiplied, he conducted a vigorous propaganda. He established or endowed above a score of colleges, among them the Collegium Romanum (founded by Ignatius Loyola in 1550), and the Collegium Germanicum, in Rome. Among his noteworthy achievements are the reform of the calendar on the 24th of February 1582 (see CALENDAR); the improved edition of the *Corpus juris canonici*, 1582; the splendid Gregorian Chapel in St Peter's; the fountains of the Piazza Navona; the Quirinal Palace; and many other public works. To meet the expenses entailed by his liberality and extravagance, Gregory resorted to confiscation, on the pretext of defective titles or long-standing arrears. The result was disastrous to the public peace: nobles armed in their defence; old feuds revived; the country became infested with bandits; not even in Rome could order be maintained. Amid these disturbances Gregory died, on the 10th of April 1585, leaving to his successor, Sixtus V., the task of pacifying the state.

See the contemporary lives by Cicarella, continuator of Platina, *De vitis pontif. Rom.*; Ciaconius, *Vitae et res gestae summorum pontif. Rom.* (Rome, 1601-1602); and Ciampi, *Comp. dell' attioni e svolta vita di Gregorio XIII* (Rome, 1591). See also Bompiano, *Hist. pontificatus Gregorii XIII.* (Rome, 1653); Ranke, *Papst (Eng. trans., Austin)*, i. 428 seq.; v. Reumont, *Gesch. der Stadt Rom*, iii. 2, 566 seq.; and for numerous references upon Gregory's relation to the massacre of St Bartholomew, *Cambridge Mod. Hist.* iii. 771 seq.

GREGORY XIV. (*Niccolò Sfondrato*), pope 1590-1591, was born in Cremona, on the 11th of February 1535, studied in Perugia, and Padua, became bishop of his native place in 1560, and took part in the council of Trent, 1562-1563. Gregory XIII. made him a cardinal, 1583, but ill-health forbade his active participation in affairs. His election to the papacy, to succeed Urban VII., on the 5th of December 1590, was due to Spanish influence. Gregory was upright and devout, but utterly ignorant of politics. During his short pontificate the States of the Church suffered dire calamities, famine, epidemic and a fresh outbreak of brigandage. Gregory was completely subservient to Philip II.; he aided the league, excommunicated Henry of Navarre, and threatened his adherents with the ban; but the effect of his intervention was only to rally the moderate Catholics to the support of Henry, and to hasten his conversion. Gregory died on the 15th of October 1591, and was succeeded by Innocent IX.

See Ciaconius, *Vitae et res gestae summorum pontif. Rom.* (Rome, 1601-1602); Cicarella, continuator of Platina, *De vitis pontif. Rom.* (both contemporary); Broch, *Gesch. des Kirchenstaates* (1880), i. 300; Ranke, *Papst* (Eng. trans., Austin), ii. 228 seq.

GREGORY XV. (*Alessandro Ludovisi*) was born on the 9th of January 1554, in Bologna, where he also studied and taught. He was made archbishop of his native place and cardinal by Paul V., whom he succeeded as pope on the 9th of February 1621. Despite his age and feebleness, Gregory displayed remarkable energy. He aided the emperor in the Thirty Years' War, and the king of Poland against the Turks. He endorsed the claims of Maximilian of Bavaria to the electoral dignity, and was rewarded with the gift of the Heidelberg library, which was carried off to Rome. Gregory founded the Congregation of the Propaganda, encouraged missions, fixed the order to be observed in conclaves, and canonized Ignatius Loyola, Francis Xavier, Philip Neri and Theresa de Jesus. He died on the 8th of July 1623, and was succeeded by Urban VIII.

See the contemporary life by Vitorelli, continuator of Ciaconius, *Vitae et res gestae summorum pontif. Rom.*; Ranke's excellent account, *Papst* (Eng. trans., Austin), ii. 468 seq.; v. Reumont, *Gesch. der Stadt Rom*, iii. 2, 609 seq.; Broch, *Gesch. des Kirchenstaates* (1880), i. 370 seq.; and the extended bibliography in Herzog-Hauck, *Realencyklopaedie*, s.v. "Gregor XV." (T. F. C.)

GREGORY XVI. (*Bartolomeo Alberto Cappellari*), pope from 1831 to 1846, was born at Belluno on the 18th of September 1765, and at an early age entered the order of the Camaldoli, among whom he rapidly gained distinction for his theological and linguistic acquirements. His first appearance before a wider public was in 1799, when he published against the Italian Jansenists a controversial work entitled *Il Trionfo della Santa Sede*, which, besides passing through several editions in Italy, has been translated into several European languages. In 1800 he became a member of the Academy of the Catholic Religion, founded by Pius VII., to which he contributed a number of memoirs on theological and philosophical questions and in 1805 was made abbot of San Gregorio on the Caelian Hill. When Pius VII. was carried off from Rome in 1809, Cappellari withdrew to Murano, near Venice, and in 1814, with some other members of his order, he removed to Padua; but soon after the restoration of the pope he was recalled to Rome, where he received successive appointments as vicar-general of the Camaldoli, councillor of the Inquisition, prefect of the Propaganda, and examiner of bishops. In March 1825 he was created cardinal by Leo XII., and shortly afterwards was entrusted with an important mission to adjust a concordat regarding the interests of the Catholics of Belgium and the Protestants of Holland. On the 2nd of February 1831 he was, after sixty-four days' conclave, unexpectedly chosen to succeed Pius VIII. in the papal chair. The revolution of 1830 had just inflicted a severe blow on the ecclesiastical party in France, and almost the first act of the new government there was to seize Ancona, thus throwing all Italy, and particularly the Papal States, into an excited condition which seemed to demand strongly repressive measures. In the course of the struggle which ensued it was more than once necessary to call in the Austrian bayonets. The reactionaries in power put off their promised reforms so persistently as to anger evch

Metternich; nor did the replacement of Berneti by Lambruschini in 1836 mend matters; for the new cardinal secretary of state objected even to railways and illuminating gas, and was liberal chiefly in his employment of spies and of prisons. The embarrassed financial condition in which Gregory left the States of the Church makes it doubtful how far his lavish expenditure in architectural and engineering works, and his magnificent patronage of learning in the hands of Mai, Mezzofanti, Gaetano, Moroni and others, were for the real benefit of his subjects. The years of his pontificate were marked by the steady development and diffusion of those ultramontane ideas which were ultimately formulated, under the presidency of his successor Pius IX., by the council of the Vatican. He died on the 1st of June 1846.

See A. M. Bernasconi, *Aeta Gregorii Papae XVI. scilicet constitutiones, bullae, litterae apostolicas, epistolae*, vols. 1-3 (Rome, 1901 ff.); Cardinal Wiseman, *Recollections of the Last Four Popes* (London, 1858); Herzog-Hauck, *Realencyclopädie*, vol. vii. (Leipzig, 1899), 127 ff. (gives literature); Frederic Nielsen, *History of the Papacy in the 19th Century*, ii. (London, 1906). (W. W. R.)

GREGORY,¹ the name of a Scottish family, many members of which attained high eminence in various departments of science, fourteen having held professorships in mathematics or medicine. Of the most distinguished of their number a notice is given below.

I. DAVID GREGORY (1627-1720), eldest son of the Rev. John Gregory of Drumoak, Aberdeenshire, who married Janet Anderson in 1621. He was for some time connected with a mercantile house in Holland, but on succeeding to the family estate of Kinarde returned to Scotland, and occupied most of his time in scientific pursuits, freely giving his poorer neighbours the benefit of his medical skill. He is said to have been the first possessor of a barometer in the north of Scotland; and on account of his success by means of it in predicting changes in the weather, he was accused of witchcraft before the presbytery of Aberdeen, but he succeeded in convincing that body of his innocence.

II. JAMES GREGORY (1638-1675), Scottish mathematician, younger brother of the preceding, was educated at the grammar school of Aberdeen and at Marischal College of that city. At an early period he manifested a strong inclination and capacity for mathematics and kindred sciences; and in 1663 he published his famous treatise *Optica promota*, in which he made known his great invention, the Gregorian reflecting telescope. About 1665 he went to the university of Padua, where he studied for some years, and in 1667 published *Veræ circuli et hyperbolæ quadratura*, in which he discussed infinite convergent series for the areas of the circle and hyperbola. In the following year he published also at Padua *Geometriæ pars universalis*, in which he gave a series of rules for the rectification of curves and the mensuration of their solids of revolution. On his return to England in this year he was elected a fellow of the Royal Society; in 1669 he became professor of mathematics in the university of St Andrews; and in 1674 he was transferred to the chair of mathematics in Edinburgh. In October 1675, while showing the satellites of the planet Jupiter to some of his students through one of his telescopes, he was suddenly struck with blindness, and he died a few days afterwards.

He was also the author of *Exercitationes geometricæ* (1668), and, it is alleged, of a satirical tract entitled *The Great and New Art of Weighing Vanity*, intended to ridicule certain fallacies of a contemporary writer on hydraulics, and published at Glasgow in 1672, professedly by "Patrick Mathers, archdeacon of the university of St Andrews."

III. DAVID GREGORY (1661-1708), son of David Gregory (1627-1720), was born in Aberdeen and educated partly in his native city and partly in Edinburgh, where he became professor of mathematics in 1683. From 1691 till his death he was Savilian professor of astronomy at Oxford. His principal works are *Exercitatio geometrica de dimensione figurarum* (1684), *Catoptricae et dioptricae sphaericae elementa* (1695), and *Astronomiæ physicae et geometricæ elementa* (1702)—the last a work highly esteemed by Sir Isaac Newton, of whose system it is an illustration and a defence. *A Treatise on Practical Geometry*

¹ See A. G. Stewart, *The Academic Gregories*.

which he left in manuscript was translated from the Latin and published in 1745. He was succeeded in the chair of mathematics in Edinburgh by his brother James; another brother, Charles, was in 1707 appointed professor of mathematics in the university of St Andrews; and his eldest son, David (1696-1767), became professor of modern history at Oxford, and canon and subsequently dean of Christ Church.

IV. JOHN GREGORY (1724-1773), Scottish physician, grandson of James Gregory (1638-1675) and youngest son of Dr James Gregory (d. 1731), professor of medicine in King's College, Aberdeen, was born at Aberdeen on the 3rd of June 1724. He received his early education at the grammar school of Aberdeen and at King's College in that city, and in 1741 he attended the medical classes at Edinburgh university. In 1745 he went to Leiden to complete his medical studies, and during his stay there he received without solicitation the degree of doctor of medicine from King's College, Aberdeen. On his return from Holland he was elected professor of philosophy at King's College, but in 1749 he resigned his professorship on account of its duties interfering too much with his private practice. In 1754 he proceeded to London, where he made the acquaintance of many persons of distinction, and the same year was chosen fellow of the Royal Society. On the death in November 1755 of his brother Dr James Gregory, who had succeeded his father as professor of medicine in King's College, Aberdeen, he was appointed to that office. In 1764 he removed to Edinburgh in the hope of obtaining a more extended field of practice as a physician, and in 1766 he was appointed professor of the practice of medicine in the university of Edinburgh, to whose eminence as a medical school he largely contributed. He died of gout on the 10th of February 1773.

He is the author of *A Comparative View of the State and Faculties of Man with those of the Animal World* (1765); *Observations on the Duties, Offices and Qualifications of a Physician* (1772); *Elements of the Practice of Physic* (1772); and *A Father's Legacy to his Daughters* (1774). His *Whole Works*, with a life by Mr Tytler (afterwards Lord Woodhouselee), were published at Edinburgh in 1788.

V. JAMES GREGORY (1753-1821), Scottish physician, eldest son of the preceding, was born at Aberdeen in January 1753. He accompanied his father to Edinburgh in 1764, and after going through the usual course of literary studies at that university, he was for a short time a student at Christchurch, Oxford. It was there probably that he acquired that taste for classical learning which afterwards distinguished him. He studied medicine at Edinburgh, and, after graduating doctor of medicine in 1774, spent the greater part of the next two years in Holland, France and Italy. Shortly after his return to Scotland he was appointed in 1776 to the chair his father had formerly held, and in the following year he also entered on the duties of teacher of clinical medicine in the Royal Infirmary. On the illness of Dr William Cullen in 1790 he was appointed joint-professor of the practice of medicine, and he became the head of the Edinburgh Medical School on the death of Dr Cullen in the same year. He died on the 2nd of April 1821. As a medical practitioner Gregory was for the last ten years of his life at the head of the profession in Scotland. He was at one time president of the Edinburgh College of Physicians, but his indiscretion in publishing certain private proceedings of the college led to his suspension on the 13th of May 1809 from all rights and privileges which pertained to the fellowship.

Besides his *Conspectus medicinae theoreticae*, published in 1788 as a text-book for his lectures on the institutes, Dr Gregory was the author of "A Theory of the Moods of Verbs," published in the *Edin. Phil. Trans.* (1787), and of *Literary and Philosophical Essays*, published in two volumes in 1792.

VI. WILLIAM GREGORY (1803-1858), son of James Gregory (1753-1821), was born on the 25th of December 1803. In 1837 he became professor of chemistry at the Andersonian Institution, Glasgow, in 1839 at King's College, Aberdeen, and in 1844 at Edinburgh University. He died on the 24th of April 1858. Gregory was one of the first in England to advocate the theories of Justus von Liebig, and translated several of his works. He is also the author of *Outlines of Chemistry* (1845), and an *Elementary Treatise on Chemistry*. (J. S. J.)

VII. **DUNCAN FARQUHARSON GREGORY** (1813-1844), brother of the preceding, was born on the 13th of April 1813. After studying at the university of Edinburgh he in 1833 entered Trinity College, Cambridge, where he was for a time assistant professor of chemistry, but he devoted his attention chiefly to mathematics. He died on the 23rd of February 1844.

The *Cambridge Mathematical Journal* was originated, and for some time edited, by him; and he also published a *Collection of Examples of Processes in the Differential and Integral Calculus* (1841). A *Treatise on the Application of Analysis to Solid Geometry*, which he left unfinished, was completed by W. Walton, and published posthumously in 1846. His *Mathematical Writings*, edited by W. Walton, with a biographical memoir by Robert Leslie Ellis, appeared in 1865.

GREGORY, EDWARD JOHN (1850-1909), British painter, born at Southampton, began work at the age of fifteen in the engineer's drawing office of the Peninsular and Oriental Company. Afterwards he studied at South Kensington, and about 1871 entered on a successful career as an illustrator and as an admirable painter in oil and water colour. He was elected associate of the Royal Academy in 1883, academician in 1898, and president of the Royal Institute of Painters in Water Colours in 1898. His work is distinguished by remarkable technical qualities, by exceptional firmness and decision of draughtsmanship and by unusual certainty of handling. His "Marooned," a water colour, is in the National Gallery of British Art. Many of his pictures were shown at Burlington House at the winter exhibition of 1909-1910 after his death in June 1909.

GREGORY, OLIVIERUS GILBERT (1774-1841), English mathematician, was born on the 29th of January 1774 at Yaxley in Huntingdonshire. Having been educated by Richard Weston, a Leicester botanist, he published in 1793 a treatise, *Lectures Astronomical and Philosophical*. Having settled at Cambridge in 1796, Gregory first acted as sub-editor on the *Cambridge Intelligencer*, and then opened a bookseller's shop. In 1802 he obtained an appointment as mathematical master at Woolwich through the influence of Charles Hutton, to whose notice he had been brought by a manuscript on the "Use of the Sliding Rule"; and when Hutton resigned in 1807 Gregory succeeded him in the professorship. Failing health obliged him to retire in 1838, and he died at Woolwich on the 2nd of February 1841.

Gregory wrote *Hints for the Use of Teachers of Elementary Mathematics* (1840, new edition 1853), and *Mathematics for Practical Men* (1825), which was revised and enlarged by Henry Law in 1848, and again by J. R. Young in 1862. His *Letters on the Evidences of Christianity* (1815) have been several times reprinted, and an abridgement was published by the Religious Tract Society in 1853. He will probably be longest remembered for his *Biography of Robert Hall*, which first appeared in the collected edition of Hall's works, was published separately in 1833, and has since passed through several editions. The minor importance of his *Memoir of John Mason Good* (1828) is due to the narrower fame of the subject. Gregory was one of the founders of the Royal Astronomical Society. In 1802 he was appointed editor of the *Gentlemen's Diary*, and in 1818 editor of the *Ladies' Diary* and superintendent of the almanacs of the Stationers' Company.

GREIFENBERG, a town of Germany, in the Prussian province of Pomerania, on the Rega, 45 m. N.E. of Stettin on the railway to Kolberg. Pop. (1905) 7208. It has two Evangelical churches (among them that of St Mary, dating from 13th century), two ancient gateways, a powder tower and a gymnasium. The manufacture of machines, stoves and bricks are the principal industries. Greifenberg possessed municipal rights as early as 1262, and in the 14th and 15th centuries had a considerable shipping trade, but it lost much of its prosperity during the Thirty Years' War.

See Riemann, *Geschichte der Stadt Greifenberg* (1862).

GREIFENHAGEN, a town of Germany, in the Prussian province of Pomerania, on the Reglitz, 12 m. S.S.W. of Stettin by rail. Pop. (1905) 6473. Its prosperity depends chiefly on agriculture and it has a considerable trade in cattle. There are also felt manufactures and saw mills. Greifenhagen was built in 1230, and was raised to the rank of a town and fortified about 1250. In the Thirty Years' War it was taken both by the imperialists and the Swedes, and in 1675 it was captured by the Brandenburgers, into whose possession it came finally in 1679.

GREIFSWALD, a town of Germany, in the Prussian province of Pomerania, on the navigable Ryk, 3 m. from its mouth on the Baltic at the little port of Wyk, and 20 m. S.E. from Stralsund by rail. Pop. (1875) 18,022, (1905) 23,750. It has wide and regular streets, flanked by numerous gabled houses, and is surrounded by pleasant promenades on the site of its old ramparts. The three Gothic Protestant churches, the Marienkirche, the Nikolaikirche and the Jakobikirche, and the town-hall (Rathaus) are the principal edifices, and these with their lofty spires are very picturesque. There is a statue of the emperor Frederick III. and a war memorial in the town. The industries mainly consist in shipbuilding, fish-curing, and the manufacture of machinery (particularly for agriculture), and the commerce in the export of corn, wood and fish. There is a theatre, an orphanage and a municipal library. Greifswald is, however, best known to fame by reason of its university. This, founded in 1456, is well endowed and is largely frequented by students of medicine. Connected with it are a library of 150,000 volumes and 800 MSS., a chemical laboratory, a zoological museum, a gynaecological institute, an ophthalmological school, a botanical garden and at Eldena (a seaside resort on the Baltic) an agricultural school. In front of the university, which had 775 students and about 100 teachers in 1904, stands a monument commemorating its four hundredth anniversary.

Greifswald was founded about 1240 by traders from the Netherlands. In 1290 it received a town constitution and Lübeck rights from Duke Wratlaw of Pomerania. In 1290 it joined the Hanse towns, Stralsund, Rostock, Wismar and Lübeck, and took part in the wars which they carried on against the kings of Denmark and Norway. During the Thirty Years' War it was formed into a fortress by the imperialists, but they vacated it in 1631 to the Swedes, in whose possession it remained after the peace of Westphalia. In 1678 it was captured by the elector of Brandenburg, but was restored to the Swedes in the following year; in 1713 it was desolated by the Russians; in 1715 it came into the possession of Denmark; and in 1721 it was again restored to Sweden, under whose protection it remained till 1815, when, along with the whole of Swedish Pomerania, it came into the possession of Prussia.

See J. G. L. Kosegarten, *Geschichte der Universität Greifswald* (1856); C. Gesterding, *Beitrag zur Geschichte der Stadt Greifswald* (3 vols., 1827-1829); and I. Ziegler, *Geschichte der Stadt Greifswald* (Greifswald, 1897).

GREISEN (in French, *hyalomite*), a modification of granite, consisting essentially of quartz and white mica, and distinguished from granite by the absence of feldspar and biotite. In the hand specimen the rock has a silvery glittering appearance from the abundance of lamellar crystals of muscovite, but many greisen have much of the appearance of granite, except that they are paler in colour. The commonest accessory minerals are tourmaline, topaz, apatite, fluorspar and iron oxides; a little feldspar more or less altered may also be present and a brown mica which is biotite or lithionite. The tourmaline in section is brown, green, blue or colourless, and often the same crystal shows many different tints. The white mica forms mostly large plates with imperfect crystalline outlines. The quartz is rich in fluid enclosures. Apatite and topaz are both colourless and of irregular form. Feldspar if present may be orthoclase and oligoclase.

Greisen occurs typically in belts or veins intersecting granite. At the centre of each vein there is usually a fissure which may be open or filled with quartz. The greisen bands are from 1 in. up to 2 ft. or more in thickness. At their outer edges they pass gradually into the granite, for they contain feldspar crystals more or less completely altered into aggregates of white mica and quartz. The transition between the two rocks is perfectly gradual, a fact which shows that the greisen has been produced by alteration of the granite. Vapours or fluids rising through the fissure have been the agents which effected the transmutation. They must have contained fluorine, boron and probably also lithium, for topaz, mica and tourmaline, the new minerals of the granite, contain these elements. The change is a post-volcanic

or pneumatolytic one induced by the vapours set free by the granite magma when it cools. Probably the rock was at a relatively high temperature at the time. A similar type of alteration, the development of white mica, quartz and tourmaline, is found sometimes in sedimentary rocks around granite masses. Greisen is closely connected with schorl rock both in its mineralogical composition and in its mode of origin. The latter is a pneumatolytic product consisting of quartz and tourmaline; it often contains white mica and thus passes by all stages into greisen. Both of these rocks carry frequently small percentages of tin oxide (cassiterite) and may be worked as ores of tin. They are common in Cornwall, Saxony, Tasmania and other districts which are centres of tin-mining. Many other greisens occur in which no tin is found. The analyses show the composition

	SiO ₂	Al ₂ O ₃	Fe ₂ O ₃	FeO	CaO	MgO	K ₂ O	Na ₂ O	Fl.	B ₂ O ₃
Granite	70.17	15.07	.88	1.79	1.13	1.11	5.73	2.69	.15	tr.
Greisen	69.42	15.65	1.25	3.30	.63	1.02	4.06	.27	3.36	.59

of Cornish granite and greisen. They make it clear that there has been an introduction of fluorine and boron and a diminution in the alkalis during the transformation of the granitic rock into the greisen.

(J. S. F.)

GREIZ, a town of Germany, capital of the principality of Reuss-Greiz (Reuss the Elder), in a pleasant valley on the right bank of the White Elster, near the borders of Saxony, and 66 m. by rail S. from Leipzig. Pop. (1875) 12,657; (1905) 23,114. It consists of two parts, the old town on the right bank and the new town on the left bank of the river; it is rapidly growing and is regularly laid out. The principal buildings are the palace of the prince of Reuss-Greiz, surrounded by a fine park, the old chateau on a rocky hill overlooking the town, the summer palace with a fine garden, the old town church dating from 1225 and possessing a beautiful tower, the town hall, the governmental buildings and statues of the emperor William I. and of Bismarck. There are classical and modern schools and a school of textile industry. The industries are considerable, and include dyeing, tanning and the manufacture of woollen, cotton, shawls, coverlets and paper. Greiz (formerly *Grewca*) is apparently a town of Slav origin. From the 12th century it was governed by *advocati* (*Vögte*), but in 1236 it came into the possession of Gera, and in 1550 of the younger line of the house of Plauen. It was wholly destroyed by fire in 1494, and almost totally in 1802.

See Wilke, *Greiz und seine Umgebung* (1875), and *Jahresberichte des Vereins für Greizer Geschichte* (1894, seq.).

GRENADA, the southernmost of the Windward Islands, British West Indies. It lies between 11° 58' and 12° 15' N. and between 61° 35' and 62° 50' W., being 140 m. S.W. of Barbados and 85 m. N. by W. of Trinidad. In shape oval, it is 21 m. long, 12 m. broad at its maximum and has an area of 133 sq. m. It owes much of its beauty to a well-wooded range of mountains traversing the island from N. to S. and throwing off from the centre spurs which form picturesque and fertile valleys. These mountains attain their highest elevation in Mount Catharine (2750 ft.). In the S.E. and N.W. there are stretches of low or undulating ground, devoted to fruit growing and cattle raising. The island is of volcanic origin; the only signs of upheaval are raised limestone beaches in the extreme N. Red and grey sandstones, hornblende and argillaceous schist are found in the mountains, porphyry and basaltic rocks also occur; sulphur and fuller's earth are worked. In the centre, at the height of 1740 ft. above the sea, is the chief natural curiosity of Grenada, the Grand Etang, a circular lake, 13 acres in extent, occupying the site of an ancient crater. Near it is a large sanatorium, much frequented as a health resort. In the north-east is a larger lake, Lake Antoine, also occupying a crater, but it lies almost at the sea level. The island is watered by several short rivers, mainly on the east and south; there are numerous fresh water springs, as well as hot chalybeate and sulphurous springs. The south-eastern coast is much indented with bays. The climate is good,

the temperature equable and epidemic diseases are rare. In the low country the average yearly temperature is 82° F., but it is cooler in the heights. The rainfall is very heavy, amounting in some parts to as much as 200 in., a year. The rainy season lasts from May to December, but refreshing showers frequently occur during other parts of the year. The average annual rainfall at St Georges is 79.07 in., and at Grand Etang 164 in. The excellent climate and good sea-bathing have made Grenada the health resort of the neighbouring islands, especially of Trinidad. Good roads and byways intersect it in every direction. The soil is extraordinarily fertile, the chief products being cocoa and spices, especially nutmegs. The exports, sent chiefly to Great Britain, are cocoa, spices, wool, cotton, coffee, live stock, hides, turtles, turtle shell, kola nuts, vanilla and timber. Barbados is dependent on Grenada for the majority of its firewood. Sugar is still grown, and rum and molasses are made, but the consumption of these is confined to the island.

Elementary education is chiefly in the hands of the various denominations, whose

schools are assisted by government grants-in-aid. There are, however, a few secular schools conducted by the government, and government-aided secondary schools for girls and a grammar school for boys. The schools are controlled by a board of education, the members of which are nominated by the government, and small fees are charged in all schools. The governor of the Windward Islands resides in Grenada and is administrator of it. The Legislative Council consists of 14 members; 7 including the governor are *ex-officio* members and the rest are nominated by the Crown. English is universally spoken, but the negroes use a French *patois*, which, however, is gradually dying out. Only 2% of the inhabitants are white, the rest being negroes and mulattoes with a few East Indians. The capital, St George, in the south-west, is built upon a lava peninsula jutting into the sea and forming one side of its land-locked harbour. It is surrounded by an amphitheatre of hills, up the sides of which climb the red-brick houses of the town. At the extremity of the peninsula is Fort St George, with a saluting battery. The ridge connecting Fort St George with Hospital Hill is tunnelled to give access to the two parts of the town lying on either side. The population in 1901 was 5198. There are four other towns—on the west coast Gouyave, or Charlotte Town, and 4 m. N. of it Victoria; on the north coast Sauteurs; and Grenville at the head of a wide bay on the east. They are all in frequent communication with the capital by steamer. The population of the entire colony in 1901 was 63,438.

History.—Grenada was discovered in 1498 by Columbus, who named it Conception. Neither the Spanish nor the British, to whom it was granted in 1627, settled on the island. The governor of Martinique, du Parquet, purchased it in 1650, and the French were well received by the Caribs, whom they afterwards extirpated with the greatest cruelty. In 1665 Grenada passed into the hands of the French West India Company, and was administered by it until its dissolution in 1674, when the island passed to the French Crown. Cocoa, coffee and cotton were introduced in 1714. During the wars between Great Britain and France, Grenada capitulated to the British forces in 1762, and was formally ceded next year by the Treaty of Paris. The French, under Count d'Estaing, re-captured the island in 1779, but it was restored to Great Britain by the Treaty of Versailles in 1783. A rebellion against the British rule, instigated and assisted by the French, occurred in 1795, but was quelled by Sir Ralph Abercromby in the following year. The emancipation of the slaves took place in 1837, and by 1877 it was found necessary to introduce East Indian labour. Grenada, with cocoa as its staple, has not experienced similar depression to that which overtook the sugar-growing islands of the West Indies.

See *Grenada Handbook* (London, 1905).

GRENADA (from the French word for a pomegranate, from a resemblance in shape to that fruit), a small spherical explosive vessel thrown by hand. Hand-grenades were used in war in the 16th century, but the word "grenade" was also from the

first used to imply an explosive shell fired from a gun; this survives to the present day in the German *Grenade*. These weapons were employed after about 1660, by special troops called "grenadiers" (q.v.), and in the wars of the 17th and 18th centuries they are continually met with. They became obsolete in the 19th century, but were given a new lease of life in the 20th, owing to their employment in the siege of Port Arthur in 1904, where hand-grenades of a modern type, and containing powerful modern explosives, proved very effective (see АММУНИЦИОН, *Shell*). Hand-grenades filled with chemicals and made of glass are used as a method of fire-extinction, and similar vessels containing a liquid with a very strong smell are used to discover defects in a drain or sewer.

GRENADIER, originally a soldier whose special duty it was to throw hand-grenades. The latter were in use for a considerable time before any special organization was given to the troops who were to use them. In 1667 four men per company in the French *Régiment du Roi* were trained with grenades (siege of Lille), and in 1668-1670 grenadier companies were formed in this regiment and in about thirty others of the French line. Evelyn, in his *Diary*, tells us that on the 29th of June 1678 he saw at Hounslow "a new sort of soldiers called granadiers, who were dexterous in flinging hand-grenades." As in the case of the fusiliers, the French practice was therefore quickly copied in England. Eventually each English battalion had a grenadier company (see for illustrations *Archaeological Journal*, xliii. 222, and xlvii. 321-324). Besides their grenades and the firelock, grenadiers carried axes which, with the grenades, were employed in the assault of fortresses, as we are told in the celebrated song, "The British Grenadiers."

The grenadier companies were formed always of the most powerful men in the regiment and, when the grenade ceased to be used, they maintained their existence as the "crack" companies of their battalions, taking the right of the line on parade and wearing the distinctive grenadier headdress. This system was almost universal, and the typical infantry regiment of the 18th and early 19th century had a grenadier and a light company besides its "line" companies. In the British and other armies these *élite* companies were frequently taken from their regiments and combined in grenadier and light infantry battalions for special service, and Napoleon carried this practice still further in the French army by organizing brigades and divisions of grenadiers (and correspondingly of *volligeurs*). Indeed the companies thus detached from the line practically never returned to it, and this was attended with serious evils, for the battalion at the outbreak of war lost perhaps a quarter of its best men, the average men only remaining with the line. This special organization of grenadiers and light companies lasted in the British army until about 1858. In the Prussian service the grenadiers became permanent and independent battalions about 1740, and the gradual adoption of the four-company battalion by Prussia and other nations tended still further to place the grenadiers by themselves and apart from the line. Thus at the present day in Germany, Russia and other countries, the title of "grenadiers" is borne by line regiments, indistinguishable, except for details of uniform and often the *esprit de corps* inherited from the old *élite* companies, from the rest. In the British service the only grenadiers remaining are the Grenadier Guards, originally the 1st regiment of Foot Guards, which was formed in 1660 on the nucleus of a regiment of English royalists which followed the fortunes of Charles II. in exile. In Russia a whole army corps (headquarters Moscow), inclusive of its artillery units, bears the title.

The special headdress of the grenadier was a pointed cap, with peak and flaps, of embroidered cloth, or a loose fur cap of similar shape; both these were light field service caps. The fur cap has in the course of time developed into the tall "bearskin" worn by British guards and various corps of other armies; the embroidered field cap survives, transformed, however, into a heavy brass headdress, in the uniform of the 1st Prussian Foot Guards, the 1st Prussian Guard Grenadiers and the Russian Paul (Pavlovsky) Grenadier Guards.

GRENADINES, a chain of islets in the Windward Islands, West Indies. They stretch for 60 m. between St Vincent and Grenada, following a N.E. to S.W. direction, and consist of some 600 islets and rocks. Some are a few square miles in extent, others are merely rocky cones projecting from the deep. For purposes of administration they are divided between St Vincent and Grenada. Bequia, the chief island in the St Vincent group, is long and narrow, with an area 6 sq. m. Owing to a lack of water it is only slightly cultivated, but game is plentiful. Admiralty Bay, on the W. side, is a safe and commodious harbour. Carriacou, belonging to Grenada, is the largest of the group, being 7 m. long, 2 m. wide and 13 sq. m. in extent. A ridge of hills, rising to an altitude of 700 ft., traverses the centre from N.E. to S.W.; here admirable building stone is found. There are two good harbours on the west coast, Hillsborough Bay on which stands Hillsborough, the chief town, and Tyrrell Bay, farther south. The island is thickly populated, the negro peasantry occupying small lots and working on the *metayer* system. Excellent oysters are found along the coast, and cotton and cattle are the chief exports. Pop. of the group, mostly on Carriacou (1901) 6497.

GRENOBLE, the ancient capital of the Dauphiné in S.E. France, and now the chief town of the Isère department, 75 m. by rail from Lyons, 38½ m. from Chambéry and 85½ m. from Gap. Pop. (1906), town, 58,641; commune, 73,022. It is one of the most beautifully situated, and also one of the most strongly fortified, cities in Europe. Built at a height of 702 ft. on both banks of the river Isère just above its junction with the Drac, the town occupies a considerable plain at the south-western end of the fertile Graisivaudan valley. To the north rise the mountains of the Grande Chartreuse, to the east the range of Belledonne, and to the south those of Taillefer and the Moucherotte, the higher summits of these ranges being partly covered with snow. From the Jardin de Ville and the quays of the banks of the Isère the summit of Mont Blanc itself is visible. The greater part of the town rises on the left bank of the Isère, which is bordered by broad quays. The older portion has the tortuous and narrow streets usual in towns that have been confined within fortifications, but in modern times these hindrances have been demolished. The newer portion of the town has wide thoroughfares and buildings of the modern French type, solid but not picturesque. The original town (of but small extent) was built on the right bank of the Isère at the southern foot of the Mont Rachais, now covered by a succession of fortresses that rise picturesquely on the slope of that hill to a very considerable height (885 ft. above the town).

Grenoble is the seat of a bishopric which was founded in the 4th century, and now comprises the department of the Isère—formerly a suffragan of Vienne it now forms part of the ecclesiastical province of Lyons. The most remarkable building in the town is the Palais de Justice, erected (late 15th century to 16th century) on the site of the old palace of the Parlement of the Dauphiné. Opposite is the most noteworthy church of the city, that of St André (13th century), formerly the chapel of the dauphins of the Viennois: in it is the 17th century monument of Bayard (1476-1524), the *chevalier sans peur et sans reproche*, which was removed hither in 1822; but it is uncertain whose bones are therein. The cathedral church of Notre Dame is a heavy building, dating in part from the 11th century. The church of St Laurent, on the right bank of the Isère, is the oldest in the city (11th century) and has a remarkable crypt, dating from Merovingian times. The town hall is a mainly modern building, constructed on the site of the palace of the dauphins; while the prefecture is entirely modern. The town library contains a considerable collection of paintings, mainly of the modern French school, but is more remarkable for its very rich collection of MSS. (7000) and printed books (250,000 vols.) which in great part belonged till 1793 to the monastery of the Grande Chartreuse. The natural history museum houses rich collections of various kinds, which contain (*inter alia*) numerous geological specimens from the neighbouring districts of the Dauphiné and Savoy. The university, revived in modern times

after a long abeyance, occupies a modern building, as does also the hospital, though founded as far back as the 15th century. There are numerous societies in the town, including the Académie Delphinale (founded in 1772), and many charitable institutions.

The staple industry of Grenoble is the manufacture of kid gloves, most of the so-called *gants Jovain* being made here—they are named after the reviver of the art, X. Jouvin (1800-1844). There are about 80 glove factories, which employ 18,500 persons (of whom 15,000 are women), the annual output being about 800,000 dozen pairs of gloves. Among other articles produced at Grenoble are artificial cements, liqueurs, straw hats and carved furniture.

Grenoble occupies the site of Cularo, a village of the Allobroges, which only became of importance when fortified by Diocletian and Maximian at the end of the 3rd century. Its present name is a corruption of Gratianopolis, a title assumed probably in honour of Gratian (4th century), who raised it to the rank of a *ciuitas*. After passing under the power of the Burgundians (c. 440) and the Franks (532) it became part of the kingdom of Provence (879-1032). On the break-up of that kingdom a long struggle for supremacy ensued between the bishops of the city and the counts of Albon, the latter finally winning the day in the 12th century, and taking the title of Dauphins of the Viennois in the 13th century. In 1349 Grenoble was ceded with the rest of the Dauphiné to France, but retained various municipal privileges which had been granted by the dauphins to the town, originally by a charter of 1242. In 1562 it was sacked by the Protestants under the baron des Adrets, but in 1572 the firmness of its governor, Bertrand de Gordes, saved it from a repetition of the Massacre of St Bartholomew. In 1590 Lesdiguières (1543-1626) took the town in the name of Henry IV., then still a Protestant, and during his long governorship (which lasted to his death) did much for it by the construction of fortifications, quays, &c. In 1788 the attempt of the king to weaken the power of the parlement of Grenoble (which, though strictly a judicial authority, had preserved traditions of independence, since the suspension of the states-general of the Dauphiné in 1628) roused the people to arms, and the "day of the tiles" (7th of June 1788) is memorable for the defeat of the royal forces. In 1790, on the formation of the department of the Isère, Grenoble became its capital. Grenoble was the first important town to open its gates to Napoleon on his return from Elba (7th of March 1815), but a few months later (July) it was obliged to surrender to the Austrian army. Owing to its situation Grenoble was formerly much subject to floods, particularly in the case of the wild Drac. One of the worst took place in 1219, while that of 1778 was known as the *déuge de la Saint Crépin*. Among the celebrities who have been born at Grenoble are Vaucanson (1709-1782), Mably (1709-1785), Condillac (1715-1780), Beyle, best known as Stendhal, his *nom de guerre* (1783-1842), Barnave (1761-1793) and Casimir Perier (1777-1832).

See A. Frudhomme, *Histoire de Grenoble* (1888); X. Roux, *La Corporation des gantiers de Grenoble* (1887); H. Duhamel, *Grenoble considéré comme centre d'excursions* (1902); J. Marion, *Cartulaires de l'église cathédrale de Grenoble* (Paris, 1869). (W. A. B. C.)

GRENVILLE, SIR BEVIL (1596-1643), Royalist soldier in the English Civil War (see GREAT REBELLION), was educated at Exeter College, Oxford. As member of Parliament, first for Cornwall, then for Launceston, Grenville supported Sir John Eliot and the opposition, and his intimacy with Eliot was lifelong. In 1639, however, he appears as a royalist going to the Scottish War in the train of Charles I. The reasons of this change of front are unknown, but Grenville's honour was above suspicion, and he must have entirely convinced himself that he was doing right. At any rate he was a very valuable recruit to the royalist cause, being "the most generally loved man in Cornwall." At the outbreak of the Civil War he and others of the gentry not only proclaimed the king's Commission of Array at Launceston assizes, but also persuaded the grand jury of the county to declare their opponents guilty of riot and unlawful assembly, whereupon the *Posse comitatus* was called out to expel them. Under the command of Sir Ralph Hopton, Sir Bevil took a

distinguished part in the action of Bradock Down, and at Stratton (16 May 1643), where the parliamentary earl of Stamford was completely routed by the Cornishmen, led one of the storming parties which captured Chudleigh's lines (*Clarendon*, vii. 89). A month later, the endeavour of Hopton to unite with Maurice and Hertford from Oxford brought on the battle of Lansdown, near Bath. Here Grenville was killed at the head of the Cornish infantry as it reached the top of the hill. His death was a blow from which the king's cause in the West never recovered, for he alone knew how to handle the Cornishmen. Hopton they revered and respected, but Grenville they loved as peculiarly their own commander, and after his death there is little more heard of the reckless valour which had won Stratton and Lansdown. Grenville is the type of all that was best in English royalism. He was neither rapacious, drunken nor dissolute, but his loyalty was unselfish, his life pure and his skill no less than his bravery unquestionable. A monument to him has been erected on the field of Lansdown.

See Lloyd, *Memoirs of Excellent Personages* (1668); S. R. Gardiner, *History of the English Civil War* (vol. i. *passim*).

GRENVILLE, GEORGE (1712-1770), English statesman, second son of Richard Grenville and Hester Temple, afterwards Countess Temple, was born on the 14th of October 1712. He was educated at Eton and at Christ Church, Oxford, and was called to the bar in 1735. He entered parliament in 1741 as member for Buckingham, and continued to represent that borough till his death. In parliament he was a member of the "Boy Patriot" party which opposed Sir Robert Walpole. In December 1744 he became a lord of the admiralty in the Pelham administration. He allied himself with his brother Richard and with William Pitt in forcing their feeble chief to give them promotion by rebelling against his authority and obstructing business. In June 1747 he became a lord of the treasury, and in 1754 treasurer of the navy and privy councillor. As treasurer of the navy in 1758 he introduced and carried a bill which established a less unfair system of paying the wages of the seamen than had existed before. He remained in office in 1761, when his brother Lord Temple and his brother-in-law Pitt resigned upon the question of the war with Spain, and in the administration of Lord Bute he was entrusted with the leadership of the House of Commons. In May 1762 he was appointed secretary of state, and in October first lord of the admiralty; and in April 1763 he became first lord of the treasury and chancellor of the exchequer. The most prominent measures of his administration were the prosecution of Wilkes and the passing of the American Stamp Act, which led to the first symptoms of alienation between America and the mother country. During the latter period of his term of office he was on a very unsatisfactory footing with the young king George III., who gradually came to feel a kind of horror of the interminable persistency of his conversation, and whom he endeavoured to make use of as the mere puppet of the ministry. The king made various attempts to induce Pitt to come to his rescue by forming a ministry, but without success, and at last had recourse to the marquis of Rockingham, on whose agreeing to accept office Grenville was dismissed July 1765. He never again held office, and died on the 13th of November 1770.

The nickname of "gentle shepherd" was given him because he bored the House by asking over and over again, during the debate on the Cider Bill of 1763, that somebody should tell him "where" to lay the new tax if it was not to be put on cider. Pitt whistled the air of the popular tune "Gentle Shepherd, tell me where," and the House laughed. Though few excelled him in a knowledge of the forms of the House or in mastery of administrative details, his tact in dealing with men and with affairs was so defective that there is perhaps no one who has been at the head of an English administration to whom a lower place can be assigned as a statesman.

In 1749 he married Elizabeth, daughter of Sir William Wyndham, by whom he had a large family. His son, the second Earl Temple, was created marquis, and his grandson duke, of Buckingham. Another son was William, afterwards Lord

Grenville. Another, Thomas Grenville (1735-1846), who was, with one interval, a member of parliament from 1780 to 1818, and for a few months during 1806 and 1807 president of the board of control and first lord of the admiralty, is perhaps more famous as a book-collector than as a statesman; he bequeathed his large and valuable library to the British Museum.

The Grenville Papers, being the Correspondence of Richard Grenville, Earl Temple, K.G., and the Right Hon. George Grenville, their Friends and Contemporaries, were published at London in 1852, and afford the chief authority for his life. But see also H. Walpole's *Memoirs of the Reign of George II.* (London, 1845); Lord Stanhope's *History of England* (London, 1858); Lecky's *History of England* (1885); and E. D. Adams, *The Influence of Grenville on Pitt's Foreign Policy* (Washington, 1904).

GRENVILLE (or **GREYNVIL**), **SIR RICHARD** (c. 1541-1591), British naval commander, was born of an old Cornish family about 1541. His grandfather, Sir Richard, had been marshal of Calais in the time of Henry VIII., and his father commanded and was lost in the "Mary Rose" in 1545. At an early age Grenville is supposed to have served in Hungary under the emperor Maximilian against the Turks. In the years 1571 and 1584 he sat in parliament for Cornwall, and in 1583 and 1584 he was commissioner for the works at Dover harbour. He appears to have been a man of much pride and ambition. Of his bravery there can be no doubt. In 1585 he commanded the fleet of seven vessels by which the colonists sent out by his cousin, Sir Walter Raleigh, were carried to Roanoke Island in the present North Carolina. Grenville himself soon returned with the fleet to England, capturing a Spanish vessel on his way, but in 1586 he carried provisions to Roanoke, and finding the colony deserted, left a few men to maintain possession. He then held an important post in charge of the defences of the western counties of England. When a squadron was despatched in 1591, under Lord Thomas Howard, to intercept the homeward-bound treasure-fleet of Spain, Grenville was appointed as second in command on board the "Revenge," a ship of 500 tons which had been commanded by Drake against the Armada in 1588. At the end of August Howard with 16 ships lay at anchor to the north of Flores in the Azores. On the last day of the month he received news from a pinnace, sent by the earl of Cumberland, who was then off the Portugal coast, that a Spanish fleet of 53 vessels was then bearing up to the Azores to meet the treasure-ships. Not being in a position to fight a fleet more than three times the size of his own, Howard gave orders to weigh anchor and stand out to sea. But, either from some misunderstanding of the order, or from some idea of Grenville's that the Spanish vessels rapidly approaching were the ships for which they had been waiting, the "Revenge" was delayed and cut off from her consorts by the Spaniards. Grenville resolved to try to break through the middle of the Spanish line. His ship was becalmed under the lee of a huge galleon, and after a hand-to-hand fight lasting through fifteen hours against fifteen Spanish ships and a force of five thousand men, the "Revenge" with her hundred and fifty men was captured. Grenville himself was carried on board the Spanish flag-ship "San Pablo," and died a few days later. The incident is commemorated in Tennyson's ballad of "The Revenge."

The spelling of Sir Richard's name has led to much controversy. Four different families, each of which claim to be descended from him, spell it Granville, Grenville, Grenfell and Greenfield. The spelling usually accepted is Grenville, but his own signature, in a bold clear handwriting, among the Tanner MSS. in the Bodleian library at Oxford, is Greynvile.

GRENVILLE (or **GRANVILLE**), **SIR RICHARD** (1600-1658), English royalist, was the third son of Sir Bernard Grenville (1559-1636), and a grandson of the famous seaman, Sir Richard Grenville. Having served in France, Germany and the Netherlands, Grenville gained the favour of the duke of Buckingham, took part in the expeditions to Cadiz, to the island of Rhé and to La Rochelle, was knighted, and in 1628 was chosen member of parliament for Fowey. Having married Mary Fitz (1596-1671), widow of Sir Charles Howard (d. 1622) and a lady of fortune, Grenville was made a baronet in 1630; his violent temper, however, made the marriage an unhappy one, and he was seized

and imprisoned as the result of two lawsuits, one with his wife, and the other with her kinsman, the earl of Suffolk. In 1633 he escaped from prison and went to Germany, returning to England six years later to join the army which Charles I. was collecting to march against the Scots. Early in 1641, just after the outbreak of the Irish rebellion, Sir Richard led some troops to Ireland, where he won some fame and became governor of Trim, then returning to England in 1643 he was arrested at Liverpool by an officer of the parliament, but was soon released and sent to join the parliamentary army. Having, however, secured men and money, he hurried to Charles I. at Oxford and was despatched to take part in the siege of Plymouth, quickly becoming the leader of the forces engaged in this enterprise. Compelled to raise the siege he retired into Cornwall, where he helped to resist the advancing Parliamentarians; but he quickly showed signs of insubordination, and, whilst sharing in the siege of Taunton, he was wounded and obliged to resign his command. About this time loud complaints were brought against Grenville. He had behaved, it was said, in a very arbitrary fashion; he had hanged some men and imprisoned others; he had extorted money and had used the contributions towards the cost of the war for his own ends. Many of these charges were undoubtedly true, but upon his recovery the councillors of the prince of Wales gave him a position under Lord Goring, whom, however, he refused to obey. Equally recalcitrant was his attitude towards Goring's successor, Sir Ralph Hopton, and in January 1646 he was arrested. But he was soon released; he went to France and Italy, and after visiting England in disguise passed some time in Holland. He was excepted by parliament from pardon in 1648, and after the king's execution he was with Charles II. in France and elsewhere until some unfounded accusation which he brought against Edward Hyde, afterwards earl of Clarendon, led to his removal from court. He died in 1658, and was buried at Ghent. In 1644, when Grenville deserted the parliamentary party, a proclamation was put out against him; in this there were attached to his name several offensive epithets, among them being *skellum*, a word probably derived from the German *Schelm*, a scoundrel. Hence he is often called "skellum Grenville."

Grenville wrote an account of affairs in the west of England, which was printed in T. Carte's *Original Letters* (1739). To this partisan account Clarendon drew up an answer, the bulk of which he afterwards incorporated in his *History*. In 1654 Grenville wrote his *Single defence against all aspersions of all malignant persons*. This is printed in the *Works of George Granville, Lord Lansdowne* (London, 1736), where Lansdowne's *Vindication* of his kinsman, Sir Richard, against Clarendon's charges is also found. See also Clarendon, *History of the Rebellion*, edited by W. D. Macray (Oxford, 1888); and R. Granville, *The King's General in the West* (1908).

GRENVILLE, WILLIAM WYNDHAM GRENVILLE, BARON (1759-1834), English statesman, youngest son of George Grenville, was born on the 25th of October 1759. He was educated at Eton and Christ Church, Oxford, gaining the chancellor's prize for Latin verse in 1779. In February 1782 Grenville was returned to parliament as member for the borough of Buckingham, and in the following September he became secretary to the lord lieutenant of Ireland, who at this time was his brother, Earl Temple, afterwards marquess of Buckingham. He left office in June 1783, but in the following December he became paymaster-general of the forces under his cousin, William Pitt, and in 1786 vice-president of the committee of trade. In 1787 he was sent on an important mission to the Hague and Versailles with reference to the affairs of Holland. In January 1789 he was chosen speaker of the House of Commons, but he vacated the chair in the same year on being appointed secretary of state for the home department; about the same time he resigned his other offices, but he became president of the board of control, and in November 1790 was created a peer as Baron Grenville. In the House of Lords he was very active in directing the business of the government, and in 1791 he was transferred to the foreign office, retaining his post at the board of control until 1793. He was doubtless regarded by Pitt as the man best fitted to carry out his policy with reference to France, but in the succeeding years he and his chief were frequently at variance on important

questions of foreign policy. In spite of his multifarious duties at the foreign office Grenville continued to take a lively interest in domestic matters, which he showed by introducing various bills into the House of Lords. In February 1801 he resigned office with Pitt because George III. would not consent to the introduction of any measure of Roman Catholic relief, and in opposition he gradually separated himself from his former leader. When Pitt returned to power in 1804 Grenville refused to join the ministry unless his political ally, Fox, was also admitted thereto; this was impossible and he remained out of office until February 1806, when just after Pitt's death he became the nominal head of a coalition government. This ministry was very unfortunate in its conduct of foreign affairs, but it deserves to be remembered with honour on account of the act passed in 1807 for the abolition of the slave trade. Its influence, however, was weakened by the death of Fox, and in consequence of a minute drawn up by Grenville and some of his colleagues the king demanded from his ministers an assurance that in future they would not urge upon him any measures for the relief of Roman Catholics. They refused to give this assurance and in March 1807 they resigned. Grenville's attitude in this matter was somewhat aggressive; his colleagues were not unanimous in supporting him, and Sheridan, one of them, said "he had known many men knock their heads against a wall, but he had never before heard of any man who collected the bricks and built the very wall with an intention to knock out his own brains against it."

Lord Grenville never held office again, although he was requested to do so on several occasions. He continued, however, to take part in public life, being one of the chief supporters of Roman Catholic emancipation, and during the remaining years of his active political career, which ended in 1823, he generally voted with the Whigs, although in 1815 he separated himself from his colleague, Charles Grey, and supported the warlike policy of Lord Liverpool. In 1819, when the marquis of Lansdowne brought forward his motion for an inquiry into the causes of the distress and discontent in the manufacturing districts, Grenville delivered an alarmist speech advocating repressive measures. His concluding years were spent at Dropmore, Buckinghamshire, where he died on the 12th of January 1834. His wife, whom he married in 1792, was Anne (1772-1864), daughter of Thomas Pitt, 1st Baron Camelford, but he had no issue and his title became extinct. In 1809 he was elected chancellor of Oxford university.

Though Grenville's talents were not of the highest order his straightforwardness and industry, together with his knowledge of politics and the moderation of his opinions, secured for him considerable political influence. He may be enrolled among the band of English statesmen who have distinguished themselves in literature. He edited Lord Chatham's letters to his nephew, Thomas Pitt, afterwards Lord Camelford (London, 1804, and other editions); he wrote a small volume, *Nugae Mæricæ* (1824), being translations into Latin from English, Greek and Italian, and an *Essay on the Supposed Advantages of a Sinking Fund* (1828).

The Dropmore MSS. contain much of Grenville's correspondence, and on this the Historical Manuscripts Commission has published a report.

GRESHAM, SIR THOMAS (1519-1579), London merchant, the founder of the Royal Exchange and of Gresham College, London, was descended from an old Norfolk family; he was the only son of Sir Richard Gresham, a leading London merchant, who for some time held the office of lord mayor, and for his services as agent of Henry VIII. in negotiating loans with foreign merchants received the honour of knighthood. Though his father intended him to follow his own profession, he nevertheless sent him for some time to Caius College, Cambridge, but there is no information as to the duration of his residence. It is uncertain also whether it was before or after this that he was apprenticed to his uncle Sir John Gresham, who was also a merchant, but we have his own testimony that he served an apprenticeship of eight years. In 1543, at the age of twenty-four, he was admitted a member of the Mercers' Company, and in the same year he went to the Low Countries, where, either on his own account or

on that of his father or uncle, he both carried on business as a merchant and acted in various matters as an agent for Henry VIII. In 1544 he married the widow of William Read, a London merchant, but he still continued to reside principally in the Low Countries, having his headquarters at Antwerp. When in 1551 the mismanagement of Sir William Dansell, "king's merchant" in the Low Countries, had brought the English government into great financial embarrassment, Gresham was called in to give his advice, and chosen to carry out his own proposals. Their leading feature was the adoption of various methods—highly ingenious, but quite arbitrary and unfair—for raising the value of the pound sterling on the "bourse" of Antwerp, and it was so successful that in a few years nearly all King Edward's debts were discharged. The advice of Gresham was likewise sought by the government in all their money difficulties, and he was also frequently employed in various diplomatic missions. He had no stated salary, but in reward of his services received from Edward various grants of lands, the annual value of which at that time was ultimately about £400 a year. On the accession of Mary he was for a short time in disfavour, and was displaced in his post by Alderman William Dauntsey. But Dauntsey's financial operations were not very successful and Gresham was soon reinstated; and as he professed his zealous desire to serve the queen, and manifested great adroitness both in negotiating loans and in smuggling money, arms and foreign goods, not only were his services retained throughout her reign, but besides his salary of twenty shillings *per diem* he received grants of church lands to the yearly value of £200. Under Queen Elizabeth, besides continuing in his post as financial agent of the crown, he acted temporarily as ambassador at the court of the duchess of Parma, being knighted in 1559 previous to his departure. By the outbreak of the war in the Low Countries he was compelled to leave Antwerp on the 10th of March 1567; but, though he spent the remainder of his life in London, he continued his business as merchant and financial agent of the government in much the same way as formerly. Elizabeth also found him useful in a great variety of other ways, among which was that of acting as jailer, to Lady Mary Grey, who, as a punishment for marrying Thomas Keys the sergeant porter, remained a prisoner in his house from June 1569 to the end of 1572. In 1565 Gresham made a proposal to the court of aldermen of London to build at his own expense a bourse or exchange, on condition that they purchased for this purpose a piece of suitable ground. In this proposal he seems to have had an eye to his own interest as well as to the general good of the merchants, for by a yearly rental of £700 obtained for the shops in the upper part of the building he received a sufficient return for his trouble and expense. Gresham died suddenly, apparently of apoplexy, on the 21st of November 1579. His only son predeceased him, and his illegitimate daughter Anne he married to Sir Nathaniel Bacon, brother of the great Lord Bacon. With the exception of a number of small sums bequeathed to the support of various charities, the bulk of his property, consisting of estates in various parts of England of the annual value of more than £2300, was bequeathed to his widow and her heirs with the stipulation that after her decease his residence in Bishopsgate Street, as well as the rents arising from the Royal Exchange, should be vested in the hands of the corporation of London and the Mercers' Company, for the purpose of instituting a college in which seven professors should read lectures—one each day of the week—on astronomy, geometry, physics, law, divinity, rhetoric and music. The lectures were begun in 1597, and were delivered in the original building until 1768, when, on the ground that the trustees were losers by the gift, it was made over to the crown for a yearly rent of £500, and converted into an excise office. From that time a room in the Royal Exchange was used for the lectures until in 1845 the present building was erected at a cost of £7000.

A notice of Gresham is contained in Fuller's *Worthies* and Ward's *Gresham Professors*; but the fullest account of him, as well as of the history of the Exchange and Gresham College is that by J. M. Burgon in his *Life and Times of Sir Thomas Gresham* (2 vols., 1839). See also a *Brief Memoir of Sir Thomas Gresham* (1833); and *The Life of Sir Thomas Gresham, Founder of the Royal Exchange* (1845).

GRESHAM, WALTER QUINTON (1832-1898), American statesman and jurist, was born near Lanesville, Harrison county, Indiana, on the 17th of March 1832. He spent two years in an academy at Corydon, Indiana, and one year at the Indiana State University at Bloomington, then studied law, and in 1854 was admitted to the bar. He was active as a campaign speaker for the Republican ticket in 1856, and in 1860 was elected to the State House of Representatives as a Republican in a strong Democratic district. In the House, as chairman of the committee on military affairs, he did much to prepare the Indiana troops for service in the Federal army; in 1861 he became colonel of the 53rd Indiana Volunteer Infantry, and subsequently took part in Grant's Tennessee campaign of 1862, and in the operations against Corinth and Vicksburg, where he commanded a brigade. In August 1863 he was appointed brigadier-general of volunteers, and was placed in command of the Federal forces at Natchez. In 1864 he commanded a division of the 17th Army Corps in Sherman's Atlanta campaign, and before Atlanta, on the 30th of July, he received a wound which forced him to retire from active service, and left him lame for life. In 1865 he was brevetted major-general of volunteers. After the war he practised law at New Albany, Indiana, and in 1869 was appointed by President Grant United States District Judge for Indiana. In April 1883 he succeeded Timothy O. Howe (1816-1883) as postmaster-general in President Arthur's cabinet, taking an active part in the suppression of the Louisiana Lottery, and in September 1884 succeeded Charles J. Folger as secretary of the treasury. In the following month he resigned to accept an appointment as United States Judge for the Seventh Judicial Circuit. Gresham was a candidate for the Republican presidential nomination in 1884 and 1888, in the latter year leading for some time in the balloting. Gradually, however, he grew out of sympathy with the Republican leaders and policy, and in 1892 advocated the election of the Democratic candidate, Grover Cleveland, for the presidency. From the 7th of March 1893 until his death at Washington on the 28th of May 1895, he was secretary of state in President Cleveland's cabinet.

GRESHAM'S LAW, in economics, the name suggested in 1857 by H. D. Macleod for the principle of currency which may be briefly summarized—"bad money drives out good." Macleod gave it this name, which has been universally adopted, under the impression that the principle was first explained by Sir Thomas Gresham in 1558. In reality it had been well set forth by earlier economic writers, notably Oresme and Copernicus. Macleod states the law in these terms: the worst form of currency in circulation regulates the value of the whole currency and drives all other forms of currency out of circulation. Gresham's law applies where there is under-weight or debased coin in circulation with full-weight coin of the same metal; where there are two metals in circulation, and one is undervalued as compared with the other, and where inconvertible paper money is put into circulation side by side with a metallic currency. See further **BIMETALLISM**; **MONEY**.

GRESSET, JEAN BAPTISTE LOUIS (1700-1777), French poet and dramatist, was born at Amiens on the 29th of August 1700. His poem *Vert Vert* is his main title to fame. He spent, however, the last twenty-five years of his life in regretting the frivolity which enabled him to produce this most charming of poems. He was brought up by the Jesuits of Amiens. He was accepted as a novice at the age of sixteen, and sent to pursue his studies at the Collège Louis le Grand in Paris. After completing his course he was appointed, being then under twenty years of age, to a post as assistant master in a college at Rouen. He published *Vert Vert* at Rouen in 1734. It is a story, in itself exceedingly humorous, showing how a parrot, the delight of a convent, whose talk was all of prayers and pious ejaculations, was conveyed to another convent as a visitor to please the nuns. On the way he falls among bad companions, forgets his convent language, and shocks the sisters on arrival by profane swearing. He is sent back in disgrace, punished by solitude and plain bread, presently repents, reforms and is killed by kindness. The story, however, is nothing. The treatment of the subject, the

atmosphere which surrounds it, the delicacy in which the little prattling ways of the nuns, their jealousies, their tiny trifles, are presented, takes the reader entirely by surprise. The poem stands absolutely unrivalled, even among French *contes en vers*.

Gresset found himself famous. He left Rouen, went up to Paris, where he found refuge in the same garret which had sheltered him when a boy at the Collège Louis le Grand, and there wrote his second poem, *La Choréreuse*. It was followed by the *Carême impromptu*, the *Lubin vivant* and *Les Ombres*. Then trouble came upon him; complaints were made to the fathers of the alleged licentiousness of his verses, the real cause of complaint being the ridicule which *Vert Vert* seemed to throw upon the whole race of nuns and the anti-clerical tendency of the other poems. An example, it was urged, must be made; Gresset was expelled the order. Men of robust mind would have been glad to get rid of such a yoke. Gresset, who had never been taught to stand alone, went forth weeping. He went to Paris in 1740 and there produced *Edouard III*, a tragedy (1740) and *Sidrac* (1743); a comedy. These were followed by *Le Méchant* which still keeps the stage, and is qualified by Brunetière as the best verse comedy of the French 18th century theatre, not excepting even the *Métromanie* of Alexis Piron. Gresset was admitted to the Academy in 1748. And then, still young, he retired to Amiens, where his relapse from the discipline of the church became the subject of the deepest remorse. He died at Amiens on the 16th of June 1777.

The best edition of his poems is A. A. Renouard's (1811). See Jules Vogues, *J. B. L. Gresset* (1894).

GRETNIA GREEN, or GRATTNEY GREEN, a village in the south-east of Dumfriesshire, Scotland, about 8 m. E. of Annan, 9 m. N.N.W. of Carlisle, and $\frac{1}{2}$ m. from the river Sark, here the dividing-line between England and Scotland, with a station on the Glasgow & South-Western railway. The Caledonian and North British railways have a station at Gretna on the English side of the Border. As the nearest village on the Scottish side, Gretna Green was notorious as the resort of eloping couples, who had failed to obtain the consent of parents or guardians to their union. Up till 1754, when Lord Hardwicke's act abolishing clandestine marriages came into force, the ceremony had commonly been performed in the Fleet prison in London. After that date runaway couples were compelled to seek the hospitality of a country where it sufficed for them to declare their wish to marry in the presence of witnesses. At Gretna Green the ceremony was usually performed by the blacksmith, but the toll-keeper, ferryman or in fact any person might officiate, and the toll-house, the inn, or, after 1826, Gretna Hall was the scene of many such weddings, the fees varying from half a guinea to a sum as large as impudence could extort or extravagance bestow. As many as two hundred couples were married at the toll-house in a year. The romantic traffic was practically, though not necessarily, put an end to in 1856, when the law required one of the contracting parties to reside in Scotland three weeks previous to the event.

GRÉTRY, ANDRÉ ERNEST MODÈSTE (1741-1813), French composer, was born at Liège on the 8th of February 1741, his father being a poor musician. He was a choir boy at the church of St Denis. In 1753 he became a pupil of Leclerc and later of Renekin and Moreau. But of greater importance was the practical tuition he received by attending the performance of an Italian opera company. Here he heard the operas of Galuppi, Pergolesi and other masters; and the desire of completing his own studies in Italy was the immediate result. To find the necessary means he composed in 1759 a mass which he dedicated to the canons of the Liège cathedral, and it was at the cost of Canon Hurley that he went to Italy in the March of 1759. In Rome he went to the Collège de Liège. Here Grétry resided for five years, studiously employed in completing his musical education under Casali. His proficiency in harmony and counterpoint was, however, according to his own confession, at all times very moderate. His first great success was achieved by *La Vendémiaire*, an Italian intermezzo or operetta, composed for the Aliberti theatre in Rome and received with universal

applause. It is said that the study of the score of one of Moinigny's operas, lent to him by a secretary of the French embassy in Rome, decided Grétry to devote himself to French comic opera. On New Year's day 1767 he accordingly left Rome, and after a short stay at Geneva (where he made the acquaintance of Voltaire, and produced another operetta) went to Paris. There for two years he had to contend with the difficulties incident to poverty and obscurity. He was, however, not without friends, and by the intercession of Count Creutz, the Swedish ambassador, Grétry obtained a libretto from Marmontel, which he set to music in less than six weeks, and which, on its performance in August 1768, met with unparalleled success. The name of the opera was *Le Huron*. Two others, *Lucile* and *Le Tableau parlant*, soon followed, and thenceforth Grétry's position as the leading composer of comic opera was safely established. Altogether he composed some fifty operas. His masterpieces are *Zémire et Asor* and *Richard Cœur de Lion*,—the first produced in 1771, the second in 1784. The latter in an indirect way became connected with a great historic event. In it occurs the celebrated romance, *O Richard, ô mon roi, l'univers l'abandonne*, which was sung at the banquet—"fatal as that of Thyestes," remarks Carlyle—given by the bodyguard to the officers of the Versailles garrison on October 3, 1789. The *Marseillais* not long afterwards became the reply of the people to the expression of loyalty borrowed from Grétry's opera. The composer himself was not influenced by the great events he witnessed, and the titles of some of his operas, such as *La Rosière républicaine* and *La Fête de la raison*, sufficiently indicate the epoch to which they belong; but they are mere *pièces de circonstance*, and the republican enthusiasm displayed is not genuine. Little more successful was Grétry in his dealings with classical subjects. His genuine power lay in the delineation of character and in the expression of tender and typically French sentiment. The structure of his concerted pieces on the other hand is frequently flimsy, and his instrumentation so feeble that the orchestral parts of some of his works had to be rewritten by other composers, in order to make them acceptable to modern audiences. During the revolution Grétry lost much of his property, but the successive governments of France vied in favouring the composer, regardless of political differences. From the old court he received distinctions and rewards of all kinds; the republic made him an inspector of the conservatoire; Napoleon granted him the cross of the legion of honour and a pension. Grétry died on the 24th of September 1813, at the Hermitage in Montmorency, formerly the house of Rousseau. Fifteen years after his death Grétry's heart was transferred to his birthplace, permission having been obtained after a tedious lawsuit. In 1842 a colossal bronze statue of the composer was set up at Liège.

See Michael Brenet, *Vie de Grétry* (Paris, 1884); Joach. le Breton, *Noëte historique sur la vie et les ouvrages de Grétry* (Paris, 1814); A. Grétry (his nephew), *Grétry en famille* (Paris, 1814); Felix van Hulst, *Grétry* (Liège, 1842); L. D. S. *Notice biographique sur Grétry* (Bruxelles, 1869).

GREUZE, JEAN BAPTISTE (1725-1805), French painter, was born at Tournus, in Burgundy, on the 21st of August 1725, and is generally said to have formed his own talent; this is, however, true only in the most limited sense, for at an early age his inclinations, though thwarted by his father, were encouraged by a Lyonsese artist named Grandon, or Grondom, who enjoyed during his lifetime considerable reputation as a portrait-painter. Grandon not only persuaded the father of Greuze to give way to his son's wishes, and permit the lad to accompany him as his pupil to Lyons, but, when at a later date he himself left Lyons for Paris—where his son-in-law Grétry the celebrated composer enjoyed the height of favour—Grandon carried young Greuze with him. Settled in Paris, Greuze worked from the living model in the school of the Royal Academy, but did not attract the attention of his teachers; and when he produced his first picture, "*Le Père de famille expliquant la Bible à ses enfants*," considerable doubt was felt and shown as to his share in its production. By other and more remarkable works of the same class Greuze soon established his claims beyond contest, and won for himself the

notice and support of the well-known *conseiller* Monsieur La Tour de Jully, the brother-in-law of Madame d'Épinay. In 1755 Greuze exhibited his "*Aveugle trompé*," upon which, presented by Fagelle the sculptor, he was immediately *agréé* by the Academy. Towards the close of the same year he left France for Italy, in company with the Abbé Louis Gougenot, who had deserted from the magistrature—although he had obtained the post of "*conseiller au Châtelet*"—in order to take the "*petit collet*." Gougenot had some acquaintance with the arts, and was highly valued by the Academicians, who, during his journey with Greuze, elected him an honorary member of their body on account of his studies in mythology and allegory; his acquirements in these respects are said to have been largely utilized by them, but to Greuze they were of doubtful advantage, and he lost rather than gained by this visit to Italy in Gougenot's company. He had undertaken it probably in order to silence those who taxed him with ignorance of "great models of style," but the Italian subjects which formed the entirety of his contributions to the Salon of 1757 showed that he had been put on a false track; and he speedily returned to the source of his first inspiration. In 1759, 1761 ("*L'Accordée de village*"—Louvre), and 1763 Greuze exhibited with ever-increasing success; in 1765 he reached the zenith of his powers and reputation. In that year he was represented with no less than thirteen works, amongst which may be cited "*La Jeune Fille qui pleure son oiseau mort*," "*La Bonne Mère*," "*Le Mauvais fils puni*" (Louvre) and "*La Malédiction paternelle*" (Louvre). The Academy took occasion to press Greuze for his diploma picture, the execution of which had been long delayed, and forbade him to exhibit on their walls until he had complied with their regulations: "*J'ai vu la lettre*," says Diderot, "*qui est un modèle d'honnêteté et d'estime; j'ai vu la réponse de Greuze, qui est un modèle de vanité et d'impertinence: il fallait appuyer cela d'un chef-d'œuvre, et c'est ce que Greuze n'a pas fait.*" Greuze wished to be received as a historical painter, and produced a work which he intended to vindicate his right to despise his qualifications as a *peintre de genre*. This unfortunate canvas—"Sevère et Caracalla" (Louvre)—was exhibited in 1769 side by side with Greuze's portrait of Jeurat (Louvre) and his admirable "*Petite Fille au chien noir*." The Academicians received their new member with all due honours, but at the close of the ceremonies the Director addressed Greuze in these words—"Monsieur, l'Académie vous a reçu, mais c'est comme peintre de genre; elle a en égard à vos anciennes productions, qui sont excellentes, et elle a fermé les yeux sur celle-ci, qui n'est digne ni d'elle ni de vous." Greuze, greatly incensed, quarrelled with his *confères*, and ceased to exhibit until, in 1804, the Revolution had thrown open the doors of the Academy to all the world. In the following year, on the 4th of March 1805, he died in the Louvre in great poverty. He had been in receipt of considerable wealth, which he had dissipated by extravagance and bad management, so that during his closing years he was forced even to solicit commissions which his enfeebled powers no longer enabled him to carry out with success. The brilliant reputation which Greuze acquired seems to have been due, not to his acquirements as a painter—for his practice is evidently that current in his own day—but to the character of the subjects which he treated. That return to nature which inspired Rousseau's attacks upon an artificial civilization demanded expression in art. Diderot, in *Le Fils naturel et le père de famille*, tried to turn the vein of domestic drama to account on the stage; that which he tried and failed to do Greuze, in painting, achieved with extraordinary success, although his works, like the plays of Diderot, were affected by that very artificiality against which they protested. The touch of melodramatic exaggeration, however, which runs through them finds an apology in the firm and brilliant play of line, in the freshness and vigour of the flesh tints, in the enticing softness of expression (often obtained by almost an abuse of *mélisés*), by the alluring air of health and youth, by the sensuous attractions, in short, with which Greuze invests his lessons of bourgeois morality. As Diderot said of "*La Bonne Mère*," "*ça pêche la population*;" and a certain piquancy of contrast is the result which never

fails to obtain admirers. "La Jeune Fille à l'agneau" fetched, indeed, at the Pourtales sale in 1865, no less than 1,000,200 francs. One of Greuze's pupils, Madame Le Doux, imitated with success the manner of her master; his daughter and granddaughter, Madame de Valory, also inherited some traditions of his talent. Madame de Valory published in 1813 a comédie-vaudeville, *Greuze, ou l'accordée de village*, to which she prefixed a notice of her grandfather's life and works, and the *Salons* of Diderot also contain, besides many other particulars, the story at full length of Greuze's quarrel with the Academy. Four of the most distinguished engravers of that date, Massard père, Flipart, Gaillard and Levasseur, were specially entrusted by Greuze with the reproduction of his subjects, but there are also excellent prints by other engravers, notably by Cars and Le Bas.

See also Normand, *J. B. Greuze* (1892). (E. F. S. D.)

GREVILLE, CHARLES CAVENDISH FULKE (1794-1865), English diarist, a great-grandson by his father of the 5th earl of Warwick, and son of Lady Charlotte Bentinck, daughter of the duke of Portland, formerly a leader of the Whig party, and first minister of the crown, was born on the 2nd of April 1794. Much of his childhood was spent at his grandfather's house at Bulstrode. He was one of the pages of George III., and was educated at Eton and Christ Church, Oxford; but he left the university early, having been appointed private secretary to Earl Bathurst before he was twenty. The interest of the duke of Portland had secured for him the secretaryship of the island of Jamaica, which was a sinecure office, the duties being performed by a deputy, and the reversion of the clerkship of the council. Greville entered upon the discharge of the duties of clerk of the council in ordinary in 1821, and continued to perform them for nearly forty years. He therefore served under three successive sovereigns,—George IV., William IV. and Victoria,—and although no political or confidential functions are attached to that office, it is one which brings a man into habitual intercourse with the chiefs of all the parties in the state. Well-born, well-bred, handsome and accomplished, Greville led the easy life of a man of fashion, taking an occasional part in the transactions of his day and much consulted in the affairs of private life. Until 1855 when he sold his stud he was an active member of the turf, and he trained successively with Lord George Bentinck, and with the duke of Portland. But the celebrity which now attaches to his name is entirely due to the posthumous publication of a portion of a Journal or Diary which it was his practice to keep during the greater part of his life. These papers were given by him to his friend Mr Henry Reeve a short time before his death (which took place on the 18th of January 1865), with an injunction that they should be published, as far as was feasible, at not too remote a period after the writer's death. The journals of the reigns of George IV. and William IV. (extending from 1820 to 1837) were accordingly so published in obedience to his directions about ten years after that event. Few publications have been received with greater interest by the public; five large editions were sold in little more than a year, and the demand in America was as great as in England. These journals were regarded as a faithful record of the impressions made on the mind of a competent observer, at the time, by the events he witnessed and the persons with whom he associated. Greville did not stoop to collect or record private scandal. His object appears to have been to leave behind him some of the materials of history, by which the men and actions of his own time would be judged. He records not so much public events as the private causes which led to them; and perhaps no English memoir-writer has left behind him a more valuable contribution to the history of the 19th century. Greville published anonymously, in 1845, a volume on the *Past and Present Policy of England to Ireland*, in which he advocated the payment of the Roman Catholic clergy; and he was also the author of several pamphlets on the events of his day.

His brother, **HENRY GREVILLE** (1801-1872), attaché to the British embassy in Paris from 1834 to 1844, also kept a diary, of which part was published by Viscountess Enfield, *Leaves from the Diary of Henry Greville* (London, 1883-1884).

See the preface and notes to the *Greville Memoirs* by Henry Reeve. The memoirs appeared in three sets—one from 1817 to 1837 (London, 1875, 3 vols.), and two for the period from 1837 to 1860, three volumes in 1885 and two in 1887. When the first series appeared in 1875 some passages caused extreme offence. The copies issued were as far as possible recalled and passages suppressed.

GRÉVIN, JACQUES (c. 1539-1570), French dramatist, was born at Clermont about 1539. He studied medicine at the university of Paris. He became a disciple of Ronsard, and was one of the band of dramatists who sought to introduce the classical drama in France. As Sainte-Beuve points out, the comedies of Grévin show considerable affinity with the farces and *soixies* that preceded them. His first play, *La Mousartine*, was lost, and formed the basis of a new comedy, *La Trésorière*, first performed at the college of Beauvais in 1558, though it had been originally composed at the desire of Henry II. to celebrate the marriage of Claude, duchess of Lorraine. In 1560 followed the tragedy of *Jules César*, imitated from the Latin of Muret, and a comedy, *Les Ébahis*, the most important but also the most indecent of his works. Grévin was also the author of some medical works and of miscellaneous poems, which were praised by Ronsard until the friends were separated by religious differences. Grévin became in 1561 physician and counsellor to Margaret of Savoy, and died at her court in Turin in 1570.

The *Théâtre* of Jacques Grévin was printed in 1562, and in the *Ancien Théâtre français*, vol. iv. (1855-1856). See L. Faviert, *Jacques Grévin* (1899).

GRÉVY, FRANÇOIS PAUL JULES (1813-1891), President of the French Republic, was born at Mont-sous-Vaudrey in the Jura, on the 15th of August 1813. He became an advocate in 1837, and, having steadily maintained republican principles under the Orleans monarchy, was elected by his native department to the Constituent Assembly of 1848. Foreseeing that Louis Bonaparte would be elected president by the people, he proposed to vest the chief authority in a president of the Council elected and removable by the Assembly, or in other words, to suppress the Presidency of the Republic. After the *coup d'état* this proposition gained Grévy a reputation for sagacity, and upon his return to public life in 1868 he took a prominent place in the republican party. After the fall of the Empire he was chosen president of the Assembly on the 16th of February 1871, and occupied this position till the 2nd of April 1876, when he resigned on account of the opposition of the Right, which blamed him for having called one of its members to order in the session of the previous day. On the 8th of March 1876 he was elected president of the Chamber of Deputies, a post which he filled with such efficiency that upon the resignation of Marshal MacMahon he seemed to step naturally into the Presidency of the Republic (30th January 1879); and was elected without opposition by the republican parties (see FRANCE: HISTORY). Quiet, shrewd, attentive to the public interest and his own, but without any particular distinction, he would have left an unblemished reputation if he had not unfortunately accepted a second term (18th December 1885). Shortly afterwards the traffic of his son-in-law (Daniel Wilson) in the decorations of the Legion of Honour came to light. Grévy was not accused of personal participation in these scandals, but he was somewhat obstinate in refusing to realize that he was responsible indirectly for the use which his relative had made of the Élysée, and it had to be unpleasantly impressed upon him that his resignation was inevitable (2nd December 1887). He died at Mont-sous-Vaudrey on the 9th of September 1891. He owed both his success and his failure to the completeness with which he represented the particular type of the thrifty, generally sensible and patriotic, but narrow-minded and frequently egoistic *bourgeois*.

See his *Discours politiques et judiciaires, rapports et messages . . . accompagnés de notices historiques et précédés d'une introduction* par L. Dalabrousse (2 vols., 1888).

GREW, NEHEMIAH (1641-1712), English vegetable anatomist and physiologist, was the only son of Obadiah Grew (1607-1688), Nonconformist divine and vicar of St Michael's, Coventry, and was born in Warwickshire in 1641. He graduated at Cambridge in 1661, and ten years later took the degree of M.D. at Leiden,

his thesis being *Disputatio medico-physica . . . de liquore nervoso*. He began observations on the anatomy of plants in 1664, and in 1670 his essay, *The Anatomy of Vegetables begun*, was communicated to the Royal Society by Bishop Wilkins, on whose recommendation he was in the following year elected a fellow. In 1672, when the essay was published, he settled in London, and soon acquired an extensive practice as a physician. In 1673 he published his *Idea of a Physiological History*, which consisted of papers he had communicated to the Royal Society in the preceding year, and in 1677 he succeeded Henry Oldenburg as secretary of the society. He edited the *Philosophical Transactions* in 1678-1679, and in 1681 he published "by request" a descriptive catalogue of the rarities preserved at Gresham College, with which were printed some papers he had read to the Royal Society on the *Comparative Anatomy of Stomachs and Guts*. In 1682 appeared his great work on the *Anatomy of Plants*, which also was largely a collection of previous publications. It was divided into four books, *Anatomy of Vegetables begun*, *Anatomy of Roots*, *Anatomy of Trunks and Anatomy of Leaves, Flowers, Fruits and Seeds*, and was illustrated with eighty-two plates, while appended to it were seven papers mostly of a chemical character. Among his other publications were *Sea-water made Fresh* (1684), *The Nature and Use of the Salt contained in Epsom and such other Waters* (1697), which was a rendering of his *Tractatus de salis . . . um* (1695), and *Cosmologia sacra* (1701). He died suddenly on the 25th of March 1712. Linnaeus named a genus of trees *Gretnia* (nat. ord. Tiliaceae) in his honour.

GREY, CHARLES GREY, 2ND EARL (1764-1845), English statesman, was the eldest surviving son of General Sir Charles Grey; afterwards 1st Earl Grey. He was born at his father's residence, Fallodon, near Alnwick, on the 13th of March 1764. General Grey (1729-1807), who was a younger son of the house of Grey of Howick, one of the most considerable territorial families in Northumberland, had already begun a career of active service which, like the political career of his son, covered nearly half a century. Before the latter was born, General Grey had served on the staff of Prince Ferdinand of Brunswick in the Seven Years' War and had been wounded at Minden. While the son was making verses at Eton, the father was serving against the revolted colonists in Pennsylvania and New Jersey, and while the young member for Northumberland was denouncing Pitt's war against the Convention, the veteran soldier was destroying the remnant of the French colonial empire by the capture of Martinique and Guadeloupe. When Napoleon threatened an invasion, General Grey took the command of the southern district, and at the peace of Amiens he was rewarded with a peerage, as Baron Grey of Alnwick, being created in 1806 Earl Grey and Viscount Howick. His elder brother, Sir Henry Grey of Howick, the head of the family, had supported the government in parliament. But the political career of young Grey, who was heir-presumptive to the family estates, took a different complexion.

Young Grey expected to reoccupy the seat which had been his uncle's; and his early years were spent in preparation for a parliamentary career. He was sent to Eton, and proceeded thence to Cambridge. William Pitt, a youth five years older, was then in residence as a master of arts, studiously paying court to the Whigs of the university; and at the general election of 1780 he came forward as a candidate for the academical seat. His name stood last on the poll, but he was brought in elsewhere, and his first speech proved him a man of the first mark. The unparalleled successes which followed portended grave changes. Pitt's elevation to the premiership, his brilliant and hard-fought battle in the house, and his complete rout of the Whig party at the general election of 1784, when he came in for Cambridge at the head of the poll, threatened the great territorial interest with nothing less than extinction. It was to this interest that Grey belonged; and hence, when at length returned for Northumberland in 1786, he at once came forward as a vigorous assailant of the government of Pitt. He was hailed by the opposition, and associated with Fox, Burke and Sheridan as a manager in the Hastings impeachment. During the nineteen years which

remained of the career of Fox, he followed the great Whig statesman with absolute fidelity, and succeeded him as leader of the party. The shortcomings of Fox's statesmanship were inherited by Grey. Both were equally devoid of political originality, shunned the severer labours of the politician, and instinctively feared any deviation from the traditions of their party. Such men cannot save a party in its decadence, and the history of Fox and Grey has been aptly termed the history of the decline and fall of Whiggism.

The stunning blow of 1784 was the first incident in this history. Its full significance was not at once perceived. An opposition, however weak in the beginning, generally has a tendency to revive, and Grey's early successes in the house helped to revive the Foxites. The European situation became favourable to this revival. The struggle in France for popular rights, culminating in the great Revolution, was watched by Fox with interested sympathy. He affected to regard the domination of Pitt as the domination of the crown, and as leading logically to absolutism, and saw in that popular sympathy for the French Revolution which naturally arose in England an instrument which might be employed to overthrow this domination.

But Pitt gathered the fruits of the windfall. The spread of "Jacobinism," or "French principles," became the pretext on which the stronger half of the opposition went over to the government. Burke led the movement in the Commons, the duke of Portland and Lord Fitzwilliam in the Lords, and with this second incident in the Whig decline began the difficulties of Grey's career. The domination of the premier had already stirred the keenest resentment in the younger and more ambitious members of the Whig party. Freed from the restraint of the steadier politicians under Burke and Portland, the residuum under Fox fell into a series of grave mistakes. Of this residuum Grey became the moving spirit, for though Fox did not check their activity, he disclaimed the responsibility of their policy. Fox had refused to condemn "French principles," and denounced the war with France; but he would take no part in exciting agitation in England. It was otherwise with the restless spirits among whom Grey was found. Enraged by the attitude of Pitt, which was grounded on the support of the constituencies as they then stood, the residuum plotted an ill-timed agitation for parliamentary reform.

The demand for parliamentary reform was as yet in a rudimentary stage. Forty years later it had become the demand of an unenfranchised nation, disabused by a sudden spread of political and economical knowledge. It was as yet but the occasional instrument of the scheming politician. Chatham had employed the cry in this sense. The Middlesex agitators had done the same; even the premier of the time, after his accession to power, had sought to strengthen his hands in the same way. But Pitt's hands were now strengthened abundantly; whereas the opposition had nothing to lose and much to gain by such a measure. The cry for reform thus became their natural expedient. Powerless to carry reform in the House, they sought to overawe parliament by external agitation, and formed the Society of the Friends of the People, destined to unite the forces of all the "patriotic" societies which already existed in the country, and to pour their violence irresistibly on a terrified parliament. Grey and his friends were enrolled in this portentous association, and presented in parliament its menacing petitions. Such petitions, which were in fact violent impeachments of parliament itself, proceeding from voluntary associations having no corporate existence, had been hitherto unknown in the English parliament. They had been well known in the French assembly. They had heralded and furthered the victory of the Jacobins, the dissolution of the constitution, the calling of the Convention and the fall of the monarchy.

The Society of the Friends of the People was originally an after-dinner folly, extemporized at the house of a man who afterwards gained an earldom by denouncing it as seditious. Fox discountenanced it, though he did not directly condemn it; but Grey was overborne by the fierce Jacobinism of Lauderdale, and avowed himself the parliamentary mouthpiece of this dangerous

agitation. But Pitt, strong in his position, cut the ground from under Grey's feet by suppressing the agitation with a strong hand. The suspension of the Habeas Corpus Act, the Gagging Acts and the state prosecutions form a painful historical episode. But the discredit belongs as much to Grey and Lauderdale as to Pitt. Grey always spoke regretfully of his share in the movement. "One word from Fox," he said, "would have kept me out of all the mess of the Friends of the People. But he never spoke it."

It was Grey who moved the impeachment of Pitt, and he next promoted the equally foolish "Secession." Since the parliament did not properly represent the nation, and refused to reform itself or to impeach the minister, nothing remained but to disown it; and the opposition announced their intention of "seceding," or systematically absenting themselves from their places in parliament. This futile movement was originated by Grey, Lauderdale and the duke of Bedford. It obtained a somewhat wider support. It suited the languor of some dispirited politicians like Fox, and the avarice of some lawyers in large practice like Erskine; but sensible politicians at once condemned it. It directly ignored parliamentary government, and amounted to nothing but a pettish threat of revolution. "Secession," said Lord Lansdowne, with characteristic shrewdness, "either means rebellion, or it is nonsense." Pitt easily dashed this feeble weapon from the hands of his opponents. He roused jealousy in the absent by praising the parts and the patriotism of the rest, and thus gradually brought them back. Grey himself reappeared to protest against the union with Ireland.

When Pitt died in 1806 nothing could prevent the reunited opposition from coming into power, and thus the Broad-bottom ministry was formed under Fox. On his death Grenville became premier, and Grey, now Lord Howick, foreign secretary, and leader of the House of Commons. Disunion, always the bane of English Liberalism, lurked in the coalition, and the Foxites and Grenvillites were only ostensibly at one. Grey opposed the war policy of Grenville; and this policy was not more successful than it had been in the hands of Pitt. And the change from the leadership of Fox to that of Grenville was only too perceptible. Both in court and country Grenville affected the role of Pitt, and assumed a stiff and peremptory attitude which ill became him. An ill-advised dissolution weakened their majority; they lost ground by the "delicate investigation" into the conduct of the princess of Wales; Lord Henry Petty's budget was too specious to command confidence; and the king, fully aware of their weak situation, resolved to get rid of them. When they proposed to concede a portion of the Catholic claims, George refused and demanded of them an undertaking never to propose such a measure again. This was refused, and the Grenville-Grey cabinet retired in March 1807. In the same year Grey's father died, and Grey went to the Upper House. Opposition united Grey and Grenville for a time, but the parties finally split on the old war question. When Napoleon returned from Elba in 1815, and once more seized the government of France, the same question arose which had arisen in 1792, Was England to go to war for the restoration of the Bourbons? Grenville followed the traditions of Pitt, and supported the ministry in at once renewing hostilities. Grey followed those of Fox, and maintained the right of France to choose her own governors, and the impossibility of checking the reaction in the emperor's favour. The victory of Waterloo put an end to the dispute, but the disruption became permanent. The termination of the war, and the cessation of all action in common, reduced the power of the opposition to nothing. Grenville retired from public life, and his adherents reinforced the ministry. Little remained for the Whigs to do. But the persecution of the queen afforded an opportunity of showing that the ministry were not omnipotent; and the part taken on that occasion by Grey won him at once the increased respect of the nation and the undying aversion of George IV. It sealed the exclusion of himself and his few friends from office during the king's life; and when in 1827 Grey came forth to denounce the ministry of Canning, he declared that he stood alone in the political world. His words were soon justified, for when Lord Goderich resigned, the remnant which had hitherto

supported Grey, hastened to support the ministry of the duke of Wellington.

We now reach the principal episode in Grey's career. In 1827 he seemed to stand forth the solitary and powerless relic of an extinct party. In 1832 we find that party restored to its old numbers and activity, supreme in parliament, popular in the nation, and Lord Grey at its head. The duke of Wellington's foolish declaration against parliamentary reform, made in a season of great popular excitement, suddenly deprived him of the confidence of the country, and a coalition of the Whigs and Canningites became inevitable. The Whigs had in 1827 supported the Canningites; the latter now supported the Whigs, of whom Grey remained the traditional head. George IV. was dead, and no obstacle existed to Grey's elevation. Grey was sent for by William IV. in November 1830, and formed a coalition cabinet, pledged to carry on the work in which the duke of Wellington had faltered. But Grey himself was the mere instrument of the times. An old-fashioned Whig, he had little personal sympathy with the popular cause, though he had sometimes indicated a certain measure of reform as necessary. When he took office, he guessed neither the extent to which the Reform Act would go, nor the means by which it would be carried. That he procured for the country a measure of constitutional reform for which he had agitated in his youth was little more than a coincidence. In his youth he had put himself at the head of a frantic agitation against parliament, because he there found himself powerless. In his old age the case was reversed. Suddenly raised to a position of authority in the country, he boldly stood between parliament, as then constituted, and the formidable agitation which now threatened it and by a forced reform saved it from revolution. In his youth he had assailed Pitt's administration because Pitt's administration threatened with extinction the political monopoly of that landed interest to which he belonged. In his old age, on the contrary, unable to check the progress of the wave, he swam with it, and headed the movement which compelled that landed interest to surrender its monopoly.

The second reading of the first Reform Bill was carried in the Commons by a majority of one. This was equivalent to a defeat, and further failures precipitated a dissolution. The confidence which the bold action of the ministry had won was soon plainly proved, for the second reading was carried in the new parliament by a majority of 136. When the bill had at length passed the Commons after months of debate, it was Grey's task to introduce it to the Lords. It was rejected by a majority of 41. The safety of the country now depended on the prudence and courage of the ministry. The resignation of Grey and his colleagues was dreaded even by the opposition, and they remained in office with the intention of introducing a third Reform Bill in the next session. The last months of 1832 were the beginning of a political crisis such as England had not seen since 1688. The two extreme parties, the Ultra-Radicals and the Ultra-Tories, were ready for civil war. Between them stood the ministry and the majority of intelligent peace-loving Englishmen; and their course of action was soon decided. The bill must be passed, and there were but two ways of passing it. One was to declare the consent of the House of Lords unnecessary to the measure, the other to create, if necessary, new peers in sufficient number to outvote the opposition. These two expedients did not in reality differ. To swamp the house in the way proposed would have been to destroy it. The question whether the ministry should demand the king's consent to such a creation, if necessary, was debated in the cabinet in September. Brougham proposed it, and gradually a majority of the cabinet were won over. Grey had at first refused to employ even the threat of so unconstitutional a device as a means to the proposed end: but his continued refusal would have broken up the ministry, and the breaking up of the ministry must now have been the signal for revolution. The second reading in the Commons was passed in December by a majority of 162, and on New-Year's day 1832 the majority of the cabinet resolved on demanding power to carry it in the Lords by a creation of peers. Grey carried the resolution to the king.

Some time still remained before the bill could be committed and read a third time. It was not until the 9th of April that Grey moved the second reading in the Lords. A sufficient number of the opposition temporized; and the second reading was allowed to pass by a majority of nine. Their intention was to mutilate the bill in committee. The Ultra-Tories, headed by the duke of Wellington, had entered a protest against the second reading, but they were now politically powerless. The struggle had become a struggle on the one hand for the whole bill, to be carried by a creation of peers, and on the other for some mutilated measure. Grey's instinct divined that the crisis was approaching. Either the king must consent to swamp the House, or the ministry must cease to stand in the breach between the peers and the country. The king, a weak and inexperienced politician, had in the meantime been wrought upon by the temporizing leaders in the Lords. He was induced to believe that if the Commons should reject the mutilated bill when it was returned to them, and the ministry should consequently retire, the mutilated bill might be reintroduced and passed by a Tory ministry. He was deaf to all representations of the state of public opinion; and to the surprise of the ministry, and the terror and indignation of every man of sense in the country, he rejected their proposal and accepted their resignation, May 9, 1832. The duke of Wellington undertook the hopeless task of constructing a ministry which should pass a restricted or sham Reform Bill. The only man who could have made the success of such a ministry even probable was Peel, and Peel's conscience and good sense forbade the attempt. He refused, and after a week of the profoundest agitation throughout the country, the king, beaten and mortified, was forced to send for Grey and Brougham. On being told that his consent to the creation of peers was the only condition on which they could undertake the government, he angrily and reluctantly yielded. The chancellor, with cool forethought, demanded this consent in writing. Grey thought such a demand harsh and unnecessary. "I wonder," he said to Brougham, when the interview was over, "you could have had the heart to press it." But Brougham was inexorable, and the king signed the following paper: "The king grants permission to Earl Grey, and to his chancellor, Lord Brougham, to create such a number of peers as will be sufficient to ensure the passing of the Reform Bill, first calling up peers' eldest sons.—WILLIAM R., Windsor, May 17, 1832."

Grey had now won the game. There was no danger that he would have to resort to the expedient which he was authorized to employ. The introduction of sixty new peers would have destroyed the opposition, but it would have been equivalent to the abolition of the House. The king's consent made known, a sufficient number of peers were sure to withdraw to enable the bill to pass, and thus the dignity of both king and peerage would be saved. The duke of Wellington headed this movement on the part of the opposition; and the third reading of the bill was carried in the Lords by a majority of 84.

It is well known that in after years both Grey and Brougham disclaimed any intention of executing their threat. If this were so, they must have merely pretended to brave a danger which they secretly feared to face, and intended to avoid; and the credit of rescuing the country would belong to the duke of Wellington and the peers who seceded with him. To argue such cowardice in them from statements made when the crisis was long past, and when they were naturally willing to palliate the rough policy which they were forced to adopt, would be to set up a needless and unjustifiable paradox. Nothing else in the career of either Grey or Brougham leads us to suppose them capable of the moral baseness of yielding up the helm of state, in an hour of darkness and peril, to reckless and unskilled hands. Such would have been the result if they had lacked the determination to carry out their programme to the end. The influence of every statesman in the country would then have been extinguished, and the United Kingdom would have been absolutely in the hands of O'Connell and Orator Hunt.

Grey took but little part in directing the legislation of the reformed parliament. Never anxious for power, he had executed

the arduous task of 1832-1834 rather as a matter of duty than of inclination, and wished for an opportunity of retiring. Such an opportunity very shortly presented itself. The Irish policy of the ministry had not conciliated the Irish people, and O'Connell denounced them with the greatest bitterness. On the renewal of the customary Coercion Bill, the ministry was divided on the question whether to continue to the lord-lieutenant the power of suppressing public meetings. Littleton, the Irish secretary, was for abolishing it; and with the view of conciliating O'Connell, he informed him that the ministry intended to abandon it. But the result proved him to have been mistaken, and O'Connell, with some reason supposing himself to have been duped, called on Littleton to resign his secretaryship. It had also transpired in the discussion that Lord Althorp, the leader of the House of Commons, was privately opposed to retaining those clauses which it was his duty to push through the house. Lord Althorp therefore resigned, and Grey, who had lately passed his seventieth year, took the opportunity of resigning also. It was his opinion, it appeared, which had overborne the cabinet in favour of the public meeting clauses; and his voluntary withdrawal enabled Lord Althorp to return to his post and to proceed with the bill in its milder form. Grey was succeeded by Lord Melbourne; but no other change was made in the cabinet. Grey took no further part in politics. During most of his remaining years he continued to live in retirement at Howick, where he died on the 17th of July 1845, in his eighty-second year. By his wife Mary Elizabeth, only daughter of the first Lord Ponsonby, whom he married on the 18th of November 1794, he became the father of ten sons and five daughters. Grey's eldest son Henry (g.s.) became the 3rd earl, and among his other sons were General Charles Grey (1804-1870) and Admiral Frederick Grey (1805-1878).

In public life, Grey could always be upon occasion bold, strenuous and self-sacrificing; but he was little disposed for the active work of the politician. He was not one of those who took the statesman's duty "as a pleasure he was to enjoy." A certain stiffness and reserve ever seemed in the popular eye to hedge him in; nor was his oratory of the kind which stirs enthusiasm and delight. A tall, stately figure, fine voice and calm aristocratic bearing reminded the listener of Pitt rather than of Fox, and his speeches were constructed on the Attic rather than the Asiatic model. Though simple and straightforward, they never lacked either point or dignity; and they were admirably adapted to the audience to which they were addressed. The scrupulous uprightness of Grey's political and private character completed the ascendancy which he gained; and no politician could be named who, without being a statesman of the highest class, has left a name more enviably placed in English history. (E. J. P.)

GREY, SIR EDWARD, 3rd Bart. (1862-), English statesman, was educated at Winchester and at Balliol College, Oxford, and succeeded his grandfather, the 2nd baronet, at the age of twenty. He entered the House of Commons as Liberal member for Berwick-on-Tweed in 1885, but he was best known as a country gentleman with a taste for sport, and as amateur champion tennis-player. His interest in politics was rather languid, but he was a disciple of Lord Rosebery, and in the 1892-1895 Liberal ministry he was under-secretary for foreign affairs. In this position he earned a reputation as a politician of thorough straightforwardness and grit, and as one who would maintain British interests independently of party; and he shared with Mr Asquith the reputation of being the ablest of the Imperialists who followed Lord Rosebery. Though outside foreign affairs he played but a small part in the period of Liberal opposition between 1895 and 1905, he retained public confidence as one who was indispensable to a Liberal administration. When Sir Henry Campbell-Bannerman's cabinet was formed in December 1905 he became foreign minister, and he retained this office when in April 1908 Mr Asquith became prime minister.

GREY, SIR GEORGE (1812-1898), British colonial governor and statesman, only son of Lieutenant-Colonel Grey of the 30th Foot, was born in Lisbon on the 14th of April 1812, eight days after the death of his father at the storming of Badajoz.

He passed through Sandhurst with credit, and received his commission in 1829. His lieutenantancy was dated 1833, and his captaincy 1839, in which year he sold out and left the army. In the early 'thirties he was quartered in Ireland, where the wretchedness of the poorer classes left a deep impression on his mind. In 1836 the Royal Geographical Society accepted his offer to explore the north-west region of West Australia, and accordingly he landed at Hanover Bay at the end of 1837. The surrounding country he found broken and difficult, and his hardships were aggravated by the tropical heat and his ignorance of the continent. In a skirmish with the natives, in which he was speared near the hip, he showed great courage, and put the assailants to flight, shooting the chief, who had wounded him. After a brave endeavour to continue his journey his wound forced him to retreat to the coast, whence he sailed to Mauritius to recruit. Next year he again essayed exploration, this time on the coast to the north and south of Shark's Bay. He had three whale-boats and an ample supply of provisions, but by a series of disasters his stores were spoilt by storms, his boats wrecked in the surf, and the party had to tramp on foot from Gantheaume Bay to Perth, where Grey, in the end, walked in alone, so changed by suffering that friends did not know him. In 1839 he was appointed governor-resident at Albany, and during his stay there married Harriett, daughter of Admiral Spencer, and also prepared for publication an account, in two volumes, of his expeditions. In 1840 he returned to England, to be immediately appointed by Lord John Russell to succeed Colonel Gawler as governor of South Australia. Reaching the colony in May 1841, he found it in the depths of a depression caused by mismanagement and insane land speculation. By rigorously reducing public expenditure, and forcing the settlers to quit the town and betake themselves to tilling their lands, and with the opportune help of valuable copper discoveries, Grey was able to aid the infant colony to emerge from the slough. So striking were his energy and determination that when, in 1845, the little settlements in New Zealand were found to be involved in a native war, and on the verge of ruin, he was sent to save them. The Maori chiefs in open rebellion were defeated, and made their submission. Another powerful leader suspected of fomenting discontent was arrested, and friendly chieftains were subsidized and honoured. Bands of the natives were employed in making government roads, and were paid good wages. The governor gained the veneration of the Maori tribes, in whose welfare he took a close personal interest, and of whose legends and myths he made a valuable and scholarly collection, published in New Zealand in 1855 and reprinted thirty years afterwards. With peace prosperity came to New Zealand, and the colonial office desired to give the growing settlements full self-government. Grey, arguing that this would renew war with the Maori, returned the constitution to Downing Street. But though the colonial office sustained him, he became involved in harassing disputes with the colonists, who organized an active agitation for autonomy. In the end a second constitution, partly framed by Grey himself, was granted them, and Grey, after eight years of despotic but successful rule, was transferred to Cape Colony. He had been knighted for his services, and had undoubtedly shown strength, dexterity and humanity in dealing with the whites and natives. In South Africa his success continued. He thwarted a formidable Kaffir rebellion in the Eastern Provinces, and pushed on the work of settlement by bringing out men from the German Legion and providing them with homes. He gained the respect of the British, the confidence of the Boers, the admiration and the trust of the natives. The Dutch of the Free State and the Basuto chose him as arbitrator of their quarrels. When the news of the Indian Mutiny reached Cape Town he strained every nerve to help Lord Canning, despatching men, horses, stores and £60,000 in specie to Bombay. He persuaded a detachment, then on its way round the Cape as a reinforcement for Lord Elgin in China, to divert its voyage to Calcutta. Finally, in 1859, Grey almost reached what would have been the culminating point of his career by federating South Africa. Persuaded by him, the Orange Free State passed resolutions in

favour of this great step, and their action was welcomed by Cape Town. But the colonial office disapproved of the change, and when Grey attempted to persevere with it Sir Edward Bulwer Lytton recalled him. A change of ministry during his voyage to England displaced Sir Edward Bulwer Lytton. But though the duke of Newcastle reinstated Grey, it was with instructions to let federation drop. In 1861 the colonial office sent him, for the fourth time in succession, to take up a post of exceptional difficulty by again entrusting him with the governorship of New Zealand, where an inglorious native war in Taranaki had just been succeeded by an armed truce. Grey did his best to make terms with the rebels and to re-establish friendship with the Maori king and the land league of tribes formed to stop further sales of land to the whites. But the Maori had got guns and powder, and were suspicious and truculent. In vain Grey, supported by Bishop Selwyn and by Fox and the peace party among the settlers, strove to avert war. It came in 1863, and spread from province to province. Ten thousand regulars and as many colonial riflemen were employed to put it down. The imperial troops were badly handled, and Grey, losing patience, became involved in bitter disputes with their commanders. As an example to the former he himself attacked and captured Weraroa, the strongest of the Maori stockades, with a handful of militia, a feat which delighted the colonists, but made him as much disliked at the war office as he now was at Downing Street. Moreover, Grey had no longer real control over the islands. New Zealand had become a self-governing colony, and though he vindicated the colonists generally when libellous imputations of cruelty and land-grabbing were freely made against them in London, he crossed swords with his ministers when the latter confiscated three million acres of tribal land belonging to the insurgent Maori. Yet through all these troubles progress was made; many successes were gained in 1866, chiefly by the colonial militia, and a condition of something like tranquillity had been reached in 1867, when he received a curt intimation from the duke of Buckingham that he was about to be superseded. The colonists, who believed he was sacrificed for upholding their interests and good name, bade farewell to him in 1868 in an outburst of gratitude and sympathy; but his career as a colonial governor was at an end. Returning to England, he tried to enter public life, delivered many able speeches advocating what later came to be termed Imperialism, and stood for Newark. Discouraged, however, by the official Liberals, he withdrew and turned again to New Zealand. In 1872 he was given a pension of £1000 a year, and settled down on the island of Kawau, not far from Auckland, which he bought, and where he passed his leisure in planting, gardening and collecting books. In 1875, on the invitation of the Auckland settlers, he became superintendent of their province, and entered the New Zealand House of Representatives to resist the abolition of the provincial councils of the colony, a change then being urged on by Sir Julius Vogel in alliance with the Centralist Party. In this he failed, but his eloquence and courage drew round him a strong Radical following, and gave him the premiership in 1877. Manhood suffrage, triennial parliaments, a land-tax, the purchase of large estates and the popular election of the governor, were leading points of his policy. All these reforms, except the last, he lived to see carried; none of them were passed by him. A commercial depression in 1879 shook his popularity, and on the fall of his ministry in 1879 he was deposed, and for the next fifteen years remained a solitary and pathetic figure in the New Zealand parliament, respectfully treated, courteously listened to, but never again invited to lead. In 1891 he came before Australia as one of the New Zealand delegates to the federal convention at Sydney, and characteristically made his mark by standing out almost alone for "one man one vote" as the federal franchise. This point he carried, and the Australians thronged to hear him, so that his visits to Victoria and South Australia were personal triumphs. When, too, in 1894, he quitted New Zealand for London, some reparation was at last made him by the imperial government; he was called to the privy council, and graciously received by Queen Victoria on his visit to Windsor. Thereafter

he lived in London, and died on the 20th of September 1808. He was given a public funeral at St Paul's. Grey was all his life a collector of books and manuscripts. After leaving Cape Colony, he gave his library to Cape Town in 1862; his subsequent collection, which numbered 12,000 volumes, he presented to the citizens of Auckland in 1887. In gratitude the people of Cape Town erected a statue of him opposite their library building.

Lives of Sir George Grey have been written by W. L. and L. Rees (1892), Professor G. C. Henderson (1907) and J. Collier (1909).
(W. P. R.)

GREY, HENRY GREY, 3RD EARL (1802-1894), English statesman, was born on the 28th of December 1802, the son of the 2nd Earl Grey, prime minister at the time of the Reform Bill of 1832. He entered parliament in 1826, under the title of Viscount Howick, as member for Winchelsea, which constituency he left in 1831 for Northumberland. On the accession of the Whigs to power in 1830 he was made under-secretary for the colonies, and laid the foundation of his intimate acquaintance with colonial questions. He belonged at the time to the more advanced party of colonial reformers, sharing the views of Edward Gibbon Wakefield on questions of land and emigration, and resigned in 1834 from dissatisfaction that slave emancipation was made gradual instead of immediate. In 1835 he entered Lord Melbourne's cabinet as secretary at war, and effected some valuable administrative reforms, especially by suppressing malpractices detrimental to the troops in India. After the partial reconstruction of the ministry in 1839 he again resigned, disapproving of the more advanced views of some of his colleagues. These repeated resignations gave him a reputation for crotchety-ness, which he did not decrease by his disposition to embarrass his old colleagues by his action on free trade questions in the session of 1841. During the exile of the Liberals from power he went still farther on the path of free trade, and anticipated Lord John Russell's declaration against the corn laws. When, on Sir Robert Peel's resignation in December 1845, Lord John Russell was called upon to form a ministry, Howick, who had become Earl Grey by the death of his father in the preceding July, refused to enter the new cabinet if Lord Palmerston were foreign secretary (see J. R. Thursfield in vol. i. and Hon. F. H. Baring in vol. xxiii. of the *English Historical Review*). He was greatly censured for perverseness, and particularly when in the following July he accepted Lord Palmerston as a colleague without remonstrance. His conduct, nevertheless, afforded Lord John Russell an escape from an embarrassing situation. Becoming colonial secretary in 1846, he found himself everywhere confronted with arduous problems, which in the main he encountered with success. His administration formed an epoch. He was the first minister to proclaim that the colonies were to be governed for their own benefit and not for the mother-country's; the first systematically to accord them self-government so far as then seemed possible; the first to introduce free trade into their relations with Great Britain and Ireland. The concession by which colonies were allowed to tax imports from the mother-country *ad libitum* was not his; he protested against it, but was overruled. In the West Indies he suppressed, if he could not overcome, discontent; in Ceylon he put down rebellion; in New Zealand he suspended the constitution he had himself accorded, and yielded everything into the masterful hands of Sir George Grey. The least successful part of his administration was his treatment of the convict question at the Cape of Good Hope, which seemed an exception to his rule that the colonies were to be governed for their own benefit and in accordance with their own wishes, and subjected him to a humiliating defeat. After his retirement he wrote a history and defence of his colonial policy in the form of letters to Lord John Russell, a dry but instructive book (*Colonial Policy of Lord John Russell's Administration*, 1853). He resigned with his colleagues in 1852. No room was found for him in the Coalition Cabinet of 1853, and although during the Crimean struggle public opinion pointed to him as the fittest man as minister for war, he never again held office. During the remainder of his long life he exercised a vigilant criticism on public affairs. In 1858 he wrote a work

(republished in 1864) on parliamentary reform; in 1868 he wrote another on the state of Ireland; and in 1892 one on the United States tariff. In his latter years he was a frequent contributor of weighty letters to *The Times* on land, tithes, currency and other public questions. His principal parliamentary appearances were when he moved for a committee on Irish affairs in 1866, and when in 1878 he passionately opposed the policy of the Beaconsfield cabinet in India. He nevertheless supported Lord Beaconsfield at the dissolution, regarding Mr Gladstone's accession to power with much greater alarm. He was a determined opponent of Mr Gladstone's Home Rule policy. He died on the 9th of October 1894. None ever doubted his capacity or his conscientiousness, but he was generally deemed impracticable and disagreeable. Prince Albert, however, who expressed himself as ready to subscribe to all Grey's principles, and applauded him for having principles, told Stockmar that, although dogmatic, he was amenable to argument; and Sir Henry Taylor credits him with "more freedom from littleness of feeling than I have met before in any public man." His chief defect was perceived and expressed by his original tutor and subsequent adversary in colonial affairs, Edward Gibbon Wakefield, who wrote, "With more than a common talent for understanding principles, he has no originality of thought, which compels him to take all his ideas from somebody; and no power of working out theory in practice, which compels him to be always in somebody's hands as respects decision and action."

The earl had no sons, and he was followed as 4th earl by his nephew Albert Henry George (b. 1851), who in 1904 became governor-general of Canada.

GREY, LADY JANE (1537-1554), a lady remarkable no less for her accomplishments than for her misfortunes, was the great-granddaughter of Henry VII. of England. Her descent from that king was traced through a line of females. His second daughter Mary, after being left a widow by Louis XII. of France, married Charles Brandon, duke of Suffolk, who was a favourite with her brother King Henry VIII. Of this marriage came two daughters, the elder of whom, Lady Frances Brandon, was married to Henry Grey, marquis of Dorset; and their issue, again, consisted of daughters only. Lady Jane, the subject of this article, was the eldest of three whom the marquis had by Lady Frances. Thus it will appear that even if the crown of England had ever fallen into the female line of descent from Henry VII., she could not have put in a rightful claim unless the issue of his elder daughter, Margaret, had become extinct. But Margaret had married James IV. of Scotland; and, though her descendant, James VI., was ultimately called to the English throne, Henry VIII. had placed her family after that of his second sister in the succession; so that, failing the lawful issue of Henry himself, Lady Jane would, according to this arrangement, have succeeded. It was to these circumstances that she owed her exceptional position in history, and became the victim of an ambition which was not her own.

She was born at her father's seat named Bradgate in Leicestershire about the year 1537. Her parents, though severe disciplinarians, bestowed more than ordinary care upon her education, and she herself was so teachable and delighted so much in study that she became the marvel of the age for her acquirements. She not only excelled in needlework and in music, both vocal and instrumental, but while still very young she had thoroughly mastered Latin, Greek, French and Italian. She was able to speak and write both Greek and Latin with an accuracy that satisfied even such critics as Ascham and her tutor Dr Aylmer, afterwards bishop of London. She also acquired some knowledge of at least three Oriental tongues, Hebrew, Chaldee and Arabic. In Ascham's *Schoolmaster* is given a touching account of the devotion with which she pursued her studies and the harshness she experienced from her parents. The love of learning was her solace; in reading Demosthenes and Plato she found a refuge from domestic unhappiness. When about ten years old she was placed for a time in the household of Thomas, Lord Seymour, who, having obtained her wardship, induced her parents to let her stay with him, even after the death of his wife, Queen

Catherine Parr, by promising to marry her to his nephew, King Edward VI. Lord Seymour, however, was attainted of high treason and beheaded in 1549, and his brother, the duke of Somerset, made some overtures to the marquess of Dorset to marry her to his son the earl of Hertford. These projects, however, came to nothing. The duke of Somerset in his turn fell a victim to the ambition of Dudley, duke of Northumberland, and was beheaded three years after his brother. Meanwhile, the dukedom of Suffolk having become extinct by the deaths of Charles Brandon and his two sons, the title was conferred upon the marquess of Dorset, Lady Jane's father. Northumberland, who was now all-powerful, fearing a great reverse of fortune in case of the king's death, as his health began visibly to decline, endeavoured to strengthen himself by marriages between his family and those of other powerful noblemen, especially of the new-made duke of Suffolk. His three eldest sons being already married, the fourth, who was named Lord Guilford Dudley, was accordingly wedded to Lady Jane Grey about the end of May 1553. The match received the full approval of the king, who furnished the wedding apparel of the parties by royal warrant. But Edward's state of health warned Northumberland that he must lose no time in putting the rest of his project into execution. He persuaded the king that if the crown should descend to his sister Mary the work of the Reformation would be undone and the liberties of the kingdom would be in danger. Besides, both Mary and her sister Elizabeth had been declared illegitimate by separate acts of parliament, and the objections to Mary queen of Scots did not require to be pointed out. Edward was easily persuaded to break through his father's will and make a new settlement of the crown by deed. The document was witnessed by the signatures of all the council and of all but one of the judges; but those of the latter body were obtained only with difficulty by threats and intimidation.

Edward VI. died on the 6th July 1553, and it was announced to Lady Jane that she was queen. She was then but sixteen years of age. The news came upon her as a most unwelcome surprise, and for some time she resisted all persuasions to accept the fatal dignity; but at length she yielded to the entreaties of her father, her father-in-law and her husband. The better to mature their plans the cabal had kept the king's death secret for some days, but they proclaimed Queen Jane in the city on the 10th. The people received the announcement with manifest coldness, and a vintner's boy was even so bold as to raise a cry for Queen Mary, for which he next day had his ears nailed to the pillory and afterwards cut off. Mary, however, had received early intimation of her brother's death, and, retiring from Hunsdon into Norfolk, gathered round her the nobility and commons of those parts. Northumberland was despatched thither with an army to oppose her; but after reaching Newmarket he complained that the council had not sent him forces in sufficient numbers and his followers began to desert. News also came that the earl of Oxford had declared for Queen Mary; and as most of the council themselves were only seeking an opportunity to wash their hands of rebellion, they procured a meeting at Baynard's Castle, revoked their former acts as done under coercion, and caused the lord mayor to proclaim Queen Mary, which he did amid the shouts of the citizens. The duke of Suffolk was obliged to tell his daughter that she must lay aside her royal dignity and become a private person once more. She replied that she relinquished most willingly a crown that she had only accepted out of obedience to him and her mother, and her nine days' reign was over.

The leading actors in the conspiracy were now called to answer for their deeds. Northumberland was brought up to London a prisoner, tried and sent to the block, along with some of his partisans. The duke of Suffolk and Lady Jane were also committed to the Tower; but the former, by the influence of his duchess, procured a pardon. Lady Jane and her husband Lord Guilford Dudley were also tried, and received sentence of death for treason. This, however, was not immediately carried out; on the contrary, the queen seems to have wished to spare their lives and mitigated the rigour of their confinement.

Unfortunately, owing to the general dislike of the queen's marriage with Philip of Spain, Sir Thomas Wyatt soon after raised a rebellion in which the duke of Suffolk and his brothers took part, and on its suppression the queen was persuaded that it was unsafe to spare the lives of Lady Jane and her husband any longer. On hearing that they were to die, Lady Jane declined a parting interview with her husband lest it should increase their pain, and prepared to meet her fate with Christian fortitude. She and her husband were executed on the same day, on the 12th of February 1554, her husband on Tower Hill, and herself within the Tower an hour afterwards, amidst universal sympathy and compassion.

See Ascham's *Schoolmaster*; Burnet's *History of the Reformation*; Howard's *Lady Jane Grey*; Nicolas's *Literary Remains of Lady Jane Grey*; Tytler's *England under Edward VI. and Mary*; *The Chronicles of Queen Jane*, ed. J. G. Nichols; *The Accession of Queen Mary* (Guarar's narrative), ed. R. Garnett (1892); Foxe's *Acts and Monuments*.

GREY DE WILTON and GREY DE RUTHYN. The first Baron Grey de Wilton was Reginald de Grey, who was summoned to parliament as a baron in 1295 and who died in 1308. Reginald's son John, the 2nd baron (1268-1323), was one of the lords ordainers in 1310 and was a prominent figure in English politics during the reign of Edward II. The later barons Grey de Wilton were descended from John's eldest son Henry (d. 1342), while a younger son Roger (d. 1353) was the ancestor of the barons Grey de Ruthyn.

WILLIAM, 13TH LORD GREY DE WILTON (d. 1562), who succeeded to the title on the death of his brother Richard, about 1520, won great fame as a soldier by his conduct in France during the concluding years of Henry VIII.'s reign, and was one of the leaders of the victorious English army at the battle of Pinkie in 1547. He was then employed on the Scottish marches and in Scotland, and in 1549 he rendered good service in suppressing the rebellion in Oxfordshire and in the west of England; in 1551 he was imprisoned as a friend of the fallen protector, the duke of Somerset, and he was concerned in the attempt made by John Dudley, duke of Northumberland, to place Lady Jane Grey on the English throne in 1553. However, he was pardoned by Queen Mary and was entrusted with the defence of Guines. Although indifferently supported he defended the town with great gallantry, but in January 1558 he was forced to surrender and for some time he remained a prisoner in France. Under Elizabeth, Grey was again employed on the Scottish border, and he was responsible for the pertinacious but unavailing attempt to capture Leith in May 1560. He died at Cheshunt in Hertfordshire on the 14th/25th of December 1562.

He was described by William Cecil as "a noble, valiant, painful and careful gentleman," and his son and successor, Arthur, wrote *A Commentary of the Services and Charges of William, Lord Grey of Wilton, K.G.* This has been edited by Sir P. de M. Grey Egerton for the Camden Society (1847).

Grey's elder son **ARTHUR, 14TH LORD GREY DE WILTON** (1536-1593), was during early life with his father in France and in Scotland; he fought at the battle of St. Quentin and helped to defend Guines and to assault Leith. In July 1580 he was appointed lord deputy of Ireland, and after an initial defeat in Wicklow was successful in reducing many of the rebels to a temporary submission. Perhaps the most noteworthy event during his tenure of this office was the massacre of 600 Italians and Spaniards at Smerwick in November 1580, an action for which he was responsible. Having incurred a heavy burden of debt Grey frequently implored the queen to recall him, and in August 1582 he was allowed to return to England (see E. Spenser, *View of the State of Ireland*, edited by H. Morley, 1890, and R. Bagwell, *Ireland under the Tudors*, vol. iii., 1890). While in Ireland Grey was served as secretary by Edmund Spenser, and in book v. of the *Faerie Queene* the poet represents his patron as a knight of very noble qualities named Artagall. As one of the commissioners who tried Mary queen of Scots, Grey defended the action of Elizabeth's secretary, William Davison, with regard to this matter, and he took part in the preparations for the defence of England against the Spaniards in 1588. His

account of the defence of Guines was used by Holinshed in his *Chronicles*.

When he died on the 14th of October 1593 he was succeeded as 15th baron by his son THOMAS (d. 1614), who while serving in Ireland incurred the enmity of Robert Devereux, earl of Essex, and of Henry Wriothesley, earl of Southampton; and after fighting against Spain in the Netherlands he was a member of the court which sentenced these two noblemen to death in 1601. On the accession of James I. he was arrested for his share in the "Bye" plot, an attempt made by William Watson and others to seize the king. He was tried and sentenced to death, but the sentence was not carried out and he remained in prison until his death on the 9th of July 1614. He displayed both ability and courage at his trial, remarking after sentence had been passed, "the house of Wilton hath spent many lives in their prince's service and Grey cannot beg his." Like his father Grey was a strong Puritan. He left no children and his barony became extinct.

In 1784 Sir Thomas Egerton, Bart., a descendant in the female line of the 14th baron, was created Baron Grey de Wilton. He died without sons in September 1814, when his barony became extinct; but the titles of Viscount Grey de Wilton and earl of Wilton, which had been conferred upon him in 1801, passed to Thomas Grosvenor (1799-1882), the second son of his daughter Eleanor (d. 1846), and her husband Robert Grosvenor, 1st marquess of Westminster. Thomas took the name of Egerton and his descendants still hold the titles.

ROGER GREY, 1ST BARON GREY DE RUTHYN, who was summoned to parliament as a baron in 1324, saw much service as a soldier before his death on the 6th of March 1353. The second baron was his son Reginald, whose son REGINALD (c. 1362-1440) succeeded to the title on his father's death in July 1388. In 1410 after a long dispute the younger Reginald won the right to bear the arms of the Hastings family. He enjoyed the favour both of Richard II. and Henry IV., and his chief military exploits were against the Welsh, who took him prisoner in 1402 and only released him upon payment of a heavy ransom. Grey was a member of the council which governed England during the absence of Henry V. in France in 1415; he fought in the French wars in 1420 and 1421 and died on the 30th of September 1440. His eldest son, Sir John Grey, K.G. (d. 1439), who predeceased his father, fought at Agincourt and was deputy of Ireland in 1427. He was the father of EDMUND GREY (d. 1489), who succeeded his grandfather as Lord Grey de Ruthyn in 1440 and was created earl of Kent in 1465.

One of Reginald Grey's younger sons, Edward (1415-1457), succeeded his maternal grandfather as Baron Ferrers of Groby in 1445. He was the ancestor of the earls of Stamford and also of the Greys, marquesses of Dorset and dukes of Suffolk.

The barony of Grey de Ruthyn was merged in the earldom of Kent until the death of Henry, the 8th earl, in November 1639. It then devolved upon Kent's nephew Charles Longueville (1612-1643), through whose daughter Susan (d. 1676) it came to the family of Yelverton, who were earls of Sussex from 1717 to 1799. The next holder was Henry Edward Gould (1780-1810), a grandson of Henry Yelverton, earl of Sussex; and through Gould's daughter Barbara, marchioness of Hastings (d. 1858), it passed to the last marquess of Hastings whose death in 1868 the barony fell into abeyance, this being terminated in 1885 in favour of Hastings's sister Bertha (d. 1887), the wife of Augustus Wykeham Clifton. Their son, Rawdon George Grey Clifton (b. 1858), succeeded his mother as 24th holder of the barony.

GREYMOUTH, a seaport of New Zealand, the principal port on the west coast of South Island, in Grey county. Pop. (1906) 4560. It stands on the small estuary of the Grey or Mawhera river, has a good harbour, and railway communication with Hokitika, Reefton, &c., while the construction of a line to connect with Christchurch and Nelson was begun in 1887. The district is both auriferous and coal-bearing. Gold-dredging is a rich industry, and the coal-mines have attendant industries in coke, bricks and fire-clay. The timber trade is also well developed. The neighbouring scenery is picturesque, especially among the hills surrounding Lake Brunner (15 m. S.E.).

GREYTOWN (SAN JUAN DEL NORTE), the principal seaport on the Caribbean coast of Nicaragua, in the extreme south-eastern corner of the republic, and at the mouth of the northern channel of the San Juan river delta. Pop. (1905) about 2500. The town

occupies the seaward side of a narrow peninsula, formed by the windings of the river. Most of its houses are raised on piles 2 or 3 ft. above the ground. The neighbourhood is unhealthy and unsuited for agriculture, so that almost all food-stuffs must be imported, and the cost of living is high. Greytown has suffered severely from the accumulation of sand in its once fine harbour. Between 1832 and 1848 Point Arenas, the seaward end of the peninsula, was enlarged by a sandbank more than 1 m. long; between 1850 and 1875 the depth of water over the bar decreased from about 25 ft. to 5 ft., and the entrance channel, which had been nearly $\frac{1}{2}$ m. wide, was almost closed. Subsequent attempts to improve the harbour by dredging and building jetties have only had partial success; but Greytown remains the headquarters of Nicaraguan commerce with Europe and eastern America. The village called America, 1 m. N., was built as the eastern terminus of a proposed interoceanic canal.

The harbour of San Juan, discovered by Columbus, was brought into further notice by Captain Diego Machuca, who in 1529 sailed down the river from Lake Nicaragua. The date of the first Spanish settlement on the spot is not known, but in the 17th century there were fortifications at the mouth of the river. In 1796 San Juan was made a port of entry by royal charter, and new defences were erected in 1821. In virtue of the protectorate claimed by Great Britain over the Mosquito Coast (q.v.), the Mosquito Indians, aided by a British force, seized the town in 1848 and occupied it until 1860, when Great Britain ceded its protectorate to Nicaragua by the treaty of Managua. This treaty secured religious liberty and trial by jury for all civil and criminal charges in Greytown; its seventh article declared the port free, but was never enforced.

GREYWACKE, or GRAUWACKE (a German word signifying a grey earthy rock), the designation, formerly more generally used by English geologists than at the present day, for impure, highly composite, gritty rocks belonging to the Palaeozoic systems. They correspond to the sandstones, grits and fine conglomerates of the later periods. Greywackes are mostly grey, brown, yellow or black, dull-coloured, sandy rocks which may occur in thick or thin beds along with slates, limestones, &c., and are abundant in Wales, the south of Scotland and the Lake district of England. They contain a very great variety of minerals, of which the principal are quartz, orthoclase and plagioclase, calcite, iron oxides and graphitic carbonaceous matters, together with (in the coarser kinds) fragments of such rocks as felsite, chert, slate, gneiss, various schists, quartzite. Among other minerals found in them are biotite and chlorite, tourmaline, epidote, apatite, garnet, hornblende and augite, sphene, pyrites. The cementing material may be siliceous or argillaceous, and is sometimes calcareous. As a rule greywackes are not fossiliferous, but organic remains may be common in the finer beds associated with them. Their component particles are usually not much rounded by attrition, and the rocks have often been considerably indurated by pressure and mineral changes, such as the introduction of interstitial silica. In some districts the greywackes are cleaved, but they show phenomena of this kind much less perfectly than the slates. Although the group is so diverse that it is difficult to characterize mineralogically, it has a well-established place in petrographical classifications, because these peculiar composite arenaceous deposits are very frequent among Silurian and Cambrian rocks, and rarely occur in Secondary or Tertiary systems. Their essential features are their gritty character and their complex composition. By increasing metamorphism greywackes frequently pass into mica-schists, chloritic schists and sedimentary gneisses. (J. S. F.)

GRIBEAUVAL, JEAN BAPTISTE DE (1715-1789), French artillery general, was the son of a magistrate of Amiens and was born there on the 15th of September 1715. He entered the French royal artillery in 1732 as a volunteer, and became an officer in 1735. For nearly twenty years regimental duty and scientific work occupied him, and in 1752 he became captain of a company of miners. A few years later he was employed in a military mission in Prussia. In 1757, being then a lieutenant-

colonel, he was lent to the Austrian army on the outbreak of the Seven Years' War, and served as a general officer of artillery. The siege of Glatz and the defence of Schweidnitz were his principal exploits. The empress Maria Theresa rewarded him for his work with the rank of lieutenant field-marshal and the cross of the Maria Theresa order. On his return to France he was made *maréchal de camp*, in 1764 inspector of artillery, and in 1765 lieutenant-general and commander of the order of St. Louis. For some years after this he was in disfavour at court, and he became first inspector of artillery only in 1776, in which year also he received the grand cross of the St. Louis order. He was now able to carry out the reforms in the artillery arm which are his chief title to fame. See ARTILLERY; and for full details Gribeauval's own *Table des constructions des principaux attributs de l'artillerie . . . de M. de Gribeauval*, and the *reglement for the French artillery* issued in 1776. He died in 1789.

See Puysegur in *Journal de Paris*, supplement of the 8th of July 1789; Chevalier de Passac, *Précis sur M. de Gribeauval* (Paris, 1816); Veyrines, *Gribeauval* (Paris, 1880); and Heanfert, *Gribeauval, lieutenant-général des armées du roy* (Paris, 1896).

GRIBOYEDOV, ALEXANDER SERGUEEVICH (1795-1829), Russian dramatic author, was born in 1795 at Moscow, where he studied at the university from 1810 to 1812. He then obtained a commission in a hussar regiment, but resigned it in 1816. Next year he entered the civil service, and in 1818 was appointed secretary of the Russian legation in Persia, whence he was transferred to Georgia. He had commenced writing early, and had produced on the stage at St. Petersburg in 1816 a comedy in verse, translated from the French, called *The Young Spouses*, which was followed by other pieces of the same kind. But neither these nor the essays and verses which he wrote would have been long remembered but for the immense success gained by his comedy in verse, *Coré et Uma*, or "Misfortune from Intelligence" (Eng. trans. by N. Benardaky, 1857). A satire upon Russian society, or, as a high official styled it, "A pasquinade on Moscow," its plot is slight, its merits consisting in its accurate representation of certain social and official types—such as Famousoff, the lover of old abuses, the hater of reforms; his secretary, Molchanin, servile fawner upon all in office; the aristocratic young liberal and Anglomaniac, Repetiloff; contrasted with whom is the hero of the piece, Tchatsky, the ironical satirist, just returned from the west of Europe, who exposes and ridicules the weaknesses of the rest, his words echoing that outcry of the young generation of 1820 which reached its climax in the military insurrection of 1825, and was then sternly silenced by Nicholas. Griboyedov spent the summer of 1823 in Russia, completed his play and took it to St. Petersburg. There it was rejected by the censorship. Many copies were made and privately circulated, but Griboyedov never saw it published. The first edition was printed in 1833, four years after his death. Only once did he see it on the stage, when it was acted by the officers of the garrison at Erivan. Soured by disappointment he returned to Georgia, made himself useful by his linguistic knowledge to his relative Count Paskievitch-Erivansky during a campaign against Persia, and was sent to St. Petersburg with the treaty of 1828. Brilliantly received there, he thought of devoting himself to literature, and commenced a romantic drama, *A Georgian Night*. But he was suddenly sent to Persia as minister-plenipotentiary. Soon after his arrival at Teheran a tumult arose, caused by the anger of the populace against some Georgian and Armenian captives—Russian subjects—who had taken refuge in the Russian embassy. It was stormed, Griboyedov was killed (February 11, 1829), and his body was for three days so ill-treated by the mob that it was at last recognized only by an old scar on the hand, due to a wound received in a duel. It was taken to Tiflis, and buried in the monastery of St. David. There a monument was erected to his memory by his widow, to whom he had been but a few months married.

GRIEG, EDVARD HAGERUP (1843-1907), Norwegian musical composer, was born on the 15th of June 1843 in Bergen, where his father, Alexander Greig (*sic*), was English consul. The Greig family were of Scottish origin, but the composer's grandfather,

a supporter of the Pretender, left his home at Aberdeen after Charles Edward's defeat at Culloden, and went to Bergen, where he carried on business. The composer's mother, Gesino Hagerup, belonged to a pure Norwegian peasant family; and it is from the mother rather than from the father that Edvard Grieg derived his musical talent. She had been educated as a pianist and began to give her son lessons on the pianoforte when he was six years of age. His first composition, "Variations on a German melody," was written at the age of nine. A summer holiday in Norway with his father in 1858 seems to have exercised a powerful influence on the child's musical imagination, which was easily kindled at the sight of mountain and fjord. In the autumn of the same year, at the recommendation of Ole Bull, young Grieg entered the Leipzig Conservatorium, where he passed, like all his contemporaries, under the influence of the Mendelssohn and Schumann school of romantics. But the curriculum of academic study was too narrow for him. He dreamed half his time away and overworked during the other half. In 1862 he completed his Leipzig studies, and appeared as pianist and composer before his fellow-citizens of Bergen. In 1863 he studied in Copenhagen for a short time with Gade and Emil Hartmann, both composers representing a sentimental strain of Scandinavian temperament, from which Grieg emancipated himself in favour of the harder inspiration of Richard Nordraak. "The scales fell from my eyes," says Grieg of his acquaintance with Nordraak. "For the first time I learned through him to know the northern folk tunes and my own nature. We made a pact to combat the effeminate Gade-Mendelssohn mixture of Scandinavianism, and boldly entered upon the new path along which the northern school at present pursues its course." Grieg now made a kind of crusade in favour of national music. In the winter of 1864-1865 he founded the Copenhagen concert-society *Euterpe*, which was intended to produce the works of young Norwegian composers. During the winters of 1865-1866 and 1869-1870 Grieg was in Rome. In the autumn of 1866 he settled in Christiania, where from 1867 till 1880 he conducted a musical union. From 1880 to 1882 he directed the concerts of the Harmonic Society in Bergen. In 1872 the Royal Musical Academy of Sweden made Grieg a member; in 1874 the Norwegian Storting granted him an annual stipend of 1600 kroner. He had already been decorated with the Olaf order in 1873. In 1888 he played his pianoforte concerto and conducted his "two melodies for strings" at a Philharmonic concert in London, and visited England again in 1891, 1894 and 1896, receiving the degree of Mus.D. from the university of Cambridge in 1894. He died at Bergen on the 4th of September 1907.

As a composer Grieg's distinguishing quality is lyrical. Whether his orchestral works or his songs or his best pianoforte works are submitted to examination, it is almost always the note of song that tells. Sometimes, as in the music to Ibsen's *Peer Gynt*, or in the suite for stringed orchestra, *Aus Holbergs Zeit*, this characteristic is combined with a strong power for raising pictures in the listener's mind, and the romantic "programme" tendency in Grieg's music becomes clearer: the farther writers like Richard Strauss carry this movement. Grieg's songs may be said to be generally the more spontaneous the more closely they conform to the simple model of the *Volskied*; yet the much sung "Ich liebe dich" is a song of a different kind, which has hardly ever been surpassed for the perfection with which it depicts a strong momentary emotion, and it is difficult to ascribe greater merits to songs of Grieg even so characteristic as "Solvejgs Lied" and "Ein Schwan." The pianoforte concerto is brilliant and spontaneous; it has been performed by most pianists of the first rank, but its essential qualities and the pure nationality of its themes have been brought out to their perfection by one player only—the Norwegian pianist Knudsen. The first and second of Grieg's violin sonatas are agreeable, so free and artless is the flow of their melody. In his numerous piano pieces and in those of his songs which are devoid of a definitely national inspiration the impression made is less permanent. Bülow called Grieg the "Chopin of the North." The phrase is an exaggeration rather than an expression of the truth, for

the range of the appeal in Chopin is far wider, nor has the national movement inaugurated by Grieg shown promise of great development. He is rather to be regarded as the pioneer of a musical mission which has been perfectly carried out by himself alone.

See La Mara, *Edvard Grieg* (Leipzig, 1898).

GRIESBACH, JOHANN JAKOB (1745-1812), German biblical critic, was born at Butzbach, a small town of Hesse-Darmstadt, where his father, Konrad Kaspar (1705-1777), was pastor, on the 4th of January 1745. He was educated at Frankfurt-on-the-Main, and at the universities of Tübingen, Leipzig and Halle, where he became one of J. S. Semler's most ardent disciples. It was Semler who induced him to turn his attention to the textual criticism of the New Testament. At the close of his undergraduate career he undertook a literary tour through Germany, Holland, France and England. On his return to Halle, he acted for some time as *Privatdozent*, but in 1773 was appointed to a professorial chair; in 1775 he was translated to Jena, where the rest of his life was spent (though he received calls to other universities). He died on the 24th of March 1812. Griesbach's fame rests upon his work in New Testament criticism, in which he inaugurated a new epoch.

His critical edition of the New Testament first appeared at Halle, in three volumes, in 1774-1775. The first volume contained the first three Gospels, synoptically arranged; the second, the Epistles and the book of Revelation. All the historical books were reprinted in one volume in 1777, the synoptical arrangement of the Gospels having been abandoned as inconvenient. Of the second edition, considerably enlarged and improved, the first volume appeared in 1796 and the second in 1806 (Halle and London). Of a third edition, edited by David Schulz, only the first volume, containing the four Gospels, appeared (1827).

For the construction of his critical text Griesbach took as his basis the Elzevir edition. Where he differed from it he placed the Elzevir reading on the inner margin along with other readings he thought worthy of special consideration (these last, however, being printed in smaller type). To all the readings on this margin he attached special marks indicating the precise degree of probability in his opinion attaching to each. In weighing these probabilities he proceeded upon a particular theory which in its leading features he had derived from J. A. Bengel and J. S. Semler, dividing all the MSS. into three main groups—the Alexandrian, the Western and the Byzantine (see *BIBLES: New Testament*, "Textual Criticism"). A reading supported by only one recension he considered as having only one witness in its favour; those readings which were supported by all the three recensions, or even by two of them, especially if these two were the Alexandrian and the Western, he unhesitatingly accepted as genuine. Only when each of the three recensions gives a different reading does he proceed to discuss the question on other grounds. See his *Symbolae criticae ad supplendas et corrigendas variorum N.T. lectionum collectiones* (Halle, 1785, 1793), and his *Commentarius criticus in lectum Graecum N.T.*, which extends to the end of Mark, and discusses the more important various readings with great care and thoroughness (Jena, 1794 ff.). Among the other works of Griesbach (which are comparatively unimportant) may be mentioned his university thesis *De codicibus quatuor evangelistarum Origenianis* (Halle, 1771) and a work upon systematic theology (*Anleitung zur Kenntniss der populären Dogmatik*, Jena, 1779). His *Opuscula*, consisting chiefly of university "Programs" and addresses, were edited by Gabler (2 vols., Jena, 1824).

See the article in Herzog-Hauck, *Realencyklopädie*, and the *Allgemeine deutsche Biographie*.

GRIESBACH, a watering-place in the grand duchy of Baden, in the valley of the Rench, 1550 ft. above the sea, 6 m. W. from Freudenstadt in Württemberg. It is celebrated for its saline chalybeate waters (twelve springs), which are specific in cases of anaemia, feminine disorders and diseases of the nervous system, and were used in the 16th century. The annual number of visitors is nearly 2000. Pop. (1900) 800. From 1665 to 1805 Griesbach was part of the bishopric of Strassburg.

See Haberer, *Die Renchbäder Petersthal und Griesbach* (Würzburg, 1866).

GRIFFE (French for "claw"), an architectural term for the spur, an ornament carved at the angle of the square base of columns.

GRIFFENFELDT, PEDER, COUNT (*Peder Schumacher*) (1635-1699), Danish statesman, was born at Copenhagen on the 24th of August 1635, of a wealthy trading family connected with the leading civic, clerical and learned circles in the Danish capital. His tutor, Jens Vorde, who prepared him in his eleventh year for the university, praises his extraordinary gifts, his mastery

of the classical languages and his almost disquieting diligence. The brilliant way in which he sustained his preliminary examination won him the friendship of the examiner, Bishop Jasper Brokman, at whose palace he first met Frederick III. The king was struck with the lad's bright grey eyes and pleasant humorous face; and Brokman, proud of his pupil, made him translate a chapter from a Hebrew Bible first into Latin and then into Danish, for the entertainment of the scholarly monarch. In 1654 young Schumacher went abroad for eight years, to complete his education. From Germany he proceeded to the Netherlands, staying at Leiden, Utrecht and Amsterdam, and passing in 1657 to Queen's College, Oxford, where he lived three years. The epoch-making events which occurred in England, while he was at Oxford profoundly interested him, and coinciding with the Revolution in Denmark, which threw open a career to the middle classes, convinced him that his proper sphere was politics. In the autumn of 1660 Schumacher visited Paris, shortly after Mazarin's death, when the young Louis XIV. first seized the reins of power. Schumacher seems to have been profoundly impressed by the administrative superiority of a strong centralised monarchy in the hands of an energetic monarch who knew his own mind; and, in politics, as in manners, France ever afterwards was his model. The last year of his travels was spent in Spain, where he obtained a thorough knowledge of the Castilian language and literature. His travels, however, if they enriched his mind, relaxed his character, and he brought home easy morals as well as exquisite manners.

On his return to Copenhagen, in 1662, Schumacher found the monarchy established on the ruins of the aristocracy, and eager to buy the services of every man of the middle classes who had superior talents to offer. Determined to make his way in this "new Promised Land," the young adventurer contrived to secure the protection of Kristoffer Gabel, the king's confidant, and in 1663 was appointed the royal librarian. A romantic friendship with the king's bastard, Count Ulric Frederick Gyldenløve, consolidated his position. In 1665 Schumacher obtained his first political post as the king's secretary, and the same year composed the memorable *Kongelov* (see *DENMARK, History*). He was now a personage at court, where he won all hearts by his amiability and gaiety; and in political matters also his influence was beginning to be felt.

On the death of Frederick III. (February 9th, 1670) Schumacher was the most trusted of all the royal counsellors. He alone was aware of the existence of the new throne of walrus ivory embellished with three silver life-size lions, and of the new regalia, both of which treasures he had, by the king's command, concealed in a vault beneath the royal castle. Frederick III. had also confided to him a sealed packet containing the *Kongelov*, which was to be delivered to his successor alone. Schumacher had been recommended to his son by Frederick III. on his deathbed. "Make him a great man, but do it slowly!" said Frederick, who thoroughly understood the characters of his son and of his minister. Christian V. was, moreover, deeply impressed by the confidence which his father had ever shown to Schumacher. When, on the 9th of February 1670, Schumacher delivered the *Kongelov* to Christian V., the king bade all those about him withdraw, and after being closeted a good hour with Schumacher, appointed him his "Obergeheimsekretär." His promotion was now almost disquietingly rapid. In May 1670 he received the titles of excellency and privy councillor; in July of the same year he was ennobled under the name of Griffenfeldt, deriving his title from the gold griffin with outspread wings which surmounted his escutcheon; in November 1673 he was created a count, a knight of the Elephant and, finally, imperial chancellor. In the course of the next few months he gathered into his hands every branch of the government: he had reached the apogee of his short-lived greatness.

But if his offices were manifold, so also were his talents. Seldom has any man united so many and such various gifts in his own person and carried them so easily—a playful wit, a vivid imagination, oratorical and literary eloquence and, above all, a profound knowledge of human nature both male and female,

of every class and rank, from the king to the meanest citizen. He had captivated the accomplished Frederick III. by his literary graces and ingenious speculations; he won the obtuse and ignorant Christian V. by saving him trouble, by acting and thinking for him, and at the same time making him believe that he was thinking and acting for himself. Moreover, his commanding qualities were coupled with an organizing talent which made itself felt in every department of the state, and with a marvellous adaptability which made him an ideal diplomatist.

On the 25th of May 1671 the dignities of count and baron were introduced into Denmark "to give lustre to the court"; a few months later the order of the Dannebrog was instituted as a fresh means of winning adherents by marks of favour. Griffenfeldt was the originator of these new institutions. To him monarchy was the ideal form of government. But he had also a political object. The aristocracy of birth, despite its reverence, still remained the élite of society; and Griffenfeldt, the son of a burgher as well as the protagonist of monarchy, was its most determined enemy. The new baronies and countships, owing their existence entirely to the crown, introduced a strong solvent into aristocratic circles. Griffenfeldt saw that, in future, the first at court would be the first everywhere. Much was also done to promote trade and industry, notably by the revival of the *Kammer Kollegium*, or board of trade, and the abolition of some of the most harmful monopolies. Both the higher and the provincial administrations were thoroughly reformed with the view of making them more centralised and efficient; and the positions and duties of the various magistrates, who now also received fixed salaries, were for the first time exactly defined. But what Griffenfeldt could create, Griffenfeldt could dispense with, and it was not long before he began to encroach upon the jurisdiction of the new departments of state by private conferences with their chiefs. Nevertheless it is indisputable that, under the single direction of this master-mind, the Danish state was now able, for a time, to utilize all its resources as it had never done before.

In the last three years of his administration, Griffenfeldt gave himself entirely to the conduct of the foreign policy of Denmark. It is difficult to form a clear idea of this, first, because his influence was perpetually traversed by opposite tendencies; in the second place, because the force of circumstances compelled him, again and again, to shift his standpoint; and finally because personal considerations largely intermingled with his foreign policy, and made it more elusive and ambiguous than it need have been. Briefly, Griffenfeldt aimed at restoring Denmark to the rank of a great power. He proposed to accomplish this by carefully nursing her resources, and in the meantime securing and enriching her by alliances, which would bring in large subsidies while imposing a minimum of obligations. Such a conditional and tentative policy, on the part of a second-rate power, in a period of universal tension and turmoil, was most difficult; but Griffenfeldt did not regard it as impossible. The first postulate of such a policy was peace, especially peace with Denmark's most dangerous neighbour, Sweden. The second postulate was a sound financial basis, which he expected the wealth of France to supply in the shape of subsidies to be spent on armaments. Above all things Denmark was to beware of making enemies of France and Sweden at the same time. An alliance, on fairly equal terms, between the three powers, would, in these circumstances, be the consummation of Griffenfeldt's "system"; an alliance with France to the exclusion of Sweden would be the next best policy; but an alliance between France and Sweden, without the admission of Denmark, was to be avoided at all hazards. Had Griffenfeldt's policy succeeded, Denmark might have recovered her ancient possessions to the south and east comparatively cheaply. But again and again he was overruled. Despite his open protests and subterranean counter-mining, war was actually declared against Sweden in 1675, and his subsequent policy seemed so obscure and hazardous to those who did not possess the clue to the perhaps purposely tangled skein, that the numerous enemies whom his arrogance

and superciliousness had raised up against him, resolved to destroy him.

On the 11th of March 1676, while on his way to the royal apartments, Griffenfeldt was arrested in the king's name and conducted to the citadel, a prisoner of state. A minute scrutiny of his papers, lasting nearly six weeks, revealed nothing treasonable; but it provided the enemies of the fallen statesman with a deadly weapon against him in the shape of an entry in his private diary, in which he had imprudently noted that on one occasion Christian V. in a conversation with a foreign ambassador had "spoken like a child." On the 3rd of May Griffenfeldt was tried not by the usual tribunal, in such cases the *Højesteret*, or supreme court, but by an extraordinary tribunal of 10 dignitaries, none of whom was particularly well disposed towards the accused. Griffenfeldt, who was charged with simony, bribery, oath-breaking, malversation and *lese-majesté*, conducted his own defence under every imaginable difficulty. For forty-six days before his trial he had been closely confined in a dungeon without lights, books or writing materials. Every legal assistance was illegally denied him. Nevertheless he proved more than a match for the forensic ability arrayed against him, and his first plea in defence is in a high degree dignified and manly. Finally, he was condemned to degradation and decapitation; though one of the ten judges not only refused to sign the sentence, but remonstrated in private with the king against its injustice. And indeed its injustice was flagrant. The primary offence of the ex-chancellor was the taking of bribes, while no twisting of the law could convert into a capital offence, which the charge of treason had not been substantiated. Griffenfeldt was pardoned on the scaffold, at the very moment when the axe was about to descend. On hearing that the sentence was commuted to life-long imprisonment, he declared that the pardon was harder than the punishment, and vainly petitioned for leave to serve his king for the rest of his life as a common soldier. For the next two and twenty years Denmark's greatest statesman lingered out his life in a lonely state-prison, first in the fortress of Copenhagen, and finally at Munkholm on Trondhjem fiord. He died at Trondhjem on the 12th of March 1699. Griffenfeldt married Kitty Nansen, the granddaughter of the great Burgomaster Hans Nansen, who brought him half a million rix-dollars. She died in 1672, after bearing him a daughter.

See *Denmark's Riges Historie*, vol. v. (Copenhagen, 1897-1905); Jørgensen. *Peter Schumacher-Griffenfeldt* (Copenhagen, 1893-1894); O. Vauppel, *Rigskansler Grev Griffenfeldt* (Copenhagen, 1880-1882); Bain, *Scandinavia*, cap. x. (Cambridge, 1905). (R. N. B.)

GRIFFIN [O'GRIFFIN, O'GREEVA], GERALD (1803-1840), Irish novelist and dramatic writer, was born at Limerick of good family, on the 12th of December 1803. His parents emigrated in 1820 to America, but he was left with an elder brother, who was a medical practitioner at Adare. As early as his eighteenth year he undertook for a short time the editorship of a newspaper in Limerick. Having written a tragedy, *Aguire*, which was highly praised by his friends, he set out in 1823 for London with the purpose of "revolutionizing the dramatic taste of the time by writing for the stage." In spite of the recommendations of John Banim, he had a hard struggle with poverty. It was only by degrees that his literary work obtained any favour. *The Noyades*, an opera entirely in recitative, was produced at the English Opera House in 1826; and the success of *Holland Tide Tales* (1827) led to *Tales of the Munster Festivals* (3 vols., 1827), which were still more popular. In 1829 appeared his fine novel, *The Collegians*, afterwards successfully adapted for the stage by Dion Boucicault under the title of *The Colleen Bawn*. He followed up this success with *The Invasion* (1832), *Tales of my Neighbourhood* (1835), *The Duke of Monmouth* (1836), and *Talis Qualis, or Tales of the Jury-room* (1842). He also wrote a number of lyrics touched with his native melancholy. But he became doubtful as to the moral influence of his writings, and ultimately he came to the conclusion that his true sphere of duty was to be found within the Church. He was admitted into a society of the Christian Brothers at Dublin, in September 1838; under the name of Brother Joseph, and in the following summer

be removed to Cork, where he died of typhus fever on the 12th of June 1840. Before adopting the monastic habit he burned all his manuscripts; but *Gisippus*, a tragedy which he had composed before he was twenty, accidentally escaped destruction, and in 1842 was put on the Drury Lane stage by Macready with great success.

The collected works of Gerald Griffin were published in 1842-1843 in eight volumes, with a *Life* by his brother William Griffin, M.D.; an edition of his *Poetical and Dramatic Works* (Dublin, 1895) by C. G. Duffy; and a selection of his lyrics, with a notice by George Sgerson, is included in the *Treasury of Irish Poetry*, edited by Stopford A. Brooke and T. W. Rolleston (London, 1900).

GRIFFIN, a city and the county-seat of Spalding county, Georgia, U.S.A., 43 m. S. of Atlanta, and about 970 ft. above the sea. Pop. (1890) 4503; (1900) 6857 (3258 negroes); (1910) 7478. It is served by the Southern and the Central of Georgia railways, and is the southern terminus of the Griffin & Chattanooga Division of the latter. The city is situated in a rich agricultural region, and just outside the corporate limits is an agricultural experiment station, established by the state but maintained by the Federal government. Griffin has a large trade in cotton and fruit. The principal industry is the manufacture of cotton and cotton-seed oil. Buggies, wagons, chairs and harness are among the other manufactures. The municipality owns and operates the water and electric-lighting systems. Griffin was founded in 1840 and was chartered as a city in 1846.

GRIFFIN, **GRIFFON** or **GRYPHON** (from Fr. *griffon*, Lat. *griffus*, Gr. *γρύψ*), in the natural history of the ancients, the name of an imaginary rapacious creature of the eagle species, represented with four legs, wings and a beak,—the fore part resembling an eagle and the hinder a lion. In addition, some writers describe the tail as a serpent. This animal, which was supposed to watch over gold mines and hidden treasures, and to be the enemy of the horse, was consecrated to the Sun; and the ancient painters represented the chariot of the Sun as drawn by griffins. According to Spanheim, those of Jupiter and Nemesis were similarly provided. The griffin of Scripture is probably the osprey, and the name is now given to a species of vulture. The griffin was said to inhabit Asiatic Scythia, where gold and precious stones were abundant; and when strangers approached to gather these the creatures leapt upon them and tore them in pieces, thus chastising human avarice and greed. The one-eyed Arimaspi waged constant war with them, according to Herodotus (iii. 16). Sir John de Mandeville, in his *Travels*, described a griffin as eight times larger than a lion.

The griffin is frequently seen as a charge in heraldry (see **HERALDRY**, fig. 163); and in architectural decoration is usually represented as a four-footed beast with wings and the head of a leopard or tiger with horns, or with the head and beak of an eagle; in the latter case, but very rarely, with two legs. To what extent it owes its origin to Persian sculpture is not known, the capitals at Persepolis have sometimes leopard or lion heads with horns, and four-footed beasts with the beaks of eagles are represented in bas-reliefs. In the temple of Apollo Branchidae near Miletus in Asia Minor, the winged griffin of the capitals has leopards' heads with horns. In the capitals of the so-called lesser propylaea at Eleusis conventional eagles with two feet support the angles of the abacus. The greater number of those in Rome have eagles' beaks, as in the frieze of the temple of Antoninus and Faustina, and their tails develop into conventional foliage. A similar device was found in the Forum of Trajan. The best decorative employment of the griffin is found in the vertical supports of tables, of which there are two or three examples in Pompeii and others in the Vatican and the museums in Rome. In some of these cases the head is that of a lion at one end of the support and an eagle at the other end, and there is only one strongly developed paw; the wings circling round at the top form conspicuous features on the sides of these supports, the surfaces below being filled with conventional Greek foliage.

GRIFFITH, **SIR RICHARD JOHN** (1784-1878), Irish geologist, was born in Dublin on the 20th of September 1784. He obtained in 1809 a commission in the Royal Irish Artillery, but a year

later, when the corps was incorporated with that of England, he retired, and devoted his attention to civil engineering and mining. He studied chemistry, mineralogy and mining for two years in London under William Nicholson (editor of the *Journal of Nat. Phil.*), and afterwards examined the mining districts in various parts of England, Wales and Scotland. While in Cornwall he discovered ores of nickel and cobalt in material that had been rejected as worthless. He completed his studies under Robert Jameson and others at Edinburgh, was elected a Fellow of the Royal Society of Edinburgh in 1807, a member of the newly established Geological Society of London in 1808, and in the same year he returned to Ireland. In 1809 he was appointed by the commissioners to inquire into the nature and extent of the bogs in Ireland, and the means of improving them. In 1812 he was elected professor of geology and mining engineer to the Royal Dublin Society. During subsequent years he made many surveys and issued many reports on mineral districts in Ireland, and these formed the foundation of his first geological map of the country (1815). In 1822 Griffith became engineer of public works in Cork, Kerry and Limerick, and was occupied until 1830 in repairing old roads and in laying out many miles of new roads. Meanwhile in 1825 he was appointed to carry out the perambulation or boundary survey of Ireland, the object of which was to ascertain and mark the boundaries of every county, barony, parish and townland in preparation for the ordnance survey. This work was finished in 1844. He was also called upon to assist in preparing a bill for the general valuation of Ireland; the act was passed in 1826, and he was appointed commissioner of valuation, in which capacity he continued to act until 1868. On "Griffith's valuation" the various local and public assessments were made. His extensive investigations furnished him with ample material for improving his geological map, and the second edition was published in 1835. A third edition on a larger scale (1 in. to 4 m.) was issued under the Board of Ordnance in 1839, and it was further revised in 1855. For this great work and his other services to science he was awarded the Wollaston medal by the Geological Society in 1854. In 1850 he was made chairman of the Irish Board of Works, and in 1858 he was created a baronet. He died in Dublin on the 22nd of September 1878.

Among his many geological works the following may be mentioned: *Outline of the Geology of Ireland* (1838); *Notice respecting the Fossils of the Mountain Limestone of Ireland, as compared with those of Great Britain, and also with the Devonian System* (1842); *A Synopsis of the Characters of the Carboniferous Limestone Fossils of Ireland* (1846) (with F. McCoy); *A Synopsis of the Silurian Fossils of Ireland* (1846) (with F. McCoy). See *memoirs in Quart. Journ. Geol. Soc.* xxxv. 39; and *Geol. Mag.*, 1878, p. 524, with bibliography.

GRILLE, a French term for an enclosure in either iron or bronze; there is no equivalent in English, "grating" applying more to a horizontal frame of bars over a sunk area, and "grate" to the iron bars of an open fireplace. The finest examples of the grille are those known as the *rejas*, which in Spanish churches form the enclosures of the chapels, such as the *reja* in the Capilla Real at Granada in wrought iron partly gilt (1522). Similar grilles are employed to protect the ground-floor windows of mansions not only in Spain but in Italy and Germany. In England the most beautiful example is that in front of Queen Eleanor's tomb in Westminster Abbey, in wrought iron. The finest grilles in Italy are the enclosures of the tombs of the Della Scalas at Verona (end of 13th century), in Germany the grille of the cenotaph of Maximilian at Innsbruck (early 16th century) and in France those which enclose the Place Stanislaus, the Place de la Carrière and the churches of Nancy, which were wrought by Jean Lamour in the middle of the 18th century. Generally, however, throughout Germany the wrought iron grilles are fine examples of forging, and they are employed for the enclosures of the numerous fountains, in the tympana of gateways, and for the protection of windows. At Danzig in the Marienkirche are some fine examples in brass.

GRILLPARZER, **FRANZ** (1791-1872), the greatest dramatic poet of Austria, was born in Vienna, on the 15th of January 1791. His father, severe, pedantic, a staunch upholder of the liberal traditions of the reign of Joseph II., was an advocate

of some standing; his mother, a nervous, finely-strung woman, belonged to the well-known musical family of Sonnleithner. After a desultory education, Grillparzer entered in 1807 the university of Vienna as a student of jurisprudence; but two years later his father died, leaving the family in straitened circumstances, and Franz, the eldest son, was obliged to turn to private tutoring. In 1813 he received an appointment in the court library, but as this was unpaid, he accepted after some months a clerkship that offered more solid prospects, in the Lower Austrian revenue administration. Through the influence of Graf Stadion, the minister of finance, he was in 1818 appointed poet to the Hofburgtheater, and promoted to the *Hofhammer* (exchequer); in 1832 he became director of the archives of that department, and in 1856 retired from the civil service with the title of *Hofrat*. Grillparzer had little capacity for an official career and regarded his office merely as a means of independence.

In 1817 the first representation of his tragedy *Die Ahnfrau* made him famous, but before this he had written a long tragedy in iambics, *Blanca von Castilien* (1807-1809), which was obviously modelled on Schiller's *Don Carlos*; and even more promising were the dramatic fragments *Spartacus* and *Alfred der Grosse* (1809). *Die Ahnfrau* is a gruesome "fate-tragedy" in the trochaic measure of the Spanish drama, already made popular by Adolf Müllner in his *Schuld*; but Grillparzer's work is a play of real poetic beauties, and reveals an instinct for dramatic as opposed to merely theatrical effect, which distinguishes it from other "fate-dramas" of the day. Unfortunately its success led to the poet's being classed for the best part of his life with playwrights like Müllner and Houwald. *Die Ahnfrau* was followed by *Sappho* (1818), a drama of a very different type; in the classic spirit of Goethe's *Tasso*, Grillparzer unrolled the tragedy of poetic genius, the renunciation of earthly happiness imposed upon the poet by his higher mission. In 1821 appeared *Das goldene Vlies*, a trilogy which had been interrupted in 1819 by the death of the poet's mother—in a fit of depression she had taken her own life—and a subsequent visit to Italy. Opening with a powerful dramatic prelude in one act, *Der Gastfreund*, Grillparzer depicts in *Die Argonauten* Jason's adventures in his quest for the Fleece; while *Medea*, a tragedy of noble classic proportions, contains the culminating events of the story which had been so often dramatized before. The theme is similar to that of *Sappho*, but the scale on which it is represented is larger; it is again the tragedy of the heart's desire, the conflict of the simple happy life with that sinister power—be it genius, or ambition—which upsets the equilibrium of life. The end is bitter disillusionment, the only consolation renunciation. Medea, her revenge stilled, her children dead, bears the fatal Fleece back to Delphi, while Jason is left to realize the nothingness of human striving and earthly happiness.

For his historical tragedy *König Ottokars Glück und Ende* (1823, but owing to difficulties with the censor, not performed until 1825), Grillparzer chose one of the most picturesque events in Austrian domestic history, the conflict of Ottokar of Bohemia with Rudolph von Habsburg. With an almost modern realism he reproduced the motley world of the old chronicler, at the same time not losing sight of the needs of the theatre; the fall of Ottokar is but another text from which the poet preached the futility of endeavour and the vanity of worldly greatness. A second historical tragedy, *Ein treuer Diener seines Herrn* (1826, performed 1828), attempts to embody a more heroic gospel; but the subject—the superhuman self-effacement of Bankbanus before Duke Otto of Meran—proved too uncompromising an illustration of Kant's categorical imperative of duty to be palatable in the theatre. With these historical tragedies began the darkest ten years in the poet's life. They brought him into conflict with the Austrian censor—a conflict which grated on Grillparzer's sensitive soul, and was aggravated by his own position as a servant of the state; in 1826 he paid a visit to Goethe in Weimar, and was able to compare the enlightened conditions which prevailed in the little Saxon duchy with the intellectual thralldom of Vienna. To these troubles were added more serious personal worries. In the winter of

1820-1821 he had met for the first time Katharina Fröhlich (1801-1879), and the acquaintance rapidly ripened into love on both sides; but whether owing to a presentiment of mutual incompatibility, or merely owing to Grillparzer's conviction that life had no happiness in store for him, he shrank from marriage. Whatever the cause may have been, the poet was plunged into an abyss of misery and despair to which his diary bears heart-rending witness; his sufferings found poetic expression in the fine cycle of poems bearing the significant title *Tristia ex Ponte* (1835).

Yet to these years we owe the completion of two of Grillparzer's greatest dramas, *Des Meeres und der Liebe Wellen* (1831) and *Der Traum, ein Leben* (1834). In the former tragedy, a dramatization of the story of Hero and Leander, he returned to the Hellenic world of *Sappho*, and produced what is perhaps the finest of all German love-tragedies. His mastery of dramatic technique is here combined with a ripeness of poetic expression and with an insight into motive which suggests the modern psychological drama of Hebbel and Ibsen; the old Greek love-story of Musaeus is, moreover, endowed with something of that ineffable poetic grace which the poet had borrowed from the great Spanish poets, Lope de Vega and Calderon. *Der Traum, ein Leben*, Grillparzer's technical masterpiece, is in form perhaps even more Spanish; it is also more of what Goethe called a "confession." The aspirations of Rustan, an ambitious young peasant, are shadowed forth in the hero's dream, which takes up nearly three acts of the play; ultimately Rustan awakens from his nightmare to realize the truth of Grillparzer's own pessimistic doctrine that all earthly ambitions and aspirations are vanity; the only true happiness is contentment with one's lot, "des Innern stiller Frieden und die schuldbelebte Brust." *Der Traum, ein Leben* was the first of Grillparzer's dramas which did not end tragically, and in 1838 he produced his only comedy, *Wek' dem, der lügt*. But *Wek' dem, der lügt*, in spite of its humour of situation, its sparkling dialogue and the originality of its idea—namely, that the hero gains his end by invariably telling the truth, where his enemies as invariably expect him to be lying—was too strange to meet with approval in its day. Its failure was a blow to the poet, who turned his back for ever on the German theatre. In 1836 Grillparzer paid a visit to Paris and London, in 1843 to Athens and Constantinople. Then came the Revolution which struck off the intellectual fetters under which Grillparzer and his contemporaries had groaned in Austria, but the liberation came too late for him. Honours were heaped upon him; he was made a member of the Academy of Sciences; Heinrich Laube, as director of the Burgtheater, reinstated his plays on the repertory; he was in 1861 elected to the Austrian *Herrenhaus*; his eightieth birthday was a national festival, and when he died in Vienna, on the 21st of January 1872, the mourning of the Austrian people was universal. With the exception of a beautiful fragment, *Esther* (1861), Grillparzer published no more dramatic poetry after the fiasco of *Wek' dem, der lügt*, but at his death three completed tragedies were found among his papers. Of these, *Die Jüdin von Toledo*, an admirable adaptation from the Spanish, has won a permanent place in the German classical repertory; *Ein Brudermord im Hause Habsburg* is a powerful historical tragedy and *Lisissa* is perhaps the ripest, as it is certainly the deepest, of all Grillparzer's dramas; the latter two plays prove how much was lost by the poet's divorce from the theatre.

Although Grillparzer was essentially a dramatist, his lyric poetry is in the intensity of its personal note hardly inferior to Lenau's; and the bitterness of his later years found vent in biting and stinging epigrams that spared few of his greater contemporaries. As a prose writer, he has left one powerful short story, *Der arme Spielmann* (1848), and a volume of critical studies on the Spanish drama, which shows how completely he had succeeded in identifying himself with the Spanish point of view.

Grillparzer's brooding, unbalanced temperament, his lack of will-power, his pessimistic renunciation and the bitterness which his self-imposed martyrdom produced in him, made him peculiarly adapted to express the mood of Austria in the epoch of intellectual

thrldom that lay between the Napoleonic wars and the Revolution of 1848; his poetry reflects exactly the spirit of his people under the Metternich régime, and there is a deep truth behind the description of *Der Traum, ein Leben* as the Austrian Faust. His fame was in accordance with the general tenor of his life; even in Austria a true understanding for his genius was late in coming, and not until the centenary of 1897 did the German-speaking world realize that it possessed in him a dramatic poet of the first rank; in other words, that Grillparzer was no mere "Epigone" of the classic period, but a poet who, by a rare assimilation of the strength of the Greeks, the imaginative depth of German classicism and the delicacy and grace of the Spaniards, had opened up new paths for the higher dramatic poetry of Europe.

Grillparzer's *Sämmtliche Werke* are edited by A. Sauer, in 20 vols., 5th edition (Stuttgart, 1892-1894); also, since the expiry of the copyright in 1901, innumerable cheap reprints. *Briefe und Tagebücher*, edited by C. Glossy and A. Sauer (2 vols., Stuttgart, 1903). *Jahrbuch der Grillparzer-Gesellschaft*, edited by K. Glossy (the publication of the Grillparzer Society) (Vienna, 1891 ff.). See also H. Laube, *Frans Grillparzers Lebensgeschichte* (Stuttgart, 1884); J. Volkelt, *Frans Grillparzer als Dichter des Tragischen* (Nördlingen, 1888); E. Reich, *Frans Grillparzers Dramen* (Dresden, 1894); A. Ehrhard, *Frans Grillparzer* (Paris, 1900) (German translation by M. Necker, Munich, 1902); H. Sitzenberger, *Grillparzer, sein Leben und Wirken* (Berlin, 1904); Gustav Pollak, *F. Grillparzer and the Austrian Drama* (New York, 1907). Of Grillparzer's works, translations have appeared in English of *Seppho* (1820, by J. Bramsen; 1846, by E. B. Lee; 1855, by L. C. Cumming; 1876, by E. Frothingham); and of *Medea* (1879, by F. W. Thurstan and J. A. Wittmann). Byron's warm admiration of *Seppho* (*Letters and Journals*, v. 171) is well known, while Carlyle's criticism, in his essay on *German Playwrights* (1829), is interesting as expressing the generally accepted estimate of Grillparzer in the first half of the 19th century. See the bibliography in K. Goedeke's *Grundriss zur Geschichte der deutschen Dichtung*, 2nd ed., vol. viii. (1905).

GRIMALD (or GRIMOALD), **NICHOLAS** (1510-1562), English poet, was born in Huntingdonshire, the son probably of Giovanni Battista Grimaldi, who had been a clerk in the service of Empson and Dudley in the reign of Henry VII. He was educated at Christ's College, Cambridge, where he took his B.A. degree in 1540. He then removed to Oxford, becoming a probationer-fellow of Merton College in 1541. In 1547 he was lecturing on rhetoric at Christ Church, and shortly afterwards became chaplain to Bishop Ridley, who, when he was in prison, desired Grimald to translate Laurentius Valla's book against the alleged *Donation of Constantine*, and the *De gestis Basiliensis Concilii* of Aeneas Sylvius (Pius II.). His connexion with Ridley brought him under suspicion, and he was imprisoned in the Marshalsea. It is said that he escaped the penalties of heresy by recanting his errors, and was despised accordingly by his Protestant contemporaries. Grimald contributed to the original edition (June 1557) of *Songes and Sonettes* (commonly known as *Tottel's Miscellany*), forty poems, only ten of which are retained in the second edition published in the next month. He translated (1553) Cicero's *De officiis* as *Marcus Tullius Ciceroes thre booke of duties* (2nd ed., 1556); a Latin paraphrase of Virgil's *Georgics* (printed 1501) is attributed to him, but most of the works assigned to him by Bale are lost. Two Latin tragedies are extant, *Archipropheta sive Johannes Baptista*, printed at Cologne in 1548, probably performed at Oxford the year before, and *Christus redivivus* (Cologne, 1543), edited by Prof. J. M. Hart (for the Modern Language Association of America, 1886, separately issued 1890). It cannot be determined whether Grimald was familiar with Buchanan's *Baptistes* (1543), or with J. Schoepppe's *Johannes descollatus vel Ectrachelistes* (1546). Grimald provides a purely romantic motive for the catastrophe in the passionate attachment of Herodias to Herod, and constantly resorts to lyrical methods. As a poet Grimald is memorable as the earliest follower of Surrey in the production of blank verse. He writes sometimes simply enough, as in the lines on his own childhood addressed to his mother, but in general his style is more artificial, and his metaphors more studied than is the case with the other contributors to the *Miscellany*. His classical reading shows itself in the comparative terseness and smartness of his verses. His epitaph was written by Barnabe Googe in May 1562.

See C. H. Herford, *Studies in the Literary Relations of England and Germany* (pp. 113-119, 1886). *A Catalogue of printed books . . . by writers bearing the name of Grimaldi* (ed. A. B. Grimaldi), printed 1883; and Arber's reprint of *Tottel's Miscellany*.

GRIMALDI, GIOVANNI FRANCESCO (1600-1680), Italian architect and painter, named Il Bolognese from the place of his birth, was a relative of the Caracci family, under whom it is presumed he studied first. He was afterwards a pupil of Albani. He went to Rome, and was appointed architect to Pope Paul V., and was also patronized by succeeding popes. Towards 1648 he was invited to France by Cardinal Mazarin, and for about two years was employed in buildings for that minister and for Louis XIV., and in fresco-painting in the Louvre. His colour was strong, somewhat excessive in the use of green; his touch light. He painted history, portraits and landscapes—the last with predilection, especially in his advanced years—and executed engravings and etchings from his own landscapes and from those of Titian and the Caracci. Returning to Rome, he was made president of the Academy of St Luke; and in that city he died on the 28th of November 1680, in high repute not only for his artistic skill but for his upright and charitable deeds. His son Alessandro assisted him both in painting and in engraving. Paintings by Grimaldi are preserved in the Quirinal and Vatican palaces, and in the church of S. Martino a' Monti; there is also a series of his landscapes in the Colonna Gallery.

GRIMALDI, JOSEPH (1770-1837), the most celebrated of English clowns, was born in London on the 18th of December 1770, the son of an Italian actor. When less than two years old he was brought upon the stage at Drury Lane; at the age of three he began to appear at Sadler's Wells; and he did not finally retire until 1828. As the clown of pantomime he was considered without an equal, his greatest success being in *Mother Goose*, at Covent Garden (1806 and often revived). Grimaldi died on the 31st of May 1837.

His *Memoirs* in two volumes (1838) were edited by Charles Dickens.

GRIMKÉ, SARAH MOORE (1792-1873) and **ANGELINA EMILY** (1805-1870), American reformers, born in Charleston, South Carolina—Sarah on the 6th of November 1792, and Angelina on the 20th of February 1805—were daughters of John Fachereau Grimké (1752-1810), an artillery officer in the Continental army, a jurist of some distinction, a man of wealth and culture and a slave-holder.

Their older brother, **THOMAS SMITH GRIMKÉ** (1786-1834), was born in Charleston; graduated at Yale in 1807; was a successful lawyer, and in 1826-1830 was a member of the state Senate, in which he, almost alone of the prominent lawyers of the state, opposed nullification; he strongly advocated spelling-reform, temperance and absolute non-resistance, and published *Addresses on Science, Education and Literature* (1831). His early intellectual influence on Sarah was strong.

In her thirteenth year Sarah was godmother to her sister Angelina. Sarah in 1821 revisited Philadelphia, whither she had accompanied her father on his last illness, and there, having been already dissatisfied with the Episcopal Church and with the Presbyterian, she became a Quaker; so, too, did Angelina, who joined her in 1829. Both sisters (Angelina first) soon grew into a belief in immediate abolition, strongly censured by many Quakers, who were even more shocked by a sympathetic letter dated "8th Month, 30th, 1835" written by Angelina to W. L. Garrison, followed in 1836 by her *A Appeal to the Christian Women of the South*, and at the end of that year, by an *Epistle to the Clergy of the Southern States*, written by Sarah, who now thoroughly agreed with her younger sister. In the same year, at the invitation of Elizur Wright (1804-1885), corresponding secretary of the American Anti-Slavery Society, Angelina, accompanied by Sarah, began giving talks on slavery, first in private and then in public, so that in 1837, when they set to work in Massachusetts, they had to secure the use of large halls. Their speaking from public platforms resulted in a letter issued by some members of the General Association of Congregational Ministers of Massachusetts, calling on the clergy to close their

churches to women exhorters; Garrison denounced the attack on the Grimké sisters and Whittier ridiculed it in his poem "The Pastoral Letter." Angelina pointedly answered Miss Beecher on the *Slave Question* (1837) in letters in the *Liberator*. Sarah, who had never forgotten that her studies had been curtailed because she was a girl, contributed to the Boston *Spectator* papers on "The Province of Woman" and published *Letters on the Condition of Women and the Equality of the Sexes* (1838)—the real beginning of the "woman's rights" movement in America, and at the time a cause of anxiety to Whittier and others, who urged upon the sisters the prior importance of the anti-slavery cause. In 1838 Angelina married Theodore Dwight Weld (1803-1895), a reformer and abolition orator and pamphleteer, who had taken part in the famous Lane Seminary debates in 1834, had left the Seminary for the lecture platform when the anti-slavery society was broken up by the Lane trustees, but had lost his voice in 1836 and had become editor of the publications of the American Anti-Slavery Society.¹ They lived, with Sarah, at Fort Lee, New Jersey, in 1838-1840, then on a farm at Belleville, New Jersey, and then conducted a school for black and white alike at Eagleswood, near Perth Amboy, New Jersey, from 1854 to 1864. Removing to Hyde Park, Massachusetts, the three were employed in Dr Lewis's school. There Sarah died on the 23rd of December 1873, and Angelina on the 26th of October 1879. Both sisters indulged in various "fads"—Graham's diet, bloomer-wearing, absolute non-resistance. Angelina did no public speaking after her marriage, save at Pennsylvania Hall (Philadelphia), destroyed by a mob immediately after her address there; but besides her domestic and school duties she was full of tender charity. Sarah at the age of 62 was still eager to study law or medicine, or to do something to aid her sex; at 75 she translated and abridged Lamarline's life of Joan of Arc.

See Catherine H. Birney, *The Grimké Sisters* (Boston, 1885).

GRIMM, FRIEDRICH MELCHIOR, BARON VON (1723-1807), French author, the son of a German pastor, was born at Ratisbon on the 26th of December 1723. He studied at the University of Leipzig, where he came under the influence of Gottsched and of J. A. Ernesti, to whom he was largely indebted for his critical appreciation of classical literature. When nineteen he produced a tragedy, *Basisse*, which met with some success. After two years of study he returned to Ratisbon, where he was attached to the household of Count Schönberg. In 1748 he accompanied August Heinrich, Count Friesen, to Paris as secretary, and he is said by Rousseau to have acted for some time as reader to Frederick, the young hereditary prince of Saxe-Gotha. His acquaintance with Rousseau, through a mutual sympathy in regard to musical matters, soon ripened into intimate friendship, and led to a close association with the encyclopedists. He rapidly obtained a thorough knowledge of the French language, and acquired so perfectly the tone and sentiments of the society in which he moved that all marks of his foreign origin and training seemed effaced. A witty pamphlet entitled *Le Petit Prophète de Bochimischbroda* (1755), written by him in defence of Italian as against French opera, established his literary reputation. It is possible that the origin of the pamphlet is partly to be accounted for by his vehement passion² for Mlle Fel, the *prima donna* of the Italian company. In 1753 Grimm, following the example of the abbé Raynal, began a literary correspondence with various German sovereigns. Raynal's letters, *Nouvelles littéraires*, ceased early in 1755. With the aid of friends, especially of Diderot and Mme d'Épinay, during his temporary absences from France, Grimm himself carried on the correspondence, which consisted of two letters a month, until 1773, and eventually counted among his subscribers Catherine II. of Russia, Stanislas Poniatowski, king of Poland, and many princes of the smaller German States.

¹ Weld was the author of several anti-slavery books which had considerable influence at the time. Among them are *The Bible against Slavery* (1837), *American Slavery as It Is* (1839), a collection of extracts from Southern papers, and *Slavery and the Internal Slave Trade in the U.S.* (1841).

² Rousseau's account of this affair (*Confessions*, 2nd part, 8th book) must be received with caution.

It was probably in 1754 that Grimm was introduced by Rousseau to Madame d'Épinay, with whom he soon formed a liaison which led to an irreconcilable rupture between him and Rousseau. Rousseau was induced by his resentment to give in his *Confessions* a wholly mendacious portrait of Grimm's character. In 1755, after the death of Count Friesen, who was a nephew of Marshal Saxe and an officer in the French army, Grimm became *secrétaire des commandements* to the duke of Orleans, and in this capacity he accompanied Marshal d'Estrées on the campaign of Westphalia in 1756-57. He was named envoy of the town of Frankfort at the court of France in 1759, but was deprived of his office for criticizing the comte de Broglie in a despatch intercepted by Louis XV. He was made a baron of the Holy Roman Empire in 1775. His introduction to Catherine II. of Russia took place at St Petersburg in 1773, when he was in the suite of Wilhelmine of Hesse-Darmstadt on the occasion of her marriage to the czarevitch Paul. He became minister of Saxe-Gotha at the court of France in 1776, but in 1777 he again left Paris on a visit to St Petersburg, where he remained for nearly a year in daily intercourse with Catherine. He acted as Paris agent for the empress in the purchase of works of art, and executed many confidential commissions for her. In 1783 and the following years he lost his two most intimate friends, Mme d'Épinay and Diderot. In 1792 he emigrated, and in the next year settled in Gotha, where his poverty was relieved by Catherine, who in 1796 appointed him minister of Russia at Hamburg. On the death of the empress Catherine he took refuge with Mme d'Épinay's granddaughter, Émilie de Belsunce, comtesse de Buell. Grimm had always interested himself in her, and had procured her dowry from the empress Catherine. She now received him with the utmost kindness. He died at Gotha on the 19th of December 1807.

The correspondence of Grimm was strictly confidential, and was not divulged during his lifetime. It embraces nearly the whole period from 1750 to 1790, but the later volumes, 1773 to 1790, were chiefly the work of his secretary, Jakob Heinrich Meister. At first he contented himself with enumerating the chief current views in literature and art and indicating very slightly the contents of the principal new books, but gradually his criticisms became more extended and trenchant, and he touched on nearly every subject—political, literary, artistic, social and religious—which interested the Parisian society of the time. His notices of contemporaries are somewhat severe, and he exhibits the foibles and selfishness of the society in which he moved; but he was unbiassed in his literary judgments, and time has only served to confirm his criticisms. In style and manner of expression he is thoroughly French. He is generally somewhat cold in his appreciation, but his literary taste is delicate and subtle; and it was the opinion of Sainte-Beuve that the quality of his thought in his best moments will compare not unfavourably even with that of Voltaire. His religious and philosophical opinions were entirely negative.

Grimm's Correspondance littéraire, philosophique et critique . . . depuis 1753 jusqu'en 1790, was edited, with many excisions, by J. B. A. Suard and published at Paris in 1812, in 6 vols. 8vo; *deuxième partie, de 1771 à 1782*, in 1812, in 5 vols. 8vo; and *troisième partie, pendant une partie des années 1775 et 1776, et pendant les années 1782 à 1790 inclusivement*, in 1813, in 5 vols. 8vo. A supplementary volume appeared in 1814; the whole correspondence was collected and published by M. Jules Tachereau, with the assistance of A. Chaudé, in a *Nouvelle Edition, revue et mise dans un meilleur ordre, avec des notes et des éclaircissements, et où se trouvent rétablies pour la première fois les phrases supprimées par la censure impériale* (Paris, 1829, 15 vols. 8vo); and the *Correspondance inédite, et recueil de lettres, poésies, morceaux, et fragments retranchés par la censure impériale en 1812 et 1813* was published in 1829. The standard edition is that of M. Tournoux (16 vols., 1877-1882). Grimm's *Mémoire historique sur l'origine et les suites de mon attachement pour l'impératrice Catherine II jusqu'à son décès de sa majesté impériale*, and Catherine's correspondence with Grimm (1774-1796) were published by J. Grot in 1880, in the *Collection of the Russian Imperial Historical Society*. She treats him very familiarly, and calls him Héraclite, Georges Dandin, &c. At the time of the Revolution she begged him to destroy her letters, but he refused, and after his death they were returned to St Petersburg. Grimm's side of the correspondence, however, is only partially preserved. He signs himself

"Pleureur." Some of Grimm's letters, besides the official correspondence, are included in the edition of M. Tournoux; others are contained in the *Erinnerungen einer Urgrossmutter* of K. von Bechtolsheim, edited (Berlin, 1902) by Count C. Oberdorff. See also Mme d'Épinay's *Mémoires*; Rousseau's *Confessions*; the notices contained in the editions quoted; E. Scherer, *Melchior Grimm* (1887); Sainte-Beuve, *Causeries du lundi*, vol. vii. For further works bearing on the subject, see K. A. Georges, *Friedrich Melchior Grimm* (Hanover and Leipzig, 1904).

GRIMM, JACOB LUDWIG CARL (1785-1863), German philologist and mythologist, was born on the 4th of January 1785 at Hanau, in Hesse-Cassel. His father, who was a lawyer, died while he was a child, and the mother was left with very small means; but her sister, who was lady of the chamber to the landgravine of Hesse, helped to support and educate her numerous family. Jacob, with his younger brother Wilhelm (born on the 24th of February 1786), was sent in 1798 to the public school at Cassel. In 1802 he proceeded to the university of Marburg, where he studied law, a profession for which he had been destined by his father. His brother joined him at Marburg a year later, having just recovered from a long and severe illness, and likewise began the study of law. Up to this time Jacob Grimm had been actuated only by a general thirst for knowledge and his energies had not found any aim beyond the practical one of making himself a position in life. The first definite impulse came from the lectures of Savigny, the celebrated investigator of Roman law, who, as Grimm himself says (in the preface to the *Deutsche Grammatik*), first taught him to realize what it meant to study any science. Savigny's lectures also awakened in him that love for historical and antiquarian investigation which forms the basis of all his work. Then followed personal acquaintance, and it was in Savigny's well-provided library that Grimm first turned over the leaves of Bodmer's edition of the Old German minnesingers and other early texts, and felt an eager desire to penetrate further into the obscurities and half-revealed mysteries of their language. In the beginning of 1805 he received an invitation from Savigny, who had removed to Paris, to help him in his literary work. Grimm passed a very happy time in Paris, strengthening his taste for the literatures of the middle ages by his studies in the Paris libraries. Towards the close of the year he returned to Cassel, where his mother and Wilhelm had settled, the latter having finished his studies. The next year he obtained a situation in the war office with the very small salary of 100 thalers. One of his grievances was that he had to exchange his stylish Paris suit for a stiff uniform and pigtail. But he had full leisure for the prosecution of his studies. In 1808, soon after the death of his mother, he was appointed superintendent of the private library of Jerome Buonaparte, king of Westphalia, into which Hesse-Cassel had been incorporated by Napoleon. Jerome appointed him an auditor to the state council, while he retained his other post. His salary was increased in a short interval from 2000 to 4000 francs, and his official duties were hardly more than nominal. After the expulsion of Jerome and the reinstatement of an elector, Grimm was appointed in 1813 secretary of legation, to accompany the Hessian minister to the headquarters of the allied army. In 1814 he was sent to Paris to demand restitution of the books carried off by the French, and in 1814-1815 he attended the congress of Vienna as secretary of legation. On his return he was again sent to Paris on the same errand as before. Meanwhile Wilhelm had received an appointment in the Cassel library, and in 1816 Jacob was made second librarian under Völkel. On the death of Völkel in 1828 the brothers expected to be advanced to the first and second librarianships respectively, and were much dissatisfied when the first place was given to Rommel, keeper of the archives. So they removed next year to Göttingen, where Jacob received the appointment of professor and librarian, Wilhelm that of under-librarian. Jacob Grimm lectured on legal antiquities, historical grammar, literary history, and diplomatics, explained Old German poems, and commented on the *Germania* of Tacitus. At this period he is described as small and lively in figure, with a harsh voice, speaking a broad Hessian dialect. His powerful memory enabled him to dispense with the

manuscript which most German professors rely on, and he spoke extempore, referring only occasionally to a few names and dates written on a slip of paper. He himself regretted that he had begun the work of teaching so late in life; and as a lecturer he was not successful: he had no idea of digesting his facts and suiting them to the comprehension of his hearers; and even the brilliant, terse and eloquent passages which abound in his writings lost much of their effect when jerked out in the midst of a long array of dry facts. In 1837, being one of the seven professors who signed a protest against the king of Hanover's abrogation of the constitution established some years before, he was dismissed from his professorship, and banished from the kingdom of Hanover. He returned to Cassel together with his brother, who had also signed the protest, and remained there till, in 1840, they accepted an invitation from the king of Prussia to remove to Berlin, where they both received professorships, and were elected members of the Academy of Sciences. Not being under any obligation to lecture, Jacob seldom did so, but together with his brother worked at the great dictionary. During their stay at Cassel Jacob regularly attended the meetings of the academy, where he read papers on the most varied subjects. The best known of these are those on Lachmann, Schiller, and his brother Wilhelm (who died in 1850), on old age, and on the origin of language. He also described his impressions of Italian and Scandinavian travel, interspersing his more general observations with linguistic details, as is the case in all his works.

Grimm died in 1863, working up to the last. He was never ill, and worked on all day, without haste and without pause. He was not at all impatient of interruption, but seemed rather to be refreshed by it, returning to his work without effort. He wrote for the press with great rapidity, and hardly ever made corrections. He never revised what he had written, remarking with a certain wonder of his brother, "Wilhelm reads his manuscripts over again before sending them to press!" His temperament was uniformly cheerful, and he was easily amused. Outside his own special work he had a marked taste for botany. The spirit which animated his work is best described by himself at the end of his autobiography. "Nearly all my labours have been devoted, either directly or indirectly, to the investigation of our earlier language, poetry and laws. These studies may have appeared to many, and may still appear, useless; to me they have always seemed a noble and earnest task, definitely and inseparably connected with our common fatherland, and calculated to foster the love of it. My principle has always been in these investigations to under-value nothing, but to utilize the small for the illustration of the great, the popular tradition for the elucidation of the written monuments."

The purely scientific side of Grimm's character developed slowly. He seems to have felt the want of definite principles of etymology without being able to discover them, and indeed even in the first edition of his grammar (1819) he seems to be often groping in the dark. As early as 1815 we find A. W. Schlegel reviewing the *Altdenksche Wälder* (a periodical published by the two brothers) very severely, condemning the lawless etymological combinations it contained, and insisting on the necessity of strict philological method and a fundamental investigation of the laws of language, especially in the correspondence of sounds. This criticism is said to have had a considerable influence on the direction of Grimm's studies.

The first work he published, *Über den altdenkschen Meistergesang* (1811), was of a purely literary character. Yet even in this essay Grimm showed that *Minnesang* and *Meistersang* were really one form of poetry, of which they merely represented different stages of development, and also announced his important discovery of the invariable division of the *Lied* into three strophic parts.

His text-editions were mostly prepared in common with his brother. In 1812 they published the two ancient fragments of the *Hildebrandslied* and the *Weissenbrunner Gebet*, Jacob having discovered what till then had never been suspected—the alliteration in these poems. However, Jacob had little taste for text-editing, and, as he himself confessed, the evolving of a

critical text gave him little pleasure. He therefore left this department to others, especially Lachmann, who soon turned his brilliant critical genius, trained in the severe school of classical philology, to Old and Middle High German poetry and metre. Both brothers were attracted from the beginning by all national poetry, whether in the form of epics, ballads or popular tales. They published in 1816-1818 an analysis and critical sifting of the oldest epic traditions of the Germanic races under the title of *Deutsche Sagen*. At the same time they collected all the popular tales they could find, partly from the mouths of the people, partly from manuscripts and books, and published in 1812-1815 the first edition of those *Kinder- und Hausmärchen* which have carried the name of the brothers Grimm into every household of the civilized world, and founded the science of folk-lore. The closely allied subject of the satirical beast epic of the middle ages also had a great charm for Jacob Grimm, and he published an edition of the *Reinkart Fuchs* in 1834. His first contribution to mythology was the first volume of an edition of the Eddaic songs, undertaken conjointly with his brother, published in 1815, which, however, was not followed by any more. The first edition of his *Deutsche Mythologie* appeared in 1835. This great work covers the whole range of the subject, tracing the mythology and superstitions of the old Teutons back to the very dawn of direct evidence, and following their decay and loss down to the popular traditions, tales and expressions in which they still linger.

Although by the introduction of the Code Napoléon into Westphalia Grimm's legal studies were made practically barren, he never lost his interest in the scientific study of law and national institutions, as the truest exponents of the life and character of a people. By the publication (in 1828) of his *Rechtsalterthümer* he laid the foundations of that historical study of the old Teutonic laws and constitutions which was continued with brilliant success by Georg L. Maurer and others. In this work Grimm showed the importance of a linguistic study of the old laws, and the light that can be thrown on many a dark passage in them by a comparison of the corresponding words and expressions in the other old cognate dialects. He also knew how—and this is perhaps the most original and valuable part of his work—to trace the spirit of the laws in countless allusions and sayings which occur in the old poems and sagas, or even survive in modern colloquialisms.

Of all his more general works the boldest and most far-reaching is his *Geschichte der deutschen Sprache*, where at the same time the linguistic element is most distinctly brought forward. The subject of the work is, indeed, nothing less than the history which lies hidden in the words of the German language—the oldest national history of the Teutonic tribes determined by means of language. For this purpose he laboriously collects the scattered words and allusions to be found in classical writers, and endeavours to determine the relations in which the German language stood to those of the Getae, Thracians, Scythians, and many other nations whose languages are known only by doubtfully identified, often extremely corrupted remains preserved by Greek and Latin authors. Grimm's results have been greatly modified by the wider range of comparison and improved methods of investigation which now characterize linguistic science, and many of the questions raised by him will probably for ever remain obscure; but his book will always be one of the most fruitful and suggestive that have ever been written.

Grimm's famous *Deutsche Grammatik* was the outcome of his purely philological work. The labours of past generations—from the humanists onwards—had collected an enormous mass of materials in the shape of text-editions, dictionaries and grammars, although most of it was uncritical and often untrustworthy. Something had even been done in the way of comparison and the determination of general laws, and the conception of a comparative Teutonic grammar had been clearly grasped by the illustrious Englishman George Hickes, at the beginning of the 18th century, and partly carried out by him in his *Thesaurus*. Ten Kate in Holland had afterwards made valuable contributions to the history and comparison of the Teutonic languages. Even Grimm himself did not at first intend

to include all the languages in his grammar; but he soon found that Old High German postulated Gothic; that the later stages of German could not be understood without the help of the Low German dialects, including English, and that the rich literature of Scandinavia could as little be ignored. The first edition of the first part of the *Grammar*, which appeared in 1819, and is now extremely rare, treated of the inflections of all these languages, together with a general introduction, in which he vindicated the importance of an historical study of the German language against the a priori, quasi-philosophical methods then in vogue.

In 1822 this volume appeared in a second edition—really a new work, for, as Grimm himself says in the preface, it cost him little reflection to mow down the first crop to the ground. The wide distance between the two stages of Grimm's development in these two editions is significantly shown by the fact that while the first edition gives only the inflections, in the second volume phonology takes up no fewer than 600 pages, more than half of the whole volume. Grimm had, at last, awakened to the full conviction that all sound philology must be based on rigorous adhesion to the laws of sound-change, and he never afterwards swerved from this principle, which gave to all his investigations, even in their boldest flights, that iron-bound consistency, and that force of conviction which distinguish science from dilettantism; up to Grimm's time philology was nothing but a more or less laborious and conscientious dilettantism, with occasional flashes of scientific inspiration; he made it into a science. His advance must be attributed mainly to the influence of his contemporary R. Rask. Rask was born two years later than Grimm, but his remarkable precocity gave him somewhat the start. Even in Grimm's first editions his Icelandic paradigms are based entirely on Rask's grammar, and in his second edition he relied almost entirely on Rask for Old English. His debt to Rask can only be estimated at its true value by comparing his treatment of Old English in the two editions; the difference is very great. Thus in the first edition he declines *dag, dages*, plural *dages*, not having observed the law of vowel-change pointed out by Rask. There can be little doubt that the appearance of Rask's Old English grammar was a main inducement for him to recast his work from the beginning. To Rask also belongs the merit of having first distinctly formulated the laws of sound-correspondence in the different languages, especially in the vowels, those more fleeting elements of speech which had hitherto been ignored by etymologists.

This leads to a question which has been the subject of much controversy,—Who discovered what is known as *Grimm's law*? This law of the correspondence of consonants in the older Indo-germanic, Low and High German languages respectively was first fully stated by Grimm in the second edition of the first part of his grammar. The correspondence of single consonants had been more or less clearly recognized by several of his predecessors; but the one who came nearest to the discovery of the complete law was the Swede J. Ihre, who established a considerable number of "literary permutations," such as *b* for *f*, with the examples *bars = fers*, *befuer = fiber*. Rask, in his essay on the origin of the Icelandic language, gives the same comparisons, with a few additions and corrections, and even the very same examples in most cases. As Grimm in the preface to his first edition expressly mentions this essay of Rask, there is every probability that it gave the first impulse to his own investigations. But there is a wide difference between the isolated permutations of his predecessors and the comprehensive generalizations under which he himself ranged them. The extension of the law to High German is also entirely his own. The only fact that can be adduced in support of the assertion that Grimm wished to deprive Rask of his claims to priority is that he does not expressly mention Rask's results in his second edition. But this is part of the plan of his work, viz. to refrain from all controversy or reference to the works of others. In his first edition he expressly calls attention to Rask's essay, and praises it most ungrudgingly. Rask himself refers as little to Ihre, merely alluding in a general way to Ihre's permutations, although his own debt to Ihre is infinitely greater than that of Grimm to

Rask or any one else. It is true that a certain bitterness of feeling afterwards sprang up between Grimm and Rask, but this was the fault of the latter, who, impatient of contradiction and irritable in controversy, refused to acknowledge the value of Grimm's views when they involved modification of his own. The importance of Grimm's generalization in the history of philology cannot be overestimated, and even the mystic completeness and symmetry of its formulation, although it has proved a hindrance to the correct explanation of the causes of the changes, was well calculated to strike the popular mind, and give it a vivid idea of the paramount importance of law, and the necessity of disregarding mere superficial resemblance. The most lawless etymologist bows down to the authority of Grimm's law, even if he honours it almost as much in the breach as in the observance.

The grammar was continued in three volumes, treating principally of derivation, composition and syntax, which last was left unfinished. Grimm then began a third edition, of which only one part, comprising the vowels, appeared in 1840, his time being afterwards taken up mainly by the dictionary. The grammar stands alone in the annals of science for comprehensiveness, method and fullness of detail. Every law, every letter, every syllable of inflection in the different languages is illustrated by an almost exhaustive mass of material. It has served as a model for all succeeding investigators. Diez's grammar of the Romance languages is founded entirely on its methods, which have also exerted a profound influence on the wider study of the Indo-Germanic languages in general.

In the great German dictionary Grimm undertook a task for which he was hardly suited. His exclusively historical tendencies made it impossible for him to do justice to the individuality of a living language; and the disconnected statement of the facts of language in an ordinary alphabetical dictionary fatally mars its scientific character. It was also undertaken on so large a scale as to make it impossible for him and his brother to complete it themselves. The dictionary, as far as it was worked out by Grimm himself, may be described as a collection of disconnected antiquarian essays of high value.

Grimm's scientific character is notable for its combination of breadth and unity. He was as far removed from the narrowness of the specialist who has no ideas, no sympathies beyond some one author, period or corner of science, as from the shallow dabbler who feverishly attempts to master the details of half-a-dozen discordant pursuits. Even within his own special studies there is the same wise concentration; no Mezzofanti-like parrot display of useless polyglotism. The very foundations of his nature were harmonious; his patriotism and love of historical investigation received their fullest satisfaction in the study of the language, traditions, mythology, laws and literature of his own countrymen and their nearest kindred. But from this centre his investigations were pursued in every direction as far as his unerring instinct of healthy limitation would allow. He was equally fortunate in the harmony that subsisted between his intellectual and moral nature. He made cheerfully the heavy sacrifices that science demands from its disciples, without feeling any of that envy and bitterness which often torment weaker natures; and although he lived apart from his fellow men, he was full of human sympathies, and no man has ever exercised a profounder influence on the destinies of mankind. His was the very ideal of the noblest type of German character.

The following is a complete list of his separately published works, those which he published in common with his brother being marked with a star. For a list of his essays in periodicals, &c., see vol. v. of his *Kleinere Schriften*, from which the present list is taken. His life is best studied in his own "Selbstbiographie," in vol. i. of the *Kleinere Schriften*. There is also a brief memoir by K. Gödecke in *Göttinger Professoren* (Gotha (Perthes), 1877): *Über den alldutschen Meisterzang* (Göttingen, 1811); *Kinder- und Hausmärchen* (Berlin, 1812-1815) (many editions); *Das Lied von Hildegard und das Weissenbrunner Gebet* (Cassel, 1812); *Alldutsche Wälder* (Cassel, Frankfurt, 1813-1816, 3 vols.); *Der arme Heinrich von Hartmann von der Aue* (Berlin, 1815); *Irmenstrasse und Irmenstraße* (Vienna, 1815); *Die Lieder der alten Edda* (Berlin, 1815); *Silva de romances viejos* (Vienna, 1815); *Deutsche Sagen* (Berlin, 1816-1818, 2nd ed.,

Berlin, 1865-1866); *Deutsche Grammatik* (Göttingen, 1809, 2nd ed., Göttingen, 1822-1840) (reprinted 1870 by W. Scherer, Berlin); *Wah Stephansovitch's kleine serbische Grammatik, verdeutscht mit einer Vorrede* (Leipzig and Berlin, 1824); *Zur Romantik der deutschen Grammatik* (Cassel, 1826); *Rechts-Elfensmärchen, aus dem Englischen* (Leipzig, 1826); *Deutsche Rechtsaltertümer* (Göttingen, 1828, 2nd ed., 1854); *Hymnorum veteris ecclesie XXVI. interpretatio theologica* (Göttingen, 1830); *Reinhart Fuchs* (Berlin, 1831); *Deutsche Mythologie* (Göttingen, 1835, 3rd ed., 1854, 2 vols.); *Tarich Germaniarum solida* (Göttingen, 1835); *Über meine Entlassung* (Bonn, 1835) (together with Schmeidler); *Lebensgeschichte des X. und XI. Jahrhunderts* (Göttingen, 1838); *Sendschreiben an Karl Ludmann über Reinhart Fuchs* (Berlin, 1840); *Weiswitzer*, Th. i. (Göttingen, 1840) (continued, partly by others, in 5 parts, 1840-1869); *Aztecus und Elone* (Cassel, 1840); *From Anstalts* (Berlin, 1842); *Geographie der deutschen Sprache* (Leipzig, 1848, 3rd ed., 1868, 2 vols.); *Der Wert des Besimes* (Berlin, 1850); *Deutsches Wörterbuch*, Bd. i. (Leipzig, 1854); *Rede auf Wilhelm Grimm und Rede über das Alter* (Berlin, 1868, 3rd ed., 1865); *Kleinere Schriften* (Berlin, 1864-1870, 5 vols.) (H. Sw.)

GRIMM, WILHELM CARL (1786-1859). For the chief events in the life of Wilhelm Grimm see article on Jacob Grimm above. As Jacob himself said in his celebrated address to the Berlin Academy on the death of his brother, the whole of their lives were passed together. In their schooldays they had one bed and one table in common, as students they had two beds and two tables in the same room, and they always lived under one roof, and had their books and property in common. Nor did Wilhelm's marriage in any way disturb their harmony. As Cleasby said ("Life of Cleasby," prefixed to his *Icelandic Dictionary*, p. lix.), "they both live in the same house, and in such harmony and community that one might almost imagine the children were common property." Wilhelm's character was a complete contrast to that of his brother. As a boy he was strong and healthy, but as he grew up he was attacked by a long and severe illness, which left him weak all his life. His was a less comprehensive and energetic mind than that of his brother, and he had less of the spirit of investigation, preferring to confine himself to some limited and definitely bounded field of work; he utilized everything that bore directly on his own studies, and ignored the rest. These studies were almost always of a literary nature. It is characteristic of his more aesthetic nature that he took great delight in music, for which his brother had but a moderate liking, and had a remarkable gift of story-telling. Cleasby, in the account of his visit to the brothers, quoted above, tells that "Wilhelm read a sort of farce written in the Frankfort dialect, depicting the 'malheurs' of a rich Frankfort tradesman on a holiday jaunt on Sunday. It was very droll, and he read it admirably." Cleasby describes him as "an uncommonly animated, jovial fellow." He was, accordingly, much-sought in society, which he frequented much more than his brother.

His first work was a spirited translation of the Danish *Kæmperne*, *Alldutsche Heldenlieder*, published in 1811-1813, which made his name at first more widely known than that of his brother. The most important of his text editions are—*Rudolfstiel* (Göttingen, 1838); *Konrad von Würzburg's Goldene Schinde* (Berlin, 1840); *Grave Rudolf* (Göttingen, 1844, 2nd ed.); *Albis und Prophias* (Berlin, 1846); *Alldutsche Gespräche* (Berlin, 1851); *Freidach* (Göttingen, 1860, 2nd ed.). Of his other works the most important is *Deutsche Heldensage* (Berlin, 1868, 2nd ed.). His *Deutsche Runen* (Göttingen, 1821) has now only an historical interest. (H. Sw.)

GRIMMA, a town in the kingdom of Saxony, on the left bank of the Mulde, 19 m. S.E. of Leipzig on the railway Döbeln-Dresden. Pop. (1905) 11,182. It has a Roman Catholic and three Evangelical churches, and among other principal buildings are the Schloss built in the 12th century, and long a residence of the margraves of Meissen and the electors of Saxony; the town-hall, dating from 1447, and the famous school Fürstenschule (*Illustre M. d'oldannus*), erected by the elector Maurice on the site of the former Augustinian monastery in 1550, having provision for 104 free scholars and a library numbering 10,000 volumes. There are also a modern school, a teachers' seminary, a commercial school and a school of brewing. Among the industries of the town are ironfounding, machine building and dyeworks, while paper and gloves are manufactured there. Gardening and agriculture generally are also important branches of industry. In the immediate neighbourhood are the ruins of the Cistercian

monastery from which Catherine von Bora fled in 1523, and the village of Döben, with an old castle. Grimma is of Sorbian origin, and is first mentioned in 1303. It passed then into possession of Saxony and has remained since part of that country.

See Lorenz, *Die Stadt Grimma, historisch beschrieben* (Leipzig, 1871); Rössler, *Geschichte der königlich sächsischen Fürsten- und Landes-scheide Grimma* (Leipzig, 1891); L. Schmidt, *Urkundenbuch der Stadt Grimma* (Leipzig, 1895); and Fraustadt, *Grimmenser Stemm-buch* (Grimma, 1900).

GRIMMELSHAUSEN, HANS JAKOB CHRISTOFFEL VON (c. 1625-1676), German author, was born at Gelnhausen in or about 1625. At the age of ten he was kidnapped by Hessian soldiery, and in their midst tasted the adventures of military life in the Thirty Years' War. At its close, Grimmelshausen entered the service of Franz Egon von Fürstenberg, bishop of Strassburg and in 1665 was made *Schultheiss* (magistrate) at Renchen in Baden. On obtaining this appointment, he devoted himself to literary pursuits, and in 1669 published *Der abenteuerliche Simplicissimus, Teutsch, d.h. die Beschreibung des Lebens eines seltsamen Vaganten, genennet Melchior Sternfels von Fuchsheim*, the greatest German novel of the 17th century. For this work he took as his model the picaresque romances of Spain, already to some extent known in Germany. *Simplicissimus* is in great measure its author's autobiography; he begins with the childhood of his hero, and describes the latter's adventures amid the stirring scenes of the Thirty Years' War. The realistic detail with which these pictures are presented makes the book one of the most valuable documents of its time. In the later parts Grimmelshausen, however, over-indulges in allegory, and finally loses himself in a Robinson Crusoe story. Among his other works the most important are the so-called *Simplicianische Schriften*: *Die Erbsätterin und Landstürmerin Courasche* (c. 1669); *Der seltsame Springinsfeld* (1670) and *Das wunderbare Vogelneest* (1672). His satires, such as *Der teutsche Michel* (1670), and "gallant" novels, like *Dietswald und Amelinda* (1670) are of inferior interest. He died at Renchen on the 17th of August 1676, where a monument was erected to him in 1879.

Editions of *Simplicissimus* and the *Simplicianische Schriften* have been published by A. von Keller (1854), H. Kurz (1863-1864), J. Tittmann (1877) and F. Bobertag (1882). A reprint of the first edition of the novel was edited by R. Kögel for the series of *Neudrucke des 16. und 17. Jahrhunderts* (1880). See the introductions to these editions; also F. Antoine, *Étude sur le Simplicissimus de Grimmelshausen* (1882) and E. Schmidt in his *Charakteristiken*, vol. I. (1886).

GRIMOARD, PHILIPPE HENRI, COMTE DE (1753-1815), French soldier and military writer, entered the royal army at the age of sixteen, and in 1775 published his *Essai théorique et pratique sur les batailles*. Shortly afterwards Louis XVI. placed him in his own military cabinet and employed him especially in connexion with schemes of army reform. By the year of the Revolution he had become one of Louis's most valued counsellors, in political as well as military matters, and was marked out, though only a colonel, as the next Minister of War. In 1791 Grimoard was entrusted with the preparation of the scheme of defence for France, which proved two years later of great assistance to the Committee of Public Safety. The events of 1792 put an end to his military career, and the remainder of his life was spent in writing military books.

The following works by him, besides his first essay, have retained some importance: *Histoire des dernières campagnes de Turenne* (Paris, 1780), *Lettres et mémoires de Turenne* (Paris, 1780), *Troupes légères et leur emploi* (Paris, 1782), *Conquêtes de Gustave-Adolphe* (Stockholm and Neuchâtel, 1782-1791); *Mémoires de Gustave Adolphe* (Paris, 1790), *Correspondence of Marshal Richelieu* (Paris, 1789), *St. Germain* (1789), and *Bernis* (1790), *Vie et règne de Frédéric le Grand* (London, 1788), *Lettres et mémoires du maréchal de Saxe* (Paris, 1794), *L'Expédition de Minorque en 1756* (Paris, 1798), *Recherches sur la force de l'armée française depuis Henri IV jusqu'en 1805* (Paris, 1806), *Mémoires du maréchal de Tessé* (Paris, 1806), *Lettres de Bolingbroke* (Paris, 1808), *Traité sur le service d'état-major* (Paris, 1809), and (with Servan) *Tableau historique de la guerre de la Révolution 1792-1794* (Paris, 1808).

GRIMSBY, or GREAT GRIMSBY, a municipal, county and parliamentary borough of Lincolnshire, England; an important

seaport near the mouth of the Humber on the south shore. Pop. (1902) 63,138. It is 155 m. N. by E. from London by the Great Northern railway, and is also served by the Great Central railway. The church of St. James, situated in the older part of the town, is a cruciform Early English building, retaining, in spite of injudicious restoration, many beautiful details. The chief buildings are that containing the town hall and the grammar school (a foundation of 1547), the exchange, a theatre, and the customs house and dock offices. A sailors' and fishermen's Harbour of Refuge, free library, constitutional club and technical school are maintained. The duke of York public gardens were opened in 1894. Adjacent to Grimsby on the east is the coastal watering-place of Cleethorpe.

The dock railway station lies a mile from the town station. In 1849 the Great Central (then the Manchester, Sheffield and Lincolnshire) railway initiated a scheme of reclamation and dock-construction. This was completed in 1854, and subsequent extensions were made. There are two large fish-docks, and for general traffic, the Royal dock, communicating with the Humber through a tidal basin, the small Union dock, and the extensive Alexandra dock, together with graving docks, timber yards, a patent slip, &c. These docks have an area of about 104 acres, but were found insufficient for the growing traffic of the port, and in 1906 the construction of a large new dock, of about 40 acres' area and 30 to 35 ft. depth, was undertaken by the Great Central Company at Immingham, 5 m. above Grimsby on the Humber. The principal imports are butter, woollens, timber, cereals, eggs, glass, cottons, preserved meat, wool, sugar and bacon. The exports consist chiefly of woollen yarn, woollens, cotton goods, cotton yarn, machinery, &c. and coal. It is as a fishing port, however, that Grimsby is chiefly famous. Two of the docks are for the accommodation of the fishing fleet, which, consisting principally of steam trawlers, numbers upwards of 500 vessels. Regular passenger steamers run from Grimsby to Dutch and south Swedish ports, and to Esbjerg (Denmark), chiefly those of the Wilson line and the Great Central railway. The chief industries of Grimsby are shipbuilding, brewing, tanning, manufactures of ship tackle, ropes, ice for preserving fish, turnery, flour, linseed cake, artificial manure; and there are saw mills, bone and corn mills, and creosote works. The municipal borough is under a mayor, 12 aldermen and 36 councillors. Area, 2852 acres.

Grimsby (*Grimsbis*) is supposed to have been the landing-place of the Danes on their first invasion of Britain towards the close of the 8th century. It was a borough by prescription as early as 1202, in which year King John granted the burgesses a charter of liberties according to the custom of the burgesses of Northampton. Henry III. in 1227 granted to "the mayor and good men" of Grimsby, that they should hold the town for a yearly rent of £111, and confirmed the same in 1271. These charters were confirmed by later sovereigns. A governing charter, under the title of mayor and burgesses, was given by James II. in 1688, and under this the appointment of officers and other of the corporation, arrangements are to a great extent regulated. In 1202 King John granted the burgesses an annual fair for fifteen days, beginning on the 25th of May. Two annual fairs are now held, namely on the first Monday in April and the second Monday in October. No early grant of a market can be found, but in 1792 the market-day was Wednesday. In 1888 it had ceased to exist. Grimsby returned two members to the parliament of 1298, but in 1833 the number was reduced to one.

In the time of Edward III. Grimsby was an important seaport, but the haven became obstructed by sand and mud deposited by the Humber, and so the access of large vessels was prevented. At the beginning of the 19th century a subscription was raised by the proprietors of land in the neighbourhood for improving the harbour, and an act was obtained by which they were incorporated under the title "The Grimsby Haven Co." The fishing trade had become so important by 1800 that it was necessary to construct a new dock.

GRIMSTON, SIR HARBOTTLE (1603?-1685), English politician, second son of Sir Harbottle Grimston, Bart. (d. 1648), was born

at Bradfield Hall, near Manningtree, on the 27th of January 1603. Educated at Emmanuel College, Cambridge, he became a barrister of Lincoln's Inn, then recorder of Harwich and recorder of Colchester. As member for Colchester, Grimston sat in the Short Parliament of 1640, and he represented the same borough during the Long Parliament, speedily becoming a leading member of the popular party. He attacked Archbishop Laud with great vigour; was a member of the important committees of the parliament, including the one appointed in consequence of the attempted seizure of the five members; and became deputy lieutenant of Essex after the passing of the militia ordinance in January 1642. He disliked taking up arms against the king, but remained nominally an adherent of the parliamentary party during the Civil War. In the words of Clarendon, he "continued rather than concurred with them." Grimston does not appear to have taken the Solemn League and Covenant, but after the conclusion of the first period of the war he again became more active. He was president of the committee which investigated the escape of the king from Hampton Court in 1647, and was one of those who negotiated with Charles at Newport in 1648, when, according to Burnet, he fell upon his knees and urged the king to come to terms. From this time Grimston's sympathies appear to have been with the Royalists. Turned out of the House of Commons when the assembly was "purged" by colonel Pride, he was imprisoned; but was released after promising to do nothing detrimental to the parliament or the army, and spent the next few years in retirement. Before this time, his elder brother having already died, he had succeeded his father as 2nd baronet. In 1650 Sir Harbottle was returned to Cromwell's second parliament as member for Essex; but he was not allowed to take his seat; and with 97 others who were similarly treated he issued a remonstrance to the public. He was among the secluded members who re-entered the Long Parliament in February 1660, was then a member of the council of state, and was chosen Speaker of the House of Commons in the Convention Parliament of 1660. As Speaker he visited Charles II. at Breda, and addressed him in very flattering terms on his return to London; but he refused to accede to the king's demand that he should dismiss Burnet from his position as chaplain to the Master of the Rolls, and in parliament he strongly denounced any relaxation of the laws against papists. Grimston did not retain the office of Speaker after the dissolution of the Convention Parliament, but he was a member of the commission which tried the regicides, and in November 1660 he was appointed Master of the Rolls. Report says he paid Clarendon £8000 for the office, while Burnet declares he obtained it "without any application of his own." He died on the 2nd of January 1685. His friend and chaplain, Burnet, speaks very highly of his piety and impartiality, while not omitting the undoubted fact that he was "much sharpened against popery." He translated the law reports of his father-in-law, the judge, Sir George Croke (1560-1642), which were written in Norman-French, and five editions of this work have appeared. Seven of his parliamentary speeches were published, and he also wrote *Sirena Christiana* (London, 1644, and other editions). Grimston's first wife, Croke's daughter Mary, bore him six sons and two daughters; and by his second wife, Anne, daughter and heiress of Sir Nathaniel Bacon, K.B., a grandson of Sir Nicholas Bacon, he had one daughter.

Of his sons one only, Samuel (1643-1700), survived his father, and when he died in October 1700 the baronetcy became extinct. Sir Harbottle's eldest daughter, Mary, married Sir Capel Luckyn, Bart., and their grandson, William Luckyn, succeeded to the estates of his great-uncle, Sir Samuel Grimston, and took the name of Grimston in 1700. This William Luckyn Grimston (1683-1756) was created Baron Dunboyne and Viscount Grimston in the peerage of Ireland in 1719. He was succeeded as 2nd viscount by his son James (1711-1773), whose son James Bucknall (1747-1808) was made an English peer as baron Verulam of Gorbamby in 1790. Then in 1815 his son James Walter (1775-1845), 2nd baron Verulam, was created earl of Verulam, and the present peer is his direct descendant. Sir Harbottle Grimston

bought Sir Nicholas Bacon's estate at Gorbamby, which is still the residence of his descendants.

See G. Burnet, *History of My Own Time*, edited by O. Airy (Oxford, 1900).

GRIMTHORPE, EDMUND BECKETT, 1ST BARON (1816-1905), son of Sir Edmund Beckett Denison, was born on the 12th of May 1816. He was educated at Doncaster and Eton, whence he proceeded to Trinity College, Cambridge, and graduated thirtieth wrangler in 1838. He was called to the bar at Lincoln's Inn in 1841. Upon succeeding to the baronetcy in 1874 he dropped the name of Denison, which his father had assumed in 1816. From 1877 to 1900 he was chancellor and vicar-general of York, and he was raised to the peerage in 1886. He was made a Q.C. in 1854, and was for many years a leader of the Parliamentary Bar. He devoted himself to the study of astronomy, horology and architecture, more especially Gothic ecclesiastical architecture. As early as 1850 he had become a recognised authority on clocks, watches and bells, and in particular on the construction of turret clocks, for he had designed Dent's Great Exhibition clock, and his *Rudimentary Treatise* had gone through many editions. In 1851 he was called upon, in conjunction with the astronomer royal (Mr, afterwards Sir, G. B. Airy) and Mr Dent, to design a suitable clock for the new Houses of Parliament. The present tower clock, popularly known as "Big Ben," was constructed after Lord Grimthorpe's designs. In a number of burning questions during his time Lord Grimthorpe took a prominent part. It is, however, in connexion with the restoration of St Albans Abbey that he is most widely known. The St Albans Abbey Reparation Committee, which had been in existence since 1871, and for which Sir Gilbert Scott had carried out some admirable repairs, obtained a faculty from the Diocesan Court in 1877 to repair and restore the church and fit it for cathedral and parochial services. Very soon, however, the committee found itself unable to raise the necessary funds, and it was at this juncture that a new faculty was granted to Lord Grimthorpe (then Sir Edmund Beckett) to "restore, repair and refit" the abbey at his own expense. Lord Grimthorpe made it an express stipulation that the work should be done according to his own designs and under his own supervision. His public spirit in undertaking the task was undeniable, but his treatment of the roof, the new west front, and the windows inserted in the terminations of the transepts, excited a storm of adverse criticism, and was the subject of vigorous protests from the professional world of architecture. He died on the 29th of April 1905, being succeeded as 2nd baron by his nephew, E. W. Beckett (b. 1856), who had sat in parliament as conservative member for the Whitley division of Yorkshire from 1885.

GRINDAL, EDMUND (c. 1519-1583), successively bishop of London, archbishop of York and archbishop of Canterbury, born about 1519, was son of William Grindal, a farmer of Hensingham, in the parish of St Bees, Cumberland. He was educated at Magdalene and Christ's Colleges and then at Pembroke Hall, Cambridge, where he graduated B.A. and was elected fellow in 1538. He proceeded M.A. in 1541, was ordained deacon in 1544 and was proctor and Lady Margaret preacher in 1548-1549. Probably through the influence of Ridley, who had been master of Pembroke Hall, Grindal was selected as one of the Protestant disputants during the visitation of 1549. He had a considerable talent for this work and was often employed on similar occasions. When Ridley became bishop of London, he made Grindal one of his chaplains and gave him the precentorship of St Paul's. He was soon promoted to be one of Edward VI.'s chaplains and prebendary of Westminster, and in October 1552 was one of the six divines to whom the Forty-two articles were submitted for examination before being sanctioned by the Privy Council. According to Knox, Grindal distinguished himself from most of the court preachers in 1553 by denouncing the worldliness of the courtiers and foretelling the evils to follow on the king's death.

That event frustrated Grindal's proposed elevation to the episcopal bench and he did not consider himself bound to await the evils which he had foretold. He abandoned his preferences

on Mary's accession and made his way to Strassburg. Thence, like so many of the Marian exiles, he proceeded to Frankfurt, where he endeavoured to compose the disputes between the "Coxians" (see Cox, RICHARD), who regarded the 1552 Prayer Book as the perfection of reform, and the Knoxians, who wanted further simplification. He returned to England in January 1559, was appointed one of the committee to revise the liturgy, and one of the Protestant representatives at the Westminster conference. In July he was also elected Master of Pembroke Hall in succession to the recusant Dr Thomas Young (1514-1580) and Bishop of London in succession to Bonner.

Grindal himself was, however, inclined to be recalcitrant from different motives. He had qualms about vestments and other traces of "popery" as well as about the Erastianism of Elizabeth's ecclesiastical government. His Protestantism was robust enough; he did not mind recommending that a priest "might be put to some torment" (*Hatfield MSS.* i. 269); and in October 1562 he wrote to Cecil begging to know "if that second Julian, the king of Navarre, is killed; as he intended to preach at St Paul's Cross, and might take occasion to mention God's judgments on him" (*Domestic Cal.*, 1547-1580, p. 209). But he was loath to execute judgments upon English Puritans, and modern high churchmen complain of his infirmity of purpose, his opportunism and his failure to give Parker adequate assistance in rebuilding the shattered fabric of the English Church. Grindal lacked that firm faith in the supreme importance of uniformity and autocracy which enabled Whitgift to persecute with a clear conscience nonconformists whose theology was indistinguishable from his own. Perhaps he was as wise as his critics; at any rate the rigour which he repudiated hardly brought peace or strength to the Church when practised by his successors, and London, which was always a difficult see, involved Bishop Sandys in similar troubles when Grindal had gone to York. As it was, although Parker said that Grindal "was not resolute and severe enough for the government of London," his attempts to enforce the use of the surplice evoked angry protests, especially in 1565, when considerable numbers of the nonconformists were suspended; and Grindal of his own motion denounced Cartwright to the Council in 1570. Other anxieties were brought upon him by the burning of his cathedral in 1561, for although Grindal himself is said to have contributed £1200 towards its rebuilding, the laity of his diocese were niggardly with their subscriptions and even his clergy were not liberal.

In 1570 Grindal was translated to the archbishopric of York, where Puritans were few and coercion would be required mainly for Roman Catholics. His first letter from Cawood to Cecil told that he had not been well received, that the gentry were not "well-affected to godly religion and among the common people many superstitious practices remained." It is admitted by his Anglican critics that he did the work of enforcing uniformity against the Roman Catholics with good-will and considerable tact. He must have given general satisfaction, for even before Parker's death two persons so different as Burghley and Dean Nowell independently recommended Grindal's appointment as his successor, and Spenser speaks warmly of him in the *Shepherd's Calendar* as the "gentle shepherd Algrind." Burghley wished to conciliate the moderate Puritans and advised Grindal to mitigate the severity which had characterized Parker's treatment of the nonconformists. Grindal indeed attempted a reform of the ecclesiastical courts, but his metropolitical activity was cut short by a conflict with the arbitrary temper of the queen. Elizabeth required Grindal to suppress the "prophesyings" or meetings for discussion which had come into vogue among the Puritan clergy, and she even wanted him to discourage preaching; she would have no doctrine that was not inspired by her authority. Grindal remonstrated, claiming some voice for the Church, and in June 1577 was suspended from his jurisdiction, though not his spiritual, functions for disobedience. He stood firm, and in January 1578 Secretary Wilson informed Burghley that the queen wished to have the archbishop deprived. She was dissuaded from this extreme course, but Grindal's sequestration was continued in spite of a petition from Convocation in 1581

for his reinstatement. Elizabeth then suggested that he should resign; this he declined to do, and after making an apology to the queen he was reinstated towards the end of 1582. But his infirmities were increasing, and while making preparations for his resignation, he died on the 6th of July 1583 and was buried in Croydon parish church. He left considerable benefactions to Pembroke Hall, Cambridge, Queen's College, Oxford, and Christ's College, Cambridge; he also endowed a free school at St Bees, and left money for the poor of St Bees, Canterbury, Lambeth and Croydon.

Strype's *Life of Grindal* is the principal authority; see also *Dict. Nat. Biogr.* and, besides the authorities there cited, Cough's *General Index to Parker Soc. Publ.*; Acts of the Privy Council; Cal. of Hatfield MSS.; Dixon's *Hist. of the Church of England*; Freer's volume in Stephens and Hunt's series; *Cambridge Mod. Hist.* vol. iii.; Gee's *Elizabethan Clergy*; Birt's *Elizabethan Religious Settlement*; and Pierce's *Introduction to the Marprelate Tracts* (1909). (A. F. F.)

GRINDELWALD, a valley in the Bernese Oberland, and one of the chief resorts of tourists in Switzerland. It is shut in on the south by the precipices of the Wetterhorn, Mettenberg and Eiger, between which two famous glaciers flow down. On the north it is sheltered by the Faulhorn range, while on the east the Great Scheidegg Pass leads over to Meiringen; and on the south-west the Little Scheidegg or Wengern Alp (railway 11½ m. across) divides it from Lauterbrunnen. The main village is connected with Interlaken by a rack railway (13 m.). The valley is very green, and possesses excellent pastures, as well as fruit trees, though little corn is grown. It is watered by the Black Lütschine, a tributary of the Aar. The height of the parish church above the sea-level is 3468 ft. The population in 1900 was 3346, practically all Protestant and German-speaking, and living in 558 houses. The glacier guides are among the best in the Alps. The valley was originally inhabited by the serfs of various great lords in summer for the sake of pasturage. A chapel in a cave was superseded about 1146 by a wooden church, replaced about 1180 by a stone church, which was pulled down in 1793 to erect the present building. Gradually the Austin canons of Interlaken bought out all the other owners in the valley, but when that house was suppressed in 1528 by the town of Bern the inhabitants gained their freedom. The houses near the hotel Adler bear the name of Gydisdorf, but there is no village of Grindelwald properly speaking, though that name is usually given to the assemblage of hotels and shops between Gydisdorf and the railway station. Grindelwald is now very much frequented by visitors in winter.

See W. A. B. Coolidge, *Walks and Excursions in the Valley of Grindelwald* (also in French and German) (Grindelwald, 1900); Emmanuel Friedli, *Bärendütsch als Spiegel bernischen Volkstums*, vol. ii. (Grindelwald, Bern, 1908); E. F. von Mülinen, *Beiträge zur Heimatkunde des Kantons Bern, deutschen Teils*, vol. i. (Bern, 1879), pp. 24-26; G. Strasser, *Der Gletschermann* (Grindelwald, 1888-1890). Scattered notices may be found in the edition (London, 1899) of the "General Introduction" (entitled "Hints and Notes for Travellers in the Alps") to John Ball's *Alpine Guide*. (W. A. B. C.)

GRINGOIRE (or GRINGORE), PIERRE (c. 1480-1539), French poet and dramatist, was born about the year 1480, probably at Caen. In his first work, *Le Chateau de labour* (1499), a didactic poem in praise of diligence, he narrates the troubles following on marriage. A young couple are visited by Care, Need, Discomfort, &c.; and other personages common to medieval allegories take part in the action. In November 1501 Gringoire was in Paris directing the production of a mystery play in honour of the archduke Philip of Austria, and in subsequent years he received many similar commissions. The fraternity of the *Enfants sans Souci* advanced him to the dignity of *Mère Sotte* and afterwards to the highest honour of the guild, that of *Prince des Sots*. For twenty years Gringoire seems to have been at the head of this illustrious confrérie. As *Prince des Sots* he exercised an extraordinary influence. At no time was the stage, rude and coarse as it was, more popular as a true exponent of the popular mind. Gringoire's success lay in the fact that he followed, but did not attempt to lead; on his stage the people saw exhibited their passions, their judgments of the moment, their jealousies, their hatreds and their ambitions. Brotherhoods

of the kind existed all over France. In Paris there were the *Enfants sans Souci*, the *Basochiens*, the *Confrérie de la Passion* and the *Souverain Empire de Gaillie*; at Dijon there were the *Mère Folle* and her family; in Flanders the *Société des Arbalétriers* played comedies; at Rouen the *Cornards* or *Conards* yielded to none in vigour and fearlessness of satire. On Shrove Tuesday 1512 Gringoire, who was the accredited defender of the policy of Louis XII., and had already written many political poems, represented the *Jeu du Prince des Sots et Mère Sotte*. It was at the moment when the French dispute with Julius II. was at its height. *Mère Sotte* was disguised as the Church, and disputed the question of the temporal power with the prince. The political meaning was even more thinly veiled in the second part of the entertainment, a morality named *L'Homme obstiné*, the principal personage representing the pope. The performance concluded with a farce. Gringoire adopted for his device on the frontispiece of this trilogy, *Tout par Raison, Raison par Tout, Par tout Raison*. He has been called the *Aristophane des Halles*. In one respect at least he resembles Aristophanes. He is serious in his merriment; there is purpose behind his extravagances. The Church was further attacked in a poem printed about 1510, *La Chasse du cerf des cerfs* (*cerf des cerfs*, i.e. *servus servorum*), under which title that of the pope is thinly veiled. About 1514 he wrote his mystery of the *Vie de Monseigneur Saint-Louis par personnages* in nine books for the *confrérie* of the masons and carpenters. He became in 1518 herald at the court of Lorraine, with the title of Vaudemont, and married Catherine Roger, a lady of gentle birth. During the last twenty years of a long life he became orthodox, and dedicated a *Blason des hérétiques* to the duke of Lorraine. There is no record of the payment of his salary as a herald after Christmas 1538, so that he died probably in 1539.

His works were edited by C. d'Héricault and A. de Montaiglon for the *Bibliothèque elzevirienne* in 1858. This edition was incomplete, and was supplemented by a second volume in 1877 by Montaiglon and M. James de Rothschild. These volumes include the works already mentioned, except *Le Chateau de labour*, and in addition, *Les Folles Entreprises* (1505), a collection of didactic and satirical poems, chiefly ballades and rondeaux, one section of which is devoted to the exposition of the tyranny of the nobles, and another to the vices of the clergy; *L'Entreprise de Venise* (c. 1509), a poem in seven-lined stanzas, giving a list of the Venetian fortresses which belonged, according to Gringoire, to other powers; *L'Espoir de paix* (1st ed. not dated; another, 1510), a verse treatise on the deeds of "certain popes of Rome," dedicated to Louis XII.; and *La Coqueluche* (1510), a verse description of an epidemic, apparently influenza. For details of his other satires, *Les Abus du monde* (1509), *Complainte de trop tard marié*, *Les Fantasies du monde qui règne*; of his religious verse, *Chants royaux* (on the Passion, 1527), *Heures de Notre Dame* (1525); and a collection of tales in prose and verse, taken from the *Gesta Romanorum*, entitled *Les Fantasies de Mère Sotte* (1516), see G. Brunet, *Manuel du libraire* (s.v. Gringore). Most of Gringoire's works conclude with an acrostic giving the name of the author. *The Chateau de labour* was translated into English by Alexander Barclay and printed by Wynkyn de Worde in 1506. Barclay's translation was edited (1905) with his original for the Roxburghe Club by Mr A. W. Pollard, who provided an account of Gringoire, and a bibliography of the book. See also, for the *Jeu du Prince des Sots*, *Feit de Julleville*, *La Comédie et les mœurs en France au moyen âge*, pp. 151-168 (Paris, 1886); for *Saint Louis*, the same author's *Les Mystères*, i. 331 et seq., ii. 582-597 (1880), with further bibliographical references; and E. Picot, *Gringore et les comédiens italiens* (1877). The real Gringoire cannot be said to have many points of resemblance with the poet described in Victor Hugo's *Notre-Dame de Paris*, nor is there more foundation in fact for the one-act prose comedy of Théodore de Banville.

GRINNELL, a city in Poweshiek county, Iowa, U.S.A., 55 m. E. by N. of Des Moines. Pop. (1900) 3860, of whom 274 were foreign-born; (1905) 4634; (1910) 5036. Grinnell is served by the Chicago, Rock Island & Pacific, and the Iowa Central railways. It is the seat of Iowa College (co-educational), founded in 1847 by the Iowa Band (Congregationalists and graduates of New England colleges and Andover Theological Seminary, who had devoted themselves to home missionary educational work in Iowa, and who came to Iowa in 1843), and by a few earlier pioneers from New England. The college opened in 1848 at Davenport, and in 1850 removed to Grinnell, where there was a school called Grinnell University, which it absorbed. Closely

affiliated with the college are the Grinnell Academy and the Grinnell School of Music. In 1907-1908 the College had 463 students, the Academy had 129 students, and the School of Music had 141 students. Among the manufactures are carriages and gloves. The city was named in honour of one of its founders, Josiah Bushnell Grinnell (1821-1891), a Congregational clergyman, friend of and sympathizer with John Brown, and from 1863 to 1867 a member of the National House of Representatives. Grinnell was settled in 1854, was incorporated as a town in 1865, and in 1882 was chartered as a city of the second class. In 1882 it suffered severely from a cyclone.

GRIQUALAND EAST and **GRIQUALAND WEST**, territorial divisions of the Cape Province of the Union of South Africa. Griqualand East, which lies south of Basutoland and west of Natal, is so named from the settlement there in 1862 of Griquas under Adam Kok. It forms part of the Transkeian Territories of the Cape, and is described under **KAFFRARIA**. Griqualand West, formerly Griqualand simply, also named after its Griqua inhabitants, is part of the great tableland of South Africa. It is bounded S. by the Orange river, W. and N. by Bechuanaland, E. by the Transvaal and Orange Free State Province, and has an area of 15,197 sq. m. It has a general elevation of 3000 to 4000 ft. above the sea, low ranges of rocky hills, the Kaap, Asbestos, Vansittart and Langeberg mountains, traversing its western portion in a general N.E.-S.W. direction. The only perennial rivers are in the eastern district, through which the Vaal flows from a point a little above Fourteen Streams to its junction with the Orange (160 m.). In this part of its course the Vaal receives the Harts river from the north and the Riet from the east. The Riet, 4 m. within the Griqualand frontier, is joined by the Modder. The banks of the rivers are shaded by willows; elsewhere the only tree is the mimosa. The greater part of the country is barren, merging N.W. into absolute desert. The soil is, however, wherever irrigated, extremely fertile. The day climate is hot and dry, but the nights are frequently cold. Rain rarely falls, though thunderstorms of great severity occasionally sweep over the land, and sandstorms are prevalent in the summer. A portion of the country is adapted for sheep-farming and the growing of crops, horse-breeding is carried on at Kimberley, and asbestos is worked in the south-western districts, but the wealth of Griqualand West lies in its diamonds, which are found along the banks of the Vaal and in the district between that river and the Riet. From the first discovery of diamonds in 1867 up to the end of 1905 the total yield of diamonds was estimated at 13½ tons, worth £95,000,000.

The chief town is Kimberley (q.v.), the centre of the diamond mining industry. It is situated on the railway from Cape Town to the Zambesi, which crosses the country near its eastern border. Three miles south of Kimberley is Beaconsfield (q.v.). On the banks of the Vaal are Barkly West (q.v.), Windsorton (pop. 800) and Warrenton (pop. 1500); at all these places are river diggings, diamonds being found along the river from Fourteen Streams to the Harts confluence. Warrenton is 44 m. N. by rail from Kimberley. Douglas (pop. 300), on the south bank of the Vaal, 12 m. above its confluence with the Orange, is the centre of an agricultural district, a canal 9½ m. long serving to irrigate a considerable area. Thirty-five miles N.W. of Douglas is Griquatown (pop. 401), the headquarters of the first Griqua settlers. Campbell (pop. 250) is 30 m. E. of Griquatown, and Postmasburg 42 m. N. by W. A census taken in 1877 showed the population of Griqualand West to be 45,277, of whom 12,347 were whites. At the census of 1891 the population was 83,215, of whom 29,602 were whites, and in 1904 the population was 108,498, of whom 32,570 were whites.

History.—Before the settlement in it of Griqua clans the district was thinly inhabited by Bushmen and Hottentots. At the end of the 18th century a horde known as Bastaards, descendants of Dutch farmers and Hottentot women, led a nomadic life on the plains south of the Orange river. In 1803 a missionary named Anderson induced a number of the Bastaards with their chief Barend Barends to settle north of the river, and a mission station was formed at a place where there was a strong

flowing fountain, which has now disappeared, which gave the name of Klaarwater to what is now known as Griquatown or Griquatad. Klaarwater became a retreat for other Bastaards, Hottentot refugees, Kafirs and Bechuanas. From Little Namaqualand came a few half-breeds and others under the leadership of Adam Kok, son of Cornelius Kok and grandson of Adam Kok (c. 1710-1795), a man of mixed white and Hottentot blood who is regarded as the founder of the modern Griquas. The settlement prospered, and in 1813, at the instance of the Rev. John Campbell, who had been sent by the London Missionary Society to inspect the country, the tribesmen abandoned the name of Bastaards in favour of that of Griquas,¹ some of them professing descent from a Hottentot tribe, originally settled near Saldanha Bay, called by the early Dutch settlers at the Cape Chariguriqua or Grigriqua. Under the guidance of missionaries the Griquas made some progress in civilization, and many professed Christianity. Adam Kok and Barends having moved eastward in 1820, those who remained behind elected as their head man a teacher in the mission school named Andries Waterboer, who successfully administered the settlement, and by defeating the Makololo raiders greatly increased the prestige of the tribe. Meanwhile Adam Kok and his companions had occupied part of the country between the Modder and Orange rivers. In 1825 Kok settled at the mission station of Philippolis (founded two years previously), and in a short time had exterminated the Bushmen inhabiting that region. He died about 1835, and after a period of civil strife was succeeded by his younger son, Adam Kok III. This chief in November 1843 signed a treaty placing himself under British protection. Many Dutch farmers were settled on the land he claimed. In 1845 he received British military aid in a contest with the white settlers, and in 1848 helped the British under Sir Harry Smith against the Boers (see ORANGE FREE STATE: *History*). Eventually finding himself straitened by the Boers of the newly established Orange Free State, he removed in 1862-1863 with his people, some 3000 in number, to the region (then depopulated by Kafir wars) now known as Griqualand East. His sovereign rights to all territory north of the Orange he sold to the Free State for £4000. He founded Kokstad (q. v.) and died in 1876. Waterboer, the principal Griqua chief, had entered into treaty relations with the British government as early as 1834, and he received a subsidy of £150 a year. He proved a staunch ally of the British, and kept the peace on the Cape frontier to the day of his death in 1852. He was succeeded by his son Nicholas Waterboer, under whom the condition of the Griquas declined—a decline induced by the indolence of the people and intensified by the drying up of the water supplies, cattle plague and brandy drinking. During this period white settlers acquired farms in the country, and the loss of their independence by the Griquas became inevitable. The discovery of diamonds along the banks of the Vaal in 1867 entirely altered the fortunes of the country, and by the end of 1869 the rush to the alluvial diggings had begun. At the diggers' camps the Griquas exercised no authority, but over part of the district the South African Republic and the Orange Free State claimed sovereignty. At Klip Drift (now Barkly West) the diggers formed a regular government and elected Theodore Parker as their president. Most of the diggers being British subjects, the high commissioner of South Africa interfered, and a Cape official was appointed magistrate at Klip Drift, President Parker resigning office in February 1871. At this time the "dry diggings," of which Kimberley is the centre, had been discovered,² and over the miners there the Orange Free State asserted jurisdiction. The land was, however, claimed by Nicholas Waterboer, who, on the advice of his agent, David Arnot, petitioned the British to take over his country. This Great Britain consented to do, and on the 27th of October 1871 proclamations were issued by the high commissioner

receiving Waterboer and his Griquas as British subjects and defining the limits of his territory. In addition to the Kimberley district this territory included that part of the diamondiferous area which had been claimed by the Transvaal, but which had been declared, as the result of the arbitration of R. W. Keate, lieutenant-governor of Natal, part of Waterboer's land. On the 4th of November a small party of Cape Mounted Police took possession of the dry diggings and hoisted the British flag. Shortly afterwards the representative of the Orange Free State withdrew. The Free State was greatly incensed by the action of the British government, but the dispute as to the sovereignty was settled in 1876 by the payment of £90,000 by the British to the Free State as compensation for any injury inflicted on the state.

The diggers, who under the nominal rule of the Transvaal and Free State had enjoyed practical independence, found the new government did little for their benefit, and a period of disorder ensued, which was not put an end to by the appointment in January 1873 of Mr (afterwards Sir) Richard Southey³ as sole administrator, in place of the three commissioners who had previously exercised authority. In the July following the territory was made a crown colony and Southey's title changed to that of lieutenant-governor. The government remained unpopular, the diggers complaining of its unrepresentative character, the heavy taxation exacted, and the inadequate protection of property. They formed a society for mutual protection, and the discontent was so great that an armed force was sent (early in 1875) from the Cape to overawe the agitators. At the same time measures were taken to render the government more popular. The settlement of the dispute with the Free State paved the way for the annexation of Griqualand to the Cape Colony on the 15th of October 1880.

See KIMBERLEY, CAPE COLONY, TRANSVAAL and ORANGE FREE STATE. For the early history of the country and an account of life at the diggings, 1871-1875, consult G. M'Call Theal's *Compendium of the History and Geography of South Africa* (London, 1878), chapters xl. and xli.; Gardner F. Williams, *The Diamond Mines of South Africa* (New York and London, 1902); and the works bearing on the subject quoted in that book. See also Theal's *History of South Africa . . . 1834-1854* (London, 1893); J. Campbell, *Travels in South Africa* (London, 1815), *Travels . . . A Second Journey . . .* (2 vols., London, 1822); the Blue Books C. 459 of 1871 and C. 508 of 1872 (the last-named containing the Keate award, &c.); the Griqualand West report in *Papers relating to Her Majesty's Colonial Possessions*, part ii. (1873), and the *Life of Sir Richard Southey, K.C.M.G.*, by A. Wilmot (London, 1904). For the Griqua people consult G. W. Stow, *The Native Races of South Africa*, chapters xvii.-xx. (London, 1905).

GRISAILLE, a French term, derived from *gris*, grey, for painting in monochrome in various shades of grey, particularly used in decoration to represent objects in relief. The frescoes of the roof of the Sistine chapel have portions of the design in *grisaille*. At Hampton Court the lower part of the decoration of the great staircase by Verrio is in *grisaille*. The term is also applied to monochrome painting in enamels, and also to stained glass; a fine example of *grisaille* glass is in the window known as the Five Sisters, at the end of the north transept in York cathedral.

GRISELDA, a heroine of romance. She is said to have been the wife of Walter, marquis of Saluces or Saluzzo, in the 11th century, and her misfortunes were considered to belong to history when they were handled by Boccaccio and Petrarch, although the probability is that Boccaccio borrowed his narrative from a Provençal *fabliau*. He included it in the recitations of the tenth day (*Decamerone*), and must have written it about 1350. Petrarch related it in a Latin letter in 1373, and his translation formed the basis of much of the later literature. The letter was printed by Ulrich Zel about 1470, and often subsequently. It was translated into French as *La Patience de*

¹ The Griquas, as a distinct tribe, numbered at the Cape census of 1904 but 6289. They have largely intermarried with Kafir and Bechuana tribes.

² The order of discovery of the chief mines was:—Dutoitspan, Sept. 1870; Bultfontein, Nov. 1870; De Beers, May 1871; Colesberg Kop (Kimberley), July 1871.

³ Sir Richard Southey (1809-1901) was the son of one of the emigrants from the west of England to Cape Colony (1820). He organized and commanded a corps of Guides in the Kafir war of 1834-35, and was with Sir Harry Smith at Boomplaats (1848). From 1864 to 1872 he was colonial secretary at the Cape. He gave up his appointment in Griqualand West in 1875, and lived thereafter in retirement. In 1891 he was created a K.C.M.G.

Criselidis and printed at Bréhan-Loudéac in 1484, and its popularity is shown by the number of early editions quoted by Brunet (*Manuel du libraire*, s.v. Petrarca). The story was dramatized in 1395, and a *Mystère de Criselidis, marquise de Saluces par personnages* was printed by Jehan Bonfons (no date). Chaucer followed Petrarch's version in the *Canterbury Tales*. Ralph Radcliffe, who flourished under Henry VIII., is said to have written a play on the subject, and the story was dramatized by Thomas Dekker, Henry Chettle and W. Haughton in 1603.

An example of the many ballads of Griselida is given in T. Deloney's *Garland of Good Will* (1685), and the 17th-century chap-book, *The History of Patient Grisel* (1619), was edited by H. B. Wheatley (1885) for the Villon Society with a bibliographical and literary introduction.

GRISI, GIULIA (1811-1869), Italian opera-singer, daughter of one of Napoleon's Italian officers, was born in Milan. She came of a family of musical gifts, her maternal aunt Josephina Grassini (1773-1850) being a favourite opera-singer both on the continent and in London; her mother had also been a singer, and her elder sister Giudetta and her cousin Carlotta were both exceedingly talented. Giulia was trained to a musical career, and made her stage début in 1828. Rossini and Bellini both took an interest in her, and at Milan she was the first Adalgisa in Bellini's *Norma*, in which Pasta took the title-part. Grisi appeared in Paris in 1832, as Semiramide in Rossini's opera, and had a great success; and in 1834 she appeared in London. Her voice was a brilliant dramatic soprano, and her established position as a prima donna continued for thirty years. She was a particularly fine actress, and in London opera her association with such singers as Lablache, Rubini, Tamburini and Mario was long remembered as the palmy days of Italian opera. In 1854 she toured with Mario in America. She had married Count de Melcy in 1836, but this ended in a divorce; and in 1856 she married Mario (q.v.). She died in Berlin on the 29th of November 1869.

GRISON (*Galeotis vittata*), a carnivorous mammal, of the family *Mustelidae*, common in Central and South America and Mexico. It is about the size of a marten, and has the upper surface of a bluish-grey tint, and the under surface is dark brown. The grison lives on small mammals and birds, and in settled districts is destructive to poultry. Allamand's grison (*G. allamandi*), with the same range, is somewhat larger. Another member of the genus is the tayra or taira (*G. barbara*), about as large as an otter, with a range from Mexico to Argentina. This species hunts in companies (see CARNIVORA).

GRISONS (Ger. *Graubünden*), the most easterly of the Swiss cantons and also the largest in extent, though relatively the most sparsely populated. Its total area is 2753.2 sq. m., of which 1634.4 sq. m. are classed as "productive" (forests covering 503.1 sq. m. and vineyards 1.3 sq. m.), but it has also 138.6 sq. m. of glaciers, ranking in this respect next after the Valais and before Bern. The whole canton is mountainous, the principal glacier groups being those of the Tödi, N. (11,887 ft.), of Medels, S.W. (Piz Medel, 10,500 ft.), of the Rheinwald or the Adula Alps, S.W. (Rheinwaldhorn, 11,149 ft.), with the chief source of the Rhine, of the Bernina, S.E. (Piz Bernina, 13,304 ft.), the most extensive, of the Albula, E. (Piz Keusch, 11,228 ft.), and of the Silvretta, N.E. (Piz Linard, 11,201 ft.). The principal valleys are those of the upper Rhine and of the upper Inn (or Engadine, q.v.). The three main sources of the Rhine are in the canton. The valley of the Vorder Rhine is called the Bündner Oberland, that of the Mittel Rhine the Val Medels, and that of the Hinter Rhine (the principal), in different parts of its course, the Rheinwald, the Schams valley and the Domleschg valley, while the upper valley of the Julia is named the Oberhalbstein. The chief affluents of the Rhine in the canton are the Gleuner (flowing through the Lugnetz valley), the Avers Rhine, the Albula (swollen by the Julia and the Landwasser), the Plessur (Schanfigg valley) and the Landquart (coming from the Prättigau). The Rhine and the Inn flow respectively into the North and the Black Seas. Of other streams that of Val Mesocco joins the Ticino and so the Po, while the Maira or Mera (Val Bregaglia) and the Poschiavino join the Adda, and the Rambach (Münster

valley) the Adige, all four thus ultimately reaching the Adriatic Sea. The inner valleys are the highest in Central Europe, and among the loftiest villages are Juf, 6998 ft. (the highest permanently inhabited village in the Alps), at the head of the Avers glen, and St Moritz, 6037 ft., in the Upper Engadine. The lower courses of the various streams are rent by remarkable gorges, such as the Via Mala, the Rofna, the Schyn, and those in the Avers, Medels and Lugnets glens, as well as that of the Züge in the Landwasser glen. Below Coire, near Malans, good wine is produced, while in the Val Mesocco, etc., maize and chestnuts flourish. But the forests and the mountain pasturages are the chief source of wealth. The lower pastures maintain a fine breed of cows, while the upper are let out in summer to Bergamasque shepherds. There are many mineral springs, such as those of St Moritz, Schuls, Alvaneu, Fideris, Le Prese and San Bernardino. The climate and vegetation, save on the southern slope of the Alps, are alpine and severe. But yearly vast numbers of strangers visit different spots in the canton, especially Davos (q.v.), Aross and the Engadine. As yet there are comparatively few railways. There is one from Maienfeld (continued north to Constance and north-west to Zürich) to Coire (11 m.), which sends off a branch line from Landquart, E., past Klosters to Davos (31 m.). From Coire the line bears west to Reichenau (6 m.), whence one branch runs S.S.E. beneath the Albula Pass to St Moritz (30 m.), and another S.W. up the Hinter Rhine valley to Ilanz (20½ m.). There are, however, a number of fine carriage roads across the passes leading to or towards Italy. Besides those leading to the Engadine may be noted the roads from Ilanz past Disentis over the Oberalp Pass (6719 ft.) to Andermatt, from Disentis over the Lukmanier Pass (6289 ft.) to Biasca, on the St Gotthard railway, from Reichenau past Thusis and Splügen over the San Bernardino Pass (6769 ft.) to Bellinzona on the same railway line, and from Splügen over the Splügen Pass (6946 ft.) to Chiavenna. The Septimer Pass (7582 ft.) from the Julier route to the Maloja route has now only a mule path, but was probably known in Roman times (as was possibly the Splügen), and was much frequented in the middle ages.

The population of the canton in 1900 was 204,520. Of this number 55,155 (mainly near Coire and Davos, in the Prättigau and in the Schanfigg valley) were Protestants, while 49,142 (mainly in the Bündner Oberland, the Val Mesocco and the Oberhalbstein) were Romanists, while there were also 114 Jews (81 of whom lived in Davos). In point of language 48,764 (mainly near Coire and Davos, in the Prättigau and in the Schanfigg valley) were German-speaking, while 17,539 (mostly in the Val Mesocco, the Val Bregaglia and the valley of Poschlaw, but including a number of Italian labourers engaged on the construction of the Albula railway) were Italian-speaking. But the characteristic tongue of the Grisons is a survival of an ancient Romance language (the *lingua rustica* of the Roman Empire), which has lagged behind its sisters. It has a scanty printed literature, but is still widely spoken, so that, of the 38,651 persons in the Swiss Confederation who speak it, no fewer than 36,472 are in the Grisons. It is distinguished into two dialects: the Romansch (sometimes wrongly called Romansch), which prevails in the Bündner Oberland and in the Hinter Rhine valley (Schams and Domleschg), and the Ladin (closely related to the tongue spoken in parts of the South Tyrol), that survives in the Engadine and in the neighbouring valleys of Bergin, Oberhalbstein and Münster. (See F. Rausch's *Geschichte der Literatur des rhaeto-romanischen Volkes*, Frankfurt, 1879, and Mr Coolidge's bibliography of this language, given on pp. 22-23 of Lorria and Martel's *Le Massif de la Bernina*, Zürich, 1894.) Yet in the midst of this Romance-speaking population are islets (mostly, if not entirely, due to immigration in the 13th century from the German-speaking Upper Valais) of German-speaking inhabitants, so in the Vals and Safen glens, and at Obersaxen (all in the Bündner Oberland), in the Rheinwald (the highest part of the Hinter Rhine valley), and in the Avers glen (middle reach of the Hinter Rhine valley), as well as in and around Davos itself.

There is not much industrial activity in the Grisons. A

considerable portion of the population is engaged in attending to the wants of the foreign visitors, but there is a considerable trade with Italy, particularly in the wines of the Valtellina, while many young men seek their fortunes abroad (returning home after having accumulated a small stock of money) as confectioners, pastry-cooks and coffee-house keepers. A certain number of lead and silver mines were formerly worked, but are now abandoned. The capital of the canton is Coire (q.v.).

The canton is divided into 14 administrative districts, and includes 224 communes. It sends 2 members (elected by a popular vote) to the Federal *Sänderath*, and 5 members (also elected by a popular vote) to the Federal *Nationalrath*. The existing-cantonal constitution was accepted by the people in 1894, and came into force on 1st January 1894. The legislature (*Grossrath*—no numbers fixed by the constitution) is elected for 2 years by a popular vote, as are the 5 members of the executive (*Kleinerath*) for 3 years. The "obligatory referendum" obtains in the case of all laws and important matters of expenditure, while 3000 citizens can demand ("facultative referendum") a popular vote as to resolutions and ordinances made by the legislature. Three thousand citizens also have the right of "initiative" as to legislative projects, but 5000 signatures are required for a proposed revision of the cantonal constitution. In the revenue and expenditure of the canton the taxes are never counted. This causes an apparent deficit which is carried to the capital account, and is met by the land tax (art. 19 of the constitution), so that there is never a real deficit, as the amount of the land tax varies annually according to the amount that must be provided. In the pre-1799 constitution of the three Rætian Leagues the system of the "referendum" was in working as early as the 16th century, not merely as between the three Leagues themselves, but as between the bailiwicks (*Hochgerichte*), the sovereign units within each League, and sometimes (as in the Upper Engadine) between the villages composing each bailiwick.

The greater part (excluding the three valleys where the inhabitants speak Italian) of the modern canton of the Grisons formed the southern part of the province of Raetia (probably the aboriginal inhabitants, the Raeti, were Celts rather than, as was formerly believed, Etruscans), set up by the Romans after their conquest of the region in 15 B.C. The Romanized inhabitants were to a certain extent (The Romansch or Latin tongue is a survival of the Roman dominion) Teutonized under the Ostrogoths (A.D. 493-537) and under the Franks (from 537 onwards). Governors called *Fraesides* are mentioned in the 7th and 8th centuries, while members of the same family occupied the episcopal see of Coire (founded 4th-5th centuries). About 806 Charles the Great made this region into a county, but in 831 the bishop procured for his dominions exemption ("immunity") from the jurisdiction of the counts, while before 847 his see was transferred from the Italian province of Milan to the German province of Mainz (Mayence) and was thus cut off from Italy to be joined to Germany. In 916 the region was united with the duchy of Alamannia, but the bishop still retained practical independence, and his wide-spread dominions placed him even above the abbots of Disentis and Pfäfers, who likewise enjoyed "immunity." In the 10th century the bishop obtained fresh privileges from the emperors (besides the Val Bregaglia in 960), and so became the chief of the many feudal nobles who struggled for power in the region. He became a prince of the empire in 1170 and later allied himself with the rising power (in the region) of the Habsburgers. This led in 1367 to the foundation of the League of God's House or the *Gotteshausbund* (composed of the city and chapter of Coire, and of the bishop's subjects, especially in the Engadine, Val Bregaglia, Domleschg and Oberhalbstein) in order to stem his rising power, the bishop entering it in 1392. In 1395 the abbot of Disentis, the men of the Lugnetz valley, and the great feudal lords of Râruns and Sax (in 1399 the counts of Werdenberg came in) formed another League, called the *Ober Bund* (as comprising the highlands in the Vorder Rhine valley) and also wrongly the "Grey League" (as the word interpreted "grey" is simply a misreading of

grösser or counts, though the false view has given rise to the name of Grisons or Graubünden for the whole canton), their alliance being strengthened in 1424 when, too, the free men of the Rheinwald and Schams came in, and in 1480 the Val Mesocco also. Finally, in 1436, the third Rætian League was founded, that of the *Zehngerichtenbund* or League of the Ten Jurisdictions, by the former subjects of the count of Toggenburg, whose dynasty then became extinct; they include the inhabitants of the Prättigau, Davos, Malenfeld, the Schanfigg valley, Churwalden, and the lordship of Belfort (i.e. the region round Alvaneu), and formed ten bailiwicks, whence the name of the League. In 1450 the *Zehngerichtenbund* concluded an alliance with the *Gotteshausbund* and in 1471 with the *Ober Bund*; but of the so-called perpetual alliance at Vazerol, near Tiefenkastels, there exists no authentic evidence in the oldest chronicles, though diets were held there. By a succession of purchases (1477-1496) nearly all the possessions of the extinct dynasty of the counts of Toggenburg in the Prättigau had come to the junior or Tyrolean line of the Habsburgers. On its extinction (1496) in turn they passed to the elder line, the head of which, Maximilian, was already emperor-elect and desired to maintain the rights of his family there and in the Lower Engadine. Hence in 1497 the *Ober Bund* and in 1498 the *Gotteshausbund* became allies of the Swiss Confederation. War broke out in 1499, but was ended by the great Swiss victory (22nd May 1499) at the battle of the Calven gorge (above Mals) which, added to another Swiss victory at Dornach (near Basel), compelled the emperor to recognize the practical independence of the Swiss and their allies of the Empire. The religious Reformation brought disunion into the three Leagues, as the *Ober Bund* clung in the main to the old faith, and for this reason their connexion with the Swiss Confederation was much weakened. In 1526, by the Articles of Ilanz, the last remaining traces of the temporal jurisdiction of the bishop of Coire was abolished. In 1486 Poschiavo had at last been secured from Milan, and Malenfeld with Malans was bought in 1509, while in 1549 the Val Mesocco (included in the *Ober Bund* since 1480) purchased its freedom of its lords, the Trivulzio family of Milan. In 1512 the three Leagues conquered from Milan the rich and fertile Valtellina, with Bormio and Chiavenna, and held these districts as subject lands till in 1797 they were annexed to the Cisalpine Republic. The struggle for lucrative offices in these lands further sharpened the long rivalry between the families of Planta (Engadine) and Salis (Val Bregaglia), while in the 17th century this rivalry was complicated by political enmities, as the Plantas favoured the Spanish side and the Salis that of France during the long struggle (1620-1639) for the Valtellina (see JENATSCH and VALTELLINA). Troubles arose (1622) also in the Prättigau through the attempts of the Habsburgers to force the inhabitants to give up Protestantism. Finally, after the emperor had formally recognized, by the treaty of Westphalia (1648), the independence of the Swiss Confederation, the rights of the Habsburgers in the Prättigau and the Lower Engadine were bought up (1649 and 1652). But the Austrian *enclaves* of Tarasp (Lower Engadine) and of Râruns (near Reichenau) were only annexed to the Grisons in 1809 and 1815 respectively, in each case France holding the lordship for a short time after its cession by Austria. In 1748 (finally in 1762) the three Leagues secured the upper portion of the valley of Münster. In 1799 the French invaded the canton, which became the scene of a fierce conflict (1799-1800) between them and the united Russian and Austrian army, in the course of which the French burnt (May 1799) the ancient convent of Disentis with all its literary treasures. In April 1799 the provisional government agreed to the incorporation of the three Leagues in the Helvetic Republic, though it was not till June 1801 that the canton of Raetia became formally part of the Helvetic Republic. In 1803, by Napoleon's Act of Mediation, it entered, under the name of Canton of the Grisons or Graubünden, the reconstituted Swiss Confederation, of which it then first became a full member.

AUTHORITIES.—A. Andrea, *Das Bergell* (Frauenfeld, 1901); *Bündnergeschichte in 11 Vorträgen*, by various writers (Coire, 1902);

Codex diplomaticus Rætiæ (5 vols., Coire, 1848-1886); W. Cox, *Travels in Switzerland*, vol. ii. of the 1789 London edition; E. Durant, *La Réunion des Grisons à la Suisse (1798-1799)* (Basel, 1899); G. Fient, *Das Prättigau* (2nd ed., Davos, 1897); P. Foffa, *Das bündnerische Münsterthal* (Coire, 1864); F. Fossati, *Codice diplomatico della Rezia* (originally published in the *Periodico della Società storica a Comense* at Como; separate reprint, Como, 1901); R. A. Ganzoni, *Beiträge zur Kenntnis d. bündnerischen Referendums* (Zürich, 1890); Mrs Henry Freshfield, *A Summer Tour in the Grisons* (London, 1862); C. and F. Jecklin, *Der Anteil Graubündens am Schwabenkrieg (1399)* (Davos, 1899); C. von Moor, *Geschichte von Curraetien* (2 vols., Coire, 1870-1874), and *Wegweiser* (Coire, 1873); E. Lechner, *Das Thal Bergell* (2nd ed., Leipzig, 1874); G. Leonhardi, *Das Poschiavinothal* (Leipzig, 1859); A. Lorria and E. A. Martel, *Le Massif de la Bernina* (Upper Engadine and Val Bregaglia) (Zürich, 1894); P. C. von Planta, *Das alte Rætien* (Berlin, 1872); *Die curraetischen Herrschaften in d. Feudalzeit* (Bern, 1881); *Geschichte von Graubünden* (Bern, 1892); and *Chronik d. Familie von Planta* (Zürich, 1892); W. Plattner, *Die Entstehung d. Freistaates der 3 Bünde* (Davos, 1895); R. von Reding-Biberberg, *Der Zug Saworoff's durch die Schweiz in 1799* (Stans, 1895); N. Salis-Soglio, *Die Familie von Salis* (Lindau, 1891); G. Theobald, *Das Bündner Oberland* (Coire, 1861), and *Naturbilder aus den rhaetischen Alpen* (4rd ed., Coire, 1893); N. Valser, *Johannes von Planta* (d. 1572) (Zürich, 1888); R. Wagner and L. R. von Salia, *Rechtquellen d. Cant. Graubünden* (Basel, 1877-1892); F. Jecklin, *Materialien zur Ständer- und Landesgeschichte Gem. üii. Bünde* (Graubünden), 1664-1803 (pt. I., *Regesten*, was published at Basel in 1907). See also COIRE, ENGADINE, JENATSCH and VALTELLINA. (W. A. B. C.)

GRISWOLD, RUFUS WILMOT (1815-1857), American editor and compiler, was born in Benson, Vermont, on the 15th of February 1815. He travelled extensively, worked in newspaper offices, was a Baptist clergyman for a time, and finally became a journalist in New York City, where he was successively a member of the staffs of *The Brother Jonathan*, *The New World* (1839-1840) and *The New Yorker* (1840). From 1841 to 1843 he edited *Graham's Magazine* (Philadelphia), and added to its list of contributors many leading American writers. From 1850 to 1852 he edited the *International Magazine* (New York), which in 1852 was merged into *Harper's Magazine*. He died in New York City on the 27th of August 1857. He is best known as the compiler and editor of various anthologies (with brief biographies and critiques), such as *Poets and Poetry of America* (1842), his most popular and valuable book; *Prose Writers of America* (1846); *Female Poets of America* (1848); and *Sacred Poets of England and America* (1849). Of his own writings his *Republican Court: or American Society in the Days of Washington* (1854) is the only one of permanent value. He edited the first American edition of Milton's prose works (1845), and, as literary executor, edited, with James R. Lowell and N. P. Willis, the works (1850) of Edgar Allan Poe. Griswold's great contemporary reputation as a critic has not stood the test of time; but he rendered a valuable service in making Americans better acquainted with the poetry and prose of their own countrymen.

See *Passages from the Correspondence and Other Papers of Rufus W. Griswold* (Cambridge, Mass., 1898), edited by his son William McCrillis Griswold (1853-1899).

GRIVET, a monkey, *Cercopithecus sabaens*, of the guenon group, nearly allied to the green monkey. It is common throughout equatorial Africa. The chin, whiskers and a broad band across the forehead, as well as the under-parts, are white, and the head and back olive-green. These monkeys are very commonly seen in menageries.

GROAT (adapted from the Dutch *groot*, great, thick; cf. Ger. *Groschen*; the Med. Lat. *grossus* gives Ital. *grosso*, Fr. *gros*, as names for the coin), a name applied as early as the 13th century on the continent of Europe to any large or thick coin. The great was almost universally a silver coin, but its value varied considerably, as well at different times as in different countries. The English great was first coined in 1351, of a value somewhat higher than a penny. The continuous debasement of both the penny and the great left the latter finally worth four pennies. The issue of the great was discontinued after 1662, but a coin worth fourpence was again struck in 1836. Although frequently referred to as a great, it had no other official designation than a "fourpenny piece." Its issue was again discontinued in 1856. The great was imitated in Scotland by a coin struck

by David II. in 1358. In Ireland it was first struck by Edward IV. in 1460.

GROCER, literally one who sells by the gross, a wholesale dealer; the word is derived through the O. Fr. form, *grossia*, from the Med. Lat. *grossarius*, defined by du Cange, *Glossarium*, s.v. *Grossares*, as *solidae mercis propola*. The name, as a general one for dealers by wholesale, "engrossers" as opposed to "regrators," the retail dealers, is found with the commodity attached; thus in the *Monimenta Gildhallæ* ("Rolls" series) ii. 1.304 (quoted in the *New English Dictionary*) is found an allusion to *grossours de vin*, cf. *grosser of fysche*, *Surtex Miz.* (1888) 63, for the customs of Malton (quoted *ib.*). The specific application of the word to one who deals either by wholesale or retail in tea, coffee, cocoa, dried fruits, spices, sugar and all kinds of articles of use or consumption in a household is connected with the history of the Grocers' Company of London, one of the twelve "great" livery companies. In 1345 the pepperers and the spicers amalgamated and were known as the Fraternity of St Anthony. The name "grocers" first appears in 1373 in the records of the company. In 1386 the association was granted a right of search over all "spicers" in London, and in 1394 they obtained the right to inspect or "garble" spices and other "subtil wares." Their first charter was obtained in 1428; letters patent in 1447 granted an extension of the right of search over the whole county, but removed the "liberties" of the city of London. They sold all kinds of drugs, medicines, ointments, plasters, and medicated and other waters. For the separation of the apothecaries from the grocers in 1617 see APOTHECARY. (See further LIVERY COMPANIES.)

See *The Grocery Trade*, by J. Aubrey Rees (1910).

GROCYN, WILLIAM (1446?-1510), English scholar, was born at Colerne, Wiltshire, about 1446. Intended by his parents for the church, he was sent to Winchester College, and in 1465 was elected to a scholarship at New College, Oxford. In 1467 he became a fellow, and had among his pupils William Warham, afterwards archbishop of Canterbury. In 1479 he accepted the rectory of Newton Longville, in Buckinghamshire, but continued to reside at Oxford. As reader in divinity in Magdalen College in 1481, he held a disputation with John Taylor, professor of divinity, in presence of King Richard III., and the king acknowledged his skill as a debater by the present of a buck and five marks. In 1485 he became prebendary of Lincoln cathedral. About 1488 Grocyn left England for Italy, and before his return in 1491 he had visited Florence, Rome and Padua, and studied Greek and Latin under Demetrius Chalcondyles and Politian. As lecturer in Exeter College he found an opportunity of indoctrinating his countrymen in the new Greek learning.

Erasmus says in one of his letters that Grocyn taught Greek at Oxford before his visit to Italy. The Warden of New College, Thomas Chaudler, invited Cornelius Vitelli, then on a visit to Oxford, to act as prelector. This was about 1475, and as Vitelli was certainly familiar with Greek literature, Grocyn may have learnt Greek from him. He seems to have lived in Oxford until 1499, but when his friend Colet became dean of St Paul's in 1504 he was settled in London. He was chosen by his friend to deliver lectures in St Paul's; and in this connexion he gave a singular proof of his honesty. He had at first denounced all who impugned the authenticity of the *Hierarchia ecclesiastica* ascribed to Dionysius the Areopagite, but, being led to modify his views by further investigation, he openly declared that he had been completely mistaken. He also counted Linacre, William Lily, William Latimer and More among his friends, and Erasmus writing in 1514 says that he was supported by Grocyn in London, and calls him "the friend and preceptor of us all." He held several preferments, but his generosity to his friends involved him in continual difficulties, and though in 1506 he was appointed on Archbishop Warham's recommendation master or warden of All Hallows College at Maidstone in Kent, he was still obliged to borrow from his friends, and even to pledge his plate as a security. He died in 1510, and was buried in the collegiate church at Maidstone. Linacre acted as his executor, and expended the money he received in gifts

to the poor and the purchase of books for poor scholars. With the exception of a few lines of Latin verse on a lady who snow-balled him, and a letter to Aldus Manutius at the head of Linacre's translation of Proclus's *Sphaera* (Venice, 1499), Grocyon has left no literary proof of his scholarship or abilities. His proposal to execute a translation of Aristotle in company with Linacre and Latimer was never carried out. Wood assigns some Latin works to Grocyon, but on insufficient authority. By Erasmus he has been described as "vir severissimae castissimae vitae, ecclesiasticarum constitutionum observantissimus pene usque ad superstitionem, scholasticae theologiae ad unguem doctus ac natura etiam acerrimi iudicis, demum in omni disciplinarum genere exacte versatus" (*Declarationes ad censuras facultatis theologiae Parisianae*, 1522).

An account of Grocyon by Professor Burrows appeared in the Oxford Historical Society's *Collectanea* (1890).

GRODNO, one of the Lithuanian governments of western Russia, lying between 51° 40' and 52° N. and between 22° 12' and 26° E., and bounded N. by the government of Vilna, E. by Minsk, S. by Volhynia, and W. by the Polish governments of Lomza and Siedlce. Area, 14,926 sq. m. Except for some hills (not exceeding 925 ft.) in the N., it is a uniform plain, and is drained chiefly by the Bug, Niemen, Narev and Bobr, all navigable. There are also several canals, the most important being the Augustowo and Oginsky. Granites and gneisses crop out along the Bug, Cretaceous, and especially Tertiary, deposits elsewhere. The soil is mostly sandy, and in the district of Grodno and along the rivers is often drift-sand. Forests, principally of *Coniferae*, cover more than one-fourth of the area. Amongst them are some of vast extent, e.g. those of Grodno (410 sq. m.) and Byelovitsa (Bialowice) (376 sq. m.), embracing wide areas of marshy ground. In the last mentioned forest the wild ox survives, having been jealously preserved since 1803. Peat bogs, sometimes as much as 4 to 7 ft. thick, cover extensive districts. The climate is wet and cold; the annual mean temperature being 44.5° F., the January mean 22.5° and the July mean 64.5°. The rainfall amounts to 21½ in.; hail is frequent. Agriculture is the predominant industry. The peasants own 42½ % of the land, that is, about 4,000,000 acres, and of these over 2½ million acres are arable. The crops principally grown are potatoes, rye, oats, wheat, flax, hemp and some tobacco. Horses, cattle and sheep are bred in fairly large numbers. There is, however, a certain amount of manufacturing industry, especially in woollens, distilling and tobacco. In woollens this government ranks second (after Moscow) in the empire, the centre of the industry being Byelostok. Other factories produce silk, shoddy and leather. The government is crossed by the main lines of railway from Warsaw to St Petersburg and from Warsaw to Moscow. The population numbered 1,008,521 in 1870 and 1,616,630 in 1897; of these last 789,801 were women and 255,946 were urban. In 1906 it was estimated at 1,826,600. White Russians predominate (54 %), then follow Jews (17.4 %), Poles (10 %), Lithuanians and Germans. The government is divided into nine districts, the chief towns, with their populations in 1897, being Grodno (*q.v.*), Brest-Litovsk (pop. 42,812 in 1901), Byelsk (7461), Byelostok or Bialystok (65,781 in 1901), Kobrin (10,365), Pruzhany (7634), Slonim (15,893), Sokolsk (7595) and Volkovysk (10,584). In 1795 Grodno, which had been Polish for ages, was annexed by Russia.

GRODNO, a town of Russia, capital of the government of the same name in 53° 40' N. and 23° 50' E., on the right bank of the Niemen, 160 m. by rail N.E. of Warsaw and 98 m. S.W. of Vilna on the main line to St Petersburg. Pop. (1901) 41,736, nearly two-thirds Jews. It is an episcopal see of the Orthodox Greek church and the headquarters of the II. Army Corps. It has two old castles, now converted to other uses, and two churches (16th and 17th centuries). Tobacco factories and distilleries are important; machinery, soap, candles, vehicles and firearms are also made. Built in the 12th century, Grodno was almost entirely destroyed by the Mongols (1241) and Teutonic knights (1284 and 1391). Stephen Bathory, king of Poland, made it his capital, and died there in 1586. The Polish Estates frequently

met at Grodno after 1673, and there in 1793 they signed the second partition of Poland. It was at Grodno that Stanislaus Poniatowski resigned the Polish crown in 1795.

GROEN VAN PRINSTERER, GUILLAUME (1801-1876), Dutch politician and historian, was born at Voorburg, near the Hague, on the 21st of August 1801. He studied at Leiden university, and graduated in 1823 both as doctor of literature and LL.D. From 1829 to 1833 he acted as secretary to King William I. of Holland, afterwards took a prominent part in Dutch home politics, and gradually became the leader of the so-called anti-revolutionary party, both in the Second Chamber, of which he was for many years a member, and outside. In Groen the doctrines of Guizot and Stahl found an eloquent exponent. They permeate his controversial and political writings and historical studies, of which his *Handbook of Dutch History* (in Dutch) and *Maurice et Barnveld* (in French, 1875, a criticism of Motley's *Life of Van Olden-Barnveldt*) are the principal. Groen was violently opposed to Thorbecke, whose principles he denounced as ungodly and revolutionary. Although he lived to see these principles triumph, he never ceased to oppose them until his death, which occurred at the Hague on the 19th of May 1876. He is best known as the editor of the *Archives et correspondance de la maison d'Orange* (12 vols., 1835-1845), a great work of patient erudition, which procured for him the title of the "Dutch Gachard." J. L. Motley acknowledges his indebtedness to Groen's *Archives* in the preface to his *Rise of the Dutch Republic*, at a time when the American historian had not yet made the acquaintance of King William's archivist, and also bore emphatic testimony to Groen's worth as a writer of history in the correspondence published after his death. At the first reception, in 1858, of Motley at the royal palace at the Hague, the king presented him with a copy of Groen's *Archives* as a token of appreciation and admiration of the work done by the "worthy vindicator of William I., prince of Orange." This copy, bearing the king's autograph inscription, afterwards came into the possession of Sir William Vernon Harcourt, Motley's son-in-law.

GROIN. (1) An obsolete word for the grunting of swine, from Lat. *grunnire*, and so applied to the snout of a pig; it is probably the origin of the word, more commonly spelled "groyne," for a small timber framework or wall of masonry used on sea coasts as a breakwater to prevent the encroachment of sand and shingle. (2) Of uncertain origin; from an older form *grynde* or *grinde*; the derivation from "grain," an obsolete word meaning "fork," cannot, according to the *New English Dictionary*, be accepted, in anatomy the folds or grooves formed between the lower part of the abdomen and the thighs, covering the inguinal glands, and so applied in architecture to the angle or "arris" formed by the intersection of two vaults crossing one another, occasionally called by workmen "groin point." If the vaults are both of the same radius and height, their intersections lie in a vertical plane, in other cases they form winding curves for which it is difficult to provide centering. In early medieval vaulting this was sometimes arranged by a slight alteration in the geometrical curve of the vault, but the problem was not satisfactorily solved until the introduction of the rib which henceforth ruled the vaulting surface of the web or cell (see *VAULT*). The name "Welsh groin" or "underpitch" is generally given to the vaulting surface or web where the main longitudinal vault is higher than the cross or transverse vaults; as the transverse rib (of much greater radius than that of the wall rib), projected diagonally in front of the latter, the filling-in or web has to be carried back from the transverse to the wall rib. The term "groin centering" is used where, in groining without ribs, the whole surface is supported by centering during the erection of the vaulting. In ribbed work the stone ribs only are supported by timber ribs during the progress of the work, any light stuff being used while filling in the spandrels. (See *VAULT*.)

GROLMANN, KARL WILHELM GEORG VON (1777-1843), Prussian soldier, was born in Berlin on the 30th of July 1777. He entered an infantry regiment when scarcely thirteen, became an ensign in 1795, second lieutenant 1797, first lieutenant 1804 and staff-captain in 1805. As a subaltern he had become one of

Scharnhorst's intimates, and he was distinguished for his energetic and fearless character before the war of 1806, in which he served throughout, from Jena to the peace of Tilsit, as a staff officer, and won the rank of major for distinguished service in action. After the peace, and the downfall of Prussia, he was one of the most active of Scharnhorst's assistants in the work of reorganization (1809), joined the *Tugendbund* and endeavoured to take part in Schill's abortive expedition, after which he entered the Austrian service as a major on the general staff. Thereafter he journeyed to Cadix to assist the Spaniards against Napoleon, and he led a corps of volunteers in the defence of that port against Marshal Victor in 1810. He was present at the battle of Albuera, at Saguntum, and at Valencia, becoming a prisoner of war at the surrender of the last-named place. Soon, however, he escaped to Switzerland, whence early in 1813 he returned to Prussia as a major on the general staff. He served successively under Colonel von Dolffs and General von Kleist, and as commissioner at the headquarters of the Russian general Barclay de Tolly. He took part with Kleist in the victory of Kulm, and recovered from a severe wound received at that action in time to be present at the battle of Leipzig. He played a conspicuous part in the campaign of 1814 in France, after which he was made a major-general. In this rank he was appointed quartermaster-general to Field Marshal Prince Blücher, and, after his chief and Gneisenau, Grolmann had the greatest share in directing the Prussian operations of 1815. In the decision, on the 18th of June 1815, to press forward to Wellington's assistance (see WATERLOO CAMPAIGN), Grolmann actively concurred, and as the troops approached the battle-field, he is said to have overcome the momentary hesitation of the commander-in-chief and the chief of staff by himself giving the order to advance. After the peace of 1815, Grolmann occupied important positions in the ministry of war and the general staff. His last public services were rendered in Poland as commander-in-chief, and practically as civil administrator of the province of Posen. He was promoted general of infantry in 1837 and died on the 1st of June 1843, at Posen. His two sons became generals in the Prussian army. The Prussian 18th infantry regiment bears his name.

General von Grolmann supervised and provided much of the material for von Damitz's *Gesch. des Feldzugs 1815* (Berlin, 1837-1838), and *Gesch. des Feldzugs 1814 in Frankreich* (Berlin, 1842-1843).

See v. Conrady, *Leben und Wirken des Generals Karl von Grolmann* (Berlin, 1894-1896).

GROMATICI (from *groma* or *gruma*, a surveyor's pole), or *Agromensores*, the name for land-surveyors amongst the Romans. The art of surveying was probably at first in the hands of the augurs, by whom it was exercised in all cases where the demarcation of a *templum* (any consecrated space) was necessary. Thus, the boundaries of Rome itself, of colonies and camps, were all marked out in accordance with the rules of augural procedure. The first professional surveyor mentioned is L. Decidius Saxa, who was employed by Antony in the measurement of camps (Cicero, *Philippics*, xi. 12, xiv. 10). During the empire their number and reputation increased. The distribution of land amongst the veterans, the increase in the number of military colonies, the settlement of Italian peasants in the provinces, the general survey of the empire under Augustus, the separation of private and state domains, led to the establishment of a recognized professional corporation of surveyors. During later times they were in receipt of large salaries, and in some cases were even honoured with the title *clarissimus*. Their duties were not merely geometrical or mathematical, but required legal knowledge for consultations or the settlement of disputes. This led to the institution of special schools for the training of surveyors and a special literature, which lasted from the 1st to the 6th century A.D. The earliest of the gromatic writers was Frontinus (q.v.), whose *De agrorum qualitate*, dealing with the legal aspect of the art, was the subject of a commentary by Aggenus Urbicus, a Christian schoolmaster. Under Trajan a certain Balbus, who had accompanied the emperor on his

Dacian campaign, wrote a still extant manual of geometry for land surveyors (*Expositio et ratio omnium formarum et mensurarum*, probably after a Greek original by Hero), dedicated to a certain Celsus who had invented an improvement in a gromatic instrument (perhaps the dioptra, resembling the modern theodolite); for the treatises of Hyginus see that name. Somewhat later than Trajan was Siculus Flaccus (*De conditionibus agrorum*, extant), while the most curious treatise on the subject, written in barbarous Latin and entitled *Casae litterarum* (long a school textbook) is the work of a certain Innocentius (4th-5th century). It is doubtful whether Boëtius is the author of the treatises attributed to him. The *Gromatici veteres* also contains extracts from official registers (probably belonging to the 5th century) of colonial and other land surveys, lists and descriptions of boundary stones, and extracts from the Theodosian Codex. According to Mommsen, the collection had its origin during the 5th century in the office of a *vicarius* (diocesan governor) of Rome, who had a number of surveyors under him. The surveyors were known by various names: *decempedator* (with reference to the instrument used); *suitor*, *metator* or *mensur castorum* in republican times; *logati Augustorum* as imperial civil officials; *professor*, *maior* as professional instructors.

The best edition of the *Gromatici* is by C. Lachmann and others (1848) with supplementary volume, *Die Schriften der römischen Feldmesser* (1852); see also B. G. Niebuhr, *Roman History*, ii., appendix (Eng. trans.), who first revived interest in the subject; M. Cantor, *Die römischen Agrimensoren* (Leipzig, 1875); P. de Tissot, *La Condition des Agrimensores dans l'ancienne Rome* (1879); G. Rossi, *Groma e squadra* (Turin, 1877); articles by F. Hultsch in Ersch and Gruber's *Allgem. Encyclopädie*, and by G. Humbert in Daremberg and Saglio's *Dictionnaire des antiquités*; Teuffel-Schwabe, *Hist. of Roman Literature*, 98.

GRONINGEN, the most northerly province of Holland, bounded S. by Drente, W. by Friesland and the Lauwers Zee, N. and N.E. by the North Sea and the mouth of the Ems with the Dollart, and on the S.E. by the Prussian province of Hanover. It includes the islands of Boschplaat and Rottumerog, belonging to the group of Frisian islands (q.v.). Area, 887 sq. m.; pop. (1900) 299,602. Groningen is connected with the Drente plateau by the sandy tongue of the Hondarug which extends almost up to the capital. West, north and north-east of this the province is flat and consists of sea-clay or sand and clay mixed, except where patches of low and high fen occur on the Frisian borders. Low fen predominates to the east of the capital, between the Zuidlardermeer and the Schildmeer or lakes. The south-eastern portion of the province consists of high fen resting on diluvial sand. A large part of this has been reclaimed and the sandy soil laid bare, but on the Drente and Prussian borders areas of fen still remain. The so-called Boertanger Morass on the Prussian border was long considered as the natural protection of the eastern frontier, and with the view of preserving its impassable condition neither agriculture nor cattle-rearing might be practised here until 1824, and it was only in 1868 that the building of houses was sanctioned and the work of reclamation begun. The gradual extension of the seaward boundaries of the province owing to the process of littoral deposits may be easily traced, a triple line of sea-dikes in places marking the successive stages in this advance. The rivers of Groningen descending from the Drente plateau meet at the capital, whence they are continued by the Reitdiep to the Lauwers Zee (being discharged through a lock), and by the Ems canal (1876) to Delfzyl. The south-eastern corner of the province is traversed by the Westerwolde Aa, which discharges into the Dollart. The railway system belongs to the northern section of the State railways, and affords communication with Germany via Winschoten. Steam-tramways also serve many parts of the province. Agriculture is the main industry. The proportion of landowners is a very large one, and the prosperous condition of the Groningen farmer is attested by the style of his home, his dress and his gig. As a result, however, partly of the usual want of work on the grasslands in certain seasons, there has been a considerable emigration to America. The ancient custom called the *deklem-recht*, or

lease-right, doubtless accounts for the extended ownership of the land. By this law a tenant-farmer is able to bequeath his farm, that is to say, he holds his lease in perpetuity.

The chief agricultural products are barley, oats, wheat, and in the north-east flax is also grown, and exported to South Holland and Belgium. On the higher clay grounds cattle-rearing and horse-breeding are also practised, together with butter and cheese making. The cultivation of potatoes on the sandgrounds in the south and the fen colonies along the Stads-Canal invite general comparison with the industries of Drente (*g.s.*). Hoogezand and Sappemeer, Veendam and Wildervank, New and Old Pekela, New and Old Stads-Canal are instances of villages which have extended until they overlap one another and are similar in this respect to the industrial villages of the Zaan Streek in North Holland. The coast fisheries are considerable. Groningen (*g.s.*) is the chief and only large town of the province. Delfsyl, which was formerly an important fortress for the protection of the ancient sluices on the little river Delf (hence its name), has greatly benefited by the construction of the Ems (Eems) ship-canal connecting it with Groningen, and has a good harbour with a considerable import trade in wood. Appingedam and Winschoten are very old towns, having important cattle and horse markets. The pretty wood at Winschoten was laid out by the Society for Public Welfare (*Tot Nut van het Algemeen*) in 1826.

GRONINGEN, a town of Holland, capital of the province of the same name, at the confluence of the two canalized rivers the Drentsche Aa and the Hunze (which are continued to the Lauwers Zee as the Reit Diep), 16 m. N. of Assen and 33 m. E. of Leeuwarden by rail. Pop. (1900) 67,563. Groningen is the centre from which several important canals radiate. Besides the Reit Diep, there are the Ems Canal and the Damster Diep, connecting it with Delfsyl and the Dollart, the Kolonel's Diep with Leeuwarden, the Nord Willem's Canal with Assen and the south and the Stads-Canal south-east with the Ems. Hence steamers ply in all directions, and there is a regular service to Emden and the island of Borkum via Delfsyl, and via the Lauwers Zee to the island of Schiermonnikoog. Groningen is the most important town in the north of Holland, with its fine shops and houses and wide clean streets, while brick houses of the 16th and 17th centuries help it to retain a certain old-world air. The ancient part of the town is still surrounded by the former moat, and in the centre lies a group of open places, of which the Grootte Markt is one of the largest market-squares in Holland. Pleasant gardens and promenades extend on the north side of the town, together with a botanical garden. The chief church is the Martini-kerk, with a high tower (432 ft.) dating from 1477, and an organ constructed by the famous scholar and musician Rudolph Agricola, who was born near Groningen in 1443. The Aa church dates from 1465, but was founded in 1253. The Roman Catholic Broederkerk (rebuilt at the end of the 19th century) contains some remarkable pictures of the Passion by L. Hendrick (1865). There is also a Jewish synagogue. The large town hall (in classical style), one of the finest public buildings, was built at the beginning of the 19th century and enlarged in 1873. The provincial government offices also occupy a fine building which received a splendid front in 1871. Other noteworthy buildings are the provincial museum of antiquities, containing interesting Germanic antiquities, as well as medieval and modern collections of porcelain, pictures, &c.; the courts of justice (transformed in the middle of the 18th century); the old Ommelandhuis, formerly devoted to the administration of the surrounding district, built in 1509 and restored in 1899; the weigh-house (1874); the civil and military prison; the arsenal; the military hospital; and the concert hall.

The university of Groningen, founded in 1614, received its present fine buildings in classical style in 1850. Among its auxiliary establishments are a good natural history museum, an observatory, a laboratory, and a library which contains a copy of Erasmus' New Testament with marginal annotations by Luther. Other educational institutions are the deaf and

dumb institution founded by Henri Daniel Guyot (d. 1828) in 1790, a gymnasium, and schools of navigation, art and music. There are learned societies for the study of law (1761) and natural science (1830); an academy of fine arts (1830); an archaeological society; and a central bureau for collecting information concerning the province.

As capital of the province, and on account of the advantages of its natural position, Groningen maintains a very considerable trade, chiefly in oil-seed, grain, wood, turf and cattle, with Great Britain, Germany, Scandinavia and Russia. The chief industries are flax-spinning, rope-making, sugar refining, book printing, wool combing and dyeing, and it also manufactures beer, tobacco and cigars, cotton and woollen stuffs, furniture, organs and pianos; besides which there are saw, oil and grain mills, machine works, and numerous goldsmiths and silversmiths.

History.—The town of Groningen belonged originally to the *pagus*, or *gouw*, of Triantha (Drente), the countship of which was bestowed by the emperor Henry II. on the bishop and chapter of Utrecht in 1024. In 1040 Henry III. gave the church of Utrecht the royal domain of Groningen, and in the deed of gift the "villa Cruonings" is mentioned. Upon this charter the bishops of Utrecht based their claim to the overlordship of the town, a claim which the citizens hotly disputed. At the time of the donation, indeed, the town can hardly be said to have existed, but the royal "villa" rapidly developed into a community which strove to assert the rights of a free imperial city. At first the bishops were too strong for the townsmen; the defences built in 1110 were pulled down by the bishop's order two years later; and during the 12th and 13th centuries the see of Utrecht, in spite of frequent revolts, succeeded in maintaining its authority. Down to the 15th century an episcopal prefect, or burgrave, had his seat in the city, his authority extending over the neighbouring districts known as the Gorecht. In 1143 Heribert of Bierum, bishop of Utrecht, converted the office into an hereditary fief in favour of his brother Liffert, on the extinction of whose male line it was partitioned between the families of Koevorden (or Coevorden) and van den Hove. Gradually, however, the burghers, aided by the neighbouring Frisians, succeeded in freeing themselves from the episcopal yoke. The city was again walled in 1255; before 1284 it had become a member of the Hanseatic league; and by the end of the 14th century it was practically a powerful independent republic, which exercised an effective control over the Frisian Ommelande between the Ems and the Lauwers Zee. At the close of the 14th century the heirs of the Koevorden and van den Hove families sold their rights, first to the town, and then to the bishop. A struggle followed, in which the city was temporarily worsted; but in 1440 Bishop Dirk II. finally sold to the city the rights of the see of Utrecht over the Gorecht.

The medieval constitution of Groningen, unlike that of Utrecht, was aristocratic. Merchant gild there was none; and the craft gilds were without direct influence on the city government, which held them in subjection. Membership of the governing council, which selected from its own body the four *rationales* or burgomasters, was confined to men of approved "wisdom," and wisdom was measured in terms of money. This *Raad* of wealthy burghers gradually monopolized all power. The bishop's bailiff (*schout*), with his nominated assessors (*scabini*), continued to exercise jurisdiction, but members of the *Raad* sat on the bench with him, and an appeal lay from his court to the *Raad* itself. The council was, in fact, supreme in the city, and not in the city only. In 1439 it decreed that no one might trade in all the district between the Ems and the Lauwers Zee except burghers, and those who had purchased the *burval* (right of residence in the city) and the freedom of the gilds. Maximilian I. assigned Groningen to Albert of Saxony, hereditary podestat of Friesland, but the citizens preferred to accept the protection of the bishop of Utrecht; and when Albert's son George attempted in 1505 to seize the town, they recognized the lordship of Edzart of East Frisia. On George's renewal of hostilities they transferred their allegiance to Duke Charles of Gelderland, in 1515. In 1536 the city passed into the

hands of Charles V., and in the great wars of the 16th century suffered all the miseries of siege and military occupation. From 1581 onwards, Groningen still held by the Spaniards, was constantly at war with the "Ommelanden" which had declared against the king of Spain. This feud continued, in spite of the capture of the city in 1594 by Maurice of Nassau, and of a decree of the States in 1597 which was intended to set them at rest. In 1672 the town was besieged by the bishop of Münster, but it was successfully defended, and in 1698 its fortifications were improved under Coehoorn's direction. The French Republicans planted their tree of liberty in the Great Market on the 14th of February 1795, and they continued in authority till the 16th of November 1814. The fortifications of the city were doomed to destruction by the law of the 18th of April 1874.

See C. Hegel, *Städte und Gilden* (Leipzig, 1891); Stokvis, *Manuel d'histoire*, iii. 496 (Leiden, 1890-1893); also a.v. in Chevalier, *Répertoire des sources hist. du moyen âge* (Topo-bibliographie).

GRONLUND, LAURENCE (1846-1890), American socialist, was born in Copenhagen, Denmark, on the 13th of July 1846. He graduated from the university of Copenhagen in 1865, began the study of law, removed to the United States in 1867, taught German in Milwaukee, was admitted to the bar in 1869, and practised in Chicago. He became a writer and lecturer on socialism and was closely connected with the work of the Socialist Labor party from 1874 to 1884, then devoted himself almost exclusively to lecturing until his appointment to a post in the bureau of labour statistics. He again returned to the lecture field, and was an editorial writer for the New York and Chicago *American* from 1898 until his death in New York City on the 15th of October 1899. His principal works are: *The Coming Revolution* (1880); *The Co-operative Commonwealth in its Outlines, An Exposition of Modern Socialism* (1884); *Ca Ira, or Danton in the French Revolution* (1888), a rehabilitation of Danton; *Our Destiny, The Influence of Socialism on Morals and Religion* (1890); and *The New Economy* (1898).

GRONOVIVS (the latinized form of Gronov), **JOHANN FRIEDRICH** (1611-1671), German classical scholar and critic, was born at Hamburg on the 8th of September 1611. Having studied at several universities, he travelled in England, France and Italy. In 1643 he was appointed professor of rhetoric and history at Deventer, and in 1658 to the Greek chair at Leiden, where he died on the 28th of December 1671. (See also FABRETTI, RAFAEL.) Besides editing, with notes, Statius, Plautus, Livy, Tacitus, Aulus Gellius and Seneca's tragedies, Gronovius was the author, amongst numerous other works, of *Commentarius de sestertius* (1643) and of an edition of Hugo Grotius' *De jure belli et pacis* (1666). His *Observationes* contain a number of brilliant emendations. His son, **JAKOB GRONOVIVS** (1643-1716), is chiefly known as the editor of the *Thesaurus antiquitatum Graecarum* (1697-1709, in 13 volumes).

See J. E. Sandys, *Hist. of Class. Schol.* ii. (1908); F. A. Eckstein in Erach and Gruber's *Allgemeine Encyclopädie*.

GROOM, in modern usage a male servant attached to the stables, whose duties are to attend to the cleaning, feeding, currying and care generally of horses. The earliest meaning of the word appears to be that of a boy, and in 16th and 17th century literature it frequently occurs, in pastorals, for a shepherd lover. Later it is used for any male attendant, and thus survives in the name for several officials in the royal household, such as the grooms-in-waiting, and the grooms of the great chamber. The groom-porter, whose office was abolished by George III., saw to the preparation of the sovereign's apartment, and, during the 16th and 17th centuries, provided cards and dice for playing, and was the authority to whom were submitted all questions of gaming within the court. The origin of the word is obscure. The O. Fr. *gromet*, shop boy, is taken by French etymologists to be derived from the English. From the application of this word to a wine-taster in a wine merchant's shop, is derived *gourmet*, an epicure. According to the *New English Dictionary*, though there are no instances of groom in other Teutonic languages, the word may be ultimately connected with the root of "to grow." In "bridegroom," a newly married man,

"grom" in the 16th century took the place of an older *gome*, a common old Teutonic word meaning "man," and connected with the Latin *homo*. The Old English word was *brýdgama*, later *brýdegoma*. The word survives in the German *Bräutigam*.

GROOT, GERHARD (1340-1384), otherwise Gerrit or Geert Groot, in Latin Gerardus Magnus, a preacher and founder of the society of Brothers of Common Life (q.v.), was born in 1340 at Deventer in the diocese of Utrecht, where his father held a good civic position. He went to the university of Paris when only fifteen. Here he studied scholastic philosophy and theology under a pupil of Occam's, from whom he imbibed the nominalist conception of philosophy; in addition he studied canon law, medicine, astronomy and even magic, and apparently some Hebrew. After a brilliant course he graduated in 1358, and possibly became master in 1363. He pursued his studies still further in Cologne, and perhaps in Prague. In 1366 he visited the papal court at Avignon. About this time he was appointed to a canonry in Utrecht and to another in Aix-la-Chapelle, and the life of the brilliant young scholar was rapidly becoming luxurious, secular and selfish, when a great spiritual change passed over him which resulted in a final renunciation of every worldly enjoyment. This conversion, which took place in 1374, appears to have been due partly to the effects of a dangerous illness and partly to the influence of Henry de Calcar, the learned and pious prior of the Carthusian monastery at Munnikhuizen near Arnhem, who had remonstrated with him on the vanity of his life. About 1376 Gerard retired to this monastery and there spent three years in meditation, prayer and study, without, however, becoming a Carthusian. In 1379, having received ordination as a deacon, he became missionary preacher throughout the diocese of Utrecht. The success which followed his labours not only in the town of Utrecht, but also in Zwolle, Deventer, Kampen, Amsterdam, Haarlem, Gouda, Leiden, Delft, Zutphen and elsewhere, was immense; according to Thomas à Kempis the people left their business and their meals to hear his sermons, so that the churches could not hold the crowds that flocked together wherever he came. The bishop of Utrecht supported him warmly, and got him to preach against concubinage in the presence of the clergy assembled in synod. The impartiality of his censures, which he directed not only against the prevailing sins of the laity, but also against heresy, simony, avarice, and impurity among the secular and regular clergy, provoked the hostility of the clergy, and accusations of heterodoxy were brought against him. It was in vain that Groot emitted a *Publica Protestatio*, in which he declared that Jesus Christ was the great subject of his discourses, that in all of them he believed himself to be in harmony with Catholic doctrine, and that he willingly subjected them to the candid judgment of the Roman Church. The bishop was induced to issue an edict which prohibited from preaching all who were not in priest's orders, and an appeal to Urban VI. was without effect. There is a difficulty as to the date of this prohibition; either it was only a few months before Groot's death, or else it must have been removed by the bishop, for Groot seems to have preached in public in the last year of his life. At some period (perhaps 1381, perhaps earlier) he paid a visit of some days' duration to the famous mystic Johann Ruysbroeck, prior of the Augustinian canons at Groenendael near Brussels; at this visit was formed Groot's attraction for the rule and life of the Augustinian canons which was destined to bear such notable fruit. At the close of his life he was asked by some of the clerics who attached themselves to him to form them into a religious order, and Groot resolved that they should be canons regular of St Augustine. No time was lost in the effort to carry out the project, but Groot died before a foundation could be made. In 1387, however, a site was secured at Windesheim, some 20 m. north of Deventer, and here was established the monastery that became the cradle of the Windesheim congregation of canons regular, embracing in course of time nearly one hundred houses, and leading the way in the series of reforms undertaken during the 15th century by all the religious orders in Germany. The initiation of this movement was the great achievement of Groot's

life; he lived to preside over the birth and first days of his other creation, the society of Brothers of Common Life. He died of the plague at Deventer in 1384, at the age of 44.

The chief authority for Groot's life is Thomas à Kempis, *Vita Gerardi Magni* (translated into English by J. P. Arthur, *The Founders of the New Devotion*, 1905); also the *Chronicon Windeshemense* of Johann Busch (ed. K. Grube, 1886). An account, based on these sources, will be found in S. Kettlewell, *Thomas à Kempis and his Brothers of Common Life* (1882), i. c. 5; and a shorter account in F. R. Cruise, *Thomas à Kempis*, 1887, pt. ii. An excellent sketch, with an account of Groot's writings, is given by L. Schulze in Herzog-Hauck, *Realencyclopædie* (ed. 3); he insists on the fact that Groot's theological and ecclesiastical ideas were those commonly current in his day, and that the attempts to make him "a reformer before the Reformation" are unhistorical. (E. C. B.)

GROOVE-TOOTHED SQUIRREL, a large and brilliantly coloured Bornean squirrel, *Rhithosciurus macrotis*, representing a genus by itself distinguished from all other members of the family *Sciuridae* by having numerous longitudinal grooves on the front surface of the incisor teeth; the molars being of a simpler type than in other members of the family. The tail is large and fox-like, and the ears are tufted and the flanks marked by black and white bands.

GROS, ANTOINE JEAN, BARON (1771-1835), French painter, was born at Paris in 1771. His father, who was a miniature painter, began to teach him to draw at the age of six, and showed himself from the first an exacting master. Towards the close of 1785 Gros, by his own choice, entered the studio of David, which he frequented assiduously, continuing at the same time to follow the classes of the Collège Mazarin. The death of his father, whose circumstances had been embarrassed by the Revolution, threw Gros, in 1791, upon his own resources. He now devoted himself wholly to his profession, and competed in 1792 for the *grand prix*, but unsuccessfully. About this time, however, on the recommendation of the École des Beaux Arts, he was employed on the execution of portraits of the members of the Convention, and when—disturbed by the development of the Revolution—Gros in 1793 left France for Italy, he supported himself at Genoa by the same means, producing a great quantity of miniatures and *faits*. He visited Florence, but returning to Genoa made the acquaintance of Josephine, and followed her to Milan, where he was well received by her husband. On November 15, 1796, Gros was present with the army near Arcola when Bonaparte planted the tricolor on the bridge. Gros seized on this incident, and showed by his treatment of it that he had found his vocation. Bonaparte at once gave him the post of "inspecteur aux revues," which enabled him to follow the army, and in 1797 nominated him on the commission charged to select the spoils which should enrich the Louvre. In 1799, having escaped from the besieged city of Genoa, Gros made his way to Paris, and in the beginning of 1801 took up his quarters in the Capucins. His "esquisse" (*Musée de Nantes*) of the "Battle of Nazareth" gained the prize offered in 1802 by the consuls, but was not carried out, owing it is said to the jealousy of Junot felt by Napoleon; but he indemnified Gros by commissioning him to paint his own visit to the pest-house of Jaffa. "Les Pestiférés de Jaffa" (Louvre) was followed by the "Battle of Aboukir" 1806 (Versailles), and the "Battle of Eylau," 1808 (Louvre). These three subjects—the popular leader facing the pestilence unmoved, challenging the splendid instant of victory, heart-sick with the bitter cost of a hard-won field—gave to Gros his chief title to fame. As long as the military element remained bound up with French national life, Gros received from it a fresh and energetic inspiration which carried him to the very heart of the events which he depicted; but as the army and its general separated from the people, Gros, called on to illustrate episodes representative only of the fulfilment of personal ambition, ceased to find the nourishment necessary to his genius, and the defect of his artistic position became evident. Trained in the sect of the Classicists, he was shackled by their rules, even when—by his naturalistic treatment of types, and appeal to picturesque effect in colour and tone—he seemed to run counter to them. In 1810 his "Madrid" and "Napoleon at the Pyramids" (Versailles) show that his star had deserted him. His "Francis I." and "Charles

V.," 1812 (Louvre), had considerable success; but the decoration of the dome of St Geneviève (begun in 1811 and completed in 1824) is the only work of Gros's later years which shows his early force and vigour, as well as his skill. The "Departure of Louis XVIII." (Versailles), the "Embarkation of Madame d'Angoulême" (Bordeaux), the plafond of the Egyptian room in the Louvre, and finally his "Hercules and Diomedes," exhibited in 1835, testify only that Gros's efforts—in accordance with the frequent counsels of his old master David—to stem the rising tide of Romanticism, served but to damage his once brilliant reputation. Exasperated by criticism and the consciousness of failure, Gros sought refuge in the grosser pleasures of life. On the 25th of June 1835 he was found drowned on the shores of the Seine near Sèvres. From a paper which he had placed in his hat it became known that "las de la vie, et trahi par les dernières facultés qui la lui rendaient supportable, il avait résolu de s'en défaire." The number of Gros's pupils was very great, and was considerably augmented when, in 1815, David quitted Paris and made over his own classes to him. Gros was decorated and named baron of the empire by Napoleon, after the Salon of 1808, at which he had exhibited the "Battle of Eylau." Under the Restoration he became a member of the Institute, professor at the École des Beaux Arts, and was named chevalier of the order of St Michel.

M. Delécluze gives a brief notice of his life in *Louis David et son temps*, and Julius Meyer's *Geschichte der modernen französischen Malerei* contains an excellent criticism on his works.

GROSART, ALEXANDER BALLOCH (1827-1899), Scottish divine and literary editor, the son of a building contractor, was born at Stirling on the 18th of June 1827. He was educated at Edinburgh University, and in 1856 became a Presbyterian minister at Kinross. In 1865 he went to Liverpool, and three years later to Blackburn. He resigned from the ministry in 1892, and died at Dublin on the 16th of March 1899. Dr Grosart is chiefly remembered for his exertions in reprinting much rare Elizabethan literature, a work which he undertook in the first instance from his strong interest in Puritan theology. Among the first writers whose works he edited were the Puritan divines, Richard Sibbes, Thomas Brooks and Herbert Palmer. Editions of Michael Bruce's *Poems* (1865) and Richard Gilpin's *Demonologia sacra* (1867) followed. In 1868 he brought out a bibliography of the writings of Richard Baxter, and from that year until 1876 he was occupied in reproducing for private subscribers the "Fuller Worthies Library," a series of thirty-nine volumes which included the works of Thomas Fuller, Sir John Davies, Fulke Greville, Henry Vaughan, Andrew Marvell, George Herbert, Richard Crashaw, John Donne and Sir Philip Sidney. The last four volumes of the series were devoted to the works of many little known and otherwise inaccessible authors. His *Occasional Issues of Unique and Very Rare Books* (1875-1881) is of the utmost interest to the book-lover. It included among other things the *Annalia Dubrensis* of Robert Dover. In 1876 still another series, known as the "Chertsey Worthies Library," was begun. It included editions of the works of Nicholas Breton, Francis Quarles, Dr Joseph Beaumont, Abraham Cowley, Henry More and John Davies of Hereford. Grosart was untiring in his enthusiasm and energy for this kind of work. The two last-named series were being produced simultaneously until 1881, and no sooner had they been completed than Grosart began the "Huth Library," so called from the bibliophile Henry Huth, who possessed the originals of many of the reprints. It included the works of Robert Greene, Thomas Nash, Gabriel Harvey, and the prose tracts of Thomas Dekker. He also edited the complete works of Edmund Spenser and Samuel Daniel. From the Townley Hall collection he reprinted several MSS. and edited Sir John Eliot's works, Sir Richard Boyle's *Lisimore Papers*, and various publications for the Chetham Society, the Camden Society and the Roxburghe Club. Dr Grosart's faults of style and occasional inaccuracy do not seriously detract from the immense value of his work. He was unwearied in searching for rare books, and he brought to light much interesting literature, formerly almost inaccessible.

GROSBEAK (Fr. *Grosbec*), a name very indefinitely applied to many birds belonging to the families *Fringillidae* and *Ploceidae* of modern ornithologists, and perhaps to some members of the *Emberisidae* and *Tanagraeidae*, but always to birds distinguished by the great size of their bill. Taken alone it is commonly a synonym of hawfinch (*q.v.*), but a prefix is usually added to indicate the species, as pine-grosbeak, cardinal-grosbeak and the like. By early writers the word was generally given as an equivalent of the Linnæan *Loxia*, but that genus has been found to include many forms not now placed in the same family.

The Pine-grosbeak (*Pinicola enucleator*) inhabits the conifer-zone of both the Old and the New Worlds, seeking, in Europe and probably elsewhere, a lower latitude as winter approaches—often journeying in large flocks; stragglers have occasionally reached the British Islands (Yarrell, *Br. Birds*, ed. 4, ii. 177-179). In structure and some of its habits much resembling a bullfinch, but much exceeding that bird in size, it has the plumage of a crossbill and appears to undergo the same changes as do the members of the restricted genus *Loxia*—the young being of a dull greenish-grey streaked with brownish-black, the adult hens tinged with golden-green, and the cocks glowing with crimson-red on nearly all the body-feathers, this last colour being replaced after moulting in confinement by bright yellow. Nests of this species were found in 1821 by Johanna Wilhelm Zetterstedt near Juckasjärwi in Swedish Lapland, but little was known concerning its nidification until 1855, when John Wolley, after two years' ineffectual search, succeeded in obtaining near the Finnish village Muonioniska, on the Swedish frontier, well-authenticated specimens with the eggs, both of which are like exaggerated bullfinches'. The food of this species seems to consist of the seeds and buds of many sorts of trees, though the staple may very possibly be those of some kind of pine.

Allied to the pine-grosbeak are a number of species of smaller size, but its equals in beauty of plumage.¹ They have been referred to several genera, such as *Carpodacus*, *Propasser*, *Bycanes*, *Uragus* and others; but possibly *Carpodacus* is sufficient to contain all. Most of them are natives of the Old World, and chiefly of its eastern division, but several inhabit the western portion of North America, and one, *C. githagineus* (of which there seem to be at least two local races), is an especial native of the deserts, or their borders, of Arabia and North Africa, extending even to some of the Canary Islands—a singular modification in the *habitat* of a form which one would be apt to associate exclusively with forest trees, and especially conifers.

The cardinal grosbeak, or Virginian nightingale, *Cardinalis virginianus*, claims notice here, though doubts may be entertained as to the family to which it really belongs. It is no less remarkable for its bright carmine attire, and an elongated crest of the same colour, than for its fine song. Its ready adaptation to confinement has made it a popular cage-bird on both sides of the Atlantic. The hen is not so good a songster as the cock bird. Her plumage, with exception of the wings and tail, which are of a dull red, is light-olive above and brownish-yellow beneath. This species inhabits the eastern parts of the United States southward of 40° N. lat., and also occurs in the Bermudas. It is represented in the south-west of North America by other forms that by some writers are deemed species, and in the northern parts of South America by the *C. phoeniceus*, which would really seem entitled to distinction. Another kindred bird placed from its short and broad bill in a different genus, and known as *Pyrhuloxia sinuata* or the Texan cardinal, is found on the southern borders of the United States and in Mexico; while among North American "grosbeaks" must also be named the birds belonging to the genera *Guiraca* and *Hedymeles*—the former especially exemplified by the beautiful blue *G. caerulea*, and the latter by the brilliant rose-breasted *H. indocianus*, which last extends its range into Canada.

¹ Many of them are described and illustrated in the *Monographie des Loxiens* of Prince C. L. Bonaparte and Professor Schlegel (1850), though it excludes many birds which an English writer would call "grosbeaks."

The species of the Old World which, though commonly called "grosbeaks," certainly belong to the family *Ploceidae*, are treated under WEAVER-BIRD. (A. N.)

GROSE, FRANCIS (c. 1730-1791), English antiquary, was born at Greenford in Middlesex, about the year 1730. His father was a wealthy Swiss jeweller, settled at Richmond, Surrey. Grose early showed an interest in heraldry and antiquities, and his father procured him a position in the Herald's College. In 1763, being then Richmond Herald, he sold his tabard, and shortly afterwards became adjutant and paymaster of the Hampshire militia, where, as he himself humorously observed, the only account books he kept were his right and left pockets, into the one of which he received, and from the other of which he paid. This carelessness exposed him to serious financial difficulties; and after a vain attempt to repair them by accepting a captaincy in the Surrey militia, the fortune left him by his father being squandered, he began to turn to account his excellent education and his powers as a draughtsman. In 1757 he had been elected fellow of the Society of Antiquaries. In 1773 he began to publish his *Antiquities of England and Wales*, a work which brought him money as well as fame. This, with its supplementary parts relating to the Channel Islands, was not completed till 1787. In 1789 he set out on an antiquarian tour through Scotland, and in the course of this journey met Burns, who composed in his honour the famous song beginning "Ken ye aught o' Captain Grose," and in that other poem, still more famous, "Hear, land o' cakes, and brither Scots," warned all Scotsmen of this "chief among them taking notes." In 1790 he began to publish the results of what Burns called "his peregrinations through Scotland;" but he had not finished the work when he bethought himself of going over to Ireland and doing for that country what he had already done for Great Britain. About a month after his arrival, while in Dublin, he died in an apoplectic fit at the dinner-table of a friend, on the 22d of June 1791.

Grose was a sort of antiquarian Falstaff—at least he possessed in a striking degree the knight's physical peculiarities; but he was a man of true honour and charity, a valuable friend, "overlooking little faults and seeking out greater virtues," and an inimitable boon companion. His humour, his varied knowledge and his good nature were all eminently calculated to make him a favourite in society. As Burns says of him—

"But wad ye see him in his glee,
For meikle glee and fun has he,
Then set him down, and twa or three
Gude fellows wi' him;
And *port, O port!* shine thou a wee,
And THEN ye'll see him!"

Grose's works include *The Antiquities of England and Wales* (6 vols., 1773-1787); *Advice to the Officers of the British Army* (1782), a satire in the manner of Swift's *Directions to Servants*; *A Guide to Health, Beauty, Riches and Honour* (1783), a collection of advertisements of the period, with characteristic satiric preface; *A Classical Dictionary of the Vulgar Tongue* (1785); *A Treatise on Ancient Armour and Weapons* (1785-1786); Darrell's *History of Dover* (1786); *Military Antiquities* (2 vols., 1786-1788); *A Pronominal Glossary* (1787); *Rules for Drawing Cartouches* (1788); *The Antiquities of Scotland* (2 vols., 1789-1791); *Antiquities of Ireland* (2 vols., 1791), edited and partly written by Ledwich. *The Grumbler*, sixteen humorous essays, appeared in 1791 after his death; and in 1793 *The Olio*, a collection of essays, jests and small pieces of poetry, highly characteristic of Grose, though certainly not all by him, was put together from his papers by his publisher, who was also his executor.

A capital full-length portrait of Grose by N. Dance is in the first volume of the *Antiquities of England and Wales*, and another is among Kay's *Portraits*. A verified sketch of him appeared in the *Gentleman's Magazine*, lxi. 660. See *Gentleman's Magazine*, lxi. 498, 582; Noble's *Hist. of the College of Arms*, p. 434; *Notes and Queries*, 1st ser., ix. 350; 3rd ser., i. 64, x. 280-281; 5th ser., xii. 148; 6th ser., ii. 47, 257, 291; Hone, *Every-day Book*, i. 655.

GROSS, properly thick, bulky, the meaning of the Late Lat. *grossus*. The Latin word has usually been taken as cognate with *crassus*, thick, but this is now doubted. It also appears not to be connected with the Ger. *gross*, a Teutonic word represented in English by "great." Apart from its direct meaning,

and such figurative senses as coarse, vulgar or flagrant, the chief uses are whole, entire, without deduction, as opposed to "net," or as applied to that which is sold in bulk as opposed to "retail" (cf. "grocer" and "engrossing"). As a unit of tale, "gross" equals 12 dozen, 144, sometimes known as "small gross," in contrast with "great gross," i. e. 12 gross, 144 dozen. As a technical expression in English common law, "in gross" is applied to an incorporeal hereditament attached to the person of an owner, in contradistinction to one which is appendant or appurtenant, that is, attached to the ownership of land (see COMMONS).

GROSSE, JULIUS WALDEMAR (1828-1902), German poet; the son of a military chaplain, was born at Erfurt on the 25th of April 1828. He received his early education at the gymnasium in Magdeburg, and on leaving school and showing disinclination for the ministry, entered an architect's office. But his mind was bent upon literature, and in 1849 he entered the university of Halle, where, although inscribed as a student of law, he devoted himself almost exclusively to letters. His first poetical essay was with the tragedy *Cola di Rienzi* (1851), followed in the same year by a comedy, *Eine Nachspiel-Schauspieler*, which was at once produced on the stage. The success of these first two pieces encouraged him to follow literature as a profession, and proceeding in 1852 to Munich, he joined the circle of young poets of whom Paul Heyse (*q. v.*) and Hermann Lingg (1820-1905) were the chief. For six years (1855-1861) he was dramatic critic of the *Neue Münchener Zeitung*, and was then for a while on the staff of the *Leipziger Illustrirte Zeitung*, but in 1862 he returned to Munich as editor of the *Bayrische Zeitung*, a post he retained until the paper ceased to exist in 1867. In 1869 Grosse was appointed secretary of the *Schiller-Stiftung*, and lived for the next few years alternately in Weimar, Dresden and Munich, until, in 1890, he took up his permanent residence in Weimar. He was made grand-ducal *Hofrath* and had the title of "professor." He died at Torbole on the Lago di Garda on the 9th of May 1902.

Grosse was a most prolific writer of novels, dramas and poems. As a lyric poet, especially in *Gedichte* (1857) and *Aus bewegten Tagen*, a volume of poems (1869), he showed himself more to advantage than in his novels, of which latter, however, *Unruh aus Mitleid* (2 vols., 1868); *Vox populi, vox dei* (1869); *Maria Mancini* (1871); *Neue Erzählungen* (1875); *Sophie Monnier* (1876), and *Ein Frauenlos* (1888) are remarkable for a certain elegance of style. His tragedies, *Die Ynglinger* (1858); *Tiberius* (1876), *Johann von Schwaben*; and the comedy *Die steinerne Brunn*, had considerable success on the stage.

Grosse's *Gesammelte dramatische Werke* appeared in 7 vols. in Leipzig (1879), while his *Erzählende Dichtungen* were published at Berlin (6 vols., 1871-1873). An edition of his selected works by A. Bartels is in preparation. See also his autobiography, *Literarische Ursachen und Wirkungen* (1896); R. Prutz, *Die Literatur der Gegenwart* (1899); J. Eché, *J. Grosse als epischer Dichter* (1872).

GROSSEHAIN, a town in the kingdom of Saxony, 20 m. N. from Dresden, on the main line of railway (via Elsterwerda) to Berlin and at the junction of lines to Priestewitz and Frankfort-on-Oder. Pop. (1905) 12,015. It has an Evangelical church, a modern and a commercial school, a library and an extensive public park. The industries are very important, and embrace manufactures of woollen and cotton stuffs, buckskin, leather, glass and machinery. Grossehain was originally a Sorb settlement. It was for a time occupied by the Bohemians, by whom it was strongly fortified. It afterwards came into the possession of the margraves of Meissen, from whom it was taken in 1372 by the margraves of Brandenburg. It suffered considerably in all the great German wars, and in 1744 was nearly destroyed by fire. On the 16th of May 1813, a battle took place here between the French and the Russians.

See G. W. Schuberth, *Chronik der Stadt Grossehain* (Grossehain, 1887-1892).

GROSSEFESTE, ROBERT (c. 1195-1253), English statesman, theologian and bishop of Lincoln, was born of humble parents at Stradbroke in Suffolk. He received his education at Oxford where he became proficient in law, medicine and the natural sciences. Giraldus Cambrensis, whose acquaintance he had

made, introduced him, before 1199, to William de Vere, bishop of Hereford. Grosseteste aspired to a post in the bishop's household, but being deprived by death of this patron betook himself to the study of theology. It is possible that he visited Paris for this purpose, but he finally settled in Oxford as a teacher. His first preferment of importance was the chancellorship of the university. He gained considerable distinction as a lecturer, and was the first rector of the school which the Franciscans established in Oxford about 1224. Grosseteste's learning is highly praised by Roger Bacon, who was a severe critic. According to Bacon, Grosseteste knew little Greek or Hebrew and paid slight attention to the works of Aristotle, but was pre-eminent among his contemporaries for his knowledge of the natural sciences. Between 1214 and 1231 Grosseteste held in succession the archdeaconries of Chester, Northampton and Leicester. In 1232, after a severe illness, he resigned all his benefices and preferments except one prebend which he held at Lincoln. His intention was to spend the rest of his life in contemplative piety. But he retained the office of chancellor, and in 1235 accepted the bishopric of Lincoln. He undertook without delay the reformation of morals and clerical discipline throughout his vast diocese. This scheme brought him into conflict with more than one privileged corporation, but in particular with his own chapter, who vigorously disputed his claim to exercise the right of visitation over their community. The dispute raged hotly from 1239 to 1245. It was conducted on both sides with unseemly violence, and those who most approved of Grosseteste's main purpose thought it needful to warn him against the mistake of over-zeal. But in 1245, by a personal visit to the papal court at Lyons, he secured a favourable verdict. In ecclesiastical politics the bishop belonged to the school of Becket. His zeal for reform led him to advance, on behalf of the courts-Christian, pretensions which it was impossible that the secular power should admit. He twice incurred a well-merited rebuke from Henry III upon this subject; although it was left for Edward I. to settle the question of principle in favour of the state. The devotion of Grosseteste to the hierarchical theories of his age is attested by his correspondence with his chapter and the king. Against the former he upheld the prerogative of the bishops; against the latter he asserted that it was impossible for a bishop to disregard the commands of the Holy See. Where the liberties of the national church came into conflict with the pretensions of Rome he stood by his own countrymen. Thus in 1238 he demanded that the king should release certain Oxford scholars who had assaulted the legate Otho. But at least up to the year 1247 he submitted patiently to papal encroachments, contenting himself with the protection (by a special papal privilege) of his own diocese from alien clerks. Of royal exactions he was more impatient; and after the retirement of Archbishop Saint Edmund (*q. v.*) constituted himself the spokesman of the clerical estate in the Great Council. In 1244 he sat on a committee which was empanelled to consider a demand for a subsidy. The committee rejected the demand, and Grosseteste foiled an attempt on the king's part to separate the clergy from the baronage. "It is written," the bishop said, "that united we stand and divided we fall."

It was, however, soon made clear that the king and pope were in alliance to crush the independence of the English clergy; and from 1250 onwards Grosseteste openly criticized the new financial expedients to which Innocent IV. had been driven by his desperate conflict with the Empire. In the course of a visit which he made to Innocent in this year, the bishop laid before the pope and cardinals a written memorial in which he ascribed all the evils of the Church to the malignant influence of the Curia. It produced no effect, although the cardinals felt that Grosseteste was too influential to be punished for his audacity. Much discouraged by his failure the bishop thought of resigning. In the end, however, he decided to continue the unequal struggle. In 1251 he protested against a papal mandate enjoining the English clergy to pay Henry III. one-tenth of their revenues for a crusade; and called attention to the fact that, under the system of provisions, a sum of 70,000 marks was annually drawn

from England by the alien nominees of Rome. In 1253, upon being commanded to provide in his own diocese for a papal nephew, he wrote a letter of expostulation and refusal, not to the pope himself but to the commissioner, Master Innocent, through whom he received the mandate. The text of the remonstrance, as given in the *Burton Annals* and in Matthew Paris, has possibly been altered by a forger who had less respect than Grosseteste for the papacy. The language is more violent than that which the bishop elsewhere employs. But the general argument, that the papacy may command obedience only so far as its commands are consonant with the teaching of Christ and the apostles, is only what should be expected from an ecclesiastical reformer of Grosseteste's time. There is much more reason for suspecting the letter addressed "to the nobles of England, the citizens of London, and the community of the whole realm," in which Grosseteste is represented as denouncing in unmeasured terms papal finance in all its branches. But even in this case allowance must be made for the difference between modern and mediæval standards of decorum.

Grosseteste numbered among his most intimate friends the Franciscan teacher, Adam Marsh (q.v.). Through Adam he came into close relations with Simon de Montfort. From the Franciscan's letters it appears that the earl had studied a political tract by Grosseteste on the difference between a monarchy and a tyranny; and that he embraced with enthusiasm the bishop's projects of ecclesiastical reform. Their alliance began as early as 1239, when Grosseteste exerted himself to bring about a reconciliation between the king and the earl. But there is no reason to suppose that the political ideas of Montfort had matured before the death of Grosseteste; nor did Grosseteste busy himself overmuch with secular politics, except in so far as they touched the interest of the Church. Grosseteste realized that the misrule of Henry III. and his unprincipled compact with the papacy largely accounted for the degeneracy of the English hierarchy and the laxity of ecclesiastical discipline. But he can hardly be termed a constitutionalist.

Grosseteste died on the 9th of October 1253. He must then have been between seventy and eighty years of age. He was already an elderly man, with a firmly established reputation, when he became a bishop. As an ecclesiastical statesman he showed the same fiery zeal and versatility of which he had given proof in his academical career; but the general tendency of modern writers has been to exaggerate his political and ecclesiastical services, and to neglect his performances as a scientist and scholar. The opinion of his own age, as expressed by Matthew Paris and Roger Bacon, was very different. His contemporaries, while admitting the excellence of his intentions as a statesman, lay stress upon his defects of temper and discretion. But they see in him the pioneer of a literary and scientific movement; not merely a great ecclesiastic who patronized learning in his leisure hours, but the first mathematician and physicist of his age. It is certainly true that he anticipated, in these fields of thought, some of the most striking ideas to which Roger Bacon subsequently gave a wider currency.

See the *Epistolæ Roberti Grosseteste* (Rolls Series, 1861) edited with a valuable introduction by H. R. Luard. Grosseteste's famous memorial to the pope is printed in the appendix to E. Brown's *Fasciculus rerum expetendarum et fugendarum* (1690). A tract *De phisicis, lineis, angulis et figuris* was printed at Nuremberg in 1503. A French poem, *Le Chastel d'amour*, sometimes attributed to him, has been printed by the Caxton Society. Two curious tracts, the "De moribus pueri ad mensam" (printed by Wynkyn de Worde) and the "Statuta familie Roberti Grosseteste" (printed by J. S. Brewer in *Monumenta Franciscana*, i. 582), may be from his pen; but the editor of the latter work ascribes it to Adam de Marsh. There is less doubt respecting the *Reules Seynt Roberti*, a tract giving advice for the management of the household of the countess of Lincoln. For Grosseteste's life and work see Roger Bacon's *Opus majus* (ed. J. H. Bridges, 1897, 2 vols.) and *Opera quorundam mediaevalium* (ed. J. S. Brewer, Rolls Series, 1899); M. Paris's *Chronica majora* (ed. H. R. Luard, Rolls Series, 1872-1883, 5 vols.); and the *Lives* by S. Pegge (1793) and F. S. Stevenson (1899). (H. W. C. D.)

GROSSETO, a town and episcopal see of Tuscany, capital of the province of Grosseto, 90 m. S.S.E. of Pisa by rail. Pop. (1901) 5856 (town), 8843 (commune). It is 38 ft. above sea-level,

and is almost circular in shape, it is surrounded by fortifications, constructed by Francis I. (1574-1587) and Ferdinand I. (1587-1609), which form a hexagonal enceinte with projecting bastions, with two gates only. The small cathedral, begun in 1204, is built of red and white marble alternating, in the Italian Gothic style, it was restored in 1855. The citadel was built in 1311 by the Siennese. Grosseto is on the main line from Pisa to Rome, and is also the starting-point (Montepescali, 8 m. to the N., is the exact point of divergence) of a branch line to Asciano and Siena.

The town dates from the middle ages. In 1138 the episcopal see was transferred thither from Rusellæ. In 1230 it, with the rest of the Maremma, of which it is the capital, came under the dominion of Siena. By the peace of 1559, however, it passed to Cosimo I. of Tuscany. In 1745 the malaria had grown to such an extent, owing to the neglect of the drainage works, that Grosseto had only 648 inhabitants, though in 1224 it had 3000 men who bore arms. Leopold I. renewed drainage operations, and by 1836 the population had risen to 2392. The malaria is not yet entirely conquered, however, and the official headquarters of the province are in summer transferred to Scansano (1837 ft.), 20 m. to the S.E. by road.

GROSSI, GIOVANNI FRANCESCO (?-1699), one of the greatest Italian singers of the age of *bel canto*, better known as Siface, was born at Pescia in Tuscany about the middle of the 17th century. He entered the papal chapel in 1675, and later sang at Venice. He derived his nickname of Siface from his impersonation of that character in an opera of Cavalli. It has generally been said that he appeared as Siface in Alessandro Scariatti's *Mitridate*, but the confusion is due to his having sung the part of Mitridate in Scariatti's *Pompeo* at Naples in 1683. In 1687 he was sent to London by the duke of Modena, to become a member of the chapel of James II. He probably did much for the introduction of Italian music into England, but soon left the country on account of the climate. Among Purcell's harpsichord music is an air entitled "Sefauch's Farewell." He was murdered in 1699 on the road between Bologna and Ferrara, probably by the agents of a nobleman with whose wife he had a liaison.

See Corrado Ricci's *Vita Barocca* (Milan, 1904).

GROSSI, TOMMASO (1791-1853), Lombard poet and novelist, was born at Bellano, on the Lake of Como, on the 20th of January 1791. He took his degree in law at Pavia in 1810, and proceeded thence to Milan to exercise his profession; but the Austrian government, suspecting his loyalty, interfered with his prospects, and in consequence Grossi was a simple notary all his life. That the suspicion was well grounded he soon showed by writing in the Milanese dialect the battle poem *La Prineide*, in which he described with vivid colours the tragical death of Prina, chief treasurer during the empire, whom the people of Milan, instigated by Austrian agitators, had torn to pieces and dragged through the streets of the town (1814). The poem, being anonymous, was first attributed to the celebrated Porta, but Grossi of his own accord acknowledged himself the author. In 1816 he published other two poems, written likewise in Milanese—*The Golden Rain* (*La Pioggia d'oro*) and *The Fugitive* (*La Fuggitiva*). These compositions secured him the friendship of Porta and Manzoni, and the three poets came to form a sort of romantic literary triumvirate. Grossi took advantage of the popularity of his Milanese poems to try Italian verse, into which he sought to introduce the moving realism which had given such satisfaction in his earliest compositions; and in this he was entirely successful with his poem *Ildogonda* (1814). He next wrote an epic poem, entitled *The Lombards in the First Crusade*, a work of which Manzoni makes honourable mention in *I Promessi Sposi*. This composition, which was published by subscription (1826), attained a success unequalled by that of any other Italian poem within the century. The example of Manzoni induced Grossi to write an historical novel entitled *Marco Visconti* (1834)—a work which contains passages of fine description and deep pathos. A little later Grossi published a tale in verse, *Ulrico and Lida*, but with this publication his poetical activity ceased.

After his marriage in 1838 he continued to employ himself as a notary in Milan till his death on the 10th of December 1853.

His *Life by Cantu* appeared at Milan in 1854.

GROSSMITH, GEORGE (1847-), English comedian, was born on the 9th of December 1847, the son of a law reporter and entertainer of the same name. After some years of journalistic work he started about 1870 as a public entertainer, with songs and recitations; but in 1877 he began a long connexion with the Gilbert and Sullivan operas at the Savoy Theatre, London, in *The Sorcerer*. For twelve years he had the leading part, his capacity for "patter-songs," and his humorous acting, dancing and singing marking his creations of the chief characters in the Gilbert and Sullivan operas as the expression of a highly original individuality. In 1889 he left the Savoy, and again set up as an entertainer, visiting all the cities of Great Britain and the United States, but retiring in 1901. Among other books he wrote *The Reminiscences of a Society Clown* (1888); and, with his brother Weedon, *The Diary of a Nobody* (1894). His humorous songs and sketches numbered over six hundred. His younger brother, Weedon Grossmith, who was educated as a painter and exhibited at the Academy, also took to the stage, his first notable success being in the *Pantomime Rehearsal*; in 1894 he went into management on his own account, and had much success as a comedian. George Grossmith's two sons, Laurence Grossmith and George Grossmith, jun., were both actors, the latter becoming a well-known figure in the musical comedies at the Gaiety Theatre, London.

GRÖS VENTRES (Fr. for "Great Bellies"), or **ATSINA**, a tribe of North American Indians of Algonquian stock. The name is said to have reference to the greediness of the people, but more probably originated from their prominent tattooing. They are settled at Fort Belknap agency, Montana. The name has also been given to other tribes, e.g. the Hidatsa or Minitari, now at Fort Berthold, North Dakota.

GROTE, GEORGE (1794-1871), English historian of Greece, was born on the 17th of November 1794, at Clay Hill near Beckenham in Kent. His grandfather, Andreas, originally a Bremen merchant, was one of the founders (1st of January 1766) of the banking-house of Grote, Prescott & Company in Threadneedle Street, London (the name of Grote did not disappear from the firm till 1879). His father, also George, married (1793) Selina, daughter of Henry Peckwell (1747-1787), minister of the countess of Huntingdon's chapel in Westminster (descended from a Huguenot family, the de Blossets, who had left Touraine on the revocation of the Edict of Nantes), and had one daughter and ten sons, of whom the historian was the eldest. Educated at first by his mother, George Grote was sent to the Sevenoaks grammar school (1800-1804) and afterwards to Charterhouse (1804-1810), where he studied under Dr Raine in company with Connop Thirlwall, George and Horace Waddington and Henry Havelock. In spite of Grote's school successes, his father refused to send him to the university and put him in the bank in 1810. He spent all his spare time in the study of classics, history, metaphysics and political economy, and in learning German, French and Italian. Driven by his mother's Puritanism and his father's contempt for academic learning to outside society, he became intimate with Charles Hay Cameron, who strengthened him in his love of philosophy, and George W. Norman, through whom he met his wife, Miss Harriet Lewin (see below). After various difficulties the marriage took place on the 5th of March 1820, and was in all respects a happy union.

In the meanwhile Grote had finally decided his philosophic and political attitude. In 1817 he came under the influence of David Ricardo, and through him of James Mill and Jeremy Bentham. He settled in 1820 in a house attached to the bank in Threadneedle Street, where his only child died a week after its birth. During Mrs Grote's slow convalescence at Hampstead, he wrote his first published work, the *Statement of the Question of Parliamentary Reform* (1821), in reply to Sir James Mackintosh's article in the *Edinburgh Review*, advocating popular representation, vote by ballot and short parliaments. In 1822 he published in the *Morning Chronicle* (April) a letter

against Canning's attack on Lord John Russell, and edited, or rather re-wrote, some discursive papers of Bentham, which he published under the title *Analysis of the Influence of Natural Religion on the Temporal Happiness of Mankind* by Philip Beauchamp (1822). The book was published in the name of Richard Carlile, then in gaol at Dorchester. Though not a member of J. S. Mill's Utilitarian Society (1822-1823), he took a great interest in a society for reading and discussion, which met (from 1823) in a room at the bank before business hours twice a week. From the *Posthumous Papers* (pp. 22, 24) it is clear that Mrs Grote was wrong in asserting that she first in 1823 (autumn) suggested the *History of Greece*; the book was already in preparation in 1822, though what was then written was subsequently reconstructed. In 1826 Grote published in the *Westminster Review* (April) a criticism of Mitford's *History of Greece*, which shows that his ideas were already in order. From 1826 to 1830 he was hard at work with J. S. Mill and Henry Brougham in the organization of the new "university" in Gower Street. He was a member of the council which organized the faculties and the curriculum; but in 1830, owing to a difference with Mill as to an appointment to one of the philosophical chairs, he resigned his position.

In 1830 he went abroad, and, attracted by the political crisis, spent some months in Paris in the society of the Liberal leaders. Recalled by his father's death (6th of July), he not only became manager of the bank, but took a leading position among the city Radicals. In 1831 he published his important *Essentials of Parliamentary Reform* (an elaboration of his previous *Statement*), and, after refusing to stand as parliamentary candidate for the city in 1831, changed his mind and was elected head of the poll, with three other Liberals, in December 1832. After serving in three parliaments, he resigned in 1841, by which time his party ("the philosophic Radicals") had dwindled away. During these years of active public life, his interest in Greek history and philosophy had increased, and after a trip to Italy in 1842, he severed his connexion with the bank and devoted himself to literature. In 1846 the first two volumes of the *History* appeared, and the remaining ten between 1847 and the spring of 1856. In 1845 with Molesworth and Raikes Currie he gave monetary assistance to Auguste Comte (q.v.), then in financial difficulties. The formation of the Sonderbund (20th of July 1847) led him to visit Switzerland and study for himself a condition of things in some sense analogous to that of the ancient Greek states. This visit resulted in the publication in the *Spectator* of seven weekly letters, collected in book form at the end of 1847 (see a letter to de Tocqueville in Mrs Grote's reprint of the *Seven Letters*, 1876).

In 1856 Grote began to prepare his works on Plato and Aristotle. *Plato and the Other Companions of Sokrates* (3 vols.) appeared in 1865, but the work on Aristotle he was not destined to complete. He had finished the *Organon* and was about to deal with the metaphysical and physical treatises when he died on the 18th of June 1871, and was buried in Westminster Abbey. He was a man of strong character and self-control, unflinching courtesy and unswerving devotion to what he considered the best interests of the nation. To colleagues and subordinates alike, he was considerate and tolerant; he was unassuming, trustworthy in the smallest detail, accurate and comprehensive in thought, energetic and conscientious in action. Yet, hidden under his calm exterior there was a burning enthusiasm and a depth of passion of which only his intimate friends were aware.

His work may best be considered under the following heads:

1. *Grote's Services to Education*.—He took, as already stated, an important part in the foundation and organization of the original university of London, which began its public work in Gower Street on the 28th of October 1828, and in 1836, on the incorporation of the university of London proper, became known as University College. In 1849 he was re-elected to the council, in 1860 he became treasurer, and on the death of Brougham (1868) president. He took a keen interest in all the work of the college, presented to it the *Marmor Homericum*, and finally bequeathed the reversion of £6000 for the endowment of a chair

of philosophy of mind and logic. The emoluments of this sum were, however, to be held over and added to the principal if at any time the holder of the chair should be "a minister of the Church of England or of any other religious persuasion." In 1850 the senate of the university was reconstituted, and Grote was one of seven eminent men who were added to it. Eventually he became the strongest advocate for open examinations, for the claims not only of philosophy and classics but also of natural science, and, as vice-chancellor in 1862, for the admission of women to examinations. This latter reform was carried in 1868. He succeeded his friend Henry Hallam as a trustee of the British Museum in 1859, and took part in the reorganization of the departments of antiquities and natural science.

The honours which he received in recognition of these services were as follows: D.C.L. of Oxford (1853); LL.D. Cambridge (1861); F.R.S. (1857); honorary professor of ancient history in the Royal Academy (1859). By the French Academy of Moral and Political Sciences he was made correspondent (1857) and foreign associate (the first Englishman since Macaulay) (1864). In 1869 he refused Gladstone's offer of a peerage.

a. *Political Career*.—In politics Grote belonged to the "philosophic Radicals" of the school of J. S. Mill and Bentham, whose chief principles were representative government, vote by ballot, the abolition of a state church, frequent elections. He adhered to these principles throughout, and refused to countenance any reforms which were incompatible with them. By this uncompromising attitude, he gradually lost all his supporters save a few men of like rigidity. As a speaker, he was clear, logical and impressive, and on select committees his common sense was most valuable. For his speeches see A. Bain in the *Minor Works*; see also BALLOT.

3. *The History of Greece*.—It is on this work that Grote's reputation mainly rests. Though half a century has passed since its production, it is still in some sense the text-book. It consists of two parts, the "Legendary" and the "Historical" Greece. The former, owing to the development of comparative mythology, is now of little authority, and portions of part ii. are obsolete owing partly to the immense accumulations of epigraphic and archaeological research, partly to the subsequent discovery of the Aristotelian *Constitution of Athens*, and partly also to the more careful weighing of evidence which Grote himself misinterpreted. The interest of the work is twofold. In the first place it contains a wonderful mass of information carefully collected from all sources, arranged on a simple plan, and expressed in direct forcible language. It is in this respect one of the few great comprehensive histories in our possession, great in scope, conception and accomplishment. But more than this it is interesting as among the first works in which Greek history became a separate study, based on real evidence and governed by the criteria of modern historical science. Further Grote, a practical man, a rationalist and an enthusiast for democracy, was the first to consider Greek political development with a sympathetic interest (see GREECE: *History, Ancient*, section "Authorities"), in opposition to the Tory attitude of John Gillies and Mitford, who had written under the influence of horror at the French Revolution. On the whole his work was done with impartiality, and more recent study has only confirmed his general conclusions. Much has been made of his defective accounts of the tyrants and the Macedonian empire, and his opinion that Greek history ceased to be interesting or instructive after Chaeronea. It is true that he confined his interest to the fortunes of the city state and neglected the wider diffusion of the Greek culture, but this is after all merely a criticism of the title of the book. The value of the *History* consists to-day primarily in its examination of the Athenian democracy, its growth and decline, an examination which is still the most inspiring, and in general the most instructive, in any language. In the description of battles and military operations generally Grote was handicapped by the lack of personal knowledge of the country. In this respect he is inferior to men like Ernst Curtius and G. B. Grundy.

4. In *Philosophy* Grote was a follower of the Mills and Bentham. J. S. Mill paid a tribute to him in the preface to the

third edition of his *Examination of Sir Wm. Hamilton's Philosophy*, and there is no doubt that the empirical school owed a great deal to his sound, accurate thinking, untrammelled by any reverence for authority, technique and convention. In dealing with Plato he was handicapped by this very common sense, which prevented him from appreciating the theory of ideas in its widest relations. His *Plato* is important in that it emphasizes the generally neglected passages of Plato in which he seems to indulge in mere Socratic dialectic rather than to seek knowledge; it is, therefore, to be read as a corrective to the ordinary criticism of Plato. The more congenial study of Aristotle, though incomplete, is more valuable in the positive sense, and has not received the attention it deserves. Perhaps Grote's most distinctive contribution to the study of Greek philosophy is his chapter in the *History of Greece* on the Sophists, of whom he took a view somewhat more favourable than has been accepted before or since.

His wife, HARRIET LEWIN (1792-1878), was the daughter of Thomas Lewin, a retired Indian civilian, settled in Southampton. After her marriage with Grote in 1820 she devoted herself to the subjects in which he was interested and was a prominent figure in the literary, political and philosophical circle in which he lived. She carefully read the proofs of his work and relieved him of anxiety in connexion with his property. Among her writings are: *Memoir of Ary Scheffer* (1860); *Collected Papers* (1862); and her biography of her husband (1873). Another publication, *The Philosophical Radicals of 1832* (privately circulated in 1866), is interesting for the light it throws on the Reform movement of 1832 to 1842, especially on Molesworth.

BIBLIOGRAPHY.—The *History of Greece* passed through five editions the fifth (10 vols., 1888) being final. An edition covering the period from Solon to 403, with new notes and excursions, was published by J. M. Mitchell and M. O. B. Caspari in 1907. The *Plato* was finally edited by Alexander Bain in 4 vols. See Mrs Grote's *Personal Life of George Grote*, and article in *Dict. Nat. Biog.* by G. Croon Robertson. (J. M. M.)

GROTEFEND, GEORG FRIEDRICH (1775-1853), German epigraphist, was born at Münden in Hanover on the 9th of June 1775. He was educated partly in his native town, partly at Ilfeld, where he remained till 1795, when he entered the university of Göttingen, and there became the friend of Heyne, Tychoen and Heeren. Heyne's recommendation procured for him an assistant mastership in the Göttingen gymnasium in 1797. While there he published his work *De p̄sigraphia sine scriptura universali* (1799), which led to his appointment in 1803 as prorektor of the gymnasium of Frankfurt-on-Main, and shortly afterwards as conrektor. Grotefend was best known during his lifetime as a Latin and Italian philologist, though the attention he paid to his own language is shown by his *Anfangsgründe der deutschen Poesie*, published in 1815, and his foundation of a society for investigating the German tongue in 1817. In 1821 he became director of the gymnasium at Hanover, a post which he retained till his retirement in 1849. In 1823-1824 appeared his revised edition of Wenck's Latin grammar, in two volumes, followed by a smaller grammar for the use of schools in 1826; in 1835-1838 a systematic attempt to explain the fragmentary remains of the Umbrian dialect, entitled *Rudimenta linguae Umbricae ex inscriptionibus antiquis enodato* (in eight parts); and in 1830 a work of similar character upon Oscan (*Rudimenta linguae Oscanae*). In the same year he published an important memoir on the coins of Bactria, under the name of *Die Münzen der griechischen, parthischen, und indoskythischen Könige von Bactrien und den Ländern am Indus*. He soon, however, returned to his favourite subject, and brought out a work in five parts, *Zur Geographie und Geschichte von Aithalien* (1840-1842). Previously, in 1836, he had written a preface to Wagenfeld's translation of the spurious *Sanchoniathon* of Philo Byblius, which was alleged to have been discovered in the preceding year in the Portuguese convent of Santa Maria de Merinhao. But it was in the East rather than in the West that Grotefend did his greatest work. The cuneiform inscriptions of Persia had for some time been attracting attention in Europe; exact copies of them had been published by the elder Niebuhr, who lost his eyesight over the work; and Grotefend's friend, Tychoen of Rostock, believed

that he had ascertained the characters in the column, now known to be Persian, to be alphabetic. At this point Grotefend took the matter up. His first discovery was communicated to the Royal Society of Göttingen in 1800, and reviewed by Tychoen two years afterwards. In 1815 he gave an account of it in Heeren's great work on ancient history, and in 1837 published his *Neue Beiträge zur Erläuterung der persopolitanischen Keilschrift*. Three years later appeared his *Neue Beiträge zur Erläuterung der babylonischen Keilschrift*. His discovery may be summed up as follows: (1) that the Persian inscriptions contain three different forms of cuneiform writing, so that the decipherment of the one would give the key to the decipherment of the others; (2) that the characters of the Persian column are alphabetic and not syllabic; (3) that they must be read from left to right; (4) that the alphabet consists of forty letters, including signs for long and short vowels; and (5) that the Persepolitan inscriptions are written in Zend (which, however, is not the case), and must be ascribed to the age of the Achaemenian princes. The process whereby Grotefend arrived at these conclusions is a prominent illustration of persevering genius (see CUNEIFORM). A solid basis had thus been laid for the interpretation of the Persian inscriptions, and all that remained was to work out the results of Grotefend's brilliant discovery, a task ably performed by Burnouf, Lassen and Rawlinson. Grotefend died on the 15th of December 1853.

GROTESQUE, strictly a form of decorative art, in painting or sculpture, consisting of fantastic shapes of human beings, animals and the like, joined together by wreaths of flowers, garlands or arabesques. The word is also applied to any whimsical design or decorative style, if characterized by unnatural distortion, and, generally, to anything ludicrous or extravagantly fanciful. "Grotesque" comes through the French from the Ital. *grottesco*, an adjective formed from *grotta*, which has been corrupted in English to "grotto." The commonly accepted explanation of the special use of the term "grotesque" is that this particular form of decorative art was most frequently found in the excavated ancient Roman and Greek dwellings found in Italy, to which was applied the name *grotta*. The derivation of *grotta* is through popular Lat. *crypta* or *grypta* (cf. "crypt"), from Gr. *κρυπτή*, a vault, *κρυπτός*, to hide. Such a term would be applicable both to the buried dwellings of ancient Italy, and to a cavern, artificial or natural, the ordinary sense of the word. An interesting parallel with this origin of the word is found in that of "antic," now meaning a freak, a jest, absurd fancy, &c. This word is the same as "antique," and was, like "grotesque," first applied to the fanciful decorations of ancient art.

GROTH, KLAUS (1819-1899), Low German poet, was born at Heide in Schleswig-Holstein, on the 24th of April 1819. After studying at the seminary in Tondern (1838-1841), he became a teacher at the girls' school in his native village, but in 1847 went to Kiel to qualify for a higher educational post. Ill-health interrupted his studies and it was not until 1853 that he was able to resume them at Kiel. In 1856 he took the degree of doctor of philosophy at Bonn, and in 1858 settled as *privatdocent* in German literature and languages at Kiel, where, in 1866, he was made professor, and where he lived until his death on the 1st of June 1899. In his Low German (*Plattdeutsch*) lyric and epic poems, which reflect the influence of Johann Peter Hebel (q.v.), Groth gives poetic expression to the country life of his northern home; and though his descriptions may not always reflect the peculiar characteristics of the peasantry of Holstein as faithfully as those of F. Reuter (q.v.), yet Groth is a lyric poet of genuine inspiration. His chief works are *Quickborn, Volksleben in plattdeutschen Gedichten Dänischer Mundart* (1852; 25th ed. 1900; and in High German translations, notably by M. J. Berchem, Krefeld, 1896); and two volumes of stories, *Vertellen* (1855-1859, 3rd ed. 1881); also *Voer de Goern* (1858) and *Umin Jungparadies* (1875).

Groth's Gesammelte Werke appeared in 4 vols. (1893). His *Lebenserinnerungen* were edited by E. Wolff in 1891; see also K. Eggers, *K. Groth und die plattdeutsche Dichtung* (1885); and biographies by A. Bartels (1899) and H. Siercks (1899).

GROTH, PAUL HEINRICH VON (1843-), German mineralogist, was born at Magdeburg on the 23rd of June 1843. He was educated at Freiberg, Dresden and Berlin, and took the degree of Ph.D. in 1868. After holding from 1872 the chair of mineralogy at Strasburg, he was in 1883 appointed professor of mineralogy and curator of minerals in the state museum at Munich. He carried on extensive researches on crystals and minerals, and also on rocks; and published *Tabellarische Übersicht der einfachen Mineralien* (1874-1898), and *Physikalische Krystallographie* (1876-1895, ed. 4, 1905). He edited for some years the *Zeitschrift für Krystallographie und Mineralogie*.

GROTIUS, HUGO (1583-1645), in his native country Huig van Groot, but known to the rest of Europe by the latinized form of the name, Dutch publicist and statesman, was born at Delft on Easter day, the 10th of April 1583. The Groots were a branch of a family of distinction, which had been noble in France, but had removed to the Low Countries more than a century before. Their French name was de Cornets, and this cadet branch had taken the name of Groot on the marriage of Hugo's great-grandfather with a Dutch heiress. The father of Hugo was a lawyer in considerable practice, who had four times served the office of burgomaster of Leiden, and was one of the three curators of the university of that place.

In the annals of precocious genius there is no greater prodigy on record than Hugo Grotius, who was able to make good Latin verses at nine, was ripe for the university at twelve, and at fifteen edited the encyclopaedic work of Martianus Capella. At Leiden he was much noticed by J. J. Scaliger, whose habit it was to engage his young friends in the editing of some classical text. At fifteen Grotius accompanied Count Justin of Nassau, and the grand pensionary J. van Olden Barneveldt on their special embassy to the court of France. After a year spent in acquiring the language and making acquaintance with the leading men of France, Grotius returned home. He took the degree of doctor of law at Leiden, and entered on practice as an advocate.

Notwithstanding his successes in his profession, his inclination was to literature. In 1600 he edited the remains of Aratus, with the versions of Cicero, Germanicus and Avienus. Of the *Germanicus* Scaliger says—"A better text than that which Grotius has given, it is impossible to give"; but it is probable that Scaliger had himself been the reviser. Grotius vied with the Latinists of his day in the composition of Latin verses. Some lines on the siege of Ostend spread his fame beyond the circle of the learned. He wrote three dramas in Latin:—*Christus patiens*; *Sophomphaneas*, on the story of Joseph and his brethren; and *Adamus exul*, a production still remembered as having given hints to Milton. The *Sophomphaneas* was translated into Dutch by Vondel, and into English by Francis Goldsmith (1652); the *Christus patiens* into English by George Sandys (1640).

In 1603 the United Provinces, desiring to transmit to posterity some account of their struggle with Spain, determined to appoint a historiographer. The choice of the states fell upon Grotius, though he was but twenty years of age, and had not offered himself for the post. There was some talk at this time in Paris of calling Grotius to be librarian of the royal library. But it was a ruse of the Jesuit party, who wished to persuade the public that the opposition to the appointment of Isaac Casaubon did not proceed from theological motives, since they were ready to appoint a Protestant in the person of Grotius.

His next preferment was that of advocate-general of the fisc for the provinces of Holland and Zeeland. This was followed by his marriage, in 1608, to Marie Reigersberg, a lady of family in Zeeland, and a woman of great capacity and noble disposition.

Grotius had already passed from occupation with the classics to studies more immediately connected with his profession. In the winter of 1604 he composed (but did not publish) a treatise entitled *De jure praedae*. The MS. remained unknown till 1868, when it was brought to light, and printed at the Hague under the auspices of Professor Fruin. It shows that the principles and the plan of the celebrated *De jure belli*, which was not composed

till 1625, more than twenty years after, had already been conceived by a youth of twenty-one. It has always been a question what it was that determined Grotius, when an exile in Paris in 1625, to that particular subject, and various explanations have been offered; among others a casual suggestion of Peiresc in a letter of early date. The discovery of the MS. of the *De jure praedae* discloses the whole history of Grotius's ideas, and shows that from youth upwards he had steadily read and meditated in one direction, that, namely, of which the famous *De jure belli* was the mature product. In the *De jure praedae* of 1604 there is much more than the germ of the later treatise *De jure belli*. Its main principles, and the whole system of thought implied in the later, are anticipated in the earlier work. The arrangement even is the same. The chief difference between the two treatises is one which twenty years' experience in affairs could not but bring—the substitution of more cautious and guarded language, less dogmatic affirmation, more allowance for exceptions and deviations. The *Jus pacis* was an addition introduced first in the later work, an insertion which is the cause of not a little of the confused arrangement which has been found fault with in the *De jure belli*.

The *De jure praedae* further demonstrates that Grotius was originally determined to this subject, not by any speculative intellectual interest, but by a special occasion presented by his professional engagements. He was retained by the Dutch East India Company as their advocate. One of their captains, Heemskirk, had captured a rich Portuguese galleon in the Straits of Malacca. The right of a private company to make prizes was hotly contested in Holland, and denied by the stricter religionists, especially the Mennonites, who considered all war unlawful. Grotius undertook to prove that Heemskirk's prize had been lawfully captured. In doing this he was led to investigate the grounds of the lawfulness of war in general. Such was the casual origin of a book which long enjoyed such celebrity that it used to be said, with some exaggeration indeed, that it had founded a new science.

A short treatise which was printed in 1609, Grotius says without his permission, under the title of *Mare liberum*, is nothing more than a chapter—the 12th—of the *De jure praedae*. It was necessary to Grotius's defence of Heemskirk that he should show that the Portuguese pretence that Eastern waters were their private property was untenable. Grotius maintains that the ocean is free to all nations. The occasional character of this piece explains the fact that at the time of its appearance it made no sensation. It was not till many years afterwards that the jealousies between England and Holland gave importance to the novel doctrine broached in the tract by Grotius, a doctrine which Selden set himself to refute in his *Mare clausum* (1632).

Equally due to the circumstances of the time was his small contribution to constitutional history entitled *De antiquitate reipublicae Batavae* (1610). In this he vindicates, on grounds of right, prescriptive and natural, the revolt of the United Provinces against the sovereignty of Spain.

Grotius, when he was only thirty, was made pensionary of the city of Rotterdam. In 1613 he formed one of a deputation to England, in an attempt to adjust those differences which gave rise afterwards to a naval struggle disastrous to Holland. He was received by James with every mark of distinction. He also cultivated the acquaintance of the Anglican ecclesiastics John Overall and L. Andrews, and was much in the society of the celebrated scholar Isaac Casaubon, with whom he had been in correspondence by letter for many years. Though the mediating views in the great religious conflict between Catholic and Protestant, by which Grotius was afterwards known, had been arrived at by him by independent reflection, yet it could not but be that he would be confirmed in them by finding in England a developed school of thought of the same character already in existence. How highly Casaubon esteemed Grotius appears from a letter of his to Daniel Heinsius, dated London, 13th of April 1613. "I cannot say how happy I esteem myself in having seen so much of one so truly great as Grotius. A

wonderful man! This I knew him to be before I had seen him; but the rare excellence of that divine genius no one can sufficiently feel who does not see his face, and hear him speak. Probity is stamped on his features; his conversation savours of true piety and profound learning. It is not only upon me that he has made this impression; all the pious and learned to whom he has been here introduced have felt the same towards him; the king especially so!"

After Grotius's return from England the exasperation of theological parties in Holland rose to such a pitch that it became clear that an appeal to force would be made. Grotius sought to find some mean term in which the two hostile parties of Remonstrants and Anti-remonstrants, or as they were subsequently called Arminians and Gomarists (see REMONSTRANTS), might agree. A form of edict drawn by Grotius was published by the states, recommending mutual toleration, and forbidding ministers in the pulpit from handling the disputed dogmas. To the orthodox Calvinists the word toleration was insupportable. They had the populace on their side. This fact determined the stadtholder, Maurice of Nassau, to support the orthodox party—a party to which he inclined the more readily that Olden Barneveldt, the grand pensionary, the man whose uprightness and abilities he most dreaded, sided with the Remonstrants.

In 1618 Prince Maurice set out on a sort of pacific campaign, disbanding the civic guards in the various cities of Guelders, Holland and Zealand, and occupying the places with troops on whom he could rely. The states of Holland sent a commission, of which Grotius was chairman, to Utrecht, with the view of strengthening the hands of their friends, the Remonstrant party, in that city. Feeble plans were formed, but not carried into effect, for shutting the gates upon the stadtholder, who entered the city with troops on the night of the 26th of July 1618. There were conferences in which Grotius met Prince Maurice, and taught him that Olden Barneveldt was not the only man of capacity in the ranks of the Remonstrants whom he had to fear. On the early morning of the 31st of July the prince's *coup d'état* against the liberties of Utrecht and of Holland was carried out; the civic guard was disarmed—Grotius and his colleagues saving themselves by a precipitate flight. But it was only a reprieve. The grand pensionary, Olden Barneveldt, the leader of the Remonstrant party, Grotius and Hoogerbecs were arrested, brought to trial, and condemned—Olden Barneveldt to death, and Grotius to imprisonment for life and confiscation of his property. In June 1619 he was immured in the fortress of Louvestein near Gorcum. His confinement was rigorous, but after a time his wife obtained permission to share his captivity, on the condition that if she came out, she should not be suffered to return.

Grotius had now before him, at thirty-six, no prospect but that of a lifelong captivity. He did not abandon himself to despair, but sought refuge in returning to the classical pursuits of his youth. Several of his translations (into Latin) from the Greek tragedians and other writers, made at this time, have been printed. "The Muses," he writes to Voss, "were now his consolation, and appeared more amiable than ever."

The ingenuity of Madame Grotius at length devised a mode of escape. It had grown into a custom to send the books which he had done with in a chest along with his linen to be washed at Gorcum. After a time the warders began to let the chest pass without opening it. Madame Grotius, perceiving this, prevailed on her husband to allow himself to be shut up in it at the usual time. The two soldiers who carried the chest out complained that it was so heavy "there must be an Arminian in it." "There are indeed," said Madame Grotius, "Arminian books in it." The chest was carried to the house of a friend, where Grotius was released. He was then dressed like a mason with hod and trowel, and so conveyed over the frontier. His first place of refuge was Antwerp, from which he proceeded to Paris, where he arrived in April 1621. In October he was joined by his wife. There he was presented to the king, Louis XIII., and a pension of 3000 livres conferred upon him. French pensions were easily granted, all the more so as they were never paid. Grotius was now

reduced to great straits. He looked about for any opening through which he might earn a living. There was talk of something in Denmark; or he would settle in Spire, and practise in the court there. Some little relief he got through the intervention of Étienne d'Aligre, the chancellor, who procured a royal mandate which enabled Grotius to draw, not all, but a large part of his pension. In 1623 the president Henri de Mêmes lent him his château of Balagni near Senlis (dep. Oise), and there Grotius passed the spring and summer of that year. De Thou gave him facilities to borrow books from the superb library formed by his father.

In these circumstances the *De jure belli et pacis* was composed. That a work of such immense reading, consisting in great part of quotation, should have been written in little more than a year was a source of astonishment to his biographers. The achievement would have been impossible, but for the fact that Grotius had with him the first draft of the work made in 1604. He had also got his brother William, when reading his classics, to mark down all the passages which touched upon law, public or private. In March 1625 the printing of the *De jure belli*, which had taken four months, was completed, and the edition despatched to the fair at Frankfurt. His own honorarium as author consisted of 200 copies, of which, however, he had to give away many to friends, to the king, the principal courtiers, the papal nuncio, &c. What remained he sold for his own profit at the price of a crown each, but the sale did not recoup him his outlay. But though his book brought him no profit it brought him reputation, so widely spread, and of such long endurance, as no other legal treatise has ever enjoyed.

Grotius hoped that his fame would soften the hostility of his foes, and that his country would recall him to her service. Theological rancour, however, prevailed over all other sentiments, and, after fruitless attempts to re-establish himself in Holland, Grotius accepted service under Sweden, in the capacity of ambassador to France. He was not very successful in negotiating the treaty on behalf of the Protestant interest in Germany, Richelieu having a special dislike to him. He never enjoyed the confidence of the court to which he was accredited, and frittered away his influence in disputes about precedence. In 1645 he demanded and obtained his recall. He was honourably received at Stockholm, but neither the climate nor the tone of the court suited him, and he asked permission to leave. He was driven by a storm on the coast near Dantzic. He got as far as Rostock, where he found himself very ill. Stockman, a Scottish physician who was sent for, thought it was only weakness, and that rest would restore the patient. But Grotius sank rapidly, and died on the 29th of August 1645.

Grotius combined a wide circle of general knowledge with a profound study of one branch of law. History, theology, jurisprudence, politics, classics, poetry,—all these fields he cultivated. His commentaries on the Scriptures were the first application on an extensive scale of the principle affirmed by Scaliger, that, namely, of interpretation by the rules of grammar without dogmatic assumptions. Grotius's philological skill, however, was not sufficient to enable him to work up to this ideal.

As in many other points Grotius inevitably recalls Erasmus, so he does in his attitude towards the great schism. Grotius was, however, animated by an ardent desire for peace and concord. He thought that a basis for reconciliation of Protestant and Catholic might be found in a common piety, combined with reticence upon discrepancies of doctrinal statement. His *De veritate religionis Christianae* (1627), a presentment of the evidences, is so written as to form a code of common Christianity, irrespective of sect. The little treatise became widely popular, gaining rather than losing popularity in the 18th century. It became the classical manual of apologetics in Protestant colleges, and was translated for missionary purposes into Arabic (by Pococke, 1660), Persian, Chinese, &c. His *Via et votum ad pacem ecclesiasticam* (1642) was a detailed proposal of a scheme of accommodation. Like all men of moderate and mediating views, he was charged by both sides with vacillation. An Amsterdam minister, James Laurent, published his *Grotius*

papistans (1642), and it was continually being announced from Paris that Grotius had "gone over." Hallam, who has collected all the passages from Grotius's letters in which the prejudices and narrow tenets of the Reformed clergy are condemned, thought he had a "bias towards popery" (*Lit. of Europe*, ii. 312). The true interpretation of Grotius's mind appears to be an indifference to dogmatic propositions, produced by a profound sentiment of piety. He approached parties as a statesman approaches them, as facts which have to be dealt with, and governed, not suppressed in the interests of some one of their number.

His editions and translations of the classics were either juvenile exercises prescribed by Scaliger, or "lusus poetici," the amusement of vacant hours. Grotius read the classics as a humanist, for the sake of their contents, not as a professional scholar.

His *Annals of the Low Countries* was begun as an official duty while he held the appointment of historiographer, and was being continued and retouched by him to the last. It was not published till 1657, by his sons Peter and Cornelius.

Grotius was a great jurist, and his *De jure belli et pacis* (Paris, 1625), though not the first attempt in modern times to ascertain the principles of jurisprudence, went far more fundamentally into the discussion than any one had done before him. The title of the work was so far misleading that the *jus belli* was a very small part of his comprehensive scheme. In his treatment of this narrower question he had the works of Alberico Gentili and Ayala before him, and has acknowledged his obligations to them. But it is in the larger questions to which he opened the way that the merit of Grotius consists. His was the first attempt to obtain a principle of right, and a basis for society and government, outside the church or the Bible. The distinction between religion on the one hand and law and morality on the other is not indeed clearly conceived by Grotius, but he wrestles with it in such a way as to make it easy for those who followed him to seize it. The law of nature is unalterable; God Himself cannot alter it any more than He can alter a mathematical axiom. This law has its source in the nature of man as a social being; it would be valid even were there no God, or if God did not interfere in the government of the world. These positions, though Grotius's religious temper did not allow him to rely unreservedly upon them, yet, even in the partial application they find in his book, entitle him to the honour of being held the founder of the modern science of the law of nature and nations. The *De jure* exerted little influence on the practice of belligerents, yet its publication was an epoch in the science. De Quincy has said that the book is equally divided between "empty truisms and time-serving Dutch falsehoods." For a saner judgment and a brief abstract of the contents of the *De jure*, consult J. K. Bluntschli, *Geschichte des allgemeinen Staatsrechts* (Munich, 1864). A fuller analysis, and some notice of the predecessors of Grotius, will be found in Hély, *Étude sur le droit de la guerre de Grotius* (Paris, 1875). The writer, however, had never heard of the *De jure praeadae*, published in 1868. Hallam, *Lit. of Europe*, ii. p. 543, has an abstract done with his usual conscientious pains. Dugald Stewart (*Collected Works*, i. 370) has dwelt upon the confusion and defects of Grotius's theory. Sir James Mackintosh (*Miscell. Works*, p. 166) has defended Grotius, affirming that his work "is perhaps the most complete that the world has yet owed, at so early a stage in the progress of any science, to the genius and learning of one man."

The chief writings of Grotius have been named. For a complete bibliography of his works, see Lehmann, *Hugonis Grotii manus vindicatus* (Delft, 1727), which also contains a full biography. Of this Latin life De Burigny published a réchauffée in French (2 vols., 8vo, Paris, 1752). Other lives are: Van Brandt, *Historie van het Leven H. de Groot* (2 vols., 8vo, Dordrecht, 1727); Von Luden, *Hugo Grotius nach seinen Schicksalen und Schriften dargestellt* (8vo, Berlin, 1806); *Life of Hugo Grotius*, by Charles Butler of Lincoln's Inn (8vo, London, 1826). The work of the Abbé Hély contains a life of Grotius. See also *Hugo Grotius*, by L. Neumann (Berlin, 1884); *Opinions of Grotius*, by D. P. de Bruyn (London, 1804).

Grotius's theological works were collected in 3 vols. fol. at Amsterdam (1644-1646; reprinted London, 1660; Amsterdam, 1679; and again Amsterdam, 1698). His letters were printed first in a selection, *Epistolae ad Gallos* (12mo, Leiden, 1648), abounding, though an Elsevir, in errors of the press. They were collected in *H.*

Grothii epistolae quotquot reperiri poterunt (fol., Amsterdam, 1687). A few may be found scattered in other collections of *Epistolae*. Supplements to the large collection of 1687 were published at Haarlem, 1806; Leiden, 1809; and Haarlem, 1829. The *De jure belli* was translated into English by Whewell (3 vols., 8vo., Cambridge, 1833); into French by Barbeyrac (2 vols., 4to., Amsterdam, 1724); into German in Kirchner's *Philosophische Bibliothek* (3 vols., 12mo., Leipzig, 1879). (M. F.)

GROTTAFERRATA, a village of Italy, in the province of Rome, from which it is 13 m. S.E. by electric tramway, and 24 m. S. of Frascati, 1080 ft. above sea-level, in the Alban Hills. Pop. (1901) 2645. It is noticeable for the Greek monastery of Basilians founded by S. Nilus in 1002 under the Emperor Otho III., and which occupies the site of a large Roman villa, possibly that of Cicero. It was fortified at the end of the 15th century by Cardinal Giuliano della Rovere (afterwards Pope Julius II.), whose arms may be seen about it. The massive towers added by him give it a picturesque appearance. The church belongs to the 12th century, and the original portal, with a mosaic over it, is still preserved; the interior was restored in 1574 and in 1754, but there are some remains of frescoes of the 13th century. The chapel of S. Nilus contains frescoes by Domenico Zampieri (Domenichino) of 1610, illustrating the life of the saint, which are among his most important works. The abbot's palace has a fine Renaissance portico, and contains an interesting museum of local antiquities. The library contains valuable MSS., among them one from the hand of S. Nilus (965); and a palaeographical school, for the copying of MSS. in the ancient style, is maintained. An *omophoron* of the 11th or 12th century, with scenes from the Gospel in needlework, and a chalice of the 15th century with enamels, given by Cardinal Bessarion, the predecessor of Giuliano della Rovere as commendatory of the abbey, are among its treasures. An important exhibition of Italo-Byzantine art was held here in 1905-1906.

See A. Rocchi, *La Badia di Grottaferrata* (Rome, 1884); A. Muñoz, *L'Art byzantin à l'exposition de Grottaferrata* (Rome, 1905); T. Ashby in *Papers of the British School at Rome*, iv. (1907). (T. As.)

GROUCHY, EMMANUEL, MARQUIS DE (1766-1847), marshal of France, was born in Paris on the 23rd of October 1766. He entered the French artillery in 1779, transferred to the cavalry in 1782, and to the *Gardes du corps* in 1786. In spite of his aristocratic birth and his connexions with the court, he was a convinced supporter of the principles of the Revolution, and had in consequence to leave the Guards. About the time of the outbreak of war in 1792 he became colonel of a cavalry regiment, and soon afterwards, as a *maréchal de camp*, he was sent to serve on the south-eastern frontier. In 1793 he distinguished himself in La Vendée, and was promoted general of division. Grouchy was shortly afterwards deprived of his rank as being of noble birth, but in 1795 he was again placed on the active list. He served on the staff of the Army of Ireland (1796-1797), and took a conspicuous part in the Irish expedition. In 1798 he administered the civil and military government of Piedmont at the time of the abdication of the king of Sardinia, and in 1799 he distinguished himself greatly as a divisional commander in the campaign against the Austrians and Russians. In covering the retreat of the French after the defeat of Novi, Grouchy received fourteen wounds and was taken prisoner. On his release he returned to France. In spite of his having protested against the *coup d'état* of the 18th of Brumaire he was at once re-employed by the First Consul, and distinguished himself again at Hohenlinden. It was not long before he accepted the new régime in France, and from 1801 onwards he was employed by Napoleon in military and political positions of importance. He served in Austria in 1805, in Prussia in 1806, Poland in 1807, Spain in 1808, and commanded the cavalry of the Army of Italy in 1809 in the Viceroy Eugène's advance to Vienna. In 1812 he was made commander of one of the four cavalry corps of the Grand Army, and during the retreat from Moscow Napoleon appointed him to command the escort squadron, which was composed entirely of picked officers. His almost continuous service with the cavalry led Napoleon to decline in 1813 to place Grouchy at the head of an army corps, and Grouchy thereupon retired to France. In

1814, however, he hastened to take part in the defensive campaign in France, and he was severely wounded at Craonne. At the Restoration he was deprived of the post of colonel-general of *chasseurs à cheval* and retired. He joined Napoleon on his return from Elba, and was made marshal and peer of France. In the campaign of Waterloo he commanded the reserve cavalry of the army, and after Ligny he was appointed to command the right wing to pursue the Prussians. The march on Wavre, its influence on the result of the campaign, and the controversy to which Grouchy's conduct on the day of Waterloo has given rise, are dealt with briefly in the article WATERLOO CAMPAIGN, and at length in nearly every work on the campaign of 1815. Here it is only necessary to say that on the 17th Grouchy was unable to close with the Prussians, and on the 18th, though urged to march towards the sound of the guns of Waterloo, he permitted himself, from whatever cause, to be held up by a Prussian rearguard while the Prussians and English united to crush Napoleon. On the 19th Grouchy won a small victory over the Prussians at Wavre, but it was then too late. So far as resistance was possible after the great disaster, Grouchy made it. He gathered up the wrecks of Napoleon's army and retired, swiftly and unbroken, to Paris, where, after interposing his reorganized forces between the enemy and the capital, he resigned his command into the hands of Marshal Davout. The rest of his life was spent in defending himself. An attempt to have him condemned to death by a court-martial failed, but he was exiled and lived in America till amnestied in 1821. On his return to France he was reinstated as general, but not as marshal nor as peer of France. For many years thereafter he was equally an object of aversion to the court party, as a member of their own caste who had followed the Revolution and Napoleon, and to his comrades of the Grand Army as the supposed betrayer of Napoleon. In 1830 Louis Philippe gave him back the marshal's bâton and restored him to the Chamber of Peers. He died at St-Étienne on the 29th of May 1847.

See Marquis de Grouchy, *Mémoires du maréchal Marquis de Grouchy* (Paris, 1873-1874); General Marquis de Grouchy, *Le Général Grouchy en Irlande* (Paris, 1866), and *Le Maréchal Grouchy du 16 au 18 juin, 1815* (Paris, 1864); *Appel à l'histoire sur les faits de l'armée française* (Paris, n.d.); *Séance Justice sur les faits . . . du 28 juin au 3 juillet, 1815* (Paris, 1866); and the literature of the Waterloo campaign. Marshal Grouchy himself wrote the following: *Observations sur la relation de la campagne de 1815 par le général de Gourgaud* (Philadelphia and Paris, 1818); *Réfutation de quelques articles des mémoires de M. le Duc de Rovigo* (Paris, 1829); *Fragment historique relatif à la campagne et à la bataille de Waterloo* (Paris, 1829-1830, in reply to Barthélemy and Méry, and to Marshal Gérard); *Réclamation du maréchal de Grouchy* (Paris, 1834); *Plainte contre le général Baron Berthelme* (Berthelme, formerly a divisional commander under Gérard, stated in reply to this defence that he had no intention of accusing Grouchy of ill faith).

GROUND-ICE,¹ ice formed at the bottom of streams while the temperature of the water is above freezing-point. Everything points to radiation as the prime cause of the formation of ground-ice. It is formed only under a clear sky, never in cloudy weather; it is most readily formed on dark rocks, and never under any covering such as a bridge, and rarely under surface-ice. Professor Howard T. Barnes of McGill University concludes that the radiation from a river bed in cold and clear nights goes through the water in long rays that penetrate much more easily from below upwards than the sun's heat rays from above downwards, which are mostly absorbed by the first few feet of water. On a cold clear night, therefore, the radiation from the bottom is excessive, and loosely-grown spongy masses of anchor-ice form on the bottom, which on the following bright sunny day receive just sufficient heat from the sun to detach the mass of

¹ The O. Eng. word *grund*, ground, is common to Teutonic languages, cf. Du. *grond*, Ger. *Grund*, but has no cognates outside Teutonic. The suggestion that the origin is to be found in "grind," to crush small, reduce to powder, is plausible, but the primary meaning seems to be the lowest part or bottom of anything rather than grit, sand or gravel. The main branches in sense appear to be, first, bottom, as of the sea or a river, cf. the use, in the plural, for dregs; second, base or foundation, actual, as of the first or main surface of a painting, fabric, &c., or figurative, as of a principle or reason; third the surface of the earth, or a particular part of that surface.

ice, which rises to the surface with considerable force. It is probable that owing to surface tension a thin film of stationary water rests upon the boulders and sand over which a stream flows, and that this, becoming frozen owing to radiation, forms the foundation for the anchor-ice and produces a surface upon which the descending frazil-ice (see below) can lodge. The theory of radiation from the boulders is supported by the fact that as the ice is formed upon them in response to a sudden fall in the air temperature, it is only released under the influence of a strong rise of temperature during the morning. It may not rise for several days, but the advent of bright sunlight is followed by the appearance on the surface of masses of ground-ice. This ice has a spongy texture and frequently carries gravel with it when it rises. It is said that the bottom of Lake Erie is strewn with gravel that has been floated down in this way. This "anchor-ice," as it was called by Canadian trappers, frequently forms dams across narrow portions of the river where the floating masses are caught. Dr H. Landor pointed out that the Mackenzie and Mississippi rivers, which rise in the same region and flow in opposite directions, carry ground-ice from their head-waters for a considerable distance down stream, and suggested that here and in Siberia many forms of vegetable and animal life may be distributed from a centre by this agency, since the material carried by the floating ice would contain the seeds and eggs or larvae of many forms.

Besides ground-ice and anchor-ice this formation is called also bottom-ice, ground-gru and lapped ice, the two last names being Scottish. In France it is called *glace de fond*, in Germany *Grundeis*, and in French Canada *montone* from the appearance of sheep at rest, since the ice formed at the bottom grows in woolly, spongy masses upon boulders or other projections.

"Frazil-ice" is a Canadian term from the French for "forginders." It is surface ice formed in spicules and carried downwards in water agitated by winds or rapids. The frazil-ice may render swiftly moving water turbid with ice crystals, it may be swirled downwards and accumulated upon the ground ice, or it may be swept under the sheet of surface-ice, coating the under surface of the sheet to a thickness as great as 80 ft. of loose spicular ice.

See W. G. Thompson, in *Nature*, i 555 (1870); H. Landor, in *Geological Magazine*, decade II., vol. III., p. 459 (1876); H. T. Barnes, *Ice Formation with special Reference to Anchor-ice and Frazil* (1906).

GROUND NUT (Earth Nut, Pistache de Terre, Monkey Nut, Pea Nut, Manilla Nut), in botany, the fruit or pod of *Arachis hypogaea* (nat. ord. Leguminosae). The plant is an annual of diffuse habit, with hairy stem, and two-paired, abruptly pinnate leaflets. The pods or legumes are stalked, oblong, cylindrical, about 1 in. in length, the thin reticulated shell containing one or two irregularly ovoid seeds. After the flower withers, the stalk of the ovary has the peculiarity of elongating and bending down, forcing the young pod underground, and thus the seeds become matured at some distance below the surface. Hence the specific and vernacular names of the plant. Originally a native of South America, it is extensively cultivated in all tropical and subtropical countries. The plant affects a light sandy soil, and is very prolific, yielding in some instances 30 to 38 bushels of nuts per acre. The pods when ripe are dug up and dried. The seeds when fresh are largely eaten in tropical countries, and in taste are almost equal to almonds; when roasted they are used as a substitute for chocolate. In America they are consumed in large quantities as the "pea-nut"; but are not much appreciated in England except by the poorer children, who know them as "monkey-nuts." By expression the seeds yield a large quantity of oil, which is used by natives for lamps, as a fish or curry oil and for medicinal purposes. The leaves form an excellent food for cattle, being very like clover.

Large quantities of seeds are imported to Europe, chiefly to Marseilles, London and Hamburg, for the sake of their contained oil. The seeds yield from 42 to 50% of oil by cold expression, but a larger quantity is obtained by heat, although of an inferior quality. The seeds being soft facilitate mechanical expression,

and where bisulphide of carbon or other solvent is used, a very pure oil is obtained.

The expressed oil is limpid, of a light yellowish or straw colour, having a faint smell and bland taste; it forms an excellent substitute for olive oil, although in a slight degree more prone to rancidity than the latter. Its specific gravity is 0.916 to 0.918; it becomes turbid at 3° C., concretes at +3° to -4° C., and hardens at +7° C. It is a non-drying oil. Ground nut oil consists of (1) oleic acid (C₁₈H₃₄O₂); (2) hypogaeic acid (C₁₈H₃₂O₂), by some supposed to be identical with a fatty acid found in whale oil; (3) palmitic acid (C₁₆H₃₂O₂); and (4) arachic acid (C₂₀H₄₀O₂). The oil is used in the adulteration of gingelly oil.

GROUND-PEARL, the glassy secretion forming the pupacase of coccid insects of the genus *Margarodes*, belonging to the homopterous division of the Hemiptera.

GROUND RENT. In Roman law, ground rent (*solarium*) was an annual rent payable by the lessee of a *superficies* or perpetual lease of building land. In English law, it appears that the term was at one time popularly used for the houses and lands out of which ground rents issue as well as for the rents themselves (cf. *Maundy v. Maundy*, 2 Strange, 1020); and Lord Eldon observed in 1815 that the context in which the term occurred may materially vary its meaning (*Stewart v. Alliston*, 1 Mer. 26). But at the present time the accepted meaning of ground rent is the rent at which land is let for the purpose of improvement by building, i.e. a rent charged in respect of the land only and not in respect of the buildings to be placed thereon. It thus conveys the idea of something lower than a rack rent (see RENT); and accordingly if a vendor described property as property for which he paid a "ground rent," without any further explanation of the term, a purchaser would not be obliged to accept the property if it turned out to be held at a rack rent. But while a rack rent is generally higher in amount than a ground rent, the latter is usually better secured, as it carries with it the reversionary interest in buildings and improvements put on the ground after the date at which the ground rent was fixed, and accordingly ground rents have been regarded as a good investment. Trustees empowered to invest money on the security of freehold or copyhold hereditaments, may invest upon freehold ground rents reserved out of house property. In estimating the amount that may be so invested, account may be taken of the value of the houses, as, if the ground rents are not paid, the landlord can re-enter. Again, where a settlement authorizes trustees to purchase lands or hereditaments in fee-simple or possession, a purchase of freehold ground rents has been held to be proper. A devise of "ground rent" carries not only the rent but the reversion. Where a tenant is compelled, in order to protect himself in the enjoyment of the land in respect of which his rent is payable, to pay ground rent to a superior landlord (who is of course in a position to distrain on him for it), he is considered as having been authorized by his immediate landlord to apply his rent, due or accruing due, in this manner, and the payment of the ground rent will be held to be payment of the rent itself or part of it. A lodger should make any payment of this character under the Law of Distress Amendment Act 1908 (s. 3; and see RENT). Ground rents are apportionable (see APPOINTMENT).

In Scots law, the term "ground rent" is not employed, but its place is taken, for practical purposes, by the "ground-annual," which bears a double meaning. (i.) At the time of the Reformation in Scotland, the lands of the Church were parcelled out by the crown into various lordships—the grantees being called Lords of Erection. In the 17th century these Lords of Erection resigned their superiorities to the crown, with the exception of the feu-duties, which were to be retained till a price agreed upon for their redemption had been paid. This reserved power of redemption was, however, resigned by the crown on the eve of the Union and the feu-duties became payable in perpetuity to the Lords of Erection as a "ground-annual." (ii.) Speculators in building ground usually grant sub-feus to builders at a high feu-duty. But where sub-feus are prohibited—as they might be, prior to the Conveyancing (Scotland) Act 1874—and there is much demand for building ground, the feuars frequently stipulate for an annual rent from the builders rather than for a price payable at once. This annual rent is called a "ground-annual." Interest is not

due on arrears of ground-annuals. Like other real burdens, ground-annuals may now be freely assigned and conveyed (Conveyancing (Scotland) Act 1874, s. 30).

The term "ground rent" in the English sense does not seem to be generally used in the United States, but is applied in Pennsylvania to a kind of tenure, created by a grant in fee simple, the grantor reserving to himself and his heirs a certain rent, which is the interest of the money value of the land. These "ground rents" are real estate, and, in cases of intestacy, go to the heir. They are rent services and not rent charges—the statute *Quia Emptores* never having been in force in Pennsylvania, and are subject to all the incidents of such rents (see RENT). The grantee of such a "ground rent" may mortgage, sell, or otherwise dispose of the grant as he pleases; and while the rent is paid the land cannot be sold or the value of the improvements lost.

A ground rent being a freehold estate, created by deed and perpetual in duration, no presumption could, at common law, arise from lapse of time, that it had been released. But now, by statute (Act of 27th of April 1855, s. 7), a presumption of release or extinguishment is created where no payment, claim or demand has been made for the rent, nor any declaration or acknowledgment of its existence made or given by the owner of the premises subject to it, for the period of 21 years. Ground rents were formerly irredeemable after a certain time. But the creation of irredeemable ground rents is now forbidden (Pennsylvania Act 7 Assembly, 22nd of April 1850).

For English Law see Foa, *Landlord and Tenant* (3rd ed., London, 1901); Scots Law, Bell's *Principles* (10th ed., Edinburgh, 1899); American Law, Bouvier, *Law Dict.* (Boston and London, 1897).

(A. W. R.)

GROUNDSEL (Ger. *Krenskraut*; Fr. *seneçon*), *Senecio vulgaris*, an annual, glabrous, or more or less woolly plant of the natural order Compositae, having a branched succulent stem 6 to 15 in. in height, pinnatifid irregularly and coarsely-toothed leaves, and small cylindrical heads of yellow tubular florets enveloped in an involucre of numerous narrow bracts; the ribbed fruit bears a soft, feathery, hoary tuft of hairs (pappus). The plant is indigenous to Europe, whence it has been introduced into all temperate climates. It is a troublesome weed, flowering throughout the year, and propagating itself rapidly by means of its light feathery fruits; it has its use, however, as a food for cage-birds. *Senecio Jacobaea*, ragwort, is a showy plant with heads of bright yellow flowers, common in pastures and by roadsides. The genus *Senecio* is a very large one, widely distributed in temperate and cold climates. The British species are all herbs, but the genus also includes shrubs and even arborescent forms, which are characteristic features of the vegetation of the higher levels on the mountains of tropical Africa. Many species of the genus are handsome florists' plants. The groundsel tree, *Baccharis halimifolia*, a native of the North American sea-coast from Massachusetts southward, is a Composite shrub, attaining 6 to 12 ft. in height, and having angular branches, obovate or oblong-cuneate, somewhat scurfy leaves, and flowers larger than but similar to those of common groundsel. The long white pappus of the female plant renders it a conspicuous object in autumn. The groundsel tree has been cultivated in British gardens since 1683.

The Old English word, represented by "groundsel" appears in two forms, *grundswyge* and *gundeswelpia*; of the first form the accepted derivation is from *grund*, ground, and *swelgan*, to swallow; a weed of such rapid growth would not inaptly be styled a "ground-swallower." If the form without the *r* be genuine, the word might mean "pus-absorber" (O.E. *grund*, filth, matter), with reference to its use in poultices for abscesses and the like.

GROUND-SQUIRREL, one of the names for a group of (chiefly) North American striped terrestrial squirrel-like rodents, more generally known as chipmunks. They are closely allied to squirrels, from which they are distinguished by the possession of cheek-pouches for the storage of food. The sides, or the sides and back, are marked with light stripes bordered by dark bands; the ears are small, and without tufts; and the tail is relatively short. With the exception of one Siberian species (*Tamias sibiricus*), ground-squirrels are confined to North America,

where they are represented by a large number of species and races, all referable to the genus *Tamias*. In North America ground-squirrels are migratory, and may be abundant in a district one year, and absent the next. They feed on nuts, beechmast, corn and roots, and also on grubs. With the assistance of their cheek-pouches they accumulate large supplies of food for the winter, during which season they lie dormant in holes. Although generally keeping to the ground, when hunted they take to trees, which they climb in search of food. One of the longest known American species is *T. striatus*.

GROUPS, THEORY OF. The conception of an operation to be carried out on some object or set of objects underlies all mathematical science. Thus in elementary arithmetic there are the fundamental operations of the addition and the multiplication of integers; in algebra a linear transformation is an operation which may be carried out on any set of variables; while in geometry a translation, a rotation, or a projective transformation are operations which may be carried out on any figure.

In speaking of an operation, an object or a set of objects to which it may be applied is postulated; and the operation may, and generally will, have no meaning except in regard to such a set of objects. If two operations, which can be performed on the same set of objects, are such that, when carried out in succession on any possible object, the result, whichever operation is performed first, is to produce no change in the object, then each of the operations is spoken of as a *definite operation*, and each of them is called the *inverse* of the other. Thus the operations which consist in replacing x by ax and by x/a respectively, in any rational function of x , are definite inverse operations, if a is any assigned number except zero. On the contrary, the operation of replacing x by an assigned number in any rational function of x is not, in the present sense, although it leads to a unique result, a definite operation; there is in fact no unique inverse operation corresponding to it. It is to be noticed that the question whether an operation is a definite operation or no may depend on the range of the objects on which it operates. For example, the operations of squaring and extracting the square root are definite inverse operations if the objects are restricted to be real positive numbers, but not otherwise.

If O, O', O'', \dots is the totality of the objects on which a definite operation S and its inverse S' may be carried out, and if the result of carrying out S on O is represented by $O.S$, then $O.S.S', O.S',S$, and O are the same object whatever object of the set O may be. This will be represented by the equations $SS'S' = S'S'S = 1$. Now $O.S.S'$ has a meaning only if $O.S$ is an object on which S' may be performed. Hence whatever object of the set O may be, both $O.S$ and $O.S'$ belong to the set. Similarly $O.S.S, O.S.S.S, \dots$ are objects of the set. These will be represented by $O.S^2, O.S^3, \dots$. Suppose now that T is another definite operation with the same set of objects as S , and that T' is its inverse operation. Then $O.S.T$ is a definite operation of the set, and therefore the result of carrying out S and then T on the set of objects is some operation U with a unique result. Represent by U' the result of carrying out T' and then S' . Then $O.UU' = O.S.T.T'.S' = O.S.S' = O$, and $O.U'U = O.T'.S'.S.T = O.T.T' = O$, whatever object O may be. Hence $UU' = U'U = 1$; and U, U' are definite inverse operations.

If S, U, V are definite operations, and if S' is the inverse of S , then

implies $SU = SV$
or $S'SU = S'SV$,
Similarly $U = V$,
implies $US = VS$
implies $U = V$.

Let S, T, U, \dots be a set of definite operations, capable of being carried out on a common object or set of objects, and let the set contain—

- (i.) the operation ST, S and T being any two operations of a group of the set;
- (ii.) the inverse operation of S, S being any operation of the set; the set of operations is then called a group.

The number of operations in a group may be either finite or infinite. When it is finite, the number is called the *order* of the group.

¹The word "group" which appears first in English in the sense of an assemblage of figures in an artistic design, picture, &c., is adapted from the Fr. *groupe*, which is to be referred to the Teutonic word meaning "knot," "mass," "bunch," represented in English by "crop" (gs.). The technical mathematical sense is not older than 1870.

and the group is spoken of as a *group of finite order*. If the number of operations is infinite, there are three possible cases. When the group is represented by a set of geometrical operations, for the specification of an individual operation a number of measurements will be necessary. In more analytical language, each operation will be specified by the values of a set of parameters. If no one of these parameters is capable of continuous variation, the group is called a *discontinuous group*. If all the parameters are capable of continuous variation, the group is called a *continuous group*. If some of the parameters are capable of continuous variation and some are not, the group is called a *mixed group*.

If S' is the inverse operation of S , a group which contains S must contain SS' , which produces no change on any possible object. This is called the *identical operation*, and will always be represented by 1. Since $S^p S^q = S^{p+q}$ when p and q are positive integers, and $S^p S^q = S^{p-q}$ while no meaning at present has been attached to S^q when q is negative, S' may be consistently represented by S^{-1} . The set of operations $\dots, S^{-4}, S^{-3}, S^{-2}, 1, S, S^2, \dots$ obviously constitute a group. Such a group is called a *cyclical group*.

It will be convenient, before giving some illustrations of the general group idea, to add a number of further definitions and explanations which apply to all groups alike. If from among the set of operations S, T, U, \dots which constitute a group G , a smaller set S', T', U', \dots can be chosen which themselves constitute a group H , the group H is called a *subgroup* of G . Thus, in particular, if S is an operation of G , the cyclical group constituted by $\dots, S^{-2}, S^{-1}, 1, S, S^2, \dots$ is a subgroup of G , except in the special case when it coincides with G itself.

If S and T are any two operations of G , the two operations S and $T^{-1}ST$ are called *conjugate operations*, and $T^{-1}ST$ is spoken of as the result of *transforming* S by T . It is to be noted that since $ST^{-1} = T^{-1}TS$, T and TS are always conjugate operations in any group containing both S and T . If T transforms S into itself, that is, if $S = T^{-1}ST$ or $TS = ST$, S and T are called *permutible operations*. A group whose operations are all permutible with each other is called an *Abelian group*. If S is transformed into itself by every operation of G , or, in other words, if it is permutible with every operation of G , it is called a *self-conjugate operation* of G .

The conception of operations being conjugate to each other is extended to subgroups. If S', T, U, \dots are the operations of a subgroup H , and if R is any operation of G , then the operations $R^{-1}S'R, R^{-1}T'R, R^{-1}U'R, \dots$ belong to G , and constitute a subgroup of G . For if $ST = U$, then $R^{-1}S'R \cdot R^{-1}T'R = R^{-1}STR = R^{-1}U'R$. This subgroup may be identical with H . In particular, it is necessarily the same as H if R belongs to H . If it is not identical with H , it is said to be *conjugate to* H , and it is in any case represented by the symbol $R^{-1}HR$. If $H = R^{-1}HR$, the operation R is said to be permutible with the subgroup H . (It is to be noticed that this does not imply that R is permutible with each operation of H .) If $H = R^{-1}HR$, when for R is taken in turn each of the operations of G , then H is called a *self-conjugate subgroup* of G .

A group is spoken of as *simple* when it has no self-conjugate subgroup other than that constituted by the identical operation alone. A group which has a self-conjugate subgroup is called *composite*.

Let G be a group constituted of the operations S, T, U, \dots , and g a second group constituted of s, t, u, \dots , and suppose that to each operation of G there corresponds a single operation of g in such a way that if $ST = U$, then $st = u$, where s, t, u are the operations corresponding to S, T, U respectively. The groups are then said to be *isomorphic*, and the U correspondence between their operations is spoken of as an *isomorphism* between the groups. It is clear that there may be two distinct cases of such isomorphism. To a single operation of g there may correspond either a single operation of G or more than one. In the first case the isomorphism is spoken of as *simple*, in the second as *multiple*.

Two simply isomorphic groups considered abstractly—that is to say, in regard only to the way in which their operations combine among themselves, and apart from any concrete representation of the operations—are clearly indistinguishable.

If G is multiply isomorphic with g , let A, B, C, \dots be the operations of G which correspond to the identical operation of g . Then to the operations A^{-1} and AB of G there corresponds the identical operation of g ; so that A, B, C, \dots constitute a subgroup H of G . Moreover, if R is any operation of G , the identical operation of g corresponds to every operation of $R^{-1}HR$, and therefore H is a self-conjugate subgroup of G . Since S corresponds to s , and every operation of H to the identical operation of g , therefore every operation of the set SA, SB, SC, \dots , which is represented by SH , corresponds to s . Also these are the only operations that correspond to s . The operations of G may therefore be divided into sets, no two of which contain a common operation, such that the correspondence between the operations of G and g connects each of the sets H, SH, TH, UH, \dots with the single operations s, t, u, \dots written below them. The sets into which the operations of G are thus divided combine among themselves by exactly the same laws as the operations of g . For if $st = u$, then $SH \cdot TH = UH$, in the sense that any operation of the set SH followed by any operation of the set TH gives an operation of the set UH .

The group g , abstractly considered, is therefore completely defined by the division of the operations of G into sets in respect of the self-conjugate subgroup H . From this point of view it is spoken of as the *factor-group* of G in respect of H , and is represented by the symbol G/H . Any composite group in a similar way defines abstractly a factor-group in respect of each of its self-conjugate subgroups.

It follows from the definition of a group that it must always be possible to choose from its operations a set such that every operation of the group can be obtained by combining the operations of the set and their inverses. If the set is such that no one of the operations belonging to it can be represented in terms of the others, it is called a set of *independent generating operations*. Such a set of generating operations may be either finite or infinite in number. If A, B, \dots, E are the generating operations of a group, the group generated by them is represented by the symbol $[A, B, \dots, E]$. An obvious extension of this symbol is used such that $[A, H]$ represents the group generated by combining an operation A with every operation of a group H ; $[H_1, H_2]$ represents the group obtained by combining in all possible ways the operations of the groups H_1 and H_2 ; and so on. The independent generating operations of a group may be subject to certain relations connecting them, but these must be such that it is impossible by combining them to obtain a relation expressing one operation in terms of the others. For instance, $AB = BA$ is a relation conditioning the group $[A, B]$; it does not, however, enable A to be expressed in terms of B , so that A and B are independent generating operations.

Let O, O', O'', \dots be a set of objects which are interchanged among themselves by the operations of a group G , so that if S is any operation of the group, and O any one of the objects, then $O \cdot S$ is an object occurring in the set. If it is possible to find an operation S of the group such that $O \cdot S$ is any assigned one of the set of objects, the group is called *transitive* in respect of this set of objects. When this is not possible the group is called *intransitive* in respect of the set. If it is possible to find S so that any arbitrarily chosen n objects of the set, O_1, O_2, \dots, O_n , are changed by S into O_1', O_2', \dots, O_n' respectively, the latter being also arbitrarily chosen, the group is said to be *n-ply transitive*.

If O, O', O'', \dots is a set of objects in respect of which a group G is transitive, it may be possible to divide the set into a number of subsets, no two of which contain a common object, such that every operation of the group either interchanges the objects of a subset among themselves, or changes them all into the objects of some other subset. When this is the case the group is called *imprimitive* in respect of the set; otherwise the group is called *primitive*. A group which is doubly-transitive, in respect of a set of objects, obviously cannot be imprimitive.

The foregoing general definitions and explanations will now be illustrated by a consideration of certain particular groups. To begin with, as the operations involved are of the most familiar nature, the group of rational arithmetic may be considered.

The fundamental operations of elementary arithmetic consist in the addition and subtraction of integers, and multiplication and division by integers, division by zero alone omitted. Multiplication by zero is not a definite operation, and it must therefore be omitted in dealing with those operations of elementary arithmetic which form a group. The operation that results from carrying out additions, subtractions, multiplications and divisions, of and by integers a finite number of times, is represented by the relation $x' = ax + b$, where a and b are rational numbers of which a is not zero, x is the object of the operation, and x' is the result. The totality of operations of this form obviously constitutes a group.

If S and T represent respectively the operations $x' = ax + b$ and $x' = cx + d$, then $T^{-1}ST$ represents $x' = ax + d - ad + bc$. When a and b are given rational numbers, c and d may be chosen in an infinite number of ways as rational numbers, so that $d - ad + bc$ shall be any assigned rational number. Hence the operations given by $x' = ax + b$, where a is an assigned rational number and b is any rational number, are all conjugate; and no two such operations for which the a 's are different can be conjugate. If a is unity and b zero, S is the identical operation which is necessarily self-conjugate. If a is unity and b different from zero, the operation $x' = x + b$ is an addition. The totality of additions forms, therefore, a single conjugate set of operations. Moreover, the totality of additions with the identical operation, i.e. the totality of operations of the form $x' = x + b$, where b may be any rational number or zero, obviously constitutes a group. The operations of this group are interchanged among themselves when transformed by any operation of the original group. It is therefore a self-conjugate subgroup of the original group.

The totality of multiplications, with the identical operation, i.e. all operations of the form $x' = ax$, where a is any rational number other than zero, again obviously constitutes a group. This, however, is not a self-conjugate subgroup of the original group. In fact, if the operations $x' = ax$ are all transformed by $x' = cx + d$, they give rise to the set $x' = ax + d(1-a)$. When d is a given rational number, the set constitutes a subgroup which is conjugate to the group of multiplications. It is to be noticed that the operations of this latter subgroup may be written in the form $x' = d + a(x-d)$.

The totality of rational numbers, including zero, forms a set of objects which are interchanged among themselves by all operations of the group.

Transitivity and primitivity.

Illustrations of the group idea.

If x_1 and x_2 are any pair of distinct rational numbers, and y_1 and y_2 any other pair, there is just one operation of the group which changes x_1 and x_2 into y_1 and y_2 respectively. For the equations $y_1 = ax_1 + b$, $y_2 = ax_2 + b$ determine a and b uniquely. The group is therefore doubly transitive in respect of the set of rational numbers. If H is the subgroup that leaves unchanged a given rational number x_1 , and S an operation changing x_1 into x_2 , then every operation of S/H leaves x_1 unchanged. The subgroups, each of which leaves a single rational number unchanged, therefore form a single conjugate set. The group of multiplications leaves zero unchanged; and, as has been seen, this is conjugate with the subgroup formed of all operations $x' = d(x-d)$, where d is a given rational number. This subgroup leaves d unchanged.

The group of multiplications is clearly generated by the operations $x' = px$, where for p negative unity and each prime is taken in turn. Every addition is obtained on transforming $x' = x+1$ by the different operations of the group of multiplications. Hence $x' = x+1$, and $x' = px$, ($p = -1, 3, 5, 7, \dots$) form a set of independent generating operations of the group. It is a discontinuous group.

As a second example the group of motions in three-dimensional space will be considered. The totality of motions, i.e. of space displacements which leave the distance of every pair of points unaltered, obviously constitutes a set of operations which satisfies the group definition. From the elements of kinematics it is known that every motion is either (i.) a translation which leaves no point unaltered, but changes each of a set of parallel lines into itself; or (ii.) a rotation which leaves every point of one line unaltered and changes every other point and line; or (iii.) a twist which leaves no point and only one line (its axis) unaltered, and may be regarded as a translation along, combined with a rotation round, the axis. Let S be any motion consisting of a translation J along and a rotation R round a line AB , and let T be any other motion. There is some line CD into which T changes AB ; and therefore $T^{-1}ST$ leaves CD unchanged. Moreover, $T^{-1}ST$ clearly effects the same translation along and rotation round CD that S effects for AB . Two motions, therefore, are conjugate if and only if the amplitudes of their translation and rotation components are respectively equal. In particular, all translations of equal amplitude are conjugate, as also are all rotations of equal amplitude. Any two translations are permutable with each other, and give when combined another translation. The totality of translations constitutes, therefore, a subgroup of the general group of motions; and this subgroup is a self-conjugate subgroup, since a translation is always conjugate to a translation.

All the points of space constitute a set of objects which are interchanged among themselves by all operations of the group of motions. So also do all the lines of space and all the planes. In respect of each of these sets the group is simply transitive. In fact, there is an infinite number of motions which change a point A to A' , but no motion can change A and B to A' and B' respectively unless the distance AB is equal to the distance $A'B'$.

The totality of motions which leave a point A unchanged forms a subgroup. It is clearly constituted of all possible rotations about all possible axes through A , and is known as the group of rotations about a point. Every motion can be represented as a rotation about some axis through A followed by a translation. Hence if G is the group of motions and H the group of translations, G/H is simply isomorphic with the group of rotations about a point.

The totality of the motions which bring a given solid to congruence with itself again constitutes a subgroup of the group of motions. This will in general be the trivial subgroup formed of the identical operation above, but may in the case of a symmetrical body be more extensive. For a sphere or a right circular cylinder the subgroups are those that leave the centre and the axis respectively unaltered. For a solid bounded by plane faces the subgroup is clearly one of finite order. In particular, to each of the regular solids there corresponds such a group. That for the tetrahedron has 12 for its order, (for the cube (or octahedron) 24, and for the icosahedron (or dodecahedron) 60.

The determination of a particular operation of the group of motions involves six distinct measurements; namely, four to give the axis of the twist, one for the magnitude of the translation along the axis, and one for the magnitude of the rotation about it. Each of the six quantities involved may have any value whatever, and the group of motions is therefore a continuous group. On the other hand, a subgroup of the group of motions which leaves a line or a plane unaltered is a mixed group.

We shall now discuss (i.) continuous groups, (ii.) discontinuous groups whose order is not finite, and (iii.) groups of finite order. For proofs of the statements, and the general theorems, the reader is referred to the bibliography.

Continuous Groups.

The determination of a particular operation of a given continuous group depends on assigning special values to each one of a set of parameters which are capable of continuous variation. The first distinction regards the number of these parameters

If this number is finite, the group is called a *finite* continuous group; if infinite, it is called an *infinite* continuous group. In the latter case arbitrary functions must appear in the equations defining the operations of the group when these are reduced to an analytical form. The theory of infinite continuous groups is not yet so completely developed as that of finite continuous groups. The latter theory will mainly occupy us here.

Sophus Lie, to whom the foundation and a great part of the development of the theory of continuous groups are due, undoubtedly approached the subject from a geometrical standpoint. His conception of an operation is to regard it as a geometrical transformation, by means of which each point of (n -dimensional) space is changed into some other definite point.

The representation of such a transformation in analytical form involves a system of equations,

$$x'_s = f_s(x_1, x_2, \dots, x_n), \quad (s = 1, 2, \dots, n),$$

expressing x'_1, x'_2, \dots, x'_n , the co-ordinates of the transformed point in terms of x_1, x_2, \dots, x_n , the co-ordinates of the original point. In these equations the functions f_s are analytical functions of their arguments. Within a properly limited region they must be one-valued, and the equations must admit a unique solution with respect to x_1, x_2, \dots, x_n , since the operation would not otherwise be a definite one.

From this point of view the operations of a continuous group, which depends on a set of r parameters, will be defined analytically by a system of equations of the form

$$x'_s = f_s(x_1, x_2, \dots, x_n; a_1, a_2, \dots, a_r), \quad (s = 1, 2, \dots, n), \quad (I)$$

where a_1, a_2, \dots, a_r represent the parameters. If this operation be represented by A , and that in which b_1, b_2, \dots, b_r are the parameters by B , then the operation AB is represented by the elimination (assumed to be possible) of x'_1, x'_2, \dots, x'_n between the equations (I) and the equations

$$x'_s = f_s(x'_1, x'_2, \dots, x'_n; b_1, b_2, \dots, b_r), \quad (s = 1, 2, \dots, n).$$

Since AB belongs to the group, the result of the elimination must be

$$x'_s = f_s(x_1, x_2, \dots, x_n; c_1, c_2, \dots, c_r),$$

where c_1, c_2, \dots, c_r represent another definite set of values of the parameters. Moreover, since A^{-1} belongs to the group, the result of solving equations (I) with respect to x_1, x_2, \dots, x_n must be

$$x_s = f_s(x'_1, x'_2, \dots, x'_n; d_1, d_2, \dots, d_r), \quad (s = 1, 2, \dots, n).$$

Conversely, if equations (I) are such that these two conditions are satisfied, they do in fact define a finite continuous group.

It will be assumed that the r parameters which enter in equations (I) are independent, i.e. that it is impossible to choose $r' (< r)$ quantities in terms of which a_1, a_2, \dots, a_r can *infinitesimally* be expressed. Where this is the case the group will *not* operationally be spoken of as a "group of order r ." Lie uses the term "r-gliedrige Gruppe." It is to be noticed that the *continuous* word order is used in quite a different sense from that group given to it in connexion with groups of finite order.

In regard to equations (I), which define the general operation of the group, it is to be noticed that, since the group contains the identical operation, these equations must for some definite set of values of the parameters reduce to $x'_1 = x_1, x'_2 = x_2, \dots, x'_n = x_n$. This set of values may, without loss of generality, be assumed to be simultaneous zero values. For if i_1, i_2, \dots, i_r be the values of the parameters which give the identical operation, and if we write

$$a_s = i_s + \alpha_s, \quad (s = 1, 2, \dots, r),$$

then zero values of the new parameters $\alpha_1, \alpha_2, \dots, \alpha_r$ give the identical operation.

To infinitesimal values of the parameters, thus chosen, will correspond operations which cause an infinitesimal change in each of the variables. These are called infinitesimal operations. The most general infinitesimal operation of the group is that given by the system

$$x'_s - x_s = \delta x_s = \frac{\partial f_s}{\partial a_1} \delta a_1 + \frac{\partial f_s}{\partial a_2} \delta a_2 + \dots + \frac{\partial f_s}{\partial a_r} \delta a_r, \quad (s = 1, 2, \dots, n),$$

where, in $\partial f_s / \partial a_s$, zero values of the parameters are to be taken. Since a_1, a_2, \dots, a_r are independent, the ratios of $\delta a_1, \delta a_2, \dots, \delta a_r$ are arbitrary. Hence the most general infinitesimal operation of the group may be written in the form

$$\delta x_s = \left(e_1 \frac{\partial f_s}{\partial a_1} + e_2 \frac{\partial f_s}{\partial a_2} + \dots + e_r \frac{\partial f_s}{\partial a_r} \right) \delta t, \quad (s = 1, 2, \dots, n),$$

where e_1, e_2, \dots, e_r are arbitrary constants, and δt is an infinitesimal.

If $F(x_1, x_2, \dots, x_n)$ is any function of the variables, and if an infinitesimal operation of the group be carried out on the variables in F , the resulting increment of F will be

$$\frac{\partial F}{\partial x_1} \delta x_1 + \frac{\partial F}{\partial x_2} \delta x_2 + \dots + \frac{\partial F}{\partial x_n} \delta x_n.$$

If the differential operator

$$\frac{\partial F}{\partial x_1} \frac{\partial}{\partial a_1} + \frac{\partial F}{\partial x_2} \frac{\partial}{\partial a_2} + \dots + \frac{\partial F}{\partial x_n} \frac{\partial}{\partial a_n}$$

be represented by X_i , ($i=1, 2, \dots, r$), then the increment of F is given by

$$(e_1 X_1 + e_2 X_2 + \dots + e_r X_r) F \Delta$$

When the equations (I.) defining the general operation of the group are given, the coefficients $\partial F / \partial x_i$ which enter in these differential operators are functions of the variables which can be directly calculated.

The differential operator $e_1 X_1 + e_2 X_2 + \dots + e_r X_r$ may then be regarded as defining the most general infinitesimal operation of the group. In fact, if it be for a moment represented by X , then $(1 + \delta)X$ is the result of carrying out the infinitesimal operation on F ; and by putting x_1, x_2, \dots, x_n in turn for F , the actual infinitesimal operation is reproduced. By a very convenient, though perhaps hardly justifiable, phraseology this differential operator is itself spoken of as the general infinitesimal operation of the group. The sense in which this phraseology is to be understood will be made clear by the foregoing explanations.

We suppose now that the constants e_1, e_2, \dots, e_r have assigned values. Then the result of repeating the particular infinitesimal operation $e_1 X_1 + e_2 X_2 + \dots + e_r X_r$ or X an infinite number of times is some finite operation of the group. The effect of this finite operation on F may be directly calculated. In fact, if δ is the infinitesimal already introduced, then

$$\frac{dF}{d\delta} = X.F, \quad \frac{d^2 F}{d\delta^2} = X.X.F, \dots$$

Hence

$$F' = F + \delta \frac{dF}{d\delta} + \frac{\delta^2}{1.2} \frac{d^2 F}{d\delta^2} + \dots \\ = F + X.F + \frac{\delta}{1.2} X.X.F + \dots$$

It must, of course, be understood that in this analytical representation of the effect of the finite operation on F it is implied that δ is taken sufficiently small to ensure the convergence of the (in general) infinite series.

When x_1, x_2, \dots are written in turn for F , the system of equations

$$x'_s = (1 + \delta X + \frac{\delta^2}{1.2} X.X + \dots) x_s, \quad (s=1, 2, \dots, n) \quad (ii)$$

represent the finite operation completely. If t is here regarded as a parameter, this set of operations must in themselves constitute a group, since they arise by the repetition of a single infinitesimal operation. That this is really the case results immediately from noticing that the result of eliminating F' between

$$F' = F + \delta X.F + \frac{\delta^2}{1.2} X.X.F + \dots$$

and

$$F'' = F' + \delta' X.F' + \frac{(\delta')^2}{1.2} X.X.F' + \dots$$

is

$$F'' = F + (\delta + \delta') X.F + \frac{(\delta + \delta')^2}{1.2} X.X.F + \dots$$

The group thus generated by the repetition of an infinitesimal operation is called a *cyclical* group; so that a continuous group contains a cyclical subgroup corresponding to each of its infinitesimal operations.

The system of equations (ii.) represents an operation of the group whatever the constants a_1, a_2, \dots, a_n may be. Hence if a_1, a_2, \dots, a_n be replaced by a_1, a_2, \dots, a_n the equations (ii.) represent a set of operations, depending on r parameters and belonging to the group. They must therefore be a form of the general equations for any operation of the group, and are equivalent to the equations (i.). The determination of the finite equations of a cyclical group, when the infinitesimal operation which generates it is given, will always depend on the integration of a set of simultaneous ordinary differential equations. As a very simple example we may consider the case in which the infinitesimal operation is given by $X = x \partial / \partial x$, so that there is only a single variable. The relation between x' and x is given by $dx'/dx = x^2$, with the condition that $x' = x$ when $t = 0$. This gives at once $x' = x/(1 - tx)$, which might also be obtained by the direct use of (ii.).

When the finite equations (i.) of a continuous group of order r are known, it has now been seen that the differential operator which defines the most general infinitesimal operation of the group can be directly constructed, and that it contains r arbitrary constants. This is equivalent to saying that the group contains r linearly independent infinitesimal operations; and that the most general infinitesimal operation is obtained by combining these linearly with constant coefficients. Moreover, when any r independent infinitesimal operations of the group are known, it has been seen how the general finite operation of the group may be calculated. This obviously suggests that it must be possible to define the group by means of its infinitesimal operations alone; and it is clear that such a definition would lend itself more readily to some applications (for instance, to the theory of differential equations) than the definition by means of the finite equations.

On the other hand, if arbitrarily given linear differential operators will not, in general, give rise to a finite continuous group of order r ; and the question arises as to what conditions such a set of operators

must satisfy in order that they may, in fact, be the independent infinitesimal operations of such a group.

If X, Y are two linear differential operators, $XY - YX$ is also a linear differential operator. It is called the "combinant" of X and Y (it uses the expression *Klammerausdruck*) and is denoted by (XY) . If X, Y, Z are any three linear differential operators the identity (known as Jacobi's)

$$(X(YZ)) + (Y(ZX)) + (Z(XY)) = 0$$

holds between them. Now it may be shown that any continuous group of which X, Y are infinitesimal operations contains also (XY) among its infinitesimal operations. Hence if r linearly independent operations X_1, X_2, \dots, X_r give rise to a finite continuous group of order r , the combinant of each pair must be expressible linearly in terms of the r operations themselves: that is, there must be a system of relations

$$(X_i X_j) = \sum_{k=1}^r c_{ijk} X_k$$

where the c 's are constants. Moreover, from Jacobi's identity and the identity $(XY) + (YX) = 0$ it follows that the c 's are subject to the relations

$$\left. \begin{aligned} c_{ijl} + c_{jil} &= 0, \\ \sum (c_{ijk} c_{ilm} + c_{kilm} + c_{ijlm}) &= 0 \end{aligned} \right\} \quad (iii)$$

for all values of i, j, k and l .

The fundamental theorem of the theory of finite continuous groups is now that these conditions, which are necessary in order that X_1, X_2, \dots, X_r may generate, as infinitesimal operations, a continuous group of order r , are also sufficient.

For the proof of this fundamental theorem see Lie's works (cf. Lie-Engel, I. chap. 9; III. chap. 25).

If two continuous groups of order r are such that, for each, a set of linearly independent infinitesimal operations X_1, X_2, \dots, X_r and Y_1, Y_2, \dots, Y_r can be chosen, so that in the relations

$$(X_i X_j) = \sum c_{ijl} X_l, \quad (Y_i Y_j) = \sum d_{ijl} Y_l$$

the two constants c_{ijl} and d_{ijl} are the same for all values of i, j and l , the two groups are simply isomorphic, X_i and Y_i being corresponding infinitesimal operations.

Two continuous groups of order r , whose infinitesimal operations obey the same system of equations (iii.), may be of very different form; for instance, the number of variables for the one may be different from that for the other. They are, however, said to be of the same type, in the sense that the laws according to which their operations combine are the same for both.

The problem of determining all distinct types of groups of order r is then contained in the purely algebraical problem of finding all the systems of r^2 quantities c_{ijk} which satisfy the relations

$$\left. \begin{aligned} c_{ijl} + c_{jil} &= 0, \\ \sum (c_{ijk} c_{ilm} + c_{kilm} + c_{ijlm}) &= 0, \end{aligned} \right\}$$

for all values of i, j, k and l . To two distinct solutions of the algebraical problem, however, two distinct types of group will not necessarily correspond. In fact, X_1, X_2, \dots, X_r may be replaced by any r independent linear functions of themselves, and the c 's will then be transformed by a linear substitution containing r^2 independent parameters. This, however, does not alter the type of group considered.

For a single parameter there is, of course, only one type of group, which has been called cyclical.

For a group of order two there is a single relation

$$(X_1 X_2) = \alpha X_1 + \beta X_2$$

If α and β are not both zero, let a be finite. The relation may then be written $(\alpha X_1 + \beta X_2, \alpha^{-1} X_1) = \alpha X_1 + \beta X_2$. Hence if $\alpha X_1 + \beta X_2 = X'_1$, and $\alpha^{-1} X_1 = X'_2$, then $(X'_1 X'_2) = X'_1$. There are, therefore, just two types of group of order two, the one given by the relation last written, and the other by $(X_1 X_2) = 0$.

Lie has determined all distinct types of continuous groups of orders three or four; and all types of non-integrable groups (a term which will be explained immediately) of orders five and six (cf. Lie-Engel, III. 713-744).

A problem of fundamental importance in connexion with any given continuous group is the determination of the self-conjugate subgroups which it contains. If X is an infinitesimal operation of a group, and Y any other, the general form of the infinitesimal operations which are conjugate to X is

$$X + t(XY) + \frac{t^2}{2}(XY)Y + \dots$$

Any subgroup which contains all the operations conjugate to X must therefore contain all infinitesimal operations $(XY), (XY)Y, \dots$ where for Y each infinitesimal operation of the group is taken in turn. Hence if X_1, X_2, \dots, X'_s are s linearly independent operations of the group which generate a self-conjugate subgroup of order s , then for every infinitesimal operation Y of the group relations of the form

$$(X'_i Y) = \sum a_{ij} X'_j, \quad (i=1, 2, \dots, s)$$

Determination of the distinct types of continuous groups of order r .

Self-conjugate subgroups.

must be satisfied. Conversely, if such a set of relations is satisfied, X_1, X_2, \dots, X_r generate a subgroup of order s , which contains every operation conjugate to each of the infinitesimal generating operations, and is therefore a self-conjugate subgroup.

A specially important self-conjugate subgroup is that generated by the combinants of the r infinitesimal generating operations. That these generate a self-conjugate subgroup follows from the relations (iii). In fact,

$$((X_r X_i) X_j) X_k = \sum c_{ij} (X_r X_k) X_j$$

Of the $\frac{1}{2}r(r-1)$ combinants not more than r can be linearly independent. When exactly r of them are linearly independent, the self-conjugate group generated by them coincides with the original group. If the number that are linearly independent is less than r , the self-conjugate subgroup generated by them is actually a subgroup; i.e. its order is less than that of the original group. This subgroup is known as the derived group, and Lie has called a group *perfect* when it coincides with its derived group. A simple group, since it contains no self-conjugate subgroup distinct from itself, is necessarily a perfect group.

If G is a given continuous group, G_1 the derived group of G , G_2 that of G_1 , and so on, the series of groups G, G_1, G_2, \dots will terminate either with the identical operation or with a perfect group; for the order of G_{n+1} is less than that of G , unless G_n is a perfect group. When the series terminates with the identical operation, G is said to be an *integrable* group; in the contrary case G is called *non-integrable*.

If G is an integrable group of order r , the infinitesimal operations X_1, X_2, \dots, X_r which generate the group may be chosen so that X_1, X_2, \dots, X_{r-1} generate the first derived group, X_2, X_3, \dots, X_{r-1} the second derived group, and so on. When they are so chosen the constants c_{ij} are clearly such that if $r_1 < i < r_2, r_2 < j < r_3, \dots, r_{s-1} < i < r_s$, then c_{ij} vanishes unless $s \leq r_{s+1}$.

In particular the generating operations may be chosen so that c_{ij} vanishes unless s is equal to or less than the smaller of the two numbers i, j ; and conversely, if the c 's satisfy these relations, the group is integrable.

A simple group, as already defined, is one which has no self-conjugate subgroup. It is a remarkable fact that the determination of all distinct types of simple continuous groups has been made, for in the case of discontinuous groups and groups of finite order this is far from being the case. Lie has demonstrated the existence of four great classes of simple groups:—

(i.) The groups simply isomorphic with the general projective group in space of n dimensions. Such a group is defined analytically as the totality of the transformations of the form

$$x'_i = \frac{a_{11}x_1 + a_{12}x_2 + \dots + a_{1n}x_n + a_{1n+1}}{a_{21}x_1 + a_{22}x_2 + \dots + a_{2n}x_n + a_{2n+1}} \quad (i=1, 2, \dots, n),$$

where the a 's are parameters. The order of this group is clearly $n(n+2)$.

(ii.) The groups simply isomorphic with the totality of the projective transformations which transform a non-special linear complex in space of $2n-1$ dimensions with itself. The order of this group is $n(2n+1)$.

(iii.) and (iv.) The groups simply isomorphic with the totality of the projective transformations which change a quadric of non-vanishing discriminant into itself. These fall into two distinct classes of types according as n is even or odd. In either case the order is $\frac{1}{2}n(n+1)$. The case $n=3$ forms an exception in which the corresponding group is not simple. It is also to be noticed that a cyclical group is a simple group, since it has no continuous self-conjugate subgroup distinct from itself.

W. K. Killing and E. J. Cartan have separately proved that outside these four great classes there exist only five distinct types of simple groups, whose orders are 14, 32, 78, 133 and 248; thus completing the enumeration of all possible types.

To prevent any misapprehension as to the bearing of these very general results, it is well to point out explicitly that there are no limitations on the parameters of a continuous group as it has been defined above. They are to be regarded as taking in general complex values. If in the finite equations of a continuous group the imaginary symbol does not explicitly occur, the finite equations will usually define a group (in the general sense of the original definition) when both parameters and variables are limited to real values. Such a group is, in a certain sense, a continuous group; and such groups have been considered shortly by Lie (cf. Lie-Engel, iii. 360-392), who calls them *real* continuous groups. To these real continuous groups the above statement as to the totality of simple groups does not apply; and indeed, in all probability, the number of types of real simple continuous groups admits of no such complete enumeration. The effect of limitation to real transformations may be illustrated by considering the groups of projective transformations which change

$$x^2 + y^2 + z^2 = 0 \quad \text{and} \quad x^2 + y^2 - z^2 = 0$$

respectively into themselves. Since one of these quadrics is changed into the other by the imaginary transformation

$$x' = x, \quad y' = y, \quad z' = z\sqrt{-1},$$

the general continuous groups which transform the two quadrics respectively into themselves are simply isomorphic. This is not however, the case for the *real* continuous groups. In fact, the second quadric has two real sets of generators; and therefore the real group which transforms it into itself has two self-conjugate subgroups, either of which leaves unchanged each of one set of generators. The first quadric having imaginary generators, no such self-conjugate subgroups can exist for the real group which transforms it into itself; and this real group is in fact simple.

Among the groups isomorphic with a given continuous group there is one of special importance which is known as the *adjunct* group. This is a homogeneous linear group in a number of variables equal to the order of the group, whose infinitesimal operations are defined by the relations

$$X_j = \sum c_{ij} x_i \frac{\partial}{\partial x_j} \quad (j=1, 2, \dots, r),$$

where c_{ij} are the often-used constants, which give the combinants of the infinitesimal operations in terms of the infinitesimal operations themselves.

That the r infinitesimal operations thus defined actually generate a group isomorphic with the given group is verified by forming their combinants. It is thus found that $(X_r X_i) X_j = \sum c_{ij} X_r X_j$. The X 's,

however, are not necessarily linearly independent. In fact, the sufficient condition that $\sum c_{ij} X_j$ should be identically zero is that

$\sum c_{ij} c_{ij} = 0$ for all values of i and s . Hence if the equations $\sum c_{ij} c_{ij} = 0$ for all values of i and s , have r' linearly independent

solutions, only $r-r'$ of the X 's are linearly independent, and the isomorphism of the two groups is multiple. If $Y_1, Y_2, \dots, Y_{r'}$ are the infinitesimal operations of the given group, the equations

$$\sum c_{ij} c_{ij} = 0, \quad (i, j=1, 2, \dots, r)$$

express the condition that the operations of the cyclical group generated by $\sum c_{ij} Y_j$ should be permutable with every operation of

the group; in other words, that they should be self-conjugate operations. In the case supposed, therefore, the given group contains a subgroup of order r' each of whose operations is self-conjugate. The adjunct group of a given group will therefore be simply isomorphic with the group, unless the latter contains self-conjugate operations; and when this is the case the order of the adjunct will be less than that of the given group by the order of the subgroup formed of the self-conjugate operations.

We have been thus far mainly concerned with the abstract theory of continuous groups, in which no distinction is made between two simply isomorphic groups. We proceed to discuss the classification and theory of groups when their form is regarded as essential; and this is a return to a more geometrical point of view.

It is natural to begin with the projective groups, which are the simplest in form and at the same time are of supreme importance in geometry. The general projective group of the straight line is the group of order three given by

$$x' = \frac{ax+b}{cx+d}$$

where the parameters are the ratios of a, b, c, d . Since

$$\frac{x'_2 - x'_1}{x'_3 - x'_1} \cdot \frac{x'_3 - x'_2}{x'_1 - x'_2} = \frac{x_2 - x_1}{x_3 - x_1} \cdot \frac{x_3 - x_2}{x_1 - x_2}$$

is an operation of the above form, the group is triply transitive. Every subgroup of order two leaves one point unchanged, and all such subgroups are conjugate. A cyclical subgroup leaves either two distinct points or two coincident points unchanged. A subgroup which either leaves two points unchanged or interchanges them is an example of a "mixed" group.

The analysis of the general projective group must obviously increase very rapidly in complexity, as the dimensions of the space to which it applies increase. This analysis has been completely carried out for the projective group of the plane, with the result of showing that there are thirty distinct types of subgroup. Excluding the general group itself, every one of these leaves either a point, a line, or a conic section unaltered. For space of three dimensions Lie has also carried out a similar investigation, but the results are extremely complicated. One general result of great importance at which Lie arrives in this connexion is that every projective group in space of three dimensions, other than the general group, leaves either a point, a curve, a surface or a linear complex unaltered.

Returning now to the case of a single variable, it can be shown that any finite continuous group in one variable is either cyclical or of order two or three, and that by a suitable transformation any such group may be changed into a projective group.

The genesis of an infinite as distinguished from a finite continuous group may be well illustrated by considering it in the case of a single variable. The infinitesimal operations of the projective group in one variable are $\frac{d}{dx}, x \frac{d}{dx}, x^2 \frac{d}{dx}$. If these combined with $x^3 \frac{d}{dx}$ be

Continuous groups of the line of the plane, and of three-dimensional space.

taken as infinitesimal operations from which to generate a continuous group among the infinitesimal operations of the group, there must occur the combinant of $x \frac{d}{dx}$ and $x^r \frac{d}{dx}$. This is $x^r \frac{d}{dx}$. The combinant of this and $x \frac{d}{dx}$ is $rx \frac{d}{dx}$ and so on. Hence $x^r \frac{d}{dx}$ where r is any positive integer, is an infinitesimal operation of the group. The general infinitesimal operation of the group is therefore $f(x) \frac{d}{dx}$ where $f(x)$ is an arbitrary integral function of x .

In the classification of the groups, projective or non-projective of two or more variables, the distinction between primitive and imprimitive groups immediately presents itself. For groups of the plane the following question arises. Is there or is there not a singly-infinite family of curves $f(x, y) = C$, where C is an arbitrary constant such that every operation of the group interchanges the curves of the family among themselves? In accordance with the previously given definition of imprimitivity, the group is called imprimitive or primitive according as such a set exists or not. In space of three dimensions there are two possibilities; namely, there may either be a singly infinite system of surfaces $F(x, y, z) = C$, which are interchanged among themselves by the operations of the group; or there may be a doubly-infinite system of curves $G(x, y, z) = a, H(x, y, z) = b$, which are so interchanged.

In regard to primitive groups Lie has shown that any primitive group of the plane can, by a suitably chosen transformation, be transformed into one of three definite types of projective groups; and that any primitive group of space of three dimensions can be transformed into one of eight definite types, which, however, cannot all be represented as projective groups in three dimensions.

The results which have been arrived at for imprimitive groups in two and three variables do not admit of any such simple statement.

We shall now explain the conception of contact-transformations and groups of contact-transformations. This conception, like that of continuous groups, owes its origin to

Contact transformations.

Lie. From a purely analytical point of view a contact-transformation may be defined as a point-transformation in $2n+1$ variables, $x_1, x_2, \dots, x_n, p_1, p_2, \dots, p_n$, which leaves unaltered the equation $dx - p_1 dx_1 - p_2 dx_2 - \dots - p_n dx_n = 0$. Such a definition as this, however, gives no direct clue to the geometrical properties of the transformation, nor does it explain the name given.

In dealing with contact-transformations we shall restrict ourselves to space of two or of three dimensions; and it will be necessary to begin with some purely geometrical considerations. An infinitesimal surface-element in space of three dimensions is completely specified, apart from its size, by its position and orientation. If x, y, z are the co-ordinates of some one point of the element, and if p, q, r give the ratios of the direction-cosines of its normal, x, y, z, p, q, r are five quantities which completely specify the element. There are, therefore, ∞^5 surface elements in three-dimensional space. The surface-elements of a surface form a system of ∞^4 elements, for there are ∞^3 points on the surface, and at each a definite surface-element. The surface-elements of a curve form, again, a system of ∞^3 elements, for there are ∞^2 points on the curve, and at each ∞^1 surface-elements containing the tangent to the curve at the point. Similarly the surface-elements which contain a given point clearly form a system of ∞^1 elements. Now each of these systems of ∞^3 surface-elements has the property that if (x, y, z, p, q, r) and $(x+dx, y+dy, z+dz, p+dp, q+dq, r+dr)$ are consecutive elements from any one of them, then $dx - p dx_1 - q dy_1 - r dz_1 = 0$. In fact, for a system of the first kind dx, dy, dz are proportional to the direction-cosines of a tangent line at a point of the surface, and p, q, r are proportional to the direction-cosines of a normal to the surface touching the curve; and for a system of the third kind dx, dy, dz are zero. Now the most general way in which a system of ∞^3 surface-elements can be given is by three independent equations between x, y, z, p, q, r . If these equations do not contain p, q, r , they determine one or more (a finite number in any case) points in space, and the system of surface-elements consists of the elements containing these points; i.e. it consists of one or more systems of the third kind.

If the equations are such that two distinct equations independent of p and q can be derived from them, the points of the system of surface-elements lie on a curve. For such a system the equation $dx - p dx_1 - q dy_1 = 0$ will hold for each two consecutive elements only when the plane of each element touches the curve at its own point.

If the equations are such that only one equation independent of p and q can be derived from them, the points of the system of surface-elements lie on a surface. Again, for such a system the equation $dx - p dx_1 - q dy_1 = 0$ will hold for each two consecutive elements only when each element touches the surface at its own point. Hence, when all possible systems of ∞^3 surface-elements in space are considered, the equation $dx - p dx_1 - q dy_1 = 0$ is characteristic of the three special types in which the elements belong, in the sense explained above, to a point or a curve or a surface.

Let us consider now the geometrical bearing of any transformation $x' = f_1(x, y, z, p, q, r), \dots, y' = f_2(x, y, z, p, q, r)$, of the five variables. It

will interchange the surface-elements of space among themselves, and will change any system of ∞^3 elements into another system of ∞^3 elements. A special system, i.e. a system which belongs to a point, curve or surface, will not, however, in general be changed into another special system. The necessary and sufficient condition that a special system should always be changed into a special system is that the equation $dx - p dx_1 - q dy_1 = 0$ should be a consequence of the equation $dx - p dx_1 - q dy_1 = 0$; or, in other words, that this latter equation should be invariant for the transformation.

When this condition is satisfied the transformation is such as to change the surface-elements of a surface in general into surface-elements of a surface, though in particular cases they may become the surface-elements of a curve or point; and similar statements may be made with respect to a curve or point. The transformation is therefore a veritable geometrical transformation in space of three dimensions. Moreover, two special systems of surface-elements which have an element in common are transformed into two new special systems with an element in common. Hence two curves or surfaces which touch each other are transformed into two new curves or surfaces which touch each other. It is this property which leads to the transformations in question being called contact-transformations. It will be noticed that an ordinary point-transformation is always a contact-transformation, but that a contact-transformation (in space of n dimensions) is not in general a point-transformation (in space of n dimensions), though it may always be regarded as a point-transformation in space of $2n+1$ dimensions. In the analogous theory for space of two dimensions a line-element, defined by (x, y, p) , where p gives the direction-cosines of the line, takes the place of the surface-element; and a transformation of x, y and p which leaves the equation $dy - p dx = 0$ unchanged transforms the ∞^1 line-elements, which belong to a curve, into ∞^1 line-elements which again belong to a curve; while two curves which touch are transformed into two other curves which touch.

One of the simplest instances of a contact-transformation that can be given is the transformation by reciprocal polars. By this transformation a point P and a plane p passing through it are changed into a plane p' and a point P' upon it; i.e. the surface-element defined by P, p is changed into a definite surface-element defined by P', p' . The totality of surface-elements which belong to a (non-developable) surface is known from geometrical considerations to be changed into the totality which belongs to another (non-developable) surface. On the other hand, the totality of the surface-elements which belong to a curve is changed into another set which belong to a developable. The analytical formulae for this transformation, when the reciprocation is effected with respect to the paraboloid $x^2 + y^2 - z^2 = 0$, are $x' = p, y' = q, z' = px + qy - z, p' = x, q' = y$. That this is, in fact, a contact-transformation is verified directly by noticing that $dx' - p' dx_1 - q' dy_1 = -d(x - px - qy) - x dp - y dq = -(dx - p dx_1 - q dy_1) - x dp - y dq$. A second simple example is that in which every surface-element is displaced, without change of orientation, normal to itself through a constant distance t . The analytical equations in this case are easily found in the form

$$x' = x + \frac{pt}{\sqrt{1+p^2+q^2}}, \quad y' = y + \frac{qt}{\sqrt{1+p^2+q^2}}, \quad z' = z - \frac{t}{\sqrt{1+p^2+q^2}}$$

$$p' = p, \quad q' = q.$$

That this is a contact-transformation is seen geometrically by noticing that it changes a surface into a parallel surface. Every point is changed by it into a sphere of radius t , and when t is regarded as a parameter the equations define a cyclical group of contact-transformations.

The formal theory of continuous groups of contact-transformations, is, of course, in no way distinct from the formal theory of continuous groups in general. On what may be called the geometrical side, the theory of groups of contact-transformations has been developed with very considerable detail in the second volume of Lie-Engel.

To the manifold applications of the theory of continuous groups in various branches of pure and applied mathematics it is impossible here to refer in any detail. It must suffice to indicate a few of them very briefly. In some of the older theories a new point of view is obtained which presents the results in a fresh light, and suggests the natural generalization. As an example, the theory of the invariants of a binary form may be considered.

If in the form $f = a_0 x^m + a_1 x^{m-1} y + \dots + a_m y^m$, the variables be subjected to a homogeneous substitution

$$x' = ax + \beta y, \quad y' = \gamma x + \delta y, \quad (i.)$$

and if the coefficients in the new form be represented by accenting the old coefficients, then

$$\left. \begin{aligned} a'_0 &= a_0 a^m + a_1 m a^{m-1} \gamma + \dots + a_m \gamma^m, \\ a'_1 &= a_0 a^{m-1} \beta + a_1 [(m-1) a^{m-2} \beta \gamma + a^{m-3} \delta] + \dots + a_m \gamma^{m-1} \delta, \\ a'_m &= a_m \delta^m + a_{m-1} m \delta^{m-1} \beta + \dots + a_0 \beta^m; \end{aligned} \right\} (ii.)$$

and this is a homogeneous linear substitution performed on the coefficients. The totality of the substitutions, (i.), for which $a\delta - \beta\gamma = 1$, constitutes a continuous group of order 3, which is generated by the two infinitesimal transformations $\gamma \frac{\partial}{\partial \beta}$ and $\beta \frac{\partial}{\partial \gamma}$. Hence with

the same limitations on $\alpha, \beta, \gamma, \delta$ the totality of the substitutions (ii.) forms a simply isomorphic continuous group of order 3, which is generated by the two infinitesimal transformations

$$a_1 \frac{\partial}{\partial x_1} + 2a_2 \frac{\partial}{\partial x_2} + 3a_3 \frac{\partial}{\partial x_3} + \dots + na_{n-1} \frac{\partial}{\partial x_{n-1}}$$

and

$$ma_1 \frac{\partial}{\partial x_1} + (n-1)a_2 \frac{\partial}{\partial x_2} + (n-2)a_3 \frac{\partial}{\partial x_3} + \dots + a_{n-1} \frac{\partial}{\partial x_{n-1}}$$

The invariants of the binary form, i.e. those functions of the coefficients which are unaltered by all homogeneous substitutions on x, y of determinant unity, are therefore identical with the functions of the coefficients which are invariant for the continuous group generated by the two infinitesimal operations last written. In other words, they are given by the common solutions of the differential equations

$$a_1 \frac{\partial f}{\partial x_1} + 2a_2 \frac{\partial f}{\partial x_2} + 3a_3 \frac{\partial f}{\partial x_3} + \dots = 0, \\ ma_1 \frac{\partial f}{\partial x_1} + (n-1)a_2 \frac{\partial f}{\partial x_2} + (n-2)a_3 \frac{\partial f}{\partial x_3} + \dots = 0.$$

Both this result and the method by which it is arrived at are well known, but the point of view by which we pass from the transformation group of the variables to the isomorphic transformation group of the coefficients, and regard the invariants as invariants rather of the group than of the forms, is a new and a fruitful one.

The general theory of curvature of curves and surfaces may in a similar way be regarded as a theory of their invariants for the group of motions. That something more than a mere change of phraseology is here implied will be evident in dealing with minimum curves, i.e. with curves such that at every point of them $dx^2 + dy^2 + dz^2 = 0$. For such curves the ordinary theory of curvature has no meaning, but they nevertheless have invariant properties in regard to the group of motions.

The curvature and torsion of a curve, which are invariant for all transformations by the group of motions, are special instances of what are known as *differential invariants*. If $\xi \frac{\partial}{\partial x} + \eta \frac{\partial}{\partial y}$ is the general infinitesimal transformation of a group of point-transformations in the plane, and if $\gamma_1, \gamma_2, \dots$ represent the successive differential coefficients of y , the infinitesimal transformation may be written in the extended form

$$\xi \frac{\partial}{\partial x} + \eta \frac{\partial}{\partial y} + \eta_1 \frac{\partial}{\partial \gamma_1} + \eta_2 \frac{\partial}{\partial \gamma_2} + \dots$$

where η_1, η_2, \dots are the increments of $\gamma_1, \gamma_2, \dots$. By including a sufficient number of these variables the group must be intrinsically intransitive in them, and must therefore have one or more invariants. Such invariants are known as differential invariants of the original group, being necessarily functions of the differential coefficients of the original variables. For groups of the plane it may be shown that not more than two of these differential invariants are independent, all others being formed from these by algebraical processes and differentiation. For groups of point-transformations in more than two variables there will be more than one set of differential invariants. For instance, with three variables, one may be regarded as independent and the other two as functions of it, or two as independent and the remaining one as a function. Corresponding to these two points of view, the differential invariants for a curve or for a surface will arise.

If a differential invariant of a continuous group of the plane be equated to zero, the resulting differential equation remains unaltered when the variables undergo any transformation of the group. Conversely, if an ordinary, differential equation $f(x, y, \gamma_1, \gamma_2, \dots) = 0$ admits the transformations of a continuous group, i.e. if the equation is unaltered when x and y undergo any transformation of the group, then $f(x, y, \gamma_1, \gamma_2, \dots)$ or some multiple of it must be a differential invariant of the group. Hence it must be possible to find two independent differential invariants α, β of the group, such that when these are taken as variables the differential equation takes the form $F(\alpha, \beta, \frac{d\beta}{d\alpha}, \frac{d^2\beta}{d\alpha^2}, \dots) = 0$. This equation in α, β will be of lower order than the original equation, and in general simpler to deal with. Supposing it solved in the form $\beta = \phi(\alpha)$, where for α, β their values in terms of $x, y, \gamma_1, \gamma_2, \dots$ are written, this new equation, containing arbitrary constants, is necessarily again of lower order than the original equation. The integration of the original equation is thus divided into two steps. This will show how, in the case of an ordinary differential equation, the fact that the equation admits a continuous group of transformations may be taken advantage of for its integration.

The most important of the applications of continuous groups are to the theory of systems of differential equations, both ordinary and partial; in fact, Lie states that it was with a view to systematizing and advancing the general theory of differential equations that he was led to the development of the theory of continuous groups. It is quite impossible here to give any account of all that Lie and his followers have done in this direction. An entirely new mode of regarding the problem of the integration of a differential equation

has been opened up, and in the classification that arises from it all those apparently isolated types of equations which in the older sense are said to be integrable take their proper place. It may, for instance, be mentioned that the question as to whether Monge's method will apply to the integration of a partial differential equation of the second order is shown to depend on whether or not a contact-transformation can be found which will reduce the equation to either $\frac{\partial^2 z}{\partial x^2} = 0$ or $\frac{\partial^2 z}{\partial x \partial y} = 0$. It is in this direction that further advance in the theory of partial differential equations must be looked for. Lastly, it may be remarked that one of the most thorough discussions of the axioms of geometry hitherto undertaken is founded entirely upon the theory of continuous groups.

Discontinuous Groups.

We go on now to the consideration of discontinuous groups. Although groups of finite order are necessarily contained under this general head, it is convenient for many reasons to deal with them separately, and it will therefore be assumed in the present section that the number of operations in the group is not finite. Many large classes of discontinuous groups have formed the subject of detailed investigation, but a general formal theory of discontinuous groups can hardly be said to exist as yet. It will thus be obvious that in considering discontinuous groups it is necessary to proceed on different lines from those followed with continuous groups, and in fact to deal with the subject almost entirely by way of example.

The consideration of a discontinuous group as arising from a set of independent generating operations suggests a purely abstract point of view in which any two simply isomorphic groups are indistinguishable. The number of generating operations may be either finite or infinite, but the former case alone will be here considered. Suppose then that S_1, S_2, \dots, S_n is a set of independent operations from which a group G is generated. The general operation of the group will be represented by the symbol $S_1^{a_1} S_2^{a_2} \dots S_n^{a_n}$ or Σ , where a, b, \dots, d are chosen from 1, 2, ..., n , and $\alpha, \beta, \dots, \delta$ are any positive or negative integers. It may be assumed that no two successive suffixes in Σ are the same, for if $b = a$, then $S_1^{a_1} S_2^{a_2}$ may be replaced by $S_1^{a_1 + a_2}$. If there are no relations connecting the generating operations and the identical operation, every distinct symbol Σ represents a distinct operation of the group. For if $\Sigma = \Sigma_1$, or $S_1^{a_1} S_2^{a_2} \dots S_n^{a_n} = S_1^{a_1} S_2^{a_2} \dots S_n^{a_2}$, then $S_1^{a_1} \dots S_n^{a_n} S_1^{-a_1} S_2^{-a_2} \dots S_n^{-a_n} = 1$; and unless $a = a_1, b = b_1, \dots, c = a_1, \beta = \beta_1, \dots$, this is a relation connecting the generating operations.

Suppose now that T_1, T_2, \dots are operations of G , and that H is that self-conjugate subgroup of G which is generated by T_1, T_2, \dots and the operations conjugate to them. Then, of the operations that can be formed from S_1, S_2, \dots, S_n , the set ΣH , and no others, reduce to the same operation Σ when the conditions $T_1 = 1, T_2 = 1, \dots$ are satisfied by the generating operations. Hence the group which is generated by the given operations, when subjected to the conditions just written, is simply isomorphic with the factor-group G/H . Moreover, this is obviously true even when the conditions are such that the generating operations are no longer independent. Hence any discontinuous group may be defined abstractly, that is, in regard to the laws of combination of its operations apart from their actual form, by a set of generating operations and a system of relations connecting them. Conversely, when such a set of operations and system of relations are given arbitrarily they define in abstract form a single discontinuous group. It may, of course, happen that the group so defined is a group of finite order, or that it reduces to the identical operation only; but in regard to the general statement these will be particular and exceptional cases.

An operation of a discontinuous group must necessarily be specified analytically by a system of equations of the form

$$x'_s = f_s(x_1, x_2, \dots, x_n; a_1, a_2, \dots, a_n), \quad (s = 1, 2, \dots, n),$$

and the different operations of the group will be given by different sets of values of the parameters a_1, a_2, \dots, a_n . No one of these parameters is susceptible of continuous variations, but at least one must be capable of taking a number of values which is not finite, if the group is not one of finite order. Among the sets of values of the parameters there must be one which gives the identical transformation. No other transformation makes each of the differences $x'_s - x_s, x'_2 - x_2, \dots, x'_n - x_n$ vanish. Let d be an arbitrary assigned positive quantity. Then if a transformation of the group can be found such that the modulus of each of these differences is less than d when the variables have arbitrary values within an assigned range of variation, however small d may be chosen, the group is said to be *improperly* discontinuous. In the contrary case the group is called *properly* discontinuous. The range within which the variables are allowed to vary may clearly affect the question whether a given group is properly or improperly discontinuous. For instance, the group

Properly discontinuous group.

defined by the equation $x' = ax + b$, where a and b are any rational numbers, is improperly discontinuous; and the group defined by $x' = x + a$, where a is an integer, is properly discontinuous, whatever the range of the variable. On the other hand, the group, to be later

considered, defined by the equation $x' = \frac{ax+b}{cx+d}$, where a, b, c, d are integers satisfying the relation $ad-bc=1$, is properly discontinuous when x may take any complex value, and improperly discontinuous when the range of x is limited to real values.

Among the discontinuous groups that occur in analysis, a large number may be regarded as arising by imposing limitations on the range of variation of the parameters of continuous groups. If

$$x'_s = f_s(x_1, x_2, \dots, x_n; a_1, a_2, \dots, a_n), \quad (s=1, 2, \dots, m),$$

are the finite equations of a continuous group, and if C with parameters a_1, a_2, \dots, a_n is the operation which results from carrying out A and B with corresponding parameters in succession, then the c 's are determined uniquely by the a 's and the b 's. If the c 's are rational functions of the a 's and b 's, and if the a 's and b 's are arbitrary rational numbers of a given corpus (see NUMERA), the c 's will be rational numbers of the same corpus. If the c 's are rational integral functions of the a 's and b 's, and the latter are arbitrarily chosen integers of a corpus, then the c 's are integers of the same corpus. Hence in the first case the above equations, when the a 's are limited to rational numbers of a given corpus, will define a discontinuous group; and in the second case they will define such a group when the a 's are further limited to be integers of the corpus.

Linear discontinuous groups. A most important class of discontinuous groups are those that arise in this way from the general linear continuous group in a given set of variables. For n variables the finite equations of this continuous group are

$$x'_s = a_{s1}x_1 + a_{s2}x_2 + \dots + a_{sn}x_n, \quad (s=1, 2, \dots, n),$$

where the determinant of the a 's must not be zero. In this case the c 's are clearly integral lineo-linear functions of the a 's and b 's. Moreover, the determinant of the c 's is the product of the determinant of the a 's and the determinant of the b 's. Hence equations (ii), where the parameters are restricted to be integers of a given corpus, define a discontinuous group; and if the determinant of the coefficients is limited to the value unity, they define a discontinuous group which is a (self-conjugate) subgroup of the previous one.

The simplest case which thus presents itself is that in which there are two variables while the coefficients are rational integers. This is the group defined by the equations

$$\begin{cases} x' = ax + by, \\ y' = cx + dy, \end{cases}$$

where a, b, c, d are integers such that $ad-bc=1$. To every operation of this group there corresponds an operation of the set defined by

$$s' = \frac{as+b}{cs+d}$$

in such a way that to the product of two operations of the group there corresponds the product of the two analogous operations of the set. The operations of the set (iv.), where $ad-bc=1$, therefore constitute a group which is isomorphic with the previous group. The isomorphism is multiple, since to a single operation of the second set there correspond the two operations of the first for which a, b, c, d and $-a, -b, -c, -d$ are parameters. These two groups, which are of fundamental importance in the theory of quadratic forms and in the theory of modular functions, have been the object of very many investigations.

Another large class of discontinuous groups, which have far-reaching applications in analysis, are those which arise in the first instance from purely geometrical considerations. By the

Discontinuous groups arising from geometrical operations.

combination and repetition of a finite number of geometrical operations such as displacements, projective transformations, inversions, &c., a discontinuous group of such operations will arise. Such a group, as regards the points of the plane (or of space), will in general be improperly discontinuous; but when the generating operations are suitably chosen, the group may be properly discontinuous. In the latter case the group may be represented in a graphical form by the division of the plane (or space) into regions such that no point of one region can be transformed into another point of the same region by any operation of the group, while any given region can be transformed into any other by a suitable transformation. Thus, let ABC be a triangle bounded by three circular arcs BC, CA, AB; and consider the figure produced from ABC by inversions in the three circles of which BC, CA, AB are part. By inversion at BC, ABC becomes an equiangular triangle A'BC. An inversion in AB changes ABC and A'BC into equiangular triangles ABC' and A'BC'. Successive inversions at AB and BC then will change ABC into a series of equiangular triangles with B for a common vertex. These will not overlap and will just fill in the space round B if the angle ABC is a submultiple of two right angles. If then the angles of ABC are submultiples of two right angles (or zero), the triangles formed by any number of inversions will never overlap, and to each operation consisting of a definite series of inversions at BC, CA and AB will correspond a distinct triangle into which ABC is changed by the operation. The network of triangles so

formed gives a graphical representation of the group that arises from the three inversions in BC, CA, AB. The triangles may be divided into two sets, those, namely, like A'BC', which are derived from ABC by an even number of inversions, and those like A'BC or ABC' produced by an odd number. Each set are interchanged among themselves by any even number of inversions. Hence the operations consisting of an even number of inversions form a group by themselves. For this group the quadrilateral formed by ABC and A'BC constitutes a region, which is changed by every operation of the group into a distinct region (formed of two adjacent triangles), and these regions clearly do not overlap. Their distribution presents in a graphical form the group that arises by pairs of inversions at BC, CA, AB; and this group is generated by the operation which consists of successive inversions at AB, BC and that which consists of successive inversions at BC, CA. The group defined thus geometrically may be presented in many analytical forms. If x, y and x', y' are the rectangular coordinates of two points which are inverse to each other with respect to a given circle, x' and y' are rational functions of x and y , and conversely. Thus the group may be presented in a form in which each operation gives a birational transformation of two variables. If $x+iy=z, x'+iy'=z'$, and if x', y' is the point to which x, y is transformed by any even number of inversions, then z' and z are connected

by a linear relation $z' = \frac{az+\beta}{\gamma z+\delta}$, where a, b, γ, δ are constants (in general complex) depending on the circles at which the inversions are taken. Hence the group may be presented in the form of a group of linear transformations of a single variable generated by the two

$$\text{linear transformations } z' = \frac{az+\beta}{\gamma z+\delta}, \quad z' = \frac{az+\beta}{\gamma z+\delta}$$

to pairs of inversions at AB, BC and BC, CA respectively. In particular, if the sides of the triangle are taken to be $x=0, x^2+y^2-1=0, x^2+y^2+2x=0$, the generating operations are found to be $z' = z+1, z' = -z^{-1}$; and the group is that consisting of all transformations of the form $z' = \frac{az+b}{cz+d}$ where $ad-bc=1, a, b, c, d$ being integers. This is the group already mentioned which underlies the theory of the elliptic modular functions; a modular function being a function of z which is invariant for some subgroup of finite index of the group in question.

The triangle ABC from which the above geometrical construction started may be replaced by a polygon whose sides are circles. If each angle is a submultiple of two right angles or zero, the construction is still effective to give a set of non-overlapping regions, which represent graphically the group which arises from pairs of inversions in the sides of the polygon. In their analytical form, as groups of linear transformations of a single variable, the groups are those on which the theory of automorphic functions depends. A similar construction in space, the polygons bounded by circular arcs being replaced by polyhedra bounded by spherical faces, has been used by F. Klein and Fricke to give a geometrical representation for groups which are improperly discontinuous when represented as groups of the plane.

The special classes of discontinuous groups that have been dealt with in the previous paragraphs arise directly from geometrical considerations. As a final example we shall refer briefly to a class of groups whose origin is essentially analytical.

Group of a linear differential equation.

$$\text{Let } \frac{d^2y}{dx^2} + P_1 \frac{dy}{dx} + P_2 y = 0 \dots + P_{n-1} \frac{dy}{dx} + P_n y = 0$$

be a linear differential equation, the coefficients in which are rational functions of x , and let y_1, y_2, \dots, y_n be a linearly independent set of integrals of the equation. In the neighbourhood of a finite value x_0 of x , which is not a singularity of any of the coefficients in the equation, these integrals are ordinary power-series in $x-x_0$. If the analytical continuations of y_1, y_2, \dots, y_n be formed for any closed path starting from and returning to x_0 , the final values arrived at when x_0 is again reached will be another set of linearly independent integrals. When the closed path contains no singular point of the coefficients of the differential equation, the new set of integrals is identical with the original set. If, however, the closed path encloses one or more singular points, this will not in general be the case. Let y'_1, y'_2, \dots, y'_n be the new integrals arrived at. Since in the neighbourhood of x_0 every integral can be represented linearly in terms of y_1, y_2, \dots, y_n , there must be a system of equations

$$\begin{cases} y'_1 = a_{11}y_1 + a_{12}y_2 + \dots + a_{1n}y_n, \\ y'_2 = a_{21}y_1 + a_{22}y_2 + \dots + a_{2n}y_n, \\ \dots \\ y'_n = a_{n1}y_1 + a_{n2}y_2 + \dots + a_{nn}y_n, \end{cases}$$

where the a 's are constants, expressing the new integrals in terms of the original ones. To each closed path described by x_0 there therefore corresponds a definite linear substitution performed on the y 's. Further, if S_1 and S_2 are the substitutions that correspond to two closed paths L_1 and L_2 , then to any closed path which can be continuously deformed, without crossing a singular point, into L_1 followed by L_2 , there corresponds the substitution $S_2 S_1$. Let L_1, L_2, \dots, L_r be arbitrarily chosen closed paths starting from and returning to the same point, and each of them enclosing a single one of the

(r) finite singular points of the equation. Every closed path in the plane can be formed by combinations of these r paths taken either in the positive or in the negative direction. Also a closed path which does not cut itself, and encloses all the r singular points within it, is equivalent to a path enclosing the point at infinity and no finite singular point. If $S_1, S_2, S_3, \dots, S_r$ are the linear substitutions that correspond to these r paths, then the substitution corresponding to every possible path can be obtained by combination and repetition of these r substitutions, and they therefore generate a discontinuous group each of whose operations corresponds to a definite closed path. The group thus arrived at is called the group of the equation. For a given equation it is unique in type. In fact, the only effect of starting from another set of independent integrals is to transform every operation of the group by an arbitrary substitution, while choosing a different set of paths is equivalent to taking a new set of generating operations. The great importance of the group of the equation in connexion with the nature of its integrals cannot here be dealt with, but it may be pointed out that if all the integrals of the equation are algebraic functions, the group must be a group of finite order, since the set of quantities $\gamma_1, \gamma_2, \dots, \gamma_n$ can then only take a finite number of distinct values.

Groups of Finite Order.

We shall now pass on to groups of finite order. It is clear that here we must have to do with many properties which have no direct analogues in the theory of continuous groups or in that of discontinuous groups in general; those properties, namely, which depend on the fact that the number of distinct operations in the group is finite.

Let $S_1, S_2, S_3, \dots, S_N$ denote the operations of a group G of finite order N , S_1 being the identical operation. The tableau

$$\begin{array}{ccccccc} S_1 & S_2 & S_3 & \dots & S_N \\ S_1 S_1 & S_1 S_2 & S_1 S_3 & \dots & S_1 S_N \\ S_2 S_1 & S_2 S_2 & S_2 S_3 & \dots & S_2 S_N \\ \dots & \dots & \dots & \dots & \dots \\ S_N S_1 & S_N S_2 & S_N S_3 & \dots & S_N S_N \end{array}$$

when in it each compound symbol $S_i S_j$ is replaced by the single symbol S_k that is equivalent to it, is called the multiplication table of the group. It indicates directly the result of multiplying together in an assigned sequence any number of operations of the group. In each line (and in each column) of the tableau every operation of the group occurs just once. If the letters in the tableau are regarded as mere symbols, the operation of replacing each symbol in the first line by the symbol which stands under it in the i th line is a permutation performed on the set of N symbols. Thus to the N lines of the tableau there corresponds a set of N permutations performed on the N symbols, which includes the identical permutation that leaves each unchanged. Moreover, if $S_i S_j = S_k$, then the result of carrying out in succession the permutations which correspond to the i th and j th lines gives the permutation which corresponds to the k th line. Hence the set of permutations constitutes a group which is simply isomorphic with the given group.

Every group of finite order N can therefore be represented in concrete form as a transitive group of permutations on N symbols.

The order of any subgroup or operation of G is necessarily finite. If $T_1 (=S_1), T_2, \dots, T_n$ are the operations of a subgroup H of G , and if Z is any operation of G which is not contained in H , the set of operations ZT_1, ZT_2, \dots, ZT_n , or ZH , are all distinct from each other and from the operations of H . If the sets H and ZH do not exhaust the operations of G , and if Z' is an operation not belonging to them, then the operations of the set $Z'H$ are distinct from each other and from those of H and ZH . This process may be continued till the operations of G are exhausted. The order π of H must therefore be a factor of the order N of G . The ratio N/π is called the *index* of the subgroup H . By taking for H the cyclical subgroup generated by any operation S of G , it follows that the order of S must be a factor of the order of G .

Every operation S is permutable with its own powers. Hence there must be some subgroup H of G of greatest possible order, such that every operation of H is permutable with S . Every operation of H transforms S into itself, and every operation of the set HZ transforms S into the same operation. Hence, when S is transformed by every operation of G , just N/π distinct operations arise if π is the order of H . These operations, and no others, are conjugate to S within G ; they are said to form a set of conjugate operations. The number of operations in every conjugate set is therefore a factor of the order of G . In the same way it may be shown that the number of subgroups which are conjugate to a given subgroup is a factor of the order of G . An operation which is permutable with every operation of the group is called a *self-conjugate* operation. The totality of the self-conjugate operations of a group forms a self-conjugate Abelian subgroup, each of whose operations is permutable with every operation of the group.

An Abelian group contains subgroups whose orders are any given factors of the order of the group. In fact, since every subgroup H

of an Abelian group G and the corresponding factor groups G/H are Abelian, this result follows immediately by an induction from the case in which the order contains π prime factors to that in which it contains $\pi+1$. For a group which is not Abelian no general law can be stated as to the existence or non-existence of a subgroup whose order is an arbitrarily assigned factor of the order of the group. In this connexion the most important general result, which is independent of any supposition as to the order of the group, is known as Sylow's theorem, which states that if p^α is the highest power of a prime p which divides the order of a group G , then G contains a single conjugate set of subgroups of order p^α , the number in the set being of the form $1+kp$. Sylow's theorem may be extended to show that if p^α is a factor of the order of a group, the number of subgroups of order p^α is of the form $1+kp$. If, however, p^α is not the highest power of p which divides the order, these groups do not in general form a single conjugate set.

The importance of Sylow's theorem in discussing the structure of a group of given order need hardly be insisted on. Thus, as a very simple instance, a group whose order is the product $p_1 p_2$ of two primes ($p_1 < p_2$) must have a self-conjugate subgroup of order p_2 , since the order of the group contains no factor, other than unity, of the form $1+kp_2$. The same again is true for a group of order $p_1^2 p_2$, unless $p_1=2$, and $p_2=3$.

There is one other numerical property of a group connected with its order which is quite general. If N is the order of G , and π a factor of N , the number of operations of G , whose orders are equal to or are factors of π , is a multiple of π .

As already defined, a composite group is a group which contains one or more self-conjugate subgroups, whose orders are greater than unity. If H is a self-conjugate subgroup of G , the factor-group G/H may be either simple or composite. In the former case G can contain no self-conjugate subgroup K , which itself contains H ; for if it did K/H would be a self-conjugate subgroup of G/H . When G/H is simple, H is said to be a maximum self-conjugate subgroup of G . Suppose now that G being a given composite group, G, G_1, G_2, \dots, G_n , is a series of subgroups of G , such that each is a maximum self-conjugate subgroup of the preceding; the last term of the series consisting of the identical operation only. Such a series is called a *composition-series* of G . In general it is not unique, since a group may have two or more maximum self-conjugate subgroups. A composition-series of a group, however it may be chosen, has the property that the number of terms of which it consists is always the same, while the factor-groups $G/G_1, G_1/G_2, \dots, G_n$ differ only in the sequence in which they occur. It should be noticed that though a group defines uniquely the set of factor-groups that occur in its composition-series, the set of factor-groups do not conversely in general define a single type of group. When the orders of all the factor-groups are primes the group is said to be *soluble*.

If the series of subgroups $G, H, K, \dots, L, 1$ is chosen so that each is the greatest self-conjugate subgroup of G contained in the previous one, the series is called a *chief composition-series* of G . All such series derived from a given group may be shown to consist of the same number of terms, and to give rise to the same set of factor-groups, except as regards sequence. The factor-groups of such a series will not, however, necessarily be simple groups. From any chief composition-series a composition-series may be formed by interpolating between any two terms H and K of the series for which H/K is not a simple group, a number of terms $h_1/h_2, \dots, h_r/h_{r+1}$; and it may be shown that the factor-groups $H/h_1, h_1/h_2, \dots, h_r/h_{r+1}$ are all simply isomorphic with each other.

A group may be represented as isomorphic with itself by transforming all its operations by any one of them. In fact, if $S_i S_j = S_k$, then $S_i^{-1} S_i S_j S_i^{-1} = S_i^{-1} S_k S_i$. An isomorphism of the group with itself, established in this way, is called an *inner isomorphism*. It may be regarded as an operation carried out on the symbols of the operations, being indeed a permutation performed on these symbols. The totality of these operations clearly constitutes a group isomorphic with the given group, and this group is called the group of inner isomorphisms. A group is simply or multiply isomorphic with its group of inner isomorphisms according as it does not or does contain self-conjugate operations other than identity. It may be possible to establish a correspondence between the operations of a group other than those given by the inner isomorphisms, such that if S' is the operation corresponding to S , then $S' S' = S$; is a consequence of $S_i S_j = S_k$. The substitution on the symbols of the operations of a group resulting from such a correspondence is called an *outer isomorphism*. The totality of the isomorphisms of both kinds constitutes the group of isomorphisms of the given group, and within this the group of inner isomorphisms is a self-conjugate subgroup. Every set of conjugate operations of a group is necessarily transformed into itself by an inner isomorphism, but two or more sets may be interchanged by an outer isomorphism.

A subgroup of a group G , which is transformed into itself by every isomorphism of G , is called a *characteristic* subgroup. A series of groups $G, G_1, G_2, \dots, 1$, such that each is a maximum characteristic subgroup of G contained in the preceding, may be shown to have the same invariant properties as the subgroups of a composition series. A group which has no characteristic subgroup must be either a simple

group or the direct product of a number of simply isomorphic simple groups.

It has been seen that every group of finite order can be represented as a group of permutations performed on a set of symbols whose number is equal to the order of the group. In general such a representation is possible with a smaller number of symbols. Let H be a subgroup of G , and let the operations of G be divided, in respect of H , into the sets $H, S_1H, S_2H, \dots, S_rH$. If S is any operation of G , the sets $SH, S_1SH, S_2SH, \dots, S_rSH$ differ from the previous sets only in the sequence in which they occur. In fact, if SS_1 belong to the set S_1H , then since H is a group, the set SS_1H is identical with the set S_1H . Hence, to each operation S of the group will correspond a permutation performed on the symbols of the m sets, and to the product of two operations corresponds the product of the two analogous permutations. The set of permutations, therefore, forms a group isomorphic with the given group. Moreover, the isomorphism is simple unless for one or more operations, other than identity, the sets all remain unaltered. This can only be the case for S , when every operation conjugate to S belongs to H . In this case H would contain a self-conjugate subgroup, and the isomorphism is multiple.

The fact that every group of finite order can be represented, generally in several ways, as a group of permutations, gives special importance to such groups. The number of symbols involved in such a representation is called the *degrees* of the group. In accordance with the general definitions already given, a permutation-group is called transitive or intransitive according as it does or does not contain permutations changing any one of the symbols into any other. It is called imprimitive or primitive according as the symbols can or cannot be arranged in sets, such that every permutation of the group changes the symbols of any one set either among themselves or into the symbols of another set. When a group is imprimitive the number of symbols in each set must clearly be the same.

The total number of permutations that can be performed on n symbols is $n!$, and these necessarily constitute a group. It is known as the *symmetric group of degree n* , the only rational functions of the symbols which are unaltered by all possible permutations being the symmetric functions. When any permutation is carried out on the product of the $n(n-1)/2$ differences of the n symbols, it must either remain unaltered or its sign must be changed. Those permutations which leave the product unaltered constitute a group of order $n!/2$, which is called the *alternating group of degree n* ; it is a self-conjugate subgroup of the symmetric group. Except when $n=4$ the alternating group is a simple group. A group of degree n , which is not contained in the alternating group, must necessarily have a self-conjugate subgroup of index 2, consisting of those of its permutations which belong to the alternating group.

Among the various concrete forms in which a group of finite order can be presented the most important is that of a group of linear substitutions. Such groups have already been referred to in connexion with discontinuous groups. Here the number of distinct substitutions is necessarily finite; and to each operation S of a group G of finite order there will correspond a linear substitution s , viz.

$$x_i = \sum_{j=1}^m s_{ij} x_j, (i, j = 1, 2, \dots, m),$$

on a set of m variables, such that if $ST=U$, then $st=us$. The linear substitutions s, t, u, \dots then constitute a group g with which G is isomorphic; and whether the isomorphism is simple or multiple g is said to give a "representation" of G as a group of linear substitutions. If all the substitutions of g are transformed by the same substitution on the m variables, the (in general) new group of linear substitutions so constituted is said to be "equivalent" with g as a representation of G ; and two representations are called "non-equivalent," or "distinct," when one is not capable of being transformed into the other.

A group of linear substitutions on m variables is said to be "reducible" when it is possible to choose m' ($< m$) linear functions of the variables which are transformed among themselves by every substitution of the group. When this cannot be done the group is called "irreducible." It can be shown that a group of linear substitutions, of finite order, is always either irreducible, or such that the variables, when suitably chosen, may be divided into sets, each set being irreducibly transformed among themselves. This being so, it is clear that when the irreducible representations of a group of finite order are known, all representations may be built up.

It has been seen at the beginning of this section that every group of finite order N can be presented as a group of permutations (i.e. linear substitutions in a limited sense) on N symbols. This group is obviously reducible; in fact, the sum of the symbols remain unaltered by every substitution of the group. The fundamental theorem in connexion with the representations, as an irreducible group of linear substitutions, of a group of finite order N is the following.

If r is the number of different sets of conjugate operations in the group, then, when the group of N permutations is completely reduced,

(i.) just r distinct irreducible representations occur;

(ii.) each of these occurs a number of times equal to the number of symbols on which it operates;

(iii.) these irreducible representations exhaust all the distinct irreducible representations of the group.

Among these representations what is called the "identical" representation necessarily occurs, i.e. that in which each operation of the group corresponds to leaving a single symbol unchanged. If these representations are denoted by $\Gamma_1, \Gamma_2, \dots, \Gamma_r$, then any representation of the group as a group of linear substitutions, or in particular as a group of permutations, may be uniquely represented by a symbol $\Sigma a_i \Gamma_i$, in the sense that the representation when completely reduced will contain the representation Γ_i just a_i times for each suffix i .

A representation of a group of finite order as an irreducible group of linear substitutions may be presented in an infinite number of equivalent forms. If

$$x'_j = \sum_{i=1}^m s_{ji} x_i, (j = 1, 2, \dots, m),$$

is the linear substitution which, in a given irreducible representation of a group of finite order G , corresponds to the operation S , the determinant

$$\begin{vmatrix} s_{11}-\lambda & s_{12} & \dots & s_{1m} \\ s_{21} & s_{22}-\lambda & \dots & s_{2m} \\ \dots & \dots & \dots & \dots \\ s_{m1} & s_{m2} & \dots & s_{mm}-\lambda \end{vmatrix}$$

is invariant for all equivalent representations, when written as a polynomial in λ . Moreover, it has the same value for S and S' , if these are two conjugate operations in G . Of the various invariants that thus arise the most important is $s_{11} + s_{22} + \dots + s_{mm}$, which is called the "characteristic" of S . If S is an operation of order p , its characteristic is the sum of m p th roots of unity; and in particular, if S is the identical operation its characteristic is m . If r is the number of sets of conjugate operations in G , there is, for each representation of G as an irreducible group, a set of r characteristics X_1, X_2, \dots, X_r , one corresponding to each conjugate set; so that for the r irreducible representations just r such sets of characteristics arise. These are distinct, in the sense that if $\Psi_1, \Psi_2, \dots, \Psi_r$ are the characteristics for a distinct representation from the above, then X_i and Ψ_i are not equal for all values of the suffix i . It may be the case that the r characteristics for a given representation are all real. If this is so the representation is said to be self-inverse. In the contrary case there is always another representation, called the "inverse" representation, for which each characteristic is the conjugate imaginary of the corresponding one in the original representation. The characteristics are subject to certain remarkable relations. If h_p denotes the number of operations in the p th conjugate set, while X'_p and X''_p are the characteristics of the p th conjugate set in Γ_1 and Γ_2 , then

$$\sum_{i=1}^r h_i X'_i X''_i = 0 \text{ or } n,$$

according to Γ_1 and Γ_2 are not or are inverse representations, n being the order of G .

Again

$$\sum_{i=1}^r h_i X'_i X'_i = 0 \text{ or } n/h_p$$

according as the p th and q th conjugate sets are not or are inverse; the q th set being called the inverse of the p th if it consists of the inverses of the operations constituting the p th.

Another form in which every group of finite order can be represented is that known as a linear homogeneous group. If in the equations

$$x'_r = a_{r1} x_1 + a_{r2} x_2 + \dots + a_{rm} x_m, (r = 1, 2, \dots, m),$$

which define a linear homogeneous substitution, the coefficients are integers, and if the equations are replaced by congruences to a finite modulus n , the system of congruences will give a definite operation, provided that the determinant of the coefficients is relatively prime to n . The product of two such operations is another operation of the same kind; and the total number of distinct operations is finite, since there is only a limited number of choices for the coefficients. The totality of these operations, therefore, constitutes a group of finite order; and such a group is known as a *linear homogeneous group*. If n is a prime the order of the group is

$$(n^m - 1)(n^m - n) \dots (n^m - n^{m-1}).$$

The totality of the operations of the linear homogeneous group for which the determinant of the coefficients is congruent to unity forms a subgroup. Other subgroups arise by considering those operations which leave a function of the variables unchanged (mod. n). All such subgroups are known as linear homogeneous groups.

When the ratios only of the variables are considered, there arises a *linear fractional group*, with which the corresponding linear homogeneous group is isomorphic. Thus, if p is a prime the totality of the congruences

$$x' = \frac{ax+by}{cx+d}, ad-bc \neq 0, \text{ (mod. } p)$$

constitutes a group of order $p(p-1)$. This class of groups for various values of p is almost the only one which has been as yet exhaustively analysed. For all values of p except 3 it contains a simple self-conjugate subgroup of index 2.

A great extension of the theory of linear homogeneous groups has been made in recent years by considering systems of congruences of the form

$$x^r = a_{r1}x_1 + a_{r2}x_2 + \dots + a_{rm}x_m \quad (r = 1, 2, \dots, m),$$

in which the coefficients a_{rs} are integral functions with real integral coefficients of a root of an irreducible congruence to a prime modulus. Such a system of congruences is obviously limited in numbers and defines a group which contains as a subgroup the group defined by the same congruences with ordinary integral coefficients.

The chief application of the theory of groups of finite order is to the theory of algebraic equations. The analogy of equations of the second, third and fourth degrees would give rise to the expectation that a root of an equation of any finite degree could be expressed in terms of the coefficients by a finite number of the operations of addition, subtraction, multiplication, division, and the extraction of roots; in other words, that the equation could be solved by radicals. This, however, as proved by Abel and Galois, is not the case: an equation of a higher degree than the fourth in general defines an algebraic irrationality which cannot be expressed by means of radicals, and the cases in which such an equation can be solved by radicals must be regarded as exceptional. The theory of groups gives the means of determining whether an equation comes under this exceptional case, and of solving the equation when it does. When it does not, the theory provides the means of reducing the problem presented by the equation to a normal form. From this point of view the theory of equations of the fifth degree has been exhaustively treated, and the problems presented by certain equations of the sixth and seventh degrees have actually been reduced to normal form.

Galois (see EQUATION) showed that, corresponding to every irreducible equation of the n th degree, there exists a transitive substitution-group of degree n , such that every function of the roots, the numerical value of which is unaltered by all the substitutions of the group can be expressed rationally in terms of the coefficients, while conversely every function of the roots which is expressible rationally in terms of the coefficients is unaltered by the substitutions of the group. This group is called the group of the equation. In general, if the equation is given arbitrarily, the group will be the symmetric group. The necessary and sufficient condition that the equation may be soluble by radicals is that its group should be a soluble group. When the coefficients in an equation are rational integers, the determination of its group may be made by a finite number of processes each of which involves only rational arithmetical operations. These processes consist in forming resolvents of the equation corresponding to each distinct type of subgroup of the symmetric group whose degree is that of the equation. Each of the resolvents so formed is then examined to find whether it has rational roots. The group corresponding to any resolvent which has a rational root contains the group of the equation; and the least of the groups so found is the group of the equation. Thus, for an equation of the fifth degree the various transitive subgroups of the symmetric group of degree five have to be considered. These are (i.) the alternating group; (ii.) a soluble group of order 20; (iii.) a group of order 10, self-conjugate in the preceding; (iv.) a cyclical group of order 5, self-conjugate in both the preceding. If x_0, x_1, x_2, x_3, x_4 are the roots of the equation, the corresponding resolvents may be taken to be those which have for roots (i.) the square root of the discriminant; (ii.) the function $(x_0x_1 + x_0x_2 + x_0x_3 + x_0x_4 + x_1x_2 + x_1x_3 + x_1x_4 + x_2x_3 + x_2x_4 + x_3x_4)$; (iii.) the function $x_0x_1 + x_1x_2 + x_2x_3 + x_3x_4 + x_4x_0$; and (iv.) the function $x_0^2x_1 + x_1^2x_2 + x_2^2x_3 + x_3^2x_4 + x_4^2x_0$. Since the groups for which (iii.) and (iv.) are invariant are contained in that for which (ii.) is invariant, and since these are the only soluble groups of the set, the equation will be soluble by radicals only when the function (ii.) can be expressed rationally in terms of the coefficients. If

$$(x_0x_1 + x_1x_2 + x_2x_3 + x_3x_4 + x_4x_0)(x_0x_1 + x_1x_2 + x_2x_3 + x_3x_4)$$

is known, then clearly $x_0x_1 + x_1x_2 + x_2x_3 + x_3x_4 + x_4x_0$ can be determined by the solution of a quadratic equation. Moreover, the sum and product $(x_0 + x_1 + x_2 + x_3 + x_4)^2$ and $(x_0 + x_1 + x_2 + x_3 + x_4)(x_0^2 + x_1^2 + x_2^2 + x_3^2 + x_4^2)$ can be expressed rationally in terms of $x_0x_1 + x_1x_2 + x_2x_3 + x_3x_4 + x_4x_0$, ϵ , and the symmetric functions; ϵ being a fifth root of unity. Hence $(x_0 + x_1 + x_2 + x_3 + x_4)^2$ can be determined by the solution of a quadratic equation. The roots of the original equation are then finally determined by the extraction of a fifth root. The problem of reducing an equation of the fifth degree, when not soluble by radicals, to a normal form, forms the subject of Klein's *Vorlesungen über das Ikosaeder*. Another application of groups of finite order is to the theory of linear differential equations whose integrals are algebraic functions. It has been already seen, in the discussion of discontinuous groups in general, that the groups of such equations must be groups of finite order. To every group of finite order which can be represented as an irreducible group of linear substitutions on n variables will correspond a class of irreducible linear differential equations of the n th order whose integrals are algebraic. The complete determination of the class of linear differ-

ential equations of the second order with all their integrals algebraic, whose group has the greatest possible order, viz. 120, has been carried out by Klein.

AUTHORITIES.—Continuous groups: Lie and Engel, *Theorie der Transformationsgruppen* (Leipzig, vol. i., 1888; vol. ii., 1890; vol. iii., 1893); Lie and Schiefers, *Vorlesungen über gewöhnliche Differentialgleichungen mit bekanntem infinitesimalen Transformationen* (Leipzig, 1891); *Idem, Vorlesungen über kontinuierliche Gruppen* (Leipzig, 1893); *Idem, Geometrie der Berührungstransformationen* (Leipzig, 1896); Klein and Schilling, *Höhere Geometrie*, vol. ii. (lithographed) (Göttingen, 1893), for both continuous and discontinuous groups); Campbell, *Introductory Treatise on Lie's Theory of Finite Continuous Transformation Groups* (Oxford, 1903). Discontinuous groups: Klein and Fricke, *Vorlesungen über das Theorie der elliptischen Modulfunktionen* (vol. i., Leipzig, 1890) (for a full discussion of the modular group); *Idem, Vorlesungen über die Theorie der automorphen Funktionen* (vol. i., Leipzig, 1897; vol. ii. pt. i., 1901) (for the general theory of discontinuous groups); Schoenflies, *Kristallsysteme und Kristallstruktur* (Leipzig, 1891) (for discontinuous groups of motions); Groups of finite order: Galois, *Œuvres mathématiques* (Paris, 1897, reprint); Jordan, *Traité des substitutions et des équations algébriques* (Paris, 1870); Netto, *Substitutionentheorie und ihre Anwendung auf die Algebra* (Leipzig, 1882; Eng. trans. by Cole, Ann Arbor, U.S.A., 1892); Klein, *Vorlesungen über das Ikosaeder* (Leipzig, 1884; Eng. trans. by Morrice, London, 1888); H. Vogt, *Leçons sur la résolution algébrique des équations* (Paris, 1895); Weber, *Lehrbuch der Algebra* (Braunschweig, vol. i., 1895; vol. ii., 1896; a second edition appeared in 1898); Burnside, *Theory of Groups of Finite Order* (Cambridge, 1897); Bianchi, *Teoria dei gruppi di sostituzioni e delle equazioni algebriche* (Pisa, 1899); Dickson, *Linear Groups with an Exposition of the Galois Field Theory* (Leipzig, 1901); De Séguier, *Éléments de la théorie des groupes abstraits* (Paris, 1904). A summary with many references will be found in the *Encyclopædie der mathematischen Wissenschaften* (Leipzig, vol. i., 1898, 1899).

GROUSE, a word of uncertain origin,¹ now used generally by ornithologists to include all the "rough-footed" Gallinaceous birds, but in common speech applied almost exclusively, when used alone, to the *Tetrao scoticus* of Linnaeus, the *Lagopus scoticus* of modern systematists—more particularly called in English the red grouse, but till the end of the 18th century almost invariably spoken of as the Moor-fowl or Moor-game. The effect which this species is supposed to have had on the British legislature, and therefore on history, is well known, for it was the common belief that parliament always rose when the season for grouse-shooting began (August 12th); while according to the *Orkneyinga Saga* (ed. Jonaeus, p. 356; ed. Anderson, p. 168) events of some importance in the annals of North Britain followed from its pursuit in Caithness in the year 1157.

The red grouse is found on moors from Monmouthshire and Derbyshire northward to the Orkneys, as well as in most of the Hebrides. It inhabits similar situations throughout Wales and Ireland, but it does not naturally occur beyond the limits of the British Islands,² and is the only species among birds peculiar to them. The word "species" may in this case be used advisedly (since the red grouse invariably "breeds true," it admits of an easy diagnosis, and it has a definite geographical range); but scarcely any zoologist can doubt of its common origin with the willow-grouse, *Lagopus albus* (L. *subalpinus* or *L. saliceti* of some authors), that inhabits a subarctic zone from Norway across the

¹ It seems first to occur (O. Salusbury Breverton, *Archæologia*, iii. 157) as "grows" in an ordinance for the regulation of the royal household dated "apud Eltham, mens. Jan. 22 Hen. VIII.," i.e. 1531, and considering the locality must refer to black game. It is found in an Act of Parliament 1 Jac. I. cap. 27, § 2, i.e. 1603, and, as reprinted in the *Statutes at Large*, stands as now commonly spelt, but by many writers or printers the final *e* was omitted in the 17th and 18th centuries. In 1611 Cotgrave had "Poule griesche. A Moore-henne; the benne of the *Grice* [in ed. 1673 "Griece"] or Mooregame" (*Dictionary of the French and English Tongues*, s.v. *Poule*). The most likely derivation seems to be from the old French word *griesche*, *grieche* or *grisais* (meaning speckled, and cognate with *grisus*, grisly or grey), which was applied to some kind of partridge, or according to Brunetto Latini (*Trés.* p. 211) to a quail, "porce que ele fu premiers trovée en Grece." The Oxford Dictionary repudiates the possibility of "grouse" being a spurious singular of an alleged plural "grice," and, with regard to the possibility of "grows" being a plural of "grow," refers to Giraldus Cambrensis (c. 1210), *Topogr. Hib. opera* (Rolls) v. 47: "gallinæ campestris, quas vulgariter *grutas* vocant."

² It was successfully, though with much trouble, introduced by Mr. Oscar Dickson on a tract of land near Gottenburg in Sweden (*Soenska Jagarförbundets Nya Tidsskrift*, 1868, p. 64 *et alibi*).

continents of Europe and Asia, as well as North America from the Aleutian Islands to Newfoundland. The red grouse indeed is rarely or never found away from the heather on which chiefly it subsists; while the willow-grouse in many parts of the Old World seems to prefer the scrubby growth of berry-bearing plants (*Vaccinium* and others) that, often thickly interpersed with willows and birches, clothes the higher levels or the lower mountain-slopes, and it flourishes in the New World where heather scarcely exists, and a "heath" in its strict sense is unknown. It is true that the willow-grouse always becomes white in winter, which the red grouse never does; but in summer there is a considerable resemblance between the two species, the cock willow-grouse having his head, neck and breast of nearly the same rich chestnut-brown as his British representative, and, though his back be lighter in colour, as is also the whole plumage of his mate, than is found in the red grouse, in other respects the two species are precisely alike. No distinction can be discovered

only the highest and most barren mountains. It is said to have formerly inhabited both Wales and England, but there is no evidence of its appearance in Ireland. On the continent of Europe it is found most numerous in Norway, but at an elevation far above the growth of trees, and it occurs on the Pyrenees and on the Alps. It also inhabits northern Russia.



Red Grouse.

in their voice, their eggs, their build, nor in their anatomical details, so far as these have been investigated and compared. Moreover, the red grouse, restricted as is its range, varies in colour not inconsiderably according to locality.

Though the red grouse does not, after the manner of other members of the genus *Lagopus*, become white in winter, Scotland possesses a species of the genus which does. This is the ptarmigan, *L. mutus* or *L. alpinus*, which differs far more in structure, station and habits from the red grouse than that does from the willow-grouse, and in Scotland is far less abundant, haunting

A very interesting subject for discussion would be whether *Lagopus scoticus* or *L. albus* has varied most from the common stock of both. Looking to the fact that the former is the only species of the genus which does not assume white clothing in winter, an evolutionist might at first deem the variation greatest in its case; but then it must be borne in mind that the species of *Lagopus* which turn white differ in that respect from all other groups of the family *Tetraonidae*. Furthermore every species of *Lagopus* (even *L. leucurus*, the whitest of all) has its first set of *remiges* coloured brown. These are dropped when the bird is about half-grown, and in all the species but *L. scoticus* white *remiges* are then produced. If therefore the successive phases assumed by any animal in the course of its progress to maturity indicate the phases through which the species has passed, there may have been a time when all the species of *Lagopus* wore a brown livery even when adult, and the white dress donned in winter has been imposed upon the wearers by causes that can be easily suggested. The white plumage of the birds of this group protects them from danger during the snows of a protracted winter. But the red grouse, instead of perpetuating directly the more ancient properties of an original *Lagopus* that underwent no great seasonal change of plumage, may derive its ancestry from the widely-ranging willow-grouse, which in an epoch comparatively recent (in the geological sense) may have stocked Britain, and left descendants that, under conditions in which the assumption of a white garb would be almost fatal to the preservation of the species, have reverted (though doubtless with some modifications) to a comparative immutability essentially the same as that of the primal *Lagopus*.



Ptarmigan.

In North America, Greenland and Iceland it is represented by a very nearly allied form—so much so indeed that it is only at certain seasons that the slight difference between them can be detected. This form is the *L. rupestris* of authors, and it would appear to be found also in Siberia (*Ibis*, 1879, p. 148). Spitzbergen is inhabited by a large form which has received recogni-



Blackcock.

tion as *L. hemileucurus*, and the northern end of the chain of the Rocky Mountains is tenanted by a very distinct species, the smallest and perhaps the most beautiful of the genus, *L. leucurus*, which has all the feathers of the tail white.

The bird, however, to which the name of grouse in all strictness belongs is probably the *Tetrao tetrix* of Linnaeus—the blackcock and gryhen, as the sexes are respectively called. It is distributed over most of the heath-country of England, except in East Anglia, where attempts to introduce it have been only partially successful. It also occurs in North Wales and very

generally throughout Scotland, though not in Orkney, Shetland or the Outer Hebrides, nor in Ireland. On the continent of Europe it has a very wide range, and it extends into Siberia. In Georgia its place is taken by a distinct species, on which a Polish naturalist (*Proc. Zool. Society*, 1875, p. 267) has conferred the name of *T. mlakosiewiczii*. Both these birds have much in common with their larger congener the capercally and its eastern representative.

The species of the genus *Bonasa*, of which the European *B. sylvestris* is the type, does not inhabit the British Islands. It is perhaps the most delicate game-bird that comes to table. It is the *gelinotte* of the French, the *Haselkuhn* of Germans, and *Hjerpe* of Scandinavians. Like its transatlantic congener *B. umbellus*, the ruffed grouse or birch-partridge (of which there are two other local forms, *B. umbelloides* and *B. sabinii*), it is purely a forest-bird. The same may be said of the species of *Canace*, of which two forms are found in America, *C. canadensis*, the spruce-partridge, and *C. franklini*, and also of the Siberian *C. falcipennis*. Nearly allied to these birds is the group known as *Dendrogaopus*, containing three large and fine forms *D. obscurus*, *D. fuliginosus*, and *D. richardsoni*—all peculiar to North America. Then there are *Centrocercus urophasianus*, the sage-cock of the plains of Columbia and California, and *Pediocetes*, the sharp-tailed grouse, with its two forms, *P. phasianellus* and *P. columbianus*, while finally *Cupidonia*, the prairie-hen, also with two local forms, *C. cupido* and *C. pallidicincta*, is a bird that in the United States of America possesses considerable economic value, enormous numbers being consumed there, and also exported to Europe.

The various sorts of grouse are nearly all figured in Elliot's *Monograph of the Tetraonidae*, and an excellent account of the American species is given in Baird, Brewer and Ridgway's *North American Birds* (iii. 414-465). See also SHOOTING. (A. N.)

GROVE, SIR GEORGE (1820-1900), English writer on music, was born at Clapham on the 13th of August 1820. He was articled to a civil engineer, and worked for two years in a factory near Glasgow. In 1841 and 1845 he was employed in the West Indies, erecting lighthouses in Jamaica and Bermuda. In 1849 he became secretary to the Society of Arts, and in 1852 to the Crystal Palace. In this capacity his natural love of music and enthusiasm for the art found a splendid opening, and he threw all the weight of his influence into the task of promoting the best music of all schools in connexion with the weekly and daily concerts at Sydenham, which had a long and honourable career under the direction of Mr (afterwards Sir) August Manns. Without Sir George Grove that eminent conductor would hardly have succeeded in doing what he did to encourage young composers and to educate the British public in music. Grove's analyses of the Beethoven symphonies, and the other works presented at the concerts, set the pattern of what such things should be; and it was as a result of these, and of the fact that he was editor of *Macmillan's Magazine* from 1868 to 1883, that the scheme of his famous *Dictionary of Music and Musicians*, published from 1878 to 1889 (new edition, edited by J. A. Fuller Maitland, 1904-1907), was conceived and executed. His own articles in that work on Beethoven, Mendelssohn and Schubert are monuments of a special kind of learning, and that the rest of the book is a little thrown out of balance owing to their great length is hardly to be regretted. Long before this he had contributed to the *Dictionary of the Bible*, and had promoted the foundation of the Palestine Exploration Fund. On a journey to Vienna, undertaken in the company of his lifelong friend, Sir Arthur Sullivan, the important discovery of a large number of compositions by Schubert was made, including the music to *Rosamunde*. When the Royal College of Music was founded in 1882 he was appointed its first director, receiving the honour of knighthood. He brought the new institution into line with the most useful European conservatoriums. On the completion of the new buildings in 1894 he resigned the directorship, but retained an active interest in the institution to the end of his life. He died at Sydenham on the 28th of May 1900.

His life, a most interesting one, was written by Mr Charles Graves. (J. A. F. M.)

GROVE, SIR WILLIAM ROBERT (1811-1896), English judge and man of science, was born on the 11th of July 1811 at Swansea, South Wales. After being educated by private tutors, he went to Brasenose College, Oxford, where he took an ordinary degree in 1832. Three years later he was called to the bar at Lincoln's Inn. His health, however, did not allow him to devote himself strenuously to practice, and he occupied his leisure with scientific studies. About 1839 he constructed the platinum-zinc voltaic cell that bears his name, and with the aid of a number of these exhibited the electric arc light in the London Institution, Finsbury Circus. The result was that in 1840 the managers appointed him to the professorship of experimental philosophy, an office which he held for seven years. His researches dealt very largely with electro-chemistry and with the voltaic cell, of which he invented several varieties. One of these, the Grove gas-battery, which is of special interest both intrinsically and as the forerunner of the secondary batteries now in use for the "storage" of electricity, was based on his observation that a current is produced by a couple of platinum plates standing in acidulated water and immersed, the one in hydrogen, the other in oxygen. At one of his lectures at the Institution he anticipated the electric lighting of to-day by illuminating the theatre with incandescent electric lamps, the filaments being of platinum and the current supplied by a battery of his nitric acid cells. In 1846 he published his famous book on *The Correlation of Physical Forces*, the leading ideas of which he had already put forward in his lectures: its fundamental conception was that each of the forces of nature—light, heat, electricity, &c.—is definitely and equivalently convertible into any other, and that where experiment does not give the full equivalent, it is because the initial force has been dissipated, not lost, by conversion into other unrecognized forces. In the same year he received a Royal medal from the Royal Society for his Bakerian lecture on "Certain phenomena of voltaic ignition and the decomposition of water into its constituent gases." In 1866 he presided over the British Association at its Nottingham meeting and delivered an address on the continuity of natural phenomena. But while he was thus engaged in scientific research, his legal work was not neglected, and his practice increased so greatly that in 1853 he became a Q.C. One of the best-known cases in which he appeared as an advocate was that of William Palmer, the Rugeley poisoner, whom he defended. In 1871 he was made a judge of the Common Pleas in succession to Sir Robert Collier, and remained on the bench till 1887. He died in London on the 1st of August 1896.

A selection of his scientific papers is given in the sixth edition of *The Correlation of Physical Forces*, published in 1874.

GROVE (O.E. *graf*, cf. O.E. *grafa*, brushwood, later "grave"; the word does not appear in any other Teutonic language, and the *New English Dictionary* finds no Indo-European root to which it can be referred; Skeat considers it connected with "grave," to cut, and finds the original meaning to be a glade cut through a wood), a small group or cluster of trees, growing naturally and forming something smaller than a wood, or planted in particular shapes or for particular purposes, in a park, &c. Groves have been connected with religious worship from the earliest times, and in many parts of India every village has its sacred group of trees. For the connexion of religion with sacred groves see TREE-WORSHIP.

The word "grove" was used by the authors of the Authorized Version of the Bible to translate two Hebrew words: (1) *'ishel*, as in Gen. xxi. 33, and 1 Sam. xxii. 6; this is rightly given in the Revised Version as "tamarisk"; (2) *asherah* in many places throughout the Old Testament. Here the translators followed the Septuagint *áσσω* and the Vulgate *lucus*. The *ásheráh* was a wooden post erected at the Canaanitish places of worship, and also by the altars of Yahweh. It may have represented a tree.

GROZNYI, a fortress and town of Russia, North Caucasia, in the province of Terek, on the Zunzha river, 82 m. by rail N.E. of Vladikavkaz, on the railway to Petrovsk. There are naphtha wells close by. The fortifications were constructed in 1819. Pop. (1897) 15,599.

GRUB, the larva of an insect, a caterpillar, maggot. The word is formed from the verb "to grub," to dig, break up the

surface of the ground, and clear of stumps, roots, weeds, &c. According to the *New English Dictionary*, "grub" may be referred to an ablative variant of the Old Teutonic *grab-*, to dig, cf. "grave." Skeat (*Etym. Dict.* 1898) refers it rather to the root seen in "gripe," "grab," &c., the original meaning "to search for." The earliest quotation of the slang use of the word in the sense of food in the *New English Dictionary* is dated 1650 from *Ancient Poems, Ballads, &c.*, Percy Society Publications. "Grubstreet," as a collective term for needy hack-writers, dates from the 17th century and is due to the name of a street near Moorfields, London, now Milton Street, which was as Johnson says "much inhabited by writers of small histories, dictionaries and temporary poems."

GRUBER, JOHANN GOTTFRIED (1774-1851), German critic and literary historian, was born at Naumburg on the Saale, on the 20th of November 1774. He received his education at the town school of Naumburg and the university of Leipzig, after which he resided successively at Göttingen, Leipzig, Jena and Weimar, occupying himself partly in teaching and partly in various literary enterprises, and enjoying in Weimar the friendship of Herder, Wieland and Goethe. In 1811 he was appointed professor at the university of Wittenberg, and after the division of Saxony he was sent by the senate to Berlin to negotiate the union of the university of Wittenberg with that of Halle. After the union was effected he became in 1815 professor of philosophy at Halle. He was associated with Johann Samuel Ersch in the editorship of the great work *Allgemeine Encyclopädie der Wissenschaften und Künste*; and after the death of Ersch he continued the first section from vol. xviii. to vol. liv. He also succeeded Ersch in the editorship of the *Allgemeine Literaturzeitung*. He died on the 7th of August 1851.

Gruber was the author of a large number of works, the principal of which are *Charakteristik Herders* (Leipzig, 1805), in conjunction with Johann T. L. Danz (1769-1851), afterwards professor of theology at Jena; *Geschichte des menschlichen Geschlechts* (2 vols., Leipzig, 1806); *Wörterbuch der altklassischen Mythologie* (3 vols., Weimar, 1810-1815); *Wielands Leben* (2 parts, Weimar, 1815-1816); and *Klopstocks Leben* (Weimar, 1832). He also edited Wieland's *Sämmtliche Werke* (Leipzig, 1818-1826).

GRUMBACH, WILHELM VON (1503-1567), German adventurer, chiefly known through his connexion with the so-called "Grumbach feuds" (*Grumbachsche Händel*), the last attempt of the German knights to destroy the power of the territorial princes. A member of an old Franconian family, he was born on the 1st of June 1503, and having passed some time at the court of Casimir, prince of Bayreuth (d. 1527), fought against the peasants during the rising in 1524 and 1525. About 1540 Grumbach became associated with Albert Alcibiades, the turbulent prince of Bayreuth, whom he served both in peace and war. After the conclusion of the peace of Passau in 1552, Grumbach assisted Albert in his career of plunder in Franconia and was thus able to take some revenge upon his enemy, Melchior von Zobel, bishop of Würzburg. As a landholder Grumbach was a vassal of the bishops of Würzburg, and had held office at the court of Conrad of Bibra, who was bishop from 1540 to 1544. When, however, Zobel was chosen to succeed Conrad the harmonious relations between lord and vassal were quickly disturbed. Unable to free himself and his associates from the suzerainty of the bishop by appealing to the imperial courts he decided to adopt more violent measures, and his friendship with Albert was very serviceable in this connexion. Albert's career, however, was checked by his defeat at Sievershausen in July 1553 and his subsequent flight into France, and the bishop took advantage of this state of affairs to seize Grumbach's lands. The knight obtained an order of restitution from the imperial court of justice (*Reichskammergericht*), but he was unable to carry this into effect; and in April 1558 some of his partisans seized and killed the bishop. Grumbach declared he was innocent of this crime, but his story was not believed, and he fled to France. Returning to Germany he pleaded his cause in person before the diet at Augsburg in 1559, but without success. Meanwhile he had found a new patron in John Frederick, duke of Saxony, whose father, John Frederick, had been obliged

to surrender the electoral dignity to the Albertine branch of his family. Chafing under this deprivation the duke listened readily to Grumbach's plans for recovering the lost dignity, including a general rising of the German knights and the deposition of Frederick II., king of Denmark. Magical charms were employed against the duke's enemies, and communications from angels were invented which helped to stir up the zeal of the people. In 1563 Grumbach attacked Würzburg, seized and plundered the city and compelled the chapter and the bishop to restore his lands. He was consequently placed under the imperial ban, but John Frederick refused to obey the order of the emperor Maximilian II. to withdraw his protection from him. Meanwhile Grumbach sought to compass the assassination of the Saxon elector, Augustus; proclamations were issued calling for assistance; and alliances both without and within Germany were concluded. In November 1566 John Frederick was placed under the ban, which had been renewed against Grumbach earlier in the year, and Augustus marched against Gotha. Assistance was not forthcoming, and a mutiny led to the capitulation of the town. Grumbach was delivered to his foes, and, after being tortured, was executed at Gotha on the 18th of April 1567.

See F. Oetloff, *Geschichte der Grumbachschen Händel* (Jena, 1868-1870), and J. Voigt, *Wilhelm von Grumbach und seine Händel* (Leipzig, 1846-1847).

GRUMENTUM, an ancient town in the centre of Lucania, 53 m. S. of Potentia by the direct road through Anzia, and 52 m. by the Via Herculia, at the point of divergence of a road eastward to Heracles. It seems to have been a native Lucanian town, not a Greek settlement. In 215 B.C. the Carthaginian general Hanno was defeated under its walls, and in 207 B.C. Hannibal made it his headquarters. In the Social War it appears as a strong fortress, and seems to have been held by both sides at different times. It became a colony, perhaps in the time of Sulla, at latest under Augustus, and seems to have been of some importance. Its site, identified by Holste from the description of the martyrdom of St Laverius, is a ridge on the right bank of the Aciris (Agri) about 1060 ft. above sea-level, $\frac{1}{2}$ m. below the modern Saponara, which lies much higher (2533 ft.). Its ruins (all of the Roman period) include those of a large amphitheatre (arena 205 by 197 ft.), the only one in Lucania, except that at Paestum. There are also remains of a theatre. Inscriptions record the repair of its town walls and the construction of *thermas* (of which remains were found) in 57-51 B.C., the construction in 43 B.C., of a portico, remains of which may be seen along an ancient road, at right angles to the main road, which traversed Grumentum from S. to N.

See F. P. Caputi in *Notizie degli scavi* (1877), 129, and G. Patroni, *ibid.* (1897) 180. (T. As.)

GRÜN, HANS BALDUNG (c. 1470-1545), commonly called Grün, a German painter of the age of Dürer, was born at Gmünd in Swabia, and spent the greater part of his life at Strassburg and Freiburg in Breisgau. The earliest pictures assigned to him are altarpieces with the monogram H. B. interlaced, and the date of 1496, in the monastery chapel of Lichtenthal near Basel. Another early work is a portrait of the emperor Maximilian, drawn in 1501 on a leaf of a sketch-book now in the print-room at Carlsruhe. The "Martyrdom of St Sebastian" and the "Epiphany" (Berlin Museum), fruits of his labour in 1507, were painted for the market-church of Halle in Saxony. In 1509 Grün purchased the freedom of the city of Strassburg, and resided there till 1513, when he moved to Freiburg in Breisgau. There he began a series of large compositions, which he finished in 1516, and placed on the high altar of the Freiburg cathedral. He purchased anew the freedom of Strassburg in 1517, resided in that city as his domicile, and died a member of its great town council 1545.

Though nothing is known of Grün's youth and education, it may be inferred from his style that he was no stranger to the school of which Dürer was the chief. Gmünd is but 50 m. distant on either side from Augsburg and Nuremberg. Grün's prints were often mistaken for those of Dürer; and Dürer himself was well acquainted with Grün's woodcuts and

copper-plates in which he traded during his trip to the Netherlands (1520). But Grün's prints, though Düreresque, are far below Dürer, and his paintings are below his prints. Without absolute correctness as a draughtsman, his conception of human form is often very unpleasant, whilst a questionable taste is shown in ornament equally profuse and "baroque." Nothing is more remarkable in his pictures than the pug-like shape of the faces, unless we except the coarseness of the extremities. No trace is apparent of any feeling for atmosphere or light and shade. Though Grün has been commonly called the Correggio of the north, his compositions are a curious medley of glaring and heterogeneous colours, in which pure black is contrasted with pale yellow, dirty grey, impure red and glowing green. Flesh is a mere glaze under which the features are indicated by lines. His works are mainly interesting because of the wild and fantastic strength which some of them display. We may pass lightly over the "Epiphany" of 1507, the "Crucifixion" of 1512, or the "Stoning of Stephen" of 1522, in the Berlin Museum. There is some force in the "Dance of Death" of 1517, in the museum of Basel, or the "Madonna" of 1530, in the Liechtenstein Gallery at Vienna. Grün's best effort is the altarpiece of Freiburg, where the "Coronation of the Virgin," and the "Twelve Apostles," the "Annunciation, Visitation, Nativity and Flight into Egypt," and the "Crucifixion," with portraits of donors, are executed with some of that fanciful power which Martin Schön bequeathed to the Swabian school. As a portrait painter he is well known. He drew the likeness of Charles V., as well as that of Maximilian; and his bust of Margrave Philip in the Munich Gallery tells us that he was connected with the reigning family of Baden as early as 1514. At a later period he had sittings from Margrave Christopher of Baden, Otilia his wife, and all their children, and the picture containing those portraits is still in the grand-ducal gallery at Karlsruhe. Like Dürer and Cranach, Grün became a hearty supporter of the Reformation. He was present at the diet of Augsburg in 1518, and one of his woodcuts represents Luther under the protection of the Holy Ghost, which hovers over him in the shape of a dove.

GRÜNBERG, a town of Germany, in Prussian Silesia, beautifully situated between two hills on an affluent of the Oder, and on the railway from Breslau to Stettin via Küstrin, 36 m. N.N.W. of Glogau. Pop. (1905) 20,987. It has a Roman Catholic and two Evangelical churches, a modern school and a technical (textiles) school. There are manufactures of cloth, paper, machinery, straw hats, leather and tobacco. The prosperity of the town depends chiefly on the vine culture in the neighbourhood, from which, besides the exportation of a large quantity of grapes, about 700,000 gallons of wine are manufactured annually.

GRUNDTVIG, NIKOLAI FREDERIK SEVERIN (1783-1872), Danish poet, statesman and divine, was born at the parsonage of Udby in Zealand on the 8th of September 1783. In 1799 he was sent to live at the house of a priest in Jutland, and studied at the free school of Aarhus until he went up to the university of Copenhagen in 1800. At the close of his university life he made Icelandic his special study, until in 1805 he took the position of tutor in a house on the island of Langeland. The next three years were spent in the study of Shakespeare, Schiller and Fichte. His cousin, the philosopher Henrik Steffens, had returned to Copenhagen in 1802 full of the teaching of Schelling and his lectures and the early poetry of Ohlenschläger opened the eyes of Grundtvig to the new era in literature. His first work, *On the Songs in the Edda*, attracted no attention. Returning to Copenhagen in 1808 he achieved greater success with his *Northern Mythology*, and again in 1809-1811 with a long epic poem, the *Dichine of the Heroic Life in the North*. The boldness of the theological views expressed in his first sermon in 1810 offended the ecclesiastical authorities, and he retired to a country parish as his father's assistant for a while. From 1812 to 1817 he published five or six works, of which the *Rhyme of Roskilde* is the most remarkable. From 1816 to 1819 he was editor of a polemical journal entitled *Dannewirke*, and in 1818 to 1822 appeared his Danish paraphrases (6 vols.) of Sæm Grammaticus and Soorri.

During these years he was preaching against rationalism to an enthusiastic congregation in Copenhagen, but he accepted in 1821 the country living of Præstø, only to return to the metropolis the year after. In 1825 he published a pamphlet, *The Church's Reply*, against H. N. Clausen, who was professor of theology in the university of Copenhagen. Grundtvig was publicly prosecuted and fined, and for seven years he was forbidden to preach, years which he spent in publishing a collection of his theological works, in paying two visits to England, and in studying Anglo-Saxon. In 1832 he obtained permission to preach again, and in 1839 he became priest of the workhouse church of Vartov hospital, Copenhagen, a post he continued to hold until his death. In 1837-1841 he published *Songs for the Danish Church*, a rich collection of sacred poetry; in 1838 he brought out a selection of early Scandinavian verse; in 1840 he edited the Anglo-Saxon poem of the *Phoenix*, with a Danish translation. He visited England a third time in 1843. From 1844 until after the first German war Grundtvig took a very prominent part in politics. In 1861 he received the titular rank of bishop, but without a see. He went on writing occasional poems till 1866, and preached in the Vartov every Sunday until a month before his death. His preaching attracted large congregations, and he soon had a following. His hymn-book effected a great change in Danish church services, substituting the hymns of the national poets for the slow measures of the orthodox Lutherans. The chief characteristic of his theology was the substitution of the authority of the "living word" for the apostolic commentaries, and he desired to see each congregation a practically independent community. His patriotism was almost a part of his religion, and he established popular schools where the national poetry and history should form an essential part of the instruction. His followers are known as Grundtvigians. He was married three times, the last time in his seventy-sixth year. He died on the 2nd of September 1872. Grundtvig holds a unique position in the literature of his country; he has been styled the Danish Carlyle. He was above all things a man of action, not an artist; and the formless vehemence of his writings, which have had a great influence over his own countrymen, is hardly agreeable or intelligible to a foreigner. The best of his poetical works were published in a selection (7 vols., 1880-1889) by his eldest son, Svend Hensleb Grundtvig (1824-1883), who was an authority on Scandinavian antiquities, and made an admirable collection of old Danish poetry (*Danmarks gamle Folkelieder*, 1853-1885, 5 vols.; completed in 1891 by A. Olrik).

His correspondence with Ingemann was edited by S. Grundtvig (1882); his correspondence with Christian Molboek by L. Schrøder (1888); see also F. Winkel Horn, *Grundtvigs Liv og Gjerning* (1863); and an article by F. Nielsen in Bricks's *Dansk Biografisk Leksikon*.

GRUNDY, SYDNEY (1848-), English dramatist, was born at Manchester on the 23rd of March 1848, son of Alderman Charles Sydney Grundy. He was educated at Owens College, Manchester, and was called to the bar in 1869, practising in Manchester until 1876. His farce, *A Little Change*, was produced at the Haymarket Theatre in 1872. He became well known as an adapter of plays, among his early successes in this direction being *The Snowball* (Strand Theatre, 1879) from *Oscar, ou le mari qui trompe sa femme* by M.M. Scribe and Duvergne, and *In Honour Bound* (1880) from Scribe's *Une Châtaigne*. In 1887 he made a popular success with *The Bells of Halesmere*, written with Mr H. Pettitt and produced at the Adelphi. In 1889-1890 he produced two ingenious original comedies, *A White Lie* (Court Theatre) and *A Fool's Paradise* (Gaiety Theatre), which had been played two years earlier at Greenwich as *The Mouse-Trap*. These were followed by *Sowing the Wind* (Comedy, 1893), *An Old Jew* (Garrick, 1894), and by an adaptation of Octave Feuillet's *Montjoye* as *A Bunch of Violets* (Haymarket, 1894). In 1894 he produced *The New Woman* and *The Slaves of the Ring*; in 1895, *The Greatest of These*, played by Mr and Mrs Kendal at the Garrick Theatre; *The Degenerates* (Haymarket, 1896), and *A Dub of Honour* (St James's 1900). Among Mr Grundy's most successful adaptations were the charming *Pair of Spectacles* (Garrick, 1890) from *Les Petits Oiseaux* of M.M. Labiche and

Delacour. Others were *A Village Priest* (Haymarket, 1890) from *Le Secret de la terreuse*, a melodrama by MM. Busnach and Cauvin; *A Marriage of Convenience* (Haymarket, 1897) from *Un Mariage de Louis XV*, by Alex. Dumas, père, *The Silver Key* (His Majesty's, 1897) from his *Mlle de Belle-Isle*; and *The Musqueteers* (1899) from the same author's novel; *Frocks and Frills* (Haymarket, 1902) from the *Doigts de fées* of MM. Scribe and Legouvé; *The Garden of Lées* (St James's Theatre, 1904) from Mr Justus Miles Forman's novel; *Business is Business* (His Majesty's Theatre, 1905), a rather free adaptation from Octave Mirbeau's *Les Affaires sont les affaires*; and *The Diplomats* (Royalty Theatre, 1905) from *La Poudre aux yeux*, by Labiche.

GRUNDY, MRS, the name of an imaginary English character, who typifies the disciplinary control of the conventional "proprieties" of society over conduct, the tyrannical pressure of the opinion of neighbours on the acts of others. The name appears in a play of Thomas Morton, *Speed the Plough* (1798), in which one of the characters, Dame Ashfield, continually refers to what her neighbour Mrs Grundy will say as the criterion of respectability. Mrs Grundy is not a character in the play, but is a kind of "Mrs Harris" to Dame Ashfield.

GRUNER, GOTTLIEB SIGMUND (1717-1778), the author of the first connected attempt to describe in detail the snowy mountains of Switzerland. His father, Johann Rudolf Gruner (1680-1761), was pastor of Trachselwald, in the Bernese Emmenthal (1705), and later (1725) of Burgdorf, and a great collector of information relating to historical and scientific matters; his great *Thesaurus topographico-historicus totius ditionis Bernensis* (4 vols. folio, 1729-1730) still remains in MS., but in 1732 he published a small work entitled *Deliciae urbis Bernae*, while he possessed an extensive cabinet of natural history objects. Naturally such tastes had a great influence on the mind of his son, who was born at Trachselwald, and educated by his father and at the Latin school at Burgdorf, not going to Berne much before 1736, when he published a dissertation on the use of fire by the heathen. In 1739 he qualified as a notary, in 1741 became the archivist of Hesse-Homburg, and in 1743 accompanied Prince Christian of Anhalt-Schaumburg to Silesia and the university of Halle. He returned to his native land before 1749, when he obtained a post at Thorberg, being transferred in 1764 to Landshut and Fraubrunnen. It was in 1760 that he published in 3 vols. at Berne his chief work, *Die Eisgebirge des Schweizerlandes* (bad French translation by M. de Kéralio, Paris, 1770). The first two volumes are filled by a detailed description of the snowy Swiss mountains, based not so much on personal experience as on older works, and a very large number of communications received by Gruner from numerous friends; the third volume deals with glaciers in general, and their various properties. Though in many respects imperfect, Gruner's book sums up all that was known on the subject in his day, and forms the starting-point for later writers. The illustrations are very curious and interesting. In 1778 he republished (nominally in London, really at Berne) much of the information contained in his larger work, but thrown into the form of letters, supposed to be written in 1776 from various spots, under the title of *Reisen durch die merkwürdigsten Gegenden Helvetiens* (2 vols.). (W. A. B. C.)

GRÜNEWALD, MATHIAS. The accounts which are given of this German painter, a native of Aschaffenburg, are curiously contradictory. Between 1518 and 1530, according to statements adopted by Waagen and Passavant, he was commissioned by Albert of Brandenburg, elector and archbishop of Mainz, to produce an altarpiece for the collegiate church of St Maurice and Mary Magdalen at Halle on the Saale; and he acquitted himself of this duty with such cleverness that the prelate in after years caused the picture to be rescued from the Reformers and brought back to Aschaffenburg. From one of the churches of that city it was taken to the Pinakothek of Munich in 1836. It represents St Maurice and Mary Magdalen between four saints, and displays a style so markedly characteristic, and so like that of Lucas Cranach, that Waagen was induced to call

Grünwald Cranach's master. He also traced the same hand and technical execution in the great altarpieces of Annaberg and Heilbronn, and in various panels exhibited in the museums of Mainz, Darmstadt, Aschaffenburg, Vienna and Berlin. A later race of critics, declining to accept the statements of Waagen and Passavant, affirm that there is no documentary evidence to connect Grünwald with the pictures of Halle and Annaberg, and they quote Sandrart and Bernhard Jobin of Strassburg to show that Grünwald is the painter of pictures of a different class. They prove that he finished before 1516 the large altarpiece of Issenheim, at present in the museum of Colmar, and starting from these premises they connect the artist with Altdorfer and Dürer to the exclusion of Cranach. That a native of the Palatinate should have been asked to execute pictures for a church in Saxony can scarcely be accounted strange, since we observe that Hans Baldung (Grün) was entrusted with a commission of this kind. But that a painter of Aschaffenburg should display the style of Cranach is strange and indeed incredible, unless vouched for by first-class evidence. In this case documents are altogether wanting, whilst on the other hand it is beyond the possibility of doubt, even according to Waagen, that the altarpiece of Issenheim is the creation of a man whose teaching was altogether different from that of the painter of the pictures of Halle and Annaberg. The altarpiece of Issenheim is a fine and powerful work, completed as local records show before 1516 by a Swabian, whose distinguishing mark is that he followed the traditions of Martin Schongauer, and came under the influence of Altdorfer and Dürer. As a work of art the altarpiece is important, being a polyptych of eleven panels, a carved central shrine covered with a double set of wings, and two side pieces containing the Temptation of St Anthony, the hermits Anthony and Paul in converse, the Virgin adored by Angels, the Resurrection, the Annunciation, the Crucifixion, St Sebastian, St Anthony, and the Marys walling over the dead body of Christ. The author of these compositions is also the painter of a series of monochromes described by Sandrart in the Dominican convent, and now in part in the Saalhof at Frankfurt, and a Resurrection in the museum of Basel, registered in Amerbach's inventory as the work of Grünwald.

GRUTER (or GRUYÈRE), JAN (1560-1627), a critic and scholar of Dutch parentage by his father's side and English by his mother's, was born at Antwerp on the 3rd of December 1560. To avoid religious persecution his parents while he was still young came to England; and for some years he prosecuted his studies at Cambridge, after which he went to Leiden, where he graduated M.A. In 1586 he was appointed professor of history at Wittenberg, but as he refused to subscribe the *formula concordiae* he was unable to retain his office. From 1589 to 1592 he taught at Rostock, after which he went to Heidelberg, where in 1602 he was appointed librarian to the university. He died at Heidelberg on the 20th of September 1627.

Gruter's chief works were his *Inscriptiones antiquae totius orbis Romani* (2 vols., Heidelberg, 1603), and *Lampas, sive fax arrium liberalium* (7 vols., Frankfurt, 1602-1634).

GRUYÈRE (Ger. *Greyers*), a district in the south-eastern portion of the Swiss canton of Fribourg, famed for its cattle and its cheese, and the original home of the "Ranz des Vaches," the melody by which the herdsmen call their cows home at milking time. It is composed of the middle reach (from Montbovon to beyond Bulle) of the Sarine or Saane valley, with its tributary glens of the Hongrin (left), the Jogne (right) and the Trême (left), and is a delightful pastoral region (in 1901 it contained 17,364 cattle). It forms an administrative district of the canton of Fribourg, its population in 1900 being 23,111, mainly French-speaking and Romanists. From Montbovon (11 m. by rail from Bulle) there are mountain railways leading S.W. past Les Avants to Montreux (14 m.), and E. up the Sarine valley past Château d'Oex to Saanen or Gessenay (14 m.), and by a tunnel below a low pass to the Simme valley and Spiez on the Lake of Thun. The modern capital of the district is the small town of Bulle [Ger. *Boll*], with a 13th-century castle and in 1900 3330 inhabitants, French-speaking and Romanists. But

the historical capital is the very picturesque little town of *Gruyères* (which keeps its final "s" in order to distinguish it from the district), perched on a steep hill (S.E. of Bulle) above the left bank of the Sarine, and at a height of 2713 ft. above the sea-level. It is only accessible by a rough carriage road, and boasts of a very fine old castle, at the foot of which is the solitary street of the town, which in 1900 had 1389 inhabitants.

The castle was the seat of the counts of the Gruyère, who are first mentioned in 1073. The name is said to come from the word *gruyer*, meaning the officer of woods and forests, but the counts bore the canting arms of a crane (*grue*), which are seen all over the castle and the town. That valiant family ended (in the legitimate line) with Count Michel (d. 1575) whose extravagance and consequent indebtedness compelled him in 1555 to sell his domains to Bern and Fribourg. Bern took the upper Sarine valley (it still keeps Saanen at its head, but in 1798 lost the Pays d'En-Haut to the canton du Léman, which in 1803 became the canton of Vaud). Fribourg took the rest of the county, which it added to Bulle and Albeuve (taken in 1537 from the bishop of Lausanne), and to the lordship of Jaun in the Jaun or Jogne valley (bought in 1502-1504 from its lords), in order to form the present administrative district of Gruyère, which is not co-extensive with the historical county of that name.

See the materials collected by J. J. Hisey and published in successive vols. of the *Mémoires et documents de la Suisse romande* . . . *introd. à l'hist.* (1851); *Histoire* (2 vols., 1855-1857); and *Monuments de l'histoire* (2 vols., 1867-1869); K. V. von Bonstetten, *Briefe über ein schweiz. Hirtenland* (1781) (Eng. trans., 1784); J. Reichle, *La Gruyère illustrée* (1890), seq.; H. Raemy, *La Gruyère* (1867); and *Les Alpes fribourgeoises*, by many authors (Lausanne, 1908). (W. A. B. C.)

GRYNAEUS (or **GRYNER**), **JOHANN JAKOB** (1540-1617), Swiss Protestant divine, was born on the 1st of October 1540 at Bern. His father, Thomas (1512-1564), was for a time professor of ancient languages at Basel and Bern, but afterwards became pastor of Röteln in Baden. He was nephew of the more eminent Simon Grynaeus (q.v.). Johann was educated at Basel, and in 1559 received an appointment as curate to his father. In 1563 he proceeded to Tübingen for the purpose of completing his theological studies, and in 1565 he returned to Röteln as successor to his father. Here he felt compelled to abjure the Lutheran doctrine of the Lord's Supper, and to renounce the *formula concordiae*. Called in 1575 to the chair of Old Testament exegesis at Basel, he became involved in unpleasant controversy with Simon Sulzer and other champions of Lutheran orthodoxy; and in 1584 he was glad to accept an invitation to assist in the restoration of the university of Heidelberg. Returning to Basel in 1586, after Simon Sulzer's death, as *antistes* or superintendent of the church there and as professor of the New Testament, he exerted for upwards of twenty-five years a considerable influence upon both the church and the state affairs of that community, and acquired a wide reputation as a skillful theologian of the school of Ulrich Zwingli. Amongst other labours he helped to reorganize the gymnasium in 1588. Five years before his death he became totally blind, but continued to preach and lecture till his death on the 13th of August 1617.

His many works include commentaries on various books of the Old and New Testament, *Theologica theorematia et problemata* (1588), and a collection of patristic literature entitled *Monumenta S. patrum orthodoxographia* (2 vols., fol., 1569).

GRYNAEUS, SIMON (1493-1541), German scholar and theologian of the Reformation, son of Jacob Gryner, a Swabian peasant, was born in 1493 at Vehringeren, in Hohenzollern-Sigmaringen. He adopted the name Grynaeus from the epithet of Apollo in Virgil. He was a schoolfellow with Melancthon at Pforzheim, whence he went to the university of Vienna, distinguishing himself there as a Latinist and Grecian. His appointment as rector of a school at Buda was of no long continuance; his views excited the zeal of the Dominicans and he was thrown into prison. Gaining his freedom at the instance of Hungarian magnates, he visited Melancthon at Wittenberg, and in 1524 became professor of Greek at the university of Heidelberg, being in addition professor of Latin from 1526. His Zwinglian view of the Eucharist disturbed his relations with

his Catholic colleagues. From 1526 he had corresponded with Oecolampadius, who in 1529 invited him to Basel, which Erasmus had just left. The university being disorganized, Grynaeus pursued his studies, and in 1531 visited England for research in libraries. A commendatory letter from Erasmus gained him the good offices of Sir Thomas More. He returned to Basel charged with the task of collecting the opinions of continental reformers on the subject of Henry VIII.'s divorce, and was present at the death of Oecolampadius (Nov. 24, 1531). He now, while holding the chair of Greek, was appointed extraordinary professor of theology, and gave exegetical lectures on the New Testament. In 1534 Duke Ulrich called him to Württemberg in aid of the reformation there, as well as for the reconstitution of the university of Tübingen, which he carried out in concert with Ambrosius Blarer of Konstanz. Two years later he had an active hand in the so-called First Helvetic Confession (the work of Swiss divines at Basel in January 1536); also in the conferences which urged the Swiss acceptance of the Wittenberg Concord (1536). At the Worms conference (1540) between Catholics and Protestants he was the sole representative of the Swiss churches, being deputed by the authorities of Basel. He was carried off suddenly in his prime by the plague at Basel on the 1st of August 1541. A brilliant scholar, a mediating theologian, and personally of lovable temperament, his influence was great and wisely exercised. Erasmus and Calvin were among his correspondents. His chief works were Latin versions of Plutarch, Aristotle and Chrysostom.

His son SAMUEL (1539-1599) was professor of jurisprudence at Basel. His nephew THOMAS (1512?-1564) was professor at Basel and minister in Baden, and left four distinguished sons of whom JOHANN JAKOB (1540-1617) was a leader in the religious affairs of Basel. The last of the direct descendants of Simon Grynaeus was his namesake SIMON (1725-1799), translator into German of French and English anti-deistical works, and author of a version of the Bible in modern German (1776).

See Bayle's *Dictionnaire*; W. T. Streuber in Hauck's *Realencyklopädie* (1899); and for bibliography, Streuber's *S. Grynaei epistolae* (1847). (A. G.)

GRYPHIUS, ANDREAS (1616-1664), German lyric poet and dramatist, was born on the 11th of October 1616, at Grossglogau in Silesia, where his father was a clergyman. The family name was Greif, latinized, according to the prevailing fashion, as Gryphius. Left early an orphan and driven from his native town by the troubles of the Thirty Years' War, he received his schooling in various places, but notably at Fraustadt, where he enjoyed an excellent classical education. In 1634 he became tutor to the sons of the eminent jurist Georg von Schönborn (1579-1637), a man of wide culture and considerable wealth, who, after filling various administrative posts and writing many erudite volumes on law, had been rewarded by the emperor Ferdinand II. with the title and office of imperial count-palatine (*Pfalzgraf*). Schönborn, who recognized Gryphius's genius, crowned him *poeta laureatus*, gave him the diploma of master of philosophy, and bestowed on him a patent of nobility, though Gryphius never used the title. A month later, on the 23rd of December 1637, Schönborn died; and next year Gryphius went to continue his studies at Leiden, where he remained six years, both hearing and delivering lectures. Here he fell under the influence of the great Dutch dramatists, Pieter Cornelissen Hooft (1581-1647) and Joost van den Vondel (1587-1679), who largely determined the character of his later dramatic works. After travelling in France, Italy and South Germany, Gryphius settled in 1647 at Fraustadt, where he began his dramatic work, and in 1650 was appointed syndic of Glogau, a post he held until his death on the 16th of July 1664. A short time previously he had been admitted under the title of "The Immortal" into the *Fruchtbringende Gesellschaft*, a literary society, founded in 1617 by Ludwig, prince of Anhalt-Köthen on the model of the Italian academies.

Gryphius was a man of morbid disposition, and his melancholy temperament, fostered by the misfortunes of his childhood, is largely reflected in his lyrics, of which the most famous are the

Kirchhofgedanken (1696). His best works are his comedies, one of which, *Absurda Comica, oder Herr Peter Squenta* (1663), is evidently based on the comic episode of Pyramus and Thisbe in *The Midsummer Night's Dream*. *Die geliebte Dermose* (1660), which is written in a Silesian dialect, contains many touches of natural simplicity and grace, and ranks high among the comparatively small number of German dramas of the 17th century. *Horribilicribrifax* (1663), founded on the *Miles gloriosus* of Plautus, is a rather laboured attack on pedantry. Besides these three comedies, Gryphius wrote five tragedies. In all of them his tendency is to become wild and bombastic, but he had the merit of at least attempting to work out artistically conceived plans, and there are occasional flashes both of passion and of imagination. His models seem to have been Seneca and Vondel. He had the courage, in *Carolus Stuartus* (1649) to deal with events of his own day; his other tragedies are *Leo Armenicus* (1646); *Katharina von Georgien* (1657), *Cardenio und Celinde* (1657) and *Papinianus* (1663). No German dramatic writer before him had risen to so high a level, nor had he worthy successors until about the middle of the 18th century.

A complete edition of Gryphius's dramas and lyric poetry has been published by H. Palm in the series of the Stuttgart Literarische Verein (3 vols., 1878, 1882, 1884). Volumes of selected works will be found in W. Müller's *Bibliothek der deutschen Dichter des 17ten Jahrhunderts* (1822) and in J. Titmann's *Deutsche Dichter des 17ten Jahrhunderts* (1870). There is also a good selection by H. Palm in *Kurschner's Deutsche Nationalliteratur*.

See O. Klopp, *Andreas Gryphius als Dramatiker* (1851); J. Hermann, *Über Andreas Gryphius* (1851); T. Wissowa, *Beiträge zur Kenntnis von Andreas Gryphius's Leben und Schriften* (1876); J. Wysocki, *Andreas Gryphius et la tragédie allemande au XVII^e siècle*; and V. Mannheimer, *Die Lyrik des Andreas Gryphius* (1904).

GUACHARO (said to be an obsolete Spanish word signifying one that cries, moans or laments loudly), the Spanish-American name of what English writers call the oil-bird, the *Steatornis caripensis* of ornithologists, a very remarkable bird, first described by Alexander von Humboldt (*Voy. aux îles équinoxiales* i. 413, Eng. trans. iii. 119; *Obs. Zoologie* ii. 141, pl. xiv.) from his own observation and from examples obtained by Aimé J. A. Bonpland, on the visit of those two travellers, in September 1799, to a cave near Caripé (at that time a monastery of Aragonese Capuchins) some forty miles S.E. of Cumaná on the northern coast of South America. A few years later it was discovered, says Latham (*Gen. Hist. Birds*, 1823, vii. 365), to inhabit Trinidad, where it appears to bear the name of *Diabolus*! but by the receipt of specimens procured at Sarayacu in Peru, Cajamarca in the Peruvian Andes, and Antioquia in Colombia (*Proc. Zool. Society*, 1878, pp. 139, 140; 1879, p. 532), its range has been shown to be much greater than had been supposed. The singularity of its structure, its curious habits, and its peculiar economical value have naturally attracted no little attention from zoologists. First referring it to the genus *Caprimulgus*, its original describer soon saw that it was no true goatsucker. It was subsequently separated as forming a sub-family, and has at last been regarded as the type of a distinct family, *Steatornithidae*—a view which, though not put forth till 1870 (*Zool. Record*, vi. 67), seems now to be generally deemed correct. Its systematic position, however, can scarcely be considered settled, for though on the whole its predominant alliance may be with the *Caprimulgidae*, nearly as much affinity may be traced to the *Strigidae*, while it possesses some characters in which it differs from both (*Proc. Zool. Society*, 1873, pp. 526-535). About as big as a crow, its plumage exhibits the blended tints of chocolate-colour and grey, barred and pencilled with dark-brown or black, and spotted in places with white, that prevail in the two families just named. The beak is hard, strong and deeply notched, the nostrils are prominent, and the gape is furnished with twelve long hairs on each side. The legs and toes are comparatively feeble, but the wings are large. In habits the guacharo is wholly nocturnal, slumbering by day in deep and dark caverns which it frequents in vast numbers. Towards evening it arouses itself, and, with croaking and

¹ Not to be confounded with the bird so called in the French Antilles, which is a petrel (*Ossifraga*).

clattering which has been likened to that of castanets, it approaches the exit of its retreat, whence at nightfall it issues in search of its food, which, so far as is known, consists entirely of oily nuts or fruits, belonging especially to the genera *Achras*, *Alphama*, *Lasurus* and *Prichotria*, some of them sought, it would seem, at a very great distance, for Funck (*Bull. Acad. Sc. Bruxelles* xi. pt. 2, pp. 371-377) states that in the stomach of one he obtained at Caripé he found the seed of a tree which he believed did not grow nearer than 80 leagues. The hard, indigestible seed swallowed by the guacharo are found in quantities on the floor and the ledges of the caverns it frequents, where many of them for a time vegetate, the plants thus growing being etiolated from want of light, and, according to travellers, forming a singular feature of the gloomy scene which these places present. The guacharo is said to build a bowl-like nest of clay, in which it lays from two to four white eggs, with a smooth but lustreless surface, resembling those of some owls. The young soon after they are hatched become a perfect mass of fat, and while yet in the nest are sought by the Indians, who at Caripé, and perhaps elsewhere, make a special business of taking them and extracting the oil they contain. This is done about midsummer, when by the aid of torches and long poles many thousands of the young birds are slaughtered, while their parents in alarm and rage hover over the destroyers' heads, uttering harsh and deafening cries. The grease is melted over fires kindled at the cavern's mouth, run into earthen pots, and preserved for use in cooking as well as for the lighting of lamps. It is said to be pure and limpid, free from any disagreeable taste or smell, and capable of being kept for a year without turning rancid. In Trinidad the young are esteemed a great delicacy for the table by many, though some persons object to their peculiar scent, which resembles that of a cockroach (*Blatta*), and consequently refuse to eat them. The old birds also, according to E. C. Taylor (*Ibis*, 1864, p. 90), have a strong crow-like odour. But one species of the genus *Steatornis* is known.

In addition to the works above quoted valuable information about this curious bird may be found under the following references: L'Herminier, *Ann. Sc. Nat.* (1836), p. 60, and *Nouv. Ann. Mus.* (1838), p. 321; Hautessier, *Rev. Zool.* (1838), p. 164; J. Müller, *Monatsh. Berl. Acad.* (1841), p. 172, and *Archiv. für Anat.* (1862), pp. 1-11; des Muris, *Rev. Zool.* (1843), p. 32, and *Col. Orn.*, pp. 260-263; Blanchard, *Ann. Mus.* (1859), xi. pl. 4, fig. 30; König, *Wartshausen, Journ. für Orn.* (1863), pp. 384-387; Coering, *Vogelzucht* (1869), pp. 124-128; Muric, *Ibis* (1873), pp. 81-86.

GUACO, HUACO or **GUAO**, also **Vejuco** and **Bejuco**, terms applied to various Central and South American and West Indian plants, in repute for curative virtues. The Indians and negroes of Colombia believe the plants known to them as **guaco** to have been so named after a species of kite, thus designated in imitation of its cry, which they say attracts to it the snakes that serve it principally for food; they further hold the tradition that their antidotal qualities were discovered through the observation that the bird eats of their leaves, and even spreads the juice of the same on its wings, during contests with its prey. The disputes that have arisen as to what is "the true guaco" are to be attributed mainly to the fact that the names of the American Indians for all natural objects are generic, and their genera not always in coincidence with those of naturalists. Thus any twining plant with a heart-shaped leaf, white and green above and purple beneath, is called by them **guaco** (R. Spruce, in Howard's *Neuea Quinologia*, "Cinchona succubra," p. 22, note). What is most commonly recognized in Colombia as **guaco**, or **Vejuco del guaco**, would appear to be *Mikania Guaco* (Humboldt and Bonpland, *Pl. Equinox.* ii. 84, pl. 105, 1809), a climbing Composite plant of the tribe *Eupatoriaceae*, affecting moist and shady situations, and having a much-branched and deep-growing root, variegated, serrate, opposite leaves and dull-white flowers, in axillary clusters. The whole plant emits a disagreeable odour. It is stated that the Indians of Central America, after having "guaconized" themselves, i.e. taken **guaco**, catch with impunity the most dangerous snakes, which writhe in their hands as though touched by a hot iron (B. Seemann, *Hooker's Journ. of Bot.* v. 76, 1853). The odour alone of **guaco**

has been said to cause in snakes a state of stupor and torpidity; and Humboldt, who observed that the near approach of a rod steeped in guaco-juice was obnoxious to the venomous *Colester coralinus*, was of opinion that inoculation with it imparts to the perspiration an odour which makes reptiles unwilling to bite. The drug is not used in modern therapeutics.

GUADALAJARA, an inland city of Mexico and capital of the state of Jalisco, 275 m. (direct) W.N.W. of the Federal capital, in lat. 20° 41' 10" N., long. 103° 21' 15" W. Pop. (1895) 83,934; (1900) 101,208. Guadalajara is served by a short branch of the Mexican Central railway from Irapuato. The city is in the Antemnac valley near the Río Grande de Santiago, 5092 ft. above sea-level. Its climate is dry, mild and healthy, though subject to sudden changes. The city is well built, with straight and well-paved streets, numerous plazas, public gardens and shady promenades. Its public services include tramways and electric lighting, the Juanacatlán falls of the Río Grande near the city furnishing the electric power. Guadalajara is an episcopal see, and its cathedral, built between 1571 and 1618, is one of the largest and most elaborately decorated churches in Mexico. The government palace, which like the cathedral faces upon the *Plaza mayor*, is generally considered one of the finest specimens of Spanish architecture in Mexico. Other important edifices and institutions are the university, with its schools of law and medicine, the mint, built in 1811, the modern national college and high schools, a public library of over 28,000 volumes, an episcopal seminary, an academy of fine arts, the Teatro Degollado, and the large modern granite building of the penitentiary. There are many interesting churches and eleven conventual establishments in the city. Charitable institutions of a high character are also prominent, among which are the Hospicio, which includes an asylum for the aged, infirm, blind, deaf and dumb, foundlings and orphans, a primary school for both sexes, and a girls' training school, and the Hospital de San Miguel de Belen, which is a hospital, an insane asylum, and a school for little children. One of the most popular public resorts of the city is the *Paseo*, a beautiful drive and promenade extending along both banks of the Río San Juan de Dios for 1½ m. and terminating in the *alameda*, or public garden. The city has a good water-supply, derived from springs and brought in through an aqueduct 8 m. long. Guadalajara is surrounded by a fertile agricultural district and is an important commercial town, but the city is chiefly distinguished as the centre of the iron, steel and glass industries of Mexico. It is also widely known for the artistic pottery manufactured by the Indians of the city and of its suburb, San Pedro. Among other prominent industries are the manufacture of cotton and woollen goods, leather, furniture, hats and sweetmeats. Guadalajara was founded in 1531 by Nuño de Guzman, and became the seat of a bishop in 1549. The Calderon bridge near the city was the scene of a serious defeat of the revolutionists under Hidalgo in January 1811. The severe earthquake of the 31st of May 1818 partially destroyed the two cathedral steeples; and that of the 11th of March 1875 damaged many of the larger buildings. The population includes large Indian and mestizo elements.

GUADALAJARA, a province of central Spain, formed in 1833 of districts taken from New Castile; bounded on the N. by Segovia, Soria and Saragossa, E. by Saragossa and Teruel, S. by Cuenca and W. by Madrid. Pop. (1900) 200,186; area, 4676 sq. m. Along the northern frontier of Guadalajara rise the lofty Guadarrama mountains, culminating in the peaks of La Cebollera (6955 ft.) and Ocejón (6775 ft.); the rest of the province, apart from several lower ranges in the east, belongs to the elevated plateau of New Castile, and has a level or slightly undulating surface, which forms the upper basin of the river Tagus, and is watered by its tributaries the Tajuña, Henares, Jarama and Gallo. The climate of this region, as of Castile generally, is marked by the extreme severity of its winter cold and summer heat; the soil varies very much in quality, but is fertile enough in many districts, notably the cornlands of the Alcarria, towards the south. Few of the cork and oak forests which formerly covered the mountains have escaped destruction;

and the higher tracts of land are mainly pasture for the sheep and goats which form the principal wealth of the peasantry. Grain, olive oil, wine, saffron, silk and flax are produced, but agriculture makes little progress, owing to defective communications and unscientific farming. In 1903, the only minerals worked were common salt and silver, and the total output of the mines was valued at £25,000. Deposits of iron, lead and gold also exist and were worked by the Romans; but their exploitation proved unprofitable when renewed in the 19th century. Trade is stagnant and the local industries are those common to almost all Spanish towns and villages, such as the manufacture of coarse cloth and pottery. The Madrid-Saragossa railway traverses the province for 70 m.; the roads are ill-kept and insufficient. Guadalajara (11,144) is the capital, and the only town with more than 5000 inhabitants; Molina de Aragón, a fortified town built at the foot of the Parameras de Molina (2500-3500 ft.), and on the right bank of the Gallo, a tributary of the Tagus, is of some importance as an agricultural centre. Sigüenza, on the railway, is an episcopal city, with a fine Romanesque cathedral dating from the 11th century. It is probably the ancient *Segontia*, founded in 218 B.C. by refugees from Saguntum. The population of the province, which numbers only 42 per sq. m., decreased slightly between 1870 and 1900, and extreme poverty compels many families to emigrate (see also CASTILE).

GUADALAJARA, the capital of the Spanish province of Guadalajara, on the left bank of the river Henares, and on the Madrid-Saragossa railway, 35 m. E.N.E. of Madrid. Pop. (1900) 11,144. Guadalajara is a picturesque town, occupying a somewhat sterile plain, 2100 ft. above the sea. A Roman aqueduct and the Roman foundations of the bridge built in 1758 across the Henares bear witness to its antiquity. Under Roman and Visigothic rule it was known as *Arriaca* or *Carsaca*; its present name, which sometimes appears in medieval chronicles as *Godelfare*, represents the *Wad-al-hajarah*, or "Valley of Stones," of the Moors, who occupied the town from 714 until 1081, when it was captured by Alvar Yañez de Minaya, a comrade of the more famous Cid. The church of Santa María contains the image of the "Virgin of Battles," which accompanied Alphonso VI. of Castile (1072-1109) on his campaigns against the Moors; and there are several other ancient and interesting churches in Guadalajara, besides two palaces, dating from the 15th century, and built with that blend of Christian and Moorish architecture which Spaniards call the *Mudéjar* style. The more important of these is the palace of the ducal house del Infantado, formerly owned by the Mendoza family, whose *panteon*, or mausoleum, added between 1696 and 1720 to the 15th-century church of San Francisco, is remarkable for the rich sculpture of its tombs. The town and provincial halls date from 1585, and the college of engineers was originally built by Philip V., early in the 18th century, as a cloth factory. Manufactures of soap, leather, woollen fabrics and bricks have superseded the original cloth-weaving industry for which Guadalajara was long celebrated; there is also a considerable trade in agricultural produce.

GUADALQUIVIR (ancient *Baetis*, Moorish *Wadi al Kebir*, "the Great River"), a river of southern Spain. What is regarded as the main stream rises 4475 ft. above sea-level between the Sierra de Cazorla and Sierra del Pozo, in the province of Jaen. It does not become a large river until it is joined by the Guadiana Menor (Guadianamenor) on the left, and the Guadalimar on the right. Lower down it receives many tributaries, the chief being the Genil or Jenil, from the left. The general direction of the river is west by south, but a few miles above Seville it changes to south by west. Below Coria it traverses the series of broad fens known as Las Marismas, the greatest area of swamp in the Iberian Peninsula. Here it forms two subsidiary channels, the western 31 M., the eastern 12 m. long, which rejoin the main stream on the borders of the province of Cadiz. Below Sanlúcar the river enters the Atlantic after a total course of 360 m. It drains an area of 21,869 sq. m. Though the shortest of the great rivers of the peninsula, it is the only one which flows at all seasons

with a full stream, being fed in winter by the rains, in summer by the melted snows of the Sierra Nevada. In the time of the Moors it was navigable up to Cordova, but owing to the accumulation of silt in its lower reaches it is now only navigable up to Seville by vessels of 1000 to 1500 tons.

GUADELOUPE, a French colony in the West Indies, lying between the British islands of Montserrat on the N., and Dominica on the S., between 15° 59' and 16° 20' N. and 61° 31' and 62° 50' W. It consists of two entirely distinct islands, separated by a narrow arm of the sea, Rivière Salée (Salt river), varying from 100 ft. to 400 ft. in width and navigable for small vessels. The western island, a rugged mass of ridges, peaks and lofty uplands, is called Basse-Terre, while the eastern and smaller island, the real low-land, is known as Grande-Terre. A sinuous ridge runs through Basse-Terre from N. to S. In the north-west rises the peak of Grosse Montagne (2370 ft.), from which sharp spurs radiate in all directions; near the middle of the west coast are the twin heights of Les Mamelles (2536 ft. and 2368 ft.). Farther south the highest elevation is attained in La Soufrière (4900 ft.). In 1797 this volcano was active, and in 1843 its convulsions laid several towns in ruins; but a few thermal springs and solfataras emitting vapour are now its only signs of activity. The range terminates in the extreme south in the jagged peak of Caraipe (2300 ft.). Basse-Terre is supremely beautiful, its cloud-capped mountains being clothed with a mantle of luxuriant vegetation. On Grande-Terre the highest elevation is only 450 ft., and this island is the seat of extensive sugar plantations. It consists of a plain composed mainly of limestone and a conglomerate of sand and broken shells known as *macousse de bon dieu*, much used for building. The bay between the two sections of Guadeloupe on the north is called Grand Cul-de-Sac Marie, that on the south being Petit Cul-de-Sac Marie. Basse-Terre (364 sq. m.) is 28 m. long by 12 m. to 15 m. wide; Grande-Terre (255 sq. m.) is 22 m. long from N. to S., of irregular shape, with a long peninsula, Chateaux Point, stretching from the south-eastern extremity. Basse-Terre is watered by a considerable number of streams, most of which in the rainy season are liable to sudden floods (locally called *gallions*), but Grande-Terre is practically destitute of springs, and the water-supply is derived almost entirely from ponds and cisterns.

The west half of the island consists of a foundation of old eruptive rocks upon which rest the recent accumulations of the great volcanic cones, together with mechanical deposits derived from the denudation of the older rocks. Grande-Terre on the other hand, consists chiefly of nearly horizontal limestones lying conformably upon a series of fine tuffs and ashes, the whole belonging to the early part of the Tertiary system (probably Eocene and Oligocene). Occasional deposits of marl and limestone of late Pliocene age rest unconformably upon these older beds; and near the coast there are raised coral reefs of modern date.

The mean annual temperature is 78° F., and the minimum 61° F., and the maximum 101° F. From July to November heavy rains fall, the annual average on the coast being 86 in., while in the interior it is much greater. Guadeloupe is subject to terrible storms. In 1825 a hurricane destroyed the town of Basse-Terre, and Grand Bourg in Marie Galante suffered a like fate in 1865. The soil is rich and fruitful, sugar having long been its staple product. The other crops include cereals, cocoa, cotton, manioc, yams and rubber; tobacco, vanilla, coffee and bananas are grown, but in smaller quantities. Over 30% of the total area is under cultivation, and of this more than 50% is under sugar. The centres of this industry are St Anne, Pointe-à-Pitre and Le Moule, where there are well-equipped *usines*, and there is also a large *usine* at Basse-Terre. The forests, confined to the island of Basse-Terre, are extensive and rich in valuable woods, but, being difficult of access, are not worked. Salt and sulphur are the only minerals extracted, and in addition to the sugar *usines*, there are factories for the making of rum, liqueurs, chocolate, besides fruit-canning works and tanneries. France takes most of the exports, and next to France, the United States, Great Britain and India are the countries most interested in the import trade.

The inhabitants of Guadeloupe consist of a few white officials and planters, a few East Indian immigrants from the French possessions in India, and the rest negroes and mulattoes. These mulattoes are famous for their grace and beauty of both form and feature. The women greatly outnumber the men, and there is a very large percentage of illegitimate births. Pop. (1900) 182,112.

The governor is assisted by a privy council, a director of the interior, a procurator-general and a paymaster, and there is also an elected legislative council of 30 members. The colony forms a department of France and is represented in the French parliament by a senator and two deputies. Political elections are very eagerly contested, the mulatto element always striving to gain the preponderance of power.

The seat of government, of the Apostolic administration and of the court of appeal is at Basse-Terre (7768), which is situated on the south-west coast of the island of that name. It is a picturesque, healthy town standing on an open roadside. Pointe-à-Pitre (17,242), the largest town, lies in Grande-Terre near the mouth of the Rivière Salée. Its excellent harbour has made it the chief port and commercial capital of the colony. Le Moule (10,378) on the east coast of Grande-Terre does a considerable export trade in sugar, despite its poor harbour. Of the other towns, St Anne (9497), Morne à l'Eau (8442), Petit Canal (6748), St François (5265), Petit Bourg (5110) and Trois Rivières (5016), are the most important.

Round Guadeloupe are grouped its dependencies, namely, La Desirade, 6 m. E., a narrow rugged island 10 sq. m. in area; Marie Galante 16 m. S.E. Les Saintes, a group of seven small islands, 7 m. S., one of the strategic points of the Antilles, with a magnificent and strongly fortified naval harbour; St Martin, 142 m. N.N.W.; and St Bartholomew, 130 m. N.N.W.

History.—Guadeloupe was discovered by Columbus in 1495, and received its name in honour of the monastery of S. Maria de Guadalupe at Estremadura in Spain. In 1635 l'Olive and Duplessis took possession of it in the name of the French Company of the Islands of America, and l'Olive exterminated the Caribs with great cruelty. Four chartered companies were ruined in their attempts to colonise the island, and in 1674 it passed into the possession of the French crown and long remained a dependency of Martinique. After unsuccessful attempts in 1666, 1691 and 1703, the British captured the island in 1759, and held it for four years. Guadeloupe was finally separated from Martinique in 1775, but it remained under the governor of the French Windward Islands. In 1782 Rodney defeated the French fleet near the island, and the British again obtained possession in April 1794, but in the following summer they were driven out by Victor Hugues with the assistance of the slaves whom he had liberated for the purpose. In 1802 Bonaparte, then first consul, sent an expedition to the island in order to re-establish slavery, but, after a heroic defence, many of the negroes preferred suicide to submission. During the Hundred Days in 1810, the British once more occupied the island, but, in spite of its cession to Sweden by the treaty of 1813 and a French invasion in 1814, they did not withdraw till 1816. Between 1816 and 1823 the code of laws peculiar to the island was introduced. Municipal institutions were established in 1837; and slavery was finally abolished in 1848.

GUADET, MARGUERITE ÉLIE (1758—1794), French Revolutionist, was born at St Émilien near Bordeaux on the 20th of July 1758. When the Revolution broke out he had already gained a reputation as a brilliant advocate at Bordeaux. In 1790 he was made administrator of the Gironde and in 1791 president of the criminal tribunal. In this year he was elected to the Legislative Assembly as one of the brilliant group of deputies known subsequently as Girondins or Girondists. As a supporter of the constitution of 1791 he joined the Jacobin club, and here and in the Assembly became an eloquent advocate of all the measures directed against real or supposed traitors to the constitution. He bitterly attacked the ministers of Louis XVI., and was largely instrumental in forcing the king to accept the Girondist ministry of the 13th of March 1792. He was

an ardent advocate of the policy of forcing Louis XVI. into harmony with the Revolution; moved (May 3) for the dismissal of the king's non-juring confessor, for the banishment of all non-juring priests (May 16), for the disbandment of the royal guard (May 30), and the formation in Paris of a camp of *feblés* (June 4). He remained a royalist, however, and with Gensonné and Vergniaud even addressed a letter to the king soliciting a private interview. Whatever negotiations may have resulted, however, were cut short by the insurrection of the 10th of August. Guadet, who presided over the Assembly during part of this fateful day, put himself into vigorous opposition to the insurrectionary Commune of Paris, and it was on his motion that on the 30th of August the Assembly voted its dissolution—a decision reversed on the following day. In September Guadet was returned by a large majority as deputy to the Convention. At the trial of Louis XVI. he voted for an appeal to the people and for the death sentence, but with a respite pending appeal. In March 1793 he had several conferences with Danton, who was anxious to bring about a *rapprochement* between the Girondists and the Mountain during the war in La Vendée, but he unconditionally refused to join hands with the man whom he held responsible for the massacres of September. Involved in the fall of the Girondists, and his arrest being decreed on the 2nd of June 1793, he fled to Caen, and afterwards hid in his father's house at St. Émilion. He was discovered and taken to Bordeaux, where, after his identity had been established, he was guillotined on the 17th of June 1794.

See J. Guadet, *Les Girondins* (Paris, 1889); and F. A. Aulard, *Les Orateurs de la législative et de la convention* (Paris, 2nd ed., 1906).

GUADIANA (anc. *Anas*, Moorish *Wadi Ana*), a river of Spain and Portugal. The Guadiana was long believed to rise in the lowland known as the Campo de Montiel, where a chain of small lakes, the Lagunas de Ruidera (partly in Ciudad Real, partly in Albacete), are linked together by the Guadiana Alto or Upper Guadiana. This stream flows north-westward from the last lake and vanishes underground within 3 m. of the river Zancara or Giguela. About 22 m. S.W. of the point of disappearance, the Guadiana Alto was believed to re-emerge in the form of several large springs, which form numerous lakes near the Zancara and are known as the "eyes of the Guadiana" (*los ojos de Guadiana*). The stream which connects them with the Zancara is called the Guadiana Bajo or Lower Guadiana. It is now known that the Guadiana Alto has no such course, but flows underground to the Zancara itself, which is the true "Upper Guadiana." The Zancara rises near the source of the Júcar, in the east of the tableland of La Mancha; thence it flows westward, assuming the name of Guadiana near Ciudad Real, and reaching the Portuguese frontier 6 m. S.W. of Badajoz. In piercing the Sierra Morena it forms a series of foaming rapids, and only begins to be navigable at Mertola, 42 m. from its mouth. From the neighbourhood of Badajoz it forms the boundary between Spain and Portugal as far as a point near Monsaraz, where it receives the small river Priega Muñoz on the left, and passes into Portuguese territory, with a southerly direction. At Pomarão it again becomes a frontier stream and forms a broad estuary 25 m. long. It enters the Gulf of Cadiz between the Portuguese town of Villa Real de Santo Antonio and the Spanish Ayamonte, after a total course of 510 m. Its mouth is divided by sandbanks into many channels. The Guadiana drains an area of 31,940 sq. m. Its principal tributaries are the Zujar, Jabalón, Matachel and Ardila from the left; the Bullaque, Ruecas, Botoa, Degebe and Cobres from the right.

The **GUADIANA MENOR** (or *Guadianamenor*, i.e. "Lesser Guadiana") rises in the Sierra Nevada, receives two large tributaries, the Fardes from the right and Barbata from the left, and enters the Guadalquivir near Ubeda, after a course of 95 m.

GUADIX, a city of southern Spain, in the province of Granada; on the left bank of the river Guadix, a tributary of the Guadiana Menor, and on the Madrid-Valdepeñas-Almería railway. Pop. (1900) 12,652. Guadix occupies part of an elevated plateau among the northern foothills of the Sierra Nevada. It is surrounded by ancient walls, and was formerly dominated by a

Moorish castle, now in ruins. It is an episcopal see of great antiquity, but its cathedral, built in the 18th century on the site of a mosque, possesses little architectural merit. The city was once famous for its cutlery; but its modern manufactures (chiefly earthenware, hempen goods, and hats) are inconsiderable. It has some trade in wool, cotton, flax, corn and liquors. The warm mineral springs of Graena, much frequented during the summer, are 6 m. W. Guadix el Viejo, 5 m. N.W., was the Roman *Acet*, and, according to tradition, the seat of the first Iberian bishopric, in the 2nd century. After 711 it rose to some importance as a Moorish fortress and trading station, and was renamed *Wad Ash*, "Water of Life." It was surrendered without a siege to the Spaniards, under Ferdinand and Isabella, in 1489.

GUADUAS, a town of the department of Cundinamarca, Colombia, 53 m. N.W. of Bogotá on the old road between that city and the Magdalena river port of Honda. Pop. (1900, estimate) 9000, chiefly Indians or of mixed blood. It stands in a narrow and picturesque valley formed by spurs of the Eastern Cordillera, and on a small stream bearing the same name, which is that of the South American bamboo (*guaduas*), found in great abundance along its banks. Sugar-cane and coffee are cultivated in the vicinity, and fruits of various kinds are produced in great abundance. The elevation of the town is 3353 ft. above the sea, and it has a remarkably uniform temperature throughout the whole year. Guaduas has a pretty church facing upon its *plaza*, and an old monastery now used for secular purposes. The importance of the town sprang from its position on the old *camino real* between Bogotá and Honda, an importance that has passed away with the completion of the railway from Girardot to the Bogotá plateau. Guaduas was founded in 1614.

GUAJACUM, a genus of trees of the natural order *Zygophyllaceae*. The guaiacum or lignum-vitae tree (Ger. *Guajakbaum*, *Franzosenbaum*, *Pochenholzbaum*; Fr. *Goyac*, *Galac*), *G. officinale*, is a native of the West Indies and the north coast of South America, where it attains a height of 20 to 30 ft. Its branches are numerous, flexuous and knotted; the leaves opposite and pinnate, with caducous (falling early) stipules, and entire, glabrous, obovate or oval leaflets, arranged in 2 or, more rarely, 3 pairs; the flowers are in axillary clusters (cymes), and have 5 oval pubescent sepals, 5 distinct pale-blue petals three times the length of the sepals, 10 stamens, and a 2-celled superior ovary. The fruit is about $\frac{1}{2}$ in. long, with a leathery pericarp, and contains in each of its two cells a single seed (see fig.). *G. sanctum* grows in the Bahamas and Cuba, and at Key West in Florida. It is distinguished from *G. officinale* by its smaller and narrow leaflets, which are in 4 to 5 pairs, by its shorter and glabrous sepals, and 5-celled and 5-winged fruit. *G. arboreum*, the guaiacum tree of Colombia, is found in the valley of the Magdalena up to altitudes 800 metres (2625 ft.) above sea-level, and reaches considerable dimensions. Its wood is of a yellow colour merging into green, and has an almost pulverulent fracture; the flowers are yellow and conspicuous; and the fruit is dry and 4-winged.

The lignum vitae of commerce, so named on account of its high repute as a medicinal agent in past times, when also it was known as *lignum sanctum* and *lignum Indicum*, *lignum guayconum*, or simply *guayacas*, is procured from *G. officinale*, and in smaller amount from *G. sanctum*. It is exported in large logs or blocks, generally divested of bark, and presents in transverse section very slightly marked concentric rings of growth, and scarcely any traces of pith; with the aid of a magnifying glass the medullary rays are seen to be equidistant and very numerous. The outer wood, the sapwood or alburnum, is of a pale yellow hue, and devoid of resin; the inner, the heartwood or duramen, which is by far the larger proportion, is of a dark greenish-brown, contains in its pores 26% of resin, and has a specific gravity of 1.333, and therefore sinks in water on which the alburnum floats. Owing to the diagonal and oblique arrangement of the successive layers of its fibres, the wood cannot be split; and on account of its hardness, density and durability it is much valued for the manufacture of ships' pulleys, rulers, skittle-balls, mallets and other articles.

Chips or turnings of the heartwood of *G. officinale* (*guaiaci lignum*) are employed in the preparation of the *liquor sereno compositis concentratus* of British pharmacy. They may be recognized by being either yellow or greenish-brown in colour, and by turning bluish-green when treated with nitric acid, or when heated with corrosive sublimate, and green with solution



From Bentley & Trimen's *Medicinal Plants*, by permission of J. & A. Churchill.

Guaiacum or Lignum Vitae. *Guaiacum officinale* shoot-bearing leaves and flowers. 1, Fruit; 2, Vertical section of fruit, showing the solitary pendulous seed in each chamber. All about $\frac{1}{2}$ natural size.

of chloride of lime. They are occasionally adulterated with boxwood shavings. Lignum vitae is imported chiefly from St Domingo, the Bahamas and Jamaica.

The bark was formerly used in medicine; it contains much calcium oxalate, and yields on incineration 23% of ash. Guaiacum resin, the *guaiaci resina* of pharmacopoeias, is obtained from the wood as an exudation from natural fissures or from incisions; by heating billets about 3 ft. in length, bored to permit of the outflow of the resin; or by boiling chips and raspings in water to which salt has been added to raise the temperature of ebullition. It occurs in rounded or oval tears, commonly coated with a greyish-green dust, and supposed to be the produce of *G. sanctum*, or in large brownish or greenish-brown masses, translucent at the edges; fuses at 85° C.; is brittle, and has a vitreous fracture, and a slightly balsamic odour, increased by pulverization and by heat; and is at first tasteless when chewed, but produces subsequently a sense of heat in the throat. It is readily soluble in alcohol, ether, chloroform, creosote, oil of cloves and solutions of caustic alkalies; and its solution gives a blue colour with gluten, raw potato parings and the roots of horse-radish, carrot and various other plants. The alcoholic tincture becomes green with sodium hypochlorite, and with nitric acid turns in succession green, blue and brown. With glycerin it gives a clear solution, and with nitrous ether a bluish-green gelatinous mass. It is bleued by various oxidizing agents, e.g. ozone, and, as Schönbein discovered, by the juice of certain fungi. The chief constituents are three distinct resins, *guaiacolic acid*, $C_{17}H_{24}O_2$ (70%), *guaiacic acid*, which is closely allied to benzoic acid, and *guaiaric acid*. Like all resins, these are insoluble in water, soluble in alkalies, but precipitated on neutralization of the alkaline solution.

Guaiacum wood was first introduced into Europe by the Spaniards in 1508, and Nicolaus Poll, writing in 1517 (see Luisinus, *De morbo gallico*, p. 210, Ven., 1566), states that some three thousand persons in Spain had already been restored to health by it. The virtues of the resin, however, were not known until a later period, and in Thomas Paynel's translation (*Of the Wood called Guaiacum*, &c., p. 9, ed. of 1540) of Ulrich von Hutten's treatise *De morbi gallici curatio per administrationem ligni guaiaci* (1519) we read of the wood: "There foloweth fro it, when it bourneth a gomme, which we yet knowe not, for what purpose it serueth." Flückiger and Hanbury (*Pharmacographia*, p. 95) state that the first edition of the *London Pharmacopoeia* in which they find the resin mentioned is that of 1677. The decoction of the wood was administered in gout, the stone, palsy, leprosy, dropsy, epilepsy, and other diseases, but principally in the "morbus gallicus" or syphilis, for which it was reckoned a certain specific, inasmuch that at first "the physicians wolde not allowe it, perceyvinge that theyr profite wolde decay thereby" (Paynel, *op. cit.* p. 8). Minute instructions are given in old works as to the mode of administering guaiacum. The patient was confined in a closed and heated chamber, was placed on the lowest possible diet, and, after liberal purgation, was made twice a day to drink a milk-warm decoction of the wood. The

use of salt was specially to be avoided. A decoction of 1 lb of guaiacum was held to be sufficient for the four first days of the treatment. The earlier opinions as to the efficacy of guaiacum came to be much modified in the course of time, and Dr Pearson (*Observations on the Effects of Variens Articles of the Mat. Med. in the Cure of Lues Venerea*, c. 1., 2nd ed., 1807) says:—"I never saw one single instance in which the powers of this medicine eradicated the venereal virus." He found its beneficial effects to be most marked in cases of secondary symptoms. Guaiacum resin is given medicinally in doses of 5-15 grains. Its important preparations in the British Pharmacopoeia are the *mistura guaiaci* (dose $\frac{1}{2}$ -1 oz.), the ammoniated tincture of guaiacum (dose $\frac{1}{2}$ -1 drachm), in which the resin is dissolved by means of ammonia, and the trochiscus or lozenge, containing $\frac{1}{2}$ grains of the resin. This lozenge is undoubtedly of value when given early in cases of sore throat, especially of rheumatic origin. Powdered guaiacum is also used.

Guaiacum resin differs pharmacologically from other resins in being less irritant, so that it is absorbed from the bowel and exerts remote stimulant actions, notably upon the skin and kidneys. It affects the bronchi but slightly, since it contains no volatile oil.

The drug is useful both in acute and chronic sore throat, the mixture, according to Sir Lauder Brunton, being more effective than the tincture. The aperient action, which it exerts less markedly than other members of its class, renders it useful in the treatment of chronic constipation. Sir Alfred Garrod has urged the claims of this drug in the treatment of chronic gout. Both in this disease and in other forms of chronic arthritis guaiacum may be given in combination with iodides, which it often enables the patient to tolerate. Guaiacum is not now used in the treatment of syphilis.

The tincture of guaiacum is universally used as a test for the presence of blood, or rather of haemoglobin, the red colouring matter of the blood, in urine or other secretions. This test was first suggested by Dr John Day of Geelong, Australia. A single drop of the tincture should be added to, say, an inch of urine in a test-tube. The resin is at once precipitated, yielding a milky fluid. If "ozonic ether"—an ethereal solution of hydrogen peroxide—be now poured gently into the test-tube, a deep blue coloration is produced along the line of contact if haemoglobin be present. The reaction is due to the oxidation of the resin by the peroxide of hydrogen—such oxidation occurring only if haemoglobin be present to act as an oxygen-carrier.

GUALDO TADINO (anc. *Tadinum*, 1 m. to the W.), a town and episcopal see of Umbria, Italy, 1755 ft. above sea-level, in the province of Perugia, 22 m. N. of Foligno by rail. Pop. (1901), town, 4440; commune, 10,756. The suffix Tadino distinguishes it from Gualdo in the province of Macerata, and Gualdo Cattaneo, S.W. of Foligno. The cathedral has a good rose-window and possesses, like several of the other churches, 15th-century paintings by Umbrian artists, especially works by Niccolò Alunno. The town is still surrounded by walls. The ancient Tadinum lay 1 m. to the W. of the modern town. It is mentioned in the Eugubine tablets (see IGUVVU) as a hostile city against which imprecations are directed. In its neighbourhood Narnes defeated and slew Totila in 552. No ruins are now visible, though they seem to have been extant in the 17th century. The new town seems to have been founded in 1237. It was at first independent, but passed under Perugia in 1292, and later became dependent on the duchy of Spoleto.

GUALEGUAY, a flourishing town and river port of the province of Entre Rios, Argentine Republic, on the Gualeguay river, 32 m. above its confluence with the Ibicuy branch of the Paraná, and about 120 m. N.N.W. of Buenos Aires. Pop. (1895) 7810. The Gualeguay is the largest of the Entre Rios rivers, traversing almost the whole length of the province from N. to S., but it is of but slight service in the transportation of produce except the few miles below Gualeguay, whose port, known as Puerto Ruiz; is 7 m. lower down stream. A steam tramway connects the town and port, and a branch line connects with Entre Rios railways at the station of Tala. The principal industry in this region is that of stock-raising, and there is a large exportation of cattle, jerked beef, hides, tallow, mutton, wool and sheep-skins. Wood and charcoal are also exported to Buenos Aires. The town was founded in 1783.

GUALEGUAYCHÚ, a prosperous commercial and industrial town and port of the province of Entre Rios, Argentine Republic, on the left bank of the Gualeguaychú river, 11 m. above its confluence with the Uruguay, and 120 m. N. of Buenos Aires. Pop. (1892, est.) 14,000. It is the chief town of a department of the same name, the largest in the province. A bar at the mouth of the river prevents the entrance of larger vessels and

compels the transfer of cargoes to and from lighters. The town is surrounded by a rich grazing country, and exports cattle, jerked beef, mutton, hides, pelts, tallow, wool and various by-products. A branch line running N. connects with the Entre Rios railways at Basavilbaso. The town was founded in 1783.

GUALO, CARDINAL (fl. 1216), was sent to England by Pope Innocent III. in 1216. He supported John with all the weight of papal authority. After John's death he crowned the infant Henry III. and played an active part in organizing resistance to the rebels led by Louis of France, afterwards king Louis VIII. As representing the pope, the suzerain of Henry, he claimed the regency and actually divided the chief power with William Marshal, earl of Pembroke. He proclaimed a crusade against Louis and the French, and, after the peace of Lambeth, he forced Louis to make a public and humiliating profession of penitence (1217). He punished the rebellious clergy severely, and ruled the church with an absolute hand till his departure from England in 1218. Gualo's character has been severely criticized by English writers; but his chief offence seems to have been that of representing unpopular papal claims.

GUAM (Span. *Guajan*; *Gwahan*, in the native Chamorro), the largest and most populous of the Ladrone or Mariana Islands, in the North Pacific, in 13° 26' N. lat. and 144° 39' E. long., about 1823 m. E. by S. of Hong Kong, and about 1450 m. E. of Manila. Pop. (1908) about 11,360, of whom 363 were foreigners, 140 being members of the U.S. naval force. Guam extends about 30 m. from N.N.E. to S.S.W., has an average width of about 6½ m., and has an area of 207 sq. m. The N. portion is a plateau from 300 to 600 ft. above the sea, lowest in the interior and highest along the E. and W. coast, where it terminates abruptly in bluffs and headlands; Mt. Santa Rosa, toward the N. extremity, has an elevation of 840 ft. A range of hills from 700 to nearly 1300 ft. in height traverses the S. portion from N. to S. a little W. of the middle—Mt. Jumullong Mangloc, the highest peak, has an elevation of 1274 ft. Between the foot of the steep W. slope of these hills and the sea is a belt of rolling lowlands and to the E. the surface is broken by the valleys of five rivers with a number of tributaries, has a general slope toward the sea, and terminates in a coast-line of bluffs. Apra (formerly San Luis d'Apra) on the middle W. coast is the only good harbour; it is about 3½ m. across, has a depth of 4-27 fathoms, and is divided into an inner and an outer harbour by a peninsula and an island. It serves as a naval station and as a port of transit between America and the Philippines, at which army transports call monthly. Deer, wild hog, duck, curlew, snipe and pigeon are abundant game, and several varieties of fish are caught. Some of the highest points of the island are nearly bare of vegetation, and the more elevated plateau surface is covered with sword grass, but in the valleys and on the lower portions of the plateaus there is valuable timber. The lowlands have a rich soil; in lower parts of the highlands raised coralliferous limestone with a light covering of soil appears, and in the higher parts the soil is entirely of clay and silt. The climate is agreeable and healthy. From December to June the N.E. trade winds prevail and the rainfall is relatively light; during the other six months the monsoon blows and produces the rainy season. Destructive typhoons and earthquakes sometimes visit Guam. The island is thought to possess little if any mineral wealth, with the possible exception of coal. Only a small part of Guam is under cultivation, and most of this lies along the S.W. coast, its chief products being coconuts, rice, sugar, coffee and cacao. A United States Agricultural Experiment Station in Guam (at Agaña) was provided for in 1908.

The inhabitants are of the Chamorro (Indonesian) stock, strongly intermixed with Philippine Tagals and Spaniards; their speech is a dialect of Malay, corrupted by Tagal and Spanish. There are very few full-blood Chamorros. The aboriginal native was of a very dark mahogany or chocolate colour. A majority of the total number of natives live in Agaña. The natives are nearly all farmers, and most of them are poor, but their condition has been improved under American rule. Public

schools have been established; in 1908 the enrolment was 1700. On the island there is a small colony of lepers, segregated only after American occupation. Gangraena is a disease said to be peculiar to Guam and the neighbouring islands; it is due to a specific bacillus and usually destroys the nasal septum. The victims of this disease also are segregated. There is a good general hospital.

Agaña (or San Ignacio de Agaña) is the capital and principal town; under the Spanish régime it was the capital of the Ladrone. It is about 5 m. N.E. of Piti, the landing-place of Apra harbour and port of entry, with which it is connected by an excellent road. Agaña has paved streets and sewer and water systems. Other villages, all small, are Asan, Piti, Sumay, Umata, Merizo and Inarajan. Guam is governed by a "naval governor," an officer of the U.S. navy who is commandant of the naval station. The island is divided into four administrative districts, each with an executive head called a gubernadorcillo (commissioner), and there are a court of appeals, a court of first instance and courts of justices of the peace. Peonage was abolished in the island by the United States in February 1900. Telegraphic communication with the Caroline Islands was established in 1905; in 1908 there were four cables ending at the relay station at Sumay on the Shore of Apra harbour.

Guam was discovered by Magellan in 1521, was occupied by Spain in 1688, was captured by the United States cruiser "Charleston" in June 1890, and was ceded to the United States by the Treaty of Paris on the 10th of December 1898.

See *A List of Books (with References to Periodicals) on Samoa and Guam* (1901; issued by the Library of Congress); L. M. Cox, "The Island of Guam," in *Bulletin of the American Geographical Society*, vol. 36 (New York, 1904); Gen. Joseph Wheeler, *Report on the Island of Guam*, June 1900 (War Department, Document No. 123); F. W. Christian, *The Caroline Islands* (London, 1899); an account of the flora of Guam by W. E. Safford in the publications of the National Herbarium (Smithsonian Institution); and the reports of the naval governor.

GUAN, a word apparently first introduced into the ornithologist's vocabulary about 1743 by Edwards, who said that a bird he figured (*Nat. Hist. Uncommon Birds*, pl. xiii.) was "so called in the West Indies," and the name has hence been generally applied to all the members of the subfamily *Penelopinae*, which are distinguished from the kindred subfamily *Cracinae* or curassows by the broad postacetabular area of the pelvis as pointed out by Huxley (*Proc. Zool. Society*, 1868, p. 297) as well as by their maxilla being wider than it is high, with its culmen depressed, the crown feathered, and the nostrils bare—the last two characters separating the *Penelopinae* from the *Oreophasinae*, which form the third subfamily of the *Cracidae*, a family belonging to that taxonomer's division *Peristeropodes* of the order *Gallinae*.

The *Penelopinae* have been separated into seven genera, of which *Penelope* and *Oriolus*, containing respectively about sixteen and nineteen species, are the largest, the others numbering from one to three only. Into their minute differences it would be useless to enter: nearly all have the throat bare of feathers, and from that of many of them hangs a wattle; but one form, *Chamaepetes*, has neither of these features, and *Stegnolaema*, though wattled, has the throat clothed. With few exceptions the guans are confined to the South-American continent; one species of *Penelope* is however found in Mexico (e.g. at Mazatlan), *Pipile cumanensis* inhabits Trinidad as well as the mainland, while three species of *Oriolus* occur in Mexico or Texas, and one, which is also common to Venezuela, in Tobago. Like curassows, guans are in great measure of arboreal habit. They also readily

¹ Edwards also gives "quan" as an alternative spelling, and this may be nearer the original form, since we find Dampier in 1676 writing (*Voy. ii. pt. 2, p. 66*) of what was doubtless an allied if not the same bird as the "quam." The species represented by Edwards does not seem to have been identified.

² See the excellent *Synopsis* by Sclater and Salvin in the *Proceedings of the Zoological Society* for 1870 (pp. 504-544), while further information on the *Cracinae* was given by Sclater in the *Transactions of the same society* (ix. pp. 273-288, pls. xl-lliii.). Some additions have since been made to the knowledge of the family, but none of very great importance.

become tame, but all attempts to domesticate them in the full sense of the word have wholly failed, and the cases in which they have even been induced to breed and the young have been reared in confinement are very few. Yet it would seem that guans and curassows will interbreed with poultry (*Ibis*, 1866, p. 24; *Bull. Soc. Imp. d'Acclimatation*, 1868, p. 539; 1869, p. 357), and what is more extraordinary is that in Texas the hybrids between the chiacalacca (*Oryzopsis peruviana*) and the domestic fowl are asserted to be far superior to ordinary game-cocks for fighting purposes. (A. N.)

GUANABACOA (an Indian name meaning "site of the waters"), a town of Cuba, in Havana province, about 6 m. E. of Havana. Pop. (1907) 14,368. Guanabacoa is served by railway to Havana, with which it is connected by the Regia ferry across the bay. It is picturesquely situated amid woods, on high hills which furnish a fine view. There are medicinal springs in the town, and deposits of liquid bitumen in the neighbouring hills. The town is essentially a residence suburb of the capital, and has some rather pretty streets and squares and some old and interesting churches (including Nuestra Señora de la Asuncion, 1714-1721). Just outside the city is the church of Potosí with a famous "wonder-working" shrine and image. An Indian pueblo of the same name existed here before 1555, and a church was established in 1576. Already at the end of the 17th century Guanabacoa was the fashionable summer residence of Havana. It enjoyed its greatest popularity in this respect from the end of the 18th to the middle of the 19th century. It was created a *villa* with an *ayuntamiento* (city council) in 1743. In 1762 its fort, the Little Morro, on the N. shore near Cojimar (a bathing beach, where the Key West cable now lands), was taken by the English.

GUANACO, sometimes spelt Huanaca, the larger of the two wild representatives in South America of the camel tribe; the other being the vicuña. The guanaco (*Lama huanacus*), which stands nearly 4 ft. at the shoulder, is an elegant creature, with gracefully curved neck and long slender legs, the hind-pair of the latter bearing two naked patches or callosities. The head and body are covered with long soft hair of a fawn colour above and almost pure white beneath.

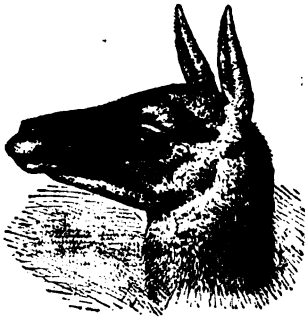

Head of Guanaco.

Guanacos are found throughout the southern half of South America, from Peru in the north to Cape Horn in the south, but occur in greatest abundance in Patagonia. They live in herds usually of from six to thirty, although these occasionally contain several hundreds, while solitary individuals are sometimes met. They are exceedingly timid, and therefore wary and difficult of approach; like many other ruminants, however, their curiosity sometimes overcomes their timidity, so as to bring them within range of the hunter's rifle. Their cry is peculiar, being something between the belling of a deer and the neigh of a horse. The chief enemies of the guanaco are the Patagonian Indians and the puma, as it forms the principal food of both. Its flesh is palatable although wanting in fat, while its skin forms the chief clothing material of the Patagonians. Guanacos are readily domesticated, and in this state become very bold and will attack man, striking him from behind with both knees. In the wild state they never defend themselves, and if approached from different points, according to the Indian fashion of hunting, get completely bewildered and fall an easy prey. They take readily to the

water, and have been observed swimming from one island to another, while they have been seen drinking salt-water. They have a habit of depositing their droppings during successive days on the same spot—a habit appreciated by the Peruvian Indians, who use those deposits for fuel. Guanaco also have favourite localities in which to die, as appears from the great heaps of their bones found in particular spots.

GUANAJAY, a town of western Cuba, in Pinar del Rio province, about 36 m. (by rail) S.W. of Havana. Pop. (1907) 6400. Guanajay is served by the W. branch of the United railways of Havana, of which it is the W. terminus. The town lies among hills, has an excellent climate, and in colonial times was (like Holguín) an acclimatization station for troops fresh from Spain; it now has considerable repute as a health resort. The surrounding country is a fertile sugar and tobacco region. Guanajay has always been important as a distributing point in the commerce of the western end of the island. It was an ancient pueblo, of considerable size and importance as early as the end of the 18th century.

GUANAJUATO, or **GUANAJUATO**, an inland state of Mexico, bounded N. by Zacatecas and San Luis Potosí, E. by Querétaro, S. by Michoacán and W. by Jalisco. Area, 11,370 sq. m. It is one of the most densely populated states of the republic; pop. (1895) 1,047,817; (1900) 1,061,724. The state lies wholly within the limits of the great central plateau of Mexico, and has an average elevation of about 6000 ft. The surface of its northern half is broken by the Sierra Gorda and Sierra de Guanajuato, but its southern half is covered by fertile plains largely devoted to agriculture. It is drained by the Rio Grande de Lerma and its tributaries, which in places flow through deeply eroded valleys. The climate is semi-tropical and healthy, and the rainfall is sufficient to insure good results in agriculture and stock-raising. In the warm valleys sugar-cane is grown, and at higher elevations Indian corn, beans, barley and wheat. The southern plains are largely devoted to stock-raising. Guanajuato has suffered much from the destruction of its forests, but there remain some small areas on the higher elevations of the north. The principal industry of the state is mining, the mineral wealth of the mountain ranges of the north being enormous. Among its mineral products are silver, gold, tin, lead, mercury, copper and opals. Silver has been extracted since the early days of the Spanish conquest, over \$800,000,000 having been taken from the mines during the subsequent three and a half centuries. Some of the more productive of these mines, or groups of mines, are the Veta Madre (mother lode), the San Bernabé lode, and the Rayas mines of Guanajuato, and the La Valenciana mine, the output of which is said to have been \$226,000,000 between 1766 and 1826. The manufacturing establishments include four mills, tanneries and manufactories of leather, cotton and woollen mills, distilleries, foundries and potteries. The Mexican Central and the Mexican National railway lines cross the state from N. to S., and the former operates a short branch from Silao to the state capital and another westward from Irapuato to Guadalajara. The capital is Guanajuato, and other important cities and towns are León, or León de las Aldamas; Celaya (pop. 25,565 in 1900), an important railway junction 22 m. by rail W. from Querétaro, and known for its manufactures of broadcloth, saddlery, soap and sweetmeats; Irapuato (18,593 in 1900), a railway junction and commercial centre, 21 m. S. by W. of Guanajuato; Silao (15,355), a railway junction and manufacturing town (woollens and cottons), 24 m. S.W. of Guanajuato; Salamanca (13,583), on the Mexican Central railway and Lerma river, 25 m. S. by E. of Guanajuato, with manufactures of cottons and porcelain; Allende (10,547), a commercial town 30 m. E. by S. of Guanajuato, with mineral springs; Valle de Santiago (12,660), 50 m. W. by S. of Querétaro; Salvatierra (10,393), 60 m. S.E. of Guanajuato; Cortazar (8633); La Luz (8518), in a rich mining district; Pénjamo (8262); Santa Cruz (7239); San Francisco del Rincón (10,904), 39 m. W. of Guanajuato in a rich mining district; and Acambaro (8345), a prosperous town of the plain, 76 m. S.S.E. of Guanajuato.

GUANAJUATO, or **SANTA FÉ DE GUANAJUATO**, a city of Mexico and capital of the above state, 155 m. (direct) N.W. of the Federal capital, on a small tributary of the Rio Grande de Lerma or Santiago. Pop. (1895) 39,404; (1900) 41,486. The city is built in the Cañada de Marfil at the junction of three ravines about 6500 ft. above the sea, and its narrow, tortuous streets rise steeply as they follow the ravines upward to the mining villages clustered about the opening of the mines in the hillsides. Guanajuato is sometimes described as a collection of mining villages; but in addition there is the central city with its crowded winding streets, its substantial old Spanish buildings, its fifty ore-crushing mills and busy factories and its bustling commercial life. Enclosing the city are the steep, barren mountain sides honeycombed with mines. The climate is semi-tropical and is considered healthy. The noteworthy public buildings and institutions are an interesting old Jesuit church with arches of pink stone and delicate carving, eight monasteries, the government palace, a mint dating from 1812, a national college, the fine Teatro Juárez, and the Pantheon, or public cemetery, with catacombs below. The Alhóndiga de Granaditas, originally a public granary, was used as a fort during the War of Independence, and is celebrated as the scene of the first battle (1810) in that long struggle. Among the manufactures are cottons, prints, soaps, chemicals, pottery and silverware, but mining is the principal interest and occupation of the population. The silver mines of the vicinity were long considered the richest in Mexico, the celebrated Veta Madre (mother lode) even being described as the richest in the world; and Guanajuato has the largest reduction works in Mexico. The railway outlet for the city consists of a short branch of the Mexican Central, which joins the trunk line at Silao. Guanajuato was founded in 1554. It attained the dignity of a city in 1741. It was celebrated for its vigorous resistance to the invaders at the time of the Spanish conquest, and was repeatedly sacked during that war.

GUANCHES, **GUANCIBIS** or **GUANCOS** (native Guanchinet; *Guan*=person, *Chinet*=Teneriffe,—"man of Teneriffe," corrupted, according to Nuñez de la Peña, by Spaniards into Guanchos), the aboriginal inhabitants of the Canary Islands. Strictly the Guanches were the primitive inhabitants of Teneriffe, where they seem to have preserved racial purity to the time of the Spanish conquest, but the name came to be applied to the indigenous populations of all the islands. The Guanches, now extinct as a distinct people, appear, from the study of skulls and bones discovered, to have resembled the Cro-Magnon race of the Quaternary age, and no real doubt is now entertained that they were an offshoot of the great race of Berbers which from the dawn of history has occupied northern Africa from Egypt to the Atlantic. Pliny the Elder, deriving his knowledge from the accounts of Juba, king of Mauretania, states that when visited by the Carthaginians under Hanno the archipelago was found by them to be uninhabited, but that they saw ruins of great buildings. This would suggest that the Guanches were not the first inhabitants, and from the absence of any trace of Mahomedanism among the peoples found in the archipelago by the Spaniards it would seem that this extreme westerly migration of Berbers took place between the time of which Pliny wrote and the conquest of northern Africa by the Arabs. Many of the Guanches fell in resisting the Spaniards, many were sold as slaves, and many conformed to the Roman Catholic faith and married Spaniards.

Such remains as there are of their language, a few expressions and the proper names of ancient chieftains still borne by certain families, connect it with the Berber dialects. In many of the islands signs are engraved on rocks. Domingo Vandewalle, a military governor of Las Palmas, was the first, in 1752, to investigate these; and it is due to the perseverance of D. Aquilino Padran, a priest of Las Palmas, that anything about the inscription on the island Hierro has been brought to light. In 1878 Dr R. Verneau discovered in the ravines of Las Balos some genuine Libyan inscriptions. Without exception the rock inscriptions have proved to be Numidic. In two of the islands (Teneriffe and Gomera) the Guanche type has been retained with

more purity than in the others. No inscriptions have been found in these two islands, and therefore it would seem that the true Guanches did not know how to write. In the other islands numerous Semitic traces are found, and in all of them are the rock-signs. From these facts it would seem that the Numidians, travelling from the neighbourhood of Carthage and intermixing with the dominant Semitic race, landed in the Canary Islands, and that it is they who have written the inscriptions at Hierro and Grand Canary.

The political and social institutions of the Guanches varied. In some islands hereditary autocracy prevailed; in others the government was elective. In Teneriffe all the land belonged to the chiefs who leased it to their subjects. In Grand Canary suicide was regarded as honourable, and on a chief inheriting, one of his subjects willingly honoured the occasion by throwing himself over a precipice. In some islands polyandry was practised; in others the natives were monogamous. But everywhere the women appear to have been respected, an insult offered any woman by an armed man being a capital offence. Almost all the Guanches used to wear garments of goat-skins, and others of vegetable fibres, which have been found in the tombs of Grand Canary. They had a taste for ornaments, necklaces of wood, bone and shells, worked in different designs. Beads of baked earth, cylindrical and of all shapes, with smooth or polished surfaces, mostly black and red in colour, were chiefly in use. They painted their bodies; the *pinaderas*, baked clay objects like seals in shape, have been explained by Dr Verneau as having been used solely for painting the body in various colours. They manufactured rough pottery, mostly without decorations, or ornamented by means of the finger-nail. The Guanches' weapons were those of the ancient races of south Europe. The polished battle-axe was more used in Grand Canary, while stone and obsidian, roughly cut, were commoner in Teneriffe. They had, besides, the lance, the club, sometimes studded with pebbles, and the javelin, and they seem to have known the shield. They lived in natural or artificial caves in their mountains. In districts where cave-dwellings were impossible, they built small round houses and, according to the Spaniards, they even practised rude fortification. In Palma the old people were at their own wish left to die alone. After bidding their family farewell they were carried to the sepulchral cave, nothing but a bowl of milk being left them. The Guanches embalmed their dead; many mummies have been found in an extreme state of desiccation, each weighing not more than 6 or 7 lb. Two almost inaccessible caves in a vertical rock by the shore 3 m. from Santa Cruz (Teneriffe) are said still to contain bones. The process of embalming seems to have varied. In Teneriffe and Grand Canary the corpse was simply wrapped up in goat and sheep skins, while in other islands a resinous substance was used to preserve the body, which was then placed in a cave difficult of access, or buried under a tumulus. The work of embalming was reserved for a special class, women for female corpses, men for male. Embalming seems not to have been universal, and bodies were often simply hidden in caves or buried.

Little is known of the religion of the Guanches. They appear to have been a distinctly religious race. There was a general belief in a supreme being, called Acoran, in Grand Canary, Achihuran in Teneriffe, Eraoranhán in Hierro, and Abora in Palma. The women of Hierro worshipped a goddess called Moneiba. According to tradition the male and female gods lived in mountains whence they descended to hear the prayers of the people. In other islands the natives venerated the sun, moon, earth and stars. A belief in an evil spirit was general. The demon of Teneriffe was called Guayota and lived in the peak of Teyde, which was the bell called Echeyde. In times of drought the Guanches drove their flocks to consecrated grounds, where the lambs were separated from their mothers in the belief that their plaintive bleatings would melt the heart of the Great Spirit. During the religious feasts all war and even personal quarrels were stayed.

BIBLIOGRAPHY.—S. Berthelot, *Antiquités canariennes* (Paris, 1839); Baker Webb and S. Berthelot, *Histoire naturelle des îles*

Canaries (Paris, 1839); Paul Broca, *Revue d'anthropologie*, iv, (1874); General L. L. C. Faidherbe, *Quelques mots sur l'ethnologie de l'archipel canarien* (Paris, 1875); Chil y Naranjo, *Estudios historicos, climatologicos y Patologicos de las Islas Canarias* (Las Palmas, 1876-1886); "De la pluralité des races humaines de l'archipel canarien," *Bull. Soc. Anthropol. Paris*, 1878; "Habitations et sépultures des anciens habitants des Iles Canaries," *Revue d'anthrop.*, 1879; R. Verocau, "Sur les Sémites aux Iles Canaries," and "Sur les anciens habitants de la Isleta, Grande Canarie," *Bull. Soc. Anthropol. Paris*, 1881; *Rapport sur une mission scientifique dans l'archipel canarien* (Paris, 1887); *Cinq années de séjour aux Iles Canaries* (Paris, 1891); H. Meyer, *Die Insel Tenerife* (Leipzig, 1896); "Über die Urbewohner der canarischen Inseln," in *Adolf Bastian Festschrift* (Berlin, 1896); F. von Luschan, *Anhang über eine Schädelammlung von den canarischen Inseln*; R. Virchow, "Schädel mit Carionecrosis der Sagittalgegend," *Verhandlungen der Berliner Anthropol. Gesellschaft* (1896); G. Sergi, *The Mediterranean Race* (London, 1901); *The Guanches of Tenerife* . . . by Alonso de Espinosa, translated by Sir Clements Markham, with bibliography (Hakluyt Society, 1907).

GUANIDINE, CN_2H_4 or $HN: C(NH_2)_2$, the amide of amidocarbonic acid. It occurs in beet juice. It was first prepared in 1861 by A. Strecker, who oxidized guanine with hydrochloric acid and potassium chlorate. It may be obtained synthetically by the action of ammonium iodide on cyanamide, $CN \cdot NH_2 + NH_4I = CN_2H_4 \cdot HI$; by heating ortho-carbonic esters with ammonia to $150^\circ C$.; but best by heating ammonium thiocyanate to $180^\circ-190^\circ C$., when the thiourea first formed is converted into guanidine thiocyanate, $2CS(NH_2)_2 = HN: C(NH_2)_2 \cdot HCNS + HS$. It is a colourless crystalline solid, readily soluble in water and alcohol; it deliquesces on exposure to air. It has strong basic properties, absorbs carbon dioxide readily, and forms well-defined crystalline salts. Baryta water hydrolyses it to urea. By direct union with glycocholic acid, it yields glycoxyamine, $NH_2(HN): C \cdot NH \cdot CH_2 \cdot CO_2H$, whilst with methyl glycocholic (sarcosine) it forms creatine, $NH_2(NH): C \cdot N(CH_3) \cdot CH_2 \cdot CO_2H$.

Many derivatives of guanidine were obtained by J. Thiele (*Ann.*, 1892, 270, p. 1; 1893, 273, p. 133; *Ber.*, 1893, 26, pp. 2598, 2645). By the action of nitric acid on guanidine in the presence of sulphuric acid, nitroguanidine, $HN: C(NH_2) \cdot NH \cdot NO_2$ (a substance possessing acid properties) is obtained; from which, by reduction with zinc dust, amidoguanidine, $HN: C(NH_2) \cdot NH \cdot NH_2$, is formed. This amidoguanidine decomposes on hydrolysis with the formation of semicarbazide, $NH_2 \cdot CO \cdot NH \cdot NH_2$, which, in its turn, breaks down into carbon dioxide, ammonia and hydrazine. Amidoguanidine is a body of hydrazone type, for it reduces gold and silver salts and yields a benzylidene derivative. On oxidation with potassium permanganate, it gives azodicarbonyldiamidine nitrate, $NH_2(HN): C \cdot N: N \cdot C: (NH) \cdot NH_2 \cdot 2HNO_3$, which, when reduced by sulphuretted hydrogen, is converted into the corresponding hydraodicarbonyldiamidine, $NH_2(HN): C \cdot NH \cdot NH \cdot C: (NH) \cdot NH_2$. By the action of nitrous acid on a nitric acid solution of amidoguanidine, diazoguanidine nitrate, $NH_2(HN): C \cdot N: N \cdot NO_2$, is obtained. This diazo compound is decomposed by caustic alkalis with the formation of cyanamide and hydrazoic acid, $CH_3N_3 \cdot NO_2 = N_2H + CN \cdot NH_2 + HNO_2$, whilst acetates and carbonates convert it into amidotetra-

zotic acid, $H_2N \cdot C \begin{matrix} N-N \\ | \\ NH-N \end{matrix}$. Amidotetra-zotic acid yields addition compounds with amines; and by the further action of nitrous acid yields a very explosive derivative, diazotetra-zol, CN_6 . By fusing guanidine with urea, dicyandiamidine $H_2N(HN): C \cdot NH \cdot CO \cdot NH_2$, is formed.

GUANO (a Spanish word from the Peruvian *guano*, dung), the excrement of birds, found as large deposits on certain islands off the coast of Peru, and on others situated in the Southern ocean and off the west coast of Africa. The large proportions of phosphorus in the form of phosphates and of nitrogen as ammonium oxalate and urate renders it a valuable fertilizer. Bat's guano, composed of the excrement of bats, is found in certain caves in New Zealand and elsewhere; it is similar in composition to Peruvian guano. (See MANURES and MANURING.)

GUANTA, a port on the Caribbean coast of the state of Bermúdez, Venezuela, 12 m. N.E. of Barcelona, with which it is connected by rail. It dates from the completion of the railway to the coal mines of Nancucal and Capricucal nearly 12 m. beyond Barcelona, and was created for the shipment of coal. The harbour is horseshoe-shaped, with its entrance, 1908 ft. wide, protected by an island less than 1 m. off the shore. The entrance is easy and safe, and the harbour affords secure anchorage for large vessels, with deep water alongside the iron railway wharf.

These advantages have made Guanta the best port on this part of the coast, and the trade of Barcelona and that of a large inland district have been transferred to it. A prominent feature in its trade is the shipment of live cattle. Among its exports are sugar, coffee, cacao, tobacco and fruit.

GUANTÁNAMO, the easternmost important town of the S. coast of Cuba, in the province of Santiago, about 40 m. E. of Santiago. Pop. (1907) 14,559. It is situated by the Guazo (or Guaso) river, on a little open plain between the mountains. The beautiful, land-locked harbour, 10 m. long from N. to S. and 4 m. wide in places, has an outer and an inner basin. The latter has a very narrow entrance, and 2 to 2.5 fathoms depth of water. From the port of Caimanera to the city of Guantánamo, 13 m. N., there is a railway, and the city has railway connexion with Santiago. Guantánamo is one of the two ports leased by Cuba to the United States for a naval station. It is the shipping-port and centre of a surrounding coffee-, sugar- and lime-growing district. In 1741 an English force under Admiral Edward Vernon and General Thomas Wentworth landed here to attack Santiago. They named the harbour Cumberland bay. After their retreat fortifications were begun. The history of the region practically dates, however, from the end of the 18th century, when it gained prosperity from the settlement of French refugees from Santo Domingo; the town, as such, dates only from 1822. Almost all the old families are of French descent, and French was the language locally most used as late as the last third of the 19th century. In recent years, especially since the Spanish-American War of 1898, the region has greatly changed socially and economically. Guantánamo was once a fashionable summer residence resort for wealthy Cubans.

GUARANA (so called from the Guarani, an aboriginal American tribe), the plant *Paulinia Cupana* (or *P. sorbilis*) of the natural order *Sapindaceae*, indigenous to the north and west of Brazil. It has a smooth erect stem; large pinnate alternate leaves, composed of 5 oblong-oval leaflets; narrow panicles of short-stalked flowers; and ovoid or pyriform fruit about as large as a grape, and containing usually one seed only, which is shaped like a minute horse-chestnut. What is commonly known as guarana, guarana bread or Brazilian cocoa, is prepared from the seeds as follows. In October and November, at which time they become ripe, the seeds are removed from their capsules and sun-dried, so as to admit of the ready removal by hand of the white aril; they are next ground in a stone mortar or deep dish of hard sandstone; the powder, moistened by the addition of a small quantity of water, or by exposure to the dew, is then made into a paste with a certain proportion of whole or broken seeds, and worked up sometimes into balls, but usually into rolls not unlike German sausages, 5 to 8 in. in length, and 12 to 16 oz. in weight. After drying by artificial or solar heat, the guarana is packed between broad leaves in sacks or baskets. Thus prepared, it is of extreme hardness, and has a brown hue, a bitter astringent taste, and an odour faintly resembling that of roasted coffee. An inferior kind, softer and of a lighter colour, is manufactured by admixture of cocoa or cassava. Rased or grated into sugar and water, guarana forms a beverage largely consumed in S. America. Its manufacture, originally confined to the Mathés Indians, has spread into various parts of Brazil.

The properties of guarana as a nervous stimulant and restorative are due to the presence of what was originally described as a new principle and termed guaranine, but is now known to be identical with caffeine or theine. Besides this substance, which is stated to exist in it in the form of tannate, guarana yields on analysis the glucoside saponin, with tannin, starch, gum, three volatile oils, and an acrid green fixed oil (Fournier, *Journ. de Pharm.*, vol. xxxix., 1861, p. 291).

GUARANIS, a tribe and stock of South American Indians, having their home in Paraguay, Uruguay and on the Brazilian coast. The Guarani had developed some civilization before the arrival of the Spaniards, and being a peaceable people quickly submitted. They form to-day the chief element in the populations of Paraguay and Uruguay. Owing to its patronage by the Jesuit missionaries the Guarani language became a

widespread medium of communication, and in a corrupted form is still the common language in Paraguay.

GUARANTEE (sometimes spelt "guarantie" or "guaranty"; an O. Fr. form of "warrant," from the Teutonic word which appears in German as *wahren*, to defend or make safe and binding), a term more comprehensive and of higher import than either "warrant" or "security," and designating either some international treaty whereby claims, rights or possessions are secured, or more commonly a mere private transaction, by means of which one person, to obtain some trust, confidence or credit for another, engages to be answerable for him.

In English law, a guarantee is a contract to answer for the payment of some debt, or the performance of some duty, by a third person who is primarily liable to such payment or performance. It is a collateral contract, which does not extinguish the original liability or obligation to which it is accessory, but on the contrary is itself rendered null and void should the latter fail, as without a principal there can be no accessory. The liabilities of a surety are in law dependent upon those of the principal debtor, and when the latter ceases the former do so likewise (*per Collins, L.J., in Stacey v. Hill, 1901, 1 K.B., at p. 666; see per Willes, J., in Bateson v. Gosling, 1871, L.R. 7 C.P., at p. 14*), except in certain cases where the discharge of the principal debtor is by operation of law (*see In re FinsGeorge—ex parte Robson, 1905, 1 K.B. p. 462*). If, therefore, persons wrongly suppose that a third person is liable to one of them, and a guarantee is given on that erroneous supposition, it is invalid *ab initio*, by virtue of the *lex contractus*, because its foundation (which was that another was taken to be liable) has failed (*per Willes, J., in Mountstephen v. Lakeman, L.R. 7 Q.B. p. 202*). According to various existing codes civil, a suretyship, in respect of an obligation "non-valable," is null and void save where the invalidity is the result of personal incapacity of the principal debtor (Codes Civil, France and Belgium, 2012; Spain, 1824; Portugal, 822; Italy, 1899; Holland, 1858; Lower Canada, 1932). In some countries, however, the mere personal incapacity of a son under age to borrow suffices to vitiate the guarantee of a loan made to him (Spain, 1824; Portugal, 822, s. 2, 1535, 1536). The Egyptian codes sanction guarantees expressly entered into "in view of debtor's want of legal capacity" to contract a valid principal obligation (Egyptian Codes, Mixed Suits, 605; Native Tribunals, 496). The Portuguese code (art. 822, s. 1) retains the surety's liability, in respect of an invalid principal obligation, until the latter has been legally rescinded.

The giver of a guarantee is called "the surety," or "the guarantor"; the person to whom it is given "the creditor," or "the guarantee"; while the person whose payment or performance is secured thereby is termed "the principal debtor," or simply "the principal." In America, but not apparently elsewhere, there is a recognized distinction between "a surety" and "a guarantor"; the former being usually bound with the principal, at the same time and on the same consideration, while the contract of the latter is his own separate undertaking, in which the principal does not join, and in respect of which he is not to be held liable, until due diligence has been exerted to compel the principal debtor to make good his default. There is no privity of contract between the surety and the principal debtor, for the surety contracts with the creditor, and they do not constitute in law one person, and are not jointly liable to the creditor (*per Baron Parke in Bain v. Cooper, 1 Dowl. R. (N.S.) 11, 14*).

No special phraseology is necessary to the formation of a guarantee; and what really distinguishes such a contract from one of insurance is not any essential difference between the two forms of words *insurance* and *guarantee*, but the substance of the contract entered into by the parties in each particular case (*per Romer, L.J., in Seaton v. Heath—Seaton v. Burnand, 1899, 1 Q.B. 782, 792, C.A.; per Vaughan Williams, L.J., in In re Denton's Estate Licenses Insurance Corporation and Guarantee Fund Ltd. v. Denton, 1904, 2 Ch., at p. 188; and see Dams v. Mortgage Insurance Corporation, 1894, 1 Q.B. 54 C.A.*) In this

connexion it may be mentioned that the different kinds of suretyships have been classified as follows: (1) Those in which there is an agreement to constitute, for a particular purpose, the relation of principal and surety, to which agreement the creditor thereby secured is a party; (2) those in which there is a similar agreement between the principal and surety only, to which the creditor is a stranger; and (3) those in which, without any such contract of suretyship, there is a primary and a secondary liability of two persons for one and the same debt, the debt being, as between the two, that of one of those persons only, and not equally of both, so that the other, if he should be compelled to pay it, would be entitled to reimbursement from the person by whom (as between the two) it ought to have been paid (*per Earl of Selborne, L.C., in Duncan Fox and Co. v. North and South Wales Bank, 6 App. Cas., at p. 11*). According to several codes civil sureties are made divisible into conventional, legal and judicial (Fr. and Bel., 2015, 2040 et seq.; Spain, 1823; Lower Canada, 1930), while the Spanish code further divides them into gratuitous and for valuable consideration (art. 1, 823).

In England the common-law requisites of a guarantee in no way differ from those essential to the formation of any other contract. That is to say, they comprise the mutual assent of two or more parties, competency to contract, and, unless the guarantee be under seal, valuable consideration. An offer to guarantee is not binding until it has been accepted, being revocable till then by the party making it. Unless, however, as sometimes happens, the offer contemplates an express acceptance, one may be implied, and it may be a question for a jury whether an offer of guarantee has in fact been accepted. Where the surety's assent to a guarantee has been procured by fraud of the person to whom it is given, there is no binding contract. Such fraud may consist of suppression or concealment or misrepresentation. There is some conflict of authorities as to what facts must be spontaneously disclosed to the surety by the creditor, but it may be taken that the rule on the subject is less stringent than that governing insurances upon marine, life and other risks (*The North British Insurance Co. v. Lloyd, 10 Exch. 523*), though formerly this was denied (*Owen v. Homan, 3 Mac. & G. 378, 397*). Moreover, even where the contract relied upon is in the form of a policy guaranteeing the solvency of a surety for another's debt, and is therefore governed by the doctrine of *uberrima fides*, only such facts as are really material to the risk undertaken need be spontaneously disclosed (*Seaton v. Burnand—Burnand v. Seaton, 1900, A.C. 135*). As regards the competency of the parties to enter into a contract of guarantee, this may be affected by insanity or intoxication of the surety, if known to the creditor, or by disability of any kind. The ordinary disabilities are those of infants and married women—now in England greatly mitigated as regards the latter by the Married Women's Property Acts, 1870 to 1893, which enable a married woman to contract, as a *feme sole*, to the extent of her separate property. Every guarantee not under seal must according to English law have a consideration to support it, though the least spark of one suffices (*per Wilmot, J., in Pillan v. van Meerop and Hopkins, 3 Burr., at p. 1666; Haigh v. Brooks, 10 A. & E. 309; Barrall v. Trussell, 4 Taunt. 117*), which, as in other cases, may consist either of some right, interest, profit or benefit accruing to the one party, or some forbearance, detriment, loss or responsibility given, suffered or undertaken by the other. In some guarantees the consideration is entire—as where, in consideration of a lease being granted, the surety becomes answerable for the performance of the covenants; in other cases it is fragmentary, *i.e.* supplied from time to time—as where a guarantee is given to secure the balance of a running account at a banker's, or a balance of a running account for goods supplied (*per Lush, L.J., in Lloyd v. Harper, 16 Ch. Div., at p. 319*). In the former case, the moment the lease is granted there is nothing more for the lessor to do, and such a guarantee as that of necessity runs on throughout the duration of the lease and is irrevocable. In the latter case, however, unless the guarantee stipulates to the contrary, the surety may at any time terminate his liability under the guarantee as to future

advances, &c. The consideration for a guarantee must not be *past* or *executed*, but on the other hand it need not comprise a direct benefit or advantage to either the surety or the creditor, but may solely consist of anything done, or any promise made, for the benefit of the principal debtor. It is more frequently *executory* than *concurrent*, taking the form either of forbearance to sue the principal debtor, or of a future advance of money or supply of goods to him.

By the Indian Contract Act 1872, sect. 127, it is provided that the consideration for a guarantee may consist of anything done or any promise made for the benefit of the principal debtor by the creditor. Total failure of the consideration stipulated for by the party giving a guarantee will prevent its being enforced, as will also the existence of an illegal consideration. Though in all countries the mutual assent of two or more parties is essential to the formation of any contract (see e.g. Codes Civil, Fr. and Bel. 1108; Port. 643, 647 et seq.; Spain, 1258, 1261; Italy, 1104; Holl. 1356; Lower Canada, 984), a consideration is not everywhere regarded as a necessary element (see Pothier's *Law of Obligations*, Evans's edition, vol. ii. p. 19). Thus in Scotland a contract may be binding without a consideration to support it (Stair i. 10. 7).

The statutory requisites of a guarantee are, in England, prescribed by (1) the Statute of Frauds, which, with reference to guarantees, provides that "no action shall be brought whereby to charge the defendant upon any special promise to answer for the debt, default or miscarriages of another person, unless the agreement upon which such action shall be brought, or some memorandum or note thereof, shall be in writing and signed by the party to be charged therewith, or some other person thereunto by him lawfully authorized," and (2) Lord Tenterden's Act (9 Geo. IV. c. 14), which by § 6 enacts that "no action shall be brought whereby to charge any person upon or by reason of any representation or assurance made or given concerning or relating to the character, conduct, credit, ability, trade or dealings of any other person, to the intent or purpose that such other person may obtain credit, money or goods upon" (i.e. "upon credit," see *per Parke, B.*, in *Lyde v. Bernard*, 1 M. & W., at p. 104), "unless such representation or assurance be made in writing signed by the party to be charged therewith." This latter enactment, which applies to incorporated companies as well as to individual persons (*Hirst v. West Riding Union Banking Co.*, 1901, 2 K.B. 560 C.A.), was rendered necessary by an evasion of the 4th section of the Statute of Frauds, accomplished by treating the special promise to answer for another's debt, default or miscarriage, when *not* in writing, as required by that section, as a false and fraudulent representation concerning another's credit, solvency or honesty, in respect of which damages, as for a tort, were held to be recoverable (*Pasley v. Freeman*, 3 T.R. 51). In Scotland, where, it should be stated, a guarantee is called a "cautionary obligation," similar enactments to those just specified are contained in § 6 of the Mercantile Law Amendment Act (Scotland) 1856, while in the Irish Statute of Frauds (7 Will. III. c. 12) there is a provision (§ 2) identical with that found in the English Statute of Frauds. In India a guarantee may be either oral or written (Indian Contract Act, § 126), while in the Australian colonies, Jamaica and Ceylon it must be in writing. The German code civil requires the surety's promise to be verified by writing where he has not executed the principal obligation (art. 766), and the Portuguese code renders a guarantee provable by all the modes established by law for the proof of the principal contract (art. 826). According to most codes civil now in force a guarantee like any other contract can usually be made verbally in the presence of witnesses and in certain cases (where for instance considerable sums of money are involved) *sous signature privée* or else by judicial or notarial instrument (see Codes Civil, Fr. and Bel. 1341; Spain, 1244; Port. 2506, 2513; Italy, 1341 et seq.; Pothier's *Law of Obligations*, Evans's ed. i. 257; Burge on *Suretyship*, p. 19; van der Linden's *Institutes of Holland*, p. 120); the French and Belgian Codes, moreover, provide that suretyship is not to be presumed but must always be expressed (art. 2015).

The Statute of Frauds does not invalidate a verbal guarantee, but renders it unenforceable by action. It may therefore be available in support of a defence to an action, and money paid under it cannot be recovered. An indemnity is not a guarantee within the statute, unless it contemplates the primary liability of a third person. It need not, therefore, be in writing when it is a mere promise to become liable for a debt, whenever the person to whom the promise is made should become liable (*Wildes v. Dunslow*, L.R. 19 Eq. 198; *per* Vaughan Williams, L.J. in *Harburg India-Rubber Co. v. Martin*, 1902, 1 K.B. p. 786; *Griff v. Conrad*, 1894, 2 Q.B. 885 C.A.). Neither does the statute apply to the promise of a *del credere* agent, which binds him, in consideration of the higher commission he receives, to make no sales on behalf of his principal except to persons who are absolutely solvent, and renders him liable for any loss that may result from the non-fulfilment of his promise. A promise to give a guarantee is, however, within the statute, though not one to *procure* a guarantee.

The general principles which determine what are guarantees within the Statute of Frauds, as deduced from a multitude of decided cases, are briefly as follows: (1) the primary liability of a third person must exist or be contemplated as the foundation of the contract (*Birkmyr v. Darnell*, 1 Sm. L.C. 11th ed. p. 299; *Moultishephen v. Lakeman*, L.R. 7 Q.B. 196; L.R. 7 H.L. 17); (2) the promise must be made to the creditor; (3) there must be an absence of all liability on the part of the surety independently of his express promise of guarantee; (4) the main object of the transaction between the parties to the guarantee must be the fulfilment of a third party's obligation (see *Harburg India-Rubber Comb Co. v. Martin*, 1902, 1 K.B. 778, 786); and (5) the contract entered into must not amount to a sale by the creditor to the promiser of a security for a debt or of the debt itself (see de Colyar's *Law of Guarantees and of Principal and Surety*, 3rd ed. pp. 65-161, where these principles are discussed in detail by the light of decided cases there cited).

As regards the kind of note or memorandum of the guarantee that will satisfy the Statute of Frauds, it is now provided by § 3 of the Mercantile Law Amendment Act 1856, that "no special promise to be made, by any person after the passing of this act, to answer for the debt, default or miscarriage of another person, being in writing and signed by the party to be charged therewith, or some other person by him thereunto lawfully authorized, shall be deemed invalid to support an action, suit or other proceeding, to charge the person by whom such promise shall have been made, by reason only that the consideration for such promise does not appear in writing or by necessary inference from a written document." Prior to this enactment, which is not retrospective in its operation, it was held in many cases that as the Statute of Frauds requires "the agreement" to be in writing, all parts thereof were required so to be, including the consideration moving to, as well as the promise by, the party to be charged (*Wain v. Walters*, 5 East, 10; *Saunders v. Wakefield*, 4 B. & Ald. 595). These decisions, however, proved to be burdensome to the mercantile community, especially in Scotland and the north of England, and ultimately led to the alteration of the law, so far as guarantees are concerned, by means of the enactment already specified. Any writing embodying the terms of the agreement between the parties, and signed by the party to be charged, is sufficient; and the idea of agreement need not be present to the mind of the person signing (*per* Lindley, L.J., in *In re Hoyle—Hoyle v. Hoyle*, 1893, 1 Ch., at p. 98). It is, however, necessary that the names of the contracting parties should appear somewhere in writing; that the party to be charged, or his agent, should sign the memorandum or note of agreement, or else should sign another paper referring thereto; and that, when the note or memorandum is made, a complete agreement shall exist. Moreover, the memorandum must have been made before action brought, though it need not be contemporaneous with the agreement itself. As regards the stamping of the memorandum or note of agreement, a guarantee cannot, in England, be given in evidence unless properly stamped (Stamp Act 1891). A guarantee for the payment of goods, however, requires no stamp, being

within the exception contained in the first schedule of the act. Nor is it necessary to stamp a written representation or assurance as to character within 9 Geo. IV. c. 14, *supra*. If under seal, a guarantee requires sometimes an *ad valorem* stamp and sometimes a ten-shilling stamp; in other cases a sixpenny stamp generally suffices; and, on certain prescribed terms, the stamps can be affixed any time after execution (Stamp Act 1891, § 15, amended by § 15 of the Finance Act 1895).

The liability incurred by a surety under his guarantee depends upon its terms, and is not necessarily coextensive with that of the principal debtor. It is, however, obvious that as the surety's obligation is merely accessory to that of the principal it cannot as such exceed it (*de Colyar, Law of Guarantees*, 3rd ed. p. 233; *Burge, Suretyship*, p. 5). By the Roman law, if there were any such excess the surety's obligation was rendered wholly void and not merely void *pro tanto*. By many existing codes civil, however, a guarantee which imposes on the surety a greater liability than that of the principal is not thereby invalidated, but the liability is merely reducible to that of the principal (Fr. and Bel. 2013; Port. 823; Spain, 1826; Italy, 1900; Holland, 1859; Lower Canada, 1933). By sec. 128 of the Indian Contract Act 1872 the liability of the surety is, unless otherwise provided by contract, coextensive with that of the principal. Where the liability of the surety is less extensive in amount than that of the principal debtor, difficult questions have arisen in England and America as to whether the surety is liable only for part of the debt equal to the limit of his liability, or, up to such limit, for the whole debt (*Ellis v. Emmanuel*, 1 Ex. Div. 157; *Hobson v. Bass*, 6 Ch. App. 792; *Brandt, Suretyship*, sec. 219). The surety cannot be made liable except for a loss sustained by reason of the default guaranteed against. Moreover, in the case of a joint and several guarantee by several sureties, unless all sign it none are liable thereunder (*National Pro. Bk. of England v. Brackenbury*, 1906, 22 Times L.R. 797). It was formerly considered in England to be the duty of the party taking a guarantee to see that it was couched in language enabling the party giving it to understand clearly to what extent he was binding himself (*Nicholson v. Pagel*, 1 C. & M. 48, 52). This view, however, can no longer be sustained, it being now recognized that a guarantee, like any other contract, must, in cases of ambiguity, be construed against the party bound thereby and in favour of the party receiving it (*Mayer v. Isaac*, 6 M. & W. 605, 612; *Wood v. Priestner*, L.R. 2 Exch. 66, 71). The surety is not to be changed beyond the limits prescribed by his contract, which must be construed so as to give effect to what may fairly be inferred to have been the intention of the parties, from what they themselves have expressed in writing. In cases of doubtful import, recourse to parol evidence is permissible, to explain, but not to contradict, the written evidence of the guarantee. As a general rule, the surety is not liable if the principal debt cannot be enforced, because, as already explained, the obligation of the surety is merely accessory to that of the principal debtor. It has never been actually decided in England whether this rule holds good in cases where the principal debtor is an infant, and on that account is not liable to the creditor. Probably in such a case the surety might be held liable by estoppel (see *Kimball v. Newell*, 7 Hill (N.Y.) 116). When directors guarantee the performance by their company of a contract which is *ultra vires*, and therefore not binding on the latter, the directors' suretyship liability is, nevertheless, enforceable against them (*Yorkshire Railway Wagon Co. v. Macture*, 21 Ch. D. 309 C.A.).

It is not always easy to determine for how long a time liability under a guarantee endures. Sometimes a guarantee is limited to a single transaction, and is obviously intended to be security against one specific default only. On the other hand, it as often happens that it is not exhausted by one transaction on the faith of it, but extends to a series of transactions, and remains a standing security until it is revoked, either by the act of the parties or else by the death of the surety. It is then termed a continuing guarantee. No fixed rules of interpretation determine

whether a guarantee is a continuing one or not, but each case must be judged on its individual merits; and frequently, in order to achieve a correct construction, it becomes necessary to examine the surrounding circumstances, which often reveal what was the subject-matter which the parties contemplated when the guarantee was given, and likewise what was the scope and object of the transaction between them. Most continuing guarantees are either ordinary mercantile securities, in respect of advances made or goods supplied to the principal debtor or else bonds for the good behaviour of persons in public or private offices or employments. With regard to the latter class of continuing guarantees, the surety's liability is, generally speaking, revoked by any change in the constitution of the persons to or for whom the guarantee is given. On this subject it is now provided by section 18 of the Partnership Act 1890, which applies to Scotland as well as England, that "a continuing guarantee or cautionary obligation given either to a firm or to a third person in respect of the transactions of a firm, is, in the absence of agreement to the contrary, revoked as to future transactions by any change in the constitution of the firm to which, or of the firm in respect of the transactions of which the guaranty or obligation was given." This section, like the enactment it replaces, namely, sec. 4 of the Mercantile Law Amendment Act 1856, is mainly declaratory of the English common law, as embodied in decided cases, which indicate that the changes in the persons to or for whom a guarantee is given may consist either of an increase in their number, of a diminution thereof caused by death or retirement from business, or of the incorporation or consolidation of the persons to whom the guarantee is given. In this connexion it may be stated that the Government Offices (Security) Act 1875, which has been amended by the Statute Law Revision Act 1883, contains certain provisions with regard to the acceptance by the heads of public departments of guarantees given by companies for the due performance of the duties of an office or employment in the public service, and enables the Commissioners of His Majesty's Treasury to vary the character of any security, for good behaviour by public servants, given after the passing of the act.

Before the surety can be rendered liable on his guarantee, the principal debtor must have made default. When, however, this has occurred, the creditor, in the absence of express agreement to the contrary, may sue the surety, without even informing him of such default having taken place, or requiring him to pay, and before proceeding against the principal debtor or resorting to securities for the debt received from the latter. In those countries where the municipal law is based on the Roman civil law, sureties usually possess the right (which may, however, be renounced by them) originally conferred by the Roman law, of compelling the creditor to insist on the goods, &c. (if any) of the principal debtor being first "discussed," *i.e.* appraised and sold, and appropriated to the liquidation of the debt guaranteed (see Codes Civil, Fr. and Bel. 2021 et seq.; Spain, 1830, 1831; Port. 830; Germany, 771, 772, 773; Holland, 1868; Italy, 1907; Lower Canada, 1941-1942; Egypt [mixed suits] 612; *ibid.* [native tribunals] 502), before having recourse to the sureties. This right, according to a great American jurist (Chancellor Kent in *Hayes v. Ward*, 4 Johns. New York, Ch. Cas. p. 132), "accords with a common sense of justice and the natural equity of mankind." In England this right has never been fully recognized. Neither does it prevail in America nor, since the passing of the Mercantile Law Amendment Act (Scotland) 1856, s. 8, is it any longer available in Scotland where, prior to the last-named enactment, the benefit of discussion, as it is termed, existed. In England, however, before any demand for payment has been made by the creditor on the surety, the latter can, as soon as the principal debtor has made default, compel the creditor, on giving him an indemnity against costs and expenses, to sue the principal debtor if the latter be solvent and able to pay (*per A. L. Smith, L.J.*, in *Rousse v. Bradford Banking Company*, 1894, 2 Ch. 75; *per Lord Eldon* in *Wright v. Simpson*, 6 Ves., at p. 733), and a similar remedy is also open to the surety in America (see *Brandt on Suretyship*, par. 205.

p. 290) though in neither of these countries nor in Scotland can one of several sureties, when sued for the whole guaranteed debt by the creditor, compel the latter to divide his claim amongst all the solvent sureties, and reduce it to the share and proportion of each surety. However, this *beneficium divisionis*, as it is called in Roman law, is recognized by many existing codes (Fr. and Bel. 2025-2027; Spain, 1837; Portugal, 835-836; Germany, 426; Holland, 1873-1874; Italy, 1911-1912; Lower Canada, 1946; Egypt [mixed suits], 615,616).

The usual mode in England of enforcing liability under a guarantee is by action in the High Court or in the county court. It is also permissible for the creditor to obtain redress by means of a set-off or counter-claim, in an action brought against him by the surety. On the other hand, the surety may now, in any court in which the action on the guarantee is pending, avail himself of any set-off which may exist between the principal debtor and the creditor. Moreover, if one of several sureties for the same debt is sued by the creditor or his guarantee, he can, by means of a proceeding termed a third-party notice, claim contribution from his co-surety towards the common liability. Independent proof of the surety's liability under his guarantee must always be given at the trial; as the creditor cannot rely either on admissions made by the principal debtor, or on a judgment or award obtained against him (*Ex parte Young In re Kitchin*, 17 Ch. Div. 668). Should the surety become bankrupt either before or after default has been made by the principal debtor, the creditor will have to prove against his estate. This right of proof is now in England regulated by the 37th section of the Bankruptcy Act, 1883, which is most comprehensive in its terms.

A person liable as a surety for another under a guarantee possesses various rights against him, against the person to whom the guarantee is given, and also against those who may have become co-sureties in respect of the same debt, default or miscarriage. As regards the surety's rights against the principal debtor, the latter may, where the guarantee was made with his consent but not otherwise (see *Hodgson, v. Shaw*, 3 Myl. & K. at p. 190), after he has made default, be compelled by the surety to exonerate him from liability by payment of the guaranteed debt (*per* Sir W. Grant, M.R., in *Antrobus v. Davidson*, 3 Meriv. 560, 579; *per* Lindley, L.J., in *Johnson v. Salvage Association*, 19 Q.B.D. 460, 461; and see *Wolmershausen v. Gullick*, 1893, 2 Ch. 514). The moment, moreover, the surety has himself paid any portion of the guaranteed debt, he is entitled to rank as a creditor for the amount so paid, and to compel repayment thereof. In the event of the principal debtor's bankruptcy, the surety can in England, if the creditor has not already proved in respect of the guaranteed debt, prove against the bankrupt's estate, not only in respect of payments made before the bankruptcy of the principal debtor, but also, it seems, in respect of the contingent liability to pay under the guarantee (see *Ex parte Delmar re Herpath*, 1880, 38 W.R. 752), while if the creditor has already proved, the surety who has paid the guaranteed debt has a right to all dividends received by the creditor from the bankrupt in respect thereof, and to stand in the creditor's place as to future dividends. This right is, however, often waived by the guarantee stipulating that, until the creditor has received full payment of all sums over and above the guaranteed debt, due to him from the principal debtor, the surety shall not participate in any dividends distributed from the bankrupt's estate amongst his creditors. As regards the rights of the surety against the creditor, they are in England exercisable even by one who in the first instance was a principal debtor, but has since become a surety, by arrangement with his creditor, duly notified to the creditor, though not even sanctioned by him. This was decided by the House of Lords in the case of *Rouse v. The Bradford Banking Co.*, 1894, A.C. 586, removing a doubt created by the previous case of *Swire v. Radman*, 1 Q.B.D. 536, which must now be treated as overruled. The surety's principal right against the creditor entitles him, after payment of the guaranteed debt, to the benefit of all

securities, whether known to him (the surety) or not, which the creditor held against the principal debtor; and where, by default or *laches* of the creditor, such securities have been lost, or rendered otherwise unavailable, the surety is discharged *pro tanto*. This right, which is not in abeyance till the surety is called on to pay (*Dixon v. Steel*, 1901, 2 Ch. 602), extends to all securities, whether satisfied or not, given before or after the contract of suretyship was entered into. On this subject the Mercantile Law Amendment Act, 1856, § 5, provides that "every person who being surety for the debt or duty of another, or being liable with another for any debt or duty, shall pay such debt or perform such duty, shall be entitled to have assigned to him, or to a trustee for him, every judgment, specialty, or other security, which shall be held by the creditor in respect of such debt or duty, whether such judgment, specialty, or other security shall or shall not be deemed at law to have been satisfied by the payment of the debt or performance of the duty, and such person shall be entitled to stand in the place of the creditor, and to use all the remedies, and, if need be, and upon a proper indemnity, to use the name of the creditor, in any action or other proceeding at law or in equity, in order to obtain from the principal debtor, or any co-surety, co-contractor, or co-debtor, as the case may be, indemnification for the advances made and loss sustained by the person who shall have so paid such debt or performed such duty; and such payment or performance so made by such surety shall not be pleadable in bar of any such action or other proceeding by him, provided always that no co-surety, co-contractor, or co-debtor shall be entitled to recover from any other co-surety, co-contractor, or co-debtor, by the means aforesaid, more than the just proportion to which, as between those parties themselves, such last-mentioned person shall be justly liable." This enactment is so far retrospective that it applies to a contract made before the act, where the breach thereof; and the payment by the surety, have taken place subsequently. The right of the surety to be subrogated, on payment by him of the guaranteed debt, to all the rights of the creditor against the principal debtor is recognized in America (*Tobin v. Kirk*, 80 New York S.C.R. 229), and many other countries (Codes Civil, Fr. and Bel. 2029; Spain, 1839; Port. 839; Germany, 774; Holland, 1877; Italy, 1916; Lower Canada, 2999; Egypt [mixed suits], 617; *ibid.* [native tribunals], 505).

As regards the rights of the surety against a co-surety, he is entitled to contribution from him in respect of their common liability. This particular right is not the result of any contract, but is derived from a general equity, on the ground of equality of burden and benefit, and exists whether the sureties be bound jointly, or jointly and severally, and by the same, or different, instruments. There is, however, no right of contribution where each surety is severally bound for a given portion only of the guaranteed debt; nor in the case of a surety for a surety; (see *In re Denton's Estate*, 1904, 2 Ch. 178 C.A.); nor where a person becomes a surety jointly with another and at the latter's request. Contribution may be enforced, either before payment, or as soon as the surety has paid more than his share of the common debt (*Wolmershausen v. Gullick*, 1893, 2 Ch. 514); and the amount recoverable is now always regulated by the number of solvent sureties, though formerly this rule only prevailed in equity. In the event of the bankruptcy of a surety, proof can be made against his estate by a co-surety for any excess over the latter's contributive share. The right of contribution is not the only right possessed by co-sureties against each other, but they are also entitled to the benefit of all securities which have been taken by any one of them as an indemnity against the liability incurred for the principal debtor. The Roman law did not recognize the right of contribution amongst sureties. It is, however, sanctioned by many existing codes (Fr. and Bel. 2033; Germany, 426,474; Italy, 1920; Holland, 1881; Spain, 1844; Port. 845; Lower Canada, 1955; Egypt [mixed suits], 618, *ibid.* [native tribunals], 506), and also by the Indian Contract Act 1872, ss. 146-147.

The discharge of a surety from liability under his guarantee

may be accomplished in various ways, he being regarded, especially in England and America, as a "favoured debtor" (*per* Turner, L.J., in *Wheatley v. Bastow*, 7 De G. M. & G. 279, 280; *per* Earl of Selborne, L.C., in *In re Sherry—London and County Banking Co. v. Terry*, 25 Ch. D., at p. 703; and see Brandt on *Suretyship*, secs. 79, 80). Thus, fraud subsequent to the execution of the guarantee (as where, for example, the creditor connives at the principal debtor's default) will certainly discharge the surety. Again, a material alteration made by the creditor in the instrument of guarantee after its execution may also have this effect. The most prolific ground of discharge, however, is usually traceable to causes originating in the creditor's *laches* or conduct, the governing principle being that if the creditor violates any rights which the surety possessed when he entered into the suretyship, even though the damage be nominal only, the guarantee cannot be enforced. On this subject it suffices to state that the surety's discharge may be accomplished (1) by a variation of the terms of the contract between the creditor and the principal debtor, or of that subsisting between the creditor and the surety (see *Rickaby v. Lewis*, 22 T.L.R. 130); (2) by the creditor taking a new security from the principal debtor in lieu of the original one; (3) by the creditor discharging the principal debtor from liability; (4) by the creditor binding himself to give time to the principal debtor for payment of the guaranteed debt; or (5) by loss of securities received by the creditor in respect of the guaranteed debt.

In this connexion it may be stated in general terms that whatever extinguishes the principal obligation necessarily determines that of the surety (which is accessory thereto), not only in England but elsewhere also (Codes Civil, Fr. and Bel. 2034, 2038; Spain, 1847; Port. 848; Lower Canada, 1956; 1960; Egypt [mixed suits], 622, *ibid.* [native tribunals], 509; Indian Contract Act 1872, sec. 134), and that, by most of the codes civil now in force, the surety is discharged by *laches* or conduct of the creditor inconsistent with the surety's rights (see Fr. and Bel. 2037; Spain, 1852; Port. 853; Germany, 776; Italy, 1928; Egypt [mixed suits], 623), though it may be mentioned that the rule prevailing in England, Scotland, America and India which releases the surety from liability where the creditor, by binding contract with the principal, extends without the surety's consent the time for fulfilling the principal obligation, while recognized by two existing codes civil (Spain, 1851; Port. 852), is rejected by the majority of them (Fr. and Bel. 2039; Holland, 1887; Italy, 1930; Lower Canada, 1961; Egypt [mixed suits], 613; *ib.* [native tribunals], 503); and see Morice, *English and Dutch Law*, p. 96; van der Linden, *Institutes of Holland*, pp. 120-121). A revocation of the contract of suretyship by act of the parties, or in certain cases by the death of the surety, may also operate to discharge the surety. The death of a surety does not *per se* determine the guarantee, but, save where from its nature the guarantee is irrevocable by the surety himself, it can be revoked by express notice after his death, or, it would appear, by the creditor becoming affected with constructive notice thereof; except where, under the testator's will, the executor has the option of continuing the guarantee, in which case the executor should, it seems, specifically withdraw the guarantee in order to determine it. Where one of a number of joint and several sureties dies, the future liability of the survivors under the guarantee continues, at all events until it has been determined by express notice. Moreover, when three persons joined in a guarantee to a bank, and their liability thereunder was not expressed to be several, it was held that the death of one surety did not determine the liability of the survivors. In such a case, however, the estate of the deceased surety would be relieved from liability.

The Statutes of Limitation bar the right of action on guarantees under seal after twenty years, and on other guarantees after six years, from the date when the creditor might have sued the surety.

AUTHORITIES.—De Colyar, *Law of Guarantees and of Principal and Surety* (3rd ed., 1897); American edition, by J. A. Morgan (1875); Throop, *Validity of Verbal Agreements*; Fell, *Guarantees*

(2nd ed.); Theobald, *Law of Principal and Surety*; Brandt, *Law of Suretyships and Guarantees*; article by de Colyar in *Journal of Comparative Legislation* (1905), on "Suretyship from the Standpoint of Comparative Jurisprudence." (H. A. de C.)

GUARATINGUETÁ, a city of Brazil in the eastern part of the state of São Paulo, 124 m. N.E. of the city of São Paulo. Pop. (1890) of the municipality, which includes a large rural district and the villages of Aparecida and Roseira, 30,600. The city, which was founded in 1651, stands on a fertile plain 3 m. from the Parahyba river, and is the commercial centre of one of the oldest agricultural districts of the state. The district produces large quantities of coffee, and some sugar, Indian corn and beans. Cattle and pigs are raised. The city dwellings are for the most part constructed of rough wooden frames covered with mud, called *taipa* by the natives, and roofed with curved tiles. The São Paulo branch of the Brazilian Central railway passes through the city, by which it is connected with Rio de Janeiro on one side and São Paulo and Santos on the other.

GUARDA, an episcopal city and the capital of an administrative district bearing the same name, and formerly in the province of Beira, Portugal; on the Guarda-Abrantes and Lisbon-Villar Formoso railways. Pop. (1900) 6124. Guarda is situated 3370 ft. above sea-level, at the north-eastern extremity of the Serra da Estrella, overlooking the fertile valley of the river Cóa. It is surrounded by ancient walls, and contains a ruined castle, a fine 16th-century cathedral and a sanatorium for consumptives. Its industries comprise the manufacture of coarse cloth and the sale of grain, wine and live stock. In 1199 Guarda was founded, on the site of the Roman Lencia Oppidana, by Sancho I. of Portugal, who intended it, as its name implies, to be a "guard" against Moorish invasion. The administrative district of Guarda coincides with north-eastern Beira; pop. (1900), 261,630; area, 1065 sq. m.

GUARDI, FRANCESCO (1712-1793), Venetian painter, was a pupil of Canaletto, and followed his style so closely that his pictures are very frequently attributed to his more celebrated master. Nevertheless, the diversity, when once perceived, is sufficiently marked—Canaletto being more firm, solid, distinct, well-grounded, and on the whole the higher master, while Guardi is noticeable for spirited touch, sparkling colour and picturesquely sketched figures—in these respects being fully equal to Canaletto. Guardi sometimes coloured Canaletto's designs. He had extraordinary facility, three or four days being enough for producing an entire work. The number of his performances is large in proportion to this facility and to the love of gain which characterized him. Many of his works are to be found in England and seven in the Louvre.

GUARDIAN, one who guards or defends another, a protector. The O. Fr. *guarden*, *garden*, mod. *gardien*, from *guarden*, *garder*, is of Teutonic origin, from the base *ward-*, to protect, cf. O.H. Ger. *warten*, and Eng. "ward"; thus "guardian" and "warden" are etymologically identical, as are "guard" and "ward"; cf. the use of the correlatives "guardian" and "ward," i.e. a minor, or person incapable of managing his affairs, under the protection or in the custody of a guardian. For the position of guardians of the poor see POOR LAW, and for the legal relations between a guardian and his ward see INFANT, MARRIAGE and ROMAN LAW.

GUARDS, AND HOUSEHOLD TROOPS. The word *guard* is an adaptation of the Fr. *garde*, mod. *garde*, O. Ger. *ward*; see **GUARDIAN**. The practice of maintaining bodyguards is of great antiquity, and may indeed be considered the beginning of organized armies. Thus there is often no clear distinction between the inner ring of personal defenders and the select corps of trained combatants who are at the chief's entire disposal. Famous examples of corps that fell under one or both these headings are the "Immortals" of Xerxes, the Mamelukes, Janissaries, the *Huscarles* of the Anglo-Saxon kings, and the Russian Strelitz (*Strzelitsi*). In modern times the distinction of function is better marked, and the fighting men who are more intimately connected with the sovereign than the bulk of the army can be classified as to duties into "Household Troops,"

who are in a sense personal retainers, and "Guards," who are a *corps d'élite* of combatants. But the dividing line is not so clear as to any given body of troops. Thus the British Household Cavalry is part of the combatant army as well as the sovereign's escort.

The oldest of the household or bodyguard corps in the United Kingdom is the King's Bodyguard of the *Yeomen of the Guard* (q.v.), formed at his accession by Henry VII. The "nearest guard," the personal escort of the sovereign, is the "King's Bodyguard of the Honourable Corps of *Gentlemen-at-Arms*," created by Henry VIII. at his accession in 1509. Formed possibly on the pattern of the "Pensionnaires" of the French kings—retainers of noble birth who were the predecessors of the *Maison du Roi* (see below)—the new corps was originally called "the Pensioners." The importance of such guards regiments in the general development of organized armies is illustrated by a declaration of the House of Commons, made in 1674, that the militia, the pensioners and the Yeomen of the Guard were the only lawful armed forces in the realm. But with the rise of the professional soldier and the corresponding disuse of arms by the nobles and gentry, the *Gentlemen-at-Arms* (a title which came into use in James II.'s time, though it did not become that of the corps until William IV.'s) retaining their noble character, became less and less military. Burke attempted without success in 1782 to restrict membership to officers of the army and navy, but the necessity of giving the corps an effective military character became obvious when, on the occasion of a threatened Chartist riot, it was called upon to do duty as an armed body at St James's Palace. The corps was reconstituted on a purely military basis in 1862, and from that date only military officers of the regular services who have received a war decoration are eligible for appointment. The office of captain, however, is political, the holder (who is always a peer) vacating it on the resignation of the government of which he is a member. The corps consists at present of captain, lieutenant, standard bearer, clerk of the cheque (adjutant), sub-officer and 39 gentlemen-at-arms. The uniform consists of a scarlet swallow-tailed coat and blue overalls, with gold epaulettes, brass dragon helmet with drooping white plume and brass box-spurs, these last contrasting rather forcibly with the partizan, an essentially infantry weapon, that they carry.

The Royal Company of Archers.—The king's bodyguard for Scotland was constituted in its present form in the year 1670, by an act of the privy council of Scotland. An earlier origin has been claimed for the company, some connecting it with a supposed archer guard of the kings of Scotland. In the above-mentioned year, 1676, the minutes of the Royal Company begin by stating, that owing to "the noble and usefull recreation of archery being for many years much neglected, several noblemen and gentlemen did associate themselves in a company for encouragement thereof . . . and did apply to the privy council for their approbation . . . which was granted." For about twenty years at the end of the 17th century, perhaps owing to the adhesion of the majority to the Stuart cause, its existence seems to have been suspended. But in 1703 a new captain-general, Sir George Mackenzie, Viscount Tarbat, afterwards earl of Cromarty (1630-1714), was elected, and he procured for the company a new charter from Queen Anne. The rights and privileges renewed or conferred by this charter were to be held of the crown for the *reddendo* of a pair of barbed arrows. This *reddendo* was paid to George IV. at Holyrood in 1822, to Queen Victoria in 1842 and to King Edward VII. in 1903. The history of the Royal Company since 1703 has been one of great prosperity. Large parades were frequently held, and many distinguished men marched in the ranks. Several of the leading insurgents in 1745 were members, but the company was not at that time suspended in any way.

In 1822 when King George IV. visited Scotland, it was thought appropriate that the Royal Company should act as his majesty's bodyguard during his stay, especially as there was a tradition of a former archer bodyguard. They therefore performed the duties usually assigned to the gentlemen-at-arms. When Queen Victoria visited the Scottish capital in 1842, the Royal Company again did duty; the last time they were called out in her reign in their capacity of royal bodyguard was in 1860 on the occasion of the great volunteer review in the Queen's Park, Edinburgh. They acted in the same capacity when King Edward VII. reviewed the Scottish Volunteers there on the 18th of September 1905.

King George IV. authorized the company to take, in addition to their former name, that of "The King's Body Guard for Scotland," and presented to the captain-general a gold stick, thus

constituting the company part of the royal household. In virtue of this stick the captain-general of the Royal Company takes his place at a coronation or similar pageant immediately behind the gold stick of England. The lieutenant-general of the company have silver sticks; and the council, which is the executive body of the company, possess seven ebony ones. George IV. further appointed a full dress uniform to be worn by members of the company at court, when not on duty as guards, in which latter case the ordinary field dress is used. The court dress is green with green velvet facings, gold epaulettes and lace, crimson silk sash, and cocked hat with green plume. The officers wear a gold sash in place of a crimson one, and an *épaulette* on the left shoulder. All ranks wear swords. The field dress at present consists of a dark-green tunic, shoulder-wings and gauntleted cuffs and trousers trimmed with black and crimson; a bow-case worn as a sash, of the same colour as the coat, black waistbelt with sword, and Balmoral bonnet with thistle ornament and eagle's feather. The officers of the company are the captain-general, 4 captains, 4 lieutenants, 4 ensigns, 12 brigadiers and adjutant.

Corps of the gentlemen-at-arms or yeoman type do not of course count as combatant troops—if for no other reason at least because they are armed with the weapons of bygone times. Colonel Clifford Walton states in his *History of the British Standing Army* that neither the Yeomen of the Guard nor the Pensioners were ever subject to martial law. The British guards and household troops that are armed, trained and organized as part of the army are the *Household Cavalry* and the *Foot Guards*.

The Household Cavalry consists at the present day of three regiments, and has its origin, as have certain of the Footguard regiments, in the ashes of the "New Model" army disbanded at the restoration of Charles II. in 1660. In that year the "1st or His Majesty's Own Troop of Guards" formed during the king's exile his cavalier followers, was taken on the strength of the army. The 2nd troop was formerly in the Spanish service as the "Duke of York's Guards," and was also a cavalier unit. In 1670, on Monk's death, the original 3rd troop (Monk's Life Guards, renamed in 1660 the "Lord General's Troop of Guards") became the 2nd (the queen's) troop, and the duke of York's troop the 3rd. In 1685 the 1st and 2nd troops were styled Life Guards of Horse, and two years later the blue-uniformed "Royal Regiment of Horse," a New Model regiment that had been disbanded and at once re-raised in 1660, was made a household cavalry corps. Later under the colonelcy of the earl of Oxford it was popularly called "The Oxford Blues." There were also from time to time other troops (e.g. Scots troops 1700-1746) that have now disappeared. In 1746 the 2nd troop was disbanded, but it was revived in 1788, when the two senior corps were given their present title of 1st and 2nd Life Guards. From 1730 to 1810 the Blues bore the name of "Royal Horse Guards Blue," which in 1810 was changed to "Royal Horse Guards (The Blues)." The general distinction between the uniforms of the red Life Guard and the blue Horse Guard still exists. The 1st and the 2nd regiments of Life Guards wear scarlet tunics with blue collars and cuffs, and the Royal Horse Guards blue tunics with scarlet collars and cuffs. All three wear steel cuirasses on state occasions and on guard duty. The head-dress is a steel helmet with drooping horse-hair plume (white for Life Guards, red for Horse Guards). In full dress white buckskin pantaloons and long knee boots are worn. Amongst the peculiarities of these *corps d'élite* is the survival of the old custom of calling non-commissioned officers "corporal of horse" instead of sergeant, and corporal-major instead of sergeant-major, the wearing by trumpeters and bandmen in full dress of a black velvet cap, a richly laced coat with a full skirt extending to the wearer's knees and long white gaiters. There is little distinction between the two Life Guards regiments' uniforms, the most obvious point being that the cord running through the white leather pouch belt is red for the 1st and blue for the 2nd.

The Foot Guards comprise the Grenadier Guards, the Coldstream Guards, the Scots Guards and the Irish Guards, each (except the last) of three battalions. The Grenadiers, originally the First Foot Guards, represent a royalist infantry regiment which served with the exiled princes in the Spanish army and returned at the Restoration in 1660. The Coldstream Guards

are a New Model regiment, and were originally called the Lord General's (Monk's) regiment of Foot Guards. Their popular title, which became their official designation in 1670, is derived from the fact that the army with which Monk restored the monarchy crossed the Tweed into England at the village of Coldstream, and that his troops (which were afterwards, except the two units of horse and foot of which Monk himself was colonel, disbanded) were called the Coldstreamers. The two battalions of Scots Foot Guards, which regiment was separately raised and maintained in Scotland after the Restoration, marched to London in 1686 and 1688 and were brought on to the English Establishment in 1707. In George III.'s reign they were known as the Third Guards, and from 1831 to 1877 (when the present title was adopted) as the Scots Fusilier Guards.

The Irish Guards (one battalion) were formed in 1902, after the South African War, as a mark of Queen Victoria's appreciation of the services rendered by the various Irish regiments of the line.¹ The dress of the Foot Guards is generally similar in all four regiments, scarlet tunic with blue collars, cuffs and shoulder-straps, blue trousers and high, rounded bearskin cap. The regimental distinctions most easily noticed are these. The Grenadiers wear a small white plume in the bearskin, the Coldstreams a similar red one, the Scots none, the Irish a blue-green one. The buttons on the tunic are spaced evenly for the Grenadiers, by twos for the Coldstreams, by threes for the Scots and by fours for the Irish. The band of the modern cap is red for the Grenadiers, white for the Coldstreams, "diced" red and white (chequers) for the Scots and green for the Irish. Former privileges of foot guard regiments, such as higher brevet rank in the army for their regimental officers, are now abolished, but Guards are still subject exclusively to the command of their own officers, and the officers of the Foot Guards, like those of the Household Cavalry, have special duties at court. Neither the cavalry nor the infantry guards serve abroad in peace time as a rule, but in 1907 a battalion of the Guards, which it was at that time proposed to disband, was sent to Egypt. "Guards' Brigades" served in the Napoleonic Wars, in the Crimea, in Egypt at various times from 1887 to 1898 and in South Africa 1899-1902. The last employment of the Household Cavalry as a brigade in war was at Waterloo, but composite regiments made up from officers and men of the Life Guards and Blues were employed in Egypt and in S. Africa.

The sovereigns of France had guards in their service in Merovingian times, and their household forces appear from time to time in the history of medieval wars. Louis XI. was, however, the first to regularize their somewhat loose organization, and he did so to such good purpose that Francis I. had no less than 8000 guardsmen organized, subdivided and permanently under arms. The senior unit of the *Gardes du Corps* was the famous company of Scottish archers (*Compagnie écossaise de la Garde du Corps du Roi*), which was originally formed (1418) from the Scottish contingents that assisted the French in the Hundred Years' War. Scott's *Quentin Durward* gives a picture of life in the corps as it was under Louis XI. In the following century, however, its regimental history becomes somewhat confused. Two French companies were added by Louis XI. and Francis I. and the *Gardes du Corps* came to consist exclusively of cavalry. About 1634 nearly all the Scots then serving went into the "regiment d'Hébron" and thence later into the British regular army (see HEBURN, SIR JOHN). Thereafter, though the titles, distinctions and privileges of the original Archer Guard were continued, it was recruited from native Frenchmen, preference being (at any rate at first) given to those of Scottish descent. At its disbandment in 1791 along with the rest of the *Gardes du Corps*, it contained few, if any, native Scots. There was also, for a short time (1643-1660), an infantry regiment of *Gardes écossaises*.

In 1671 the title of *Maison Militaire du Roi* was applied to that portion of the household that was distinctively military. It came to consist of 4 companies of the *Gardes du Corps*, 2 companies of *Mousquetaires* (cavalry) (formed 1622 and 1660), 1 company of *Chevaux légers* (1570), 1 of *Gendarmes de la Maison Rouge*, and 1 of *Grenadiers à Cheval* (1676), with 1 company of *Gardes de la Porte* and one called the *Centi-Suisses*, the last two being semi-military. This large establishment, which did not include all the guard regiments, was considerably reduced by the Count of St Germain's reforms in

1775, all except the *Gardes du Corps* and the *Centi-Suisses* being disbanded. The whole of the *Maison du Roi*, with the exception of the semi-military bodies referred to, was cavalry.

The *Gardes françaises*, formed in 1563, did not form part of the *Maison*. They were an infantry regiment, as were the famous *Gardes suisses*, originally a Swiss mercenary regiment in the Wars of Religion, which was, for good conduct at the combat of Arques, incorporated in the permanent establishment by Henry IV. in 1589 and in the guards in 1615. At the Revolution, contrary to expectation, the French Guards sided openly with the Constitutional movement and were disbanded. The Swiss Guards, however, being foreigners, and therefore unaffected by civil troubles, retained their exact discipline and devotion to the court to the day on which they were sacrificed by their master to the bullets of the Marseillais and the pikes of the mob (August 10, 1792). Their tragic fate is commemorated by the well-known monument called the "Lion of Lucerne," the work of Thorvaldsen, erected near Lucerne in 1821. The "Constitutional," "Revolutionary" and other guards that were created after the abolition of the *Maison* and the slaughter of the Swiss are unimportant, but through the "Directory Guards" they form a nominal link between the household troops of the monarchy and the corps which is perhaps the most famous "Guard" in history. The Imperial Guard of Napoleon had its beginnings in an escort squadron called the Corps of Guides, which accompanied him in the Italian campaign of 1796-1797 and in Egypt. On becoming First Consul in 1799 he built up out of this and of the guard of the Directory a small corps of horse and foot, called the Consular Guard, and this, which was more of a fighting unit than a personal bodyguard, took part in the battle of Marengo. The Imperial Guard, into which it was converted on the establishment of the Empire, was at first of about the strength of a division. As such it took part in the Austerlitz and Jena campaigns, but after the conquest of Prussia Napoleon augmented it, and divided it into the "Old Guard" and the "Young Guard." Subsequently the "Middle Guard" was created, and by successive augmentations the corps of the guard had grown to be 57,000 strong in 1811-1812 and 81,000 in 1813. It preserved its general character as a *corps d'élite* of veterans to the last, but from about 1813 the "Young Guard" was recruited directly from the best of the annual conscript contingent. The officers held a higher rank in the army than their regimental rank in the Guards. At the first Restoration an attempt was made to revive the *Maison du Roi*, but in the constitutional régime of the second Restoration this semi-medieval form of bodyguard was given up and replaced by the *Garde Royale*, a selected fighting corps. This took part in the short war with Spain and a portion of it fought in Algeria, but it was disbanded at the July Revolution. Louis Philippe had no real guard troops, but the memories of the Imperial Guard were revived by Napoleon III., who formed a large guard corps in 1853-1854. This, however, was open to an even greater degree than Napoleon I.'s guard to the objection that it took away the best soldiers from the line. Since the fall of the Empire in 1870 there have been no guard troops in France. The duty of watching over the safety of the president is taken in the ordinary roster of duty by the troops stationed in the capital. The "Republican Guard" is the Paris gendarmerie, recruited from old soldiers and armed and trained as a military body.

In *Austria-Hungary* there are only small bodies of household troops (Archer Body Guard, Trabant Guard, Hungarian Crown Guards, &c.) analogous to the British Gentlemen at Arms or Yeomen of the Guard. Similar forces, the "Noble Guard" and the "Swiss Guard," are maintained in the Vatican. The court troops of Spain are called "halberdiers" and armed with the halbert.

In *Russia* the Guard is organized as an army corps. It possesses special privileges, particularly as regards officers' advancement.

In *Germany* the distinction between armed retainers and "Guards" is well marked. The army is for practical purposes a unit under imperial control, while household troops ("castle-guards" as they are usually called) belong individually to the various sovereigns within the empire. The "Guards," as a combatant force in the army are those of the king of *Prussia* and constitute a strong army corps. This has grown gradually from a bodyguard of archers, and, as in Great Britain, the functions of the heavy cavalry regiments of the Guard preserve to some extent the name and character of a body guard (*Gardes du Corps*). The senior foot guard regiment is also personally connected with the royal family. The conversion of a palace-guard to a combatant force is due chiefly to Frederick William I., to whom drill was a ruling passion, and who substituted effective regiments for the ornamental "Trabant Guards" of his father. A further move was made by Frederick the Great in substituting for Frederick William's expensive "giant" regiment of guards a larger number of ordinary soldiers, whom he subjected to the same rigorous training and made a *corps d'élite*. Frederick the Great also formed the Body Guard alluded to above. Nevertheless in 1806 the Guard still consisted only of two cavalry regiments and four infantry regiments, and it was the example of Napoleon's imperial guard which converted this force into a corps of all arms. In 1813 its strength was that of a weak division, but in 1866 by slight but frequent augmentations it had come to consist of an army corps, complete with all auxiliary services. A few guard

¹ The "Irish Guards" of the Stuarts took the side of James II., fought against William III. in Ireland and lost their regimental identity in the French service to which the officers and soldiers transferred themselves on the abandonment of the struggle.

regiments belonging to the minor sovereigns are counted in the line of the German army. In war the Guard is employed as a unit, like other army corps. It is recruited by the assignment of selected young men of each annual contingent, and is thus free from the reproach of the French Imperial Guard, which took the best-trained soldiers from the regiments of the line.

GUARD-SHIP, a warship stationed at some port or harbour to act as a guard, and in former times in the British navy to receive the men impressed for service. She usually was the flagship of the admiral commanding on the coast. A guard-boat is a boat which goes the round of a fleet at anchor to see that due watch is kept at night.

GUÁRICO, a large inland state of Venezuela created by the territorial redivision of 1904, bounded by Aragua and Miranda on the N., Bermúdez on the E., Bolívar on the S., and Zamora on the W. Pop. (1905 estimate), 78,117. It extends across the northern *llanos* to the Orinoco and Apure rivers and is devoted almost wholly to pastoral pursuits, exporting cattle, horses and mules, hides and skins, cheese and some other products. The capital is Calabozo, and the other principal towns are Camaguán (pop. 3648) on the Portuguesa river, Guayabal (pop. 3146), on a small tributary of the Guárico river, and Zaraza (pop. 14,546) on the Unare river, nearly 150 m. S.E. of Carúacas.

GUARIENTO, sometimes incorrectly named **GUERRIERO**, the first Paduan painter who distinguished himself. The only date distinctly known in his career is 1365, when, having already acquired high renown in his native city, he was invited by the Venetian authorities to paint a Paradise, and some incidents of the war of Spoleto, in the great council-hall of Venice. These works were greatly admired at the time, but have long ago disappeared under repaintings. His works in Padua have suffered much. In the church of the Eremitani are allegories of the Planets, and, in its choir, some small sacred histories in dead colour, such as an Ecce Homo; also, on the upper walls, the life of St Augustine, with some other subjects. A few fragments of other paintings by Guariento are still extant in Padua. In the gallery of Bassano is a Crucifixion, carefully executed, and somewhat superior to a merely traditional method of handling, although on the whole Guariento must rather be classed in that school of art which preceded Cimabue than as having advanced in his vestiges; likewise two other works in Bassano, ascribed to the same hand. The painter is buried in the church of S. Bernardino, Padua.

GUARINI, CAMILLO-GUARINO (1624-1683), Italian monk, writer and architect, was born at Modena in 1624. He was at once a learned mathematician, professor of literature and philosophy at Messina, and, from the age of seventeen, was architect to Duke Philibert of Savoy. He designed a very large number of public and private buildings at Turin, including the palaces of the duke of Savoy and the prince of Cacicuan, and many public buildings at Modena, Verona, Vienna, Prague, Lisbon and Paris. He died at Milan in 1683.

GUARINI, GIOVANNI BATTISTA (1537-1612), Italian poet, author of the *Pastor fido*, was born at Ferrara on the 10th of December 1537, just seven years before the birth of Tasso. He was descended from Guarino da Verona. The young Battista studied both at Pisa and Padua, whence he was called, when not yet twenty, to profess moral philosophy in the schools of his native city. He inherited considerable wealth, and was able early in life to marry Taddea de' Bendedei, a lady of good birth. In 1567 he entered the service of Alphonso II., duke of Ferrara, thus beginning the court career which was destined to prove a constant source of disappointment and annoyance to him. Though he cultivated poetry for pastime, Guarini aimed at state employment as the serious business of his life, and managed to be sent on various embassies and missions by his ducal master. There was, however, at the end of the 16th century no opportunity for a man of energy and intellectual ability to distinguish himself in the petty sphere of Italian diplomacy. The time too had passed when the profession of a courtier, painted in such glowing terms by Castiglione, could confer either profit or honour. It is true that the court of Alphonso presented a brilliant spectacle to Europe, with Tasso for titular poet, and

an attractive circle of accomplished ladies. But the last duke of Ferrara was an illiberal patron, feeding his servants with promises, and ever ready to treat them with the brutality that condemned the author of the *Gerusalemme liberata* to a mad-house. Guarini spent his time and money to little purpose, suffered from the spite and ill-will of two successive secretaries,—Pigna and Montecatini,—quarrelled with his old friend Tasso, and at the end of fourteen years of service found himself half-ruined, with a large family and no prospects. When Tasso was condemned to S. Anna, the duke promoted Guarini to the vacant post of court poet. There is an interesting letter extant from the latter to his friend Cornelio Bentivoglio, describing the efforts he made to fill this place appropriately. "I strove to transform myself into another person, and, like a player, reassumed the character, costume and feelings of my youth. Advanced in manhood, I forced myself to look young; I turned my natural melancholy into artificial gaiety, affected loves I did not feel, exchanged wisdom for folly, and, in a word, passed from a philosopher into a poet." How ill-adapted he felt himself to this masquerade life may be gathered from the following sentence: "I am already in my forty-fourth year, the father of eight children, two of whom are old enough to be my censors, while my daughters are of an age to marry." Abandoning so un-congenial a strain upon his faculties, Guarini retired in 1582 to his ancestral farm, the Villa Guarina, in the lovely country that lies between the Adige and Po, where he gave himself up to the cares of his family, the nursing of his dilapidated fortunes and the composition of the *Pastor fido*. He was not happy in his domestic lot; for he had lost his wife young, and quarrelled with his elder sons about the division of his estate. Litigation seems to have been an inveterate vice with Guarini; nor was he ever free from legal troubles. After studying his biography, the conclusion is forced upon our minds that he was originally a man of robust and virile intellect, ambitious of greatness, confident in his own powers, and well qualified for serious affairs, whose energies found no proper scope for their exercise. Literary work offered but a poor sphere for such a character, while the enforced inactivity of court life soured a naturally capricious and choleric temper. Of poetry he spoke with a certain tone of condescension, professing to practise it only in his leisure moments; nor are his miscellaneous verses of a quality to secure for their author a very lasting reputation. It is therefore not a little remarkable that the fruit of his retirement—a disappointed courtier past the prime of early manhood—should have been a dramatic masterpiece worthy to be ranked with the classics of Italian literature. Deferring a further account of the *Pastor fido* for the present, the remaining incidents of Guarini's restless life may be briefly told. In 1585 he was at Turin superintending the first public performance of his drama, whence Alphonso recalled him to Ferrara, and gave him the office of secretary of state. This reconciliation between the poet and his patron did not last long. Guarini moved to Florence, then to Rome, and back again to Florence, where he established himself as the courtier of Ferdinand de' Medici. A dishonourable marriage, pressed upon his son Guarino by the grand-duke, roused the natural resentment of Guarini, always scrupulous upon the point of honour. He abandoned the Medicean court, and took refuge with Francesco Maria of Urbino, the last scion of the Montefeltro-della-Rovere house. Yet he found no satisfaction at Urbino. "The old court is a dead institution," he writes to a friend; "one may see a shadow of it, but not the substance in Italy of to-day. Ours is an age of appearances, and one goes a-masquerading all the year." This was true enough. Those dwindling deadly-lively little residence towns of Italian ducal families, whose day of glory was over, and who were waiting to be slowly absorbed by the capacious appetite of Austria, were no fit places for a man of energy and independence. Guarini finally took refuge in his native Ferrara, which, since the death of Alphonso, had now devolved to the papal see. Here, and at the Villa Guarina, his last years were passed in study, lawsuits, and polemical disputes with his contemporary critics, until 1612, when he died at Venice in his seventy-fifth year.

The *Pastor fido* (first published in 1590) is a pastoral drama composed not without reminiscences of Tasso's *Arcadia*. The scene is laid in Arcadia, where Guarini supposes it to have been the custom to sacrifice a maiden yearly to Diana. But an oracle has declared that when two scions of divine lineage are united in marriage, and a faithful shepherd has atoned for the ancient error of a faithless woman, this inhuman rite shall cease. The plot turns upon the unexpected fulfilment of this prophecy, contrary to all the schemes which had been devised for bringing it to accomplishment, and in despite of apparent improbabilities of divers kinds. It is extremely elaborate, and regarded as a piece of cunning mechanism, leaves nothing to be desired. Each motive has been carefully prepared, each situation amply developed. Yet, considered as a play, the *Pastor fido* disappoints a reader trained in the school of Sophocles or Shakespeare. The action itself seems to take place off the stage, and only the results of action, stationary tableaux representing the movement of the drama, are put before us in the scenes. The art is lyrical, not merely in form but in spirit, and in adaptation to the requirements of music which demands stationary expressions of emotion for development. The characters have been well considered, and are exhibited with great truth and vividness; the cold and eager hunter Silvio contrasting with the tender and romantic Mirtillo, and Corisca's meretricious arts enhancing the pure affection of Amarilli. Dorinda presents another type of love so impulsive that it prevails over a maiden's sense of shame, while the courtier Carino brings the corruption of towns into comparison with the innocence of the country. In Carino the poet painted his own experience, and here his satire upon the court of Ferrara is none the less biting because it is gravely measured. In Corisca he delineated a woman vitiated by the same town life, and a very hideous portrait has he drawn. Though a satirical element was thus introduced into the *Pastor fido* in order to relieve its ideal picture of Arcadia, the whole play is but a study of contemporary feeling in Italian society. There is no true rusticity whatever in the drama. This correspondence with the spirit of the age secured its success during Guarini's lifetime; this made it so dangerously seductive that Cardinal Bellarmine told the poet he had done more harm to Christendom by his blandishments than Luther by his heresy. Without anywhere transgressing the limits of decorum, the *Pastor fido* is steeped in sensuousness; and the immodesty of its pictures is enhanced by rhetorical concealments more provocative than nudity. Moreover, the love described is effeminate and wanton, felt less as passion than as lust enveloped in a veil of sentiment. We divine the coming age of *cicisbei* and *castrati*. Of Guarini's style it would be difficult to speak in terms of too high praise. The thought and experience of a lifetime have been condensed in these five acts, and have found expression in language brilliant, classical, chiselled to perfection. Here and there the taste of the 17th century makes itself felt in frigid conceits and forced antitheses; nor does Guarini abstain from sententious maxims which reveal the moralist rather than the poet. Yet these are but minor blemishes in a masterpiece of diction, glittering and faultless like a polished bas-relief of hard Corinthian bronze. That a single pastoral should occupy so prominent a place in the history of literature seems astonishing, until we reflect that Italy, upon the close of the 16th century, expressed itself in the *Pastor fido*, and that the influence of this drama was felt through all the art of Europe till the epoch of the Revolution. It is not a mere play. The sensual refinement proper to an age of social decadence found in it the most exact embodiment, and made it the code of gallantry for the next two centuries.

The best edition of the *Pastor fido* is the 20th, published at Venice (Ciotti) in 1602. The most convenient is that of Barbéra (Florence, 1866). For Guarini's miscellaneous *Rime*, the Ferrara edition, in 4 vols., 1737, may be consulted. His polemical writings, *Verato primo* and *secondo*, and his prose comedy called *Idropica*, were published at Venice, Florence and Rome, between 1588 and 1614.

(J. A. S.)

GUARINO, also known as VARINUS, and surnamed from his birthplace FAVORINUS, PMAVORINUS or CAMBES (c. 1450-

1537), Italian lexicographer and scholar, was born at Favera near Camerino, studied Greek and Latin at Florence under Politian, and afterwards became for a time the pupil of Lascaris. Having entered the Benedictine order, he now gave himself with great zeal to Greek lexicography; and in 1496 published his *Thesaurus cornucopias et horti Adonidis*, a collection of thirty-four grammatical tracts in Greek. He for some time acted as tutor to Giovanni dei Medici (afterwards Leo X.), and also held the appointment of keeper of the Medicean library at Florence. In 1514 Leo appointed him bishop of Nocera. In 1517 he published a translation of the *Apophtegmata* of Joannes Stobaeus, and in 1523 appeared his *Etymologicum magnum, sive thesaurus universae linguae Graecae ex multis variisque autoribus collectus*, a compilation which has been frequently reprinted, and which has laid subsequent scholars under great though not always acknowledged obligations.

GUARINO (GUARINUS) DA VERONA (1370-1460), one of the Italian restorers of classical learning, was born in 1370 at Verona, and studied Greek at Constantinople, where for five years he was the pupil of Manuel Chrysoloras. When he set out on his return to Italy he was the happy possessor of two cases of precious Greek MSS. which he had been at great pains to collect; it is said that the loss of one of these by shipwreck caused him such distress that his hair turned grey in a single night. He supported himself as a teacher of Greek, first at Verona and afterwards in Venice and Florence; in 1436 he became, through the patronage of Lionel, marquis of Este, professor of Greek at Ferrara; and in 1438 and following years he acted as interpreter for the Greeks at the councils of Ferrara and Florence. He died at Ferrara on the 14th of December 1460.

His principal works are translations of Strabo and of some of the *Lives* of Plutarch, a compendium of the Greek grammar of Chrysoloras, and a series of commentaries on Poesius, Juvenal, Martial and on some of the writings of Aristotle and Cicero. See Rosmini, *Vita e disciplina di Guarino* (1805-1806); Sabbadini, *Guarino Veronese* (1885); Sandys, *Hist. Class. Schol.* ii. (1908).

GUARNIERI, or GUARNERIUS, a celebrated family of violin-makers of Cremona. The first was Andreas (c. 1626-1698), who worked with Antonio Stradivari in the workshop of Nicolo Amati (son of Geronimo). Violins of a model original to him are dated from the sign of "St Theresa" in Cremona. His son Joseph (1666-c. 1739) made instruments at first like his father's, but later in a style of his own with a narrow waist; his son, Peter of Venice (b. 1695), was also a fine maker. Another son of Andreas, Peter (Pietro Giovanni), commonly known as "Peter of Cremona" (b. 1655), moved from Cremona and settled at Mantua, where he too worked "sub signo Sanctae Teresae." Peter's violins again showed considerable variations from those of the other Guarneri. Hart, in his work on the violin, says, "There is increased breadth between the sound-holes; the sound-hole is rounder and more perpendicular; the middle bouts are more contracted, and the model is more raised."

The greatest of all the Guarneri, however, was a nephew of Andreas, Joseph del Gesu (1687-1745), whose title originates in the I.H.S. inscribed on his tickets. His master was Gaspar di Salo. His conception follows that of the early Brescian makers in the boldness of outline and the massive construction which aim at the production of tone rather than visual perfection of form. The great variety of his work in size, model, &c., represents his various experiments in the direction of discovering this tone. A stain or sap-mark, parallel with the finger-board on both sides, appears on the bellies of most of his instruments. Since the middle of the 18th century a great many spurious instruments ascribed to this master have poured over Europe. It was not until Paganini played on a "Joseph" that the taste of amateurs turned from the sweetness of the Amati and the Stradivarius violins in favour of the robuster tone of the Joseph Guarnerius. See VIOLIN.

GUASTALLA, a town and episcopal see of Emilia, Italy, in the province of Reggio, from which it is 18 m. N. by road, on the S. bank of the Po, 70 ft. above sea-level. It is also connected by rail with Parma and Mantua (via Suzzara). Pop.

(1901), 2658 (town); 11,091 (commune). It has 16th-century fortifications. The cathedral, dating from the 16th century, has been frequently restored. Guatemala was founded by the Lombards in the 7th century; in the church of the Pieve Pope Paschal II. held a council in 1106. In 1507 it was seized by Giberto da Correggio of Parma. In 1503 it passed to Guido Torello, cousin of Filippo Maria Visconti of Milan. In 1539 it was sold by the last female descendant of the Torelli to Ferrnste Gonsaga. In 1621 it was made the seat of a duchy, but in 1748 it was added to those of Parma and Piacenza, whose history it subsequently followed.

GUATEMALA (sometimes incorrectly written **GUATMALA**), a name now restricted to the republic of Guatemala and to its chief city, but formerly given to a captaincy-general of Spanish America, which included the fifteen provinces of Chiapas, Suchitepeques, Escuintla, Sonsonate, San Salvador, Vera Paz and Peten, Chiquimula, Hoaduraz, Nicaragua, Costa Rica, Totonicapam, Quezaltenango, Sololá, Chimaltenango and Sacatepeques,—or, in other words, the whole of Central America (except Panama) and part of Mexico. The name is probably of Aztec origin, and is said by some authorities to mean in its native form Quauhtemalan, "Land of the Eagle," or "Land of Forest"; others, writing it U-ha-tez-ma-la, connect it with the volcano of Agua (*i.e.* "water"), and interpret it as "mountain vomiting water."

The republic of Guatemala is situated between 13° 42' and 17° 40' N., and 88° 10' and 92° 30' W. (For map, see **CENTRAL AMERICA**.) Pop. (1903), 1,842,134; area about 48,250 sq. m. Guatemala is bounded on the W. and N. by Mexico, N.E. by British Honduras, E. by the Gulf of Honduras, and the republic of Honduras, S.E. by Salvador and S. by the Pacific Ocean. The frontier towards Mexico was determined by conventions of the 27th of September 1882, the 17th of October 1883, the 1st of April 1895, and the 8th of May 1899. Starting from the Pacific, it ascends the river Suchiate, then follows an irregular line towards the north-east, till it reaches the parallel of 17° 49' N., along which it runs to the frontier of British Honduras. This frontier, by the convention of the 9th of July 1893, coincides with the meridian of 80° 20' W., till it meets the river Sarstoon or Sarstun, which it follows eastwards to the Gulf of Honduras.

Physical Description.—Guatemala is naturally divided into five regions—the lowlands of the Pacific coast, the volcanic mountains of the Sierra Madre, the so-called plateaus immediately north of these, the mountains of the Atlantic versant and the plain of Peten. (1) The coastal plains extend along the entire southern seaboard, with a mean breadth of 50 m., and link together the belts of similar territory in Salvador and the district of Soconusco in Chiapas. Owing to their tropical heat, low elevation above sea-level, and marshy soil, they are thinly peopled, and contain few important towns except the seaports. (2) The precipitous barrier of the Sierra Madre, which closes in the coastal plains on the north, is similarly prolonged into Salvador and Mexico. It is known near Guatemala city as the Sierra de las Nubes, and enters Mexico as the Sierra de Ixtatan. It forms the main watershed between the Pacific and Atlantic river systems. Its summit is not a well-defined crest, but is often rounded or flattened into a table-land. The direction of the great volcanic cones, which rise in an irregular line above it, is not identical with the main axis of the Sierra itself, except near the Mexican frontier, but has a more southerly trend, especially towards Salvador; here the base of many of the igneous peaks rests among the southern foothills of the range. It is, however, impossible to subdivide the Sierra Madre into a northern and a volcanic chain; for the volcanoes are isolated by stretches of comparatively low country; at least thirteen considerable streams flow down between them, from the main watershed to the sea. Viewed from the coast, the volcanic cones seem to rise directly from the central heights of the Sierra Madre, above which they tower; but in reality their bases are, as a rule, farther south. East of Tacana, which marks the Mexican frontier, and is variously estimated at 13,976 ft. and 13,090 ft., and if the higher estimate be correct is the loftiest peak in Central America, the principal volcanoes are—Tajumulco or Tajumulco (13,517 ft.); Santa Maria (12,467 ft.), which was in eruption during 1902, after centuries of quiescence, in which its slopes had been overgrown by dense forests; Atitlán (11,719), overlooking the lake of that name; Acatanangó (13,615), which shares the claim of Tacana to be the highest mountain of Central America; Fuego (*i.e.* "fire," variously estimated at 12,795 ft. and 12,582 ft.), which received its name from its activity at the time of the Spanish conquest; Agua (*i.e.* "water," 12,139 ft.),

so named in 1541 because it destroyed the former capital of Guatemala with a deluge of water from its flooded crater; and Pacaya (8390), a group of igneous peaks which were in eruption in 1870. (3) The so-called plateaus which extend north of the Sierra Madre are in fact high valleys, rather than table-lands, enclosed by mountains. A better idea of this region is conveyed by the native name Altos, or highlands, although that term includes the northern declivity of the Sierra Madre. The mean elevation is greatest in the west (Altos of Quezaltenango) and least in the east (Altos of Guatemala). A few of the streams of the Pacific slope actually rise in the Altos, and force a way through the Sierra Madre at the bottom of deep ravines. One large river, the Chixoy, escapes northwards towards the Atlantic. (4) The relief of the mountainous country which lies north of the Altos and drains into the Atlantic is varied by innumerable terraces, ridges and underfalls; but its general configuration is admirably compared by E. Reclus with the appearance of "a stormy sea breaking into parallel billows" (*Universal Geography*, ed. E. G. Ravenstein, div. xxxiii, p. 212). The parallel ranges extend east and west with a slight southerly curve towards their centres. A range called the Sierra de Chama, which, however, changes its name frequently from place to place, strikes eastward towards British Honduras, and is connected by low hills with the Cockscomb Mountains; another similar range, the Sierra de Santa Cruz, continues east to Cape Coccol between the Polochic and the Sarstoon; and a third, the Sierra de las Minas or, in its eastern portion, Sierra del Mico, stretches between the Polochic and the Motagua. Between Honduras and Guatemala the frontier is formed by the Sierra de Merendon. (5) The great plain of Peten, which comprises about one-third of the whole area of Guatemala, belongs geographically to the Yucatan Peninsula, and consists of level or undulating country, covered with grass or forest. Its population numbers less than two per sq. m., although many districts have a wonderfully fertile soil and abundance of water. The greater part of this region is uncultivated, and only utilized as pasture by the Indians, who form the majority of its inhabitants.

Guatemala is richly watered. On the western side of the sierras the versant is short, and the streams, while very numerous, are consequently small and rapid; but on the eastern side a number of the rivers attain a very considerable development. The Motagua, whose principal head stream is called the Rio Grande, has a course of about 250 m., and is navigable to within 90 m. of the capital, which is situated on one of its confluent, the Rio de las Vacas. It forms a delta on the south of the Gulf of Honduras. Of similar importance is the Polochic, which is about 180 m. in length, and navigable about 20 m. above the river-port of Telemán. Before reaching the Golfo Amatique it passes through the Golfo Dulce, or Izabal Lake, and the Golfo Dulce. A vast number of streams, among which are the Chixoy, the Guadalupe, and the Rio de la Pasion, unite to form the Usumacinta, whose noble current passes along the Mexican frontier, and flowing on through Chiapas and Tabasco, falls into the Bay of Campeche. The Chiapas follows a similar course.

There are several extensive lakes in Guatemala. The Lake of Peten or Laguna de Flores, in the centre of the department of Peten, is an irregular basin, about 27 m. long, with an extreme breadth of 13 m. In an island in the western portion stands Flores, a town well known to American antiquaries for the number of ancient idols which have been recovered from its soil. On the shore of the lake is the stalactite cave of Jobitinal, of great local celebrity; and in its depths, according to the popular legend, may still be discerned the stone image of a horse that belonged to Cortes. The Golfo Dulce is, as its name implies, a fresh-water lake, although so near the Atlantic. It is about 36 m. long, and would be of considerable value as a harbour if the bar at the mouth of the Rio Dulce did not prevent the upward passage of seafaring vessels. As a contrast the Lake of Atitlán (*q.v.*) is a land-locked basin encompassed with lofty mountains. About 9 m. S. of the capital lies the Lake of Amatitlán (*q.v.*) with the town of the same name. On the borders of Salvador and Guatemala there is the Lake of Guixá, about 20 m. long and 12 broad, at a height of 2100 ft. above the sea. It is connected by the river Ostuma with the Lake of Ayarza which lies about 1000 ft. higher at the foot of the Sierra Madre.

The geology, fauna and flora of Guatemala are discussed under **CENTRAL AMERICA**. The bird-life of the country is remarkably rich; one bird of magnificent plumage, the quetzal, quijal or quetzal (*Trogon resplendens*), has been chosen as the national emblem. **Climate.**—The climate is healthy, except on the coasts, where malarial fever is prevalent. The rainy season in the interior lasts from May to October, but on the coast sometimes continues till December. The coldest month is January, and the warmest is May. The average temperatures for these months at places of different altitudes, as given by Dr Karl Sapper, are shown on the following page.

The average rainfall is very heavy, especially on the Atlantic slope, where the prevailing winds are charged with moisture from the Gulf of Mexico or the Caribbean Sea; at Tual, a high station on the Atlantic slope, it reaches 195 in.; in central Guatemala it is only 27 in. Towards the Atlantic rain often occurs in the dry season, and there is a local saying near the Golfo Dulce that "it rains thirteen months in the year." Fogs are not rare. In Guatemala,

Locality.	Altitude (Feet).	Fahrenheit Degrees.	
		January.	May
Puerto Barrios	6	74	81
Salamá	3020	68	77
Campur	3050	64	73
Chimax	4280	61	68
Guatemala	4870	60	67
Quezaltenango	7710	50	62

as in other parts of Central America (*q.v.*), each of the three climatic zones, cold, temperate and hot (*tierra fría, tierra templada, tierra caliente*) has its special characteristics, and it is not easy to generalize about the climate of the country as a whole.

Natural Products.—The minerals discovered in Guatemala include gold, silver, lead, tin, copper, mercury, antimony, coal, salt and sulphur; but it is uncertain if many of these exist in quantities sufficient to repay exploitation. Gold is obtained at Las Quebradas near Izabal, silver in the departments of Santa Rosa and Chiquimula, salt in those of Santa Rosa and Alta Vera Paz. During the 17th century gold-washing was carried on by English miners in the Motagua valley, and is said to have yielded rich profits; hence the name of "Gold Coast" was not infrequently given to the Atlantic littoral near the mouth of the Motagua.

The area of forest has only been seriously diminished in the west, and amounted to 2030 sq. m. in 1904. Besides rubber, it yields many valuable dye-woods and cabinet-woods, such as cedar, mahogany and logwood. Fruits, grain and medicinal plants are obtained in great abundance, especially where the soil is largely of volcanic origin, as in the Altos and Sierra Madre. Parts of the Peten district are equally fertile, maize in this region yielding two hundredfold on unmanured soil. The vegetable products of Guatemala include coffee, cocoa, sugar-cane, bananas, oranges, vanilla, aloe, agave, ipecacuanha, castor-oil, sarsaparilla, cinchona, tobacco, indigo and the wax-plant (*Myrtila cerifera*).

Inhabitants.—The inhabitants of Guatemala, who tend to increase rapidly owing to the high birth-rate, low mortality, and low rate of emigration, numbered in 1903 1,842,134, or more than one-third of the entire population of Central America. Fully 60% are pure Indians, and the remainder, classed as *Ladinos* or "Latinos" (*i.e.* Spaniards in speech and mode of life), comprise a large majority of half-castes (*mestizos*) and civilized Indians and a smaller proportion of whites. It includes a foreign population of about 12,000 Europeans and North Americans, among them being many Jews from the west of the United States. There are important German agricultural settlements, and many colonists from north Italy who are locally called *Tiroleses*, and despised by the Indians for their industry and thrift. About half the births among the Indians and one-third among the whites are illegitimate.

No part of Central America contains a greater diversity of tribes, and in 1883 Otto Stoll estimated the number of spoken languages as eighteen, although east of the meridian of Lake Amatitlán the native speech has almost entirely disappeared and been replaced by Spanish. The Indians belong chiefly to the Maya stock, which predominates throughout Peten, or to the allied Quiché race which is well represented in the Altos and central districts. The Itzas, Mopans, Lacandons, Chols, Pokonchi and the Pokomans who inhabit the large settlement of Mixco near the capital, all belong to the Maya family; but parts of central and eastern Guatemala are peopled by tribes distinct from the Mayas and not found in Mexico. In the 16th century the Mayas and Quichés had attained a high level of civilization (see CENTRAL AMERICA, *Archæology*), and at least two of the Guatemalan languages, Quiché and Cakchiquel, possess the rudiments or the relics of a literature. The Quiché *Popol Vuh*, or "Book of History," which was translated into Spanish by the Dominican friar Ximenes, and edited with a French version by Brasseur de Bourbourg, is an important document for students of the local myths. In appearance the various Guatemalan tribes differ very little; in almost all the characteristic type of Indian is short but muscular, with low forehead, prominent cheek-bones and straight black hair. In character the Indians are, as a rule, peaceable, though conscious of their numerical superiority and at times driven to join in the revolutions which so often disturb the course of local politics; they are often intensely religious, but with a few exceptions

are thriftless, indolent and inveterate gamblers. Their *cofrades*, or brotherhoods, each with its patron saint and male and female chiefs, exist largely to organize public festivals, and to purchase wooden masks, costumes and decorations for the dances and dramas in which the Indians delight. These dramas, which deal with religious and historical subjects, are of Indian origin, and somewhat resemble the mystery-plays of medieval Europe, a resemblance heightened by the introduction, due to Spanish missionaries, of Christian saints and heroes such as Charlemagne. The Indians are devoted to bull-fighting and cock-fighting. Choral singing is a popular amusement, and is accompanied by the Spanish guitar and native wind-instruments. The Indians have a habit of consuming a yellowish edible earth containing sulphur; on pilgrimages they obtain images moulded of this earth at the shrines they visit, and eat the images as a prophylactic against disease. Maize, beans and bananas, varied occasionally with dried meat and fresh pork, form their staple diet; drunkenness is common on pay-days, and festivals, when large quantities of a fiery brandy called *chicha* are consumed.

Chief Towns.—The capital of the republic, Guatemala or Guatemala la Nueva (pop. 1905 about 97,000) and the cities of Quezaltenango (31,000), Totonicapam (28,000), Coban (25,000), Sololá (17,000), Escuintla (12,000), Huehuetanango (12,000), Amatitlán (10,000) and Atitlán (9000) are described under separate headings. All the chief towns except the seaports are situated within the mountainous region where the climate is temperate. Retalhuleu, among the southern foothills of the Sierra Madre, is one of the centres of coffee production, and is connected by rail with the Pacific port of Champerico, a very unhealthy place in the wet season. Both Retalhuleu and Champerico were, like Quezaltenango, Sololá, and other towns, temporarily ruined by the earthquake of the 18th of April 1902. Santa Cruz Quiché, 25 m. N.E. of Totonicapam, was formerly the capital of the Quiché kings, but has now a Ladino population. Livingston, a seaport at the mouth of the Polochic (here called the Río Dulce), was founded in 1806, and subsequently named after the author of a code of Guatemalan laws; few vestiges remain of the Spanish settlement of Sevilla la Nueva, founded in 1844, and of the English colony of Abbotville, founded in 1825,—both near Livingston. La Libertad, also called by its Indian name of Sacluc, is the principal town of Peten.

Shipping and Communications.—The republic is in regular steam communication on the Atlantic side with New Orleans, New York and Hamburg, by vessels which visit the ports of Barrios (Santo Tomas) and Livingston. On the southern side the ports of San José, Champerico and Ocos are visited by the Pacific mail steamers, by the vessels of a Hamburg company and by those of the South American (Chilean) and the Pacific Steam Navigation Companies. Itzapa, formerly the principal harbour on the south coast, has been almost entirely abandoned since 1853. Gualan, on the Motagua, and Panzos, on the Polochic, are small river-ports. The principal towns are connected by wagon roads, towards the construction and maintenance of which each male inhabitant is required to pay two pesos or give four days' work a year. There are coach routes between the capital and Quezaltenango, but over a great portion of the country transport is still on mule-back. All the railway lines have been built since 1875. The main lines are the Southern, belonging to an American company and running from San José to the capital; the Northern, a government line from the capital to Puerto Barrios, which completes the interoceanic railroad; and the Western, from Champerico to Quezaltenango, belonging to a Guatemalan company, but largely under German management. For local traffic there are several lines: one from Itzapa, near San José, to Narajón, and another from Ocos to the western coffee plantations. On the Atlantic slope transport is effected mainly by river tow-boats from Livingston along the Golfo Dulce and other lakes, and the Polochic river as far as Panzós. The narrow-gauge railway that serves the German plantations in the Vera Paz region is largely owned by Germans.

Guatemala joined the Postal Union in 1881; but its postal and telegraphic services have suffered greatly from financial difficulties. The telephonic systems of Guatemala la Nueva, Quezaltenango and other cities are owned by private companies.

Commerce and Industry.—The natural resources of Guatemala are rich but undeveloped; and the capital necessary for their development is not easily obtained in a country where war, revolution and economic crises recur at frequent intervals, where the premium on gold has varied by no less than 500% in a single year, and where many of the wealthiest cities and agricultural districts have been destroyed by earthquake in one day (18th of April 1902). At the beginning of the 19th century, Guatemala had practically no export trade; but between 1825 and 1850 cochineal was largely exported, the centre of production being the Amatitlán district. This industry was ruined by the competition of chemical dyes, and a substitute was found in the cultivation of coffee.

Guatemala is surpassed only by Brazil and the East Indies in the quantity of coffee it exports. The chief plantations are owned and managed by Germans; more than half of the crop is sent to Germany, while three-fifths of the remainder go to the United States and one-fifth to Great Britain. The average yearly product is about 70,000,000 lb, worth approximately £1,300,000, and subject to an export duty of one gold dollar (4s.) per quintal (101 lb). Sugar, bananas, tobacco and cocoa are also cultivated; but much of the sugar and bananas, most of the cocoa, and all the tobacco are consumed in the country. During the colonial period, the cocoa of western Guatemala and Soconusco was reserved on account of its fine flavour for the Spanish court. The indigo and cotton plantations yield little profit, owing to foreign competition, and have in most cases been converted to other uses. The cultivation of bananas tends to increase, though more slowly than in other Central American countries. Grain, sweet potatoes and beans are grown for home consumption. Cattle-farming is carried on in the high pasture-lands and the plains of Peten; but the whole number of sheep (77,000 in 1900) and pigs (30,000) in the republic is inferior to the number kept in many single English counties. Much of the wool is sold, like the native cotton, to Indian and Ladino women, who manufacture coarse cloth and linen in their homes.

By the Land Act of 1894 the state domains, except on the coasts and frontiers, were divided into lots for sale. The largest holding tenable by one person under this act was fixed at 50 caballerias, or 562½ acres; the price varies from £40 to £80 per caballeria of 112½ acres. Free grants of uncultivated land are sometimes made to immigrants (including foreign companies), to persons who undertake to build roads or railways through their allotments, to towns, villages and schools. The condition of the Indians on the plantations is often akin to slavery, owing to the system adopted by some planters of making payments in advance, for the Indians soon spend their earnings, and thus contract debts which can only be repaid by long service.

In addition to the breweries, rum and brandy distilleries, sugar mills and tobacco factories, which are sometimes worked on adjacent to the plantations, there are many purely urban industries, such as the manufacture of woollen and cotton goods on a large scale, and manufactures of building material and furniture; but these industries are far less important than agriculture.

During the five years 1900 to 1904 inclusive, the average value of Guatemalan imports, which consisted chiefly of textiles, iron and machinery, sacks, provisions, flour, beer, wine and spirits, amounted to £776,000; about one-half came from the United States, and nearly one-fourth from the United Kingdom. The exports during the same period had an average value of £1,528,000, and ranked as follows in order of value: coffee (£1,300,000), timber, hides, rubber, sugar, bananas, cocoa.

Finance.—Within the republic there are six banks of issue, to which the government is deeply indebted. There is practically neither gold nor silver in circulation, and the value of the bank-notes is so fluctuating that trade is seriously hampered. On the 25th of June 1903, the issue of bank-notes without a guarantee was restricted; and thenceforward all banks were compelled to retain gold or silver to the value of 10% of the notes issued in 1904, 20% in 1905 and 30% in 1906. This reform has not, to any appreciable extent, rendered more stable the value of the notes issued. The silver peso, or dollar, of 100 centavos is the monetary unit, weighs 25 grammes .900 fine, and has a nominal value of 4s. Being no longer current it has been replaced by the paper peso. The nickel coins include the real (nominal value 6d.), half-real and quarter-real. The metric system of weights and measures has been adopted, but the old Spanish standards remain in general use.

Of the revenue, about 64% is derived from customs and excise; 9% from property, road, military, slaughter and salt taxes; 17% from the gunpowder monopoly, and the remainder from various taxes, stamps, government lands, and postal and telegraph services. The estimated revenue for 1905-1906 was 23,000,000 pesos (about £328,500), the estimated expenditure was 27,317,659 pesos (£390,200), of which £242,800 were allotted to the public debt, £42,000 to internal development and justice, £29,000 to the army and the remainder largely to education. The gold value of the currency peso (75 = £1 in 1902, 70 = £1 in 1904, 58 = £1 in 1905) fluctuates between limits so wide that conversion into sterling (especially for a series of years), with any pretension to accuracy, is impracticable. In 1899 the rate of exchange moved between 710% and 206% premium on gold. According to the official statement, the gold debt, which runs chiefly at 4% and is held in Germany and England, amounted to £1,087,905 on the 1st of January 1905; the currency debt (note issues, internal loans, &c.) amounted to £704,730; total £2,692,635, a decrease since 1900 of about £300,000.

Government.—According to the constitution of December 1879 (modified in 1885, 1887, 1889 and 1903) the legislative power is vested in a national assembly of 69 deputies (1 for every 20,000 inhabitants) chosen for 4 years by direct popular vote, under universal manhood suffrage. The president of the republic

is elected in a similar manner, but for 6 years, and he is theoretically not eligible for the following term. He is assisted by 6 ministers, heads of government departments, and by a council of state of 13 members, partly appointed by himself and partly by the national assembly.

Local Government.—Each of the twenty-two departments is administered by an official called a *jefe político*, or political chief, appointed by the president, and each is subdivided into municipal districts. These districts are administered by one or more *alcaldes* or mayors, assisted by municipal councils, both *alcaldes* and councils being chosen by the people.

Justice.—The judicial power is vested in a supreme court, consisting of a chief justice and four associate justices elected by the people; six appeal courts, each with three judges, also elected by the people; and twenty-six courts of first instance, each consisting of one judge appointed by the president and two by the chief justice of the supreme court.

Religion and Instruction.—The prevailing form of religion is the Roman Catholic, but the state recognizes no distinction of creed. The establishment of conventual or monastic institutions is prohibited. Of the population in 1893, 90% could neither read nor write, 2% could only read, and 8% could read and write. Primary instruction is nominally compulsory, and, in government schools, is provided at the cost of the state. In 1903 there were 1064 government primary schools. There are besides about 128 private (occasionally aided) schools of similar character, owners of plantations on which there are more than ten children being obliged to provide school accommodation. Higher instruction is given in two national institutes at the capital, one for men with 500 pupils and one for women with 300. At Quetzaltenango there are two similar institutes, and at Chiquimula there are other two. To each of the six there is a school for teachers attached, and within the republic there are four other schools for teachers. For professional instruction (law, medicine, engineering) there are schools supported by private funds, but aided occasionally by the government. Other educational establishments are a school of art, a national conservatory of music, a commercial college, four trades' schools with more than 600 pupils and a national library. There is a German school, endowed by the German government.

Defence.—For the white and mixed population military service is compulsory; from the eighteenth to the thirtieth year of age in the active army, and from the thirtieth to the fiftieth in the reserve. The effective force of the active army is 56,000, of the reserve 20,400. About 7000 officers and men are kept in regular service. Military training is given in all public and most private schools.

History.—Guatemala was conquered by the Spaniards under Pedro de Alvarado between 1522 and 1524. Up to the years 1837-1839 its history differs only in minor details from that of the neighbouring states of Central America (q.v.). The colonial period was marked by the destruction of the ancient Indian civilization, the extermination of many entire tribes, and the enslavement of the survivors, who were exploited to the utmost for the benefit of Spanish officials and adventurers. But although the administration was weak, corrupt and cruel, it succeeded in establishing the Roman Catholic religion, and in introducing the Spanish language among the Indians and Ladinos, who thus obtained a tincture of civilization and ultimately a desire for more liberal institutions. The Central American provinces revolted in 1821, were annexed to the Mexican empire of Iturbide from 1822 to 1823, and united to form a federal republic from 1823 to 1839. In Guatemala the Clerical, Conservative or anti-Federal party was supreme; after a protracted struggle it overthrew the Liberals or Federalists, and declared the country an independent republic, with Rafael Carrera (1814-1865) as president. In 1845 an attempt to restore the federal union failed; in 1851 Carrera defeated the Federalist forces of Honduras and Salvador at La Arada near Chiquimula, and was recognized as the pacificator of the republic. In 1851 a new constitution was promulgated, and Carrera was appointed president till 1856, a dignity which was in 1854 bestowed upon him for life. His

rivalry with Gerardo Barrios (d. 1865), president of Salvador, resulted in open war in 1863. At Coatepeque the Guatemalans suffered a severe defeat, which was followed by a truce. Honduras now joined with Salvador, and Nicaragua and Costa Rica with Guatemala. The contest was finally settled in favour of Carrera, who besieged and occupied San Salvador and made himself dominant also in Honduras and Nicaragua. During the rest of his rule, which lasted till his death in April 1865, he continued to act in concert with the Clerical party, and endeavoured to maintain friendly relations with the European governments. Carrera's successor was General Cerna, who had been recommended by him for election. The Liberal party began to rise in influence about 1870, and in May 1871 Cerna was deposed. The archbishop of Guatemala and the Jesuits were driven into exile as intriguers in the interests of the Clericals. Pres. Rufino Barrios (1835-1885), elected in 1873, governed the country after the manner of a dictator; he expelled the Jesuits, confiscated their property and disestablished and disendowed the church. But though he encouraged education, promoted railway and other enterprises, and succeeded in settling difficulties as to the Mexican boundary, the general result of his policy was baneful. Conspiracies against him were rife, and in 1884 he narrowly escaped assassination. His ambition was to be the restorer of the federal union of the Central American states, and when his efforts towards this end by peaceful means failed he had recourse to the sword. Counting on the support of Honduras and Salvador, he proclaimed himself, in February 1885, the supreme military chief of Central America, and claimed the command of all the forces within the five states. President Zaldívar, of Salvador, had been his friend, but after the issue of the decree of union he entered into a defensive alliance with Costa Rica and Nicaragua. In March Barrios invaded Salvador, and on the 2nd of April a battle was fought, in which the Guatemalan president was killed. He was succeeded by General Manuel Barillas. No further effort was made to force on the union, and on the 16th of April the war was formally ended. Peace, however, only provided opportunity for domestic conspiracy, with assassination and revolution in view. In 1892 General José María Reina Barrios was elected president, and in 1897 he was re-elected; but on the 8th of February 1898 he was assassinated. Señor Morales, vice-president, succeeded him; but in the same year Don Manuel Estrada Cabrera (b. 1857) was elected president for the term ending 1905. Cabrera promoted education, commerce and the improvement of communications, but his re-election for the term 1905-1912 caused widespread discontent. He was charged with aiming at a dictatorship, with permitting or even encouraging the imprisonment, torture and execution without trial of political opponents, with maladministration of the finances and with aggression against the neighbouring states. A well-armed force, which included a body of adventurers from San Francisco (U.S.A.) was organised by General Barillas, the ex-president, and invaded Guatemala in March 1906 from Mexico. British Honduras and Salvador Barillas (1845-1907) proclaimed his intention of establishing a silver currency, and gained, to a great extent, the sympathy of the German and British residents; he had been the sole Guatemalan president who had not sought to prolong his own tenure of office. Ocos was captured by his lieutenant, General Castillo, and the revolution speedily became a war, in which Honduras, Costa Rica and Salvador were openly involved against Guatemala, while Nicaragua was hostile. But Cabrera held his ground, and even gained several indecisive victories. The intervention of President Roosevelt and of President Díaz of Mexico brought about an armistice on the 19th of July, and the so-called "Marblehead Pact" was signed on the following day on board the United States cruiser "Marblehead." Its terms were embodied in a treaty signed (28th of September) by representatives of the four belligerent states, Nicaragua taking no part in the negotiations. The treaty included regulations for the improvement of commerce and navigation in the area affected by the war, and provided for the settlement of subsequent disputes by the arbitration of the United States and Mexico.

BIBLIOGRAPHY.—Besides the works cited under CENTRAL AMERICA see the interesting narrative of Thomas Gage, the English missionary, in Juarros, *Compendio de la historia de Guatemala* (1806-1818, 2 vols.; new ed., 1857), which in Bailly's English translation (London, 1823) long formed the chief authority. See also C. Juan Anino, *La República de Guatemala* (Guatemala, 1894); T. Brigham, *Guatemala, The Land of the Quetzal* (London, 1887); J. M. Caceres, *Geografía de Centro-América* (Paris, 1882); G. Lemale, *Gaço geográfica de los centros de población de la república de Guatemala* (Guatemala, 1882); F. A. de Fuentes y Guzman, *Historia de Guatemala o Recordación Florida* (Madrid, 1882); A. C. and A. P. Maudslay, *A Glimpse at Guatemala, and some Notes on the Ancient Monuments of Central America* (London, 1899); Gustavo Niederlein, *The Republic of Guatemala* (Philadelphia, 1896); Ramon A. Salazar, *Historia del desenvolvimiento intelectual de Guatemala*, vol. i (Guatemala, 1897); Otto Stoll, *Reisen und Schilderungen aus den Jahren 1878-1883* (Leipzig, 1886); J. Mendez, *Guía del inmigrante en la república de Guatemala* (Guatemala, 1895); Karl Sapper, "Grundzüge der physikalischen Geographie von Guatemala," *Ergänzungsheft No. 115, Petermann's Mitteilungen* (Gotha, 1894); *Anuario de estadística de la república de Guatemala* (Guatemala); *Memoria de la Secretaría de Instrucción Pública* (Guatemala, 1899); *Handbook of Guatemala*, revised (Bureau of the American Republics, Washington, 1897); *United States Consular Reports* (Washington); *British Foreign Office Diplomatic and Consular Reports* (London).

GUATEMALA, or **GUATEMALA LA NUEVA** (i.e. "New Guatemala," sometimes written Nueva Guatemala, and formerly Santiago de los Caballeros de Guatemala), the capital of the republic of Guatemala, and until 1821 of the Spanish captaincy-general of Guatemala, which comprised Chiapas in Mexico and all Central America except Panama. Pop. (1905) about 97,000. Guatemala is built more than 5000 ft. above sea-level, in a wide table-land traversed by the Rio de las Vacas, or Cow River, so called from the cattle introduced here by Spanish colonists in the 16th century. Deep ravines mark the edge of the table-land, and beyond it lofty mountains rise on every side, the highest peaks being on the south, where the volcanic summits of the Sierra Madre exceed 12,000 ft. Guatemala has a station on the transcontinental railway from Puerto Barrios on the Atlantic (100 m. N.E.) to San José on the Pacific (75 m. S. by W.). It is thrice the size of any other city in the republic, and has a corresponding commercial superiority. Its archbishop is the primate of Central America (excluding Panama). Like most Spanish-American towns Guatemala is laid out in wide and regular streets, often planted with avenues of trees, and it has extensive suburbs. The houses, though usually of only one storey, are solidly and comfortably constructed; many of them are surrounded by large gardens and courts. Among the open spaces the chief are the Plaza Mayor, which contains the cathedral, erected in 1730, the archiepiscopal palace, the government buildings, the mint and other public offices; and the more modern Reforma Park and Plaza de la Concordia, now the favourite resorts of the inhabitants. There are many large schools for both sexes, besides hospitals and an orphanage. Many of the principal buildings, such as the military academy, were originally convents. The theatre, founded in 1858, is one of the best in Central America. A museum, founded in 1831, is maintained by the Sociedad Economica, which in various ways has done great service to the city and the country. There are two fortresses, the Castillo Matamoros, built by Rafael Carrera (see GUATEMALA [republic] under *History*), and the Castillo de San José. Water is brought from a distance of about 8 m. by two old aqueducts from the towns of Mixco and Finlia; fuel and provisions are largely supplied by the Pokoman Indians of Mixco. The general prosperity, and to some extent the appearance, of Guatemala have procured it the name of the Paris of Central America. It is lighted by electricity and has a good telephone service. Its trade is chiefly in coffee, but it also possesses cigar factories, wool and cotton factories, breweries, tanneries and other industrial establishments. The foreign trade is chiefly controlled by Germans.

The first city named Guatemala, now called Ciudad Vieja or "Old City," was founded in 1527 by Pedro de Alvarado, the conqueror of the country, on the banks of the Rio Penasivo, and at the foot of the volcano of Agua (i.e. "Water"). In 1541 it was overwhelmed by a deluge of water from the flood

crater of Agua; and in 1542 Alvarado founded Santiago de los Caballeros in Nueva, now Antigua. This city flourished greatly, and by the middle of the 18th century had become the most populous place in Central America, with 60,000 inhabitants and more than 100 churches and convents. But in 1773 it was ruined by an earthquake. It was rebuilt, and ultimately became capital of the department of Sacatepeques, and a health-resort locally celebrated for its thermal springs. But the Guatemalans determined to found a new capital on the site occupied by the hamlet of Ermita, 27 m. N.E. Here the third and last city of Guatemala was built, and became the seat of government in 1779. The remarkable regularity of the streets is due to the construction of the city on a uniform plan. The wide area covered, and the lowness of the houses, were similarly due to an ordinance which, in order to minimize the danger from earthquakes, forbade the erection of any building more than 30 ft. high. Many of the bellies of convents or churches, added after the ordinance had fallen into abeyance, were overthrown by the earthquake of 1874, which also destroyed a large part of Antigua.

GUATOS, a tribe of South American Indians of the upper Paraguay. They are of a European fairness and wear beards. They live almost entirely in canoes, building rough shelters in the swamps. They aided the Brazilians in the war with Paraguay 1865-70. Very few survive.

GUATOSOS, a tribe of American Indians of Costa Rica. They are an active, hardy people, who have always maintained hostility towards the Spaniards and retain their independence. From their language they appear to be a distinct stock. They were described by old writers as being very fair, with flaxen hair, and these reports led to a belief, since exploded, that they were European hybrids. There are very few surviving.

GUAVA (from the Mexican *guayaba*), the name applied to the fruits of species of *Psidium*, a genus belonging to the natural order *Myrtaceae*. The species which produces the bulk of the guava fruits of commerce is *Psidium Guajava*, a small tree from 15 to 20 ft. high, a native of the tropical parts of America and the West Indies. It bears short-stalked ovate or oblong leaves, with strongly marked veins, and covered with a soft tomentum or down. The flowers are borne on axillary stalks, and the fruits vary much in size, shape and colour, numerous forms and varieties being known and cultivated. The variety of which the fruits are most valued is that which is sometimes called the white guava (*P. Guajava*, var. *pyrifolium*). The fruits are pear-shaped, about the size of a hen's egg, covered with a thin bright yellow or whitish skin filled with soft pulp, also of a light yellowish tinge, and having a pleasant sweet-acid and somewhat aromatic flavour. *P. Guajava*, var. *pomiferum*, produces a more globular or apple-shaped fruit, sometimes called the red guava. The pulp of this variety is mostly of a darker colour than the former and not of so fine a flavour, therefore the first named is most esteemed for eating in a raw state; both, however, are used in the preparation of two kinds of preserve known as guava jelly and guava cheese, which are made in the West Indies and imported thence to England; the fruits are of much too perishable a nature to allow of their importation in their natural state. Both varieties have been introduced into various parts of India, as well as in other countries of the East, where they have become perfectly naturalized. Though of course much too tender for outdoor planting in England, the guava thrives there in hothouses or stoves.

Psidium variable (also known as *P. Cattleyanum*), a tree of from 10 to 20 ft. high, a native of Brazil (the Araçá or Araçá de Praya), is known as the purple guava. The fruit, which is very abundantly produced in the axils of the leaves, is large, spherical, of a fine deep claret colour; the rind is pitted, and the pulp is soft, fleshy, purplish, reddish next the skin, but becoming paler towards the middle and in the centre almost or quite white. It has a very agreeable acid-sweet flavour, which has been likened to that of a strawberry.

GUAYAMA, a small city and the capital of a municipal district and department of the same name, on the southern coast of Porto Rico, 53 m. S. of San Juan. Pop. (1899) of the

city, 5334; (1900) 5321; (1899) of the district, 12,749. The district (1565 sq. m.) includes Arroyo and Salinas. The city stands about 230 ft. above the sea and has a mild, healthy climate. It is connected with Ponce by railway (1910), and with the port of Arroyo by an excellent road, part of the military road extending to Cayey, and it exports sugar, rum, tobacco, coffee, cattle, fruit and other products of the department, which is very fertile. The city was founded in 1736, but was completely destroyed by fire in 1832. It was rebuilt on a rectangular plan and possesses several buildings of note. Drinking-water is brought in through an aqueduct.

GUAYAQUIL, or **SANTIAGO DE GUAYAQUIL**, a city and port of Ecuador, capital of the province of Guayas, on the right bank of the Guayas river, 33 m. above its entrance into the Gulf of Guayaquil, in 2° 12' S., 79° 51' W. Pop. (1890) 44,777; (1897, estimate) 51,000, mostly half-breeds. The city is built on a comparatively level *pajonal* or savanna, extending southward from the base of three low hills, called Los Cerros de la Cruz, between the river and the partially filled waters of the Estero Salado. It is about 30 ft. above sea-level, and the lower parts of the town are partially flooded in the rainy season. The old town is the upper or northern part, and is inhabited by the poorer classes, its streets being badly paved, crooked, undrained, dirty and pestilential. The great fire of 1896 destroyed a large part of the old town, and some of its insanitary conditions were improved in rebuilding. The new town, or southern part, is the business and residential quarter of the better classes, but the buildings are chiefly of wood and the streets are provided with surface drainage only. Among the public buildings are the governor's and bishop's palaces, town-hall, cathedral and 9 churches, national college, episcopal seminary and schools of law and medicine, theatre, two hospitals, custom-house, and several asylums and charitable institutions. Guayaquil is also the seat of a university corporation with faculties of law and medicine. A peculiarity of Guayaquil is that the upper floors in the business streets project over the walks, forming covered arcades. The year is divided into a wet and dry season, the former from January to June, when the hot days are followed by nights of drenching rain. The mean annual temperature is about 82° to 83° F.; malarial and bilious fevers are common, the latter being known as "Guayaquil fever," and epidemics of yellow fever are frequent. The dry or summer season is considered pleasant and healthy. The water-supply is now brought in through iron mains from the Cordilleras 53 m. distant. The mains pass under the Guayas river and discharge into a large distributing reservoir on one of the hills N. of the city. The city is provided with tramway and telephone services, the streets are lighted with gas and electricity, and telegraph communication with the outside world is maintained by means of the West Coast cable, which lands at the small port of Santa Elena, on the Pacific coast, about 65 m. W. of Guayaquil. Railway connexion with Quito (290 m.) was established in June 1908. There is also steamboat connexion with the producing districts of the province on the Guayas river and its tributaries, on which boats run regularly as far up as Bodegas (80 m.) in the dry season, and for a distance of 40 m. on the Dauke. For smaller boats there are about 200 m. of navigation on this system of rivers. The exports of the province are almost wholly transported on these rivers, and are shipped either at Guayaquil, or at Puna, its deep-water port, 6½ m. outside the Guayas bar, on the E. end of Puna Island. The Guayas river is navigable up to Guayaquil for steamers drawing 22 ft. of water; larger vessels anchor at Puna, 40 m. from Guayaquil, where cargoes and passengers are transferred to lighters and tenders. There is a quay on the river front, but the depth alongside does not exceed 18 ft. The principal exports are cacao, rubber, coffee, tobacco, hides, cotton, Panama hats, cinchona bark and ivory nuts, the value of all exports for the year 1905 being 14,148,877 *sucre*s, in a total of 18,565,668 *sucre*s for the whole republic. In 1908 the exports were: cacao, about 64,000,000 lb., valued at \$6,400,000; hides, valued at \$135,000; rubber, valued at \$235,000; coffee, valued at \$273,000; and vegetable ivory, valued at \$102,000.

There are some small industries in the city, including a shipyard, saw-mills, foundry, sugar refineries, cotton and woollen mills, brewery, and manufactures of soap, cigars, chocolate, ice, soda-water and liqueurs.

Santiago de Guayaquil was founded on St James's day, the 25th of July 1535, by Sebastian de Benalcazar, but was twice abandoned before its permanent settlement in 1537 by Francesco de Orellana. It was captured and sacked several times in the 17th and 18th centuries by pirates and freebooters—by Jacob Clark in 1624, by French pirates in 1686, by English freebooters under Edward David in 1687, by William Dampier in 1707 and by Clapperton in 1709. Defensive works were erected in 1730, and in 1763, when the town was made a governor's residence, a castle and other fortifications were constructed. Owing to the flimsy construction of its buildings Guayaquil has been repeatedly burned, the greater fires occurring in 1707, 1764, 1865, 1896 and 1899. The city was made the see of a bishopric in 1837.

GUAYAS, or **EL GUAYAS**, a coast province of Ecuador, bounded N. by Manabí and Pichincha, E. by Los Ríos, Cañar and Azuay, S. by El Oro and the Gulf of Guayaquil, and W. by the same gulf, the Pacific Ocean and the province of Manabí. Pop. (1893, estimate) 98,100; area, 11,504 sq. m. It is very irregular in form and comprises the low alluvial districts surrounding the Gulf of Guayaquil between the Western Cordilleras and the coast. It includes (since 1885) the Galápagos Islands, lying 600 m. off the coast. The province of Guayas is heavily forested and traversed by numerous rivers, for the most part tributaries of the Guayas river, which enters the gulf from the N. This river system has a drainage area of about 14,000 sq. m. and an aggregate of 200 m. of navigable channels in the rainy season. Its principal tributaries are the Daule and Babahoyo or Chimbo (also called Bodegas), and of the latter the Vinces and Yaguachi. The climate is hot, humid and unhealthy, bilious and malarial fevers being prevalent. The rainfall is abundant and the soil is deep and fertile. Agriculture and the collection of forest products are the chief industries. The staple products are cacao, coffee, sugar-cane, cotton, tobacco and rice. The cultivation of cacao is the principal industry, the exports forming about one-third the world's supply. Stock-raising is also carried on to a limited extent. Among forest products are rubber, cinchona bark, toquilla fibre and ivory nuts. The manufacture of so-called Panama hats from the fibre of the toquilla palm (commonly called *jipijapa*, after a town in Manabí famous for this industry) is a long-established domestic industry among the natives of this and other coast provinces, the humidity of the climate greatly facilitating the work of plaiting the delicate straws, which would be broken in a dry atmosphere. Guayas is the chief industrial and commercial province of the republic, about nineteen-twentieths of the commerce of Ecuador passing through the port of its capital, Guayaquil. There are no land transport routes in the province except the Quito & Guayaquil railway, which traverses its eastern half. The sluggish river channels which intersect the greater part of its territory afford excellent facilities for transporting produce, and a large number of small boats are regularly engaged in that traffic. There are no large towns in Guayas other than Guayaquil. Durán, on the Guayas river opposite Guayaquil, is the starting point of the Quito railway and contains the shops and offices of that line. The port of Santa Elena on a bay of the same name, about 65 m. W. of Guayaquil, is a landing-point of the West Coast cable, and a port of call for some of the regular steamship lines. Its exports are chiefly Panama hats and salt.

GUAYCURUS, a tribe of South American Indians on the Paraguay. The name has been used generally of all the mounted Indians of Gran Chaco. The Guaycurus are a wild, fierce people, who paint their bodies and go naked. They are fearless horsemen and are occupied chiefly in cattle rearing.

GUAYMAS, or **SAN JOSÉ DE GUAYMAS**, a seaport of Mexico, in the state of Sonora, on a small bay opening into the Gulf of California a few miles W. of the mouth of the Yaqui river, in lat. 27° 58' N., long. 110° 58' W. Pop. (1900) 8648. The harbour

is one of the best on the W. coast of Mexico, and the port is a principal outlet for the products of the large state of Sonora. The town stands on a small, arid plain, nearly shut in by mountains, and has a very hot, dry climate. It is connected with the railways of the United States by a branch of the Southern Pacific from Benson, Arizona, and is 230 m. S. by W. of the frontier town of Nogales, where that line enters Mexico. The exports include gold, silver, hides and pearls.

GUBBIO (anc. *Iguvium*, *q.v.*; med. *Engubium*), a town and episcopal see of Umbria, Italy, in the province of Perugia, from which it is 23 m. N.N.E. by road; by rail it is 13 m. N.W. of Fossato di Vico (on the line between Foligno and Ancona) and 70 m. E.S.E. of Arezzo. Pop. (1901) 5783 (town); 26,718 (commune). Gubbio is situated at the foot and on the steep slopes of Monte Cayo, from 1568 to 1735 ft. above sea-level, at the entrance to the gorge which ascends to Scheggia, probably on the site of the ancient Umbrian town. It presents a markedly medieval appearance. The most prominent building is the Palazzo dei Consoli, on the N. side of the Piazza della Signoria; it is a huge Gothic edifice with a tower, erected in 1332-1346, according to tradition, by Matteo di Giovannello of Gubbio; the name of Angelo da Orvieto occurs on the arch of the main door, but his work may be limited to the sculptures of this arch. It has two stories above the ground floor, and, being on the slope of the hill, is, like the whole piazza, raised on arched substructures. On the S. side of the piazza is the Palazzo Pretorio, or della Podestà, begun in 1349 and now the municipal palace. It contains the famous *Tabulae Iguvinae*, and a collection of paintings of the Umbrian school, of furniture and of majolica. On the E. side is the modern Palazzo Ranghiasi-Brancaleone, which until 1882 contained fine collections, now dispersed. Above the Piazza della Signoria, at the highest point of the town, is the Palazzo Ducale, erected by the dukes of Urbino in 1474-1480; the architect was, in all probability, Lucio da Laurana, to whom is due the palace at Urbino, which this palace resembles, especially in its fine colonnaded court. The Palazzo Beni, lower down, belongs to a somewhat earlier period of the 15th century. Pope Martin V. lodged here for a few days in 1420. The Palazzo Accoramboni, on the other hand, is a Renaissance structure, with a fine entrance arch. Here Vittoria Accoramboni was born in 1557. Opposite the Palazzo Ducale is the cathedral, dedicated to SS. Mariano e Jacopo, a structure of the 12th century, with a façade, adorned with contemporary sculptures, partly restored in 1514-1550. The interior contains some good pictures by Umbrian artists, a fine episcopal throne in carved wood, and a fine Flemish cope given by Pope Marcellus II. (1555) in the sacristy. The exterior of the Gothic church of S. Francesco, in the lower part of the town, built in 1259, preserves its original style, but the interior has been modernized; and the same fate has overtaken the Gothic churches of S. Maria Nuova and S. Pietro. S. Agostino, on the other hand, has its Gothic interior better preserved. The whole town is full of specimens of medieval architecture, the pointed arch of the 13th century being especially prevalent. A remarkable procession takes place in Gubbio on the 15th of May in each year, in honour of S. Ubaldo, when three colossal wooden pedestals, each over 30 ft. high, and crowned by statues of SS. Ubaldo, Antonio and Giorgio, are carried through the town, and then, in a wild race, up to the church of S. Ubaldo on the mountain-side (2690 ft.). See H. M. Bower, *The Elevation and Procession of the Ceri at Gubbio* (Folk-lore Society, London, 1897).

After its reconstruction with the help of Narzes (see *IGUVINA*) the town remained subject to the exarchs of Ravenna, and, after the destruction of the Lombard kingdom in 774, formed part of the donation of Charlemagne to the pope. In the 11th century the beginnings of its independence may be traced. In the struggles of that time it was generally on the Ghibelline side. In 1151 it repelled an attack of several neighbouring cities, and formed from this time a republic governed by consuls. In 1155 it was besieged by the emperor Frederick I., but saved by the intervention of its bishop, S. Ubaldo, and was granted privileges

by the emperor. In 1203 it had its first podestà, and from this period dates the rise of its importance. In 1387, after various political changes, it surrendered to Antonio da Montefeltro of Urbino, and remained under the dominion of the dukes of Urbino until, in 1623, the whole duchy was ceded to the pope.

Gubbio was the birthplace of Oderisio, a famous miniature painter (1240-1299), mentioned by Dante as the honour of his native town (*Purg.* xi. 80 "*L'onor d'Agobbio*"), but no authentic works by him exist. In the 14th and 15th centuries a branch of the Umbrian school of painting flourished here, the most famous masters of which were Guido Palmaerucci (1280-1345?) and several members of the Nelli family, particularly Ottaviano (d. 1444), whose best work is the "*Madonna del Belvedere*" in S. Maria Nuova at Gubbio (1404), extremely well preserved, with bright colouring and fine details. Another work by him is the group of frescoes including a large "*Last Judgment*," and scenes from the life of St. Augustine, in the church of S. Agostino, discovered in 1902 under a coating of whitewash. These painters seem to have been influenced by the contemporary masters of the Sieneese school.

Gubbio occupies a far more important place in the history of majolica. In a decree of 1438 a *vasarius vasorum fictorum* is mentioned, who probably was not the first of his trade. The art was brought to perfection by Giorgio Andreoli, whose father had emigrated hither from Pavia, and who in 1498 became a citizen of Gubbio. The works by his hand are remarkable for their ruby tint, with a beautiful metallic lustre; but only one small *tazza* remains in Gubbio itself. His art was carried on by his sons, Cencio and Ubaldo, but was afterwards lost, and only recovered in 1853 by Angelico Fabbri and Luigi Carocci.

Two miles outside Porta Metauro to the N.E. is the Bottaccone, a large water reservoir, constructed in the 17th or 18th century; the water is collected in the bed of a stream by a massive dam.

See A. Colasanti, *Gubbio* (Bergamo, 1905); L. McCracken, *Gubbio* (London, 1905).

GUBEN, a town of Germany, in the kingdom of Prussia, at the confluence of the Lubis with the Neisse, 28 m. S.S.E. of Frankfort-on-Oder, at the junction of railways to Breslau, Halle and Forst. Pop. (1875) 23,704; (1905) 36,666. It possesses three Evangelical churches, a Roman Catholic church, a synagogue, a gymnasium, a modern school, a museum and a theatre. The principal industries are the spinning and weaving of wool, dyeing, tanning, and the manufacture of pottery ware, hats, cloth, paper and machinery. The vine is cultivated in the neighbourhood to some extent, and there is also some trade in fruit and vegetables. Guben is of Wendish origin. It is mentioned in 1207 and received civic rights in 1235. It was surrounded by walls in 1311, about which time it came into the possession of the margrave of Brandenburg, from whom it passed to Bohemia in 1368. It was twice devastated by the Hussites, and in 1631 and 1642 it was occupied by the Swedes. By the peace of Prague in 1635 it came into the possession of the elector of Saxony, and in 1815 it was, with the rest of Lower Lusatia, united to Prussia.

GUBERNATIS, ANGELO DE, COUNT (1840-), Italian man of letters, was born at Turin and educated there and at Berlin, where he studied philology. In 1862 he was appointed professor of Sanskrit at Florence, but having married a cousin of the Socialist Bakunin and become interested in his views he resigned his appointment and spent some years in travel. He was reappointed, however, in 1867; and in 1891 he was transferred to the university of Rome. He became prominent both as an orientalist, a publicist and a poet. He founded the *Italia letteraria* (1862), the *Rivista orientale* (1867), the *Civita italiana* and *Rivista europea* (1869), the *Bollettino italiano degli studi orientali* (1876) and the *Revue internationale* (1883), and in 1887 became director of the *Giornale della società asiatica*. In 1878 he started the *Dizionario biografico degli scrittori contemporanei*. His Oriental and mythological works include the *Piccola enciclopedia indiana* (1867), the *Fons vedice* (1868), a famous work on zoological mythology (1872), and another on

plant mythology (1878). He also edited the encyclopaedia *Storia universale dalla letteratura* (1882-1885). His work in verse includes the dramas *Cato*, *Romolo*, *Il re Nalo*, *Don Rodrigo*, *Sesiri*, &c.

GUDBRANDESDAL, a district in the midlands of southern Norway, comprising the upper course of the river Lougen or Laagen from Lillehammer at the head of Lake Mjøsen to its source in Lake Lesjekogen and tributary valleys. Lillehammer, the centre of a rich timber district, is 114 m. N. of Christiania by rail. The railway continues through the well-wooded and cultivated valley to Otta (70 m.). Several tracks run westward into the wild district of the Jotunheim. From Otta good driving routes run across the watershed and descend the western slope, where the scenery is incomparably finer than in Gudbrandsdal itself—(a) past Sørum, with the 13th-century churches of Vaagen and Lom (a fine specimen of the Stavekirke or timber-built church), Aanstad and Polso, with beautiful falls of the Otta river, to Grollid, whence roads diverge to Stryn on the Nordfjord, and to Marok on the Geirangerfjord; (b) past Domaas (with branch road north to Støren near Trondhjem, skirting the Dovrefjeld), over the watershed formed by Lesjekogen Lake, which drains in both directions, and down through the magnificent Romsdal.

GUDE (**GODIUS**), **MARQUARD** (1635-1689), German archaeologist and classical scholar, was born at Rendsburg in Holstein on the 1st of February 1635. He was originally intended for the law, but from an early age showed a decided preference for classical studies. In 1658 he went to Holland in the hope of finding work as a teacher of classics, and in the following year, through the influence of J. F. Gronovius, he obtained the post of tutor and travelling companion to a wealthy young Dutchman, Samuel Schara. During his travels Gude seized the opportunity of copying inscriptions and MSS. At the earnest request of his pupil, who had become greatly attached to him, Gude refused more than one professional appointment, and it was not until 1671 that he accepted the post of librarian to Duke Christian Albert of Holstein-Gottorp. Schara, who had accompanied Gude, died in 1675, and left him the greater part of his property. In 1678 Gude, having quarrelled with the duke, retired into private life; but in 1682 he entered the service of Christian V. of Denmark as counsellor of the Schleswig-Holstein chancellery, and remained in it almost to the time of his death on the 26th of November 1689. Gude's great life-work, the collection of Greek and Latin inscriptions, was not published till 1731. Mention may also be made of his *editio princeps* (1667) of the treatise of Hippolytus the Martyr on Antichrist, and of his notes on Phaedrus (with four new fables discovered by him) published in P. Burmann's edition (1698).

His correspondence (ed. P. Burmann, 1697) is the most important authority for the events of Gude's life, besides containing valuable information on the learning of the times. See also J. Møller, *Cimbria literata*, iii., and C. Bursian in *Allgemeine deutsche Biographie*, x.

GUDENAN, ALFRED (1862-), American classical scholar, was born in Atlanta, Georgia, on the 26th of August 1862. He graduated at Columbia University in 1883 and studied under Hermann Diels at the University of Berlin. From 1890 to 1893 he was reader in classical philology at Johns Hopkins University, from 1893 to 1902 professor in the University of Pennsylvania, and from 1902 to 1904 professor in Cornell University. In 1904 he became a member of the corps of scholars preparing the *Wölfflin Thesaurus linguae Latinae*—a unique distinction for an American Latinist, as was the publication of his critical edition, with German commentary, of Tacitus' *Agricola* in 1902 by the Weidmannsche Buchhandlung of Berlin. He wrote *Latin Literature of the Empire* (2 vols., *Prose and Poetry*, 1898-1899), a *History of Classical Philology* (1902) and *Sources of Plutarch's Life of Cicero* (1902); and edited Tacitus' *Dialogus de oratoribus* (text with commentary, 1894 and 1898) and *Agricola* (1899; with German, 1900), and Sallust's *Catiline* (1903).

GUDGEON (*Gobio fluviatilis*), a small fish of the Cyprinid family. It is nearly related to the barbel, and has a small barbel or fleshy appendage at each corner of the mouth. It is the

gobione of Italy, *goujon* of France (whence adapted in M. English as *gojon*), and *Grüßling* or *Gründling* of Germany. Gudgeons thrive in streams and lakes, keeping to the bottom, and seldom exceeding 3 in. in length. In China and Japan there are varieties differing only slightly from the common European type.

GUDRUN (*Kudrun*), a Middle High German epic, written probably in the early years of the 13th century, not long after the *Nibelungenlied*, the influence of which may be traced upon it. It is preserved in a single MS. which was prepared at the command of Maximilian I., and was discovered as late as 1820 in the Castle of Ambras in Tirol. The author was an unnamed Austrian poet, but the story itself belongs to the cycle of sagas, which originated on the shores of the North Sea. The epic falls into three easily distinguishable parts—the adventures of King Hagen of Ireland, the romance of Hettel, king of the Hegelingen, who woos and wins Hagen's daughter Hilde, and lastly, the more or less parallel story of how Herwig, king of Seeland, wins, in opposition to her father's wishes, Gudrun, the daughter of Hettel and Hilde. Gudrun is carried off by a king of Normandy, and her kinsfolk, who are in pursuit, are defeated in a great battle on the island of Wülpensand off the Dutch coast. The finest parts of the epic are those in which Gudrun, a prisoner in the Norman castle, refuses to become the wife of her captor, and is condemned to do the most menial work of the household. Here, thirteen years later, Herwig and her brother Ortwin find her washing clothes by the sea; on the following day they attack the Norman castle with their army and carry out the long-delayed retribution.

The epic of *Gudrun* is not unworthy to stand beside the greater *Nibelungenlied*, and it has been aptly compared with it as the *Odyssey* to the *Iliad*. Like the *Odyssey*, Gudrun is an epic of the sea, a story of adventure; it does not turn solely round the conflict of human passions; nor is it built up round one all-absorbing, all-dominating idea like the *Nibelungenlied*. Scenery and incident are more varied, and the poet has an opportunity for a more lyric interpretation of motive and character. *Gudrun* is composed in stanzas similar to those of the *Nibelungenlied*, but with the essential difference that the last line of each stanza is identical with the others, and does not contain the extra accented syllable characteristic of the *Nibelungen* metre.

Gudrun was first edited by von der Hagen in vol. i. of his *Heldenbuch* (1820). Subsequent editions by A. Ziemann and A. J. Vollmer followed in 1837 and 1845. The best editions are those by K. Bartsch (4th ed., 1880), who has also edited the poem for Körner's *Deutsche Nationalliteratur* (vol. 6, 1885), by B. Symons (1883) and by E. Martin (2nd ed., 1901). L. Ettmüller first applied Lachmann's ballad-theory to the poem (1841), and K. Müllenhoff (*Kudrun, die echten Teile des Gedichts*, 1845) rejected more than three-quarters of the whole as "not genuine." There are many translations of the epic into modern German, the best known being that of K. Simrock (15th ed., 1884). A translation into English by M. P. Nichols appeared at Boston, U.S.A., in 1889.

See K. Bartsch, *Beiträge zur Geschichte und Kritik der Kudrun* (1865); H. Keck, *Die Gudrunsaage* (1867); W. Wilmanns, *Die Entwicklung der Kudrunsaage* (1873); A. Fécamp, *Le Poème de Gudrun, ses origines, sa formation et son histoire* (1892); F. Panzer, *Hilde-Gudrun* (1901). For later versions and adaptations of the saga see O. Benedict, *Die Gudrunsaage in der neueren Literatur* (1902).

GUBBRIANT, JEAN BAPTISTE BUDES, COMTE DE (1602-1643), marshal of France, was born at Plessis-Budes, near St Brieu, of an old Breton family. He served first in Holland, and in the Thirty Years' War he commanded from 1638 to 1639 the French contingent in the army of his friend Bernard of Saxe-Weimar, distinguishing himself particularly at the siege of Breisach in 1638. Upon the death of Bernard he received the command of his army, and tried, in conjunction with J. Baner (1596-1641), the Swedish general, a bold attack upon Regensburg (1640). His victories of Wolfenbüttel on the 29th of June 1641 and of Kempen in 1642 won for him the marshal's bâton. Having failed in an attempt to invade Bavaria in concert with Torstensson he seized Rottweil, but was mortally wounded there on the 17th of November 1643.

A biography was published by Le Laboureur, *Histoire du maréchal de Gubbriant*, in 1656. See A. Brinzinger in *Württembergische Vierteljahrsschrift für Landesgeschichte* (1902).

GUELDER ROSE, so called from Guelderland, its supposed source, termed also marsh elder, rose elder, water elder (Ger. *Wasserhelder*, *Schnaeball*; Fr. *viorne-obier*, *l'obier d'Europe*), known botanically as *Viburnum Opulus*, a shrub or small tree of the natural order Caprifoliaceae, a native of Britain, and widely distributed in the temperate and colder parts of Europe, Asia and North America. It is common in Ireland, but rare in Scotland. In height it is from 6 to 12 ft., and it thrives best in moist situations. The leaves are smooth, 2 to 3 in. broad, with 3 to 5 unequal serrate lobes, and glandular stipules adnate to the stalk. In autumn the leaves change their normal bright green for a pink or crimson hue. The flowers, which appear in June and July, are small, white, and arranged in cymes 2 to 4 in. in diameter. The outer blossoms in the wild plant have an enlarged corolla, $\frac{1}{2}$ in. in diameter, and are devoid of stamens or pistils; in the common cultivated variety all the flowers are sterile and the inflorescence is globular, hence the term "snow-ball tree" applied to the plant, the appearance of which at the time of flowering has been prettily described by Cowper in his *Winter Walk at Noon*. The guelder rose bears juicy, red, elliptical berries, $\frac{1}{2}$ in. long, which ripen in September, and contain each a single compressed seed. In northern Europe these are eaten, and in Siberia, after fermentation with flour, they are distilled for spirit. The plant has, however, emetic, purgative and narcotic properties; and Taylor (*Med. Jurisp.* i. 448, 2nd ed., 1873) has recorded an instance of the fatal poisoning of a child by the berries. Both they and the bark contain valerianic acid. The woody shoots of the guelder rose are manufactured into various small articles in Sweden and Russia. Another member of the genus, *Viburnum Lantana*, wayfaring tree, is found in dry copses and hedges in England, except in the north.

GUELPH, a city of Ontario, Canada, 45 m. W. of Toronto, on the river Speed and the Grand Trunk and Canadian Pacific railways. Pop. (1901) 11,496. It is the centre of a fine agricultural district, and exports grain, fruit and live-stock in large quantities. It contains, in addition to the county and municipal buildings, the Ontario Agricultural College, which draws students from all parts of North and South America. The river affords abundant water-power for flour-mills, saw-mills, woollen-mills and numerous factories, of which agricultural implements, sewing machines and musical instruments are the chief.

GUELPHS AND Ghibellines. These names are doubtless Italianized forms of the German words *Welf* and *Waiblingen*, although one tradition says that they are derived from Guelph and Gibel, two rival brothers of Pistoia. Another theory derives Ghibelline from Gibello, a word used by the Sicilian Arabs to translate Hohenstaufen. However, a more popular story tells how, during a fight around Weinsberg in December 1140 between the German king Conrad III. and Welf, count of Bavaria, a member of the powerful family to which Henry the Lion, duke of Saxony and Bavaria, belonged, the soldiers of the latter raised the cry "Hie Welf!" to which the king's troops replied with "Hie Waiblingen!" this being the name of one of Conrad's castles. But the rivalry between Welf and Hohenstaufen, of which family Conrad was a member, was anterior to this event, and had been for some years a prominent fact in the history of Swabia and Bavaria, although its introduction into Italy—in a slightly modified form, however—only dates from the time of the Italian expeditions of the emperor Frederick I. It is about this time that the German chronicler, Otto of Freising, says, "Duæ in Romano orbe apud Galliae Germaniae fines famosae familiae actenus fuerunt, una Heinricorum de Guelbelinga, alia Guelforum de Aldorfo, altera imperatores, altera magnos duces producere solita." Chosen German king in 1152, Frederick was not only the nephew and the heir of Conrad, he was related also to the Welfs; yet, although his election abated to some extent the rivalry between Welf and Hohenstaufen in Germany, it opened it upon a larger and fiercer scale in Italy.

During the long and interesting period covered by Frederick's Italian campaigns, his enemies, prominent among whom were the cities of the Lombard League, became known as Welfs, or Guelphs, while his partisans seized upon the rival term of

Waldingen, or Ghibelline, and the contest between these two parties was carried on with a ferocity unknown even to the inhabitants of southern Germany. The distracted state of northern Italy, the jealousies between various pairs of towns, the savage hatred between family and family, were some of the causes which fed this feud, and it reached its height during the momentous struggle between Frederick II. and the Papacy in the 13th century. The story of the contest between Guelph and Ghibelline, however, is little less than the history of Italy in the middle ages. At the opening of the 13th century it was intensified by the fight for the German and imperial thrones between Philip, duke of Swabia, a son of Frederick I., and the Welf, Otto of Brunswick, afterwards the emperor Otto IV., a fight waged in Italy as well as in Germany. Then, as the heir of Philip of Swabia and the rival of Otto of Brunswick, Frederick II. was forced to throw himself into the arms of the Ghibellines, while his enemies, the popes, ranged themselves definitely among the Guelphs, and soon Guelph and Ghibelline became synonymous with supporter of pope and emperor.

After the death of Frederick II. in 1250 the Ghibellines looked for leadership to his son and successor, the German king, Conrad IV., and then to his natural son, Manfred, while the Guelphs called the French prince, Charles of Anjou, to their aid. But the combatants were nearing exhaustion, and after the execution of Conradin, the last of the Hohenstaufen, in 1268, this great struggle began to lose force and interest. Guelph and Ghibelline were soon found representing local and family rather than papal and imperial interests; the names were taken with little or no regard for their original significance, and in the 15th century they began to die out of current politics. However, when Louis XII. of France conquered Milan at the beginning of the 16th century the old names were revived; the French king's supporters were called Guelphs and the friends of the emperor Maximilian I. were referred to as Ghibellines.

The feud of Guelph and Ghibelline penetrated within the walls of almost every city of northern Italy, and the contest between the parties, which practically makes the history of Florence during the 13th century, is especially noteworthy. First one side and then the other was driven into exile; the Guelph defeat at the battle of Monte Aperto in 1260 was followed by the expulsion of the Ghibellines by Charles of Anjou in 1266, and on a smaller scale a similar story may be told of many other cities (see FLORENCE).

The Guelph cause was buttressed by an idea, yet very nebulous, of Italian patriotism. Dislike of the German and the foreigner rather than any strong affection for the Papacy was the feeling which bound the Guelph to the pope, and so enabled the latter to defy the arms of Frederick II. The Ghibelline cause, on the other hand, was aided by the dislike of the temporal power of the pope and the desire for a strong central authority. This made Dante a Ghibelline, but the hopes of this party, kindled anew by the journey of Henry VII. to Italy in 1310, were extinguished by his departure. J. A. Symonds thus describes the constituents of the two parties: "The Guelph party meant the burghers of the consular Communes, the men of industry and commerce, the upholders of civil liberty, the friends of democratic expansion. The Ghibelline party included the naturalised nobles, the men of arms and idleness, the advocates of feudalism, the politicians who regarded constitutional progress with disfavour. That the banner of the church floated over the one camp, while the standard of the empire rallied to itself the hostile party, was a matter of comparatively superficial moment." In another passage the same writer thus describes the sharp and universal division between Guelph and Ghibelline: "Ghibellines wore the feathers in their caps upon one side, Guelphs upon the other. Ghibellines cut fruit at table crosswise, Guelphs straight down. . . Ghibellines drank out of smooth and Guelphs out of chased goblets. Ghibellines wore white and Guelphs red roses." It is interesting to note that while Dante was a Ghibelline, Petrarch was a Guelph.

See J. A. Symonds, *The Renaissance in Italy*, vol. i. (1875).

GUENEVERE (Lat. *Guanhumara*; Welsh, *Gwenhwyfar*; O. Eng. *Geymore*), in Arthurian romance, the wife of King Arthur. Geoffrey of Monmouth, who calls her Guanhumara, makes her a Roman lady, but the general tradition is that she was of Cornish birth and daughter to King Leodegrance. Wace, who, while translating Geoffrey, evidently knew, and used, popular tradition, combines these two, asserting that she was of Roman parentage on the mother's side, but cousin to Cadoc of Cornwall by whom she was brought up. The tradition relating to Guenevere is decidedly confused and demands further study. The Welsh triads know no fewer than three Gwenhwyfars; Giraldus Cambrensis, relating the discovery of the royal tombs at Glastonbury, speaks of the body found as that of Arthur's second wife; the prose *Martin* gives Guenevere a bastard half-sister of the same name, who strongly resembles her; and the *Lancelot* relates how this lady, trading on the likeness, persuaded Arthur that she was the true daughter of Leodegrance, and the queen the bastard interloper. This episode of the false Guenevere is very perplexing.

To the majority of English readers Guenevere is best known in connexion with her liaison with Lancelot, a story which, in the hands of Malory and Tennyson, has assumed a form widely different from the original conception, and at once more picturesque and more convincing. In the French romances Lancelot is a late addition to the Arthurian cycle, his birth is not recorded till long after the marriage of Arthur and Guenevere, and he is at least twenty years the junior of the queen. The relations between them are of the most conventional and courtly character, and are entirely lacking in the genuine dramatic passion which marks the love story of Tristan and Isolt. The *Lancelot-Guenevere* romance took form and shape in the artificial atmosphere encouraged by such patronesses of literature as Eleanor of Aquitaine and her daughter Marie, Comtesse de Champagne (for whom Chrétien de Troyes wrote his *Chevalier de la Charrette*), and reflects the low social morality of a time when love between husband and wife was declared impossible. But though Guenevere has changed her lover, the tradition of her infidelity is of much earlier date and formed a part of the primitive Arthurian legend. Who the original lover was is doubtful; the *Vite Gildas* relates how she was carried off by Melwas, king of Aestiva Regis, to Glastonbury, whither Arthur, at the head of an army, pursued the ravisber. A fragment of a Welsh poem seems to confirm this tradition, which certainly lies at the root of her later abduction by Meleagaunt. In the *Lancelot* of Ulrich von Zatzikhoven the abductor is Falerin. The story in these forms represents an other-world abduction. A curious fragment of Welsh dialogue, printed by Professor Rhys in his *Studies on the Arthurian Legend*, appears to represent Kay as the abductor, in the pseudo-Chronicles and the romances based upon them the abductor is Mordred, and in the chronicles there is no doubt that the lady was no unwilling victim. On the final defeat of Mordred she retires to a nunnery, takes the veil, and is no more heard of. Wace says emphatically—

*Ne fu ois ne véue,
Ne fu trovée, ne sée
Por la vergogne del masfaiz
Et del peccé qu' ele avoit fait* (ll. 13627-30).

Layamon, who in his translation of Wace treats his original much as Wace treated Geoffrey, says that there was a tradition that she had drowned herself, and that her memory and that of Mordred were hateful in every land, so that none would offer prayer for their souls. On the other hand certain romances, e.g. the *Perceval*, give her an excellent character. The truth is probably that the tradition of his wife's adultery and treachery was a genuine part of the Arthurian story, which, neglected for a time, was brought again into prominence by the social conditions of the courts for which the later romances were composed; and it is in this later and conventionalized form that the tale has become familiar to us (see also LANCELOT).

See *Studies on the Arthurian Legend* by Professor Rhys; *The Legend of Sir Lancelot*, Grimm Library, xii., Jessie L. Weston; *Der Karrenritter*, ed. Professor Foerster. (J. L. W.)

GUENON (from the French, =one who grimaces, hence an ape), the name applied by naturalists to the monkeys of the African genus *Cercopithecus*, the Ethiopian representative of the Asiatic macaques, from which they differ by the absence of a posterior heel to the last molar in the lower jaw.

GUÉRET, a town of central France, capital of the department of Creuse, situated on a mountain declivity 48 m. N.E. of Limoges on the Orleans railway. Pop. (1906), town, 6042; commune (including troops, &c.), 8058. Apart from the Hôtel des Monneyroux (used as prefecture), a picturesque mansion of the 15th and 16th centuries, with mansard roofs and mullioned windows, Guéret has little architectural interest. It is the seat of a prefect and a court of assizes, and has a tribunal of first instance, a chamber of commerce and lycées and training colleges, for both sexes. The industries include brewing, saw-milling, leather-making and the manufacture of basket-work and wooden shoes, and there is trade in agricultural produce and cattle. Guéret grew up round an abbey founded in the 7th century, and in later times became the capital of the district of Marche.

GUEREZA, the native name of a long-tailed, black and white Abyssinian monkey, *Colobus guereza* (or *C. abyssinicus*), characterized by the white hairs forming a long pendent mantle. Other east African monkeys with a similar type of colouring, which, together with the wholly black west African *C. satanas*, collectively constitute the subgenus *Guereza*, may be included under the same title; and the name may be further extended to embrace all the African thumbless monkeys of the genus *Colobus*. These monkeys are the African representatives of the Indo-Malay langurs (*Semnopithecus*), with which they agree in their slender build, long limbs and tail, and complex stomachs, although differing by the rudimentary thumb. The members of the subgenus *Guereza* present a transition from a wholly black animal (*C. satanas*) to one (*C. candidus*) in which the sides of the face are white, and the whole flanks, as well as the tail, clothed with a long fringe of pure white hairs.

GUERICKE, HEINRICH ERNST FERDINAND (1803-1878), German theologian, was born at Wettin in Saxony on the 25th of February 1803 and studied theology at Halle, where he was appointed professor in 1829. He greatly disliked the union between the Lutheran and the Reformed churches, which had been accomplished by the Prussian government in 1817, and in 1833 he definitely threw in his lot with the Old Lutherans. In 1835 he lost his professorship, but he regained it in 1840. Among his works were a *Life of August Hermann Francke* (1827, Eng. trans. 1837), *Church History* (1833, Eng. trans. by W. T. Shedd, New York, 1857-1863), *Allgemeine christliche Symbolik* (1839). In 1840 he helped to found the *Zeitschrift für die gesammte lutherische Theologie und Kirche*, and he died at Halle on the 4th of February 1878.

GUERICKE, OTTO VON (1602-1686), German experimental philosopher, was born at Magdeburg, in Prussian Saxony, on the 20th of November 1602. Having studied law at Leipzig, Helmstadt and Jena, and mathematics, especially geometry and mechanics, at Leiden, he visited France and England, and in 1636 became engineer-in-chief at Erfurt. In 1627 he was elected alderman of Magdeburg, and in 1646 mayor of that city and a magistrate of Brandenburg. His leisure was devoted to scientific pursuits, especially in pneumatics. Incited by the discoveries of Galileo, Pascal and Torricelli, he attempted the creation of a vacuum. He began by experimenting with a pump on water placed in a barrel, but found that when the water was drawn off the air permeated the wood. He then took a globe of copper fitted with pump and stopcock, and discovered that he could pump out air as well as water. Thus he became the inventor of the air-pump (1650). He illustrated his discovery before the emperor Ferdinand III. at the imperial diet which assembled at Regensburg in 1654, by the experiment of the "Magdeburg hemispheres." Taking two hollow hemispheres of copper, the edges of which fitted nicely together, he exhausted the air from between them by means of his pump, and it is recorded that thirty horses, fifteen back to back, were unable

to pull them asunder until the air was readmitted. Besides investigating other phenomena connected with a vacuum, he constructed an electrical machine which depended on the excitation of a rotating ball of sulphur; and he made successful researches in astronomy, predicting the periodicity of the return of comets. In 1681 he gave up office, and retired to Hamburg, where he died on the 11th of May 1686.

His principal observations are given in his work, *Experimenta nova, ut vocant, Magdeburgica de vacuo spatio* (Amsterdam, 1672). He is also the author of a *Geschichte der Belagerung und Eroberung von Magdeburg*. See F. W. Hoffmann, *Otto von Guericke* (Magdeburg, 1874).

GUÉRIDON, a small table to hold a lamp or vase, supported by a tall column or a human or mythological figure. This piece of furniture, often very graceful and elegant, originated in France towards the middle of the 17th century. In the beginning the table was supported by a negro or other exotic figure, and there is some reason to believe that it took its name from the generic appellation of the young African groom or "tiger," who was generally called "Guéridon" or as we should say in English "Sambo." The swarthy figure and brilliant costume of the "Moor" when reproduced in wood and picked out in colours produced a very striking effect, and when a small table was supported on the head by the upraised hands the idea of passive service was suggested with completeness. The guéridon is still occasionally seen in something approaching its original form; but it had no sooner been introduced than the artistic instinct of the French designer and artificer converted it into a far worthier object. By the death of Louis XIV. there were several hundreds of them at Versailles, and within a generation or two they had taken an infinity of forms—columns, tripods, terminal and mythological figures. Some of the simpler and more artistic forms were of wood carved with familiar decorative motives and gilded. Silver, enamel, and indeed almost any material from which furniture can be made, have been used for their construction. A variety of small "occasional" tables are now called in French *guéridons*.

GUÉRIN, JEAN BAPTISTE PAULIN (1785-1855), French painter, was born at Toulon, on the 25th of March 1783, of poor parents. He learnt, as a lad, his father's trade of a locksmith, whilst at the same time he followed the classes of the free school of art. Having sold some copies to a local amateur, Guérin started for Paris, where he came under the notice of Vincent, whose counsels were of material service. In 1810 Guérin made his first appearance at the Salon with some portraits, which had a certain success. In 1812 he exhibited "Cain after the murder of Abel" (formerly in Luxembourg), and, on the return of the Bourbons, was much employed in works of restoration and decoration at Versailles. His "Dead Christ" (Cathedral, Baltimore) obtained a medal in 1817, and this success was followed up by a long series of works, of which the following are the more noteworthy: "Christ on the knees of the Virgin" (1819); "Anchises and Venus" (1822) (formerly in Luxembourg); "Ulysses and Minerva" (1824) (Musée de Reanes); "the Holy Family" (1829) (Cathedral, Toulon); and "Saint Catherine" (1838) (St Roch). In his treatment of subject, Guérin attempted to realize rococo graces of conception, the liveliness of which was lost in the strenuous effort to be correct. His chief successes were attained by portraits, and those of Charles Nodier and the Abbé Lamennais became widely popular. He died on the 10th of January 1855.

GUÉRIN, PIERRE MARCISSÉ, BARON (1774-1833), French painter, was born at Paris on the 23th of May 1774. Becoming a pupil of Jean Baptiste Regnault, he carried off one of the three "grands prix" offered in 1796, in consequence of the competition not having taken place since 1793. The pension was not indeed re-established, but Guérin fulfilled at Paris the conditions imposed upon a *pensionnaire*, and produced various works, one of which brought him prominently before the public. This work, "Marcus Sextus" (Louvre), exhibited at the Salon of 1799, excited wild enthusiasm, partly due to the subject,—a victim of Sulla's proscription returning to Rome to find his wife dead and his house in mourning—in which an allusion was found to the actual

situation of the *émigrés*. Guérin on this occasion was publicly crowned by the president of the Institute, and before his departure for Rome (on the re-establishment of the École under Survé) a banquet was given to him by the most distinguished artists of Paris. In 1800, unable to remain in Rome on account of his health, he went to Naples, where he painted the "Grave of Amyntas." In 1802 Guérin produced "Phædra and Hippolytus" (Louvre); in 1810, after his return to Paris, he again achieved a great success with "Andromache and Pyrrhus" (Louvre); and in the same year also exhibited "Cephalus and Aurora" (Collection Sommariva) and "Bonaparte and the Rebels of Cairo" (Versailles). The Restoration brought to Guérin fresh honours; he had received from the first consul in 1803 the cross of the Legion of Honour, and in 1815 Louis XVIII. named him Academician. The success of Guérin's "Hippolytus" of "Andromache," of "Phædra" and of "Clytemnestra" (Louvre) had been ensured by the skillful selection of highly melodramatic situations, treated with the strained and pompous dignity proper to the art of the first empire; in "Aeneas relating to Dido the disasters of Troy" (Louvre), which appeared side by side with "Clytemnestra" at the Salon of 1817, the influence of the Restoration is plainly to be traced. In this work Guérin sought to captivate the public by an appeal to those sensuous charms which he had previously rejected, and by the introduction of picturesque elements of interest. But with this work Guérin's public successes came to a close. He was, indeed, commissioned to paint for the Madeleine a scene from the history of St Louis, but his health prevented him from accomplishing what he had begun, and in 1822 he accepted the post of director of the École de Rome, which in 1816 he had refused. On returning to Paris in 1828, Guérin, who had previously been made chevalier of the order of St Michel, was ennobled. He now attempted to complete "Pyrrhus and Priam," a work which he had begun at Rome, but in vain; his health had finally broken down, and in the hope of improvement he returned to Italy with Horace Vernet. Shortly after his arrival at Rome Baron Guérin died, on the 6th of July 1833, and was buried in the church of La Trinità de' Monti by the side of Claude Lorraine.

A careful analysis and criticism of his principal works will be found in Meyer's *Geschichte der französischen Malerei*.

GUÉRIN DU CAYLA, GEORGES MAURICE DE (1810-1839), French poet, descended from a noble but poor family, was born at the château de Le Cayla in Languedoc, on the 4th of August 1810. He was educated for the church at a religious seminary at Toulouse, and then at the Collège Stanislas, Paris, after which he entered the society at La Chesnaye in Brittany, founded by Lamennais. It was only after great hesitation, and without being satisfied as to his religious vocation, that under the influence of Lamennais he joined the new religious order in the autumn of 1832; and when, in September of the next year, Lamennais, who had come under the displeasure of Rome, severed connexion with the society, Maurice de Guérin soon followed his example. Early in the following year he went to Paris, where he was for a short time a teacher at the Collège Stanislas. In November 1838 he married a Creole lady of some fortune; but a few months afterwards he was attacked by consumption and died on the 10th of July 1839. In the *Revue des deux mondes* for May 15th, 1840, there appeared a notice of Maurice de Guérin by George Sand, to which she added two fragments of his writings—one a composition in prose entitled the *Centaur*, and the other a short poem. His *Reliquiæ* (2 vols.; 1861), including the *Centaur*, his journal, a number of his letters and several poems, was edited by G. S. Trébutien, and accompanied with a biographical and critical notice by Sainte-Beuve; a new edition, with the title *Journal, lettres et poèmes*, followed in 1862; and an English translation of it was published at New York in 1867. Though he was essentially a poet, his prose is more striking and original than his poetry. Its peculiar and unique charm arises from his strong and absorbing passion for nature, a passion whose intensity reached almost to adoration and worship, but in which the pagan was more prominent than the moral element. According to Sainte-Beuve, "no French

poet or painter has rendered so well the feeling for nature—the feeling not so much for details as for the ensemble and the divine universality, the feeling for the origin of things and the sovereign principle of life."

The name of **EUGÉNIE DE GUÉRIN** (1805-1848), the sister of Maurice, cannot be omitted from any notice of him. Her *Journals* (1861, Eng. trans., 1865) and her *Lettres* (1864, Eng. trans., 1865) indicated the possession of gifts of as rare an order as those of her brother, though of a somewhat different kind. In her case mysticism assumed a form more strictly religious, and she continued to mourn her brother's loss of his early Catholic faith. Five years older than he, she cherished a love for him which was blended with a somewhat motherly anxiety. After his death she began the collection and publication of the scattered fragments of his writings. She died, however, on the 31st of May 1848, before her task was completed.

See the notices by George Sand and Sainte-Beuve referred to above; Sainte-Beuve, *Causeries du lundi* (vol. xii.) and *Notions sur Lamais* (vol. iii.); G. Merlet, *Causeries sur les femmes et les livres* (Paris, 1865); Selden, *L'Esprit des femmes de notre temps* (Paris, 1864); Marelle, *Eugénie et Maurice de Guérin* (Berlin, 1869); Harriet Parr, *M. and E. de Guérin, a monograph* (London, 1870); and Matthew Arnold's essays on Maurice and Eugénie de Guérin, in his *Essays in Criticism*.

GUERNIERI, or **WERNER**, a celebrated mercenary captain who lived about the middle of the 14th century. He was a member of the family of the dukes of Urslingen, and probably a descendant of the dukes of Spoleto. From 1340 to 1343 he was in the service of the citizens of Pisa, but afterwards he collected a troop of adventurers which he called the Great Company, and with which he plundered Tuscany and Lombardy. He then entered the service of Louis I. the Great, king of Hungary and Poland, whom he assisted to obtain possession of Naples; but when dismissed from this service his ravages became more terrible than ever, culminating in the dreadful sack of Anagni in 1358, shortly after which Guernieri disappeared from history. He is said to have worn a breastplate with the inscription, "The enemy of God, of pity and of mercy."

GUERNSEY (Fr. *Guernesey*), one of the Channel Islands, belonging to Britain, the second in size and westernmost of the important members of the group. Its chief town, St Peter Port, on the east coast, is in 2° 33' W., 49° 27' N., 74 m. S. of Portland Bill on the English coast, and 30 m. from the nearest French coast to the east. The island, roughly triangular in form, is 9½ m. long from N.E. to S.W. and has an extreme breadth of 5½ m. and an area of 15,691 acres or 24.5 sq. m. Pop. (1901), 40,446, the density being thus 162 per sq. m.

The surface of the island rises gradually from north to south, and reaches its greatest elevation at Haut Nez (349 ft.) above Point Icart on the south coast. The coast scenery, which forms one of the principal attractions to the numerous summer visitors to the island, is finest on the south. This coast, between Jerbourg and Pleinmont Points, respectively at the south-eastern and south-western corners of the island, is bold, rocky and indented with many exquisite little bays. Of these the most notable are Moulin Huet, Saint's, and Petit Bot, all in the eastern half of the south coast. The cliffs, however, culminate in the neighbourhood of Pleinmont. Picturesque caves occur at several points, such as the Creux Mahie. On the west coast there is a succession of larger bays—Rocquaine Perelle, Vazon, and Cobo. Off the first lies Lihou Island, the Hanois and other islets, and all three bays are sown with rocks. The coast, however, diminishes in height, until at the north-eastern extremity of the island the land is so low across the Vale or Braye du Val, from shore to shore, that the projection of L'Ancrese is within a few feet of being isolated. The east coast, on which, besides the town and harbour of St Peter Port, is that of St Sampson, presents no physical feature of note. The interior of the island is generally undulating, and gains in beauty from its rich vegetation. Picturesque glens descend upon some of the southern bays (the two converging upon Petit Bot are notable), and the high-banked paths, arched with foliage, which follow the small

rills down to Moulin Huet Bay, are much admired under the name of water-lanes.

The soil is generally light sandy loam, overlying an angular gravel which rests upon the weathered granite. This soil requires much manure, and a large proportion of the total area (about three-fifths) is under careful cultivation, producing a considerable amount of grain, but more famous for market-gardening. Vegetables and potatoes are exported, with much fruit, including grapes and flowers. Granite is quarried and exported from St Sampson, and the fisheries form an important industry.

For administrative purposes Guernsey is united with Alderney, Sark, Herm and the adjacent islets to form the bailiwick of Guernsey, separate from Jersey. The peculiar constitution, machinery of administration and justice, finance, &c., are considered under the heading CHANNEL ISLANDS. Guernsey is divided into the ten parishes of St Peter Port, St Sampson, Vale, Côtel, St Saviour, St Andrew, St Martin, Forest, St Peter du Bois and Torveval. The population of St Peter Port in 1901 was 18,264; of the other parishes that of St Sampson was 5614 and that of Vale 5082. The population of the bailiwick of Guernsey nearly doubled between 1821 and 1901, and that of the island increased from 35,243 in 1891 to 40,446 in 1901. The island roads are excellent, Guernsey owing much in this respect to Sir John Doyle (d. 1834), the governor whose monument stands on the promontory of Jerbourg. Like Jersey and the neighbouring part of France, Guernsey retains considerable traces of early habitation in cromlechs and menhirs, of which the most notable is the cromlech in the north at L'Anresse. As regards ecclesiastical architecture, all the parish churches retain some archaeological interest. There is good Norman work in the church of St Michael, Vale, and the church of St Peter Port is a notable building of various periods from the early 14th century. Small remains of monastic buildings are seen at Vale and on Lihou Island.

GUERRAZZI, FRANCESCO DOMENICO (1804-1873), Italian publicist, born at Leghorn, was educated for the law at Pisa, and began to practise in his native place. But he soon took to politics and literature, under the influence of Byron, and his novel, the *Ballagi di Benvenuto* (1827), brought him into notice. Mazzini made his acquaintance, and with Carlo Bini they started a paper, the *Indicatore*, at Leghorn in 1829, which was quickly suppressed. Guerrazzi himself had to endure several terms of imprisonment for his activity in the cause of Young Italy, and it was in Portoferrato in 1834 that he wrote his most famous novel *Assidio di Firenze*. He was the most powerful Liberal leader at Leghorn, and in 1848 became a minister, with some idea of exercising a moderating influence in the difficulties with the grand-duke of Tuscany. In 1849, when the latter fled, he was first one of the triumvirate with Mazzini and Montanelli, and then dictator, but on the restoration he was arrested and imprisoned for three years. His *Apologia* was published in 1852. Released from prison, he was exiled to Corsica, but subsequently was restored and was for some time a deputy at Turin (1862-1870), dying of apoplexy at Leghorn on the 25th of September 1873. He wrote a number of other works besides the novels already mentioned, notably *Isabella Orsini* (1845) and *Beatrice Cenci* (1854), and his *Opere* were collected at Milan (1868).

See the *Life and Works* by Bosio (1877), and Carducci's edition of his letters (1880).

GUERRERO, a Pacific coast state of Mexico, bounded N.W. by Michoacan, N. by Mexico (state) and Morelos, N.E. and E. by Puebla and Oaxaca, and S. and W. by the Pacific. Area, 24,996 sq. m. Pop., largely composed of Indians and mestizos (1895), 417,886; (1900) 479,205. The state is roughly broken by the Sierra Madre and its spurs, which cover its entire surface with the exception of the low coastal plain (averaging about 20 m. in width) on the Pacific. The valleys are usually narrow, fertile and heavily forested, but difficult of access. The state is divided into two distinct zones—the *tierras calientes* of the coast and lower river courses where tropical conditions prevail,

and the *tierras templadas* of the mountain region where the conditions are subtropical. The latter is celebrated for its agreeable and healthy climate, and for the variety and character of its products. The principal river of the state is the Rio de las Balsas or Mescala, which, having its source in Tlaxcala, flows entirely across the state from W. to E., and then southward to the Pacific on the frontier of Michoacan. This river is 429 m. long and receives many affluents from the mountainous region through which it passes, but its course is very precipitous and its mouth obstructed by sand bars. The agricultural products include cotton, coffee, tobacco and cereals, and the forests produce rubber, vanilla and various textile fibres. Mining is undeveloped, although the mineral resources of the state include silver, gold, mercury, lead, iron, coal, sulphur and precious stones. The capital, Chilpancingo, or Chilpancingo de los Bravos (pop. 7497 in 1900), is a small town in the Sierra Madre about 110 m. from the coast and 200 m. S. of the Federal capital. It is a healthy well-built town on the old Acapulco road, is lighted by electricity and is temporarily the western terminus of the Inter-oceanic railway from Vera Cruz. It is celebrated in the history of Mexico as the meeting-place of the revolutionary congress of 1813, which issued a declaration of independence. Chilpancingo was badly damaged by an earthquake in January 1902, and again on the 16th of April 1907. Other important towns of the state are Tixtla, or Tixtla de Guerrero, formerly the capital (pop. 6316 in 1900), 3 m. N.E. of Chilpancingo; Chilapa (8456 in 1895), the most populous town of the state, partially destroyed by a hurricane in 1889, and again by the earthquake of 1907; Iguala (6631 in 1895); and Acapulco. Guerrero was organized as a state in 1849, its territory being taken from the states of Mexico, Michoacan and Puebla.

GUERRILLA (erroneously written "guerilla," being the diminutive of the Span. *guerra*, war), a term currently used to denote war carried on by bands in any irregular and unorganized manner. At the Hague Conference of 1899 the position of irregular combatants was one of the subjects dealt with, and the rules there adopted were reaffirmed at the Conference of 1907. They provide that irregular bands in order to enjoy recognition as belligerent forces shall (a) have at their head a person responsible for his subordinates, (b) wear some fixed distinctive badge recognisable at a distance, (c) carry arms openly, and (d) conform in their operations to the laws and customs of war. The rules, however, also provide that in case of invasion the inhabitants of a territory who on the approach of the invading enemy spontaneously take up arms to resist it, shall be regarded as belligerent troops if they carry arms openly and respect the laws and customs of war, although they may not have had time to become organized in accordance with the above provisions. These rules were borrowed almost word for word from the project drawn up at the Brussels international conference of 1874, which, though never ratified, was practically incorporated in the army regulations issued by the Russian government in connexion with the war of 1877-78. (T. BA.)

GUERRINI, OLINDO (1845-), Italian poet, was born at Sant' Alberto, Ravenna, and after studying law took to a life of letters, becoming eventually librarian at Bologna University. In 1877 he published *Postuma*, a volume of *canzoniere*, under the name of Lorenzo Stechetti, following this with *Polemica* (1878), *Canti popolari romagnoli* (1880) and other poetical works, and becoming known as the leader of the "verist" school among Italian lyrical writers.

GUESDE, JULES BASILE (1845-), French socialist, was born in Paris on the 11th of November 1845. He had begun his career as a clerk in the French Home Office, but at the outbreak of the Franco-German War he was editing *Les Droits de l'Homme* at Montpellier, and had to take refuge at Geneva in 1871 from a prosecution instituted on account of articles which had appeared in his paper in defence of the Commune. In 1876 he returned to France to become one of the chief French apostles of Marxian collectivism, and was imprisoned for six months in 1878 for taking part in the first Parisian International Congress. He edited at different times

Les Droits de l'homme, Le Cri du peuple, Le Socialiste, but his best-known organ was the weekly *Egalité*. He had been in close association with Paul Lafargue, and through him with Karl Marx, whose daughter he married. It was in conjunction with Marx and Lafargue that he drew up the programme accepted by the national congress of the Labour party at Havre in 1880, which laid stress on the formation of an international labour party working by revolutionary methods. Next year at the Reims congress the orthodox Marxian programme of Guesde was opposed by the "possibilists," who rejected the intransigent attitude of Guesde for the opportunist policy of Benoît Malon. At the congress of St-Étienne the difference developed into separation, those who refused all compromise with a capitalist government following Guesde, while the opportunists formed several groups. Guesde took his full share in the consequent discussion between the Guesdists, the Blanquists, the possibilists, &c. In 1893 he was returned to the Chamber of Deputies for Lille (7th circonscription) with a large majority over the Christian Socialist and Radical candidates. He brought forward various proposals in social legislation forming the programme of the Labour party, without reference to the divisions among the Socialists, and on the 20th of November 1894 succeeded in raising a two days' discussion of the collectivist principle in the Chamber. In 1902 he was not re-elected, but resumed his seat in 1906. In 1903 there was a formal reconciliation at the Reims congress of the sections of the party, which then took the name of the Socialist party of France. Guesde, nevertheless, continued to oppose the opportunist policy of Jaurès, whom he denounced for supporting one bourgeois party against another. His defence of the principle of freedom of association led him, incongruously enough, to support the religious Congregations against Émile Combes. Besides his numerous political and socialist pamphlets he published in 1901 two volumes of his speeches in the Chamber of Deputies entitled *Quatre ans de lutte de classe 1893-1898*.

GUEST, EDWIN (1800-1880), English antiquary, was born in 1800. He was educated at King Edward's school, Birmingham, and at Caius College, Cambridge, where he graduated as eleventh wrangler, subsequently becoming a fellow of his college. Called to the bar in 1828, he devoted himself, after some years of legal practice, to antiquarian and literary research. In 1838 he published his exhaustive *History of English Rhythms*. He also wrote a very large number of papers on Roman-British history, which, together with a mass of fresh material for a history of early Britain, were published posthumously under the editorship of Dr Stubbs under the title *English Cellicae* (1883). In 1852 Guest was elected master of Caius College, becoming LL.D. in the following year, and in 1854-1855 he was vice-chancellor of Cambridge University. Guest was a fellow of the Royal Society, and an honorary member of the Society of Antiquaries. He died on the 23rd of November 1880.

GUEST (a word common to Teutonic languages; cf. Ger. *Gast*, and Swed. *gäst*; cognate with Lat. *hospit*, originally a stranger, hence enemy; cf. "host"), one who receives hospitality in the house of another, his "host"; hence applied to a parasite.

GUESTARD, JEAN ÉTIENNE (1715-1786), French naturalist and mineralogist, was born at Étampes, on the 22nd of September 1715. In boyhood he gained a knowledge of plants from his grandfather, who was an apothecary, and later he qualified as a doctor in medicine. Pursuing the study of botany in various parts of France and other countries, he began to take notice of the relation between the distribution of plants and the soils and subsoils. In this way his attention came to be directed to minerals and rocks. In 1746 he communicated to the Academy of Sciences in Paris a memoir on the distribution of minerals and rocks, and this was accompanied by a map on which he had recorded his observations. He thus, as remarked by W. D. Conybeare, "first carried into execution the idea, proposed by [Martin] Lister years before, of geological maps." In the course of his journeys he made a large collection of fossils and figured many of them, but he had no clear ideas about the sequence of strata. He made observations also on the degradation of

mountains by rain, rivers and sea; and he was the first to ascertain the existence of former volcanoes in the district of Auvergne. He died in Paris on the 7th of January 1786.

His publications include: *Observations sur les plantes* (2 vols., 1747); *Histoire de la découverte faite en France de matières semblables à celles dont la porcelaine de la Chine est composée* (1765); *Mémoires sur différentes parties des sciences et arts* (5 vols., 1768-1783); *Mémoire sur la minéralogie du Dauphiné* (2 vols., 1779). See *The Founders of Geology*, by Sir A. Geikie (1897).

GUEUX, LES, or "THE BEGGARS," a name assumed by the confederacy of nobles and other malcontents, who in 1566 opposed Spanish tyranny in the Netherlands. The leaders of the nobles, who signed a solemn league known as "the Compromise," by which they bound themselves to assist in defending the rights and liberties of the Netherlands against the civil and religious despotism of Philip II., were Louis, count of Nassau, and Henry, count of Brederode. On the 5th of April 1566 permission was obtained for the confederates to present a petition of grievances, called "the Request," to the regent, Margaret, duchess of Parma. About 250 nobles marched to the palace accompanied by Louis of Nassau and Brederode. The regent was at first alarmed at the appearance of so large a body, but one of her councillors, Berlaymont by name, was heard to exclaim, "What, madam, is your highness afraid of these beggars (*ces gueux*)?" The appellation was not forgotten. At a great feast held by some 300 confederates at the Hôtel Culemburg three days later, Brederode in a speech declared that if need be they were all ready to become "beggars" in their country's cause. The words caught on, and the hall resounded with loud cries of "*Vivent les gueux!*" The name became henceforward a party appellation. The patriot party adopted the emblems of beggarhood, the wallet and the bowl, as trinkets to be worn on their hats or their girdles, and a medal was struck having on one side the head of Philip II., on the other two clasped hands with the motto "*Fidèle au roy, jusques à porter la besace.*" The original league of "Beggars" was short-lived, crushed by the iron hand of Alva, but its principles survived and were to be ultimately triumphant.

In the year 1566 the prince of Orange, who had now openly placed himself at the head of the party of revolt, granted letters of marque to a number of vessels manned by crews of desperadoes drawn from all nationalities. These fierce corsairs under the command of a succession of daring and reckless leaders—the best-known of whom is William de la Marck, lord of Lumey—were called "*Gueux de mer*," or "Sea Beggars." At first they were content with plundering both by sea and land and carrying their booty to the English ports where they were able to refit and replenish their stores. This went on till 1572, when Queen Elizabeth suddenly refused to admit them to her harbours. Having no longer any refuge, the Sea Beggars in desperation made an attack upon Brill, which they seized by surprise in the absence of the Spanish garrison on the 1st of April 1572. Encouraged by their unhopèd-for success, they now sailed to Flushing, which was also taken by a *coup de main*. The capture of these two towns gave the signal for a general revolt of the northern Netherlands, and is regarded as the real beginning of the War of Dutch Independence.

GUEVARA, ANTONIO DE (c. 1490-1544), Spanish chronicler and moralist, was a native of the province of Alava, and passed some of his earlier years at the court of Isabella, queen of Castile. In 1528 he entered the Franciscan order, and afterwards accompanied the emperor Charles V. during his journeys to Italy and other parts of Europe. After having held successively the offices of court preacher, court historiographer, bishop of Guadix and bishop of Mondoñedo, he died in 1544. His earliest work, entitled *Reloj de príncipes*, published at Valladolid in 1529, and, according to its author, the fruit of eleven years' labour, is a didactic novel, designed, after the manner of Xenophon's *Cyropædia*, to delineate, in a somewhat ideal way for the benefit of modern sovereigns, the life and character of an ancient prince, Marcus Aurelius, distinguished for wisdom and virtue. It was often reprinted in Spanish; and before the close of the century had also been translated into Latin, Italian, French and English,

an English translation being by J. Bourchier (London, 1546) and another being by T. North. It is difficult now to account for its extraordinary popularity, its thought being neither just nor profound, while its style is stiff and affected. It gave rise to a literary controversy, however, of great bitterness and violence, the author having ventured without warrant to claim for it an historical character, appealing to an imaginary "manuscript in Florence." Other works of Guevara are the *Decada de los Césares* (Valladolid, 1539), or "Lives of the Ten Roman Emperors," in imitation of the manner of Plutarch and Suetonius; and the *Epistolas familiares* (Valladolid, 1539-1545), sometimes called "The Golden Letters," often printed in Spain, and translated into all the principal languages of Europe. They are in reality a collection of stiff and formal essays which have long ago fallen into merited oblivion. Guevara, whose influence upon the Spanish prose of the 16th century was considerable, also wrote *Libro de los inventores del arte de marear* (Valladolid, 1539, and Madrid, 1895).

GUEVARA, LUIS VELEZ DE (1579-1644), Spanish dramatist and novelist, was born at Ecija on the 1st of August 1579. After graduating as a sizar at the university of Osuna in 1596, he joined the household of Rodrigo de Castro, cardinal-archbishop of Seville, and celebrated the marriage of Philip II. in a poem signed "Velez de Santander," a name which he continued to use till some years later. He appears to have served as a soldier in Italy and Algiers, returning to Spain in 1602 when he entered the service of the count de Saldaña, and dedicated himself to writing for the stage. He died at Madrid on the 10th of November 1644. He was the author of over four hundred plays, of which the best are *Reinar despues de morir*, *Adas peso el rey que la sangre*, *La Luna de la Sierra* and *El Diabolo está en Castillana*; but he is most widely known as the author of *El Diabolo cojuelo* (1641), a fantastic novel which suggested to Le Sage the idea of his *Diabolo boiteux*.

GUGLIELMI, PIETRO (1727-1804), Italian composer, was born at Massa Carrara in May 1727, and died in Rome on the 19th of November 1804. He received his first musical education from his father, and afterwards studied under Durante at the Conservatorio di Santa Maria di Loreto at Naples. His first operatic work, produced at Turin in 1755, established his reputation, and soon his fame spread beyond the limits of his own country, so that in 1762 he was called to Dresden to conduct the opera there. He remained for some years in Germany, where his works met with much success, but the greatest triumphs were reserved for him in England. He went to London, according to Burney, in 1768, but according to Florimo in 1772, returning to Naples in 1777. He still continued to produce operas at an astounding rate, but was unable to compete successfully with the younger masters of the day. In 1793 he became *maestro di cappella* at St Peter's, Rome. He was a very prolific composer of Italian comic opera, and there is in most of his scores a vein of humour and natural gaiety not surpassed by Cimarosa himself. In serious opera he was less successful. But here also he shows at least the qualities of a competent musician. Considering the enormous number of his works, his unequal workmanship and the frequent instances of mechanical and slipshod writing in his music need not surprise us. The following are among the most celebrated of his operas: *I Due Gemelli*, *La Serna innamorata*, *La Pastorella nobile*, *La Bella Pasticatrice*, *Rinaldo*, *Artaserse*, *Didone* and *Enea e Lavinia*. He also wrote oratorios and miscellaneous pieces of orchestral and chamber music. Of his eight sons two at least acquired fame as musicians—Pietro Carlo (1763-1827), a successful imitator of his father's operatic style, and Giacomo, an excellent singer.

GUIANA (*Guayana*, *Guayana*), the general name given in its

variously interpreted. But the late Col. G. E. Church supplies the following note, which has the weight of his great authority; "I cannot confirm the suggestion of Schomburgk that Guayana received its name from a small river, a tributary of the Orinoco; supposed to be the Waini or Guainia. In South America, east of the Andes, it was the common custom of any tribe occupying a length of river to call it simply 'the river'; but the other tribes

widest acceptance to the part of South America lying to the north-east from 8° 40' N to 3° 30' S, and from 50° W to 68° 30' W. Its greatest length, from Cabo do Norte to the confluence of the Rio Xuc and Rio Negro, is about 1250 m., its greatest breadth, from Barima Point in the mouth of the Orinoco to the confluence of the Rio Negro and Amazon, 800 m. Its area is roughly 690,000 sq. m. Comprised in this vast territory are Venezuelan (formerly Spanish) Guiana, lying on both sides of the Orinoco and extending S. and S.W. to the Rio Negro and Brazilian settlements; British Guiana, extending from Venezuela to the left bank of the Corentya river, Dutch Guiana

designated any section of it by the name of the people living on its banks. Many streams, therefore, had more than a dozen names. It is probable that no important river had one name alone throughout its course, prior to the time of the Conquest. The radical *wai*, *wayni*, is found as a prefix, and very frequently as a termination, to the names of numerous rivers, not only throughout Guayana but all over the Orinoco and Amazon valleys. For instance, Paymary Indians called the portion of the Purús river which they occupied the *Waini*. It simply means water, or a fountain of water, or a river. The alternative suggestion that Guayana is an Indian word signifying 'wild coast,' I also think untenable. This term, applied to the north-east fringing of South America between the Orinoco and the Amazon, is found on the old Dutch map of Hartmanck, who calls it 'Guiana Caribania de Wilde Kust,' a name which must have well described it when, in 1580, some Zealanders of the Netherlands, sent a ship to cruise along it, from the mouth of the Amazon to that of the Orinoco, and formed the first settlement near the river Pomeroon. The map of Firnao Vaz Dourado, 1564, calls the northern part of South America, including the present British Guiana, 'East Peru.' An anonymous Spanish map, about 1566, gives Guayana as lying on the east side of the Orinoco just above its mouth. About 1660, Sebastian de Ruesta, cosmographer of the *Casa de Contratacion de Sevilla*, shows Guayana covering the British, French and Dutch Guayanias. According to the map of Nicolas de Fer, 1719, a tribe of Guayazis (Guyanans) occupied the south side of the Amazon river, front of the island of Tupinambará, east of the mouth of the Madeira. Aristides Rojas, an eminent Venezuelan scholar, says that the Mariches Indians, near Caracas, inhabited a site called Guayana long before the discovery of South America by the Spaniards. Coudreau in his *Ches nes Indes* mentions that the *Roucouyennes* of Guayana take their name from a large tree in their forests, which appears to be the origin of the name Guayana. According to Michelana y Rojas, in their report to the Venezuelan government on their voyages in the basin of the Orinoco, 'Guayana derives its name from the Indians who live between the Caroni river and the Sierra de Imataca, called Guayanos.' My own studies of aboriginal South America lead me to support the statement of Michelana y Rojas, but with the following enlargement of it: The Portuguese, in the early part of the 16th century, found that the coast and mountain district of Rio de Janeiro, between Cape São Thome and Angra dos Reis, belonged to the formidable *Tamoyos*. South of these, for a distance of about 300 m. of the ocean slope of the coast range, were the *Guayana* tribes, called by the early writers *Guayná*, *Goyaná*, *Guayaná*, *Goyaná* and, plural, *Guayánas*, *Goyánas* and *Guayánas*. They were constantly at feud with the *Tamoyos* and with their neighbours on the south, the *Carijos*, as well as with the vast Tapuya hordes of the Sertão to the interior. Long before the discovery, they had been forced to abandon their beautiful lands, but had recuperated their strength, returned and reconquered their ancient habitat. Meanwhile, however, many of them had migrated northward, some had settled in the Sertão back of Bahia and Pernambuco, others on the middle Amazon and in the valley of the Orinoco, but a large number had crossed the lower Amazon and occupied an extensive area of country to the north of it, about the size of Belgium, along the Tumuchucac range of highlands, and the upper Paron and Maroni rivers, as well as a large district on the northern slope of the above-named range. In their new home they became known as *Roucouyennes*, because, like the *Mundurucos* of the middle Amazon, they rubbed and painted themselves with *roucou* or *urucu* (Bixa Orellana); but other surrounding tribes called them *Ouayanás*, that is *Guayánas*—the *Gua*, so common to the Guarani-Tupi tongue, having become corrupted into *Oua*. Porto Seguro says of the so-called *Tupia*, 'at other times they gave themselves the name of *Guayá* or *Guayáná*, which probably means "brothers," from which comes *Guayanas* and *Guayánases*. . . . The latter occupied the country just south of Rio de Janeiro. . . . The masters of the Capitania of St Vincent called themselves *Guianás*. Guinía, referring to north-eastern South America (1745), speaks of five missions being formed to civilize the *Nacion Guayana*. In view of the above, it may be thought reasonable to assume that the vast territory now known as Guayana (British, Dutch, French, Brazilian and Venezuelan) derives its name from its aborigines who were found there at the time of the discovery, and whose original home was the region I have indicated."

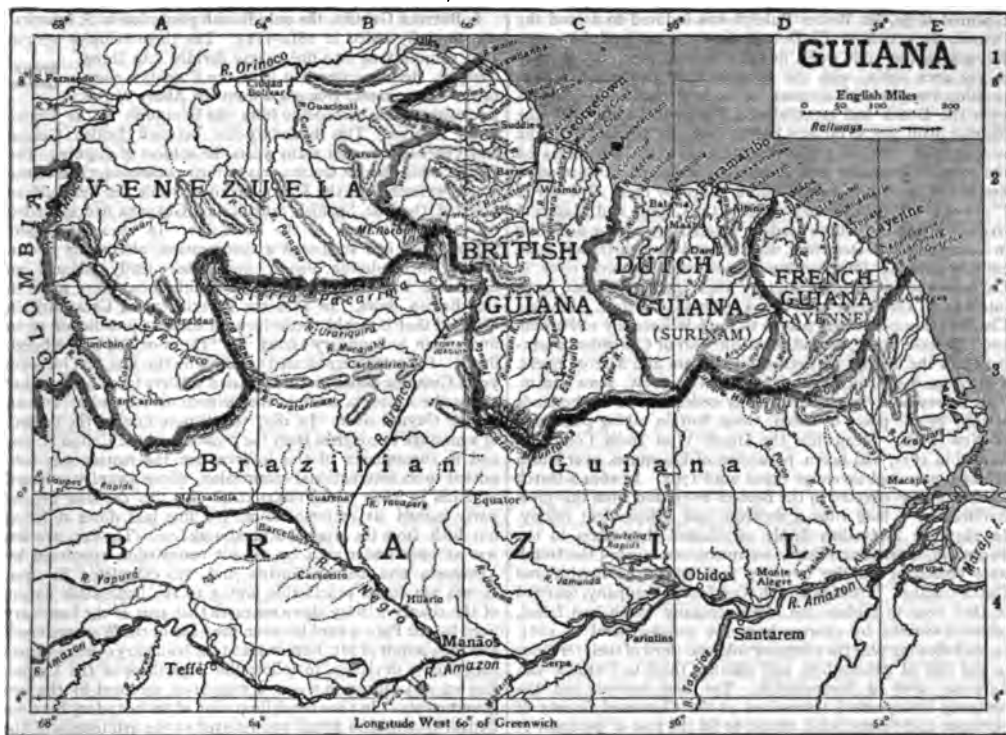

(or Surinam), from the Corentyn to the Maroni river; French Guiana (or Cayenne), from the Maroni to the Oyapock river;¹ Brazilian (formerly Portuguese) Guiana, extending from the southern boundaries of French, Dutch, British and part of Venezuelan Guiana, to the Amazon and the Negro. Of these divisions the first and last are now included in Venezuela and Brazil respectively; British, Dutch and French Guiana are described in order below, and are alone considered here.

In their physical geography the three Guianas present certain common characteristics. In each the principal features are the rivers and their branch streams. In each colony the northern portion consists of a fluvio-marine deposit extending inland and gradually rising to a height of 10 to 15 ft. above the sea. This alluvial plain varies in width from 50 m. to 18 m. and is traversed by ridges of sand and shells, roughly parallel to what is now the coast, indicating the trend of former shore lines. By the draining and diking of these lands the plantations have been formed along the coast and up the rivers. These low lands are attached to a somewhat higher plateau, which towards the coast is traversed by numerous huge sand-dunes and inland by ranges of hills rising in places to as much as 2000 ft. The greater part of this belt of country, in which the auriferous districts principally occur, is covered with a dense growth of jungle and high forest, but savannahs, growing only a long wiry grass and poor shrubs, intrude here and there, being in the S.E. much nearer to the coast than in the N.W. The hinterlands consist of undulating open savannahs rising into hills and mountains, some grass-covered, some in dense forest.

Geology.—Guiana is formed almost entirely of gneiss and crystal-

line schists penetrated by numerous dikes of diorite, diabase, &c. The gold of the placer deposits appears to be derived, not from quartz reefs, but from the schists and intrusive rocks, the selvages of the diabase dikes sometimes containing as much as 5 oz. of gold to the ton. In British Guiana a series of conglomerates, red and white sandstone and red shale, rests upon the gneiss and forms the remarkable table-topped mountains Koraima, Kukuenaam, &c. The beds are horizontal, and according to Brown and Sawkins, three layers of greenstone, partly intrusive and partly contemporaneous, are interstratified with the sedimentary deposits. The age of these beds is uncertain, but they evidently correspond with the similar series which occurs in Brazil, partly Palaeozoic and partly Cretaceous. In Dutch Guiana there are a few small patches supposed to belong to the Cretaceous period. Along the coast, and in the lower parts of the river valleys, are deposits which are mainly Quaternary but may also include beds of Tertiary age.

History.—The coast of Guiana was sighted by Columbus in 1498 when he discovered the island of Trinidad and the peninsula of Paria, and in the following year by Alonso de Ojeda and Amerigo Vespucci; and in 1500 Vincente Yañez Pinzon ventured south of the equator, and sailing north-west along the coast discovered the Amazon; he is believed to have also entered some of the other rivers of Guiana, one of which, now called Oyapock, is marked on early maps as Rio Pinzon. Little, however, was known of Guiana until the fame of the fabled golden city Manoa or El Dorado tempted adventurers to explore its rivers and forests. From letters of these explorers found in bassins du Parou et du Yari (affluents de l'Amazone) d'après les explorations du Dr Crevaux," *Bull. Soc. Géogr.* ser. 7, vol. vi. (Paris, 1885), pp. 453-492 (with geological map); E. Martin, *Geologische Studien über Niederländisch-West-Indien, auf Grund eigener Untersuchungsreisen* (Leiden, 1888); W. Bergt, "Zur Geologie des Coppename- und Nickerietales in Surinam (Holländisch-Guyana)," *Samml. d. Geol. Reichsmus.* (Leiden), ser. 2, Bd. ii. Helt 2, pp. 93-163 (with 3 maps); and for British Guiana, the official reports on the geology of various districts, by J. B. Harrison, C. W. Anderson, H. I. Perkins, published at Georgetown.

¹ This is the boundary generally accepted; but it is in dispute.

² See C. B. Brown and J. G. Sawkins, *Reports on the Physical, Descriptive and Economic Geology of British Guiana* (London, 1875); C. Velain, "Esquisse géologique de la Guyane française et des

captured ships, Sir Walter Raleigh was induced to ascend the Orinoco in search of El Dorado in 1595, to send Lawrence Keymis on the same quest in the following year, and, in 1617 to try once again, with the same intrepid lieutenant, an expedition fraught with disaster for both of them. As early as 1580 the Dutch had established a systematic trade with the Spanish main, but so far as is known their first voyage to Guiana was in 1598. By 1613 they had three or four settlements on the coast of Demerara and Essequibo, and in about 1616 some Zealanders settled on a small island, called by them *Kyk ober al* ("see over all"), in the confluence of the Cuyuni and Mazaruni rivers. While the Dutch traders were struggling for a footing in Essequibo and Demerara, English and French traders were endeavouring to form settlements on the Oyapock river, in Cayenne and in Surinam, and by 1652 the English had large interests in the latter and the French in Cayenne. In 1663 Charles II. issued letters patent to Lord Willoughby of Parham and Lawrence Hyde, second son of the earl of Clarendon, granting them the district between the Copenan and Maroni rivers, a province described as extending from E. to W. some 120 m. This colony was, however, formally ceded to the Netherlands in 1667 by the peace of Breda, Great Britain taking possession of New York. Meanwhile the Dutch West India Company, formed in 1621, had taken possession of Essequibo, over which colony it exercised sovereign rights until 1701. In 1624 a Dutch settlement was effected in the Berbice river, and from this grew Berbice, for a long time a separate and independent colony. In 1657 the Zealanders firmly established themselves in the Pomeroun, Moruca and Demerara rivers, and by 1674 the Dutch were colonizing all the territory now known as British and Dutch Guiana. The New Dutch West Indian Company, founded in the year to replace the older company which had failed, received Guiana by charter from the states-general in 1682. In the following year the company sold one-third of their territory to the city of Amsterdam, and another third to Cornelis van Aerssens, lord of Sommelsdijk. The new owners and the company incorporated themselves as the Chartered Society of Surinam, and Sommelsdijk agreed to fill the post of governor of the colony at his own expense. The lucrative trade in slaves was retained by the West Indian Company, but the society could import them on its own account by paying a fine to the company. Sommelsdijk's rule was wise and energetic. He repressed and pacified the Indian tribes, erected forts and disciplined the soldiery, constructed the canal which bears his name, established a high court of justice and introduced the valuable cultivation of the cocoa-nut. But on the 17th of June 1688 he was massacred in a mutiny of the soldiers. The "third" which Sommelsdijk possessed was offered by his widow to William III. of England, but it was ultimately purchased by the city of Amsterdam for 700,000 fl. The settlements in Essequibo progressed somewhat slowly, and it was not until immigration was attracted in 1740 by offers to newcomers of free land and immunity for a decade from taxation that anything like a colony could be said to exist there. In 1732 Berbice placed itself under the protection of the states-general of Holland and was granted a constitution, and in 1773 Demerara, till then a dependency of Essequibo, was constituted as a separate colony. In 1781 the three colonies, Demerara, Essequibo and Berbice, were captured by British privateers, and were placed by Rodney under the governor of Barbados, but in 1782 they were taken by France, then an ally of the Netherlands, and retained until the peace of 1783, when they were restored to Holland. In 1784 Essequibo and Demerara were placed under one governor, and Georgetown—then called Stabroek—was fixed on as the seat of government. The next decade saw a series of struggles between the colonies and the Dutch West India company, which ended in the company being wound up and in the three colonies being governed directly by the states-general. In 1796 the British again took possession, and retained the three colonies until the peace of Amiens in 1802, when they were once again restored to Holland, only to be recaptured by Great Britain in 1803, in which year the history proper of British Guiana began.

I. BRITISH GUIANA, the only British possession in S. America, was formally ceded in 1814-1815. The three colonies were in 1831 consolidated into one colony divided into three counties, Berbice extending from the Corentyne river to the Abary creek, Demerara from the Abary to the Boerasirie creek, Essequibo from the Boerasirie to the Venezuelan frontier. This boundary-line between British Guiana and Venezuela was for many years the subject of dispute. The Dutch, while British Guiana was in their possession, claimed the whole watershed of the Essequibo river, while the Venezuelans asserted that the Spanish province of Guayana had extended up to the left bank of the Essequibo. In 1840 Sir Robert Schomburgk had suggested a demarcation, afterwards known as the "Schomburgk line"; and subsequently, though no agreement was arrived at, certain modifications were made in this British claim. In 1886 the government of Great Britain declared that it would thenceforward exercise jurisdiction up to and within a boundary known as "the modified Schomburgk line." Outposts were located at points on this line, and for some years Guianese police and Venezuelan soldiers faced one another across the Amacura creek in the Orinoco mouth and at Yurua up the Cuyuni river. In 1897 the dispute formed the subject of a message to congress from the president of the United States, and in consequence of this intervention the matter was submitted to an international commission, whose award was issued at Paris in 1899 (see VENEZUELA). By this decision neither party gained its extreme claim, the line laid down differing but little from the original Schomburgk line. The demarcation was at once undertaken by a joint commission appointed by Venezuela and British Guiana and was completed in 1904. It was not found practicable, owing to the impassable nature of the country, to lay down on earth that part of the boundary fixed by the Paris award between the head of the Wenamu creek and the summit of Mt. Roraima, and the boundary commissioners suggested a deviation to follow the watersheds of the Caroni, Cuyuni and Mazaruni rivers, a suggestion accepted by the two governments. In 1902 the delimitation of the boundary between British Guiana and Brazil was referred to the arbitration of the king of Italy, and by his reward, issued in June 1904, the substantial area in dispute was conceded to British Guiana. The work of demarcation has since been carried out.

Towns, &c.—The capital of British Guiana is Georgetown, at the mouth of the Demerara river, on its right bank, with a population of about 50,000. New Amsterdam, on the right bank of the Berbice river, has a population of about 7500. Each possesses a mayor and town council, with statutory power to impose rates. There are nineteen incorporated villages, and ten other locally governed areas known as country districts, the affairs of which are controlled by local authorities, known as village councils and country authorities respectively.

Population.—The census of 1891 gave the population of British Guiana as 278,328. There was no census taken in 1901. By official estimates the population at the end of 1904 was 301,023. Of these some 120,000 were negroes and 124,000 East Indians, 4300 were Europeans, other than Portuguese, estimated at about 11,600, and some 30,000 of mixed race. The aborigines—Arawaks, Caribs, Wapisianas, Warraws, &c.—who numbered about 10,000 in 1891, are now estimated at about 6500. In 1904 the birth-rate for the whole colony was 30.3 per 1000 and the death-rate 28.8.

Physical Geography.—The surface features of British Guiana may be divided roughly into four regions: first, the alluvial seaboard, flat and below the level of high-water; secondly, the forest belt, swampy along the rivers but rising into undulating lands and hills between them, thirdly, the savannas in and inland of the forest belt, elevated table-lands, grass-covered and practically treeless, and fourthly, the mountain ranges. The eastern portion of the colony, from the source of its two largest rivers, the Corentyne and Essequibo, is a rough inclined plain, starting at some 900 ft. above sea-level at the source of the Takutu in the west, but only some 400 at that of the Corentyne in the west, and sloping down gradually to the low alluvial flats about 3 ft. below high-water line. The eastern part is generally forested; the western is an almost level savanna, with woodlands along the rivers. The

northern portion of British Guiana, the alluvial flats alluded to already, consists of a fluvio-marine deposit extending inland from 25 m. to 30 m., gradually rising to about 12 ft. above high-water mark and ending against beds of sandy clay, the residua of igneous rocks decomposed *in situ*, which form an extensive undulating region rising to 150 ft. above the sea and stretching back to the forest-covered hills. Roughly parallel to the existing coast-line are narrow reefs of sand and sea-shells, which are dunes indicating the trend of former limits of the sea, and still farther back are the higher "sand hills," hills of granite or diabase with a thick stratum of coarse white sand superimposed. From the coast-line seawards the ocean deepens very gradually, and at low tide extensive flats of sand and of mixed clay and sand (called locally "caddy") are left bare, these flats being at times covered with a deposit of thin drift mud.

Two great parallel mountain systems cross the colony from W. to E., the greater being that of the Pacaraima and Merumé Mts., and the lesser including the Kanuku Mts. (2000 ft.), while the Acaai Mts., a densely-wooded range rising to 2500 ft., form the southern boundary of British Guiana and the watershed between the Essequibo and the Amazon. These mountains rise generally in a succession of terraces and broad plateaus, with steep or even sheer sandstone escarpments. They are mostly flat-topped, and their average height is about 3500 ft. The Pacaraima Mts., however, reach 8635 ft. at Roraima, and the latter remarkable mountain rises as a perpendicular wall of red rock 1500 ft. in height springing out of the forest-clad slopes below the summit, and was considered inaccessible until in December 1884 Messrs. in Thurn and Perkins found a ledge by which the top could be reached. The summit is a table-land some 12 sq. m. in area. Mt. Kukenam is of similar structure and also rises above 8500 ft. Other conspicuous summits (about 7000 ft.) are Iwalkarima, Eluwarima, Iutipu and Waiakapiapu. The southern portion of the Pacaraima range comprises rugged hills and rock-strewn valleys, but to the N., where the sandstone assumes the table-shaped form, there are dense forests, and the scenery is of extraordinary grandeur. Waterfalls frequently descend the cliffs from a great height (nearly 2000 ft. sheer at Roraima and Kukenam). The sandstone formation can be traced from the northern Pacaraima range on the N.W. to the Corentyn in the S.E. It is traversed in places by dikes and sills of diabase or dolerite, while bosses of more or less altered gabbro rise through it. The surface of a large part of the colony is composed of gneiss, and of gneissose granite, which is seen in large water-worn bosses in the river beds. Intrusive granite is of somewhat rare occurrence; where found, it gives rise to long low rolls of hilly country and to cataracts in the rivers. Extensive areas of the country consist of quartz-porphyr, porphyrites and felsestone, and of more or less schistose rocks derived from them. These rocks are closely connected with the gneissose granites and gneiss, and there are reasons for believing that the latter are the deep-seated portions of them and are only visible where they have been exposed by denudation. Long ranges of hills, varying in elevation from a few hundreds to from 2000 ft. to 3000 ft., traverse the plains of the gneissose districts. These are caused either by old intrusions of diabase and gabbro which have undergone modifications, or by later ones of dolerite. These ranges are of high importance, as the rocks comprising them are the main source of gold in British Guiana.

Rivers.—The principal physical features of British Guiana are its rivers and their branches, which form one vast network of waterways all over it, and are the principal, indeed practically the only, highways inland from the coast. Chief among them are the Waini, the Essequibo, and its tributaries the Mazaruni and Cuyuni, the Demerara, the Berbice and the Corentyn. The Essequibo rises in the Acaai Mts., in 0° 41' N. and about 850 ft. above the sea, and flows northwards for about 600 m. until it discharges itself into the ocean by an estuary nearly 15 m. in width. In this estuary are several large and fertile islands, on four of which sugar used to be grown. Now but one, Wakenam, can boast of a factory. The Essequibo can be entered only by craft drawing less than 20 ft. and is navigable for these vessels for not more than 50 m., its subsequent course upwards being frequently broken by cataracts and rapids. Some 7 m. below the first series of rapids it is joined by the Mazaruni, itself joined by the Cuyuni some 4 m. farther up. It has a remarkable course from its source in the Merume Mountains, about 2400 ft. above the sea. It flows first south, then west, north-west, north, and finally south-east to within 20 m. of its own source, forming many fine falls, and its course thereafter is still very tortuous. In 4° N. and 58° W., the Essequibo is joined by the Rupununi, which, rising in a savannah at the foot of the Karawaimo Mts., has a northerly and easterly course of fully 200 m. In 3° 57' N. the Awaricura joins the Rupununi, and by this tributary the Pirara, a tributary of the Amazon, may be reached—an example of the interesting series of *liabos* connecting nearly all S. American rivers with one another. Another large tributary of the Essequibo is the Potaro, on which, at 1130 ft. above sea-level and in 5° 8' N. and 50° 19' W., is the celebrated Kaieteur fall, discovered in 1870 by Mr C. Barrington Brown while engaged on a geological survey. This fall is produced by the river flowing from a tableland of sandstone and conglomerate into a deep valley 822 ft. below. For the first 741 ft. the water falls as a perpendicular column, thence as a sloping

cataract to the still reach below. The river 200 yds. above the fall is about 400 ft. wide, while the actual waterway of the fall itself varies from 120 ft. in dry weather to nearly 400 ft. in rainy seasons. The Kaieteur, which it took Mr Brown a fortnight to reach from the coast, can now be reached on the fifth day from Georgetown. Among other considerable tributaries of the Essequibo are the Siparuni, Bureo-Bureo, Rewa, Kuyuwini and Kassi-Kudji. The Demerara river, the head-waters of which are known only to Indians, rises probably near 5° N., and after a winding northerly course of some 200 m. enters the ocean in 6° 50' N. and 58° 20' W. A bar of mud and sand prevents the entrance of vessels drawing more than 10 ft. The river is from its mouth, which is nearly 2 m. wide, navigable for 70 m. to all vessels which can enter. The Berbice river rises in about 3° 40' N., and in 3° 53' N. is within 9 m. of the Essequibo. At its mouth it is about 2½ m. wide, and is navigable for vessels drawing not more than 12 ft. for about 105 m. and for vessels drawing not more than 7 ft. for fully 175 m. Thence upwards it is broken by great cataracts. The Canje creek joins the Berbice river close to the sea. The Corentyn river rises in 1° 48' 30" N., about 140 m. E. of the Essequibo, and flowing northwards enters the Atlantic by an estuary some 14 m. wide. The divide between its head-waters and those of streams belonging to the Amazon system is only some 400 ft. in elevation. It is navigable for about 150 m., some of the reaches being of great width and beauty. The upper reaches are broken by a series of great cataracts, some of which, until the discovery of Kaieteur, were believed to be the grandest in British Guiana. Among other rivers are the Pomeroon, Moruca and Barima, while several large streams or creeks fall directly into the Atlantic, the largest being the Abary, Mahaicony and Mahaica, between Berbice and Demerara, and the Boerasirie between Demerara and Essequibo. The colour of the water of the rivers and creeks is in general a dark brown, caused by the infusion of vegetable matter, but where the streams run for a long distance through savannahs they are of a milky colour.

Climate.—The climate is, as tropical countries go, not unhealthy. Malarial fevers are common but preventable; and phthisis is prevalent, not because the climate is unsuitable to sufferers from pulmonary complaints, but because of the ignorance of the common people of the elementary principles of hygiene, an ignorance which the state is endeavouring to lessen by including the teaching of hygiene in the syllabus of the primary schools. The temperature is uniform on the coast for the ten months from October to July, the regular N.E. trade winds keeping it down to an average of 80° F. In August and September the trades die away and the heat becomes oppressive. In the interior the nights are cold and damp. Hurricanes, indeed even strong gales, are unknown; a tidal wave is an impossibility; and the nature of the soil of the coast lands renders earthquakes practically harmless. Occasionally there are severe droughts, and the rains are sometimes unduly prolonged, but usually the year is clearly divided into two wet and two dry seasons. The long wet season begins in mid-April and lasts until mid-August. The long dry season is from September to the last week in November. December and January constitute the short rainy season, and February and March the short dry season. The rainfall varies greatly in different parts of the colony; on the coast it averages about 80 in. annually.

Flora.—The vegetation is most luxuriant and its growth perpetual. Indigenous trees and plants abound in the utmost variety, while many exotics have readily adapted themselves to local conditions. Along the coast is a belt of courida and mangrove; the bark of the latter being used for tanning—forming a natural barrier to the inroads of the sea, but one which—very unwisely—has been in parts almost ruined to allow of direct drainage. The vast forests afford an almost inexhaustible supply of valuable timbers; greenheart and mora, largely used in shipbuilding and for wharves and dock and lock gates; silverbilly, yielding magnificent planks for all kinds of boats; and cabinet woods, such as cedar and crabwood. There may be seen great trees, struggling for life one with the other, covered with orchids—some of great beauty and value—and draped with falling *lianas* and vines. Giant palms fringe the riverbanks and break the monotony of the mass of smaller foliage. Many of the trees yield gums, oils and febrifuges, the bullet tree being bled extensively for *balata*, a gum used largely in the manufacture of belting. Valuable varieties of rubber have also been found in several districts, and since early in 1905 have attracted the attention of experts from abroad. On the coast plantains, bananas and mangoes grow readily and are largely used for food, while several districts are admirably adapted to the growth of limes. Oranges, pineapples, star-apples, granadillas, guavas are among the fruits; Indian corn, cassava, yams, eddoes, tannias, sweet potatoes and ochros are among the vegetables, while innumerable varieties of peppers are grown and used in large quantities by all classes. The dainty avocado pear, purple and green, grows readily. In the lagoons and trenches many varieties of water-lilies grow wild, the largest being the famous *Victoria regia*.

Fauna.—Guiana is full of wild animals, birds, insects and reptiles. Among the wild animals, one and all nocturnal, are the mippourrie or tapir, manatee, acouri and labba (both excellent eating), sloth, ant-eater, armadillo, several kinds of deer, baboons, monkeys and the puma and jaguar. The last is seen

frequently down on the coast, attracted from the forest by the cattle grazing on the front and back pasture lands of the estates. Among the birds may be mentioned the carrion crow (an invaluable scavenger), vicissi and muscovy ducks, snipe, teal, plover, pigeon, the ubiquitous kinkadee or *qu'est que dit*, a species of shrike—his name derived from his shrill call—the canary and the two-twa, both charming whistlers. These are all found on the coast. In the forest are maam (partridge), maroudi (wild turkey), the beautiful bell-bird with note like a silver gong, the quadrille bird with its tuneful oft-repeated bar, great flocks of macaws and parrots, and other birds of plumage of almost indescribable richness and variety. On the coast the trenches and canals are full of alligators, but the great cayman is found only in the rivers of the interior. Among the many varieties of snakes are huge constricting camoudies, deadly bushmasters, labarrias and rattlesnakes. Among other reptiles are the two large lizards, the salumpenta (an active enemy of the barn-door fowl), and the iguana, whose flesh when cooked resembles tender chicken. The rivers, streams and trenches abound with fishes, crabs and shrimps, the amount of the latter consumed being enormous, running into tons weekly as the coolies use them in their curries and the blacks in their foo-foo.

Government and Administration.—Executive power is vested in a governor, who is advised in all administrative matters by an executive council, consisting of five official and three unofficial members nominated by the crown. Legislative authority is vested in the Court of Policy, consisting of the governor, who presides and without whose permission no legislation can be initiated, seven other official members and eight elected members. This body has, however, no financial authority, all taxation and expenditure being dealt with by the Combined Court, consisting of the Court of Policy combined with six financial representatives. The elected members of the Court of Policy and the financial representatives are elected by their several constituencies for five years. Qualification for the Court of Policy is the ownership, or possession under lease for a term of twenty-one years, of eighty acres of land, of which at least forty acres are under cultivation, or of house property to the value of \$7500. A financial representative must be similarly qualified or be in receipt of a clear income of not less than £300 per annum. Every male is entitled to be registered as a voter who (in addition to the usual formal qualifications) owns (during six months prior to registration) three acres of land in cultivation or a house of the annual rental or value of £20; or is a secured tenant for not less than three years of six acres of land in cultivation or for one year of a house of £40 rental; or has an income of not less than £100 per annum; or has during the previous twelve months paid £4, 3s. 4d. in direct taxation. Residence in the electoral district for six months prior to registration is coupled with the last two alternative qualifications. Plural voting is legal but no plumping is allowed. The combined court is by this constitution, which was granted in 1891, allowed the use of all revenues due to the crown in return for a civil list voted for a term now fixed at three years. English is the official and common language. The Roman-Dutch law, modified by orders-in-council and local statutes, governs actions in the civil courts, but the criminal law is founded on that of England. Magistrates have in civil cases jurisdiction up to £20, while an appeal lies from their decisions in any criminal or civil case. The supreme court consists of a chief justice and two puisne judges, and has various jurisdictions. The full court, consisting of the three judges or any two of them, has jurisdiction over all civil matters, but an appeal lies to His Majesty in privy council in cases involving £500 and upwards. A single judge sits in insolvency, in actions involving not over £520, and in appeals from magistrates' decisions. The appeal full court, consisting of three judges, sits to hear appeals from decisions of a single judge in the limited civil, appellate and insolvency courts. Criminal courts are held four times a year in each county, a single judge presiding in each court. A court of crown cases reserved is formed by the three judges, of whom two form a quorum provided the chief-justice is one of the two. There are no imperial troops now stationed in British Guiana, but there is a semi-military police force, a small militia and two companies of volunteers. The Church of England and the Church of Scotland are both established, and grants-in-aid are also given to the

Roman Catholic and Wesleyan churches and to several other denominations.

The revenue and expenditure now each amount annually to an average of a little over £500,000. About one-half of the revenue is produced by import duties, and about £90,000 by excise. The public debt on the 31st of March 1905 stood at £989,620.

The system of primary education is denominational and is mainly supported from the general revenue. During 1904-1905, 213 schools received grants-in-aid amounting to £23,500, the average cost per scholar being a little over £1. These grants are calculated on the results of examinations held annually, an allowance varying from 4s. 4d. to 1s. 0d. being made for each pass in reading, writing, arithmetic, school-garden work, nature study, singing and drill, English, geography, elementary hygiene and sewing. Secondary education is provided in Georgetown at some private establishments, and for boys at Queen's College, an undenominational government institution where the course of instruction is the same as at a public school in England, and the boys are prepared for the Cambridge local examinations, on the result of which annually depend the Guiana scholarship—open to boys and girls, and carrying a university or professional training in England—and two scholarships at Queen's College.

Industries and Trade.—At the end of the third decade of the 19th century the principal exports were sugar, rum, molasses, cotton and coffee. In 1830, 9,500,000 lb of coffee were sent abroad, but after the emancipation of the slaves it almost ceased as an export, and the little that is now grown is practically entirely consumed in the colony. The cultivation of cotton ceased in 1844, and, but for a short revival during the American civil war, has never prospered since. Efforts have been made to resuscitate its growth, but the experiments of the Board of Agriculture have only shown that So Island cotton is not adaptable to local conditions, and that no other known variety can as yet be recommended. To-day the principal exports are sugar, rum, molasses, molascuit—a cattle food made from molasses—gold, timber, balata, shingles and cattle. The annual value of the total exports is just under £2,000,000, of which about two-thirds go to Great Britain and British possessions. The cultivation of rice has made great strides in recent years, and, where difficulties of drainage and irrigation can be economically overcome, promises to increase rapidly. In 1873, 32,000,000 lb of rice were imported, whereas in 1904-1905, the quantity imported having fallen to 20,500,000 lb, there were over 18,000 acres under rice cultivation, and exportation, principally to the British West Indies, had commenced. The cultivation of the sugar-cane, and its manufacture into sugar and its by-products, still remains, in spite of numerous fluctuations, the staple industry. The provision of a trustworthy labour supply for the estates is of great importance, and local scarcity has made it necessary since 1840 to import it under a system of indenture. In that year and until 1867, liberated Africans were brought from Rio de Janeiro, Havana, Sierra Leone and St Helena, and in 1845 systematic immigration from India commenced and has since been carried on annually—save in 1849-1850. In 1853 immigration from China was tried, and was carried on by the government from 1859 to 1866, when it ceased owing to a convention arranged at Peking, stipulating that all immigrants should on the expiry of their term of indenture be entitled to be sent back at the expense of the colony, a liability it could not afford to incur. To reduce the cost of supervision and kindred expenses, and consequently of the cane and its manufacture into sugar, the policy of centralization has been universally adopted, and forty-six estates now produce as much sugar as three times that number did in 1875. During recent years Canada has come forward as a large buyer of Guiana's sugar, and in 1904-1905 the same amount went there as to the United States, in each case over 44,000 tons, whereas in 1901-1902 the United States took 85,000 tons and Canada under 8000 tons. Practically all the rum and molascuit go to England, and the molasses to Holland and Portuguese possessions. The lands on the coast and on the river banks up to the sand hills are of marked fertility, and can produce almost any tropical vegetable or fruit. Cultivation, however, save on the sugar, coffee and cocoa estates, and by a few exceptional small farmers, is carried on in a haphazard and half-hearted manner, and the problem of agricultural development is one of great difficulty for the government. Much of the privately-owned land is not beneficially occupied, and in many cases it is not possible even to learn to whom it belongs, and though there are vast tracts of uncultivated crown land where a large farm or a small homestead can be easily and cheaply acquired, the difficulties involved in clearing, draining, and in some cases of protecting it by dams, are prohibitive to all but the exceptionally determined.

Prospecting for gold began in 1880, and from 1884 to 1893-1894 the output, chiefly from alluvial workings, increased from 250 oz. to nearly 140,000 oz. annually. The industry then received a serious check by the failure of several mines, and for nearly a decade was almost entirely in the hands of the small tributor, known locally as a pork-knocker. There has been some revival, chiefly due to foreign enterprise. At Ormai on the Essequibo river a German syndicate worked a large concession on the hydraulic process of placer mining with considerable success, and more recently took to dredging on its

flats. In the Puruni (a tributary of the Mazaruni) American capitalists, working the Peters' mine, have established their workings to a considerable depth, besides constructing a road, 60 m. in length, from Kartabo point, at the confluence of the Guyuni and Mazaruni, to the Puruni river opposite the mine. An English syndicate started dredging in the Conawarook, a tributary of the Essequibo. The principal gold districts are on the Essequibo and its tributaries—the chief being the Cuyuni, Mazaruni, Potaro and Conawarook—and on the Barima, Barama and Waini rivers in the north-west district. There have been smaller workings, mostly unsuccessful, in the Demerara and Berbice rivers.

Diamonds and other precious stones have been found in small quantities, and since 1900 efforts have been made to extend the output, nearly 11,000 carats weight of diamonds being exported in 1904. But though the small stones found were of good water, the cost of transport to the diamond fields, on the Mazaruni river, was heavy, and after 1904 the industry declined. Laws dealing with gold and precious stones passed in 1880, 1886 and 1887, and regulations in 1899, were codified in 1902 and amended in 1905.

Timber is cut, and balata and rubber collected, from crown lands by licences issued from the department of Lands and Mines. Wood-cutting, save on concessions held by a local company owning an up-country line of railway connecting the Demerara and Essequibo rivers, is limited to those parts of the forest which are close to the lower stretches of the rivers and creeks, the overland haulage of the heavy logs being both difficult and costly, while transport through the upper reaches of the rivers is impossible on account of the many cataracts and rapids. The average annual value of imports is £1,500,000, of which about two-thirds are from Great Britain and British possessions. Of the vessels trading with the colony, most are under the British flag, the remainder being principally American and Norwegian.

The money of account is dollars and cents, but, with the exception of the notes of the two local banks, the currency is British sterling. The unit of land measure is the Rhymland rood, roughly equal to 12 ft. 4 in. A Rhymland acre contains 300 square roods.

Inland Communication, &c.—The public roads extend along the coast from the Corentyn river to some 20 m. N. of the Essequibo mouth on the Arawak coast, and for a short distance up each of the principal rivers and creeks entering the sea between these points. A line of railway 60½ m. in length runs from Georgetown to Rosignol on the left bank of the Berbice river opposite New Amsterdam; and another line 15 m. long starts from Vreed-en-hoop, on the left bank of the Demerara river opposite Georgetown, and runs to Greenwich Park on the right bank of the Essequibo river some 3 m. from its mouth. A light railway, metre gauge, 18½ m. in length, connects Wismar (on the left bank of the Demerara river some 70 m. from its mouth) with Rockstone (on the right bank of the Essequibo, and above the first series of cataracts in that river). Steamers run daily to and from Georgetown and Wismar, and launches to and from Rockstone and Tumatumari Fall on the Potaro, and all expeditions for the goldfields of the Essequibo and its tributaries above Rockstone travel by this route. Another steamer goes twice a week to Bartica at the confluence of the Essequibo and Mazaruni, and another weekly to Mt. Everard on the Barima, from which termini expeditions start to the other gold and diamond fields. Steamers also run from Georgetown to New Amsterdam and up the Berbice river for about 100 m. Above the termini of these steamer routes all travelling is done in keelless *balacas*, propelled by paddlers and steered when coming through the rapids at both bow and stern by certificated bowmen and sternmen. Owing to the extreme dangers of this inland travelling, stringent regulations have been framed as to the loading of boats, supply of ropes and qualifications of men in charge, and the shooting of certain falls is prohibited. Voyages up-country are of necessity slow, but the return journey is made with comparatively great rapidity, distances laboriously covered on the up-trip in three days being done easily in seven hours when coming back.

From England British Guiana is reached in sixteen days by the steamers of the Royal Mail Steam Packet Company, and in nineteen days by those of the direct line from London and Glasgow. There are also regular services from Canada, the United States, France and Holland.

History.—When taken over in 1803 the prospects of three British colonies were by no means promising, and during the next decade the situation became very critical. Owing to the increased output of sugar by conquered Dutch and French colonies the English market was glutted and the markets of the continent of Europe were not available, Bonaparte having closed the ports. The years 1811 and 1812 were peculiarly disastrous, especially to those engaged in the manufacture of sugar, and at a public meeting held in Georgetown early in the latter year it was stated that the produce of the colony ordinarily worth £1,866,000 had on account of deteriorated value decreased by fully one-third. At this meeting it was resolved to petition the imperial parliament to allow the interchange of produce

with the United States; a resolution which was unfortunately rendered abortive by the outbreak of war between England and the States in 1812, the trade of British Guiana being instead actually harried by American privateers. In his address to the Combined Court on the 20th of October 1812 the governor (General Carmichael) stated that a vessel with government stores had been captured by an American privateer, and in February 1813 the imperial government sent H.M.S. "Peacock" to protect the coast. On the 23rd of that month in cruising along the east coast of Demerara the "Peacock" met the American privateer "Hornet," and though, after a gallant struggle, in which Captain Peake, R.N., was killed, the English ship was sunk with nearly all her crew, the colony did not suffer from any further depredations. In the following years news of the agitation in England in favour of emancipation gradually became known to the slaves and caused considerable unrest among them, culminating in 1823 in a serious outbreak on the estates on the east coast of Demerara. Negroes, demanding their freedom, attacked the houses of several managers, and although at most points these attacks were repulsed with but little loss on either side, the situation was so serious as to necessitate the calling out of the military. The ringleaders were arrested and promptly and vigorously dealt with, while a special court-martial was appointed to try the Rev. John Smith, of the London Missionary Society, who it was alleged had fostered the rising by his teachings to the slave congregation at his chapel in Le Resmouvenir. This trial was stigmatized as unfair by the missionary party in England, but on the whole appears to have been conducted decently by an undoubtedly unbiased court. It is difficult now to form any very definite conclusion. Mr Smith certainly had great influence over the slaves, and while his teaching prior to the outbreak was at least ill-advised, he made no efforts while the disturbances were going on to use his influence on the side of law and order; indeed all he could say in his own defence was that he was ignorant of what was going on, a statement it is impossible to believe to have been strictly veracious. He was found guilty and sentenced to be hanged. It is obvious that it was never intended to carry out this sentence, and on the 29th of November the governor announced that he felt it imperative on him to transmit the findings of the court for His Majesty's consideration. The question of Smith's guilt or innocence created a great deal of feeling in England, the anti-slavery and missionary societies making it a basis for increased agitation in favour of the slaves; but the imperial government evidently agreed with the colonial executive in holding that he could not be exonerated of grave responsibility, as the order of the king was that while the sentence of death was remitted Mr Smith was to be dismissed from the colony and to enter into a recognizance in £2000 not to return to British Guiana or to reside in any other West Indian colony. This order reached Georgetown in April 1824, but Mr Smith had died in the city jail on the 6th of February of a pulmonary complaint from which he had been suffering for some time.

Sir Benjamin d'Urban was governor from April 1824 to May 1833, the principal event of his administration being the consolidation in 1831 of the three colonies into one colony divided into three counties, Berbice, Demerara and Essequibo.

Governor d'Urban was succeeded in June 1833 by Sir James Carmichael Smyth, who began his administration by a proclamation to the slaves stating that while the king intended to improve their condition, the details of his plans were not as yet completed, and warning them against impatience or insubordination. When the resolutions foreshadowing emancipation, passed by the House of Commons on the 12th of June 1833, reached the colony, the planters, to whom the governor's proclamation had been most distasteful, were thunderstruck and even the government was surprised. Naturally the slaves were wildly jubilant. Emancipation brought troublous times through which the governor steered the colony with great tact and firmness, serious troubles being nipped in the bud solely by his great personality, and the subsequent conflicts with the apprentices

might have been obliterated had he lived longer. He died at Camp House on the 4th of March 1838.

In the years following emancipation the colony was in a serious condition. The report of a commission in 1850 proved that it was virtually ruined, and only by the introduction of immigrants to provide a reliable labour supply were the sugar estates saved from total extinction. By 1853 the colony had begun to make headway, and Sir Henry Barkly, the then governor, was able to state in his speech to the Combined Court in January that its progress was in every way satisfactory. During Governor Barkly's administration the long series of struggles between the legislature and the executive terminated, and when he left in May 1853 he did so with the respect and good-will of all classes. The strengthening of the labour supply was not effected without troubles. In 1847 the negroes in Berbice attacked the persons and property of the Portuguese immigrants, the riots spreading to Demerara and Essequibo, and not until the military were called out were the disturbances quelled. Similar riots in 1861 were only stopped by the prompt and firm action of the new governor, Mr (afterwards Sir) Francis Hincks, while rows between negroes and Chinese and negroes and East Indians were frequent. Gradually, however, things quieted down, and until 1883 the estates as a whole did well. In 1884 the price of sugar fell so seriously as to make the prospects of the colony very gloomy, and for nearly two decades proprietors had to be content with a price kept artificially low by bounty-fed beet-sugar, many estates being ruined, while those that survived only did so by the application of every economy, and by their owners availing themselves of every new discovery in the sciences of cultivation and manufacture.

The year 1880 was marked by an outbreak on the part of a section of the negro population in Georgetown directed against the Portuguese residents there. A Portuguese had murdered his black paramour and had been convicted and sentenced to death. The governor commuted the sentence to penal servitude for life. Shortly after this a Portuguese stall-holder in the market assaulted a small black boy whom he suspected of pilfering, the latter having to be taken to a hospital, while the former, after being taken to a police station was, through some misunderstanding or informality, at once released. Almost immediately excitable and unreasoning negroes were rushing about loudly proclaiming that the boy was dead, that the Portuguese were allowed to kill black people and to go free, and calling on one another to take their own revenge. Mobs gathered quickly, attacked individual Portuguese and wrecked their shops and houses, and not until the city had been given up for two days to scenes of disgraceful disorder were the efforts of the police and special constables successful in quelling the disturbances. The damage done amounted to several thousands of dollars, the Portuguese owners being eventually compensated from general revenue.

In 1884 the dispute as to the boundary with Venezuela became acute. It was reported to the colonial government that the government of Venezuela had granted to an American syndicate a concession which covered much of the territory claimed by Great Britain, and although prompt investigation by an agent despatched by the governor did not then disclose any trace of interference with British claims, a further visit in January 1885, made in consequence of reports that servants of the Manoa Company had torn down notices posted by Mr McTurk on his former visit, discovered that the British notices had been covered over by Venezuelan ones and resulted in the government of Great Britain declaring that it would thenceforward exercise jurisdiction up to and within a boundary known as "the modified Schomburgk line." Outposts were located at points on this line, and for some years Guianese police and Venezuelan soldiers faced one another across the Amacura creek in the Orinoco mouth and at Yuruan up the Cuyuni river. Guianese officers were, however, presumably instructed not actively to oppose acts of aggression by the Venezuelan government, for in January 1895 Venezuelan soldiers arrested Messrs D. D. Barnes and A. H. Baker, inspectors of police in charge at

Yuruan station, conveyed them through Venezuela to Caracas, eventually allowing them to take steamer to Trinidad. For this act compensation was demanded and was eventually paid by Venezuela. The diplomatic question as to the boundary—the results of which are stated above—was passed out of the hands of the colony; see the account of the arbitration under VENEZUELA.

The last two months of 1905 were marked by serious disturbances in Georgetown, and in a lesser degree on the east and west banks of the Demerara river. On the 29th of November the dock labourers employed on the wharves in Georgetown struck for higher wages, and large crowds invaded the principal stores in the city, compelling men willing to work to desist and in some cases assaulting those who opposed them. By the evening of the 30th of November they had got so far out of hand as to necessitate the reading of the Riot Act and a proclamation by the governor (Sir F. M. Hodgson) forbidding all assemblies. On the morning of the 1st of December serious disturbances broke out at Ruimvelt, a sugar estate directly south of Georgetown, where the cane-cutters had suddenly struck for higher pay, and the police were compelled to fire on the mob, killing some and wounding others. All through that day mobs in all parts of the city assaulted any white man they met, houses were invaded and windows smashed, and on two further occasions the police had to fire. At night torrential rains forced the rioters to shelter, and enabled the police to get rest, their places being taken by pickets of militiamen and special constables. On Saturday, the 2nd of December, the police had got the upper hand, and the arrival that night of H.M.S. "Sappho" and on Sunday of H.M.S. "Diamond" gave the government complete control of the situation. Threatened troubles on the sugar estates on the west bank were suppressed by the prompt action of the governor, and the arrest of large numbers of the rioters and their immediate trial by special courts restored their order.

AUTHORITIES.—See Raleigh's *Voyages for the Discovery of Guiana 1595-1596* ("Hakluyt" series); Laurence Keynys' *Relation of the second Voyage to Guiana (1596)* ("Hakluyt" series); Sir R. H. Schomburgk, *Description of British Guiana* (London, 1840); C. Waterton, *Wanderings in South America, 1812-1825* (London, 1828); J. Rodway, *History of British Guiana* (Georgetown, 1891-1894); H. G. Dalton, *History of British Guiana* (London, 1855); J. W. Boddam Whetham, *Roraima and British Guiana* (London, 1879); C. P. Lucas, *Historical Geography of British Colonies*; E. F. im Thurn, *Among the Indians of Guiana* (London, 1883); *British Guiana Directory* (Georgetown, 1906); G. D. Bayley, *Handbook of British Guiana* (Georgetown, 1909). (A. G. B.')

II. DUTCH GUIANA, or Surinam, has an area of about 57,000 sq. m. British Guiana bounds it on the west and French on the east (the long unsettled question of the French boundary is dealt with in section III., Dutch Guiana FRENCH GUIANA). The various peoples inhabiting Surinam are distributed according to the soil and the products. The Indians (Caribs, Arawaks, Warrous) live on the savannahs, or on the upper Nickerie, Coppename and Maroni, far from the plantations, cultivating their fields of manioc or cassava, and for the rest living by fishing and hunting. They number about 2000. The bush negroes (Marrons) dwell between 3° and 4° N., near the isles and cataracts. They are estimated at 10,000, and are employed in the transport of men and goods to the goldfields, the navigation of the rivers in trade with the Indians, and in the transport of wood to Paramaribo and the plantations. They are the descendants of runaway slaves, and before missionaries had worked among them their paganism retained curious traces of their former connexion with Christianity. Their chief god was Gran Gado (grand-god), his wife Maria, and his son Jesi Kist. Various minor deities were also worshipped, Ampuka the bush-god, Toni the water-god, &c. Their language was based on a bastard English, mingled with many Dutch, Portuguese and native elements. Their chiefs are called *grammas* or grand men; but the authority of these men, and the peculiarities of language and religion, have in great measure died out owing to modern intercourse with the Dutch and others. The inhabitants of Paramaribo and the plantations comprise a variety

of races, represented by Chinese, Javanese, coolies from India and the West Indies, negroes and about 2000 whites. Of non-Christian immigrants there are about 6000 Mahomedans and 12,000 Hindus; and Jews number about 1200. The total population was given in 1907 as 84,703, exclusive of Indians; &c., in the forests. Nearly one-half of this total are in Paramaribo and one-half in the districts. The population has shown a tendency to move from the districts to the town; thus in 1852 there were 6000 persons in the town and 32,000 in the districts.

The principal settlements have been made in the lower valley of the Surinam, or between that river and the Saramacca on the W. and the Commewyne on the E. The Surinam is the chief of a number of large rivers which rise in the Tumuc Humac range or the low hills between it and the sea, which they enter on the Dutch seaboard, between the Corentyn and the Maroni (Dutch *Corantijn* and *Marowijne*), which form the boundaries with British and French territories respectively. Between the rivers of Dutch Guiana there are remarkable cross channels available during the floods at least. As the Maroni communicates with the Cottica, which is in turn a tributary of the Commewyne, a boat can pass from the Maroni to Paramaribo; thence by the Sommeldijk canal it can reach the Saramacca; and from the Saramacca it can proceed up the Coppename, and by means of the Nickerie find its way to the Corentyn. The rivers are not navigable inland to any considerable extent, as their courses are interrupted by rapids. The interior of the country consists for the most part of low hills, though an extreme height of 3800 ft. is known in the Wilhelmina Kette, in the west of the colony, about 3° 50' to 4° N. The hinterland south of this latitude, and that part of the Tumuc Humac range along which the Dutch frontier runs, are, however, practically unexplored. Like the other territories of Guiana the Dutch colony is divided physically into a low coast-land, savannahs and almost impenetrable forest.

Meteorological observations have been carried on at five stations (Paramaribo, Coronie, Sommeldijk, Nieuw-Nickerie and Groningen). The mean range of temperature for the day, month and year shows little variation, being respectively 77.54°-88.38° F., 76.12°-78.62° F. and 70.52°-90.14° F. The north-east trade winds prevail throughout the year, but the rainfall varies considerably; for December and January the mean is respectively 8.58 and 9.57 in., for May and June 11.26 and 10.31 in., but for February and March 7.2 and 6.81 in., and for September 2.48 and 2.0 in. The seasons comprise a long and a short dry season, and a period of heavy and of slight rainfall.

Products and Trade.—It has been found exceedingly difficult to exploit the produce of the forests. The most important crops and those supplying the chief exports are cocoa, coffee and sugar, all cultivated on the larger plantations, with rice, maize and bananas on the smaller or coast lands. Most of the larger plantations are situated on the lower courses of the Surinam, Commewyne, Nickerie and Cottica, and on the coast lands, rarely in the upper parts. Goldfields lie in the older rocks (especially the slate) of the upper Surinam, Saramacca and Maroni. The first section of a railway designed to connect the goldfields with Paramaribo was opened in 1906. The annual production of gold amounts in value to about £100,000, but has shown considerable fluctuation. Agriculture is the chief means of subsistence. About 42,000 acres are under cultivation. Of 30,000 persons whose occupation is given in official statistics, close upon 21,000 are engaged in agriculture or on the plantations, 2400 in gold-mining and only 1000 in trade. The exports increased in value from £200,800 in 1875 to £459,800 in 1899, and imports from £260,450 in 1875 to £510,180 in 1899; but the average value of exports over five years subsequently was only £414,000, while that of imports was £531,000.

Administration.—The colony is under a governor, who is president of an executive council, which also includes a vice-president and three members nominated by the crown. The legislative body is the states, the members of which are elected for six years by electors, of whom there is one for every 200 holders of the franchise. The colony is divided into sixteen districts. For the administration of justice there are three cantonal courts, two district courts, and the supreme court at Paramaribo, whose president and permanent members are nominated by the crown. The average local revenue (1901-1906) was about £276,000 and the expenditure about £317,000; both fluctuated considerably, and a varying subvention is necessary

from the home government (£16,000 in 1902, £60,400 in 1906; the annual average is about £37,000). There are a civic guard of about 1800 men and a militia of 500, with a small garrison.

History.—The history of the Dutch in Guiana, and the compression of their influence within its present limits, belongs to the general history of Guiana (above). Surinam and the Dutch islands of the West Indies were placed under a common government in 1828, the governor residing at Paramaribo, but in 1845 they were separated. Slavery was abolished in 1863. Labour then became difficult to obtain, and in 1870 a convention was signed between Holland and England for the regulation of the coolie traffic, and a Dutch government agent for Surinam was appointed at Calcutta. The problem was never satisfactorily solved, but the interest of the mother-country in the colony greatly increased during the last twenty years of the 19th century, as shown by the establishment of the Surinam Association, of the Steam Navigation Company's service to Paramaribo, and by the formation of a botanical garden for experimental culture at that town, as also by geological and other scientific expeditions, and the exhibition at Haarlem in 1898.

AUTHORITIES.—Among the older works on Surinam the first rank is held by Jan Jacob Hartstuck's masterly *Beschryving van Guiana, of de Wilde Kust, in Zuid Amerika* (2 vols., Amsterdam, 1770). Extracts from this work, selected for their bearing upon British boundary questions, were translated and annotated by J. A. J. de Villiers (London, 1897). A valuable *Geschiedenis der Kolonie van Suriname*, by a number of "learned Jews," was published at Amsterdam in 1791; and it was supplemented and so far superseded by Wolbers, *Geschiedenis van Suriname* (Amsterdam, 1861). See further W. G. Palgrave, *Dutch Guiana* (London, 1870); A. Kappler, *Surinam, sein Land, &c.* (Stuttgart, 1887); Prince Roland Bonaparte, *Les Habitans de Suriname* (Paris, 1884); K. Martin, "Bericht über eine Reise ins Gebiet des Obereen-Surinam" *Bijdragen v. h. Inst. voor Taal- en Volkskunde*, i. 1. (The Hague); Westeroen van Meesteren, *La Guyane néerlandaise* (Leiden, 1884); H. Ten Kate, "Een en ander over Suriname," *Gids* (1888); G. Vercluur, "Voyages aux trois Guyanes," *Tour du monde* (1893), pp. 1, 49, 65; W. L. Loth, *Beknopte Aardrijkskundige beschrijving van Suriname* (Amsterdam, 1898), and *Tijdschrift van het Aardrijkskundig Genootschap* (1878), 79, 93; Asch van Wyck, "La Colonie de Surinam," *Les Pays-Bas* (1898); L. Thompson, *Overzicht der Geschiedenis van Suriname* (The Hague, 1901); *Catalogus der Nederl. W. I. ten Toonstelling te Haarlem* (1899); *Guide à travers la section des Indes néerlandaises*, p. 323 (Amsterdam, 1899); *Surinaamsche Almanak* (Paramaribo, annually). For the language of the bush-negroes see Wulfschlaegel, *Kurzgefasste neger-englische Grammatik* (Bautzen, 1854), and *Deutsch-neger-englisches Wörterbuch* (Lobau, 1865).

III. FRENCH GUIANA (GUYANE).—This colony is situated between Dutch Guiana and Brazil. A delimitation of the territory belonging to France and the Netherlands was agreed at in 1801, by decision of the emperor of ^{French} ~~Russia~~ ^{Russia}. This question originated in the arrangement of 1836, that the river Maroni should form the frontier. It turned on the claim of the Awa or the Tapanahoni to be recognized as the main head-stream of the Maroni, and the final decision, in indicating the Awa, favoured the Dutch. In 1905 certain territory lying between the upper Maroni and the Itany, the possession of which had not then been settled, was acquired by France by agreement between the French and Dutch governments. The question of the exploitation of gold in the Maroni was settled by attributing alternate reaches of the river to France and Holland; while France obtained the principal islands in the lower Maroni. The additional territory thus attached to the French colony amounted to 965 sq. m. In December 1900 the Swiss government as arbitrators fixed the boundary between French Guiana and Brazil as the river Oyapock and the watershed on the Tumuc Humac mountains, thus awarding to France about 3000 of the 100,000 sq. m. which she claimed. This dispute was of earlier origin than that with the Dutch; dissensions between the French and the Portuguese relative to territory north of the Amazon occurred in the 17th century; In 1700 the Treaty of Lisbon made the contested area (known as the Terres du Cap du Nord) neutral ground. The treaty of Utrecht in 1713 indicated as the French boundary a river which the French afterwards claimed to be the Araguay, but the Portuguese asserted that the Oyapock was intended. After

Brazil had become independent the question dragged on until 1890-1895 there were collisions in the contested territory between French and Brazilian adventurers. This compelled serious action, and a treaty of arbitration, preliminary to the settlement, was signed at Rio de Janeiro in 1897. French Guiana, according to official estimate, has an area of about 51,000 sq. m. The population is estimated at about 30,000; its movement is not rapid. Of this total 12,350 live at Cayenne, 10,100 were in the communes, 5700 formed the penal population, 1500 were native Indians (Galibi, Emerillon, Oyampfi) and 500 near Maroni were negroes. Apart from Cayenne, which was rebuilt after the great fire of 1888, the centres of population are unimportant: Sinnamarié with 1500 inhabitants, Mana with 1750, Roura with 1200 and Approuague with 1150. In 1892 French Guiana was divided into fourteen communes, exclusive of the Maroni district. Belonging to the colony are also the three Safety Islands (Royale, Joseph and Du Diable—the last notable as the island where Captain Dreyfus was imprisoned), the Enfant Perdu Island and the five Remire Islands.

A considerable portion of the low coast land is occupied by marshes, with a dense growth of mangroves or, in the drier parts, with the pinot or wassay palm (*Euterpe oleracea*). Settlements are confined almost entirely to the littoral and alluvial districts. The forest-clad hills of the hinterland do not generally exceed 1500 ft. in elevation; that part of the Tumuc Humac range which forms the southern frontier may reach an extreme elevation of 2600 ft. But the dense tropical forests attract so much moisture from the ocean winds that the highlands are the birthplace of a large number of rivers which in the rainy season especially pour down vast volumes of water. Not less than 15 are counted between the Maroni and the Oyapock. South-eastward from the Maroni the first of importance is the Mana, which is navigable for large vessels 10 m. from its mouth, and for smaller vessels 27 m. farther. Passing the Sinnamarié and the Kourou, the Oyock is next reached, near the mouth of which is Cayenne, the capital of the colony, and thereafter the Approuague. All these rivers take their rise in a somewhat elevated area about the middle of the colony; those streams which rise farther south, in the Tumuc Humac hills, are tributaries of the two frontier rivers, the Maroni on the one hand or the Oyapock on the other.

Climate and Products.—The rainy season begins in November or December, and lasts till the latter part of June; but there are usually three or four weeks of good weather in March. During the rest of the year there is often hardly a drop of rain for months, but the air is always very moist. At Cayenne the average annual rainfall amounts to fully 130 in., and it is naturally heavier in the interior. During the hotter part of the year—August, September, October—the temperature usually rises to about 86° F., but it hardly ever exceeds 88°; in the colder season the mean is 79° and it seldom sinks so low as 70°. Between day and night there is very little thermometric difference. The prevailing winds are the N.N.E. and the S.E.; and the most violent are those of the N.E. During the rainy season the winds keep between N. and E., and during the dry season between S. and E. Hurricanes are unknown. The flora and fauna French Guiana resembles the rest of the Guianese region. Vegetation is excessively rich. Among leguminous trees, which are abundantly represented, the wacapou is the finest of many hardwood trees. Caoutchouc and various palms are also common. The manioc is a principal source of food; rice is an important object of cultivation; and maize, yams, arrowroot, bananas and the bread-fruit are also to be mentioned. Vanilla is one of the common wild plants of the country. The clove tree has been acclimatized, and in the latter years of the empire it formed a good source of wealth; the cinnamon tree was also successfully introduced in 1772, but like that of the pepper-tree and the nutmeg its cultivation is neglected. A very small portion of the territory indeed is devoted to agriculture, although France has paid some attention to the development of this branch of activity. In 1880 a colonial garden was created near Cayenne; since 1894 an experimental garden has been laid out at Baduel. About 8000 acres are cultivated, of which 5400 acres are under cereals and rice, the remaining being under coffee (introduced in 1716), cacao, cane and other cultures. The low lands between Cayenne and Oyapock are capable of bearing colonial produce, and the savannahs might support large herds; cereals, root-crops and vegetables might easily be grown on the high grounds, and timber working in the interior should be profitable.

Gold-mining is the most important industry in the colony. Places of great wealth have been discovered on the Awa, on the Dutch frontier; and at Carseventin in the territory which formed the subject of the Franco-Brazilian dispute. But wages are high and transport is costly, and the amount of gold declared at Cayenne did not average more than 130,550 oz. annually in 1900-1905. Silver and iron have been found in various districts; kaolin is extracted in the plains of Moatsinéry; and phosphates have been discovered

at several places. Besides gold-workings, the industrial establishments comprise saw-mills, distilleries, brick-works and sugar-works.

Trade and Communications.—The commerce in 1885 amounted to £135,000 for imports and to £144,000 for exports; in 1897 the values were respectively £375,350 and £286,400, but in 1903, while imports had increased in value only to £418,720, exports had risen to £493,213. The imports consist of wines, flour, clothes, &c.; the chief are gold, phosphates, timber, cocoa and rosewood essence. Cayenne is the only considerable port. One of the drawbacks to the development of the colony is the lack of labour. Native labour is most difficult to obtain, and attempts to utilize convict labour have not proved very successful. Efforts to supply the need by immigration have not done so completely. The land routes are not numerous. The most important are that from Cayenne to Mana by way of Kourou, Sinnamarié and Iracoubo, and that from Cayenne along the coast to Kaw and the mouth of the Approuague. Towards the interior there are only foot-paths, badly made. By water, Cayenne is in regular communication with the Safety Islands (35 m.), and the mouth of the Maroni (80 m.), with Fort de France in the island of Martinique, where travellers meet the mail packet for France, and with Boston (U.S.A.). There is a French cable between Cayenne and Brest.

Administration.—The colony is administered by a commissioner-general assisted by a privy council, including the secretary general and chief of the judicial service, the military, penitentiary and administrative departments. In 1879 an elective general council of sixteen members was constituted. There are a tribunal of first instance and a higher tribunal at Cayenne, besides four justices of peace, one of whom has extensive jurisdiction in other places. Of the £256,000 demanded for the colony in the colonial budget for 1906, £235,000 represented the estimated expenditure on the penal settlement, so that the cost of the colony was only about £21,000. The local budget for 1903 balanced at £92,000 and in 1905 at £116,450. Instruction is given in the college of Cayenne and in six primary schools. At the head of the clergy is an apostolic prefect. The armed force consists of two companies of marine infantry, half a battery of artillery, and a detachment of gendarmierie, and comprises about 380 men. The penal settlement was established by a decree of 1852. From that year until 1867, 18,000 exiles had been sent to Guiana, but for the next twenty years New Caledonia became the chief penal settlement in the French colonies. But in 1865-1887 French Guiana was appointed as a place of banishment for confirmed criminals and for convicts sentenced to more than eight years' hard labour. A large proportion of these men have been found unfit for employment upon public works.

History.—The Sieur La Revardière, sent out in 1604 by Henry IV. to reconnoitre the country, brought back a favourable report; but the death of the king put a stop to the projects of formal colonization. In 1626 a small body of traders from Rouen settled on the Sinnamarié, and in 1635 a similar band founded Cayenne. The Compagnie du Cap Nord, founded by the people of Rouen in 1643 and conducted by Poncet de Brétigny, the Compagnie de la France Équinoxiale, established in 1645, and the second Compagnie de la France Équinoxiale, or Compagnie des Douze Seigneurs, established in 1652, were failures, the result of incompetence, mismanagement and misfortune. From 1654 the Dutch held the colony for a few years. The French Compagnie des Indes Occidentales, chartered in 1664 with a monopoly of Guiana commerce for forty years, proved hardly more successful than its predecessors; but in 1674 the colony passed under the direct control of the crown, and the able administration of Colbert began to tell favourably on its progress, although in 1686 an unsuccessful expedition against the Dutch in Surinam set back the advance of the French colony until the close of the century.

The year 1763 was marked by a terrible disaster. Choiseul, the prime minister, having obtained for himself and his cousin Praslin a concession of the country between the Kourou and the Maroni, sent out about 12,000 volunteer colonists, mainly from Alsace and Lorraine. They were landed at the mouth of the Kourou, where no preparation had been made for their reception, and where even water was not to be obtained. Mismanagement was complete; there was (for example) a shop for skates, whereas the necessary tools for tillage were wanting. By 1765 no more than 918 colonists remained alive, and these were a famished fever-stricken band. A long investigation in Paris resulted in the imprisonment of the incompetent leaders of the expedition. Several minor attempts at colonization in Guiana were made in the latter part of the century; but they

all seemed to suffer from the same fatal prestige of failure. During the revolution band after band of political prisoners were transported to Guiana. The fate of the royalists, nearly 600 in number, who were exiled on the 18th Fructidor (1797), was especially sad. Landed on the Sinnamary without shelter or food, two-thirds of them perished miserably. In 1800 Victor Hugues was appointed governor, and he managed to put the colony in a better state; but in 1809 his work was brought to a close by the invasion of the Portuguese and British.

Though French Guiana was nominally restored to the French in 1814, it was not really surrendered by the Portuguese till 1817. Numerous efforts were now made to establish the colony firmly, although its past misfortunes had prejudiced the public mind in France against it. In 1822 the first steam sugar mills were introduced; in 1824 an agricultural colony (Nouvelle Angoulême) was attempted in the Mana district, which, after failure at first, became comparatively successful. The emancipation of slaves and the consequent dearth of labour almost ruined the development of agricultural resources about the middle of the century, but in 1853 a large body of African immigrants was introduced. The discovery of gold on the Approuague in 1855 caused feverish excitement, and seriously disturbed the economic condition of the country.

AUTOBIOGRAPHY.—A detailed bibliography of French Guiana will be found in Teraux-Compans, *Notice historique de la Guyane française* (Paris, 1843). Among more recent works, see E. Basalès, *Notice sur la Guyane*, issued on the occasion of the Paris Exhibition (1900); *Publications de la société d'études pour la colonisation de la Guyane française* (Paris, 1843-1844); H. A. Couderc, *La France équinoxiale* (1887); *Dialectes indiens de Guyane* (1891); *Deux ans de Guyane* (1899); and *Chez nos Indiens* (1893), all at Paris; G. Brousseau, *Les Richesses de la Guyane française* (Paris, 1901); L. F. Viala, *Les Trois Guyanes* (Montpellier, 1893).

GUIART (or **GUIARD**), **GUILLAUME** (d. c. 1316), French chronicler and poet, was probably born at Orleans, and served in the French army in Flanders in 1304. Having been disabled by a wound he began to write, lived at Arras and then in Paris, thus being able to consult the large store of manuscripts in the abbey of St Denis, including the *Grandes chroniques de France*. Afterwards he appears as a *ménétrier de bouche*. Guiart's poem *Branche des royaux lignages*, was written and then rewritten between 1304 and 1307, in honour of the French king Philip IV., and in answer to the aspersions of a Flemish poet. Comprising over 21,000 verses it deals with the history of the French kings from the time of Louis VIII.; but it is only really important for the period after 1296 and for the war in Flanders from 1301 to 1304, of which it gives a graphic account, and for which it is a high authority. It was first published by J. A. Buchon (Paris, 1828), and again in tome xxiii. of the *Recueil des historiens des Gaules et de la France* (Paris, 1865).

See A. Molinier, *Les Sources de l'histoire de France*, tome iii. (Paris, 1903).

GUIBERT, or **WIBERT** (c. 1030-1100), of Ravenna, antipope under the title of Clement III. from the 25th of June 1080 until September 1100, was born at Parma between 1020 and 1030 of the noble imperialist family, Corregio. He entered the priesthood and was appointed by the empress Agnes, chancellor and, after the death of Pope Victor II. (1057), imperial vicar in Italy. He strove to uphold the imperial authority during Henry IV.'s minority, and presided over the synod at Basel (1061) which annulled the election of Alexander II. and created in the person of Cadalus, bishop of Parma, the antipope Honorius II. Guibert lost the chancellorship in 1062. In 1073, through the influence of Empress Agnes and the support of Cardinal Hildebrand, he obtained the archbishopric of Ravenna and swore fealty to Alexander II. and his successors. He seems to have been at first on friendly terms with Gregory VII., but soon quarrelled with him over the possession of the city of Imola, and henceforth was recognized as the soul of the imperial faction in the investiture contest. He allied himself with Cencius, Cardinal Candidus and other opponents of Gregory at Rome, and, on his refusal to furnish troops or to attend the Lenten synod of 1075, he was ecclesiastically suspended by the pope. He was probably excommunicated at the synod of Worms

(1076) with other Lombard bishops who sided with Henry IV., and at the Lenten synod of 1078 he was banned by name. The emperor, having been excommunicated for the second time in March 1080, convened nineteen bishops of his party at Mainz on the 31st of May, who pronounced the deposition of Gregory; and on the 25th of June he caused Guibert to be elected pope by thirty bishops assembled at Brixen. Guibert, whilst retaining possession of his archbishopric, accompanied his imperial master on most of the latter's military expeditions. Having gained Rome, he was installed in the Lateran and consecrated as Clement III. on the 24th of March 1084. One week later, on Easter Sunday, he crowned Henry IV. and Bertha in St Peter's. Clement survived not only Gregory VII. but also Victor III. and Urban II., maintaining his title to the end and in great measure his power over Rome and the adjoining regions. Excommunication was pronounced against him by all his rivals. He was driven out of Rome finally by crusaders in 1097, and sought refuge in various fortresses on his own estates. St Angelo, the last Guibertist stronghold in Rome, fell to Urban II. on the 24th of August 1098. Clement, on the accession of Paschal II. in 1099, prepared to renew his struggle but was driven from Albano by Norman troops and died at Civita Castellana in September 1100. His ashes, which were said by his followers to have worked miracles, were thrown into the water by Paschal II.

See J. Langen, *Geschichte der römischen Kirche von Gregor VII. bis Innocenz III.* (Boon, 1893); Jaffé-Wattenbach, *Regesta pontificum Romanorum*, (2nd ed., 1885-1888); K. J. von Hefele, *Conciliengeschichte*, vol. v. (2nd ed.); F. Gregorovius, *Rome in the Middle Ages*, vol. iv., trans. by Mrs G. W. Hamilton (London, 1900-1902); and O. Köhneke, *Wibert von Ravenna* (Leipzig, 1888). (C. H. HA.)

GUIBERT (1053-1124), of Nogent, historian and theologian, was born of noble parents at Clermont-en-Beauvoisis, and dedicated from infancy to the church. He received his early education at the Benedictine abbey of Flavigny (Flaviacum) or St Germer, where he studied with great zeal, devoting himself at first to the secular poets, an experience which left its imprint on his works; later changing to theology, through the influence of Anselm of Bec, afterwards of Canterbury. In 1104, he was chosen to be head of the abbey of Notre Dame de Nogent and henceforth took a prominent part in ecclesiastical affairs. His autobiography (*De vita sua, sive monodiarum*), written towards the close of his life, gives many picturesque glimpses of his time and the customs of his country. The description of the commune of Laon is an historical document of the first order. The same local colour lends charm to his history of the first crusade (*Gesta Dei per Francos*) written about 1110. But the history is largely a paraphrase, in ornate style, of the *Gesta Francorum* of an anonymous Norman author (see *CRUSADES*); and when he comes to the end of his authority, he allows his book to degenerate into an undigested heap of notes and anecdotes. At the same time his high birth and his position in the church give his work an occasional value.

BIBLIOGRAPHY.—Guibert's works, edited by d'Achery, were first published in 1651, in 1 vol. folio, at Paris (*Venerabilis Guiberti abbatis B. Marialis de Novigento opera omnia*), and republished in Migne's *Patrologia Latina*, vols. clvi. and clxxiv. They include, besides minor works, a treatise on homiletics ("Liber quo ordine sermo fieri debeat"); ten books of *Moralia* on Genesis, begun in 1084, but not completed until 1116, composed on the model of Gregory the Great's *Moralia in Jobum*; five books of *Tropologiae* on Hosea, Amos and the Lamentations; a treatise on the *Incarnation*, against the Jews; four books *De pigmentibus sanctorum*, a remarkably free criticism on the abuses of saint and relic worship; three books of autobiography, *De vita sua, sive monodiarum*; and eight books of the *Historia quae dicitur Gesta Dei per Francos, sive Historia Hierosolymitana* (the ninth book is by another author). Separate editions exist of the last named, in J. Bongars, *Gesta Dei per Francos*, i., and *Recueil des historiens des croisades, hist. Occid.*, iv. 115-263. It has been translated into French in Guizot's *Collection*, ix. 1-338. See H. von Sybel, *Geschichte des ersten Kreuzzuges* (Leipzig, 1881); B. Monod, *Le Moine Guibert et son temps* (Paris, 1905); and *Guibert de Nogent; histoire de sa vie*, edited by G. Bourgin (Paris, 1907).

GUIBERT, JACQUES ANTOINE HIPPOLYTE, COMTE DE (1743-1790), French general and military writer, was born at Montauban, and at the age of thirteen accompanied his father, Charles Bénéot, comte de Guibert (1715-1786), chief of staff to

Marshal de Broglie, throughout the war in Germany, and won the cross of St Louis and the rank of colonel in the expedition to Corsica (1767). In 1770 he published his *Essai général de tactique* in London, and this celebrated work appeared in numerous subsequent editions and in English, German and even Persian translations (extracts also in Liskenne and Sauvan, *Bibl. historique et militaire*, Paris, 1845). Of this work (for a detailed critique of which see Max Jähns, *Gesch. d. Kriegswissenschaften*, vol. iii. pp. 2058-2070 and references therein) it may be said that it was the best essay on war produced by a soldier during a period in which tactics were discussed even in the salon and military literature was more abundant than at any time up to 1871. Apart from technical questions, in which Guibert's enlightened conservatism stands in marked contrast to the doctrinaire progressiveness of Menil Durand, Foillard and others, the book is chiefly valued for its broad outlook on the state of Europe, especially of military Europe in the period 1763-1792. One quotation may be given as being a most remarkable prophecy of the impending revolution in the art of war, a revolution which the "advanced" tacticians themselves scarcely foresaw. "The standing armies, while a burden on the people, are inadequate for the achievement of great and decisive results in war, and meanwhile the mass of the people, untrained in arms, degenerates. . . . The hegemony over Europe will fall to that nation which . . . becomes possessed of manly virtues and creates a national army"—a prediction fulfilled almost to the letter within twenty years of Guibert's death. In 1773 he visited Germany and was present at the Prussian regimental drills and army manoeuvres; Frederick the Great, recognizing Guibert's ability, showed great favour to the young colonel and freely discussed military questions with him. Guibert's *Journal d'un voyage en Allemagne* was published, with a memoir, by Toulougeon (Paris, 1803). His *Défense du système de guerre moderne*, a reply to his many critics (Neuchâtel, 1779) is a reasoned and scientific defence of the Prussian method of tactics, which formed the basis of his work when in 1775 he began to co-operate with the count de St Germain in a series of much-needed and successful reforms in the French army. In 1777, however, St Germain fell into disgrace, and his fall involved that of Guibert who was promoted to the rank of *maréchal de camp* and relegated to a provincial staff appointment. In his semi-retirement he vigorously defended his old chief St Germain against his detractors. On the eve of the Revolution he was recalled to the War Office, but in his turn he became the object of attack and he died, practically of disappointment, on the 6th of May 1790. Other works of Guibert, besides those mentioned, are: *Observations sur la constitution politique et militaire des armées de S. M. Prussienne* (Amsterdam, 1778); *Éloges of Marshal Catinat* (1775); of Michel de l'Hôpital (1778), and of Frederick the Great (1787). Guibert was a member of the Academy from 1786, and he also wrote a tragedy, *Le Comte de Bourbon* (1775) and a journal of travels in France and Switzerland.

See Toulougeon, *Éloge véritable de Guibert* (Paris, 1790); Madame de Stael, *Éloge de Guibert*; Bardin, *Notice historique du général Guibert* (Paris, 1836); Flavien d'Aldeguier, *Discours sur la vie et les écrits du comte de Guibert* (Toulouse, 1855); Count Forestie, *Biographie du comte de Guibert* (Montauban, 1855); Count zur Lippe, "Friedr. der Grosse und Oberst Guibert" (*Militär-Wochenblatt*, 1873, 9 and 10).

GUICCIARDINI, FRANCESCO (1483-1540), the celebrated Italian historian and statesman, was born at Florence in the year 1483, when Marsilio Ficino held him at the font of baptism. His family was illustrious and noble; and his ancestors for many generations had held the highest posts of honour in the state, as may be seen in his own genealogical *Ricordi autobiografici e di famiglia* (*Op. ined.* vol. x.). After the usual education of a boy in grammar and elementary classical studies, his father, Piero, sent him to the universities of Ferrara and Padua, where he stayed until the year 1505. The death of an uncle, who had occupied the see of Cortona with great pomp, induced the young Guicciardini to hanker after an ecclesiastical career. He already saw the scarlet of a cardinal awaiting him, and to

this eminence he would assuredly have risen. His father, however, checked this ambition, declaring that, though he had five sons, he would not suffer one of them to enter the church in its then state of corruption and debasement. Guicciardini, whose motives were confessedly ambitious (see *Ricordi*, *Op. ined.* x. 68), turned his attention to law, and at the age of twenty-three was appointed by the Signoria of Florence to read the *Institutes* in public. Shortly afterwards he engaged himself in marriage to Maria, daughter of Alamanno Salviati, prompted, as he frankly tells us, by the political support which an alliance with that great family would bring him (*ib.* x. 71). He was then practising at the bar, where he won so much distinction that the Signoria, in 1512, entrusted him with an embassy to the court of Ferdinand the Catholic. Thus he entered on the real work of his life as a diplomatist and statesman. His conduct upon that legation was afterwards severely criticized; for his political antagonists accused him of betraying the true interests of the commonwealth, and using his influence for the restoration of the exiled house of Medici to power. His Spanish correspondence with the Signoria (*Op. ined.* vol. vi.) reveals the extraordinary power of observation and analysis which was a chief quality of his mind; and in Ferdinand, hypocritical and profoundly dissimulative, he found a proper object for his scientific study. To suppose that the young statesman learned his frigid statecraft in Spain would be perhaps too simple a solution of the problem offered by his character, and scarcely fair to the Italian proficients in perfidy. It is clear from Guicciardini's autobiographical memoirs that he was ambitious, calculating, avaricious and power-loving from his earliest years; and in Spain he had no more than an opportunity of studying on a large scale those political vices which already ruled the minor potentates of Italy. Still the school was pregnant with instructions for so apt a pupil. Guicciardini issued from this first trial of his skill with an assured reputation for diplomatic ability, as that was understood in Italy. To unravel plots and weave counterplots; to meet treachery with fraud; to parry force with sleights of hand; to credit human nature with the basest motives, while the blackest crimes were contemplated with cold enthusiasm for their cleverness, was reckoned then the height of political sagacity. Guicciardini could play the game to perfection. In 1515 Leo X. took him into service, and made him governor of Reggio and Modena. In 1521 Parma was added to his rule, and in 1523 he was appointed viceregent of Romagna by Clement VII. These high offices rendered Guicciardini the virtual master of the papal states beyond the Apennines, during a period of great bewilderment and difficulty. The copious correspondence relating to his administration has recently been published (*Op. ined.* vols. vii., viii.). In 1526 Clement gave him still higher rank as lieutenant-general of the papal army. While holding this commission, he had the humiliation of witnessing from a distance the sack of Rome and the imprisonment of Clement, without being able to rouse the perfidious duke of Urbino into activity. The blame of Clement's downfall did not rest with him; for it was merely his duty to attend the camp, and keep his master informed of the proceedings of the generals (see the Correspondence, *Op. ined.* vols. iv., v.). Yet Guicciardini's conscience accused him, for he had previously counselled the pope to declare war, as he notes in a curious letter to himself written in 1527 (*Op. ined.*, x. 104). Clement did not, however, withdraw his confidence, and in 1531 Guicciardini was advanced to the governorship of Bologna, the most important of all the papal lord-lieutenancies (Correspondence, *Op. ined.* vol. ix.). This post he resigned in 1534 on the election of Paul III., preferring to follow the fortunes of the Medicean princes. It may here be noticed that though Guicciardini served three popes through a period of twenty years, or perhaps because of this, he hated the papacy with a deep and frozen bitterness, attributing the woes of Italy to the ambition of the church, and declaring he had seen enough of sacerdotal abominations to make him a Lutheran (see *Op. ined.* i. 27, 104, 96, and *Ist. d' It.*, ed. Ros., ii. 218). The same discord between his private opinions and his public actions may be traced in his conduct subsequent to 1534. As a

political theorist, Guicciardini believed that the best form of government was a commonwealth administered upon the type of the Venetian constitution (*Op. ined.* i 6; ii. 130 sq.); and we have ample evidence to prove that he had judged the tyranny of the Medici at its true worth (*Op. ined.* i. 171, on the tyrant; the whole *Storia Fiorentina* and *Reggimento di Firenze*, ib. i. and iii., on the Medici). Yet he did not hesitate to place his powers at the disposal of the most vicious members of that house for the enslavement of Florence. In 1527 he had been declared a rebel by the Signoria on account of his well-known Medicean prejudices; and in 1530, deputed by Clement to punish the citizens after their revolt, he revenged himself with a cruelty and an avarice that were long and bitterly remembered. When, therefore, he returned to inhabit Florence in 1534, he did so as the creature of the dissolute Alessandro de' Medici. Guicciardini pushed his servility so far as to defend this infamous despot at Naples in 1535, before the bar of Charles V., from the accusations brought against him by the Florentine exiles (*Op. ined.* vol. ix.). He won his cause; but in the eyes of all posterity he justified the reproaches of his contemporaries, who describe him as a cruel, venal, grasping seeker after power, eager to support a despotism for the sake of honours, offices and emoluments secured for himself by a bargain with the oppressors of his country. Varchi, Nardi, Jacopo Pitti and Bernardo Segni are unanimous upon this point, but it is only the recent publication of Guicciardini's private MSS. that has made us understand the force of their invectives. To plead loyalty or honest political conviction in defence of his Medicean partisanship is now impossible, face to face with the opinions expressed in the *Ricordi politici* and the *Storia Fiorentina*. Like Machiavelli, but on a lower level, Guicciardini was willing to "roll stones," or to do any dirty work for masters whom, in the depth of his soul, he detested and despised. After the murder of Duke Alessandro in 1537, Guicciardini espoused the cause of Cosimo de' Medici, a boy addicted to field sports, and unused to the game of statecraft. The wily old diplomatist hoped to rule Florence as grand vizier under this inexperienced princeling. He was mistaken, however, in his schemes, for Cosimo displayed the genius of his family for politics, and coldly dismissed his would-be lord-protector. Guicciardini retired in disgrace to his villa, where he spent his last years in the composition of the *Storia d'Italia*. He died in 1540 without male heirs.

Guicciardini was the product of a cynical and selfish age, and his life illustrated its sordid influences. Of a cold and worldly temperament, devoid of passion, blameless in his conduct as the father of a family, faithful as the servant of his papal patrons; severe in the administration of the provinces committed to his charge, and indisputably able in his conduct of affairs, he was at the same time, and in spite of these qualities, a man whose moral nature inspires a sentiment of liveliest repugnance. It is not merely that he was ambitious, cruel, revengeful and avaricious, for these vices have existed in men far less antipathetic than Guicciardini. Over and above those faults, which made him odious to his fellow-citizens, we trace in him a meanness that our century is less willing to condone. His phlegmatic and persistent egotism, his sacrifice of truth and honour to self-interest, his acquiescence in the worst conditions of the world, if only he could use them for his own advantage, combined with the glaring discord between his opinions and his practice, form a character which would be contemptible in our eyes were it not so sinister. The social and political decrepitude of Italy, where patriotism was unknown, and only selfishness survived of all the motives that rouse men to action, found its representative and exponent in Guicciardini. When we turn from the man to the author, the decadence of the age and race that could develop a political philosophy so arid in its cynical despair of any good in human nature forces itself vividly upon our notice. Guicciardini seems to glory in his disillusionment, and uses his vast intellectual ability for the analysis of the corruption he had helped to make incurable. If one single treatise of that century should be chosen to represent the spirit

of the Italian people in the last phase of the Renaissance, the historian might hesitate between the *Principe* of Machiavelli and the *Ricordi politici* of Guicciardini. The latter is perhaps preferable to the former on the score of comprehensiveness. It is, moreover, more exactly adequate to the actual situation, for the *Principe* has a divine spark of patriotism yet lingering in the cinders of its frigid science, an idealistic enthusiasm surviving in its moral aberrations, whereas a great Italian critic of this decade has justly described the *Ricordi* as "Italian corruption codified and elevated to a rule of life." Guicciardini is, however, better known as the author of the *Storia d'Italia*, that vast and detailed picture of his country's sufferings between the years 1494 and 1532. Judging him by this masterpiece of scientific history, he deserves less commendation as a writer than as a thinker and an analyst. The style is wearisome and prolix, attaining to precision at the expense of circumlocution, and setting forth the smallest particulars with the same distinctness as the main features of the narrative. The whole tangled skein of Italian politics, in that involved and stormy period, is unravelled with a patience and an insight that are above praise. It is the crowning merit of the author that he never ceases to be an impartial spectator—a cold and curious critic. We might compare him to an anatomist, with knife and scalpel dissecting the dead body of Italy, and pointing out the symptoms of her manifold diseases with the indifferent analysis of one who has no moral sensibility. This want of feeling, while it renders Guicciardini a model for the scientific student, has impaired the interest of his history. Though he lived through that agony of the Italian people, he does not seem to be aware that he is writing a great historical tragedy. He takes as much pains in laying bare the trifling causes of a petty war with Pisa as in probing the deep-seated ulcer of the papacy. Nor is he capable of painting the events in which he took a part, in their totality as a drama. Whatever he touches, lies already dead on the dissecting table, and his skill is that of the analytical pathologist. Consequently, he fails to understand the essential magnitude of the task, or to appreciate the vital vigour of the forces contending in Europe for mastery. This is very noticeable in what he writes about the Reformation. Notwithstanding these defects, inevitable in a writer of Guicciardini's temperament, the *Storia d'Italia* was undoubtedly the greatest historical work that had appeared since the beginning of the modern era. It remains the most solid monument of the Italian reason in the 16th century, the final triumph of that Florentine school of philosophical historians which included Machiavelli, Segni, Pitti, Nardi, Varchi, Francesco Vettori and Donato Giannotti. Up to the year 1857 the fame of Guicciardini as a writer, and the estimation of him as a man, depended almost entirely upon the *History of Italy*, and on a few ill-edited extracts from his aphorisms. At that date his representatives, the counts Piero and Luigi Guicciardini, opened their family archives, and committed to Signor Giuseppe Canestrini the publication of his hitherto inedited MSS. in ten important volumes. The vast mass of documents and finished literary work thus given to the world has thrown a flood of light upon Guicciardini, whether we consider him as author or as citizen. It has raised his reputation as a political philosopher into the first rank, where he now disputes the place of intellectual supremacy with his friend Machiavelli; but it has coloured our moral judgment of his character and conduct with darker dyes. From the stores of valuable materials contained in those ten volumes, it will be enough here to cite (1) the *Ricordi politici*, already noticed, consisting of about 400 aphorisms on political and social topics; (2) the observations on Machiavelli's *Discorsi*, which bring into remarkable relief the views of Italy's two great theorists on statecraft in the 16th century, and show that Guicciardini regarded Machiavelli somewhat as an amiable visionary or political enthusiast; (3) the *Storia Fiorentina*, an early work of the author, distinguished by its animation of style, brilliancy of portraiture, and liberality of judgment; and (4) the *Dialogo del reggimento di Firenze*, also in all probability an early work, in which the various forms of government suited to an Italian

commonwealth are discussed with infinite subtlety, contrasted, and illustrated from the vicissitudes of Florence up to the year 1494. To these may be added a series of short essays, entitled *Discorsi politici*, composed during Guicciardini's Spanish legation. It is only after a careful perusal of these minor works that the student of history may claim to have comprehended Guicciardini, and may feel that he brings with him to the consideration of the *Storia d'Italia* the requisite knowledge of the author's private thoughts and jealously guarded opinions. Indeed, it may be confidently affirmed that those who desire to gain an insight into the true principles and feelings of the men who made and wrote history in the 16th century will find it here far more than in the work designed for publication by the writer. Taken in combination with Machiavelli's treatises, the *Opere inedite* furnish a comprehensive body of Italian political philosophy anterior to the date of Fra Paolo Sarpi. (J. A. S.)

See Rosini's edition of the *Storia d'Italia* (10 vols., Pisa, 1819), and the *Opere inedite*, in 10 vols., published at Florence, 1857. A complete and initial edition of Guicciardini's works is now in preparation in the hands of Alessandro Gherardini of the Florence archives. Among the many studies on Guicciardini we may mention Agostino Rossi's *Francesco Guicciardini e il governo Fiorentino* (2 vols., Bologna, 1896), based on many new documents; F. de Sanctis's essay "L'Uomo del Guicciardini," in his *Nuovi Saggi critici* (Naples, 1879), and many passages in Professor P. Villari's *Machiavelli* (Eng. trans., 1893); E. Benoit's *Guichardin, historien et homme d'état italien au XVI^e siècle* (Paris, 1862), and C. Gioda's *Francesco Guicciardini e le sue opere inedite* (Bologna, 1880) are not without value, but the authors had not had access to many important documents since published. See also Geoffroy's article "Une Autobiographie de Guichardin d'après ses œuvres inédites," in the *Revue des deux mondes* (1st of February 1874).

GUICHARD, KARL GOTTLIEB (1724-1775), soldier and military writer, known as **QUINTUS ICIILIUS**, was born at Magdeburg in 1724, of a family of French refugees. He was educated for the Church, and at Leiden actually preached a sermon as a candidate for the pastorate. But he abandoned theology for more secular studies, especially that of ancient history, in which his learning attracted the notice of the prince of Orange, who promised him a vacant professorship at Utrecht. On his arrival, however, he found that another scholar had been elected by the local authorities, and he thereupon sought and obtained a commission in the Dutch army. He made the campaigns of 1747-48 in the Low Countries. In the peace which followed, his combined military and classical training turned his thoughts in the direction of ancient military history. His notes on this subject grew into a treatise, and in 1754 he went over to England in order to consult various libraries. In 1757 his *Mémoires militaires sur les Grecs et les Romains* appeared at the Hague, and when Carlyle wrote his *Frederick the Great* it had reached its fifth edition. Coming back, with English introductions, to the Continent, he sought service with Ferdinand of Brunswick, who sent him on to Frederick the Great, whom he joined in January 1758 at Breslau. The king was very favourably impressed with Guichard and his works, and he remained for nearly 18 months in the royal suite. His Prussian official name of Quintus Icilus was the outcome of a friendly dispute with the king (see Nikolai, *Anekdoten*, vi. 120-145; Carlyle, *Frederick the Great*, viii. 113-114). Frederick in discussing the battle of Pharsalia spoke of a centurion Quintus Caecilius as Q. Icilus. Guichard ventured to correct him, whereupon the king said, "You shall be Quintus Icilus," and as Major Quintus Icilus he was forthwith gazetted to the command of a free battalion. This corps he commanded throughout the later stages of the Seven Years' War, his battalion, as time went on, becoming a regiment of three battalions, and Quintus himself recruited seven more battalions of the same kind of troops. His command was almost always with the king's own army in these campaigns, but for a short time it fought in the western theatre under Prince Henry. When not on the march he was always at the royal headquarters, and it was he who brought about the famous interview between the king and Gellert (see Carlyle, *Frederick the Great*, ix. 109; Gellert, *Briefwechsel mit Demosthelo Lucius*, ed. Ebert, Leipzig, 1823, pp. 620-631) on the subject of national German literature. On 22nd January 1761 Quintus was ordered to sack the castle

of Hubertsburg (a task which Major-General Saldern had point-blank refused to undertake, from motives of conscience), and carried out his task, it is said, to his own very considerable profit. The place cannot have been seriously injured, as it was soon afterwards the meeting-place of the diplomatists whose work ended in the peace of Hubertsburg, but the king never ceased to banter Quintus on his supposed depredations. The very day of Frederick's triumphant return from the war saw the disbanding of most of the free battalions, including that of Quintus, but the major to the end of his life remained with the king. He was made lieutenant-colonel in 1765, and in 1773, in recognition of his work *Mémoires critiques et historiques sur plusieurs points d'antiquité militaires*, dealing mainly with Cæsar's campaigns in Spain (Berlin, 1773), was promoted colonel. He died at Potsdam, 1775.

GUICHEN, LUC URBAIN DE BOUËNIC, COMTE DE (1712-1790), French admiral, entered the navy in 1730 as "garde de la Marine," the first rank in the corps of royal officers. His promotion was not rapid. It was not till 1748 that he became "lieutenant de vaisseau," which was, however, a somewhat higher rank than the lieutenant in the British navy, since it carried with it the right to command a frigate. He was "capitaine de vaisseau," or post captain, in 1756. But his reputation must have been good, for he was made chevalier de Saint Louis in 1748. In 1775 he was appointed to the frigate "Terpsichore," attached to the training squadron, in which the duc de Chartres, afterwards notorious as the duc d'Orléans and as Philippe Égalité, was entered as volunteer. In the next year he was promoted chef d'escadre, or rear-admiral. When France had become the ally of the Americans in the War of Independence, he hoisted his flag in the Channel fleet, and was present at the battle of Ushant on the 27th of July 1779. In March of the following year he was sent to the West Indies with a strong squadron and was there opposed to Sir George Rodney. In the first meeting between them on the 12th of April to leeward of Martinique, Guichen escaped disaster only through the clumsy manner in which Sir George's orders were executed by his captains. Seeing that he had to deal with a formidable opponent, Guichen acted with extreme caution, and by keeping the weather gauge afforded the British admiral no chance of bringing him to close action. When the hurricane months approached (July to September) he left the West Indies, and his squadron, being in a bad state from want of repairs, returned home, reaching Brest in September. Throughout all this campaign Guichen had shown himself very skilful in handling a fleet, and if he had not gained any marked success, he had prevented the British admiral from doing any harm to the French islands in the Antilles. In December 1781 the comte de Guichen was chosen to command the force which was entrusted with the duty of carrying stores and reinforcements to the West Indies. On the 12th Admiral Kempenfelt, who had been sent out by the British Government with an unduly weak force to intercept him, sighted the French admiral in the Bay of Biscay through a temporary clearance in a fog, at a moment when Guichen's warships were to leeward of the convoy, and attacked the transports at once. The French admiral could not prevent his enemy from capturing twenty of the transports, and driving the others into a panic-stricken flight. They returned to port, and the mission entrusted to Guichen was entirely defeated. He therefore returned to port also. He had no opportunity to gain any counterbalancing success during the short remainder of the war, but he was present at the final relief of Gibraltar by Lord Howe. His death occurred on the 13th of January 1790. The comte de Guichen was, by the testimony of his contemporaries, a most accomplished and high-minded gentleman. It is probable that he had more scientific knowledge than any of his English contemporaries and opponents. But as a commander in war he was notable chiefly for his skill in directing the orderly movements of a fleet, and seems to have been satisfied with formal operations, which were possibly elegant but could lead to no substantial result. He had some of the combative instincts of his countryman Suñen, or of the average British admiral.

See vicomte de Nouilles, *Marius et soldats français en Amérique* (1903); and E. Chevalier, *Histoire de la marine française pendant la guerre de l'indépendance américaine* (1872). (D. H.)

GUIDE (in Mid. Eng. *gyde*, from the Fr. *guide*; the earlier French form was *guie*, English "guy" the *d* was due to the Italian form *guida*; the ultimate origin is probably Teutonic, the word being connected with the base seen in O. Eng. *witan*, to know), an agency for directing or showing the way, specifically a person who leads or directs a stranger over unknown or unmapped country, or conducts travellers and tourists through a town, or over buildings of interest. In European wars up to the time of the French Revolution, the absence of large scale detailed maps made local guides almost essential to the direction of military operations, and in the 18th century the general tendency to the stricter organization of military resources led in various countries to the special training of guide officers (called *Feldjäger*, and considered as general staff officers in the Prussian army), whose chief duty it was to find, and if necessary establish, routes across country for those parts of the army that had to move parallel to the main road and as nearly as possible at deploying interval from each other, for in those days armies were rarely spread out so far as to have the use of two or more made roads. But the necessity for such precautions died away when adequate surveys (in which guide officers were, at any rate in Prussia, freely employed) were carried out, and, as a definite term of military organization to-day, "guide" possesses no more essential peculiarity than fusilier, grenadier or rifleman. The genesis of the modern "Guide" regiments is perhaps to be found in a short-lived Corps of Guides formed by Napoleon in Italy in 1796, which appears to have been a personal escort or body guard composed of men who knew the country. In the Belgian army of to-day the Guide regiments correspond almost to the Guard cavalry of other nations; in the Swiss army the squadrons of "Guides" act as divisional cavalry, and in this rôle doubtless are called upon on occasion to lead columns. The "Queen's own Corps of Guides" of the Indian army consists of infantry companies and cavalry squadrons. In drill, a "guide" is an officer or non-commissioned officer told off to regulate the direction and pace of movements, the remainder of the unit maintaining their alignment and distances by him.

A particular class of guides are those employed in mountaineering; these are not merely to show the way but stand in the position of professional climbers with an expert knowledge of rock and snowcraft, which they impart to the amateur, at the same time assuring the safety of the climbing party in dangerous expeditions. This professional class of guides arose in the middle of the 19th century when Alpine climbing became recognized as a sport (see MOUNTAINEERING). It is thus natural to find that the Alpine guides have been requisitioned for mountaineering expeditions all over the world. In climbing in Switzerland, the central committee of the Swiss Alpine Club issues a guides' tariff which fixes the charges for guides and porters; there are three sections, for the Valais and Vaudois Alps, for the Bernese Oberland, and for central and eastern Switzerland. The names of many of the great guides have become historical. In Chamonix a statue has been raised to Jacques Balmat, who was the first to climb Mont Blanc in 1786. Of the more famous guides since the beginning of Alpine climbing may be mentioned Auguste Balmat, Michel Cros, Maquignay, J. A. Carrel, who went with E. Wympyer to the Andes, the brothers Laucner, Christian Almer and Jakob and Melchior Anderegg.

"Guide" is also applied to a book, in the sense of an elementary primer on some subject, or of one giving full information for travellers of a country, district or town. In mechanical usage, the term "guide" is of wide application, being used of anything which steadies or directs the motion of an object, as of the "leading" screw of a screw-cutting lathe, of a loose pulley used to steady a driving-belt, or of the bars or rods in a steam-engine which keep the sliding blocks moving in a straight line. The doublet "guy" is thus used of a rope which steadies

a sail when it is being raised or lowered, or of a rope, chain or stay supporting a funnel, mast, derrick, &c.

GUIDI, CARLO ALESSANDRO (1650-1712), Italian lyric poet, was born at Pavia in 1650. As chief founder of the well-known Roman academy called "L'Arcadia," he had a considerable share in the reform of Italian poetry, corrupted at that time by the extravagance and bad taste of the poets Marini and Achillini and their school. The poet Guidi and the critic and juriscult Gravina checked this evil by their influence and example. The genius of Guidi was lyric in the highest degree; his songs are written with singular force, and charm the reader, in spite of touches of bombast. His most celebrated song is that entitled *Alla Fortuna* (To Fortune), which certainly is one of the most beautiful pieces of poetry of the 17th century. Guidi was squint-eyed, humpbacked, and of a delicate constitution, but possessed undoubted literary ability. His poems were printed at Parma in 1671, and at Rome in 1704. In 1681 he published at Parma his lyric tragedy *Amalasia in Italy*, and two pastoral dramas *Daphne* and *Endymion*. The last had the honour of being mentioned as a model by the critic Gravina, in his treatise on poetry. Less fortunate was Guidi's poetical version of the six homilies of Pope Clement XI., first as having been severely criticized by the satirist Settano, and next as having proved to be the indirect cause of the author's death. A splendid edition of this version had been printed in 1712, and, the pope being then in San Gaudolfo, Guidi went there to present him with a copy. On the way he found out a serious typographical error, which he took so much to heart that he was seized with an apoplectic fit at Frascati and died on the spot. Guidi was honoured with the special protection of Ranuccio II., duke of Parma, and of Queen Christina of Sweden.

GUIDICIONI, GIOVANNI (1480-1541), Italian poet, was born at Lucca in 1480, and died at Macerata in 1541. He occupied a high position, being bishop of Fossombrone and president of Romagna. The latter office nearly cost him his life; a murderer attempted to kill him, and had already touched his breast with his dagger when, conquered by the resolute calmness of the prelate, he threw away the weapon and fell at his feet, asking forgiveness. The *Rime* and *Letters* of Guidicioni are models of elegant and natural Italian style. The best editions are those of Genoa (1749), Bergamo (1753) and Florence (1878).

GUIDO OF AREZZO (possibly to be identified with Guido de St Maur des Fosses), a musician who lived in the 11th century. He has by many been called the father of modern music, and a portrait of him in the refectory of the monastery of Avellana bears the inscription *Beatus Guido, inventor musicæ*. Of his life little is known, and that little is chiefly derived from the dedicatory letters prefixed to two of his treatises and addressed respectively to Bishop Theodald (not Theobald, as Burney writes the name) of Arezzo, and Michael, a monk of Pomposa and Guido's pupil and friend. Occasional references to the celebrated musician in the works of his contemporaries are, however, by no means rare, and from these it may be conjectured with all but absolute certainty that Guido was born in the last decade of the 10th century. The place of his birth is uncertain in spite of some evidence pointing to Arezzo; on the title-page of all his works he is styled *Guido Arctinus*, or simply *Arctinus*. At his first appearance in history Guido was a monk in the Benedictine monastery of Pomposa, and it was there that he taught singing and invented his educational method, by means of which, according to his own statement, a pupil might learn within five months what formerly it would have taken him ten years to acquire. Envy and jealousy, however, were his only reward, and by these he was compelled to leave his monastery—"inde est, quod me vides prolixis finibus exulatum," as he says himself in the second of the letters above referred to. According to one account, he travelled as far as Bremen, called there by Archbishop Hermann in order to reform the musical service. But this statement has been doubted. Certain it is that not long after his flight from Pomposa Guido was living at Arezzo, and it was here that, about 1030, he received an invitation to Rome from Pope John XIV. He obeyed the summons, and the

pope himself became his first and apparently one of his most proficient pupils. But in spite of his success Guido could not be induced to remain in Rome, the insubstantial air of which seems to have affected his health. In Rome he met again his former superior, the abbot of Pomposa, who seems to have repented of his conduct, and to have induced Guido to return to Pomposa; and here all authentic records of Guido's life cease. We only know that he died, on the 17th of May 1050, as prior of Avellana, a monastery of the Camaldulians; such at least is the statement of the chroniclers of that order. It ought, however, to be added that the Camaldulians claim the celebrated musician as wholly their own, and altogether deny his connexion with the Benedictines.

The documents discovered by Dom Germain Morin, the Belgian Benedictine, about 1888, point to the conclusion that Guido was a Frenchman and lived from his youth upwards in the Benedictine monastery of St Maur des Fosses where he invented his novel system of notation and taught the brothers to sing by it. In codex 763 of the British Museum the composer of the "Micrologus" and other works by Guido of Arezzo is always described as Guido de Sancto Mauro.

There is no doubt that Guido's method shows considerable progress in the evolution of modern notation. It was he who for the first time systematically used the lines of the staff, and the intervals or *spatia* between them. There is also little doubt that the names of the first six notes of the scale, *ut, re, mi, fa, sol, la*, still in use among Romance nations, were introduced by Guido, although he seems to have used them in a relative rather than in an absolute sense. It is well known that these words are the first syllables of six lines of a hymn addressed to St John the Baptist, which may be given here:—

<i>Ut</i> queant laxis	resonare fibris
<i>Mi</i> ra gestorum	famuli tuorum,
<i>Solve</i> polluti	labii reatum,
Sancte Joannes.	

In addition to this Guido is generally credited with the introduction of the F clef. But more important than all this, perhaps, is the thoroughly practical tone which Guido assumes in his theoretical writings, and which differs greatly from the clumsy scholasticism of his contemporaries and predecessors.

The most important of Guido's treatises, and those which are generally acknowledged to be authentic, are *Micrologus Guidonis de disciplina artis musicae*, dedicated to Bishop Theodald of Arezzo, and comprising a complete theory of music, in 20 chapters; *Musicae Guidonis regulae rhythmicae in antiphonariis sui prologum prolatas*, written in trochaic decasyllables of anything but classical structure; *Artis Guidonis regulae de ignoto cantu, identidem in antiphonariis sui prologum prolatas*; and the *Epistola Guidonis Michaeli monacho de ignoto cantu*, already referred to. These are published in the second volume of Gerbert's *Scriptores ecclesiastici de musica sacra*. A very important manuscript unknown to Gerbert (the *Codex bibliothecae Ulicensis*, in the Paris library) contains, besides minor treatises, an antiphonarium and gradual undoubtedly belonging to Guido.

See also L. Angeloni, *G. d'Arezzo* (1811); Kicscwetter, *Guido von Arezzo* (1840); Kornmüller, "Leben und Werke Guido von Arezzo," in Habert's *Jahrb.* (1876); Antonio Brandi, *G. Aretino* (1882); G. B. Ristori, *Biografia di Guido monaco d'Arezzo* (1868).

GUIDO OF SIENA. The name of this Italian painter is of considerable interest in the history of art, on the ground that, if certain assumptions regarding him could be accepted as true, he would be entitled to share with Cimabue, or rather indeed to supersede him in, the honour of having given the first onward impulse to the art of painting. The case stands thus. In the church of S. Domenico in Siena is a large painting of the "Virgin and Child Enthroned," with six angels above, and in the Benedictine convent of the same city is a triangular pinnacle, once a portion of the same composition, representing the Saviour in benediction, with two angels; the entire work was originally a triptych, but is not so now. The principal section of this picture has a rhymed Latin inscription, giving the painter's name as Gu . . . o de Senis, with the date 1221: the genuineness of the inscription is not, however, free from doubt, and especially it is maintained that the date really reads as 1281. In the general treatment of the picture there is nothing to distinguish it particularly from other work of the same early

period; but the heads of the Virgin and Child are indisputably very superior, in natural character and graceful dignity, to anything to be found anterior to Cimabue. The question therefore arises, Are these heads really the work of a man who painted in 1221? Crowe and Cavalcaselle pronounce in the negative, concluding that the heads are repainted, and are, as they now stand, due to some artist of the 14th century, perhaps Ugolino da Siena; thus the claims of Cimabue would remain undisturbed and in their pristine vigour. Beyond this, little is known of Guido da Siena. There is in the Academy of Siena a picture assigned to him, a half-figure of the "Virgin and Child," with two angels, dating probably between 1250 and 1300; also in the church of S. Bernardino in the same city a Madonna dated 1262. Milanesi thinks that the work in S. Domenico is due to Guido Graziani, of whom no other record remains earlier than 1278, when he is mentioned as the painter of a banner. Guido da Siena appears always to have painted on panel, not in fresco on the wall. He has been termed, very dubiously, a pupil of Pietrolino, and the master of "Diotisalvi," Mino da Turrita and Berlinghieri da Lucca.

GUIDO RENI (1575-1642), a prime master in the Bolognese school of painting, and one of the most admired artists of the period of incipient decadence in Italy, was born at Calvenzano near Bologna on the 4th of November 1575. His father was a musician of repute, a player on the flageolet; he wished to bring the lad up to perform on the harpsichord. At a very childish age, however, Guido displayed a determined bent towards the art of form, scribbling some attempt at a drawing here, there and everywhere. He was only nine years of age when Denis Calvart took notice of him, received him into his academy of design by the father's permission, and rapidly brought him forward, so that by the age of thirteen Guido had already attained marked proficiency. Albani and Domenichino became soon afterwards pupils in the same academy. With Albani Guido was very intimate up to the earlier period of manhood, but they afterwards became rivals, both as painters and as heads of ateliers, with a good deal of asperity on Albani's part; Domenichino was also pitted against Reni by the policy of Annibale Caracci. Guido was still in the academy of Calvart when he began frequenting the opposition school kept by Lodovico Caracci, whose style, far in advance of that of the Flemish painter, he dallied with. This exasperated Calvart. Him Guido, not yet twenty years of age, cheerfully quitted, transferring himself openly to the Caracci academy, in which he soon became prominent, being equally skillful and ambitious. He had not been a year with the Caracci when a work of his excited the wonder of Agostino and the jealousy of Annibale. Lodovico cherished him, and frequently painted him as an angel, for the youthful Reni was extremely handsome. After a while, however, Lodovico also felt himself nettled, and he patronized the competing talents of Giovanni Barbieri. On one occasion Guido had made a copy of Annibale's "Descent from the Cross"; Annibale was asked to retouch it, and finding nothing to do, exclaimed pettishly, "He knows more than enough" ("Costui ne sa troppo"). On another occasion Lodovico, consulted as umpire, lowered a price which Reni asked for an early picture. This slight determined the young man to be a pupil no more. He left the Caracci, and started on his own account as a competitor in the race for patronage and fame. A renowned work, the story of "Callisto and Diana," had been completed before he left.

Guido was faithful to the eclectic principle of the Bolognese school of painting. He had appropriated something from Calvart, much more from Lodovico Caracci; he studied with much zest after Albert Dürer; he adopted the massive, sombre and partly uncouth manner of Caravaggio. One day Annibale Caracci made the remark that a style might be formed reversing that of Caravaggio in such matters as the ponderous shadows and the gross common forms; this observation germinated in Guido's mind, and he endeavoured after some such style, aiming constantly at suavità. Towards 1602 he went to Rome with Albani, and Rome remained his headquarters for twenty years.

Here, in the pontificate of Paul V. (Borghese), he was greatly noted and distinguished. In the garden-house of the Romignoli Palace he painted the vast fresco which is justly regarded as his masterpiece—"Phoebus and the Hours preceded by Aurora." This exhibits his second manner, in which he had deviated far indeed from the promptings of Caravaggio. He founded now chiefly upon the antique, more especially the Niebo group and the "Venus de' Medici," modified by suggestions from Raphael, Correggio, Parmigiano and Paul Veronese. Of this last painter, although on the whole he did not get much from him, Guido was a particular admirer; he used to say that he would rather have been Paul Veronese than any other master—Paul was more nature than art. The "Aurora" is beyond doubt a work of pre-eminent beauty and attainment; it is stamped with pleasurable dignity, and, without being effeminate, has a more uniform aim after graceful selectness than can readily be traced in previous painters, greatly superior though some of them had been in impulse and personal fervour of genius. The pontifical chapel of Montcavallo was assigned to Reni to paint; but, being straitened in payments by the ministers, the artist made off to Bologna. He was fetched back by Paul V. with ceremonious éclat, and, lodging, living and equipage were supplied to him. At another time he migrated from Rome to Naples, having received a commission to paint the chapel of S. Gennaro. The notorious cabal of three painters resident in Naples—Corenzio, Casacchio and Ribera—offered, however, as stiff an opposition to Guido as to some other interlopers who preceded and succeeded him. They gave his servant a beating by the hands of two unknown bullies, and sent by him a message to his master to depart or prepare for death; Guido waited for no second warning, and departed. He now returned to Rome; but he finally left that city abruptly, in the pontificate of Urban VIII., in consequence of an offensive reprimand administered to him by Cardinal Spiniola. He had received an advance of 400 scudi on account of an altarpiece for St Peter's, but after some lapse of years had made no beginning with the work. A broad reminder from the cardinal put Reni on his mettle; he returned the 400 scudi, quitted Rome within a few days, and steadily resisted all attempts at recall. He now resettled in Bologna. He had taught as well as painted in Rome, and he left pupils behind him; but on the whole he did not stamp any great mark upon the Roman school of painting, apart from his own numerous works in the papal city.

In Bologna Guido lived in great splendour, and established a celebrated school, numbering more than two hundred scholars. He himself drew in it, even down to his latest years. On first returning to this city, he charged about £21 for a full-length figure (mere portraits are not here in question), half this sum for a half-length, and £5 for a head. These prices must be regarded as handsome, when we consider that Domenichino about the same time received only £10, 10s. for his very large and celebrated picture, the "Last Communion of St Jerome." But Guido's reputation was still on the increase, and in process of time he quintupled his prices. He now left Bologna hardly at all; in one instance, however, he went off to Ravenna, and, along with three pupils, he painted the chapel in the cathedral with his admired picture of the "Israelites gathering Manna." His shining prosperity was not to last till the end. Guido was dissipated, generously but indiscriminately profuse, and an inveterate gambler. The gambling propensity had been his from youth, but until he became elderly it did not noticeably damage his fortunes. It grew upon him, and in a couple of evenings he lost the enormous sum of 14,400 scudi. The vice told still more ruinously on his art than on his character. In his decline he sold his time at so much per hour to certain picture dealers; one of them, the Shylock of his craft, would stand by, watch in hand, and see him work. Half-heartedness, half-performance, blighted his product: self-repetition and mere mannerism, with affectation for sentiment and rapidity for beauty, became the art of Guido. Some of these trade-works, heads or half-figures, were turned out in three hours or even less. It is said that, tardily wise, Reni left off gambling for

nearly two years; at last he relapsed, and his relapse was followed not long afterwards by his death, caused by malignant fever. This event took place in Bologna on the 18th of August 1642; he died in debt, but was buried with great pomp in the church of S. Domenico.

Guido was personally modest, although he valued himself on his position in the art, and would tolerate no slight in that relation; he was extremely upright, temperate in diet, nice in his person and his dress. He was fond of stately houses, but could feel also the charm of solitude. In his temper there was a large amount of suspiciousness; and the jealousy which his abilities and his successes excited, now from the Caracci, now from Albani, now from the monopolizing league of Neapolitan painters, may naturally have kept this feeling in active exercise. Of his numerous scholars, Simone Cantarini, named Il Pesarese, counts as the most distinguished; he painted an admirable head of Reni, now in the Bolognese Gallery. The portrait in the Uffizi Gallery of Florence is from Reni's own hand. Two other good scholars were Giacomo Semenza and Francesco Cesi.

The character of Guido's art is so well known as hardly to call for detailed analysis, beyond what we have already intimated. His most characteristic style exhibits a prepositional ideal, of form rather than character, with a slight mode of handling, and silvery, somewhat cold, colour. In working from the nude he aimed at perfection of form, especially marked in the hands and feet. But he was far from always going to choice nature for his model; he transmuted *ad libitum*, and painted, it is avowed, a Magdalene of demonstrative charms from a vulgar-looking colour-grinder. His best works have beauty, great amenity, artistic feeling and high accomplishment of manner, all alloyed by a certain core of commonplace; in the worst pictures the commonplace swamps everything, and Guido has flooded European galleries with trashy and empty pretentiousness, all the more noxious in that its apparent grace of sentiment and form misleads the unwary into approval, and the dilettante dabbler into cheap raptures. Both in Rome and wherever else he worked he introduced increased softness of style, which was then designated as the modern method. His pictures are mostly Scriptural or mythologic in subject, and between two and three hundred of them are to be found in various European collections—more than a hundred of these containing life-sized figures. The portraits which he executed are few—those of Sixtus V., Cardinal Spada and the so-called Beatrice Cenci being among the most noticeable. The identity of the last-named portrait is very dubious; it certainly cannot have been painted direct from Beatrice, who had been executed in Rome before Guido ever resided there. Many etchings are attributed to him—some from his own works, and some after other masters; they are spirited, but rather negligent.

Of other works not already noticed, the following should be named:—in Rome (the Vatican), the "Crucifixion of St Peter," an example of the painter's earlier manner; in S. Lorenzo in Lucina, "Christ Crucified"; in Forlì, the "Conception"; in Bologna, the "Alms of St Roch" (early), the "Massacre of the Innocents," and the "Pieta, or Lament over the Body of Christ" (in the church of the Mendicanti), which is by many regarded as Guido's prime executive work; in the Dresden Gallery, an "Ecce Homo"; in Milan (Brera Gallery), "Saints Peter and Paul"; in Genoa (church of S. Ambrogio), the "Assumption of the Virgin"; in Berlin, "St Paul the Hermit and St Anthony in the Wilderness." The celebrated picture of "Fortune" (in the Capitol) is one of Reni's finest treatments of female form; as a specimen of male form, the "Samson Drinking from the Jawbone of an Ass" might be named beside it. One of his latest works of mark is the "Ariadne," which used to be in the Gallery of the Capitol. The Louvre contains twenty of his pictures, the National Gallery of London seven, and others were once there, now removed to other public collections. The most interesting of the seven is the small "Coronation of the Virgin," painted on copper, an elegantly finished work, more pretty than beautiful. It was probably painted before the master quitted Bologna for Rome.

For the life and works of Guido Reni, see Bolognini, *Vita di Guido Reni* (1839); Passeri, *Vite de' pittori*; and Malvasia, *Felsina Pittorica*; also Lanzi, *Storia pittorica*. (W. M. R.)

GUIENNE, an old French province which corresponded roughly to the *Aquitania Secunda* of the Romans and the archbishopric of Bordeaux. In the 12th century it formed with Gascony the duchy of Aquitaine, which passed under the dominion of the kings of England by the marriage of Eleanor of Aquitaine to Henry II.; but in the 13th, through the conquests of Philip Augustus, Louis VIII. and Louis IX., it was confined within the narrower limits fixed by the treaty of Paris (1259). It is at this point that Guienne becomes distinct from Aquitaine. It then comprised the Bordelais (the old countrypship of Bordeaux), the Bazadais, part of Périgord, Limousin, Quercy and Rouergue, the Agenais ceded by Philip III. (the Bold) to Edward I. (1279), and (still united with Gascony) formed a

duchy extending from the Charente to the Pyrenees. This duchy was held on the terms of homage to the French kings, an onerous obligation; and both in 1296 and 1324 it was confiscated by the kings of France on the ground that there had been a failure in the feudal duties. At the treaty of Brétigny (1360) Edward III. acquired the full sovereignty of the duchy of Guienne, together with Aunis, Saintonge, Angoumois and Poitou. The victories of du Guesclin and Gaston Phœbus, count of Foix, restored the duchy soon after to its 13th-century limits. In 1451 it was conquered and finally united to the French crown by Charles VII. In 1469 Louis XI. gave it in exchange for Champagne and Brîs to his brother Charles, duke of Berry, after whose death in 1472 it was again united to the royal dominion. Guienne then formed a government, which from the 17th century onwards was united with Gascony. The government of Guienne and Gascony, with its capital at Bordeaux, lasted till the end of the *ancien régime*. Under the Revolution the departments formed from Guienne proper were those of Gironde, Lot-et-Garonne, Dordogne, Lot, Aveyron and the chief part of Tarn-et-Garonne.

GUIGNES, JOSEPH DE (1721-1800), French orientalist, was born at Pontoise on the 10th of October 1721. He succeeded Fourmont at the Royal Library as secretary interpreter of the Eastern languages. A *Mémoire historique sur l'origine des Huns et des Turcs*, published by de Guignes in 1748, obtained his admission to the Royal Society of London in 1752, and he became an associate of the French Academy of Inscriptions in 1754. Two years later he began to publish his learned and laborious *Histoire générale des Huns, des Mongoles, des Turcs et des autres Tartares occidentaux* (1756-1758); and in 1757 he was appointed to the chair of Syriac at the Collège de France. He maintained that the Chinese nation had originated in Egyptian colonization, an opinion to which, in spite of every argument, he obstinately clung. He died in Paris in 1800. The *Histoire* had been translated into German by Dähnert (1768-1771). De Guignes left a son, Christian Louis Joseph (1759-1845), who, after learning Chinese from his father, went as consul to Canton, where he spent seventeen years. On his return to France he was charged by the government with the work of preparing a Chinese-French-Latin dictionary (1813). He was also the author of a work of travels (*Voyages à Pékin, Manille, et l'île de France*, 1808).

See Quérard, *La France littéraire*, where a list of the memoirs contributed by de Guignes to the *Journal des sçavants* is given.

GUILBERT, YVETTE (1869-), French *discuse*, was born in Paris. She served for two years until 1885 in the *Magasin du Printemps*, when, on the advice of the journalist, Edmond Stoullig, she trained for the stage under Landrol. She made her début at the Bouffes du Nord, then played at the Variétés, and in 1890 she received a regular engagement at the Eldorado to sing a couple of songs at the beginning of the performance. She also sang at the Ambassadeurs. She soon won an immense vogue by her rendering of songs drawn from Parisian lower-class life, or from the humours of the Latin Quarter, "*Quatre s'étudiants*" and the "*Hôtel du numéro trois*" being among her early triumphs. Her adoption of an habitual yellow dress and long black gloves, her studied simplicity of diction, and her ingenious delivery of songs charged with *risqué* meaning, made her famous. She owed something to M. Xanrof, who for a long time composed songs especially for her, and perhaps still more to Aristide Bruant, who wrote many of her *argot* songs. She made successful tours in England, Germany and America, and was in great request as an entertainer in private houses. In 1895 she married Dr M. Schiller. In later years she discarded something of her earlier manner, and sang songs of the "pompadour" and the "criméline" period in costume. She published the novels *La Vedette* and *Les Dent-sèches*, both in 1907.

GUILDFORD, a market town and municipal borough, and the county town of Surrey, England, in the Guildford parliamentary division, 29 m. S.W. of London by the London and South Western railway; served also by the London, Brighton, and South Coast and the South Eastern and Chatham railways.

Pop. (1901) 15,098. It is beautifully situated on an acclivity of the northern chalk Downs and on the river Wey. Its older streets contain a number of picturesque gabled houses, with quaint lattices and curious doorways. The ruins of a Norman castle stand finely above the town and are well preserved; while the ground about them is laid out as a public garden. Beneath the Angel Inn and a house in the vicinity are extensive vaults, apparently of Early English date, and traditionally connected with the castle. The church of St. Mary is Norman and Early English, with later additions and considerably restored; its aisles retain their eastward apses and it contains many interesting details. The church of St. Nicholas is a modern building on an ancient site, and that of Holy Trinity is a brick structure of 1763, with later additions, also on the site of an earlier church, from which some of the monuments are preserved, including that of Archbishop Abbot (1640). The town hall dates from 1683 and contains a number of interesting pictures. Other public buildings are the county hall, corn-market and institute with museum and library. Abbot's Hospital, founded by Archbishop Abbot in 1619, is a beautiful Tudor brick building. The county hospital (1866) was erected as a memorial to Albert, Prince Consort. The Royal Free Grammar School, founded in 1509, and incorporated by Edward VI., is an important school for boys. At Cranleigh, 6 m. S.E., is a large middle-class county school. The town has flour mills, iron foundries and breweries, and a large trade in grain; while fairs are held for live stock. There is a manufacture of gunpowder in the neighbouring village of Chilworth. Guildford is a suffragan bishopric in the diocese of Winchester. The borough is under a mayor, 4 aldermen and 22 councillors. Area, 2602 acres.

Guildford (Gyldford, Galdelford), occurs among the possessions of King Alfred, and was a royal borough throughout the middle ages. It probably owed its rise to its position at the junction of trade routes. It is first mentioned as a borough in 1131. Henry III. granted a charter to the men of Guildford in 1236, by which they obtained freedom from toll throughout the kingdom, and the privilege of having the county court held always in their town. Edward III. granted charters to Guildford in 1340, 1346 and 1367; Henry VI. in 1423; Henry VII. in 1488. Elizabeth in 1580 confirmed earlier charters, and other charters were granted in 1603, 1626 and 1686. The borough was incorporated in 1486 under the title of the mayor and good men of Guildford. During the middle ages the government of the town rested with a powerful merchant guild. Two members for Guildford sat in the parliament of 1295, and the borough continued to return two representatives until 1867 when the number was reduced to one. By the Redistribution Act of 1885 Guildford became merged in the county for electoral purposes. Edward II. granted to the town the right of having two fairs, at the feast of St. Matthew (21st of September) and at Trinity respectively. Henry VII. granted fairs on the feast of St. Martin (11th of November) and St. George (23rd of April). Fairs in May for the sale of sheep and in November for the sale of cattle are still held. The market rights date as least from 1276, and three weekly markets are still held for the sale of corn, cattle and vegetables respectively. The cloth trade which formed the staple industry at Guildford in the middle ages is now extinct.

GUILDHALL, the hall of the corporation of the city of London, England. It faces a courtyard opening out of Olesham Street. The date of its original foundation is not known. An ancient crypt remains, but the hall has otherwise undergone much alteration. It was rebuilt in 1411, beautified by the munificence of successive officials, damaged in the Great Fire of 1666, and restored in 1789 by George Dance; while the hall was again restored, with a new roof, in 1870. This fine chamber, 152 ft. in length, is the scene of the state banquets and entertainments of the corporation, and of the municipal meetings "in common hall." The building also contains a council chamber and various concert rooms, with a splendid library, open to the public, a museum and art gallery adjoining. The hall contains several monuments and two giant figures of wood.

known as Gbg and Magog. These were set up in 1708, but the appearance of giants in city pageants is of much earlier date.

GUILFORD, BARON AND EARL OF. FRANCIS NORTH, 1st Baron Guilford (1637-1695), was the third son of the 4th Baron North (see NORTH, BARONS), and was created Baron Guilford in 1683, after becoming lord keeper in succession to Lord Nottingham. He had been an eminent lawyer, solicitor-general (1671), attorney-general (1673), and chief-justice of the common pleas (1675), and in 1679 was made a member of the council of thirty and on its dissolution of the cabinet. He was a man of wide culture and a staunch royalist. In 1672 he married Lady Frances Pope, daughter and co-heiress of the earl of Downe, who inherited the Wrexton estate; and he was succeeded as 2nd baron by his son Francis (1673-1729), whose eldest son Francis (1704-1790), after inheriting first his father's title as 3rd baron, and then (in 1734) the barony of North from his kinsman the 6th Baron North, was in 1752 created 1st earl of Guilford. His first wife was a daughter of the earl of Halifax, and his son and successor Frederick was the English prime minister, commonly known as Lord North, his courtesy title while the 1st earl was alive.

FREDERICK NORTH, 2nd earl of Guilford, but better known by his courtesy title of Lord North (1752-1792), prime minister of England during the important years of the American War, was born on the 13th of April 1752, and after being educated at Eton and Christ Church, Oxford, was sent to make the grand tour of the continent. On his return he was, though only twenty-two years of age, at once elected M.P. for Banbury, of which town his father was high steward; and he sat for the same town in parliament for nearly forty years. In 1759 he was chosen by the duke of Newcastle to be a lord of the treasury, and continued in the same office under Lord Bute and George Grenville till 1765. He had shown himself such a ready debater that on the fall of the first Rockingham ministry in 1766 he was sworn of the privy council, and made paymaster-general by the duke of Grafton. His reputation for ability grew so high that in December 1767, on the death of the brilliant Charles Townshend, he was made chancellor of the exchequer. His popularity with both the House of Commons and the people continued to increase, for his temper was never ruffled, and his quiet humour perpetually displayed; and, when the retirement of the duke of Grafton was necessitated by the hatred he inspired and the attacks of Junius, no better successor could be found for the premiership than the chancellor of the exchequer. Lord North succeeded the duke in March 1770, and continued in office for twelve of the most eventful years in English history. George III. had at last overthrown the ascendancy of the great Whig families, under which he had so long groaned, and determined to govern as well as rule. He knew that he could only govern by obtaining a majority in parliament to carry out his wishes, and this he had at last obtained by a great expenditure of money in buying seats and by a careful exercise of his patronage. But in addition to a majority he must have a minister who would consent to act as his lieutenant, and such a minister he found in Lord North. How a man of undoubted ability such as Lord North was could allow himself to be thus used as a mere instrument cannot be explained; but the confidential tone of the king's letters seems to show that there was an unusual intimacy between them, which may account for North's compliance. The path of the minister in parliament was a hard one; he had to defend measures which he had not designed, and of which he had not approved, and this too in a House of Commons in which all the oratorical ability of Burke and Fox was against him, and when he had only the purchased help of Thurlow and Wedderburne to aid him. The most important events of his ministry were those of the American War of Independence. He cannot be accused of causing it, but one of his first acts was the retention of the tea-duty, and he it was also who introduced the Boston Port Bill in 1774. When the war had broken out he earnestly counselled peace, and it was only the earnest solicitations of the king not to leave his sovereign again at the mercy of the Whigs that induced him to defend a war which from 1779

he knew to be both hopeless and impolitic. At last, in March 1782, he insisted on resigning after the news of Cornwallis's surrender at Yorktown, and no man left office more blithely. He had been well rewarded for his assistance to the king: his children had good sinecures; his half-brothers, Brownlow North (1741-1820); was bishop of Winchester; he himself was chancellor of the university of Oxford, lord-lieutenant of the county of Somerset, and had finally been made a knight of the Garter, an honour which has only been conferred on three other members of the House of Commons, Sir R. Walpole, Lord Castlereagh and Lord Palmerston. Lord North did not remain long out of office, but in April 1783 formed his famous coalition with his old subordinate, C. J. Fox (q.v.), and became secretary of state with him under the nominal premiership of the duke of Portland. He was probably urged to this coalition with his old opponent by a desire to show that he could act independently of the king, and was not a mere royal mouthpiece. The coalition ministry went out of office on Fox's India Bill in December 1783, and Lord North, who was losing his sight, then finally gave up political ambition. He played, when quite blind, a somewhat important part in the debates on the Regency Bill in 1789, and in the next year succeeded his father as earl of Guilford. He did not long survive his elevation, and died peacefully on the 5th of August 1792. It is impossible to consider Lord North a great statesman, but he was a most good-tempered and humorous member of the House of Commons. In a time of unexampled party feeling he won the esteem and almost the love of his most bitter opponents. Burke finely sums up his character in his *Letter to a Noble Lord*: "He was a man of admirable parts, of general knowledge, of a versatile understanding, fitted for every sort of business; of infinite wit and pleasantry, of a delightful temper, and with a mind most disinterested. But it would be only to degrade myself," he continues, "by a weak adulation, and not to honour the memory of a great man, to deny that he wanted something of the vigilance and spirit of command which the times required."

By his wife Anne (d. 1797), daughter of George Speke of White Lackington, Somerset, Guilford had four sons, the eldest of whom, George Augustus (1757-1802), became 3rd earl on his father's death. This earl was a member of parliament from 1778 to 1792 and was a member of his father's ministry and also of the royal household; he left no sons when he died on the 30th of April 1802 and was succeeded in the earldom by his brother Francis (1761-1817), who also left no sons. The youngest brother, Frederick (1766-1827), who now became 5th earl of Guilford, was remarkable for his great knowledge and love of Greece and of the Greek language. He had a good deal to do with the foundation of the Ionian university at Corfu, of which he was the first chancellor and to which he was very liberal. Guilford, who was governor of Ceylon from 1798 to 1805, died unmarried on the 14th of October 1827. His cousin, Francis (1772-1801), a son of Brownlow North, bishop of Winchester from 1781 to 1820, was the 6th earl, and the latter's descendant, Frederick George (b. 1876), became 8th earl in 1886.

On the death of the 3rd earl of Guilford in 1802 the barony of North fell into abeyance between his three daughters, the survivor of whom, Susan (1797-1884), wife of John Sidney Doyle, who took the name of North, was declared by the House of Lords in 1841 to be Baroness North, and the title passed to her son, William Henry John North, the 11th baron (b. 1856) (see NORTH, BARONS).

For the Lord Keeper Guilford see the *Lives* by the Hon. R. North, edited by A. Jessop (1890) and E. Foss, *The Judges of England*, vol. vii. (1848-1864). For the prime minister, Lord North, see *Correspondence of George III. with Lord North*, edited by W. B. Donne (1867); Horace Walpole, *Journal of the Reign of George III.* (1809), and *Memoirs of the Reign of George III.*, edited by O. F. R. Barker (1894); Lord Brougham, *Historical Sketches of Statesmen*, vol. i. (1830); Earl Stanhope, *History of England* (1858); Sir T. E. May, *Constitutional History of England* (1863-1869); and W. E. H. Lecky, *History of England in the 18th century* (1878-1890).

GUILFORD, a township, including a borough of the same name, in New Haven county, Connecticut, U.S.A., on Long Island Sound and at the mouth of the Mounkatuck or West

river, about 16 m. E. by S. of New Haven. Pop. of the township, including the borough (1900), 2785, of whom 387 were foreign-born; (1920) 3001; pop. of the borough (1910), 1608. The borough is served by the New York, New Haven & Hartford railroad. On a plain is the borough green of nearly 12 acres, which is shaded by some fine old elms and other trees, and in which there is a soldiers' monument. About the green are several churches and some of the better residences. On an eminence commanding a fine view of the Sound is an old stone house, erected in 1630 for a parsonage, meeting-house and fortification; it was made a state museum in 1898, when extensive alterations were made to restore the interior to its original appearance. The Point of Rocks, in the harbour, is an attractive resort during the summer season. There are about 12 ft. of water on the harbour bar at high tide. The principal industries of Guilford are coastwise trade, the manufacture of iron castings, brass castings, wagon wheels and school furniture, and the canning of vegetables. Near the coast are quarries of fine granite; the stone for the pedestal of the Statue of Liberty on Bedloe's Island, in New York Harbour, was taken from them.

Guilford was founded in 1630 as an independent colony by a company of twenty-five or more families from Kent, Surrey and Sussex, England, under the leadership of Rev. Henry Whitfield (1597-1657). While still on shipboard twenty-five members of the company signed a plantation covenant whereby they agreed not to desert the plantation which they were about to establish. Arriving at New Haven early in July 1630, they soon began negotiations with the Indians for the purchase of land, and on the 29th of September a deed was signed by which the Indians conveyed to them the territory between East River and Stony Creek for "12 coats, 12 Fathoms of Wampam, 12 glasses (mirrors), 12 payer of shoes, 12 Hatchets, 12 pair of Stockings, 12 Hoes, 4 kettles, 12 knives, 12 Hatts, 12 Porringers, 12 spoones, and 2 English coats." Other purchases of land from the Indians were made later. Before the close of the year the company removed from New Haven and established the new colony; it was known by the Indian name Menuncatuck for about four years and the name Guilford (from Guildford, England) was then substituted. As a provisional arrangement, civil power for the administration of justice and the preservation of the peace was vested in four persons until such time as a church should be organized. This was postponed until 1643 when considerations of safety demanded that the colony should become a member of the New Haven Jurisdiction, and then only to meet the requirements for admission to this union were the church and church state modelled after those of New Haven. Even then, though suffrage was restricted to church members, Guilford planters who were not church members were required to attend town meetings and were allowed to offer objections to any proposed order or law. From 1661 until the absorption of the members of the New Haven Jurisdiction by Connecticut, in 1664, William Leete (1611-1683), one of the founders of Guilford, was governor of the Jurisdiction, and under his leadership Guilford took a prominent part in furthering the submission to Connecticut, which did away with the church state and the restriction of suffrage to freemen. Guilford was the birthplace of Fitz-Greene Halleck (1790-1867), the poet; of Samuel Johnson (1696-1771), the first president of King's College (now Columbia University); of Abraham Baldwin (1754-1807), prominent as a statesman and the founder of the University of Georgia; and of Thomas Chittenden, the first governor of Vermont. The borough was incorporated in 1815.

See B. C. Steiner, *A History of the Plantation of Menuncatuck and of the Original Town of Guilford, Connecticut* (Baltimore, 1897), and *Proceedings at the Celebration of the 250th Anniversary of the Settlement of Guilford, Connecticut* (New Haven, 1889).

GUILLAUME, JEAN BAPTISTE CLAUDE EUGÈNE (1822-1905), French sculptor, was born at Montbard on the 4th of July 1822, and studied under Cavalier, Millet, and Barrias, at the École des Beaux-Arts, which he entered in 1841, and where he gained the *prix de Rome* in 1845 with "Theseus finding on a

rock his Father's Sword." He became director of the École des Beaux-Arts in 1864, and director-general of Fine Arts from 1878 to 1879, when the office was suppressed. Many of his works have been bought for public galleries, and his monuments are to be found in the public squares of the chief cities of France. At Rheims there is his bronze statue of "Colbert," at Dijon his "Rameau" monument. The Luxembourg Museum has his "Anacreon" (1852), "Les Gracques" (1853), "Faucheu" (1855), and the marble bust of "Mgr Darboy"; the Versailles Museum the portrait of "Thiers"; the Sorbonne Library the marble bust of "Victor le Clerc, doyen de la faculté des lettres." Other works of his are at Trinity Church, St Germain l'Auxerrois, and the church of St Clotilde, Paris. Guillaume was a prolific writer, principally on sculpture and architecture of the Classic period and of the Italian Renaissance. He was elected member of the Académie Française in 1862, and in 1891 was sent to Rome as director of the Académie de France in that city. He was also elected an honorary member of the Royal Academy, London, 1869, on the institution of that class.

GUILLAUME DE LORRIS (fl. 1230), the author of the earlier section of the *Roman de la rose*, derives his surname from a small town about equidistant from Montargis and Gien, in the present department of Loiret. This and the fact of his authorship may be said to be the only things positively known about him. The rubric of the poem, where his own part finishes, attributes Jean de Meun's continuation to a period forty years later than William's death and the consequent interruption of the romance. Arguing backwards, this death used to be put at about 1260; but Jean de Meun's own work has recently been dated earlier, and so the composition of the first part has been thrown back to a period before 1240. The author represents himself as having dreamed the dream which furnished the substance of the poem in his twentieth year, and as having set to work to "rhymer it" five years later. The later and longer part of the *Roman* shows signs of greater intellectual vigour and wider knowledge than the earlier and shorter, but Guillaume de Lorris is to all appearance more original. The great features of his four or five thousand lines are, in the first place, the extraordinary vividness and beauty of his word-pictures, in which for colour, freshness and individuality he has not many rivals except in the greatest masters, and, secondly, the fashion of allegorical presentation, which, hackneyed and wearisome as it afterwards became, was evidently in his time new and striking. There are of course traces of it before, as in some romances, such as those of Raoul de Houdenc, in the troubadours, and in other writers; but it was unquestionably Guillaume de Lorris who fixed the style.

For an attempt to identify Guillaume de Lorris see L. Jarry, *Guillaume de Lorris et le testament d'Alphonse de Poitiers* (1881). Also Paulin Paris in the *Hist. litt. de la France*, vol. xxiii.

GUILLAUME DE PALERME (WILLIAM OF PALERME), hero of romance. The French verse romance was written at the desire of a Countess Yolande, generally identified with Yolande, daughter of Baldwin IV., count of Flanders. The English poem in alliterative verse was written about 1350 by a poet called William, at the desire of Humphrey Bohun, earl of Hereford, (d. 1361). Guillaume, a founding supposed to be of low degree, is brought up at the court of the emperor of Rome, and loves his daughter Melior who is destined for a Greek prince. The lovers flee into the woods disguised in bear-skins. Alfonso, who is Guillaume's cousin and a Spanish prince, has been changed into a wolf by his step-mother's enchantments. He provides food and protection for the fugitives, and Guillaume eventually triumphs over Alfonso's father, and wins back from him his kingdom. The benevolent werewolf is disenchanted, and marries Guillaume's sister.

See *Guillaume de Palerne*, ed. H. Michelant (Soc. d. anc. textes fr. 1876); *Hist. litt. de la France*, xxii. 829; *William of Palerne*, ed. Sir F. Madden (Roxburghe Club, 1832), and W. W. Skeat (E. E. Text Soc., extra series No. 1, 1867); M. Kalua, in *Eng. Studies* (Heilbronn, iv. 196). The prose version of the French romance, printed by N. Bonfons, passed through several editions.

GUILLAUME D'ORANGE (d. 812), also known as Guillaume Fierabrace, St Guillaume de Gellone, and the Marquis au court

sex, was the central figure of the southern cycle of French romance, called by the *trouvères* the *geste* of Garin de Monglane. The cycle of Guillaume has more unity than the other great cycles of Charlemagne or of Doon de Mayence, the various poems which compose it forming branches of the main story rather than independent epic poems. There exist numerous cyclic MSS. in which there is an attempt at presenting a continuous *histoire politique* of Guillaume and his family. MS. Royal 20 D xi. in the British Museum contains eighteen *chansons* of the cycle. Guillaume, son of Thierry or Theodoric and of Alde, daughter of Charles Martel, was born in the north of France about the middle of the 8th century. He became one of the best soldiers and trusted counsellors of Charlemagne, and in 790 was made count of Toulouse, when Charles's son Louis the Pious was put under his charge. He subdued the Gascons, and defended Narbonne against the infidels. In 793 Hescham, the successor of Abd-al-Rahman II., proclaimed a holy war against the Christians, and collected an army of 100,000 men, half of which was directed against the kingdom of the Asturias, while the second invaded France, penetrating as far as Narbonne. Guillaume met the invaders near the river Orbicieux, at Villedaigne, where he was defeated, but only after an obstinate resistance which so far exhausted the Saracens that they were compelled to retreat to Spain. He took Barcelona from the Saracens in 803, and in the next year founded the monastery of Gellone (now Saint Guilhem-le Désert), of which he became a member in 806. He died there in the odour of sanctity on the 28th of May 812.

No less than thirteen historical personages bearing the name of William (Guillaume) have been thought by various critics to have their share in the formation of the legend. William, count of Provence, son of Boso II., again delivered southern France from a Saracen invasion by his victory at Frazinet in 973, and ended his life in a cloister. William Tow-head (*Tête d'Étonpe*), duke of Aquitaine (d. 983), showed a fidelity to Louis IV. paralleled by Guillaume d'Orange's service to Louis the Pious. The cycle of twenty or more *chansons* which form the *geste* of Guillaume reposes on the traditions of the Arab invasions of the south of France, from the battle of Poitiers (732) under Charles Martel onwards, and on the French conquest of Catalonia from the Saracens. In the Norse version of the Carolingian epic Guillaume appears in his proper historical environment, as a chief under Charlemagne; but he plays a leading part in the *Couronnement Looyz*, describing the formal associations of Louis the Pious in the empire at Aix (813, the year after Guillaume's death), and after the battle of Aliscans it is from the emperor Louis that he seeks reinforcements. This anachronism arises from the fusion of the epic Guillaume with the champion of Louis IV., and from the fact that he was the military and civil chief of Louis the Pious, who was titular king of Aquitaine under his father from the time when he was three years old. The inconsistencies between the real and the epic Guillaume are often left standing in the poems. The personages associated with Guillaume in his Spanish wars belong to Provence, and have names common in the south. The most famous of these are Beuves de Comarchis, Ernaud de Girone, Garin d'Anseün, Aimer le chétif, so called from his long captivity with the Saracens. The separate existence of Aimer, who refused to sleep under a roof, and spent his whole life in warring against the infidel, is proved. He was Hadhemar, count of Narbonne, who in 809 and 810 was one of the leaders sent by Louis against Tortosa. No doubt the others had historical prototypes. In the hands of the *trouvères* they became all brothers of Guillaume, and sons of Aymeri de Narbonne, the grandson of Garin de Monglane, and his wife Ermenjart. Nevertheless when Guillaume seeks help from Louis the emperor he finds all his relations in Leon, in accordance with his historic Frankish origin.

¹ The poem of *Aymeri de Narbonne* contains the account of the young Aymeri's brilliant capture of Narbonne, which he then receives as a fief from Charlemagne, of his marriage with Ermenjart, sister of Boniface, king of the Lombards, and of their children. The fifth daughter, Blanche fleur, is represented as the wife of Louis the Pious. The opening of this poem furnished, though indirectly, the matter of the *Aymerrilles* of Victor Hugo's *Légende des siècles*.

The central fact of the *geste* of Guillaume is the battle of the Archamp or Aliscans, in which perished Guillaume's heroic nephew, Vezeian or Vivien, a second Roland. At the eleventh hour he summoned Guillaume to his help against the overwhelming forces of the Saracens. Guillaume arrived too late to help Vivien, was himself defeated, and returned alone to his wife Guibourc, leaving his knights all dead or prisoners. This event is related in a Norman-French transcript of an old French *chanson de geste*, the *Chançon de Willame*—which only was brought to light in 1901 at the sale of the books of Sir Henry Hope Edwardes—in the *Covenant Vivien*, a recension of an older French *chanson* and in *Aliscans*. *Aliscans* continues the story, telling how Guillaume obtained reinforcements from Laon, and how, with the help of the comic hero, the scullion Rainouart or Rennewart, he avenged the defeat of Aliscans and his nephew's death. Rainouart turns out to be the brother of Guillaume's wife Guibourc, who was before her marriage the Saracen princess and enchantress Orable. Two other poems are consecrated to his later exploits, *La Bataille Loquifer*, the work of a French Sicilian poet, Jendeu de Brie (fl. 1170), and *Le Montage Rainouart*. The starting-point of Herbert le duc de Dammartin (fl. 1170) in *Foucon de Candie* (Candle = Gandia in Spain?) is the return of Guillaume from the battle; and the Italian compilation *I Nerbonesi*, based on these and other *chansons*, seems in some cases to represent an earlier tradition than the later of the French *chansons*, although its author Andrea di Barberino wrote towards the end of the 14th century. The minnesinger Wolfram von Eschenbach based his *Willehalm* on a French original which must have differed from the versions we have. The variations in the story of the defeat of Aliscans or the Archant, and the numerous inconsistencies of the narratives even when considered separately have occupied many critics. Aliscans (Aleschans, Alyscamps, Elysiä Campi) was, however, generally taken to represent the battle of Villedaigne, and to take its name from the famous cemetery outside Arles. Wolfram von Eschenbach even mentions the tombs which studded the field of battle. Indications that this tradition was not unassailable were not lacking before the discovery of the *Chançon de Willame*, which, although preserved in a very corrupt form, represents the earliest recension we have of the story, dating at least from the beginning of the 12th century. It seems probable that the Archant was situated in Spain near Vivien's headquarters at Tortosa, and that Guillaume started from Barcelona, not from Orange, to his nephew's help. The account of the disaster was modified by successive *trouvères*, and the uncertainty of their methods may be judged by the fact that in the *Chançon de Willame* two consecutive accounts (ll. 450-1326 and ll. 1326-2420) of the fight appear to be set side by side as if they were separate episodes. *Le Couronnement Looyz*, already mentioned, *Le Charroi de Nîmes* (12th century) in which Guillaume, who had been forgotten in the distribution of fiefs, enumerates his services to the terrified Louis, and *Aliscans* (12th century), with the earlier *Chançon*, are among the finest of the French epic poems. The figure of Vivien is among the most heroic elaborated by the *trouvères*, and the giant Rainouart has more than a touch of Rabelaisian humour.

The *chansons de geste* of the cycle of Guillaume are: *Enfances Garin de Monglane* (13th century) and *Garin de Monglane* (13th century), on which is founded the prose romance of *Guérin de Monglane*, printed in the 15th century by Jehan Trepperel and often later; *Girars de Viane* (13th century, by Bertrand de Bar-sur-Aube), ed. P. Tarbé (Reims, 1850); *Hernaut de Beaulandis* (fragment 14th century); *Renier de Genes*, which only survives in its prose form; *Aymeri de Narbonne* (c. 1210) by Bertrand de Bar-sur-Aube, ed. L. Demaison (Soc. des anc. textes fr., Paris, 2 vols., 1887); *Les Enfances Guillaume* (13th century); *Les Narbonnois*, ed. H. Suchier (Soc. des anc. textes fr., 2 vols., 1898), with a Latin fragment dating from the 11th century, preserved at the Hague; *Le Couronnement Looyz* (ed. E. Langlois, 1888), *Le Charroi de Nîmes*, *La Prise d'Orange*, *Le Covenant Vivien*, *Aliscans*, which were edited by W. J. A. Jonckbloet in vol. i. of his *Guillaumes d'Orange* (The Hague, 1854); a critical text of *Aliscans* (Halle, 1903, vol. I.) is edited by E. Wienbeck, W. Hartnacke and P. Rasch; *Loquifer* and *Le Montage Rainouart* (12th century); *Beoves de Comarchis* (13th century), recension of the earlier *Siege de Barbastre*, by Adrien B.

Rois, ed. A. Scheler (Brussels, 1874); *Guibet d'Andrenos* (13th century); *La Prise de Cordes* (13th century); *La Mort Aimery de Narbonne*, ed. J. Couraye de Parc (Soc. des Anciens Textes français, Paris, 1884); *Fouques de Candie* (ed. P. Tarbé, Reims, 1860); *Le Montage Guillaume* (12th century); *Les Enfances Vivien* (ed. C. Wahlund and H. v. Feilitzen, Upsala and Paris, 1895); *Chansons de Guillaume* (Chiswick Press, 1903), described by P. Meyer in *Romania* (xxxiii, 597-618). The ninth branch of the *Karlamagnus Saga* (ed. C. R. Unger, Christiania, 1860) deals with the geste of Guillaume. *I Nerbonensi* is edited by J. G. Isola (Bologna, 1877, &c.).

See C. Révillout, *Étude hist. et litt. sur la vie sainte Willielmi* (Montpellier, 1876); W. J. A. Jonckbloet, *Guillaume d'Orange* (2 vols., 1854, The Hague); L. Clarus (ps. for W. Volk), *Hieroglyphen von Aquitanien* (Münster, 1865); P. Paris, in *Hist. litt. de la France* (vol. xxii., 1852); L. Gautier, *Épopées françaises* (vol. iv., and ed., 1882); R. Weeks, *The newly discovered Chansons de Guillaume* (Chicago, 1904); A. Thomas, *Études romanes* (Paris, 1891), on Vivien; L. Sallet, "S. Vidua de Martres-Tolosanes" in *Bull. de l'Écl. ecclési.* (Toulouse, 1902); P. Becker, *Die altfr. Wühelmsage u. ihre Beziehung zu Wilhelm dem Heiligen* (Halle, 1896), and *Die südfranzösische Sagenwelt und seine Probleme* (Halle, 1898); A. Jeanroy, "Études sur le cycle de Guillaume au court nez" (in *Romania*, vol. 25 and 26, 1896-1897); H. Suchier, "Recherches sur Guillaume d'Orange" (in *Romania*, vol. 32, 1903). The conclusions arrived at by earlier writers are combated by Joseph Bédier in the first volume, "Le Cycle de Guillaume d'Orange" (1908), of his *Légendes épiques*, in which he constructs a theory that the cycle of Guillaume d'Orange grew up round the various shrines on the pilgrim route to Saint Gilles of Provence and Saint James of Compostella—that the *chansons de geste* were, in fact, the product of 11th and 12th century trouvères, exploiting local ecclesiastical traditions, and were not developed from earlier poems dating back perhaps to the lifetime of Guillaume of Toulouse, the saint of Gellone.

GUILLEMOT (Fr. *guillemot* ¹), the name accepted by nearly all modern authors for a sea-bird, the *Colymbus troile* of Linnaeus and the *Uria troile* of Latham, which nowadays it seems seldom if ever to bear among those who, from their vocation, are most conversant with it, though, according to Willughby and Ray his translator, it was in their time so called "by those of Northumberland and Durham." Around the coasts of Britain it is variously known as the frowl, kiddaw or skiddaw, langy (cf. Ice. *Langvía*), lavy, marrock, murre, scout (cf. COOT), scutlock, strany, tinker or tinkershire and willock. In former days the guillemot yearly frequented the cliffs on many parts of the British coasts in countless multitudes, and this is still the case in the northern parts of the United Kingdom; but more to the southward nearly all its smaller settlements have been rendered utterly desolate by the wanton and cruel destruction of their tenants during the breeding season, and even the inhabitants of those which were more crowded had become so thinned that, but for the intervention of the Sea Birds Preservation Act (32 & 33 Vict. cap. 17), which provided under penalty for the safety of this and certain other species at the time of year when they were most exposed to danger, they would unquestionably by this time have been exterminated so far as England is concerned.

Part of the guillemot's history is still little understood. We know that it arrives at its wonted breeding stations on its accustomed day in spring, that it remains there till, towards the end of the summer, its young are hatched and able, as they soon are, to encounter the perils of a seafaring life, when away go all, parents and progeny. After that time it commonly happens that a few examples are occasionally met with in bays and shallow waters. Tempestuous weather will drive ashore a large number in a state of utter destitution—many of them indeed are not infrequently washed up dead—but what becomes of the bulk of the birds, not merely the comparatively few thousands that are natives of Britain, but the tens and hundreds of thousands, not to say millions, that are in summer denizens of more northern latitudes, no one can say. This mystery is not peculiar to the guillemot, but is shared by all the *Alcidas* that inhabit the Atlantic Ocean. Examples stray every season across the Bay of

Biscay, are found off the coasts of Spain and Portugal, enter the Mediterranean and reach Italian waters, or, keeping farther south, may even touch the Madeiras, Canaries or Azores; but these bear no proportion whatever to the mighty hosts of whom they are literally the "scouts," and whose position and movements they no more reveal than do the vedettes of a well-appointed army. The common guillemot of both sides of the Atlantic is replaced farther northward by a species with a stouter bill, the *U. arca* or *U. brucei* of ornithologists, and on the west coast of North America by the *U. californica*. The habits of all these are essentially the same, and the structural resemblance between all of them and the Auks is so great that several systematists have relegated them to the genus *Alea*, confining the genus *Uria* to the guillemots of another group, of which the type is the *U. grylla*, the black guillemot of British authors, the dovekey or Greenland dove of sailors, the tysty of Shetlanders. This bird assumes in summer an entirely black plumage with the exception of a white patch on each wing, while in winter it is beautifully marbled with white and black. Allied to it as species or geographical races are the *U. mandri*; *U. columba* and *U. corbe*. All these differ from the larger guillemots by laying two or three eggs, which are generally placed in some secure niche, while the members of the other group lay but a single egg, which is invariably exposed on a bare ledge. (A. N.)

GUILLOCHE, a French word for an ornament, either painted or carved, which was one of the principal decorative bands employed by the Greeks in their temples or on their vases. Guilloches are single, double or triple; they consist of a series of circles equidistant one from the other and enclosed in a band which winds round them and interlaces. This guilloche is of Asiatic origin and was largely employed in the decoration of the Assyrian palaces, where it was probably copied from Chaldaean work, as there is an early example at Erech which dates from the time of Gudea (2294 B.C.). The ornament as painted by the Greeks has almost entirely disappeared, but traces are found in the temple of Nemesis at Rhamnus; and on the terra-cotta slabs by which the timber roofs of Greek temples were protected, it is painted in colours which are almost as brilliant as when first produced, those of the Treasury of Gela at Olympia being of great beauty. These examples are double guilloches, with two rows of circles, each with an independent interlacing band and united by a small arc with palmette inside; in both the single and double guilloches of Greek work there is a flower in the centre of the circles. In the triple guilloche, the centre row of circles comes half-way between the others, and the enclosing band crosses diagonally both ways, interlacing alternately. The best example of the triple guilloche is that which is carved on the torus moulding of the base and on the small convex moulding above the echinus of the capitals of the columns of the Erechtheum at Athens. It was largely employed in Roman work, and the single guilloche is found almost universally as a border in mosaic pavements, not only in Italy but throughout Europe. In the Renaissance in Italy it was also a favourite enrichment for borders and occasionally in France and England.

GUILLOU, MARIE NICOLAS SYLVESTRE (1760-1847), French ecclesiastic, was born in Paris on the 1st of January 1760. He was librarian and almoner in the household of the princess de Lamballe, and when in 1792 she was executed, he fled to the provinces, where under the name of Pastel he practised medicine. A man of facile conscience, he afterwards served in turn under Napoleon, the Bourbons and the Orleanists, and became canon of St Denis, bishop of Morocco and dean of the Sorbonne.

Among his many literary works are a *Collection des brevets du pape Pie VI* (1796), *Bibliothèque choisie des pères grecs et latins* (1822, 26 vols.) and a French translation of Cyprian with notes (1837, 2 vols.).

GUILLOTINE, the instrument for inflicting capital punishment by decapitation, introduced into France at the period of the Revolution. It consists of two upright posts surmounted by a cross beam, and grooved so as to guide an oblique-edged knife, the back of which is heavily weighted to make it fall swiftly and with force when the cord by which it is held aloft is let go. Some

¹ The word, however, seems to be cognate with or derived from the Welsh and Manx *Guillem*, or *Gwilym* as Pennant spells it. The association may have no real meaning, but one cannot help comparing the resemblance between the French *guillemot* and *Guillaume* with that between the English willock (another name for the bird) and William.

ascribe the invention of the machine to the Persians; and previous to the period when it obtained notoriety under its present name it had been in use in Scotland, England and various parts of the continent. There is still preserved in the antiquarian museum of Edinburgh the rude guillotine called the "maiden" by which the regent Morton was decapitated in 1581. The last persons decapitated by the Scottish "maiden" were the marquis of Argyll in 1661 and his son the earl of Argyll in 1685. It would appear that no similar machine was ever in general use in England; but until 1650 there existed in the forest of Hardwick, which was coextensive with the parish of Halifax, West Riding, Yorkshire, a mode of trial and execution called the gibbet law, by which a felon convicted of theft within the liberty was sentenced to be decapitated by a machine called the Halifax gibbet. A print of it is contained in a small book called *Halifax and its Gibbet Law* (1708), and in Gibson's edition of Camden's *Britannia* (1722). In Germany the machine was in general use during the middle ages, under the name of the *Diele*, the *Hobel* or the *Dolabra*. Two old German engravings, the one by George Penez, who died in 1550, and the other by Heinrich Aldegrever, with the date 1553, represent the death of a son of Titus Manlius by a similar instrument, and its employment for the execution of a Spartan in the subject of the engraving of the eighteenth symbol in the volume entitled *Symbolica quaestiones de uniuerso genere*, by Achilles Bocchi (1556). From the 13th century it was used in Italy under the name of *Mannaia* for the execution of criminals of noble birth. The *Chronique de Jean d'Anton*, first published in 1835, gives minute details of an execution in which it was employed at Genoa in 1507; and it is elaborately described by Père Jean Baptiste Labat in his *Voyage en Espagne et en Italie en 1730*. It is mentioned by Jacques, viscomte de Puysegur, in his *Mémoires* as in use in the south of France, and he describes the execution by it of Marshal Montmorency at Toulouse in 1637. For about a century it had, however, fallen into general disuse on the continent; and Dr Guillotine, who first suggested its use in modern times, is said to have obtained his information regarding it from the description of an execution that took place at Milan in 1700, contained in an anonymous work entitled *Voyage historique et politique de Suisse, d'Italie, et d'Allemagne*.

Guillotine, who was born at Saintes, May 28, 1738, and elected to the Constituent Assembly in 1789, brought forward on the 1st December of that year two propositions regarding capital punishment, the second of which was that, "in all cases of capital punishment it shall be of the same kind—that is, decapitation—and it shall be executed by means of a machine." The reasons urged in support of this proposition were that in cases of capital punishment the privilege of execution by decapitation should no longer be confined to the nobles, and that it was desirable to render the process of execution as swift and painless as possible. The debate was brought to a sudden termination in peals of laughter caused by an indiscreet reference of Dr Guillotine to his machine, but his ideas seem gradually to have leavened the minds of the Assembly, and after various debates decapitation was adopted as the method of execution in the penal code which became law on the 6th October 1791. At first it was intended that decapitation should be by the sword, but on account of a memorandum by M. Sanson, the executioner, pointing out the expense and certain other inconveniences attending that method, the Assembly referred the question to a committee, at whose request Dr Antoine Louis, secretary to the Academy of Surgeons, prepared a memorandum on the subject. Without mentioning the name of Guillotine, it recommended the adoption of an instrument similar to that which was formerly suggested by him. The Assembly decided in favour of the report, and the contract was offered to the person who usually provided the instruments of justice; but, as his terms were considered exorbitant, an agreement was ultimately come to with a German of the name of Schmidt, who, under the direction of M. Louis, furnished a machine for each of the French departments. After satisfactory experiments had been made with the machine on several dead bodies in the hospital of Bicêtre, it was erected on

the Place de Grève for the execution of the highwayman Felletier on the 25th April 1792. While the experiments regarding the machine were being carried on, it received the name *Louisette* or *La Petite Louise*, but the mind of the nation seems soon to have reverted to Guillotine, who first suggested its use; and in the *Journal des révolutions de Paris* for 28th April 1792 it is mentioned as *la guillotine*, a name which it thenceforth bore both popularly and officially. In 1795 the question was much debated as to whether or not death by the guillotine was instantaneous, and in support of the negative side the case of Charlotte Corday was adduced whose countenance, it is said, blushed as if with indignation when the executioner, holding up the head to the public gaze, struck it with his fist. The connexion of the instrument with the horrors of the Revolution has hindered its introduction into other countries, but in 1853 it was adopted under the name of *Fallschwert* or *Fallsbeil* by the kingdom of Saxony; and it is used for the execution of sentences of death in France, Belgium and some parts of Germany. It has often been stated that Dr Guillotine perished by the instrument which bears his name, but it is beyond question that he survived the Revolution and died a natural death in 1814.

See Sédillot, *Réflexions historiques et physiologiques sur le supplice de la guillotine* (1795); Sue, *Opinion sur le supplice de la guillotine*, (1796); Réveille-Parise, *Étude biographique sur Guillotine* (Paris, 1851); *Notice historique et physiologique sur le supplice de la guillotine* (Paris, 1830); Louis Dubois, *Rocherches historiques et physiologiques sur la guillotine et détails sur Sanson* (Paris, 1843); and a paper by J. W. Croker in the *Quarterly Review* for December 1843, reprinted separately in 1850 under the title *The Guillotine, a historical Essay*.

GUILT, a lapse from duty, a crime, now usually the fact of wilful wrong-doing, the condition of being guilty of a crime, hence conduct deserving of punishment. The O. Eng. form of the word is *gylt*. The *New English Dictionary* rejects for phonetic reasons the usually accepted connexion with the Teutonic root *gald-*, to pay, seen in Ger. *gelten*, to be of value, *Geld*, money, payment, English "yield."

GUIMARÃES (sometimes written *Guimaraens*), a town of northern Portugal, in the district of Braga, formerly included in the province of Entre-Minbo-e-Douro; 36 m. N.E. of Oporto by the Trofa-Guimarães branch of the Oporto-Corunna railway. Pop. (1900) 9104. Guimarães is a very ancient town with Moorish fortifications; and even the quarters which are locally described as "new" date partly from the 15th century. It occupies a low hill, skirted on the north-west by a small tributary of the river Ave. The citadel, founded in the 11th century by Count Henry of Burgundy, was in 1094 the birthplace of his son Alphonso, the first king of Portugal. The font in which Alphonso was baptized is preserved, among other interesting relics, in the collegiate church of Santa Maria da Oliveira. "St Mary of the Olive," a Romanesque building of the 14th century, which occupies the site of an older foundation. This church owes its name to the legend that the Visigothic king Wamba (672-680) here declined the crown of Spain, until his olive wood spear-shaft blossomed as a sign that he should consent. The convent of São Domingos, now a museum of antiquities, has a fine 12th-13th century cloister; the town hall is built in the blend of Moorish and Gothic architecture known as Manoelina. Guimarães has a flourishing trade in wine and farm produce; it also manufactures cutlery, linen, leather and preserved fruits. Near the town are Citania, the ruins of a prehistoric Iberian city, and the hot sulphurous springs of Taipas, frequented since the 4th century, when Guimarães itself was founded.

GUILMARD, MARIE MADELEINE (1743-1816), French dancer, was born in Paris on the 10th of October 1743. For twenty-five years she was the star of the Paris Opéra. She made herself even more famous by her love affairs, especially by her long liaison with the prince de Soubise. She bought a magnificent house at Pantin, and built a private theatre connected with it, where Collé's *Partie de chasse de Henri IV* which was prohibited in public, and most of the *Proverbes* of Carmontelle (Louis Carrogis, 1717-1806), and similar licentious performances were given to the delight of high society. In 1772, in defiance of the

archbishop of Paris, she opened a gorgeous house with a theatre seating five hundred spectators in the Chaussée d'Antia. In this Temple of Terpsichore, as she named it, the wildest orgies took place. In 1786 she was compelled to get rid of the property, and it was disposed of by lottery for her benefit for the sum of 300,000 francs. Soon after her retirement in 1789 she married Jean Etienne Despreaux (1748-1820), dancer, song-writer and playwright.

GUMMET, JEAN BAPTISTE (1795-1871), French industrial chemist, was born at Vailron on the 20th of July 1795. He studied at the École Polytechnique in Paris, and in 1817 entered the Administration des Poudres et Salpêtres. In 1828 he was awarded the prize offered by the Société d'Encouragement pour l'Industrie Nationale for a process of making artificial ultramarine with all the properties of the substance prepared from lapis lazuli; and six years later he resigned his official position in order to devote himself to the commercial production of that material, a factory for which he established at Fleurieux sur Saône. He died on the 8th of April 1871.

His son **ÉMILE ÉTIENNE GUMMET**, born at Lyons on the 26th of June 1836, succeeded him in the direction of the factory, and founded the Musée Guimet, which was first located at Lyons in 1879 and was handed over to the state and transferred to Paris in 1885. Devoted to travel, he was in 1876 commissioned by the minister of public instruction to study the religions of the Far East, and the museum contains many of the fruits of this expedition, including a fine collection of Japanese and Chinese porcelain and many objects relating not merely to the religions of the East but also to those of Ancient Egypt, Greece and Rome. He wrote *Lettres sur l'Algérie* (1877) and *Promenades japonaises* (1880), and also some musical compositions, including a grand opera, *Tai-Tsoung* (1894).

GUINEA, the general name applied by Europeans to part of the western coast region of equatorial Africa, and also to the gulf formed by the great bend of the coast line eastward and then southward. Like many other geographical designations the use of which is controlled neither by natural nor political boundaries, the name has been very differently employed by different writers and at different periods. In the widest acceptation of the term, the Guinea coast may be said to extend from 13° N. to 16° S., from the neighbourhood of the Gambia to Cape Negro. Southern or Lower Guinea comprises the coasts of Gabun and Loango (known also as French Congo) and the Portuguese possessions on the south-west coast, and Northern or Upper Guinea stretches from the river Casamance to and inclusive of the Niger delta, Cameroon occupying a middle position. In a narrower use of the name, Guinea is the coast only from Cape Palmas to the Gabun estuary. Originally, on the other hand, Guinea was supposed to begin as far north as Cape Nun, opposite the Canary Islands, and Gomes Azurara, a Portuguese historian of the 15th century, is said to be the first authority who brings the boundary south to the Senegal. The derivation of the name is uncertain, but is probably taken from Ghinea, Ginné, Genni or Jenné, a town and kingdom in the basin of the Niger, famed for the enterprise of its merchants and dating from the 8th century A.D. The name Guinea is found on maps of the middle of the 14th century, but it did not come into general use in Europe till towards the close of the 15th century.¹

¹ Guinea may, however, be derived from Ghana (or Ghanata) the name of the oldest known state in the western Sudan. Ghana dates, according to some authorities, from the 3rd century A.D. From the 7th to the 12th century it was a powerful empire, its dominions extending, apparently, from the Atlantic to the Niger bend. At one time Jenné was included within its borders. Ghana was finally conquered by the Mandingo kings of Melle in the 13th century. Its capital, also called Ghana, was west of the Niger, and is generally placed some 200 m. west of Jenné. In this district L. Desplagnes discovered in 1907 numerous remains of a once extensive city, which he identified as those of Ghana. The ruins lie 25 m. W. of the Niger, on both banks of a marigot, and are about 40 m. N. by E. of Kulikoro (see *La Géographie*, xvi. 329). By some writers Ghana city is, however, identified with Walata, which town is mentioned by Arab historians as the capital of Ghanata. The identification of Ghana city with Jenné is not justified, though Idrisi seems to be describing Jenné when writing of "Ghana the Great."

Although the term Gulf of Guinea is applied generally to that part of the coast south of Cape Palmas and north of the mouth of the Congo, particular indentations have their peculiar designations. The bay formed by the configuration of the land between Cape St Paul and the Nun mouth of the Niger is known as the Bight of Benin, the name being that of the once powerful native state whose territory formerly extended over the whole district. The Bight of Biafra, or Mafra (named after the town of Mafra in southern Portugal), between Capes Formosa and Lopez, is the most eastern part of the Gulf of Guinea; it contains the islands Fernando Po, Prince's and St Thomas's. The name Biafra—as indicating the country—fell into disuse in the later part of the 19th century.

The coast is generally so low as to be visible to navigators only within a very short distance, the mangrove trees being their only sailing marks. In the Bight of Biafra the coast forms an exception, being high and bold, with the Cameroon Mountains for background. At Sierra Leone also there is high land. The coast in many places maintains a dead level for 30 to 50 m. inland. Vegetation is exceedingly luxuriant and varied. The palm-oil tree is indigenous and abundant from the river Gambia to the Congo. The fauna comprises nearly all the more remarkable of African animals. The inhabitants are the true Negro stock.

By the early traders the coast of Upper Guinea was given names founded on the productions characteristic of the different parts. The Grain coast, that part of the Guinea coast extending for 500 m. from Sierra Leone eastward to Cape Palmas received its name from the export of the seeds of several plants of a peppery character, called variously grains of paradise, Guinea pepper and melegueta. The name Grain coast was first applied to this region in 1455. It was occasionally styled the Windy or Windward coast, from the frequency of short but furious tornadoes throughout the year. Towards the end of the 18th century, Guinea pepper was supplanted in Europe by peppers from the East Indies. The name now is seldom used, the Grain coast being divided between the British colony of Sierra Leone and the republic of Liberia. The Ivory coast extends from Cape Palmas to 3° W., and obtained its name from the quantity of ivory exported therefrom. It is now a French possession. Eastwards of the Ivory coast are the Gold and Slave coasts. The Niger delta was for long known as the Oil rivers. To two regions only of the coast is the name Guinea officially applied, the French and Portuguese colonies north of Sierra Leone being so styled.

Of the various names by which the divisions of Lower Guinea were known, Loango was applied to the country south of the Gabun and north of the Congo river. It is now chiefly included in French Congo. Congo was used to designate the country immediately south of the river of the same name, usually spoken of until the last half of the 19th century as the Zaire. Congo is now one of the subdivisions of Portuguese West Africa (see ANGOLA). It must not be confounded with the Belgian Congo.

Few questions in historical geography have been more keenly discussed than that of the first discovery of Guinea by the navigators of modern Europe. Lancelot Malocello, a Genoese, in 1270 reached at least as far as the Canaries. The first direct attempt to find a sea route to India was, it is said, also made by Genoese, Ugolino and Guido de Valvado, Tedisio Doria and others who equipped two galleys and sailed south along the African coast in 1291. Beyond the fact that they passed Cape Nun there is no trustworthy record of their voyage. In 1346 a Catalan expedition started for "the river of gold" on the Guinea coast; its fate is unknown. The French claim that between 1304 and 1410 the people of Dieppe sent out several expeditions to Guinea; and Jean de Béthencourt, who settled in the Canaries about 1402, made explorations towards the south. At length the consecutive efforts of the navigators employed by Prince Henry of Portugal—Gil Eannes, Diniz Diaz, Nuno Tristram, Alvaro Fernandez, Cadamosto, Usodimare and Diego Gomez—made known the coast as far as the Gambia; and by the end

of the 15th century the whole region was familiar to Europeans.

For further information see SENEGAL, GOLD COAST, IVORY COAST, FRENCH GUINEA, PORTUGUESE GUINEA, LIBERIA, &c. For the history of European discoveries, consult G. E. de Azurara, *Crónica de descobrimento e conquista de Guiné*, published, with an introduction, by Barros de Santarém (Paris, 1841), English translation, *The Discovery and Conquest of Guinea*, by C. R. Beazley and E. Prestage (Hakluyt Society publications, 2 vols., London, 1896-1899), vol. II, has an introduction on the early history of African exploration, &c. with full bibliographical notes). L. Escanell, *Recherches sur les voyages et découvertes des navigateurs normands en Afrique* (Paris, 1832); Villault de Bellefond, *Relation des côtes d'Afrique appelées Guinée* (Paris, 1669); Père Labat, *Nouvelle Relation de l'Afrique occidentale* (Paris, 1728); Desmarquets, *Mém. chron. pour servir à l'hist. de Dièppe* (1875); Santarém, *Priorité de la découverte des pays situés sur la côte occidentale d'Afrique* (Paris, 1842); R. H. Major, *Life of Prince Henry the Navigator* (London, 1869); and the elaborate review of Major's work by M. Codine in the *Bulletin de la Soc. de Géog.* (1873); A. E. Nordenkiöld, *Periplus* (Stockholm, 1897); *The Story of Africa*, vol. I. (London, 1892), edited by Dr Robert Brown.

GUINEA, a gold coin at one time current in the United Kingdom. It was first coined in 1663, in the reign of Charles II., from gold imported from the Guinea coast of West Africa by a company of merchants trading under charter from the British crown—hence the name. Many of the first guineas bore an elephant on one side, this being the stamp of the company; in 1675 a castle was added. Issued at the same time as the guinea were five-guinea, two-guinea and half-guinea pieces. The current value of the guinea on its first issue was twenty shillings. It was subsidiary to the silver coinage, but this latter was in such an unsatisfactory state that the guinea in course of time became over-valued in relation to silver, so much so that in 1694 it had risen in value to thirty shillings. The rehabilitation of the silver coinage in William III.'s reign brought down the value of the guinea to 21s. 6d. in 1698, at which it stood until 1717, when its value was fixed at twenty-one shillings. This value the guinea retained until its disappearance from the coinage. It was last coined in 1813, and was superseded in 1817 by the present principal gold coin, the sovereign. In 1718 the quarter-guinea was first coined. The third-guinea was first struck in George III.'s reign (1787). To George III.'s reign also belongs the "spade-guinea," a guinea having the shield on the reverse pointed at the base or spade-shaped. It is still customary to pay subscriptions, professional fees and honoraria of all kinds, in terms of "guineas," a guinea being twenty-one shillings.

GUINEA FOWL, a well-known domestic gallinaceous bird, so called from the country whence in modern times it was brought to Europe, the *Meleagris* or *Avis* or *Gallina Numidica* of ancient authors.¹ Little is positively known of the wild stock to which we owe our tame birds, nor can the period of its re-introduction (for there is apparently no evidence of its domestication being continuous from the time of the Romans) be assigned more than roughly to that of the African discoveries of the Portuguese. It does not seem to have been commonly known till the middle of the 16th century, when John Caius sent a description and figure, with the name *Gallus Mauritanus*, to Gesner, who published both in his *Paralipomena* in 1555, and in the same year Belon also gave a notice and woodcut under the name of *Pouille de la Guinée*; but while the former authors properly referred their bird to the ancient *Meleagris*, the latter confounded the *Meleagris* and the turkey.

The ordinary guinea fowl of the poultry-yard (see also POULTRY AND POULTRY-FARMING) is the *Numida meleagris* of ornithologists. The chief or only changes which domestication seems to have induced in its appearance are a tendency to albinism generally shown in the plumage of its lower parts, and frequently, though not always, the conversion of the colour of its legs and

¹ Columella (*De re rustica*, viii. cap. 2) distinguishes the *Meleagris* from the *Gallina Africana* or *Numidica*, the latter having, he says, a red wattle (*pales*, a reading obviously preferable to *gales*), while it was blue in the former. This would look as if the *Meleagris* had sprung from what is now called *Numida pitlorhynchos*, while the *Gallina Africana* originated in the *N. meleagris*, species which have a different range, and if so the fact would point to two distinct introductions—one by Greeks, the other by Latins.

feet from dark greyish-brown to bright orange. That the home of this species is West Africa from the Gambia to the Gaboon is certain, but its range in the interior is quite unknown. It appears to have been imported early into the Cape Verd Islands, where, as also in some of the Greater Antilles and in Ascension, it has run wild. Representing the species in South Africa we have the *N. coronata*, which is very numerous from the Cape Colony to Ovampoland, and the *N. cornuta* of Drs Finch and Hartlaub, which replaces it in the west as far as the Zambesi. Madagascar also has its peculiar species, distinguishable by its red crown, the *N. mirata* of Pallas, a name which has often been misapplied to the last. This bird has been introduced to Rodriguez, where it is now found wild. Abyssinia is inhabited by another species, the *N. pitlorhynchos*,² which differs from all the foregoing by the absence of any red colouring about the head. Very different from all of them, and the finest species known, is the *N. vulturina* of Zanzibar, conspicuous by the bright blue in its plumage, the hackles that adorn the lower part of its neck, and its long tail. By some writers it is thought to form a separate genus, *Acryllium*. All these guinea fowls except the last are characterized by having the crown bare of feathers and elevated into a bony "helmet," but there is another group (to which the name *Guttera* has been given) in which a thick tuft of feathers ornaments the top of the head. This contains four or five species, all inhabiting some part or other of Africa, the best known being the *N. cristata* from Sierra Leone and other places on the western coast. This bird, apparently mentioned by Marcgrave more than 200 years ago, but first described by Pallas, is remarkable for the structure—unique, if not possessed by its representative forms—of its *furcula*, where the head, instead of being the thin plate found in all other *Gallinæ*, is a hollow cup opening upwards, into which the trachea dips, and then emerges on its way to the lungs. Allied to the genus *Numida*, but readily distinguished therefrom among other characters by the possession of spurs and the absence of a helmet, are two very rare forms, *Agelastes* and *Phasioides*, both from western Africa. Of their habits nothing is known. All these birds are beautifully figured in Elliot's *Monograph of the Phasianidae*, from drawings by Wolf.

(A. N.)
GUINEA-WORM (*Dracontiasis*), a disease due to the *Filaria medinensis*, or *Dracunculus*, or Guinea-worm, a filariform nematode like a horse-hair, whose most frequent habitat is the subcutaneous and intramuscular tissues of the legs and feet. It is common on the Guinea coast, and in many other tropical and subtropical regions and has been familiarly known since ancient times. The condition of dracontiasis due to it is a very common one, and sometimes amounts to an epidemic. The black races are most liable, but Europeans of almost any social rank and of either sex are not altogether exempt. The worm lives in water, and, like the *Filaria sanguinis hominis*, appears to have an intermediate host for its larval stage. It is doubtful whether the worm penetrates the skin of the legs directly; it is not impossible that the intermediate host (a cyclops) which contains the larvae may be swallowed with the water, and that the larvae of the *Dracunculus* may be set free in the course of digestion.

GÜINES, a town in the interior of Havana province, Cuba, about 30 m. S.E. of Havana. Pop. (1907) 8053. It is situated on a plain, in the midst of a rich plantation district, chiefly devoted to the cultivation of tobacco. The first railway in Cuba was built from Havana to Güines between 1835 and 1838. One of the very few good highways of the island also connects Güines with the capital. The pueblo of Güines, which was built on a great private estate of the same name, dates back to about 1735. The church dates from 1850. Güines became a "villa" in 1814, and was destroyed by fire in 1817.

GUINGAMP, a town of north-western France, capital of an arrondissement in the department of Côtes-du-Nord, on the

² Specimens from the Gambia are said to be smaller, and have been described as distinct under the name of *N. vendakii*.
³ Darwin (*Anim. and Pl. under Domestication*, i. 294), gives this as the original stock of the modern domestic birds, but obviously by an accidental error. As before observed, it may possibly have been the true *pitlorhynchos* of the Greeks.

right bank of the Trieux; 20 m. W.N.W. of St Brieuc on the railway to Brest. Pop. (1906), town 6937, commune 9212. Its chief church, Notre-Dame de Bon-Secours, dates from the 14th to the 16th centuries, two towers rise on each side of the richly sculptured western portal and a third surmounts the crossing. A famous statue of the Virgin, the object of one of the most important "pardons" or religious pilgrimages in Brittany, stands in one of the two northern porches. The central square is decorated by a graceful fountain in the Renaissance style, restored in 1743. Remains of the ramparts and of the chateau of the dukes of Penthièvre, which belong to the 15th century, still survive. Guingamp is the seat of a sub-prefect and of a tribunal of first instance. It is an important market for dairy-cattle, and its industries include flour-milling, tanning and leather-dressing. Guingamp was the chief town of the countship (subsequently the duchy) of Penthièvre. The Gothic chapel of Grâces, near Guingamp, contains fine sculptures.

GUINNESS, the name of a family of Irish brewers. The firm was founded by ARTHUR GUINNESS, who about the middle of the 18th century owned a modest brewing-plant at Leixlip, a village on the upper reaches of the river Liffey. In or about 1759 Arthur Guinness, seeking to extend his trade, purchased a small porter brewery belonging to a Mr Rainsford at St James's Gate, Dublin. By careful attention to the purity of his product, coupled with a shrewd perception of the public taste, he built up a considerable business. But his third son, BENJAMIN LEE GUINNESS (1798-1868), may be regarded as the real maker of the firm, into which he was taken at an early age, and of which about 1825 he was given sole control. Prior to that date the trade in Guinness's porter and stout had been confined to Ireland, but Benjamin Lee Guinness at once established agencies in the United Kingdom, on the continent, in the British colonies and in America. The export trade soon assumed huge proportions; the brewery was continually enlarged, and when in 1855 his father died, Benjamin Lee Guinness, who in 1851 was elected first lord mayor of Dublin, found himself sole proprietor of the business and the richest man in Ireland. Between 1860 and 1865 he devoted a portion of this wealth to the restoration of St Patrick's cathedral, Dublin. The work, the progress of which he regularly superintended himself, cost £100,000. Benjamin Lee Guinness represented the city of Dublin in parliament as a Conservative from 1865 till his death, and in 1867 was created a baronet. He died in 1868, and was succeeded in the control of the business by Sir Arthur Edward Guinness (b. 1840), his eldest, and Edward Cecil Guinness (b. 1847), his third son. Sir ARTHUR EDWARD GUINNESS, who for some time represented Dublin in parliament, was in 1880 raised to the peerage as Baron Ardilaun, and about the same time disposed of his share in the brewery to his brother Edward Cecil Guinness. In 1886 EDWARD CECIL GUINNESS disposed of the brewery, the products of which were then being sent all over the world, to a limited company, in which he remained the largest shareholder. Edward Cecil Guinness was created a baronet in 1885, and in 1891 was raised to the peerage as Baron Iveagh.

The Guinness family have been distinguished for their philanthropy and public munificence. Lord Ardilaun gave a recreation ground to Dublin, and the famous Muckross estate at Killarney to the nation. Lord Iveagh set aside £250,000 for the creation of the Guinness trust (1886) for the erection and maintenance of buildings for the labouring poor in London and Dublin, and was a liberal benefactor to the funds of Dublin university.

GUINOBATAN, a town of the province of Albay, Luzon, Philippine Islands, on the Inaya river, 9 m. W. by N. of the town of Albay. Pop. (1903), 20,027. Its chief interest is in hemp, which is grown in large quantities in the neighbouring country.

GUIPÚZCOA, a maritime province of northern Spain, included among the Basque provinces, and bounded on the N. by the Bay of Biscay; W. by the province of Biscay (*Viscaya*); S. and S.E. by Álava and Navarre; and N.E. by the river Bidassoa,¹

¹ A small island in the Bidassoa, called La Isla de los Faisanes, or l'Isle de la Conférence, is celebrated as the place where the marriage

which separates it from France. Pop. (1900), 195,850; area, 728 sq. m. Situated on the northern slope of the great Cantabrian chain at its junction with the Pyrenees, the province has a great variety of surface in mountain, hill and valley; and its scenery is highly picturesque. The coast is much indented, and has numerous harbours, but none of very great importance; the chief are those of San Sebastian, Pasajes, Guetaria, Deva and Fuenterrabia. The rivers (Deva, Urola, Oria, Urumea, Bidassoa) are all short, rapid and unnavigable. The mountains are for the most part covered with forests of oak, chestnut or pine; holly and arbutus are also common, with furze and heath in the poorer parts. The soil in the lower valleys is generally of hard clay and unferile; it is cultivated with great care, but the grain raised falls considerably short of what is required for home consumption. The climate, though moist, is mild, pleasant and healthy; fruit is produced in considerable quantities, especially apples for manufacture into *saragus* or cider. The chief mineral products are iron, lignite, lead, copper, zinc and cement. Ferruginous and sulphurous springs are very common, and are much frequented every summer by visitors from all parts of the kingdom. There are excellent fisheries, which supply the neighbouring provinces with cod, tunny, sardines and oysters; and the average yearly value of the coasting trade exceeds £400,000. By Irun, Pasajes and the frontier roads £4,000,000 of imports and £3,000,000 of exports pass to and from France, partly in transit for the rest of Europe. Apart from the four Catalan provinces, no province has witnessed such a development of local industries as Guipúzcoa. The principal industrial centres are Irun, Reñeria, Villabona, Vergara and Azpéitia for cotton and linen stuffs; Zumarraga for osies; Eibar, Plasencia and Elgoibar for arms and cannon and gold incrustations; Irun for soap and carriages; San Sebastian, Irun and Onate for paper, glass, chemicals and saw-mills; Tolosa for paper, timber, cloths and furniture; and the banks of the bay of Pasajes for the manufacture of liqueurs of every kind, and the preparation of wines for export and for consumption in the interior of Spain. This last industry occupies several thousand French and Spanish workmen. An arsenal was established at Azpéitia during the Carlist rising of 1870-1874; but the manufacture of ordnance and gunpowder was subsequently discontinued. The main line of the northern railway from Madrid to France runs through the province, giving access, by a loop line, to the chief industrial centres. The custom-house through which it passes on the frontier is one of the most important in Spain. Despite the steep gradients, where traffic is hardly possible except by ox-carts, there are over 350 m. of admirably engineered roads, maintained solely by the local tax-payers. After San Sebastian, the capital (pop. 1900, 37,812), the chief towns are Fuenterrabia (4,345) and Irun (9,912). Other towns with more than 6000 inhabitants are Azpéitia (6,066), Eibar (6,583), Tolosa (8,111) and Vergara (6,196). Guipúzcoa is the smallest and one of the most densely peopled provinces of Spain, for its constant losses by emigration are counterbalanced by a high birth-rate and the influx of settlers from other districts who are attracted by its industrial prosperity.

For an account of its inhabitants and their customs, language and history, see **BASQUES** and **BASQUE PROVINCES**.

GUIRAUD, ERNEST (1837-1892), French composer, was born at New Orleans on the 26th of June 1837. He studied at the Paris Conservatoire, where he won the *grand prix de Rome*. His father had gained the same distinction many years previously, this being the only instance of both father and son obtaining this prize. Ernest Guiraud composed the following operas: *Sylvie* (1864), *Le Kobold* (1870), *Madame Turlupin* (1872), *Piccolino* (1876), *Galante Aventure* (1882), and also the ballet *Gretna Green*, given at the Opéra in 1873. His opera *Frédérigo* was left in an unfinished condition and was completed by Camille Saint-Saëns. Guiraud, who was a fellow-student and intimate of the duke of Guenne was arranged between Louis XI. and Henry IV. in 1469, where Francis I., the prisoner of Charles V., was exchanged for his two sons in 1526, and where in 1659 "the Peace of the Pyrenees" was concluded between D. Luis de Haro and Cardinal Mazarin.

friend of Georges Biset, was for some years professor of composition at the Conservatoire. He was the author of an excellent treatise on instrumentation. He died in Paris on the 6th of May 1892.

GUIBOROUGH, or **GUINBOROUGH**, a market town in the Cleveland parliamentary division of the North Riding of Yorkshire, England, 20 m. E.S.E. of Middlesbrough by a branch of the North-Eastern railway. Pop. of urban district (1901), 3642. It is well situated in a narrow, fertile valley at the N. foot of the Cleveland Hills. The church of St Nicholas is Perpendicular, greatly restored. Other buildings are the town hall, and the modern buildings of the grammar school founded in 1562. Ruins of an Augustinian priory, founded in 1129, are beautifully situated near the eastern extremity of the town. The church contains some fine Decorated work, and the chapter house and parts of the conventual buildings may be traced. Considerable fragments of Norman and transitional work remain. Among the historic personages who were buried within its walls was Robert Bruce, lord of Annandale, the competitor for the throne of Scotland with John Balliol, and the grandfather of King Robert the Bruce. About 2 m. S.E. of the town there is a sulphurous spring discovered in 1822. The district neighbouring Guisborough is rich in iron-stone. Its working forms the chief industry of the town, and there are also tanneries and breweries.

GUISE, a town of northern France, in the department of Aisne, on the Oise, 31 m. N. of Laon by rail. Pop. (1906), 7562. The town was formerly the capital of the district of Thiérache and afterwards of a countship (see below). There is a chateau dating in part from the middle of the 16th century. Camille Desmoulins was in 1762 born in the town, which has erected a statue to him. The chief industry is the manufacture of iron stoves and heating apparatus, carried on on the co-operative system in works founded by J. B. A. Godin, who built for his workpeople the huge buildings known as the *familistère*, in front of which stands his statue. A board of trade-arbitration is among the public institutions.

GUISE, HOUSE OF, a cadet branch of the house of Lorraine (q.v.). René II., duke of Lorraine (d. 1508), united the two branches of the house of Lorraine. From his paternal grandmother, Marie d'Harcourt, René inherited the countships of Aumale, Mayenne, Elbeuf, Lillebonne, Brienne and other French fiefs, in addition to the honours of the elder branch, which included the countship of Guise, the dowry of Marie of Blois on her marriage in 1333 with Rodolph or Raoul of Lorraine. René's eldest surviving son by his marriage with Philippa, daughter of Adolphus of Egmout, duke of Gelderland, was Anthony, who succeeded his father as duke of Lorraine (d. 1544), while the second, Claude, count and afterwards duke of Guise, received the French fiefs. The Guises, though naturalised in France, continued to interest themselves in the fortunes of Lorraine, and their enemies were always ready to designate them as foreigners. The partition between the brothers Anthony and Claude was ratified by a further agreement in 1530, reserving the fabled honours of the Kingdoms of Jerusalem, Sicily, Aragon, the duchy of Anjou and the countships of Provence and Maine to the duke of Lorraine. Of the other sons of René II., John (1498-1550) became the first cardinal of Lorraine while Ferris, Louis and Francis fell fighting in the French armies at Marignano (1515), Naples (1528) and Pavia (1525) respectively.

CLAUDE OF LORRAINE, count and afterwards 1st duke of Guise (1496-1550), was born on the 20th of October 1496. He was educated at the French court, and at seventeen allied himself to the royal house of France by a marriage with Antoinette de Bourbon (1493-1583) daughter of François, Count of Vendôme. Guise distinguished himself at Marignano (1515); and was long in recovering from the twenty-two wounds he received in the battle; in 1521 he fought at Foenterrabia, when Louise of Savoy ascribed the capture of the place to his efforts; in 1522 he defended northern France, and forced the English to raise the siege of Hesdin; and in 1523 he obtained the government of Champagne and Burgundy, defeating at Neufchâteau the

imperial troops who had invaded his province. In 1525 he destroyed the Anabaptist peasant army, which was overrunning Lorraine, at Lupstein, near Saverny (Zabern). On the return of Francis I. from captivity, Guise was erected into a duchy in the peerage of France, though up to this time only princes of the royal house had held the title of duke and peer of France. The Guises, as cadets of the sovereign house of Lorraine and descendants of the house of Anjou, claimed precedence of the Bourbon princes. Their pretensions and ambitions inspired distrust in Francis I., although he rewarded Guise's services by substantial gifts in land and money. The duke distinguished himself in the Lauenburg campaign in 1542, but for some years before his death he effaced himself before the growing fortunes of his sons. He died on the 12th of April 1550.

He had been supported in all his undertakings and intrigues by his brother JOSH, cardinal of Lorraine (1498-1550), who had been made coadjutor of Metz at the age of three. The cardinal was archbishop of Reims, Lyons and Narbonne, bishop of Metz, Toul, Verdun, Thérouanne, Luçon, Albi, Valence; Nantes and Agen, and before he died had squandered most of the wealth which he had derived from these and other benefices. Part of his ecclesiastical preferments he gave up in favour of his nephews. He became a member of the royal council in 1530, and in 1536 was entrusted with an embassy to Charles V. Although a complainant helper in Francis I.'s pleasures, he was disgraced in 1542, and retired to Rome. He died at Nogent-sur-Yonne on the 18th of May 1550. He was extremely dissolute, but as an open-handed patron of art and learning, as the protector and friend of Erasmus, Marot and Rabelais he did something to counter-balance the general unpopularity of his calculating and avaricious brother.

CLAUDE OF GUISE had twelve children, among them Francis, 2nd duke of Guise; Charles, and cardinal of Lorraine (1524-1574), who became archbishop of Reims in 1538 and cardinal in 1547; Claude, marquis of Mayenne, duke of Aumale (1526-1573), governor of Burgundy, who married Louise de Brézé, daughter of Diane de Poitiers, thus securing a powerful ally for the family; Louis (1527-1578), bishop of Troyes, archbishop of Sens and cardinal of Guise; René, marquis of Elbeuf (1536-1566), from whom descended the families of Harcourt, Armagnac, Marsais and Lillebonne; Mary of Lorraine (q.v.), generally known as Mary of Guise, who after the death of her second husband, James V. of Scotland, acted as regent of Scotland for her daughter Mary, queen of Scots; and Francis (1534-1563), grand prior of the order of the Knights of Malta. The solidarity of this family, all the members of which through three generations cheerfully submitted to the authority of the head of the house, made it a formidable factor in French politics.

FRANCIS OF LORRAINE, 2nd duke of Guise (1519-1563), "le grand Guise," was born at Bar on the 17th of February 1519. As count of Aumale he served in the French army, and was nearly killed at the siege of Boulogne in 1545 by a wound which brought him the name of "Balafre." Aumale was made (1547) a peerage-duchy in his favour, and on the accession of Henry II. the young duke, who had paid assiduous court to Diane de Poitiers, shared the chief honours of the kingdom with the constable Anne de Montmorency. Both cherished ambitions for their families, but the Guises were more unscrupulous in subordinating the interests of France to their own. Montmorency's brutal manners, however, made enemies where Guise's grace and courtesy won him friends. Guise was a suitor for the hand of Jeanne d'Albret, princess of Navarre, who refused, however, to become a sister-in-law of a daughter of Diane de Poitiers and remained one of the most dangerous and persistent enemies of the Guises. He married in December 1548 Anne of Este, daughter of Ercole II., duke of Ferrara, and through her mother Renée, a granddaughter of Louis XII. of France. In the same year he had put down a peasant rising in Saintonge with a humanity that compared very favourably with the cruelty shown by Montmorency to the town of Bordeaux. He made preparations in Lorraine for the king's German campaign of 1551-52. He was already governor of Dauphiné, and now became grand chamberlain, prince of Joinville, and hereditary seneschal of Champagne, with large additions to his already considerable revenues. He was charged with the defence of Metz, which Henry II. had entered in 1552. He reached the

city in August 1552, and rapidly gave proof of his great powers as a soldier and organizer by the skill with which the place, badly fortified and unprovided with artillery, was put in a state of defence. Metz was invested by the duke of Alva in October with an army of 60,000 men, and the emperor joined his forces in November. An army of brigands commanded by Albert of Brandenburg had also to be reckoned with. Charles was obliged to raise the siege on the 2nd of January 1553, having lost, it is said, 30,000 men before the walls. Guise used his victory with rare moderation and humanity, providing medical care for the sick and wounded left behind in the besiegers' camp. The subsequent operations were paralysed by the king's suspicion and carelessness, and the constable's inactivity, and a year later Guise was removed from the command. He followed the constable's army as a volunteer, and routed the army of Charles V. at the siege of Renty on the 12th of August 1554. Montmorency's inaction rendered the victory fruitless, and a bitter controversy followed between Guise and the constable's nephew Coligny, admiral of France, which widened a breach already existing.

The conclusion of a six years' truce at Vascelles (1556) disappointed Guise's ambitions, and he was the main mover in the breach of the treaty in 1558, when he was sent at the head of a French army to Italy to the assistance of Pope Paul IV. against Spain. Guise, who perhaps had in view the restoration to his family of the Angevin dominion of Naples and Sicily, crossed the Alps early in 1557 and after a month's delay in Rome, where he failed to receive the promised support, marched on the kingdom of Naples, then occupied by the Spanish troops under Alva. He seized and sacked Campi (April 17th), but was compelled to raise the siege of Civitella. Meanwhile the pope had veered round to a Spanish alliance, and Guise, seeing that no honour was to be gained in the campaign, wisely spared his troops, so that his army was almost intact when, in August, he was hastily summoned home to repel the Spanish army which had invaded France from the north, and had taken St Quentin. On reaching Paris in October Guise was made lieutenant-general of the kingdom, and proceeded to prepare for the siege of Calais. The town was taken, after six days' fighting, on the 6th of January 1558, and this success was followed up by the capture of Guines, Thionville and Arlon, when the war was ended by the treaty of Câteau Cambresis (1559). Although his brother, the cardinal of Lorraine, was one of the negotiators, this peace was concluded against the wishes of Guise, and was regarded as a triumph of the constable's party. The Guises were provided with a weapon against Montmorency by the bishop of Arras (afterwards Cardinal Granvella), who gave to the cardinal of Lorraine at an interview at Péronne in 1558 an intercepted letter proving the Huguenot leanings of the constable's nephews.

On the accession in 1559 of Francis II., their nephew by marriage with Mary Stuart, the royal authority was practically delegated to Guise and the cardinal, who found themselves beyond rivalry for the time being. They had, however, to cope with a new and dangerous force in Catherine de' Medici, who was now for the first time free to use her political ability. The incapacity, suspicion and cruelty of the cardinal, who controlled the internal administration, roused the smaller nobility against the Lorraine princes. A conspiracy to overturn their government was formed at Nantes, with a needy Périgord nobleman named La Renaudie as its nominal head, though the agitation had in the first instance been fostered by the agents of Louis I., prince of Condé. The Guises were warned of the conspiracy while the court was at Blois, and for greater security removed the king to Amboise. La Renaudie, nothing daunted, merely postponed his plans; and the conspirators assembled in small parties in the woods round Amboise. They had, however, been again betrayed, and many of them were surrounded and taken before the *coup* could be delivered; one party, which had seized the château of Nolsay, surrendered on a promise of amnesty given "on his faith as a prince" by James of Savoy, duke of Nemours, a promise which, in spite of the duke's protest, was disregarded. On the 19th of March 1560, La Renaudie and

the rest of the conspirators openly attacked the château of Amboise. They were repelled; their leader was killed; and a large number were taken prisoners. The merciless vengeance of the Guises was the measure of their previous fears. For a whole week the torturings, quarterings and hangings went on, the bodies being cast into the Loire, the young king and queen witnessing the bloody spectacle day by day from a balcony of the château.

The cruel repression of this "conspiracy of Amboise" inspired bitter hatred of the Guises, since they were avenging a rising rather against their own than the royal authority. They now entrenched themselves with the king at Orleans, and the Bourbon princes, Anthony, king of Navarre, and his brother Condé, were summoned to court. The Guises conveyed a special commission to try Condé, who was condemned to death; but the affair was postponed by the chancellor, and the death of Francis II. in December saved Condé. Guise then made common cause with his old rival Montmorency and with the Marshal de Saint André against Catherine, the Bourbons and Coligny. This alliance, constituted on the 6th of April 1561, and known as the triumvirate, aimed at the annulment of the concessions made by Catherine to the Huguenots. The cardinal of Lorraine fomented the discord which appeared between the clergy of the two religions when they met at the colloquy of Poissy in 1561, but in spite of the extreme Catholic views he there professed, he was at the time in communication with the Lutheran princes of Germany, and in February 1562 met the duke of Württemberg at Zabern to discuss the possibility of a religious compromise.

The signal for civil war was given by an attack of Guise's escort on a Huguenot congregation at Vassy (1st of March 1562). Although Guise did not initiate the massacre, and although, when he learned what was going on, he even tried to restrain his soldiers, he did not disavow their action. When Catherine de' Medici forbade his entry into Paris, he accepted the challenge, and on the 16th of March he entered the city, where he was a popular hero, at the head of 8000 armed nobles. The provost of the merchants offered to put 20,000 men and two million livres at his disposal. In September he joined Montmorency in besieging Rouen, which was sacked as if it had been a foreign city, in spite of Guise's efforts to save it from the worst horrors. At the battle of Dreux (19th of December 1562) he commanded a reserve army, with which he saved Montmorency's forces from destruction and inflicted a crushing defeat on the Huguenots. The prince of Condé was his prisoner, while the capture of Montmorency by the Huguenots and the assassination of the Marshal de Saint-André after the battle left Guise the undisputed head of the Catholic party. He was appointed lieutenant-general of the kingdom, and on the 5th of February 1563 he appeared with his army before Orleans. On the 19th, however, he was shot by the Huguenot Jean Poltrot de Mézières as he was returning to his quarters, and died on the 24th of the effects of the wound. Guise's splendid presence, his generosity and humanity and his almost unvarying success on the battlefield made him the idol of his soldiers. He attended personally to the minutest details, and Montluc complains that he even wrote out his own orders. The mistakes and cruelties associated with his name were partly due to the evil counsels of his brother Charles, the cardinal, whose cowardice and insincerity were the scorn of his contemporaries. The negotiations of the Guises with Spain dated from the interview with Granvella at Péronne, in 1558, and after the death of his brother the cardinal of Lorraine was constantly in communication with the Spanish court, offering, in the event of the failure of direct heirs to the Valois kings, to deliver up the frontier fortresses and to acknowledge Philip II. as king of France. His death in 1574 temporarily weakened the extreme Catholic party.

Of the children of Francis "de Blainfré" five survived him: Henry, 3rd duke of Guise; Charles, duke of Mayenne (1554-1611) (g.a.), who consolidated the League; Catherine (1552-1596), who married Louis of Bourbon, duke of Montpensier, and encouraged the fanaticism of the Parisian leaguers; Louis, second cardinal of Guise, afterwards of Lorraine (1555-1588), who was assassinated with his brother Henry; and Francis (1558-1573).

HENRY OF LORRAINE, 3rd duke of Guise (1550-1588), born on the 31st of December 1550, was thirteen years old at the time of his father's death, and grew up under the domination of a passionate desire for revenge. Catherine de' Medici refused to take steps against Coligny, who was formally accused by the duchess of Guise and her brothers-in-law of having incited the murder. In 1566 she insisted on a formal reconciliation at Moulins between the Guises and Coligny, at which, however, none of the sons of the murdered man was present. Henry and his brothers were, however, compelled in 1572 to sign an ambiguous assent to this agreement. Guise's widow married James of Savoy, duke of Nemours, and the young duke at sixteen went to fight against the Turks in Hungary. On the fresh outbreak of civil war in 1567 he returned to France and served under his uncle Aumale. In the autumn of 1568 he received a considerable command, and speedily came into rivalry with Henry of Valois, duke of Anjou. He had not inherited his father's generalship, and his rashness and headstrong valour more than once brought disaster on his troops, but the showy quality of his fighting brought him great popularity in the army. In the defence of Poitiers in 1569 with his brother, the duke of Mayenne, he showed more solid abilities as a soldier. On the conclusion of peace in 1570 he returned to court, where he made no secret of his attachment to Margaret of Valois. His pretensions were violently resented by her brothers, who threatened his life, and he saved himself by a precipitate marriage with Catherine of Cleves (daughter of Francis of Cleves, duke of Nevers, and Margaret of Bourbon), the widow of a Huguenot nobleman, Antoine de Crog, prince of Porcien. Presently he ended his disgrace by an apparent reconciliation with Henry of Valois and an alliance with Catherine de' Medici. He was an accomplice in the first attack on Coligny's life, and when permission for the massacre of Saint Bartholomew had been extorted from Charles IX. he roused Paris against the Huguenots, and satisfied his personal vengeance by superintending the murder of Coligny. He was now the acknowledged chief of the Catholic party, and the power of his family was further increased by the marriage (1575) of Henry III. with Louise of Vaudémont, who belonged to the elder branch of the house of Lorraine. In a fight at Dormans (10th of October 1575), the only Catholic victory in a disastrous campaign, Guise received a face wound which won for him his father's name of Balafre and helped to secure the passionate attachment of the Parisians. He refused to acquiesce in the treaty of Beaulieu (5th of May 1576), and with the support of the Jesuits proceeded to form a "holy league" for the defence of the Roman Catholic Church. The terms of enrolment enjoined offensive action against all who refused to join. This association had been preceded by various provincial leagues among the Catholics, notably one at Péronne. Condé had been imposed on this town as governor by the terms of the peace, and the local nobility banded together to resist him. This, like the Holy League itself, was political as well as religious in its aims, and was partly inspired by revolt against the royal authority. In the direction of the League Guise was hampered by Philip of Spain, who subsidized the movement, while he also had to submit to the dictation of the Parisian democracy. Ulterior ambitions were freely ascribed to him. It was asserted that papers seized from his envoy to Rome, Jean David, revealed a definite design of substituting the Lorraines, who represented themselves as the successors of Charlemagne, for the Valois; but these papers were probably a Huguenot forgery. Henry III. eventually placed himself at the head of the League, and resumed the war against the Huguenots; but on the conclusion of peace (September 1577) he seized the opportunity of disbanding the Catholic associations. The king's jealousy of Guise increased with the duke's popularity, but he did not venture on an open attack, nor did he dare to avenge the murder by Guise's partisans of one of his personal favourites, Saint-Mégrin, who had been set on by the court to compromise the reputation of the duchess of Guise.¹

¹ This incident supplied Alexandre Dumas père with the subject of his *Henri III et sa cour* (1829).

Meanwhile the duke had entered on an equivocal alliance with Don John of Austria. He was also in constant correspondence with Mary of Lorraine, and meditated a descent on Scotland in support of the Catholic cause. But the great riches of the Guises were being rapidly dissipated, and in 1578 the duke became a pensioner of Philip II. When in 1584 the death of the duke of Anjou made Henry of Navarre the next heir to the throne, the prospect of a Huguenot dynasty roused the Catholics to forget their differences, and led to the formation of a new league of the Catholic nobles. At the end of the same year Guise and his brother, the duke of Mayenne, with the assent of other Catholic nobles, signed a treaty at Joinville with Philip II., fixing the succession to the crown on Charles, cardinal of Bourbon, to the exclusion of the Protestant princes of his house. In March 1585 the chiefs of the League issued the Déclaration of Péronne, exposing their grievances against the government and announcing their intention to restore the dignity of religion by force of arms. On the refusal of Henry III. to accept Spanish help against his Huguenot subjects, war broke out. The chief cities of France declared for the League, and Guise, who had recruited his forces in Germany and Switzerland, took up his headquarters at Châlons, while Mayenne occupied Dijon, and his relatives, the dukes of Elbeuf, Aumale and Mercœur, roused Normandy and Brittany. Henry III. accepted, or feigned to accept, the terms imposed by the Guises at Nemours (7th of July 1585). The edicts in favour of the Huguenots were immediately revoked. Guise added to his reputation as the Catholic champion by defeating the German auxiliaries of the Huguenots at Vimory (October 1587) and Auneau (November 1587). The protestations of loyalty to Henry III. which had marked the earlier manifestoes of the League were modified. Obedience to the king was now stated to depend on his giving proof of Catholic zeal and showing no favour to heresy. In April 1588 Guise arrived in Paris, where he put himself at the head of the Parisian mob, and on the 12th of May, known as the Day of the Barricades, he actually had the crown within his grasp. He refused to treat with Catherine de' Medici, who was prepared to make peace at any cost, but restrained the populace from revolution and permitted Henry to escape from Paris. Henry came to terms with the League in May, and made Guise lieutenant-general of the royal armies. The estates-general, which were assembled at Blois, were devoted to the Guise interest, and alarmed the king by giving voice to the political as well as the religious aspirations of the League. Guise remained at the court of Blois after receiving repeated warnings that Henry meditated treason. On the 25th of December he was summoned to the king's chamber during a sitting of the royal council, and was murdered by assassins carefully posted by Henry III. himself. The cardinal of Lorraine was murdered in prison on the next day. The history of the Guises thenceforward centres in the duke of Mayenne (q.v.).

By his wife, Catherine of Cleves, the third duke had fourteen children: among them Charles, 4th duke of Guise (1571-1640); Claude, duke of Chevreuse (1578-1657), whose wife, Marie de Rohan, duchess of Chevreuse, became famous for her intrigues; Louis (1585-1621), 3rd cardinal of Guise, archbishop of Reims, remembered for his liaison with Charlotte de Essarts, mistress of Henry IV.

CHARLES, 4th duke of Guise (1571-1640), was imprisoned for three years after his father's death. He married Henriette Cathérine de Joyeuse, widow of the duke of Montpensier. His eldest son predeceased him, and he was succeeded by his second son **HENRY** (1614-1664), who had been archbishop of Reims, but renounced the ecclesiastical estate and became 5th duke. He made an attempt (1647) on the crown of Naples, and was a prisoner in Spain from 1648 to 1652. A second expedition to Naples in 1654 was a fiasco. He was succeeded by his nephew, **LOUIS JOSEPH** (1650-1671), as 6th duke. With his son, **FRANCIS JOSEPH** (1670-1675), the line failed; and the title and estates passed to his great-aunt, Marie of Lorraine, duchess of Guise.
¹ Philippe-Emmanuel of Lorraine, duke of Mercœur, a cadet of Lorraine and brother of Louise de Vaudémont, Henry III.'s queen. His wife, Mary of Luxemburg, descended from the dukes of Brittany, and he was made governor of the province in 1582. He aspired to separate sovereignty, and called his son prince and duke of Brittany.

GENEALOGICAL TABLE OF THE HOUSE OF GUISE

René II. (who united the two branches of the house of Lorraine, duke of Lorraine, and Philippa of Clefderland, had (besides two older boys who died in childhood, and four unmarried daughters)

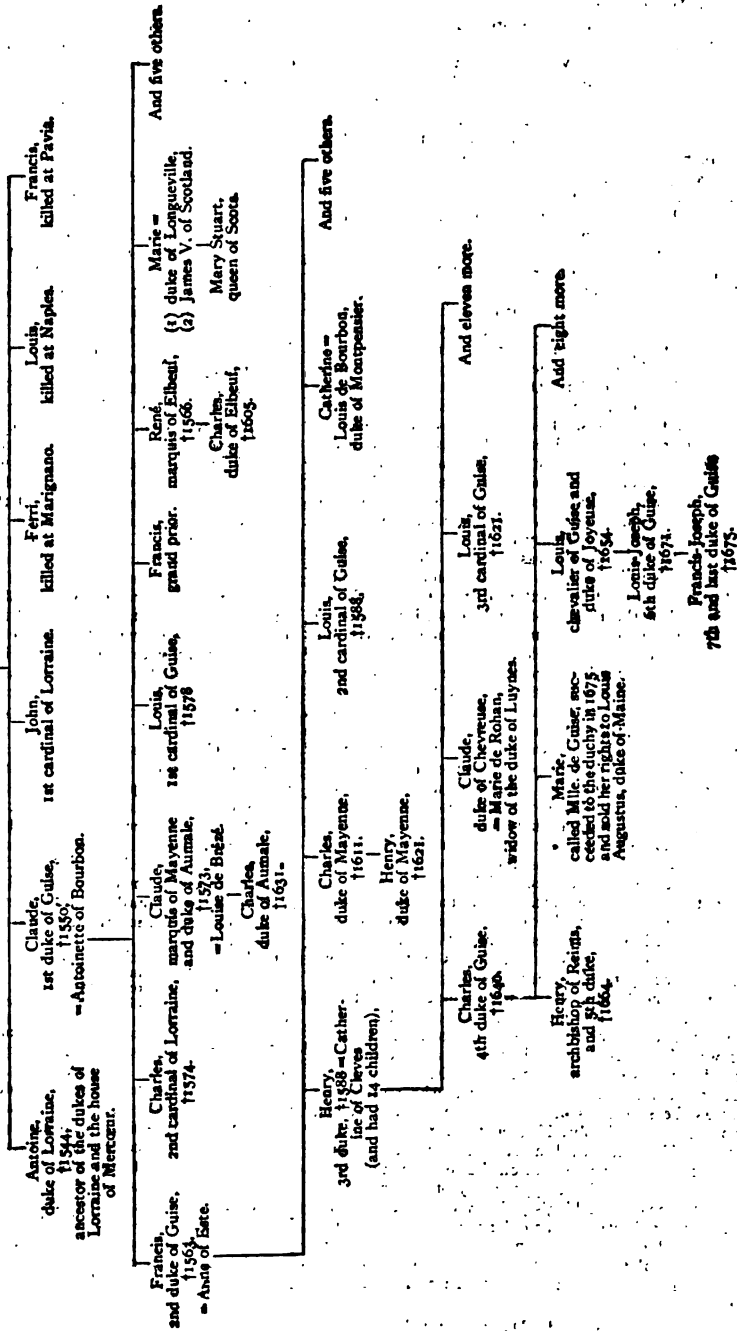

(1615-1688), daughter of the 4th duke, and with her the title became extinct. The title is now vested in the family of the Bourbon-Orleans princes.

AUTHORITIES.—A number of contemporary documents relating to the Guises are included by L. Cimber and F. Danjou in their *Archives Curieuses de l'histoire de France* (Paris, 1834, &c.). Vol. iii. contains a soldier's diary of the siege of Metz, first published in Italian (Lyons, 1553), accounts of the sieges of Calais (Tours, 1558), of Thionville (Paris, 1558); vol. iv. an account of the tumult of Amboise from the *Mémoires* of Condé, and four accounts of the affair of Vassy; vol. v. four accounts of the battle of Dreux, one dictated by Guise, and accounts of the murder of Guise; vol. xi. accounts of the Parisian revolution of 1558; and vol. xii. numerous pamphlets and pieces dealing with the murder of Henry of Guise and his brother. An account of the murder of Guise and of the subsequent measures taken by Mayenne, which was supplied by the Venetian ambassador, G. Mogenigo, to his government, is printed by H. Brown in the *Eng. Hist. Rev.* (April 1895). For the foreign policy of the Guises, and especially their relations with Scotland, there is abundant material in the English *Calendar of State Papers* of Queen Elizabeth (Foreign Series) and in the correspondence of Cardinal Granvelle. The memoirs of Francis, duke of Guise, covering the years 1547 to 1563, were published by Miché and Poujoulat in series I, vol. iv. of their *Coll. de mémoires*. Among contemporary memoirs see especially those of the prince of Condé, of Blaise de Monluc and of Gaspard de Saulx-Tavannes. See also *La Vie de F. de Lorraine, duc de Guise* (Paris, 1681); by J. B. H. du Trousset de Valincourt; A. de Ruble, *L'Assassinat de F. de Lorraine, duc de Guise* (1897), where there is a list of the MS. sources available for a history of the house; R. de Bouillé, *Hist. des ducs de Guise* (2 vols., 1849); H. Forneron, *Les Guise et leur époque* (2 vols., 1897).

GUITAR (Fr. *guitarre*, Ger. *Guitarre*, Ital. *chitarra*, Span. *guitarra*), a musical instrument strung with gut strings twanged by the fingers, having a body with a flat back and graceful incurvations in complete contrast to the members of the family of lute (*q.v.*), whose back is vaulted. The construction of the instrument is of paramount importance in assigning to the guitar its true position in the history of musical instruments, midway between the cithara (*q.v.*) and the violin. The medieval stringed instruments with neck fall into two classes, characterized mainly by the construction of the body: (1) Those which, like their archetype the cithara, had a body composed of a flat or delicately arched back and soundboard joined by ribs. (2) Those which, like the lyre, had a body consisting of a vaulted back over which was glued a flat soundboard without the intermediary of ribs; this method of construction predominates among Oriental instruments and is greatly inferior to the first. A striking proof of this inferiority is afforded by the fact that instruments with vaulted backs, such as the rebab or rebec, although extensively represented during the middle ages in all parts of Europe by numerous types, have shown but little or no development during the course of some twelve centuries, and have dropped out one by one from the realm of practical music without leaving a single survivor. The guitar must be referred to the first of these classes.

The back and ribs of the guitar are of maple, ash or cherry-wood, frequently inlaid with rose-wood, mother-of-pearl, tortoise-shell, &c., while the soundboard is of pine and has one large ornamental rose sound hole. The bridge, to which the strings are fastened, is of ebony with an ivory nut which determines the one end of the vibrating strings, while the nut at the end of the fingerboard determines the other. The neck and fingerboard are made of hard wood, such as ebony, beech or pear. The head, bent back from the neck at an obtuse angle contains two parallel barrels or long holes through

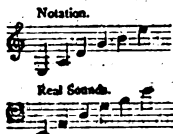

which the pegs or metal screws pass, three on each side of the head. The correct positions for stopping the intervals are marked on the fingerboard by little metal ridges called frets. The modern guitar has six strings, three of gut and three of silk covered with silver wire, tuned as shown. To the thumb are assigned the three deepest strings, while the first, second and third fingers are used to twang the highest strings. It is generally stated that the sixth or lowest string was added in 1790 by Jacob August Otto of Jena, who was the first in Germany to take up the construction of guitars

after their introduction from Italy in 1788 by the duchess Amalie of Weimar. Otto¹ states that it was Capelmeister Naumana of Dresden who requested him to make him a guitar with six strings by adding the low E, a spun wire string. The original guitar brought from Italy by the duchess Amalie had five strings,² the lowest A being the only one covered with wire. Otto also covered the D in order to increase the fulness of the tone. In Spain six-stringed guitars and vihuelas were known in the 16th century; they are described by Juan Bermudo³ and others.⁴ The lowest string was tuned to G. Other Spanish guitars of the same period had four, five or seven strings or courses of strings in pairs of unisons. They were always twanged by the fingers.

The guitar is derived from the cithara⁵ both structurally and etymologically. It is usually asserted that the guitar was introduced into Spain by the Arabs, but this statement is open to the gravest doubts. There is no trace among the instruments of the Arabs known to us of any similar to the guitar in construction or shape, although a guitar (fig. 2) with slight incurvations was known to the ancient Egyptians.⁶ There is also extant a fine example of the guitar, with ribs and incurvations and a long neck provided with numerous frets, on a Hitite bas-relief on the domos at Euyuk (c. 1000 a.c.) in Cappadocia.⁷ Unless other monuments of much later date should come to light showing guitars with ribs, we shall be justified in assuming that the instrument, which required skill in construction, died out in Egypt and in Asia before the days of classic Greece, and had to be evolved anew from the cithara by the Greeks of Asia Minor. That the evolution should take place within the Byzantine Empire or in Syria would be quite consistent with the traditions of the Greeks and their veneration for the cithara, which would lead them to adapt the neck and other improvements to it, rather than adopt the rebab, the tanbur or the barbiton from the Persians or Arabians. This, in fact, what seems an enumeration of musical instruments by the Archbishop of Hita, a *guitarra morisca* is mentioned and unfavourably compared with the *guitarra latina*; moreover, the Arabs of the present day still use an instrument called *akira* (which in N. Africa would be guitarra), but it has a vaulted back, the body being like half a pear with a long neck; the strings are twanged by means of a quill. The Arab instrument therefore belongs to a different class, and to admit the instrument as the ancestor of the Spanish guitar would be tantamount to deriving the guitar from the lute.⁸

By piecing together various indications given by Spanish writers, we obtain a clue to the identity of the medieval instruments, which, in the absence of absolute proof, is entitled to serious consideration. From Bermudo's work, quoted above, we learn that the guitar and the *vihuela da mano* were practically identical, differing only in accordance and occasionally in the number of strings.⁹ Three kinds of vihuelas were known in Spain during the middle ages, distinguished by the qualifying phrases *da arco* (with bow), *da mano* (by hand), *da penola* (with quill). Spanish scholars¹⁰ who have inquired into this question of identity state that the *guitarra latina* was afterwards known as the *vihuela da mano*, a statement fully supported by



From Juan Bermudo.
FIG. 1.—Spanish Guitar with seven Strings. 1555. *Vihuela da Mano*.

¹ *Über den Bau der Bogeninstrumente* (Jena, 1828), pp. 94 and 95.

² See Pietro Millioni, *Vero e facil modo d' imparare a sonare et accordare da se medesimo la chitarra spagnola*, with illustration (Rome, 1637).

³ *Declaracion de instrumentos musicales* (Osuna, 1555), fol. xciii. b and fol. xci. a. See also illustration of *vihuela da mano* (Rome, 1637).

⁴ See also G. G. Kapsperger, *Libro primo di Villanelle con l' infavolutura del chitarone et alfabeto per la chitarra spagnola* (three books, Rome, 1610-1623).

⁵ See Kathleen Schlesinger, *The Instruments of the Orchestra*, part ii. "Precursors of the Violin Family," pp. 230-248.

⁶ See Denon's *Voyage en Egypte* (London, 1807, pl. 55).

⁷ Illustrated from a drawing in Perrot and Chipiez, "Judée Sardaigne, Syrie, Cappadoce." Vol. iv. of *Hist. de l'art dans l'antiquité*, Paris, 1887, p. 670. Also see plate from a photograph by Prof. John Garstang, in Kathleen Schlesinger, *op. cit.*

⁸ See Biernath, *Die Guitarre* (1908).

⁹ See also Luys Milan, *Libro de musica de vihuela da mano, intitulado El Maestro*, where the accordance is D, G, C, E, A, D from bass to treble.

¹⁰ Mariano Soriano, *Fuertes Historia de la musica española* (Madrid, 1855), i. 105, and iv. 208, &c.

other evidence. As the Arab *kasira* was known to be played by means of a quill, we shall not be far wrong in identifying it with the *vikula da penola*. The word *vikula* or *vigola* is connected with the Latin *fidicula* or *fidis*, a stringed instrument mentioned by Cicero¹ as being made from the wood of the plane-tree and having many strings. The remaining link in the chain of identification is afforded by St



From Demou's *Voyage en Egypte*.

FIG. 2.—Ancient Egyptian Guitar. 1700 to 1200 B.C.

Isidore, bishop of Seville in the 7th century, who states that *fidicula* was another name for *cithara*. "Veteres aut *citharas fidicula* vel *fidice nominaverunt*."² The *fidicula* therefore was the *cithara*, either in its original classical form or in one of the transitions which transformed it into the guitar. The existence of a superior *guitarra latina* side by side with the *guitarra morisca* is thus explained. It was derived directly from the classical *cithara* introduced by the Romans into Spain, the archetype of the structural beauty which formed the basis of the perfect proportions and delicate structure of the violin. In an inventory³ made by Philip van Wilder of the musical instruments which had belonged to Henry VIII. is the following item bearing on the question: "four gitterons with *iiii*. cases they are called *Spanische Vielle*." *Viel* or *viol* was the English equivalent of *vikula*. The transitions whereby the *cithara* acquired a neck and became a guitar are shown in the miniatures (fig. 3) of a single MS., the celebrated Utrecht Psalter, which gave rise to so many discussions. The Utrecht Psalter was executed in the diocese of Reims in the 9th century, and the miniatures, drawn by an Anglo-Saxon artist attached to the Reims school, are unique, and illustrate



FIG. 3.—Instrumentalists from the Utrecht Psalter, 9th century: (a) The bass rotta, first transition of *cithara* in (C); (b, c, d), Transitions showing the addition of neck to the body of the *cithara*.

the Psalter, psalm by psalm. It is evident that the Anglo-Saxon artist, while endowed with extraordinary talent and vivid imagination, drew his inspiration from an older Greek illustrated Psalter from the Christian East,⁴ where the evolution of the guitar took place.

One of the earliest representations (fig. 4) of a guitar in Western Europe occurs in a *Passionale* from Zwifalten A.D. 1180, now in the

¹ *De natura deorum*, ii. 8, 22.

² See *Etymologiarium*, lib. iii., cap. 21.

³ See British Museum, Harleian MS. 1419, fol. 200.

⁴ The literature of the Utrecht Psalter embraces a large number of books and pamphlets in many languages of which the principal are given: Professor J. O. Westwood, *Facsimiles of the Miniatures and Ornaments of Anglo-Saxon and Irish MSS.* (London, 1868); Sir Thos. Duffus-Hardy, *Report on the Athanasian Creed in connection with the Utrecht Psalter* (London, 1872); *Report on the Utrecht Psalter*, addressed to the Trustees of the British Museum (London, 1874); Sir Thomas Duffus-Hardy, *Further Report on the Utrecht Psalter* (London, 1874); Walter de Gray Birch, *The History, Art and Palaeography of the MS. styled the Utrecht Psalter* (London, 1876); Anton Springer, "Die Psalterillustrationen im frühen Mittelalter mit besonderer Rücksicht auf den Utrecht Psalter," *Abhandlungen der kgl. sächs. Ges. d. Wissenschaften, phil.-hist. Klasse*, Bd. viii. pp. 187-296, with 10 facsimile plates in autotype from the MS.; Adolf Goldschmidt, "Der Utrecht Psalter," in *Repertorium für Kunstwissenschaft*, Bd. xv. (Stuttgart, 1892), pp. 156-166; Franz Friedrich Leitschuh, *Geschichte der karolingischen Malerei, ihre Bilderkreise und seine Quellen* (Berlin, 1894), pp. 321-330; Adolf Goldschmidt, *Der Albani Psalter in Hildesheim*, 8c. (Berlin, 1895); Paul Durieu, *L'Origine du MS. célèbre dit le Psautier d'Utrecht* (Paris, 1895); Hans Graeven, "Die Vorlage des Utrecht Psalters," paper read before the XI. International Oriental Congress, Paris, 1897. See also *Repertorium für Kunstwissenschaft* (Stuttgart, 1898), Bd. xxi. pp. 28-35; J. J. Tilkänen, *Abendländische Psalter-Illustration im Mittelalter*, part iii. "Der Utrecht Psalter" (Helsingfors, 1900), 320 pp. and 77 pls. (Professor Tilkänen now accepts the Greek or Syrian origin of the Utrecht Psalter); Georg Swarzenski, "Die karolingische Malerei und Plastik in Reims," in *Jahrbuch d. kgl. preussischen Kunstsammlungen*, Bd. xxiii. (Berlin, 1902), pp. 81-100; Ormonde M. Dalton, "The Crystal of Lothair," in *Archæologie*, vol. lix. (1904);

Royal Library at Stuttgart.⁵ St Pelagia seated on an ass holds a rotta, or *cithara* in transition, while one of the men-servants leading her ass holds her guitar. Both instruments have three strings and the characteristic guitar outline with incurvations, the rotta differing in having no neck. Mersenne⁶ writing early in the 17th century



From Dr H. Janitschek's *Geschichte der deutschen*

Malerei. FIG. 4.—Representation of a European Guitar. A.D. 1180.

describes and figures two Spanish guitars, one with four, the other with five strings; the former had a cittern head, the latter the straight head bent back at an obtuse angle from the neck, as in the modern instrument; he gives the Italian, French and Spanish tablatures which would seem to show that the guitar already enjoyed a certain vogue in France and Italy as well as in Spain. Mersenne states that the proportions of the guitar *Malerri* demand that the length of the neck from shoulder to nut shall be equal to the length of the body from the centre of the rose to the tail end. From this time until the middle of the 19th century the guitar enjoyed great popularity on the continent, and became the fashionable instrument in England after the Peninsular War, mainly through the virtuosity of Ferdinand Sor, who also wrote compositions for it. This popularity of the guitar was due less to its merits as a solo instrument than to the ease with which it could be mastered sufficiently to accompany the voice. The advent of the Spanish guitar in England led to the wane in the popularity of the cittern, also known at that time in contradistinction as the English or wire-strung guitar, although the two instruments differed in many particulars. As further evidence of the great popularity of the guitar all over Europe may be instanced the extraordinary number of books extant on the instrument, giving instructions how to play the guitar and read the tablature.⁷ (K. S.)

GUITAR FIDDLE (*Troubadour Fiddle*), a modern name bestowed retrospectively upon certain precursors of the violin possessing characteristics of both guitar and fiddle. The name "guitar fiddle" is intended to emphasize the fact that the instrument in the shape of the guitar, which during the middle ages represented the most perfect principle of construction for stringed instruments with necks, adopted at a certain period the use of the bow from instruments of a less perfect type, the rebab and its hybrids. The use of the bow with the guitar entailed certain constructive changes in the instrument: the large central rose sound-hole was replaced by lateral holes of various shapes; the flat bridge, suitable for instruments whose strings were plucked, gave place to the arched bridge required in order to enable the bow to vibrate each string separately; the arched bridge, by raising the strings higher above the sound-board, made the stopping of strings on the neck extremely difficult if not impossible; this matter was adjusted by the addition of a finger-board of suitable shape and dimensions (fig. 1). At this stage the guitar fiddle possesses the essential features of



From Reihmann's *Geschichte der Bogensinstrumente*.

FIG. 1.—Typical Alto Guitar Fiddle, 15th century (Pinakothek, Munich).

Kathleen Schlesinger, *The Instruments of the Orchestra*, part ii. "The Precursors of the Violin Family," chap. viii. "The Question of the Origin of the Utrecht Psalter," pp. 352-382 (with illustrations), where all the foregoing are summarized.

⁵ Reproduced in Hubert Janitschek's *Geschichte der deutschen Malerei*, Bd. iii. of *Gesch. der deutschen Kunst* (Berlin, 1890), p. 118.

⁶ *Harmonie universelle* (Paris, 1636), livre ii. prop. xiv.

⁷ See C. F. Becker, *Darstellung der musik. Literatur* (Leipzig, 1836); and Wilhelm Tappert, "Zur Geschichte der Gitarre," in *Monatshefte für Musikgeschichte* (Berlin, 1882), No. 3. pp. 77-85.

the violin, and may justly claim to be its immediate predecessor¹ not so much through the viols which were the outcome of the Minnesinger fiddle with sloping shoulders, as through the intermediary of the Italian *fyra*, a guitar-shaped bowed instrument with from 7 to 12 strings.

From such evidence as we now possess, it would seem that the evolution of the early guitar with a neck from the Greek cithara took place under Greek influence in the Christian East. The various stages of this transition have been definitely established by the remarkable miniatures of the Utrecht Psalter.² Two kinds of citharas are shown: the antique rectangular,³ and the later design with rounded body having at the point where the arms are added indications of the waist or incurvations characteristic of the outline of the Spanish guitar.⁴ The first stage in the transition is shown by a cithara or rotta⁵ in which arms and transverse bar are replaced by a kind of frame repeating the outline of the body and thus completing the second lobe of the Spanish guitar. The next stages in the transition are concerned with the addition of a neck⁶ and of frets.⁷ All these instruments are twanged by the fingers. One may conclude that the use of the bow was either unknown at this time (c. 6th century A.D.), or that it was still confined to instruments of the rebab type. The earliest known representation of a guitar fiddle complete with bow⁸ (fig. 2) occurs in a Greek Psalter written and illuminated in Caesarea by the archpriest Theodoros in 1066 (British Museum, Add. MS. 19352). Instances of perfect guitar fiddles abound in the 13th century MSS. and monuments, as for instance in a picture by Cimabue (1240-1302), in the Pitti Gallery in Florence.⁹



From a Byzantine MS. in the British Museum.

FIG. 2.—Earliest example of the Guitar Fiddle. A.D. 1066.

As a natural consequence as soon as an extended compass can be obtained by stopping the strings. By the addition of a neck we obtain the clue to the origin of rectangular citterns with rounded corners and of certain instruments played with the bow whose bodies or sound-chests have an outline based upon the rectangle with various modifications. We may not look upon this type of guitar fiddle as due entirely to western or southern European initiative; its origin like that of the type approximating to the violin is evidently Byzantine. It is found among the frescoes which cover walls and barrel vaults in the palace of Koseir "Amra,"¹⁰ believed to be that of Caliph Walid II. (A.D. 744) of the Omayyad dynasty, or of Prince

Ahmad, the Abbasid (862-866). The instrument, a cithara with four strings, is being played by a bear. Other examples occur in the Stuttgart Carolingian Psalter¹¹ (10th century); in MS. 1260 (Bibl. Imp. Paris) *Tristan and Yseult*; as guitar fiddle in the Liber Regalis preserved in Westminster Abbey (14th century); in the *Sforza Book*¹² (1444-1476), the Book of Hours executed for Bona of Savoy, wife of Galeazzo Maria Sforza; on one of the carvings of the 13th century in the Cathedral of Amiens. It has also been painted by Italian artists of the 15th and 16th centuries. (K. S.)

GUITRY, LUCIEN GERMAIN (1860-), French actor, was born in Paris. He became prominent on the French stage at the Porte Saint-Martin theatre in 1900, and the Variétés in 1901, and then became a member of the Comédie Française, but he resigned very soon in order to become director of the Renaissance, where he was principally associated with the actress Marthe Brandès, who had also left the Comédie. Here he established his reputation, in a number of plays, as the greatest contemporary French actor in the drama of modern reality.

GUIZOT, FRANÇOIS PIERRE GUILLAUME (1787-1874), historian, orator and statesman, was born at Nîmes on the 4th of October 1787, of an honourable Protestant family belonging to the bourgeoisie of that city. It is characteristic of the cruel disabilities which still weighed upon the Protestants of France before the Revolution, that his parents, at the time of their union, could not be publicly or legally married by their own pastors, and that the ceremony was clandestine. The liberal opinions of his family did not, however, save it from the sanguinary intolerance of the Reign of Terror, and on the 8th April 1794 his father perished at Nîmes upon the scaffold. Thenceforth the education of the future minister devolved entirely upon his mother, a woman of slight appearance and of homely manners, but endowed with great strength of character and clearness of judgment. Madame Guizot was a living type of the Huguenots of the 16th century, stern in her principles and her faith, immovable in her convictions and her sense of duty. She formed the character of her illustrious son and shared every vicissitude of his life. In the days of his power her simple figure, always clad in deep mourning for her martyred husband, was not absent from the splendid circle of his political friends. In the days of his exile in 1848 she followed him to London, and there at a very advanced age closed her life and was buried at Kensal Green. Driven from Nîmes by the Revolution, Madame Guizot and her son repaired to Geneva, where he received his education. In spite of her decided Calvinistic opinions, the theories of Rousseau, then much in fashion, were not without their influence on Madame Guizot. She was a strong Liberal, and she even adopted the notion inculcated in the *Emile* that every man ought to learn a manual trade or craft. Young Guizot was taught to be a carpenter, and he so far succeeded in his work that he made a table with his own hands, which is still preserved. Of the progress of his graver studies little is known, for in the work which he entitled *Memoirs of my own Times* Guizot omitted all personal details of his earlier life. But his literary attainments must have been precocious and considerable, for when he arrived in Paris in 1805 to pursue his studies in the faculty of laws, he entered at eighteen as tutor into the family of M. Stapfer, formerly Swiss minister in France, and he soon began to write in a journal edited by M. Suard, the *Publiciste*. This connexion introduced him to the literary society of Paris. In October 1809, being then twenty-two, he wrote a review of M. de Chateaubriand's *Martyrs*, which procured for him the approbation and cordial thanks of that eminent person, and he continued to contribute largely to the periodical press. At Suard's he had made the acquaintance of Pauline Meulan, an accomplished lady of good family, some fourteen years older than himself, who had been forced by the hardships of the Revolution to earn her living by literature, and who also was engaged to contribute a series of articles to Suard's journal. These contributions were

¹ See "The Precursors of the Violin Family," by Kathleen Schlesinger, part ii. of *An Illustrated Handbook on the Instruments of the Orchestra* (London, 1908), chs. ii. and x.

² See Kathleen Schlesinger, *op. cit.* part ii., the "Utrecht Psalter," pp. 127-135, and the "Question of the Origin of the Utrecht Psalter," pp. 136-166, where the subject is discussed and illustrated.

³ *Idem*, see pl. vi. (2) to the right centre.

⁴ *Idem*, see pl. iii. centre and figs. 118 and 119.

⁵ *Idem*, see fig. 117, p. 341, and figs. 172 and 116.

⁶ *Idem*, see fig. 121, p. 246, figs. 122, 123, 125 and 126 pl. iii. vi. (1) and (2).

⁷ *Idem*, see fig. 126, p. 350, and pl. iii. right centre.

⁸ *Idem*, see fig. 173, p. 448.

⁹ See *Museo Pio Clementino*, by Visconti (Milan, 1818).

¹⁰ See for example *Georgics*, iv. 471-473 in the Vatican Virgil (Cod. 3225), in facsimile (Rome, 1899) (British Museum press-mark 8, tab. f. vol. ii.).

¹¹ This rotta was found in an Alamannic tomb of the 4th to the 7th centuries at Oberflacht in the Black Forest. A facsimile is preserved in the collection of the Kgl. Hochschule, Berlin, illustrations d. Grabfunde am Berge Lupia bei Oberflacht, 1846. *Jahresberichte d. Warlemb. Altertums-Vereins*, iii. (Stuttgart, 1846), tab. viii. also Kathleen Schlesinger, *op. cit.* part ii. fig. 168 (drawing from the facsimile).

¹² Reproductions of both miniatures are to be found in Professor J. O. Westwood's *Facsimiles of the Miniatures and Ornaments of Anglo-Saxon and Irish MSS.* (London, 1868).

¹³ An illustration occurs in the fine publication of the Austrian Academy of Sciences, *Kusej "Amra"* (Vienna, 1907, pl. xxxiv.).

¹⁴ See reproduction of some of the miniatures in Jacob and H. von Helmer-Altenack, *Trachten der christlichen Mittelalters* (Darmstadt, 1840-1854, 3 vols.), and in *Trachten, Kunstwerke und Geräthschaften vom frühen Mittelalter* (Frankfurt-on-Main, 1879-1890).

¹⁵ Add. MS. 34294, British Museum, vol. ii. fol. 83, 161, vol. iii. fol. 402, vol. iv. fols. 534 and 667.

interrupted by her illness, but immediately resumed and continued by an unknown hand. It was discovered that François Guizot had quietly supplied the deficiency on her behalf. The acquaintance thus begun ripened into friendship and love, and in 1812 Mademoiselle de Meulan consented to marry her youthful ally. She died in 1827; she was the author of many esteemed works on female education. An only son, born in 1819, died in 1837 of consumption. In 1828 Guizot married Elisa Dillon, niece of his first wife, and also an author. She died in 1833, leaving a son, Maurice Guillaume (1833-1892), who attained some reputation as a scholar and writer.

During the empire, Guizot, entirely devoted to literary pursuits, published a collection of French synonyms (1809), an essay on the fine arts (1811), and a translation of Gibbon with additional notes in 1812. These works recommended him to the notice of M. de Fontanes, then grand-master of the university of France, who selected Guizot for the chair of modern history at the Sorbonne in 1812. His first lecture (which is reprinted in his *Memoirs*) was delivered on the 11th of December of that year. The customary compliment to the all-powerful emperor he declined to insert in it, in spite of the hints given him by his patron, but the course which followed marks the beginning of the great revival of historical research in France in the 19th century. He had now acquired a considerable position in the society of Paris, and the friendship of Royer-Collard and the leading members of the liberal party, including the young duc de Broglie. Absent from Paris at the moment of the fall of Napoleon in 1814, he was at once selected, on the recommendation of Royer-Collard, to serve the government of Louis XVIII. in the capacity of secretary-general of the ministry of the interior, under the abbé de Montesquiou. Upon the return of Napoleon from Elba he immediately resigned, on the 25th of March 1815 (the statement that he retained office under General Carnot is incorrect), and returned to his literary pursuits. After the Hundred Days, he repaired to Ghent, where he saw Louis XVIII., and in the name of the liberal party pointed out to his majesty that a frank adoption of a liberal policy could alone secure the duration of the restored monarchy—advice which was ill-received by M. de Blacas and the king's confidential advisers. This visit to Ghent, at the time when France was a prey to a second invasion, was made a subject of bitter reproach to Guizot in after life by his political opponents, as an unpatriotic action. "The Man of Ghent" was one of the terms of insult frequently hurled against him in the days of his power. But the reproach appears to be wholly unfounded. The true interests of France were not in the defence of the falling empire, but in establishing a liberal policy on a monarchical basis and in combating the reactionary tendencies of the ultra-royalists. It is at any rate a remarkable circumstance that a young professor of twenty-seven, with none of the advantages of birth or political experience, should have been selected to convey so important a message to the ears of the king of France, and a proof, if any were wanting, that the Revolution had, as Guizot said, "done its work."

On the second restoration, Guizot was appointed secretary-general of the ministry of justice under M. de Barbé-Marbois, but resigned with his chief in 1816. Again in 1819 he was appointed general director of communes and departments in the ministry of the interior, but lost his office with the fall of Decazes in February 1820. During those years Guizot was one of the leaders of the *Doctrinaires*, a small party strongly attached to the charter and the crown, and advocating a policy which has become associated (especially by Faguet) with the name of Guizot, that of the *justo milieu*, a *via media* between absolutism and popular government. Their opinions had more of the rigour of a sect than the elasticity of a political party. Adhering to the great principles of liberty and toleration, they were sternly opposed to the anarchical traditions of the Revolution. They knew that the elements of anarchy were still fermenting in the country; these they hoped to subdue, not by reactionary measures, but by the firm application of the power of a limited constitution, based on the suffrages of the middle class and

defended by the highest literary talent of the times. Their motives were honourable. Their views were philosophical. But they were opposed alike to the democratic spirit of the age, to the military traditions of the empire, and to the bigotry and absolutism of the court. The fate of such a party might be foreseen. They lived by a policy of resistance; they perished by another revolution (1830). They are remembered more for their constant opposition to popular demands than by the services they undoubtedly rendered to the cause of temperate freedom.

In 1820, when the reaction was at its height after the murder of the duc de Berri, and the fall of the ministry of the duc Decazes, Guizot was deprived of his office, and in 1822 even his course of lectures were interdicted. During the succeeding years he played an important part among the leaders of the liberal opposition to the government of Charles X., although he had not yet entered parliament, and this was also the time of his greatest literary activity. In 1822 he had published his lectures on representative government (*Histoire des origines du gouvernement représentatif*, 1821-1822, 2 vols.; Eng. trans. 1852); also a work on capital punishment for political offences and several important political pamphlets. From 1822 to 1830 he published two important collections of historical sources, the memoirs of the history of England in 26 volumes, and the memoirs of the history of France in 31 volumes, and a revised translation of Shakespeare, and a volume of essays on the history of France. The most remarkable work from his own pen was the first part of his *Histoire de la révolution d'Angleterre depuis Charles I^{er} à Charles II.* (2 vols., 1826-1827; Eng. trans., 2 vols., Oxford, 1838), a book of great merit and impartiality, which he resumed and completed during his exile in England after 1828. The Martignac administration restored Guizot in 1828 to his professor's chair and to the council of state. Then it was that he delivered the celebrated courses of lectures which raised his reputation as an historian to the highest point of fame, and placed him amongst the best writers of France and of Europe. These lectures formed the basis of his general *Histoire de la civilisation en Europe* (1828; Eng. trans. by W. Hazlitt, 3 vols., 1846), and of his *Histoire de la civilisation en France* (4 vols., 1830), works which must ever be regarded as classics of modern historical research.

Hitherto Guizot's fame rested on his merits as a writer on public affairs and as a lecturer on modern history. He had attained the age of forty-three before he entered upon the full display of his oratorical strength. In January 1830 he was elected for the first time by the town of Lisieux to the chamber of deputies, and he retained that seat during the whole of his political life. Guizot immediately assumed an important position in the representative assembly, and the first speech he delivered was in defence of the celebrated address of the 221, in answer to the menacing speech from the throne, which was followed by the dissolution of the chamber, and was the precursor of another revolution. On his returning to Paris from Nîmes on the 27th of July, the fall of Charles X. was already imminent. Guizot was called upon by his friends Casimir-Périer, Laffitte, Villemain and Dupin to draw up the protest of the liberal deputies against the royal ordinances of July, whilst he applied himself with them to control the revolutionary character of the late contest. Personally, Guizot was always of opinion that it was a great misfortune for the cause of parliamentary government in France that the infatuation and ineptitude of Charles X. and Prince Polignac rendered a change in the hereditary line of succession inevitable. But, though convinced that it was inevitable, he became one of the most ardent supporters of Louis-Philippe. In August 1830 Guizot was made minister of the interior, but resigned in November. He had now passed into the ranks of the conservatives, and for the next eighteen years was the most determined foe of democracy, the unyielding champion of "a monarchy limited by a limited number of bourgeois."

In 1831 Casimir-Périer formed a more vigorous and compact administration, which was terminated in May 1832 by his death;

the summer of that year was marked by a formidable republican rising in Paris, and it was not till the 11th of October 1832 that a stable government was formed, in which Marshal Soult was first minister, the duc de Broglie took the foreign office, Thiers the home department, and Guizot the department of public instruction. This ministry, which lasted for nearly four years; was by far the ablest that ever served Louis Philippe. Guizot, however, was already marked with the stigma of unpopularity by the more advanced liberal party. He remained unpopular all his life, "not," said he, "that I court unpopularity, but that I think nothing about it." Yet never were his great abilities more useful to his country than whilst he filled this office of secondary rank but of primary importance in the department of public instruction. The duties it imposed on him were entirely congenial to his literary tastes, and he was master of the subjects they concerned. He applied himself in the first instance to carry the law of the 28th of June 1833, and then for the next three years to put it into execution. In establishing and organizing primary education in France, this law marked a distinct epoch in French history. In fifteen years, under its influence, the number of primary schools rose from ten to twenty-three thousand; normal schools for teachers, and a general system of inspection, were introduced; and boards of education, under mixed lay and clerical authority, were created. The secondary class of schools and the university of France were equally the subject of his enlightened protection and care, and a prodigious impulse was given to philosophical study and historical research. The branch of the Institute of France known as the "Académie des Sciences Morales et Politiques," which had been suppressed by Napoleon, was revived by Guizot. Some of the old members of this learned body—Talleyrand, Siéyès, Roederer and Lakanal—again took their seats there, and a host of more recent celebrities were added by election for the free discussion of the great problems of political and social science. The "Société de l'Histoire de France" was founded for the publication of historical works; and a vast publication of mediæval chronicles and diplomatic papers was undertaken at the expense of the state (see HISTORY; and FRANCE, *History*, section *Sources*).

The object of the cabinet of October 1832 was to organize a conservative party, and to carry on a policy of resistance to the republican faction which threatened the existence of the monarchy. It was their pride and their boast that their measures never exceeded the limits of the law, and by the exercise of legal power alone they put down an insurrection amounting to civil war in Lyons and a sanguinary revolt in Paris. The real strength of the ministry lay not in its nominal heads, but in the fact that in this government and this alone Guizot and Thiers acted in cordial co-operation. The two great rivals in French parliamentary eloquence followed for a time the same path; but neither of them could submit to the supremacy of the other, and circumstances threw Thiers almost continuously on a course of opposition, whilst Guizot bore the graver responsibilities of power.

Once again indeed, in 1839, they were united, but it was in opposition to M. Molé, who had formed an intermediate government, and this coalition between Guizot and the leaders of the left centre and the left, Thiers and Odilon Barrot, due to his ambition and jealousy of Molé, is justly regarded as one of the chief inconsistencies of his life. Victory was secured at the expense of principle, and Guizot's attack upon the government gave rise to a crisis and a republican insurrection. None of the three chiefs of that alliance took ministerial office, however, and Guizot was not sorry to accept the post of ambassador in London, which withdrew him for a time from parliamentary contests. This was in the spring of 1840, and Thiers succeeded shortly afterwards to the ministry of foreign affairs.

Guizot was received with marked distinction by the queen and by the society of London. His literary works were highly esteemed, his character was respected, and France was never more worthily represented abroad than by one of her greatest orators. He was known to be well versed in the history and the

literature of England; and sincerely attached to the alliance of the two nations and the cause of peace. But, as he himself remarked, he was a stranger to England and a novice in diplomacy; and unhappily the embroiled state of the Syrian question, on which the French government had separated itself from the joint policy of Europe, and possibly the absence of entire confidence between the ambassador and the minister of foreign affairs, placed him in an embarrassing and even false position. The warnings he transmitted to Thiers were not believed. The warlike policy of Thiers was opposed to his own convictions. The treaty of the 15th of July was signed without his knowledge and executed in the teeth of his remonstrances. For some weeks Europe seemed to be on the brink of war, until the king put an end to the crisis by refusing his assent to the military preparations of Thiers, and by summoning Guizot from London to form a ministry and to aid his Majesty in what he termed "ma lutte tenace contre l'anarchie." Thus began, under dark and adverse circumstances, on the 29th of October 1840, the important administration in which Guizot remained the master-spirit for nearly eight years. He himself took the office of minister for foreign affairs, to which he added some years later, on the retirement of Marshal Soult, the ostensible rank of prime minister. His first care was the maintenance of peace and the restoration of amicable relations with the other powers of Europe. If he succeeded, as he did succeed, in calming the troubled elements and healing the wounded pride of France, the result was due mainly to the indomitable courage and splendid eloquence with which he faced a raging opposition, gave unity and strength to the conservative party, who now felt that they had a great leader at their head, and appealed to the thrift and prudence of the nation rather than to their vanity and their ambition. In his pacific task he was fortunately seconded by the formation of Sir Robert Peel's administration in England, in the autumn of 1841. Between Lord Palmerston and Guizot there existed an incompatibility of character exceedingly dangerous in the foreign ministers of two great and in some respects rival countries. With Lord Palmerston in office, Guizot felt that he had a bitter and active antagonist in every British agent throughout the world; the combative element was strong in his own disposition; and the result was a system of perpetual conflict and counter-intrigues. Lord Palmerston held (as it appears from his own letters) that war between England and France was, sooner or later, inevitable. Guizot held that such a war would be the greatest of all calamities, and certainly never contemplated it. In Lord Aberdeen, the foreign secretary of Sir Robert Peel, Guizot found a friend and an ally perfectly congenial to himself. Their acquaintance in London had been slight, but it soon ripened into mutual regard and confidence. They were both men of high principles and honour; the Scotch Presbyterianism which had moulded the faith of Lord Aberdeen was reflected in the Huguenot minister of France; both were men of extreme simplicity of taste, joined to the refinement of scholarship and culture; both had an intense aversion to war and felt themselves ill-qualified to carry on those adventurous operations which inflamed the imagination of their respective opponents. In the eyes of Lord Palmerston and Thiers their policy was mean and pitiful; but it was a policy which secured peace to the world, and united the two great and free nations of the West in what was termed the *entente cordiale*. Neither of them would have stooped to snatch an advantage at the expense of the other; they held the common interest of peace and friendship to be paramount; and when differences arose, as they did arise, in remote parts of the world,—in Tahiti, in Mexico, on the Gold Coast,—they were reduced by this principle to their proper insignificance. The opposition in France denounced Guizot's foreign policy as basely subservient to England. He replied in terms of unmeasured contempt,—"You may raise the pile of calumny as high as you will; vous n'arriverez jamais à la hauteur de mon dédain." The opposition in England attacked Lord Aberdeen with the same reproaches, but in vain. King Louis Philippe visited Windsor. The queen of England (in 1843) stayed at the Château d'Eu. In 1845 British and

French troops fought side by side for the first time in an expedition to the River Plate.

The fall of Sir Robert Peel's government in 1846 changed these intimate relations; and the return of Lord Palmerston to the foreign office led Guizot to believe that he was again exposed to the passionate rivalry of the British cabinet. A friendly understanding had been established at Eu between the two courts with reference to the future marriage of the young queen of Spain. The language of Lord Palmerston and the conduct of Sir Henry Bulwer (afterwards Lord Dalling) at Madrid led Guizot to believe that this understanding was broken, and that it was intended to place a Coburg on the throne of Spain. Determined to resist any such intrigue, Guizot and the king plunged headlong into a counter-intrigue, wholly inconsistent with their previous engagements to England, and fatal to the happiness of the queen of Spain. By their influence she was urged into a marriage with a despicable offshoot of the house of Bourbon, and her sister was at the same time married to the youngest son of the French king, in direct violation of Louis Philippe's promises. This transaction, although it was hailed at the time as a triumph of the policy of France, was in truth as fatal to the monarch as it was discreditable to the minister. It was accomplished by a mixture of secrecy and violence. It was defended by subterfuges. By the dispassionate judgment of history it has been universally condemned. Its immediate effect was to destroy the Anglo-French alliance, and to throw Guizot into closer relations with the reactionary policy of Metternich and the Northern courts.

The history of Guizot's administration, the longest and the last which existed under the constitutional monarchy of France, bears the stamp of the great qualities and the great defects of his political character, for he was throughout the master-spirit of that government. His first object was to unite and discipline the conservative party, which had been broken up by previous dissensions and ministerial changes. In this he entirely succeeded by his courage and eloquence as a parliamentary leader, and by the use of all those means of influence which France too liberally supplies to a dominant minister. No one ever doubted the purity and disinterestedness of Guizot's own conduct. He despised money; he lived and died poor; and though he encouraged the fever of money-getting in the French nation, his own habits retained their primitive simplicity. But he did not disdain to use in others the baser passions from which he was himself free. Some of his instruments were mean; he employed them to deal with meanness after its kind. Gross abuses and breaches of trust came to light even in the ranks of the government, and under an incorruptible minister the administration was denounced as corrupt. *Licet uti alieno vitio* is a proposition as false in politics as it is in divinity.

Of his parliamentary eloquence it is impossible to speak too highly. It was terse, austere, demonstrative and commanding,—not persuasive, not humorous, seldom adorned, but condensed with the force of a supreme authority in the fewest words. He was essentially a ministerial speaker, far more powerful in defence than in opposition. Like Pitt he was the type of authority and resistance, unmoved by the brilliant charges, the wit, the gaiety, the irony and the discursive power of his great rival. Nor was he less a master of parliamentary tactics and of those sudden changes and movements in debate which, as in a battle, sometimes change the fortune of the day. His confidence in himself, and in the majority of the chamber which he had moulded to his will, was unbounded; and long success and the habit of authority led him to forget that in a country like France there was a people outside the chamber elected by a small constituency, to which the minister and the king himself were held responsible.

A government based on the principle of resistance and repression and marked by dread and distrust of popular power, a system of diplomacy which sought to revive the traditions of the old French monarchy, a sovereign who largely exceeded the bounds of constitutional power and whose obstinacy augmented with years, a minister who, though far removed from the servility

of the courtier, was too obsequious to the personal influence of the king, were all singularly at variance with the promises of the Revolution of July, and they narrowed the policy of the administration. Guizot's view of politics was essentially historical and philosophical. His tastes and his acquirements gave him little insight into the practical business of administrative government. Of finance he knew nothing; trade and commerce were strange to him; military and naval affairs were unfamiliar to him; all these subjects he dealt with by second hand through his friends, P. S. Dumon (1797-1870), Charles Marie Tanneguy, Comte Duchâtel (1803-1867), or Marshal Bugeaud. The consequence was that few measures of practical improvement were carried by his administration. Still less did the government lend an ear to the cry for parliamentary reform. On this subject the king's prejudices were insurmountable, and his ministers had the weakness to give way to them. It was impossible to defend a system which confined the suffrage to 200,000 citizens, and returned a chamber of whom half were placemen. Nothing would have been easier than to strengthen the conservative party by attaching the suffrage to the possession of land in France, but blank resistance was the sole answer of the government to the just and moderate demands of the opposition. Warning after warning was addressed to them in vain by friends and by foes alike; and they remained profoundly unconscious of their danger till the moment when it overwhelmed them. Strange to say, Guizot never acknowledged either at the time or to his dying day the nature of this error; and he speaks of himself in his memoirs as the much-enduring champion of liberal government and constitutional law. He utterly fails to perceive that a more enlarged view of the liberal destinies of France and a less intense confidence in his own specific theory might have preserved the constitutional monarchy and averted a vast series of calamities, which were in the end fatal to every principle he most cherished. But with the stubborn conviction of absolute truth he dauntlessly adhered to his own doctrines to the end.

The last scene of his political life was singularly characteristic of his inflexible adherence to a lost cause. In the afternoon of the 23rd of February 1848 the king summoned his minister from the chamber, which was then sitting, and informed him that the aspect of Paris and the country during the banquet agitation for reform, and the alarm and division of opinion in the royal family, led him to doubt whether he could retain his ministry. That doubt, replied Guizot, is decisive of the question, and instantly resigned, returning to the chamber only to announce that the administration was at an end and that Molé had been sent for by the king. Molé failed in the attempt to form a government, and between midnight and one in the morning Guizot, who had according to his custom retired early to rest, was again sent for to the Tuileries. The king asked his advice. "We are no longer the ministers of your Majesty," replied Guizot; "it rests with others to decide on the course to be pursued. But one thing appears to be evident; this street riot must be put down; these barricades must be taken; and for this purpose my opinion is that Marshal Bugeaud should be invested with full power, and ordered to take the necessary military measures, and as your Majesty has at this moment no minister, I am ready to draw up and countersign such an order." The marshal, who was present, undertook the task, saying, "I have never been beaten yet, and I shall not begin to-morrow. The barricades shall be carried before dawn." After this display of energy the king hesitated, and soon added: "I ought to tell you that M. Thiers and his friends are in the next room forming a government!" Upon this Guizot rejoined, "Then it rests with them to do what they think fit," and left the palace. Thiers and Barrot decided to withdraw the troops. The king and Guizot next met at Claremont. This was the most perilous conjuncture of Guizot's life, but fortunately he found a safe refuge in Paris for some days in the lodging of a humble miniature painter whom he had befriended, and shortly afterwards effected his escape across the Belgian frontier and thence to London, where he arrived on the 3rd of March. His mother and daughters

had preceded him, and he was speedily installed in a modest habitation in Pelham Crescent, Brompton.

The society of England, though many persons disapproved of much of his recent policy, received the fallen statesman with as much distinction and respect as they had shown eight years before to the king's ambassador. Sums of money were placed at his disposal, which he declined. A professorship at Oxford was spoken of, which he was unable to accept. He stayed in England about a year, devoting himself again to history. He published two more volumes on the English revolution, and in 1854 his *Histoire de la république d'Angleterre et de Cromwell* (2 vols., 1854), then his *Histoire du protectorat de Cromwell et du rétablissement des Stuarts* (2 vols., 1856). He also published an essay on Pœl, and amid many essays on religion, during the ten years 1858-1868, appeared the extensive *Mémoires pour servir à l'histoire de mon temps*, in nine volumes. His speeches were included in 1863 in his *Histoire parlementaire de la France* (5 vols. of parliamentary speeches, 1863).

Guizot survived the fall of the monarchy and the government he had served twenty-six years. He passed abruptly from the condition of one of the most powerful and active statesmen in Europe to the condition of a philosophical and patriotic spectator of human affairs. He was aware that the link between himself and public life was broken for ever; and he never made the slightest attempt to renew it. He was of no party, a member of no political body; no murmur of disappointed ambitions, no language of asperity, ever passed his lips; it seemed as if the fever of oratorical debate and ministerial power had passed from him and left him a greater man than he had been before, in the pursuit of letters, in the conversation of his friends, and as head of the patriarchal circle of those he loved. The greater part of the year he spent at his residence at Val Richer, an Augustinian monastery near Lisieux in Normandy, which had been sold at the time of the first Revolution. His two daughters, who married two descendants of the illustrious Dutch family of De Witt, so congenial in faith and manners to the Huguenots of France, kept his house. One of his sons-in-law farmed the estate. And here Guizot devoted his later years with undiminished energy to literary labour, which was in fact his chief means of subsistence. Proud, independent, simple and contented he remained to the last; and these years of retirement were perhaps the happiest and most serene portion of his life.

Two institutions may be said even under the second empire to have retained their freedom—the Institute of France and the Protestant Consistory. In both of these Guizot continued to the last to take an active part. He was a member of three of the five academies into which the Institute of France is divided. The Academy of Moral and Political Science owed its restoration to him, and he became in 1832 one of its first associates. The Academy of Inscriptions and Belles Lettres elected him in 1833 as the successor to M. Dacier; and in 1836 he was chosen a member of the French Academy, the highest literary distinction of the country. In these learned bodies Guizot continued for nearly forty years to take a lively interest and to exercise a powerful influence. He was the jealous champion of their independence. His voice had the greatest weight in the choice of new candidates; the younger generation of French writers never looked in vain to him for encouragement; and his constant aim was to maintain the dignity and purity of the profession of letters.

In the consistory of the Protestant church in Paris Guizot exercised a similar influence. His early education and his experience of life conspired to strengthen the convictions of a religious temperament. He remained through life a firm believer in the truths of revelation, and a volume of *Meditations on the Christian Religion* was one of his latest works. But though he adhered inflexibly to the church of his fathers and combated the rationalist tendencies of the age, which seemed to threaten it with destruction, he retained not a tinge of the intolerance or asperity of the Calvinistic creed. He respected in the Church of Rome the faith of the majority of his countrymen; and the writings of the great Catholic prelates, Bossuet and Bourdaloue,

were as familiar and as dear to him as those of his own persuasion, and were commonly used by him in the daily exercises of family worship.

In these literary pursuits and in the retirement of Val Richer years passed smoothly and rapidly away; and as his grandchildren grew up around him, he began to direct their attention to the history of their country. From these lessons sprang his last and not his least work, the *Histoire de France racontée à mes petits enfants*, for although this publication assumed a popular form, it is not less complete and profound than it is simple and attractive. The history came down to 1789, and was continued to 1870 by his daughter Madame Guizot de Witt from her father's notes.

Down to the summer of 1874 Guizot's mental vigour and activity were unimpaired. His frame, temperate in all things, was blessed with a singular immunity from infirmity and disease; but the vital power ebbed away, and he passed gently away on the 12th of September 1874, reciting now and then a verse of Corneille or a text of Scripture.

BIBLIOGRAPHY.—See his own *Mémoires pour servir à l'histoire de mon temps* (8 vols., 1858-1863); *Lettres de M. Guizot à sa famille et à ses amis* (1884); C. A. Sainte-Beuve, *Causeries du lundi* (vol. 1, 1857) and *Nouveaux Lundis* (vols. I. and II., 1863-1872); E. Scherer, *Études critiques sur la littérature contemporaine* (vol. IV., 1873); Mme de Witt, *Guizot dans sa famille* (1880); Jules Simon, *Thiers, Guizot et Rémusat* (1885); E. Faguet, *Politiques et moralistes au XIX^e siècle* (1891); G. Bardoux, *Guizot* (1894) in the series of "Les Grands Écrivains français"; Maurice Guizot, *Les Années de retraite de M. Guizot* (1907); and for a long list of books and articles on Guizot in periodicals see H. P. Thieme, *Guide bibliographique de la littérature française de 1800 à 1906* (s.v. Guizot, Paris, 1907). For a notice of his first wife see C. A. Sainte-Beuve, *Portraits de femmes* (1884), and Ch. de Rémusat, *Critiques et études littéraires* (vol. II., 1847).

GUJARAT or **GUZERAT**, a region of India, in the Bombay Presidency. In the widest sense of the name it includes the whole of the country where the Gujarati language is spoken, i.e. the northern districts and states of the Presidency from Palanpur to Damaun, with Kathiawar and Cutch. But it is more properly confined to the country north of the Nerbudda and east of the Rana of Cutch and Kathiawar. In this sense it has an area of 29,021 sq. m., with a population in 1901 of 4,708,304. It includes the states distributed among the agencies of Palanpur, Mahi Kantha, Rewa Kantha and Cambay, with most of Baroda and the British districts of Ahmedabad, Kaira, Panch Mahals and Broach. Less than one-fourth is British territory. The region takes its name from the Gujars, a tribe who passed into India from the north-west, established a kingdom in Rajputana, and spread south in A.D. 400-600. The ancient Hindu capital was Anhilvada; the Mahomedan dynasty, which ruled from 1306 to 1572, founded Ahmedabad, which is still the largest city; but Gujarat owed much of its historical importance to the seaports of Broach, Cambay and Surat. Its fertile plain, with a regular rainfall and numerous rivers, has caused it to be styled the "garden of India." It suffered, however, severely from the famine of 1899-1901. For an account of the history, geography, &c., of Gujarat see the articles on the various states and districts. Gujarat gives its name to the vernacular of northern Bombay, viz. Gujarati, one of the three great languages of that Presidency, spoken by more than 9 millions. It has an ancient literature and a peculiar character. As the language of the Pasis it is prominent in the Bombay press; and it is also the commercial language of Bombay city, which lies outside the territorial area of Gujarat.

See J. Campbell, *History of Gujarat* (Bombay, 1896); Sir E. C. Bayley, *The Mohammedan Kingdom of Gujarat* (1886); A. K. Forbes, *Ras Mala* (1856).

GUJARATI and **RAJASTHANI**, the names of two members of the western sub-group of the Intermediate Group of Indo-Aryan languages (q.v.). The remaining member of this sub-group is Panjabi or Punjabi (see HINDOSTANI). In 1901 the speakers of those now dealt with numbered: Gujarati, 9,439,025, and Rajasthani, 10,917,712. The two languages are closely connected and might almost be termed co-dialects of the same form of speech. Together they occupy an almost square block of country,

some 400 m. broad, reaching from near Agra and Delhi on the river Jumna to the Arabian Sea. Gujarati (properly *Gujarātī*) is spoken in Gujarat, the northern maritime province of the Bombay Presidency, and also in Baroda and the native states adjoining. Rajasthani (properly *Rājasthānī*, from "*Rājasthān*," the native name for Rajputana) is spoken in Rajputana and the adjoining parts of Central India.

In the articles INDO-ARYAN LANGUAGES and PRAKRIT the history of the earlier stages of the Indo-Aryan vernaculars is given at some length. It is there shown that, from the most ancient times, there were two main groups of these forms of speech—one, the language of the Midland, spoken in the country near the Gaugetic Doab, and the other, the so-called "Outer Band," containing the Midland on three sides, west, north and south. The country to the west and south-west of the Midland, in which this outer group of languages was spoken, included the modern Punjab, Rajputana and Gujarat. In process of time the population of the Midland expanded and carried its language to its new homes. It occupied the eastern and central Punjab, and the mixed (or "intermediate") language which there grew up became the modern Panjabi. To the west it spread into Rajputana, till its progress was stopped by the Indian desert, and in Rajputana another intermediate language took rise and became Rajasthani. As elsewhere explained, the language-wave of the Midland exercised less and less influence as it travelled farther from its home, so that, while in eastern Rajputana the local dialect is now almost a pure midland speech, in the west there are many evident traces of the old outer language still surviving. To the south-west of Rajputana there was no desert to stop the wave of Midland expansion, which therefore rolled on unobstructed into Gujarat, where it reached the sea. Here the survivals of the old outer language are stronger still. The old outer Prakrit of north Gujarat was known as "Saurāśtrī," while the Prakrit of the Midland invaders was called "Saurasēnī," and we may therefore describe Gujarati as being an intermediate language derived (as explained in the articles PRAKRIT from a mixture of the Apabhramśa forms of Saurāśtrī and Saurasēnī, in which the latter predominated.

It will be observed that, at the present day, Gujarati breaks the continuity of the outer band of Indo-Aryan languages. To its north it has Sindhi and to its south Marathi, both outer languages with which it has only a slight connexion. On the other hand, on the east and north-east it has Rajasthani, into which it merges so gradually and imperceptibly that at the conventional border-line, in the state of Palanpur, the inhabitants of Rajputana say that the local dialect is a form of Gujarati, while the inhabitants of Gujarat say that it is Rajasthani.

Gujarati has no important local dialects, but there is considerable variation in the speeches of different classes of the community. Parsees and Mussulmans (when the latter use the language—as a rule the Gujarat Mussulmans speak Hindostani) have some striking peculiarities of pronunciation, the most noticeable of which is the disregard by the latter of the distinction between cerebral and dental letters. The uneducated Hindus do not pronounce the language in the same way as their betters, and this difference is accentuated in northern Gujarat, where the lower classes substitute *ḍ* for *ṣ*, *ḍ* for *k*, *ch* for *ḥ*, *s* for *c* and *ch*, *h* for *s*, and drop *h* as readily as any cockney. There is also (as in the case of the Mussulmans) a tendency to confuse cerebral and dental consonants, to substitute *r* for *ḍ* and *ḷ*, to double medial consonants, and to pronounce the letter *ḍ* as *ḥ*, something like the *o* in "all." The Bhils of the hills east of Gujarat also speak a rude Gujarati, with special dialectic peculiarities of their own, probably due to the fact that the tribes are of Dravidian origin. These Bhil peculiarities are further mixed with corruptions of Marathi idioms in Nimar and Khandesh, where we have almost a new language.

Rajasthani has numerous dialects, each state claiming one or more of its own. Thus, in the state of Jaipur there have been catalogued no less than ten dialects among about 1,688,000 people. All Rajasthani dialects can, however, be easily classed in four well-defined groups, a north-eastern, a southern, a

western and an east-central. The north-eastern (*Mewāṭī*) is that form of Rajasthani which is merging into the Western Hindi of the Midland. It is a mixed form of speech, and need not detain us further. Similarly, the southern (*Mālvī*) is much mixed with the neighbouring Bundelī form of Western Hindi. The western (*Mārwarī*) spoken in Marwar and its neighbourhood, and the east-central (*Jaipurī*) spoken in Jaipur and its neighbourhood, may be taken as the typical Rajasthani dialects. In the following paragraphs we shall therefore confine ourselves to Gujarati, Marwarī and Jaipurī.

We know more about the ancient history of Gujarati than we do about that of any other Indo-Aryan language. The one native grammar of Apabhramśa Prakrit which we possess in a printed edition, was written by Hemacandra (12th century A.D.), who lived in what is now north Gujarat, and who naturally described most fully the particular vernacular with which he was personally familiar. It was known as the *Nāgara Apabhramśa*, closely connected (as above explained) with *Saurasēnī*, and was so named after the *Nāgara* Brahmins of the locality. These men carried on the tradition of learning inherited from Hemacandra, and we see Gujarati almost in the act of taking birth in a work called the *Meghdūtasambhāvanī*, written by one of them only two hundred years after his death. Formal Gujarati literature is said to commence with the poet Narsingh Mēta in the 15th century. Rajasthani literature has received but small attention from European or native scholars, and we are as yet unable to say how far back the language goes.

Both Gujarati and Rajasthani are usually written in current scripts related to the well-known Nāgarī alphabet (see SANSKRIT). The form employed in Rajputana is known all over northern India as the "Mishājani" alphabet, being used by bankers or *Mahājans*, most of whom are Marwaris. It is noteworthy as possessing two distinct characters for *ḍ* and *ḷ*. The Gujarati character closely resembles the Kaithī character of northern India (see BIRARĪ). The Nāgarī character is also freely used in Rajputana, and to a less extent in Gujarat, where it is employed by the *Nāgara* Brahmins, who claim that their tribe has given the alphabet its name.

In the following description of the main features of our two languages, the reader is presumed to be familiar with the leading facts stated in the articles INDO-ARYAN LANGUAGES and PRAKRIT. The article HINDOSTANI may also be perused with advantage.

(Abbreviations. Skr. = Sanskrit. Pr. = Prakrit. Ap. = Apabhramśa. G. = Gujarati. R. = Rajasthani. H. = Hindostani.)

Vocabulary.—The vocabulary of both Gujarat and Rajasthani is very free from *taṣama* words. The great mass of both vocabularies is *śuddha* (see INDO-ARYAN LANGUAGES). Rajputana was from an early period brought into close contact with the Mogul court at Agra and Delhi, and even in the 13th century A.D. official documents of the Rajput princes contained many borrowed Persian and Arabic words. Gujarati, under the influence of the learned *Nāgara* Brahmins, has perhaps more *taṣama* words than Rajasthani, but their employment is not excessive. On the other hand, Parsees and Mussulmans employ Persian and Arabic words with great freedom; while, owing to its maritime connexions, the language has also borrowed occasional words from other parts of Asia and from Europe. This is specially marked in the strange dialect of the Kathiawar boatmen who travel all over the world as lascars on the great steamships. Their language is a mixture of Hindostani and Gujarati with a heterogeneous vocabulary.

Phonetics.—With a few exceptions to be mentioned below, the sound-system of the two languages is the same as that of Sanskrit, and is represented in the same manner in the Roman character (see SANSKRIT). The simplest method for considering the subject in regard to Gujarati is to compare it with the phonetic system of Hindostani (*q.v.*). As a rule, Rajasthani closely follows Gujarati and need not be referred to except in special cases. G. invariably simplifies a medial Pr. double consonant, lengthening the preceding vowel in compensation. Thus Skr. *mākhṣāṇam*, Ap. *makhṣāṇam*, H. *makhṣān*, but G. *mākhṣān*, butter. In H. this rule is generally observed, but in G. it is universal, while, on the other hand, in Panjabi the double consonant is never simplified, but is retained as in Ap. In G. (and sometimes in R.) when a *ḥ* is followed by *h* it is changed to *s*, as in H. *shahr*, G. *śahr*, a city. As in other outer languages H. *ai* and *au* are usually represented by a short *e* and by *o* (sounded like the *a* in "all") respectively. Thus H. *baīḥ*, G. *beḥ*, seared; H. *cauth*, G. *cāth* (written *cāth*), fourth. In R. this *e* is often further weakened to the sound of *a* in "aan," a change

which is also common in Bengali. Many words which have *j* in H. have *ś* in G. and R., thus, H. *likhē*, G. *likhē*, he writes; H. *diḥ*, G. and R. *das*, a day. Similarly we have *s* for *ś*, as in H. *śam*, G. & R. *sam*, you. In colloquial G. *ś* of tea becomes *s*, and *ī* becomes *ē*; thus, *pāi* for *pāī*, water; *māri* for *māī*, I shall strike. As in most Indo-Aryan vernaculars an *s* after an accented syllable is very lightly pronounced, and is here represented by a small *ˆ* above the line.

The Vedic cerebral *ṣ* and the cerebral *ś* are very common as medial letters in both G. and R. (both being unknown to literary H.).

The rule is, as elsewhere in western and southern intermediate and outer languages, that when *s* and *l* represent a double *ś* (or *ṣ*) or a double *ll* in Pr. they are dental, but when they represent single medial letters they are cerebralized. Thus Ap. *soṣṣā*, G. *śṣā*, gold; Ap. *ghaṣṣā*, G. *ghaṣṣā*, dense; Ap. *caśśā*, G. *caśśā*, he goes; Ap. *caśśā*, G. *caśśā*, he moves. In northern G. and in some caste dialects dental and cerebral letters are absolutely interchangeable, as in *ghāśśā* or *dahāśśā*, a day; *śā* or *śā*, thou; *śāśśā* or *dīśśā*, given. In G. and R. medial *ś* is pronounced as a rough cerebral *ṣ*, and is then so transcribed. We have seen that in the Marwari alphabet there are actually distinct letters for these two sounds. In colloquial G. *ś* and *ch* are pronounced *s*, especially in the north, as in *pās* for *pās*, five; *pūśyā* for *pūśyā*, he asked. Similarly, in the north, *j* and *ḥ* become *s*, as in *śād* for *jād*, a tree. In some localities (as in Marathi) we have *ś* and *ś* for these sounds, as in *Tarūśār* (name of a tract of country) for *Cerōśār*. On the other hand, *h*, *kh* and *g*, especially when preceded or followed by *t*, *c* or *y*, become in the north *c*, *ph* and *j* respectively; thus, *śāśśā* for *śāśśā*, a son; *śāśśā* for *śāśśā*, a field; *śāśśā* for *śāśśā*, begun. A similar change is found in dialectic Marathi, and is, of course, one of the commonplaces of the philology of the Romance languages. The sibilants *s* and *f* are colloquially pronounced *h* (as in several outer languages), especially in the north. Thus *śāś* for *śāś*, a country; *śāś* for *śāś*, what; *hām-śāśyā* for *śāśyā*, he explained. An original aspirate *ś*, however, often dropped, as in *śāś* for *śāś*, I; *śāś* for *śāś*, on the hand. Standard G. is at the same time fond of pronouncing an *h* where it is not written, as in *śāś*, we, pronounced *śāśh*. In other respects both G. and R. closely agree in their phonetical systems with the Apabhraṃśa form of Saurasāni Prakrit from which the Midland language is derived.

Declension.—Gujarati agrees with Marathi (an outer language) as against Hindostani in retaining the neuter gender of Sanskrit and Prakrit. Moreover, the neuter gender is often employed to indicate living beings of which the sex is uncertain, as in the case of *śāśśā*, a child, compared with *śāśśā*, a son, and *śāśśā*, a daughter. In R. there are only sporadic instances of the neuter, which grow more and more rare as we approach the Midland. Nouns in both G. and R. may be weak or strong as is fully explained in the article HINDOSTANI. We have there seen that the strong form of masculine nouns in Western Hindi generally ends in *ā*, the *ā* of words like the Hindostani *ghōṣā*, a horse, being an accident due to the fact that the Hindostani dialect of Western Hindi borrows this termination from Pasjābi. G. and R. follow Western Hindi, for their masculine strong forms end in *ā*. Feminine strong forms end in *ī* as elsewhere. Neuter strong forms in G. end in *ś*, derived as follows: Skr. *śarāśam*, Ap. *śarāśā*, G. *śāśśā*, gold. As an example of the three genders of the same word we may take G. *śāśśā* (masc.), a boy; *śāśśā* (fem.), a girl; *śāśśā* (neut.), a child. Long forms corresponding to the Eastern Hindi *ghōṣāśśā*, a horse, are not much used, but we not infrequently meet another long form made by suffixing the pleonastic terminator *śā* or *śā* (sem. *śā* or *śā*; G. neut. *śā* or *śā*) which is directly descended from the Ap. pleonastic termination *śāś*, *śāś*. We come across this most often in R., where it is used contemptuously, as in *Tarūśāśśā*, a Turk.

In the article HINDOSTANI it is shown that all the oblique cases of each number in Sanskrit and Prakrit became melted down in the modern language into one general oblique case, which, in the Midland, is derived in the singular from the Ap. termination *-ā* or *-āś*, and that even this has survived only in the case of strong masculine nouns; thus, *ghōṣāś*, obl. *ghōṣāś*. In G. and R. this same termination has also survived, but for all nouns as the case sign of the agent and locative cases. The general oblique case is the same as the nominative, except in the case of strong masculine and neuter nouns in *ā* and *ī* respectively, where it ends in *ā*, not *ś*. This *ā*-termination is characteristic of the outer band of languages, and is one of the survivals already referred to. It is derived from the Apabhraṃśa genitive form in *-āśā*, corresponding to the Māgadhī Pr. (an outer Prakrit) termination *-āśā*. Thus, G. *śāśśāś*, a son; *śāśśāś*, a child; obl. sing. *śāśśāś*.

In G. the nominative and oblique plural for all nouns are formed by adding *ś* to the oblique form singular but in the neuter strong forms the oblique singular is nasalized. The real plural is the same in form as the oblique singular in the case of masculines, and as a nasalized oblique singular in the case of neuter strong forms, as in

other modern Indo-Aryan vernaculars, and the added *ś* is a further plural termination (making a double plural, exactly as it does in the Ardhamāgadhī Prakrit *śāśśāśśā*, sons) which is often dropped. The nasalization of the strong neuter plurals is inherited from Ap., in which the neuter nom. plural of such nouns ended in *-āś*. In R. the nominative plural of masculine nouns is the same in form as the oblique case singular, and the oblique plural ends in *ś*. The feminine has *ś* both in the nominative and in the oblique plural. These are all explained in the article HINDOSTANI. We thus get the following paradigms of the declension of nouns.

	Apabhraṃśa.	Gujarati.	Rajasthani.
Strong Noun Masc.—			
"A horse."	Sing. Nom. <i>ghōṣāś</i>	<i>ghōṣāś</i>	<i>ghōṣāś</i>
	Obl. <i>ghōṣāśāś</i>	<i>ghōṣāś</i>	<i>ghōṣāś</i>
	Ag.-Loc. <i>ghōṣāśāś</i>	<i>ghōṣāś</i> , <i>ghōṣāśāś</i>	<i>ghōṣāś</i>
	Plur. Nom. <i>ghōṣāśāś</i>	<i>ghōṣāśāś</i>	<i>ghōṣāśāś</i>
	Obl. <i>ghōṣāśāśāś</i>	<i>ghōṣāśāś</i>	<i>ghōṣāśāś</i>
	Ag.-Loc. <i>ghōṣāśāśāś</i>	<i>ghōṣāśāśāś</i>	<i>ghōṣāśāśāś</i>
Strong Noun Neut.—			
"Gold."	Sing. Nom. <i>soṣṣāś</i>	<i>śṣāś</i>	..
	Obl. <i>soṣṣāśāś</i>	<i>śṣāś</i>	..
	Ag.-Loc. <i>soṣṣāśāś</i>	<i>śṣāś</i> , <i>śṣāśāś</i>	..
	Plur. Nom. <i>soṣṣāśāś</i>	<i>śṣāśāś</i>	..
	Obl. <i>soṣṣāśāśāś</i>	<i>śṣāśāś</i>	..
	Ag.-Loc. <i>soṣṣāśāśāś</i>	<i>śṣāśāśāś</i>	..
Strong Noun Fem.—			
"A mare."	Sing. Nom. <i>ghōṣāśī</i>	<i>ghōṣāśī</i>	<i>ghōṣāśī</i>
	Obl. <i>ghōṣāśīś</i>	<i>ghōṣāśī</i>	<i>ghōṣāśī</i>
	Ag.-Loc. <i>ghōṣāśīś</i>	<i>ghōṣāśīś</i>	<i>ghōṣāśīś</i>
	Plur. Nom. <i>ghōṣāśīśāś</i>	<i>ghōṣāśīśāś</i>	<i>ghōṣāśīśāś</i>
	Obl. <i>ghōṣāśīśāśāś</i>	<i>ghōṣāśīśāś</i>	<i>ghōṣāśīśāś</i>
	Ag.-Loc. <i>ghōṣāśīśāśāś</i>	<i>ghōṣāśīśāśāś</i>	<i>ghōṣāśīśāśāś</i>
Weak Noun Masc. or Neut.—			
"A house."	Sing. Nom. <i>gharū</i> (neut.)	<i>ghar</i>	<i>ghar</i>
	Obl. <i>gharāś</i>	<i>ghar</i>	<i>ghar</i>
	Ag.-Loc. <i>gharāś</i>	<i>ghar</i>	<i>ghar</i>
	Plur. Nom. <i>gharāśāś</i>	<i>gharāś</i>	<i>gharāś</i>
	Obl. <i>gharāśāśāś</i>	<i>gharāś</i>	<i>gharāś</i>
	Ag.-Loc. <i>gharāśāśāś</i>	<i>gharāśāś</i>	<i>gharāś</i>
Weak Noun Fem.—			
"A word."	Sing. Nom. <i>vattāś</i>	<i>vattāś</i>	<i>vattāś</i>
	Obl. <i>vattāśī</i>	<i>vattāś</i>	<i>vattāś</i>
	Ag.-Loc. <i>vattāś</i>	<i>vattāś</i>	<i>vattāś</i>
	Plur. Nom. <i>vattāśāś</i>	<i>vattāśāś</i>	<i>vattāśāś</i>
	Obl. <i>vattāśāśāś</i>	<i>vattāśāś</i>	<i>vattāśāś</i>
	Ag.-Loc. <i>vattāśāśāś</i>	<i>vattāśāśāś</i>	<i>vattāśāśāś</i>

The general oblique case can be employed for any case except the nominative, but, in order to define the meaning, it is customary to add postpositions as in Hindostani. These are:

	Genitive.	Dative.	Ablative.	Locative.
Gujarati	<i>nō</i>	<i>nē</i>	<i>tō</i>	<i>mō</i>
Rajasthani	<i>rō</i> , <i>hō</i>	<i>nāi</i> , <i>rāi</i> , <i>hāi</i>	<i>tō</i>	<i>mō</i>

The suffix *nō* of the genitive is believed to be a contraction of *lāṣṣ*, which is found in old Gujarati poetry, and which, under the form *lāṣṣ* in Sanskrit and *lāṣṣā* in Apabhraṃśa, mean "belonging to." It is an adjective, and agrees in gender, number and case with the thing possessed. Thus, *rājā-nō dīkṣṣ*, the king's son; *rājā-nō dīkṣṣī*, the king's daughter; *rājā-nō ghar*, the king's house; *rājā-nō dīkṣṣā-nē*, to the king's son (*nō* is in the oblique case masculine to agree with *dīkṣṣ*); *rājā-nō gharāś*, in the king's house. The *rō* and *hō* of R. are similarly treated, but, of course, have no neuter. The dative postpositions are simply locatives of the genitive ones, as in all modern Indo-Aryan languages (see HINDOSTANI). *tō*, the postposition of the G. ablative, is connected with *lāṣṣ*, to be, one of the verbs substantive in that language. The ablative suffix is made in this way in many modern Indo-Aryan languages (e.g. Bengali, &c.). It means literally "having been" and is to be ultimately referred to the Sanskrit root, *śāś*, stand. The derivation of the other postpositions is discussed in the article HINDOSTANI.

Strong adjectives agree with the nouns they qualify in gender, number and case, as in the examples of the genitive above. Weak adjectives are immutable.

Pronouns closely agree with those found in Hindostani. In the table on following page we give the first two personal pronouns, and the demonstrative pronoun "this."

Similarly are formed the remaining pronouns, viz. G. *ś*, R. *ś*, he, that; G. *ś*, R. *ś* (obl. sing. f.), that; G. *jē*, R. *jē*, who; G. *hō* (obl. *hō*, *hō*, or *hō*), R. *hō* (obl. *hō*), who; G. *ś*, R. *hō*, what?; G. *hō*, anyone, someone, *hō* anything, something. G. has two other demonstratives, *śāś* and *śāś*, both meaning "that." The derivation of these and of *ś* has been discussed without any decisive result. The rest are explained in the article HINDOSTANI. The

		Apabhraṃśa.	Gujarati.	Rajasthani.
I	Nom. Obl.	haṣ maṣ, maku, majjhu mahdrāṣ amhē	hā ma, maj māṣ amē	hā, mhh, maṣ ma, mha, mā māṣ, mhāṣ mihē
MY	Nom. Obl.	amhadrā amhadrā	am-ṣ am-ṣ	mihē mihē-ṣ, mihē-hē
THOU	Nom. Obl.	tuhā taṣ, tuha, tujjhu tuhdrāṣ tumhāṣ	tā ta, tuj tāṣ tam-ṣ	tā ta, tha, thē thāṣ thā, tam-ṣ
THY	Nom. Obl.	tumhadrāṣ tumhadrāṣ	tam-ṣ tam-ṣ	thā, tam-ṣ thā-ṣ, thā-hē
YOU	Nom. Obl.	ṣhe (?) ṣhaha, imaha	ṣ ṣ	ṣ ṣ
YOUR	Nom. Obl.	ṣi ṣammi, ṣhapa	ṣ-ṣ am	ṣ, ṣṣ ṣṣ, ṣṣ
THIS, HE	Nom. Obl.			
THESE, THEY	Nom. Obl.			

reflexive pronoun is G. *ṣp-ṣ*, R. *ṣp-ṣ*. It is generally employed as a plural of the first personal pronoun including the person addressed; thus G. *ṣp-ṣ*, we (including you), but *amē*, we (excluding you). In G. *ṣp-ṣ*, obl. *ṣp-ṣ*, is used to mean "self."

Conjugation.—The old present has survived as in Hindostani and other Indian languages. Taking the base *call* or *cal*, go, as our model, we have:

		Apabhraṃśa.	Gujarati.	Rajasthani.
Sing.	1	callāṣ callahī	callā callē	callē callai
	2	callai	callē	callai
Plur.	1	callahāṣ callahū	callāṣ callō	callē callō
	2	callahū	callō	callō
	3	callahī	callē	callai

The derivation of the G. 1 plural is unknown. That of the other G. and R. forms is manifest. The imperative closely follows this, but as usual has no termination in the second person singular.

In R. the future may be formed by adding *ṣ* (cf. Hindostani *ṣē*), *ṣ*, or *ṣā* to the old present. Thus, *call-ṣ*, *call-ṣ* or *call-ṣā* I shall go. The *ṣ* and *ṣā* agree in gender and number with the subject, but *ṣ* is immutable. The termination with *ṣ* is also found in Bhojpuri (see BĪHARĪ), in Marathi and in Nepali. For *ṣ* see HINDOSTANI. Another form of the future has *ṣ* or *ṣ* for its characteristic letter, and is the only one employed in G. Thus, Ap. *calliṣāṣ* or *calliṣāṣ*, G. *calliṣ*, R. (Jaipuri) *calliṣ*, (Marwari) *calliṣ*. The other personal terminations differ considerably from those of the old present, and closely follow Ap. Thus, Ap. 3 sing. *calliṣai* or *calliṣi*, G. *calliṣ*, Marwari *calliṣ*.

The participles and infinitive are as follows:

	Apabhraṃśa.	Gujarati.	Rajasthani.
Pres. Part. Active	callantāṣ	callāṣ	callāṣ
Past Part. Passive	calliṣāṣ	calliṣ	calliṣ
Future Part. Passive	calliṣvaṣ	calliṣ-ṣ	calliṣ-ṣ
Infinitive	..	call-ṣ	call-ṣ

In G. the infinitive is simply the neuter of the future passive participle. The participles are employed to form finite tenses; thus G. *hā call-ṣ*, I used to go; *hā call-ṣ*, I went. If the verb is transitive (see HINDOSTANI) the passive meaning of the past participle comes into force. The subject is put into the case of the agent, and the participle inflects to agree with the object, or, if there is no object, is employed impersonally in the neuter (in G.) or in the masculine (in R.). In Hindostani, if the object is expressed in the dative, the participle is also employed impersonally, in the masculine; thus *ṣhā-ṣ* *ṣhā-ṣ* *ṣhā-ṣ* [masc., not *māṣ*, (fem.), by-the-king, with reference-to-the-tigress, it-(impersonal)-was-killed, i.e. the king killed the tigress. But in G. and R., even if the object is in the dative, the past participle agrees with it; thus, G. *ṣhā-ṣ* *ṣhā-ṣ* *ṣhā-ṣ*, by-the-king, with-reference-to-the-tigress, she-was-killed. Other examples from G. of this passive construction are *mē* *ṣhā-ṣ*, by me it was said, I said; *ṣhā-ṣ* *ṣhā-ṣ* *ṣhā-ṣ*, by him a letter was written, he wrote a letter; *ṣhā-ṣ* *ṣhā-ṣ* *ṣhā-ṣ*, by this lady, in the wilderness, days were passed, i.e. she passed her days in the wilderness; *ṣhā-ṣ* *ṣhā-ṣ*, the king considered. The idiom of R. is exactly the same in these cases, except that the masculine must be used where G. has the neuter; thus, *ṣhā-ṣ* *ṣhā-ṣ*. The future passive participle is construed in much the same way, but (as in Latin) the subject may be put into the dative. Thus, *māṣ* *ṣ* *ṣhā-ṣ*, *mihē* *ṣ* *ṣhā-ṣ* *ṣhā-ṣ* (est) *ṣhā-ṣ*, I must read that book, but also *ṣhā-ṣ* (agent case) *ṣ* *ṣhā-ṣ*, by him this business is to be done.

G. also forms a past participle in *ṣhā* (*calliṣ*), which is one of the many survivals of the outer language. This *-ṣhā* participle is typical of most of the languages of the outer band, including Marathi, Oriya, Bengali, Bihari and Assamese. It is formed by the addition of the

Prakrit pleonastic suffix *-ṣhā*, which was not used by the Prakrit of the Midland, but was common elsewhere. Compare, for instance, the Ardhmagadhī past participle passive *ṣhā-ṣhā*, brought.

The usual verbs substantive are as follows: G. *chā*, R. *hā* or *chā*, I am, which are conjugated regularly as old presents, and G. *hā*, R. *hā* or *chā*, was, which is a past participle, like the Hindostani (q.v.) *thā*. *Hā*, *hā* and *chā* are explained in the article on that language. *Chā* is for Skr. *ṣhāmi*, Ap. *acchāṣ*. The use of this base is one of the outer band survivals. Even in Prakrit, it is not found (so far as the present writer is aware) in the Saurashtra of the Midland. Using these as auxiliaries the finite verb makes a whole series of periphrastic tenses. A present definite is formed by conjugating the old present tense (not the present participle) with the present tense of the verb substantive. Thus, G. *callā chā*, I am going. A similar idiom is found in some Western Hindi dialects, but Hindostani employs the present participle; thus, *callā hā*. In G. and R., however, the imperfect is formed with the present participle as in H. Thus, G. *hā call-ṣ* *hā*, I was going. So, as in H., we have a perfect *hā call-ṣ* (or *call-ṣ*) *chā*, I have gone, and a pluperfect *hā call-ṣ* (or *call-ṣ*) *hā*, I had gone. The R. periphrastic tenses are made on the same principles. With the genitive of the G. future passive participle, *call-ṣ-ṣ*, we have a kind of gerundive, as in *hā call-ṣ-ṣ* *chā*, I am to be gone, i.e. I am about to go; *hā call-ṣ-ṣ* *hā*, I was about to go.

The same series of derivative verbs occurs in G. and R. as in H. Thus, we have a potential passive (a simple passive in G.) formed by adding *ṣ* to the base, as in G. *call-ṣ-ṣ*, to write, *call-ṣ-ṣ*, to be written; and a causal by adding *ṣ* or *ṣ*, as in *call-ṣ-ṣ*, to cause to write; *ṣhā-ṣ*, to sit, *ṣhā-ṣ*, to seat. A new passive may be formed in G. from the causal, as in *ṣhā-ṣ-ṣ*, to be hot; *ṣhā-ṣ-ṣ*, to cause to be hot; to heat; *ṣhā-ṣ-ṣ*, to be heated.

Several verbs have irregular past participles. These must be learnt from the grammar. So also the numerous compound verbs, such as (G.) *call-ṣ-ṣ*, to be able to go; *call-ṣ-ṣ*, to have completed going; *call-ṣ-ṣ*, to be in the habit of going, and so on.

Very little is known about the literature of Rajputana, except that it is of large extent. It includes a number of bardic chronicles of which only one has been partially edited, but the contents of which have been described by Tod in his *Literature of Rajasthani*. It also includes a considerable religious literature, but the whole mass of this is still in MS. From those specimens which the present writer has examined, it would appear that most of the authors wrote in Braj Bhasha, the Hindu literary dialect of Hindostani (q.v.). In Marwar it is an acknowledged fact that the literature falls into two branches, one called *Pingal* and couched in Braj Bhasha, and the other called *Dingal* and couched in Rajasthani. The most admired work in Dingal is the *Raghunāth Rāpāk* written by Mansā Rām in the beginning of the 19th century. It is nominally a treatise on prosody, but, like many other works of the same kind, it contrives to pay a double debt, for the examples of the metres are so arranged as to form a complete epic poem celebrating the deeds of the hero Rāma.

The earliest writer of importance in Gujarati, and its most admired poet, was Narsingh MEṬA, who lived in the 15th century A.D. Before him there were writers on Sanskrit grammar, rhetoric and the like, who employed an old form of Gujarati for their explanations. Narsingh does not appear to have written any considerable work, his reputation depending on his short songs, many of which exhibit much felicity of diction. He had several successors, all admittedly his inferiors. Perhaps the most noteworthy of these was Rōwā Sankar, the translator of the *Mahābhārata* (see SANSKRIT: *Literature*). A more important side of Gujarati literature is its bardic chronicles, the contents of which have been utilized by Forbes in his *Rās Mālā*. Modern Gujarati literature mostly consists of translations or imitations of English works.

AUTHORITIES.—Volume ix. of the *Linguistic Survey of India* contains a full and complete account of Gujarati and Rajasthani, including their various dialectic forms.

For Rajasthani, see S. H. Kellogg, *Grammar of the Hindi Language* (2nd ed., London, 1893). In this are described several dialects of Rajasthani. See also Rām Karo Sarmā, *Mārwarī Vyākaraṇa* (Jodhpur, 1901) (a Marwari grammar written in that language), and G. Macalister, *Specimens of the Dialects spoken in the State of Jaipur* (contains specimens, vocabularies and grammars) (Allahabad, 1898).

For Gujarati, there are numerous grammars, amongst which may note W. St C. Tisdall, *Simplified Grammar of the Gujarati Language* (London, 1892) and (the most complete) G. P. Taylor, *The Student's Gujarati Grammar* (2nd ed., Bombay, 1908). As for dictionaries, the most authoritative is the *Narvaṣ* of Narmaḍā

Sankar (Bhaunagar and Surat, 1873), in Gujarati throughout. For English readers we may mention Shahpurji Edalji's (2nd ed., Bombay, 1868), the introduction to which contains an account of Gujarati literature by J. Glasgow, Belare's (Ahmedabad, 1895), and Karbhari's (Ahmedabad, 1899). (G. A. G.)

GUJRANWALA, a town and district of British India, in the Lahore division of the Punjab. The town is situated 40 m. N. of Lahore by rail. It is of modern growth, and owes its importance to the father and grandfather of Maharaja Ranjit Singh, whose capital it formed during the early period of the Sikh power. Pop. (1901) 29,224. There are manufactures of brass-ware, jewellery, and silk and cotton scarves.

The DISTRICT comprises an area of 3198 sq. m. In 1901 the population was 756,797, showing an increase of 29% in the decade. The district is divided between a low alluvial tract along the rivers Chenab and Degh and the upland between them, which forms the central portion of the Rechna Doab, intermediate between the fertile submontane plains of Sialkot and the desert expanses of Jhang. Part of the upland tract has been brought under cultivation by the Chenab canal. The country is very bare of trees, and the scenery throughout is tame and in the central plateau becomes monotonous. It seems likely that the district once contained the capital of the Punjab, at an epoch when Lahore had not begun to exist. We learn from the Chinese Buddhist pilgrim, Hsuan Tsang, that about the year 630 he visited a town known as Tse-ki (or Taki), the metropolis of the whole country of the five rivers. A mound near the modern village of Asarur has been identified as the site of the ancient capital. Until the Mahomedan invasions little is known of Gujranwala, except that Taki had fallen into oblivion and Lahore had become the chief city. Under Mahomedan rule the district flourished for a time; but a mysterious depopulation fell upon the tract, and the whole region seems to have been almost entirely abandoned. On the rise of Sikh power, the waste plains of Gujranwala were seized by various military adventurers. Charat Singh took possession of the village of Gujranwala, and here his grandson the great Maharaja Ranjit Singh was born. The Sikh rule, which was elsewhere so disastrous, appears to have been an unmitigated benefit to this district. Ranjit Singh settled large colonies in the various villages, and encouraged cultivation throughout the depopulated plain. In 1847 the district came under British influence in connexion with the regency at Lahore; and in 1849 it was included in the territory annexed after the second Sikh war. A large export trade is carried on in cotton, wheat and other grains. The district is served by the main line and branches of the North-Western railway.

GUJRAT, a town and district of British India, in the Rawalpindi division of the Punjab, lying on the south-western border of Kashmir. The town stands about 5 m. from the right bank of the river Chenab, 70 m. N. of Lahore by rail. Pop. (1901) 19,410. It is built upon an ancient site, formerly occupied, according to tradition, by two successive cities, the second of which is supposed to have been destroyed in 1303, the year of a Mongol invasion. More than 200 years later either Sher Shah or Akbar founded the existing town. Though standing in the midst of a Jat neighbourhood, the fort was first garrisoned by Gujars, and took the name of Gujrat. Akbar's fort, largely improved by Gujjar Singh, stands in the centre of the town. The neighbouring shrine of the saint Shah Daula serves as a kind of native asylum for lunatics. The town has manufactures of furniture, inlaid work in gold and iron, brass-ware, boots, cotton goods and shawls.

The DISTRICT of GUJRAT comprises a narrow wedge of sub-Himalayan plain country, possessing few natural advantages. From the basin of the Chenab on the south the general level rises rapidly towards the interior, which, owing to the great distance of the water beneath the surface, assumes a dreary and desert aspect. A range of low hills, known as the Pabbi, traverses the northern angle of Gujrat. They are composed of a friable Tertiary sandstone and conglomerate, destitute of vegetation, and presenting a mere barren chaos of naked rock, deeply scored with precipitous ravines. Immediately below the

Pabbi stretches a high plateau, terminating abruptly in a precipitous bluff some 200 ft. in height. At the foot of this plateau is a plain, which forms the actual valley of the Chenab and participates in the irrigation from the river bed.

Numerous relics of antiquity stud the surface of the district. Mounds of ancient construction yield early coins, and bricks are found whose size and type prove them to belong to the prehistoric period. A mound now occupied by the village of Moga of Mong has been identified as the site of Nisces, the city built by Alexander the Great on the field of his victory over Porus. The Delhi empire established its authority in this district under Bahlol Lodi (1431-1489). A century later it was visited by Akbar, who founded Gujrat as the seat of government. During the decay of the Mogul power, the Ghakkars of Rawalpindi overran this portion of the Punjab and established themselves in Gujrat about 1741. Meanwhile the Sikh power had been asserting itself in the eastern Punjab, and in 1763 the Ghakkars chief was defeated by Sirdar Gujjar Singh, chief of the Bhangi confederacy. On his death, his son succeeded him, but after a few months' warfare, he submitted himself as vassal to the Maharaja Ranjit Singh. In 1846 Gujrat first came under the supervision of British officials. Two years later the district became the theatre for the important engagements which decided the event of the second Sikh war. After several bloody battles in which the British were unsuccessful, the Sikh power was irretrievably broken at the engagement which took place at Gujrat on the 22nd of February 1849. The Punjab then passed by annexation under British rule.

The district comprises an area of 2031 sq. m. In 1901 the population was 750,548, showing a decrease of 1% compared with an increase of 10% in the previous decade. The district has a large export trade in wheat and other grains, oil, wool, cotton and hides. The main line and the Sind-Sagar branch of the North-Western railway traverse it.

GULA, a Babylonian goddess, the consort of Ninib. She is identical with another goddess, known as Bau, though it would seem that the two were originally independent. The name Bau is more common in the oldest period and gives way in the post-Khammurabic age to Gula. Since it is probable that Ninib (g.a.) has absorbed the cults of minor sun-deities, the two names may represent consorts of different gods. However this may be, the qualities of both are alike, and the two occur as synonymous designations of Ninib's female consort. Other names borne by this goddess are Nin-Karrak, Ga-tum-dug and Nin-din-dug, the latter signifying "the lady who restores to life." The designation well emphasizes the chief trait of Bau-Gula which is that of healer. She is often spoken of as "the great physician," and accordingly plays a specially prominent rôle in incantations and incantation rituals intended to relieve those suffering from disease. She is, however, also invoked to curse those who trample upon the rights of rulers or those who do wrong with poisonous potions. As in the case of Ninib, the cult of Bau-Gula is prominent in Shirgulla and in Nippur. While generally in close association with her consort, she is also invoked by herself, and thus retains a larger measure of independence than most of the goddesses of Babylonia and Assyria. She appears in a prominent position on the designs accompanying the Kudurrus boundary-stone monuments of Babylonia, being represented by a statue, when other gods and goddesses are merely pictured by their shrines, by sacred animals or by weapons. In neo-Babylonian days her cult continues to occupy a prominent position, and Nebuchadrezzar II. speaks of no less than three chapels or shrines within the sacred precincts of E-Zida in the city of Borsippa, besides a temple in her honour at Babylon. (M. J. A.)

GULBARGA, an ancient city of India, situated in the Nizam's dominions, 70 m. S.E. of Sholapur. Pop. (1901) 29,228. Originally a Hindu city, it was made the capital of the Bahmani kings when that dynasty established their independence in the Deccan in 1347, and it remained such until 1422. The palaces, mosques and tombs of these kings still stand half-ruined. The most notable building is a mosque modelled after that of Cordova

in Spain, covering an area of 38,000 sq. ft., which is almost unique in India as being entirely covered in. Since the opening of a station on the Great India Peninsula railway, Gulbarga has become a centre of trade, with cotton-spinning and weaving mills. It is also the headquarters of a district and division of the same name. The district, as recently reconstituted, has an area of 6004 sq. m.; pop. (1901), 1,047,667.

GULF STREAM, the name properly applied to the stream current which issues from the Gulf of Mexico and flows north-eastward, following the eastern coast of North America, and separated from it by a narrow strip of cold water (the *Cold Wall*), to a point east of the Grand Banks off Newfoundland. The Gulf Stream is a narrow, deep current, and its velocity is estimated at about 80 m. a day. It is joined by, and often indistinguishable from, a large body of water which comes from outside the West Indies and follows the same course. The term was formerly applied to the drift current which carries the mixed waters of the Gulf Stream and the Labrador current eastwards across the Atlantic. This is now usually known as the "Gulf Stream drift," although the name is not altogether appropriate. See ATLANTIC.

GULFWOOD, in botany, a popular name for the seaweed *Sargassum bacciferum*, one of the brown seaweeds (Phaeophyceae), large quantities of which are found floating in the Gulf of Mexico, whence it is carried northwards by the Gulf Stream, small portions sometimes being borne as far as the coasts of the British Isles. It was observed by Columbus, and is remarkable among seaweeds for its form, which resembles branches bearing leaves and berries; the latter, to which the species-name *bacciferum* refers, are hollow floats answering the same purpose as the bladders in another brown seaweed, *Fucus vesiculosus*, which is common round the British Isles between high and low water.

GULL, SIR WILLIAM WITHEY, 1st Bart. (1816-1890), English physician, was the youngest son of John Gull, a barge-owner and wharfinger of Thorpe-le-Soken; Essex, and was born on the 31st of December 1816 at Colchester. He began life as a schoolmaster, but in 1837 Benjamin Harrison, the treasurer of Guy's Hospital, who had noticed his ability, brought him up to London from the school at Lewes where he was usher, and gave him employment at the hospital, where he also gained permission to attend the lectures. In 1843 he was made a lecturer in the medical school of the hospital, in 1851 he was chosen an assistant physician, and in 1856 he became full physician. In 1847 he was elected Fullerian professor of physiology in the Royal Institution, retaining the post for the usual three years, and in 1848 he delivered the Gulstonian Lectures at the College of Physicians, where he filled every office of honour but that of president. He died in London on the 20th of January 1890 after a series of paralytic strokes, the first of which had occurred nearly three years previously. He was created a baronet in 1872, in recognition of the skill and care he had shown in attending the prince of Wales during his attack of typhoid in 1871. Sir William Gull's fame rested mainly on his success as a clinical practitioner; as he said himself, he was "a clinical physician or nothing." This success must be largely ascribed to his remarkable powers of observation, and to the great opportunities he enjoyed for gaining experience of disease. He was sometimes accused of being a disbeliever in drugs. That was not the case, for he prescribed drugs like other physicians when he considered them likely to be beneficial. He felt, however, that their administration was only a part of the physician's duties, and his mental honesty and outspokenness prevented him from deluding either himself or his patients with unwarranted notions of what they can do. But though he regarded medicine as primarily an art for the relief of physical suffering, he was far from disregarding the scientific side of his

¹The word "gulf" a portion of the sea partially enclosed by the coast-line, and usually taken as referring to a tract of water larger than a bay and smaller than a sea, is derived through the Fr. *golfe*, from Late Gr. *gállos*, class. Gr. *gállos*, bosom, hence bay, cf. *Lat. sinus*. In University slang, the term is used of the position of those who fail to obtain a place in the honours list at a public examination, but are allowed a "pass."

profession, and he made some real contributions to medical science. His papers were printed chiefly in *Guy's Hospital Reports* and in the proceedings of learned societies; among the subjects he wrote about were cholera, rheumatic fever, tetanus, paraplegia and abscess of the brain, while he distinguished for the first time (1873) the disease now known as myxoedema, describing it as a "cretinoid state in adults."

GULL (Welsh *gwytan*, Breton, *goulann*, whence Fr. *gouland*), the name commonly adopted, to the almost entire exclusion of the O. Eng. *Maw* (Icel. *máfur*, Dan. *maags*, Swedish *måse*, Ger. *Meve*, Dutch *meeuw*, Fr. *moquette*), for a group of sea-birds widely and commonly known, all belonging to the genus *Larus* of Linnaeus, which subsequent systematists have broken up in a very arbitrary and often absurd fashion. The family *Laridae* is composed of two chief groups, *Larinae* and *Sterninae*—the gulls and the terns, though two other subfamilies are frequently counted, the skuas (*Stercorariinae*), and that formed by the single genus *Rhynchops*, the skimmers; but there seems no strong reason why the former should not be referred to the *Larinae* and the latter to the *Sterninae*.

Taking the gulls in their restricted sense, Howard Saunders, who has subjected the group to a rigorous revision (*Proc. Zool. Society*, 1878, pp. 155-211), admits forty-nine species of them, which he places in five genera instead of the many which some prior investigators had sought to establish. Of the genera recognized by him, *Pagophila* and *Rhodostethia* have but one species each, *Rissa* and *Xema* two, while the rest belong to *Larus*. The *Pagophila* is the so-called ivory-gull, *P. eburnea*, names which hardly do justice to the extreme whiteness of its plumage, to which its jet-black legs offer a strong contrast. The young, however, are spotted with black. An inhabitant of the most northern seas, examples, most commonly young birds of the year, find their way in winter to more temperate shores. Its breeding-place has seldom been discovered, and the first of its eggs ever seen by ornithologists was brought home by Sir L. M'Clintock in 1853 from Cape Krabbe (*Journ. R. Dubl. Society*, i. 60, pl. 1); others were subsequently obtained by Dr Malmgren in Spitsbergen. Of the species of *Rissa*, one is the abundant and well-known kittiwake, *R. tridactyla*, of circumpolar range, breeding, however, also in comparatively low latitudes, as on the coasts of Britain, and in winter frequenting southern waters. The other is *R. brevirostris*, limited to the North Pacific, between Alaska and Kamchatka. The singular fact requires to be noticed that in both these species the hind toe is generally deficient, but that examples of each are occasionally found in which this functionless member has not wholly disappeared. We have then the genus *Larus*, which ornithologists have attempted most unsuccessfully to subdivide. It contains the largest as well as the smallest of gulls. In some species the adults assume a dark-coloured head every breeding-season, in others any trace of dark colour is the mark of immaturity. The larger species prey fiercely on other kinds of birds, while the smaller content themselves with a diet of small animals, often insects and worms. But however diverse be the appearance, structure or habits of the extremities of the series of species, they are so closely connected by intermediate forms that it is hard to find a gap between them that would justify a generic division. Forty-three species of this genus are recognized by Saunders. About fifteen belong to Europe and fourteen to North America, of which (excluding stragglers) some five only are common to both countries. Our knowledge of the geographical distribution of several of them is still incomplete. Some have a very wide range, others very much the reverse, as witness *L. fuliginosus*, believed to be confined to the Galapagos, and *L. scopulinus* and *L. bulleri* to New Zealand,—the last indeed perhaps only to the South Island. The largest species of the group are the glaucous gull and greater black-backed gull, *L. glaucus* and *L. marinus*, of which the former is circumpolar, and the latter nearly so—not being hitherto found between Labrador and Japan. The smallest species is the European *L. minutus*, though the North American *L. philadelphia* does not much exceed it in size. Many of the gulls congregate in vast numbers to breed, whether on rocky cliffs of the sea-coast

or on healthy islands in inland waters. Some of the settlements of the black-headed or "pewit" gull, *L. ridibundus*, are a source of no small profit to their proprietors,—the eggs, which are rightly accounted a great delicacy, being taken on an orderly system up to a certain day, and the birds carefully protected. Ross's or the roseate gull, *Rhodostethia rosea*, forms a well-marked genus, distinguished not so much by the pink tint of its plumage (for that is found in other species) but by its small dove-like bill and wedge-shaped tail. It is an exceedingly scarce bird, and beyond its having an Arctic habitat, little has yet been ascertained about it. More rare still is one of the species of *Xema*, *X. fuscicornis*, of which only two specimens, both believed to have come from the Galapagos, have been seen. Its smaller congener Sabine's gull, *X. sabini*, is more common, and has been found breeding both in Arctic America and in Siberia, and several examples, chiefly immature birds, have been obtained in the British islands. Both species of *Xema* are readily distinguished from all other gulls by their forked tails. (A. N.)

GULLY, JOHN (1783-1863), English sportsman and politician, was born at Wick, near Bath, on the 21st of August 1783, the son of an innkeeper. He came into prominence as a boxer, and in 1805 he was matched against Henry Pearce, the "Game Chicken," before the duke of Clarence (afterwards William IV.) and numerous other spectators, and after fighting sixty-four rounds, which occupied an hour and seventeen minutes, was beaten. In 1807 he twice fought Bob Gregson, the Lancashire giant, for two hundred guineas a side, winning on both occasions. As the landlord of the "Plough" tavern in Carey Street, London, he retired from the ring in 1808, and took to horse-racing. In 1817 he lost £40,000 by backing his horse "Mameluke" (for which he had paid four thousand guineas) for the St Leger. In partnership with Robert Redkale, in 1832, he made £85,000 by winning the Derby and St Leger with "St Giles" and "Mansgrave." In partnership with John Day he won the Two Thousand Guineas with "Ugly Buck" in 1844 and two years later he took the Derby and the Oaks with "Pyrrhus the First" and "Mendicant." In 1854 the Two Thousand Guineas with "Hermis," and in the same year, in partnership with Henry Padwick, the Derby with "Andover." Having bought Ackworth Park near Pontefract he was M.P. from December 1832 to July 1837. In 1862 he purchased the Wingate Grange estate and collieries. Gully was twice married and had twelve children by each wife. He died at Durham on the 9th of March 1863. He appears to have been no relation of the subsequent Speaker, Lord Selby.

GULPÁIGÁN (*Jebdádégán* of the Arab geographers), a district and city in Central Persia, situated N.W. of Isfahán and S.E. of Irák. Together with Khunúsir it forms a small province, paying a yearly revenue of about £6000. The city of Gulpáigán is situated 37 m. N.W. of Isfahán, at an elevation of 5875 ft. in 33° 24' N. and 50° 20' E., and has a population of about 5000. The district is fertile and produces much grain and some opium. Sometimes it is under the governor-general of the Isfahán province, at others it forms part of the province of Irák, and at times, as in 1906, is under a governor appointed from Teheran.

GUM (Fr. *gomme*; Lat. *gummi*, Gr. *gumma*, possibly a Coptic word; distinguish "gum" from the fleshy covering of the base of a tooth, in O. Eng. *guma*, palate, cf. Ger. *Gaumen*, roof of the mouth; the ultimate origin is probably the root *gha*, to open wide, seen in Gr. *χελύξ*, to gape, cf. "yawn"), the generic name given to a group of amorphous carbo-hydrates of the general formula $(C_6H_{10}O_5)_n$, which exist in the juices of almost all plants, and also occur as exudations from stems, branches and fruits of plants. They are entirely soluble or soften in water, and form with it a thick glutinous liquid or mucilage. They yield mucic and oxalic acids when treated with nitric acid. In structure the gums are quite amorphous, being neither organized like starch nor crystallized like sugar. They are odourless and tasteless, and some yield clear aqueous solutions—the real gums—while others swell up and will not percolate filter paper—the vegetable mucilages. The acacias and the Rosaceae yield their gums most abundantly when sickly and in an abnormal

state, caused by a fulness of sap in the young tissues, whereby the new cells are softened and finally disorganized; the cavities thus formed fill with liquid, which exudes, dries and constitutes the gum.

Gum arabic may be taken as the type of the gums entirely soluble in water. Another variety, obtained from the *Prosopis dulcis*, a leguminous plant, is called gum mesquite or mesquite; it comes from western Texas and Mexico, and is yellowish in colour, very brittle and quite soluble in water.

Gum arabic occurs in pieces of varying size, and some kinds are full of minute cracks. The specific gravity of Turkey picked gum (the purest variety) is 1.487, or, when dried at 100° C., 1.525. It is soluble in water to an indefinite extent; boiled with dilute sulphuric acid it is converted into the sugar galactose. Moderately strong nitric acid changes it into mucic, saccharic, tartaric and oxalic acids. Under the influence of yeast it does not enter into the alcoholic fermentation, but M. P. E. Berthelot, by digesting with chalk and cheese, obtained from it 12% of its weight of alcohol, along with calcium lactate, but no appreciable quantity of sugar. Gum arabic may be regarded as a potassium and calcium salt of gummic or arabic acid. T. Graham (*Chemical and Physical Researches*) recommended dialysis as the best mode of preparing gummic acid, and stated that the power of gum to penetrate the parchment septum is 400 times less than that of sodium chloride, and, further, that by mixing the gum with substances of the crystalloid class the diffusibility is lowered, and may be even reduced to nothing. The mucilage must be acidulated with hydrochloric acid before dialysing, to set free the gummic acid. By adding alcohol to the solution, the acid is precipitated as a white amorphous mass, which becomes glassy at 100°. Its formula is $(C_6H_7O_5)_2H_2O$, and it forms compounds with nearly all bases which are easily soluble in water. Gummic acid reddens litmus, its reaction being about equal to carbonic acid. When solutions of gum arabic and gelatin are mixed, oily drops of a compound of the two are precipitated, which on standing form a nearly colourless jelly, melting at 25° C., or by the heat of the hand. This substance can be washed without decomposition. Gummic acid is soluble in water; when well dried at 100° C., it becomes transformed into octagummic acid, which is insoluble, but swells up in water like gum tragacanth.

Gum arabic, when heated to 150° C. with two parts of acetic anhydride, swells up to a mass which, when washed with boiling water, and then with alcohol, gives a white amorphous insoluble powder called acetyl arabin $C_{12}H_{18}O_{10}$. It is saponified by alkalis, with reproduction of soluble gum. Gum arabic is not precipitated from solution by alum, stannous chloride, sulphate or nitrate of copper, or neutral lead acetate; with basic lead acetate it forms a white jelly, with ferric chloride it yields a stiff clear gelatinoid mass, and its solutions are also precipitated by borax.

The finer varieties are used as an emollient and demulcent in medicine, and in the manufacture of confectionery; the commoner qualities are used as an adhesive paste, for giving lustre to crape, silk, &c., in cloth finishing to stiffen the fibres, and in calico-printing. For labels, &c., it is usual to mix sugar or glycerin with it to prevent it from cracking.

Gum senegal, a variety of gum arabic produced by *Acacia Senegal*, occurs in pieces generally rounded, of the size of a pigeon's egg, and of a reddish or yellow colour, and specific gravity 1.436. It gives with water a somewhat stronger mucilage than gum arabic, from which it is distinguished by its clear interior, fewer cracks and greater toughness. It is imported from the river Gambra, and from Senegal and Bathurst.

Chagual gum, a variety brought from Santiago, Chile, resembles gum senegal. About 75% is soluble in water. Its solution is not thickened by borax, and is precipitated by neutral lead acetate; and dilute sulphuric acid converts it into *D-glucose*.

Gum tragacanth, familiarly called gum dragon, exudes from the stem, the lower part especially, of the various species of *Astragalus*, especially *A. gummifer*, and is collected in Asia Minor, the chief port of shipment being Smyrna. Formerly only what exuded spontaneously was gathered; this was often of a brownish colour; but now the flow of the gum is aided by incisions cut near the root, and the product is the fine, white, flaky variety so much valued in commerce. The chief flow of gum takes place during the night, and hot and dry weather is the most favourable for its production.

In colour gum tragacanth is of a dull white; it occurs in horny, flexible and tough, thin, twisted flakes, translucent, and with peculiar wavy lines on the surface. When dried at temperatures under 100° C. it loses about 14% of water, and is then easily powdered. Its specific gravity is 1.384. With water it swells by absorption, and

with even fifty times its weight of that liquid forms a thick mucilage. Part of it only is soluble in water, and that resembles gummic acid in being precipitated by alcohol and ammonium oxalate, but differs from it in giving a precipitate with neutral lead acetate and none with borax. The insoluble part of the gum is a calcium salt of basorin ($C_{12}H_{16}O_{11}$), which is devoid of taste and smell, forms a gelatinoid mass with water, but by continued boiling is rendered soluble.

Gum tragacanth is used in calico-printing as a thickener of colours and mordants; in medicine as a demulcent and vehicle for insoluble powders, and as an excipient in pills; and for setting and mending beetles and other insect specimens. It is medicinally superior to gum acacia, as it does not undergo acetous fermentation. The best pharmacopoeial preparation is the *Mucilage Tragacanthæ*. The compound powder is a useless preparation, as the starch it contains is very liable to ferment.

Gum kuteera resembles in appearance gum tragacanth, for which the attempt has occasionally been made to substitute it. It is said to be the product of *Sterculia urens*, a plant of the natural order Sterculiaceæ.

Cherry tree gum is an exudation from trees of the genera *Prunus* and *Cerasus*. It occurs in shiny reddish lumps, resembling the commoner kinds of gum arabic. With water, in which it is only partially soluble, it forms a thick mucilage. Sulphuric acid converts it into *l*-arabinose; and nitric acid oxidizes it to oxalic acid (without the intermediate formation of mucic acid as in the case of gum arabic).

Gum of Bassora, from Bassora or Bussorah in Asia, is sometimes imported into the London market under the name of the bog tragacanth. It is insipid, crackles between the teeth, occurs in variable-sized pieces, is tough, of a yellowish-white colour, and opaque, and has properties similar to gum tragacanth. Its specific gravity is 1.36. It contains only 1% of soluble gum or arabin. Under the name of Caramania gum it is mixed with inferior kinds of gum tragacanth before exportation.

Mucilage.—Very many seeds, roots, &c., when infused in boiling water, yield mucilages which, for the most part, consist of basorin. Linseed, quince seed and marshmallow root yield it in large quantity. In their reactions the different kinds of mucilage present differences; e.g. quince seed yields only oxalic acid when treated with nitric acid, and with a solution of iodine in zinc iodide it gives, after some time, a beautiful red tint. Linseed does not give the latter reaction; by treatment with boiling nitric acid it yields mucic and oxalic acids.

Gum Resins.—This term is applied to the inspissated milky juices of certain plants, which consist of gum soluble in water, resin and essential oil soluble in alcohol, other vegetable matter and a small amount of mineral matter. They are generally opaque and solid, and often brittle. When finely powdered and rubbed down with water they form emulsions, the undissolved resin being suspended in the gum solution. Their chief uses are in medicine. Examples are ammoniacum, asafoetida, bdellium, euphorbium, gamboge, myrrh, sagapanum and scammony.

GÜMBEL, KARL WILHELM VON, BARON (1823-1898), German geologist, was born at Dannenfels, in the Palatinate of the Rhine, on the 11th of February 1823, and is known chiefly by his researches on the geology of Bavaria. He received a practical and scientific education in mining at Munaich and Heidelberg, taking the degree of Ph.D. at Munich in 1862; and he was engaged for a time at the colliery of St Ingbert and as a surveyor in that district. In 1851, when the Geological Survey of Bavaria was instituted, Gumbel was appointed chief geologist; in 1863 he was made honorary professor of geognosy and surveying at the university of Munich, and in 1879, Oberberg director of the Bavarian mining department with which the Geological Survey was incorporated. His geological map of Bavaria appeared in 1858, and the official memoir descriptive of the detailed work, entitled *Geognostische Beschreibung des Königreichs Bayern* was issued in three parts (1861, 1868 and 1879). He subsequently published his *Geologie von Bayern* in 3 vols. (1884-1894), an elaborate treatise on geology, with special reference to the geology of Bavaria. In the course of his long and active career he engaged in much palaeontological work: he studied the fauna of the Trias, and in 1867 introduced the

term Rhaetic for the uppermost division of that system; he supported at first the view of the organic nature of *Looson* (1866 and 1876), he devoted special attention to Foraminifera, and described those of the Eocene strata of the northern Alps (1868); he dealt also with Receptaculites (1875) which he regarded as a genus belonging to the Foraminifera. He died on the 18th of June 1898.

GUMBINNEN, a town of Germany, in the Prussian province of East Prussia, on the Pissa, an affluent of the Pregel, 22 m. by rail S.W. of Eydtkuhnen on the line to Königsberg. Pop. (1905) 14,794. The surrounding country is pleasant and fruitful, and the town has spacious and regular streets shaded by linden trees. It has a Roman Catholic and three Evangelical churches, a synagogue, a gymnasium, two public schools, a public library, a hospital and an infirmary. In the market square there is a statue of the king of Prussia Frederick William I., who in 1734 raised Gumbinnen to the rank of a town, and in 1739 brought to it a number of persons who had been driven from Salzburg by religious persecution. On the bridge over the Pissa a monument has been erected to the soldiers from the neighbourhood who fell in the Franco-German war of 1870-71. Iron founding and the manufacture of machinery, wool, cotton, and linen weaving, stocking-making, tanning, brewing and distilling are the principal industries. There are horse and cattle markets, and some trade in corn and linseed.

See J. Schneider, *Aus Gumbinnens Vergangenheit* (Gumbinnen, 1904).

GUMBO, or **OKRA**, termed also *Okro*, *Ochro*, *Kamia*, *Gabbo* and Syrian mallow (Sans. *Tindisa*, Bengali *Dheras*, Pers. *Bamiyah*—the *Bamisia* of Prosper Alpinus; Fr. *Gombout*, or better *Gombo*, and *Kamia comestible*), *Hibiscus esculentus*, a herbaceous hairy annual plant of the natural order *Malvaceæ*, probably of African origin, and now naturalized or cultivated in all tropical countries. The leaves are cordate, and 3 to 5-lobed, and the flowers yellow, with a crimson centre; the fruit or pod, the *Bendi-Kai* of the Europeans of southern India, is a tapering, 10-angled capsule, 4 to 10 in. in length, except in the dwarf varieties of the plant, and contains numerous oval dark-coloured seeds, hairy at the base. Three distinct varieties of the gumbo (*Quiabo* and *Quingombo*) in Brazil have been described by Pacheco. The unripe fruit is eaten either pickled or prepared like asparagus. It is also an ingredient in various dishes, e.g. the *gumbo* of the Southern United States and the *calalou* of Jamaica; and on account of the large amount of mucilage it contains, it is extensively consumed, both fresh and in the form of the prepared powder, for the thickening of broths and soups. For winter use it is salted or sliced and dried. The fruit is grown on a very large scale in the vicinity of Constantinople. It was one of the esculents of Egypt in the time of Abul-Abbas el-Nebati, who journeyed to Alexandria in 1216 (*Wüstenfeld, Gesch. d. arab. Arzte*, p. 118, Göt., 1840), and is still cultivated by the Egyptians, who called it *Bamag*.

The seeds of the gumbo are used as a substitute for coffee. From their demulcent and emollient properties, the leaves and immature fruit have long been in repute in the East for the preparation of poultices and fomentations. Alpinus (1592) mentions the employment of their decoction in Egypt in ophthalmia and in uterine and other complaints.

The musk okra (Sans. *Laidhasturikā*, cf. the Gr. *okrap*; Bengali, *Laidhasturi*; Ger. *Bismörkentranch*; Fr. *Kamia musquée*), *Hibiscus Abolmenchar* (*A balsamachus moschatus*), indigenous to India, and cultivated in most warm regions of the globe, is a suffruticose plant, bearing a conical 5-ridged pod about 3 in. in length, within which are numerous brown reniform seeds, smaller than those of *H. esculentus*. The seeds possess a stinky odour, due to an oleo-resin present in the integument, and are known to perfumers under the name of *ambrette* as a substitute for musk. They are said to be used by the Arabs for scenting coffee. The seeds (in the Fantee language, *Inromakom*) are used in Africa as beads; and powdered and steeped in rum they are valued in the West Indies as a remedy for snake-bites. The plant yields an excellent fibre, and, being rich in mucilage, is employed in Upper India for the clarifying of sugar. The best-perfumed seeds are reported to come from Martinique.

See P. Alpinus, *De plantis Aegypti*, chap. xxvii. p. 38 (Venice, 1592); J. Sontheimer's *Abd Allah ibn Ahmad*, &c., i. 118 (Stuttgart,

(1840-1847); P. P. Pacheco, "La Ketmie potagire ou comestible," *La Belgique horticole*, iv, 63 (1853); Della Sudda, "De l'emploi à Constantinople de la racine de l'*Hibiscus esculentus*," *Répert. de pharm.*, January 1860, p. 229; E. J. Waring, *Pharm. of India*, p. 35 (1868); O. Popp, "Über die Aschenbestandteile der Samen von *Acacia nilotica* und *Hibiscus esculentus* in Ägypten," *Arch. der Pharm. conc. p.* 140 (1871); Dewar, *The Useful Plants of India*, pp. 1, 2 (2nd ed., 1873); U. C. Dut, *The Mat. Med. of the Hindus*, pp. 123, 321 (1877); Lanessan, *Hist. des drogues*, I, 181-184 (1878); C. Watt, *Dictionary of the Economic Products of India* (1890).

GUMTI, a river of northern India. It rises in a depression in the Pilibhit district of the United Provinces, and after a sinuous but generally south-easterly course of 300 m. past Lucknow and Jaunpur joins the Ganges in Ghazipur district. At Jaunpur it is a fine stream, spanned by a 16th-century bridge of sixteen arches, and is navigable by vessels of 17 tons burden. There is also a small river of the same name in the Tippera district of eastern Bengal and Assam.

GUMULJINA, or **GUMURJINA**, a town of European Turkey, in the vilayet of Adrianople. Pop. (1905), about 8000, of whom three-fourths are Turks and the remainder Greeks, Jews or Armenians. Gumuljina is situated on the river Katsja-Su, south of the eastern extremity of the Rhodope range of mountains and 13 m. inland from the Aegean Sea. It has a station on the railway between Salonica and Dédragatch. The district produces wheat, maize, barley and tobacco; sericulture and viticulture are both practised on a limited scale. A cattle fair is held annually on Greek Palm Sunday. Copper and antimony are found in the neighbourhood.

GUMUS, or **GUMZ**, Negroes of the Shangai group of tribes, dwelling in the mountainous district of Fasogli on the Sudan-Abyssinia frontier. They live in independent groups, some being mountaineers while others are settled on the banks of the Blue Nile. Gumz in the native tongue signifies "people," and the sub-tribes have distinctive names. The Gumus are nature-worshippers, God and the sun being synonymous. On ceremonial occasions they carry parasols of honour (see SHANGALLA).

GÜMÜSH-KHANEH, the chief town of a sanjak of the same name in the Trebizond vilayet of Asiatic Turkey, situated on high ground (4400 ft.) in the valley of the Kharabut Su, about ½ m. to south of the Trebizond-Erzurum *chaussée*. The silver mines from which the place takes its name were noted in ancient times and are mentioned by Marco Polo. Pop. about 3000, chiefly Greeks, who are in the habit of emigrating to great distances to work in mines. They practically supply the whole lead- and silver-mining labour in Asiatic Turkey; and in consequence the Greek bishop of Gümüş-Khaneh has under his jurisdiction all the communities engaged in this particular class of mines.

GUN, a general term for a weapon, tubular in form, from which a projectile is discharged by means of an explosive. When applied to artillery the word is confined to those pieces of ordnance which have a direct as opposed to a high-angle fire, in which case the terms "howitzer" and "mortar" are used (see ORDNANCE and MACHINE-GUN). "Gun" as applied to firearms which are carried in the hand and fired from the shoulder, the old "hand gun," is now chiefly used of the sporting shot-gun, with which this article mainly deals; in military usage this type of weapon, whether rifle, carbine, &c., is known collectively as "small arms" (see RIFLE and PISTOL). The origin of the word, which in Mid. Eng. is *gonne* or *gunne*, is obscure, but it has been suggested by Professor W. W. Skeat that it conceals a female name, *Gunnilda* or *Gunhilda*. The names, e.g. Mons Meg at Edinburgh Castle and *faule Greta* (heavy Peg), known to readers of Carlyle's *Frederick the Great*, will be familiar parallels. "Gunn" would be a shortened "pet name" of *Gunnhilda*. The *New English Dictionary* finds support for the suggestion in the fact that in Old Norwegian *gunne* and *hilde* both mean "war" and quotes an inventory of war material at Windsor Castle in 1330-1331, where is mentioned "una magna balista de cornu quae vocatur Domina Gunnilda." Another suggestion for the origin of the word is that the word represents

a shortened form, *gonne*, of a supposed French *mangonne*, a mangonel; but the French word is *mangousson*.

Firearms are said to have been first used in European warfare in the 14th century. The hand gun (see fig. 1) came into practical use in 1416 and was of very rude construction. It consisted of a simple iron or brass tube with a touch-hole at the top fixed in a straight stock of wood, the end of which passed under the right *ampit* when the "gonne" was about to be fired. A similar weapon (see fig. 2) was



FIG. 1.—Hand Gun.

also used by the horse-soldier, with a ring at the end of the stock, by which it was suspended by a cord round the neck; a forked rest, fitted by a ring to the saddlebow, served to steady the gun. This rest, when not in use, hung down in front of the right leg. A match was made of cotton or hemp spun slack, and boiled in a strong solution of saltpetre or in the lees of wine. The touch-hole was first placed on the top of the barrel, but afterwards at the side, with a small pan underneath to hold the priming, and guarded by a cover moving on a pivot.

An improvement in firearms took place in the first year of the reign of Henry VII., or at the close of Edward IV., by fixing a cock (Fr. *serpentine*) on the hand gun to hold the match, which was brought down to the priming by a trigger, whence the term matchlock. This weapon is still in use among the Chinese, Tartars, Sikhs, Persians and Turks. An improvement in the stock was also made during this period by forming it with a wide butt end so to be placed against the right breast. Subsequently the stock was bent, a German invention, and the arm was called a hackbutt or hagbut, and the smaller variety a demihague. The arquebus and hackbutt were about a yard in length, including barrel and stock, and the demihague was about half the size and weight, the forerunner of the pistol. The arquebus was the standard infantry firearm in Europe from the battle of Pavia to the introduction of the heavier and more powerful musket. It did not as a rule require a rest, as did the musket. The wheel-lock, an improvement on the matchlock, was in-



FIG. 2.—Mounted Man with Hand Gun.



From General Hardy de Péria's *Traité de l'Art de la Guerre*, 1666.

FIG. 3.—Musketeer, 1666.

vented in Nuremberg in 1517; was first used at the siege of Parma in 1521; was brought to England in 1530, and continued in partial use there until the time of Charles II. This wheel-lock consisted of a fluted or grooved steel wheel which protruded into the priming pan, and was connected with a strong spring. The cock, also regulated by a spring, was fitted with a piece of iron pyrites. In order to discharge the gun the

lock was wound up by a key, the cock was let down on the priming pan, the pyrites resting on the wheel; on the trigger being pressed the wheel was released and rapidly revolved, emitting sparks, which ignited the powder in the pan. The complicated and expensive nature of this lock, with its liability to injury, no doubt prevented its general adoption.

About 1540 the Spaniards constructed a larger and heavier firearm (matchlock), carrying a ball of 10 to the pound, called a muskét. This weapon was introduced into England before the middle of the 16th century, and soon came into general use throughout Europe. The snaphance was invented about this period in Germany, and from its comparative cheapness was



From General Hardy de Périn's *Tournoi de Genes*, 1660-1675.

FIGS. 4 and 5.—Musketeers, 1675.

much used in England, France and Holland. It held a flint instead of the pyrites of the wheel or firelock, which ignited the powder in the pan by striking on a piece of furrowed steel, when released by the trigger, and emitting sparks.

As a sporting weapon the gun may be said to date from the invention of the wheel-lock in the beginning of the 16th century, though firearms were used for sporting purposes in Italy, Spain, Germany, and to some extent in France, in the 15th century. Before that period the longbow in England and the crossbow on the Continent were the usual weapons of the chase. In Great Britain little use appears to have been made of firearms for game shooting until the latter half of the 17th century, and the arms then used for the purpose were entirely of foreign make.

The French gunmakers of St-Étienne claim for their town that it is the oldest centre of the firearms industry. They do not appear to have made more than the barrels of the finest sporting arms, and these even were sometimes made in Paris. The production of firearms by the artists of Paris reached its zenith about the middle of the 17th century. The Italian, German, Spanish and Russian gunsmiths also showed great skill in the elegance and design of their firearms, the Spaniards in particular being makers of fine barrels. The pistol (q.v.) is understood to have been made for the first time about 1540 at Pistoia in Italy. About 1635 the modern firelock or flint-lock was invented, which only differed from the snaphance by the cover of the pan forming part of the furrowed steel struck by the flint. Originally the priming was put into the pan from a flask containing a fine-grained powder called serpentine powder. Later the top of the cartridge was bitten off and the pan filled therewith before loading. The mechanism of the flint-lock muskét rendered all this unnecessary, as, in loading, a portion of the charge passed through the vent into the pan, where it was held by the cover or hammer. The matchlock, as a military weapon, gradually gave way to the firelock, which came into general use in the last half of the 17th century, and was the weapon of Marlborough's and Wellington's armies. This was the famous "Brown Bess" of the British army. The highest development of the flint-lock is found in the fowling-pieces of the end of the 18th and beginning of the 19th centuries, particularly those made by Joseph Manton, the celebrated English gunsmith and inventor. The Napoleonic wars afforded English gunmakers an opportunity, which they fully utilized, of gaining the supremacy over their foreign competitors in the gunmaking trade. English gunmakers reduced the weight,

improved the shooting powers, and perfected the lock mechanism of the sporting gun, and increased the range and efficiency of the rifle. This transference of the gunmaking craft from the Continent to England was also assisted by the tyranny of the foreign gunmaking guilds. In 1637 the London gunmakers obtained their charter of incorporation. The important gunmaking industry of Birmingham dates from 1603, and soon rivalled that of London. Double shot-guns do not appear to have been generally used until the 19th century.

The first successful double guns were built with the barrels over and under, and not side by side, and were invented about 1616 by one Guiliano Bossi of Rome. In 1784 double shot guns were described as a novelty. Joseph Manton patented the elevated rib which rested on the barrels. The general success of the double gun was eventually due to the light weight which the better material and workmanship of the best gunmakers made possible, and to the quickness and certainty of ignition of the modern cartridge.

The objections to the flint-lock were that it did not entirely preserve the priming from wet, and that the flint sparks sometimes failed to ignite the charge. In 1807 the Rev. Alexander John Forsyth obtained a patent for priming with a fulminating powder made of chlorate of potash, sulphur and charcoal, which exploded by concussion. This important improvement in firearms was not recognized and adopted by the military authorities until more than thirty years later. In the meantime it was gradually developed, and the copper percussion cap invented, by various gunmakers and private individuals. Thomas Shaw of Philadelphia first used fulminate in a steel cap in 1814, which he changed to a copper cap in 1816. It was not until the introduction of the copper cap that the percussion gun could be considered in every way superior to the flint. In 1834, in the reign of William IV., Forsyth's invention was tested at Woolwich by firing 6000 rounds from six flint lock muskets, and a similar number from six percussion muskets, in all weather

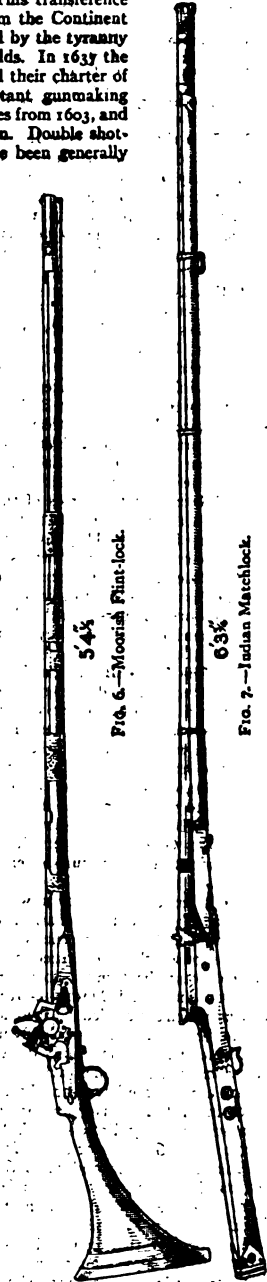

FIG. 6.—Moorish Flint-lock.

FIG. 7.—Jadian Matchlock.

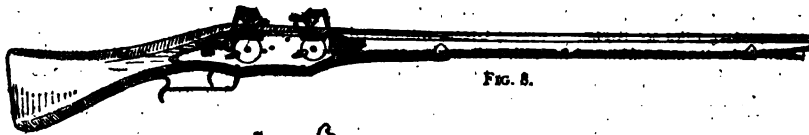

FIG. 8.

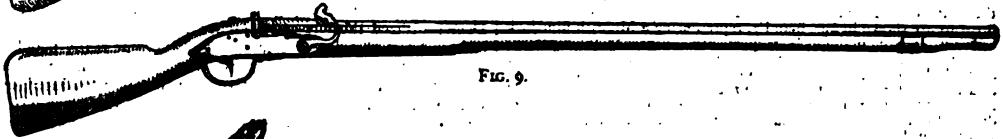

FIG. 9.

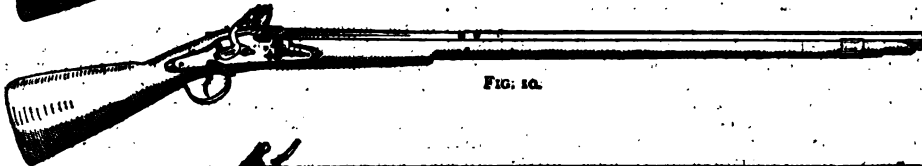

FIG. 10.

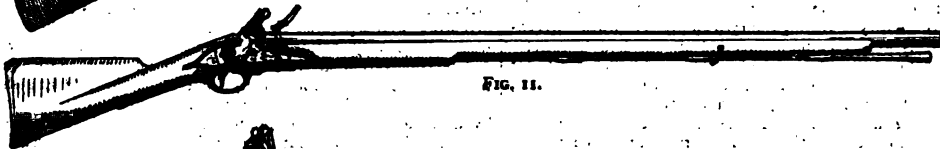

FIG. 11.

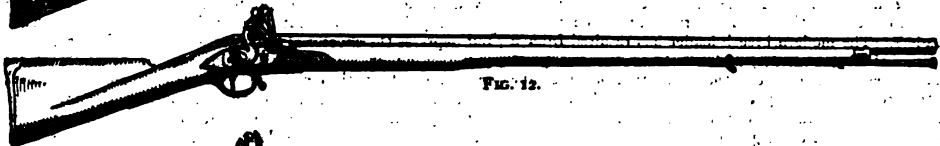

FIG. 12.

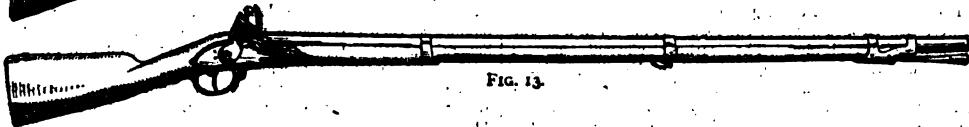

FIG. 13.

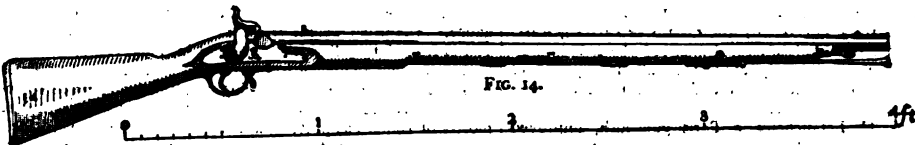

FIG. 14.



FIG. 15.

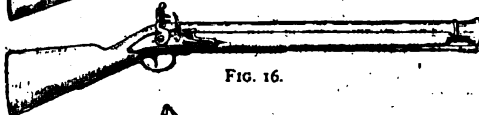

FIG. 16.



FIG. 17.

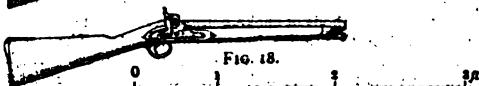

FIG. 18.

system. In consequence of this successful trial the military flint-lock in 1839 was altered to suit the percussion principle. This was easily accomplished by replacing the hammer and pan by a nipple with a hole through its centre to the vent or touch-hole, and by replacing the cock which held the flint by a smaller cock or hammer with a hollow to fit on the nipple when released by the trigger. On the nipple was placed the copper cap containing the detonating composition, now made of three parts of ebloate of potash, two of fulminate of mercury and one of powdered glass.

In 1840 the Austrian army was supplied with the percussion musket, and in 1842 a new model percussion musket with a block or back-sight for 150 yds. was issued to the British army, 23 lb 6 oz. in weight, 4 ft. 6½ in. in length without bayonet, 6 ft. with bayonet and with a barrel 3 ft. 3 in. in length, firing a bullet of 14½ to the lb with 4½ drs. of powder. This musket was larger in bore than that of France, Belgium, Russia and Austria, and thus had the advantage of being able to fire their balls, while the English balls could not be fired from their barrels. But the greater weight and momentum of the English ball was counteracted by the excess of windage. This percussion musket of 1842, the latest development of the renowned Brown Bess, continued in use in the British army until partially superseded in 1851 by the Minié rifle, and altogether by the Enfield rifle

This trial established the percussion principle. The shooting was found to be more accurate, the recoil less, the charge of powder having been reduced from 6 to 4½ drs., the rapidity of firing greater and the number of miss-fires much reduced, being as 1 to 26 nearly in favour of the percussion

in 1855. For further information as to the history and development of military, target and sporting rifles see *RIFLE*.

Illustrations are given herewith of a German carbine of the 16th century, with double wheel-lock (fig. 8); a snaplance (fig. 9); several forms of the Brown Bess or flint-lock military musket (English, William III., fig. 10; George II., fig. 11; George III., fig. 12; French, Napoleon, fig. 13); and of the percussion musket adopted in the British service in 1839 (fig. 14). Examples of non-European firearms are shown in figs. 6 and 7, representing a Moorish flint-lock and an Indian matchlock respectively. Figs. 15-18 represent various carbines, musketoons and blunderbusses, fig. 15 showing a small blunderbuss or musketoon of the early 18th century, fig. 16 a large blunderbuss of 1750, fig. 17 a flint-lock cavalry carbine of about 1825 and fig. 18 a percussion carbine of 1830. All these are drawn from arms in the museum of the Royal United Service Institution, London.

Modern Shot Guns.—The modern sporting breech-loaders may be said to have originated with the invention of the cartridge-case containing its own means of ignition. The breech-loading mechanism antedated the cartridge by many years, the earliest breech-loading hand guns dating back to 1537. Another distinct type of breech-loader was invented in France about the middle of the 17th century. During the 17th and 18th centuries breech-loading arms were very numerous and of considerable variety. The original cartridge, a charge of powder and bullet in a paper envelope, dates from 1586. These were used with muzzle-loaders, the base of the cartridge being ripped or bitten off by the soldier before placing in the barrel. It was only when the detonating cap came into use that the paper cartridge answered well in breech-loaders. The modern breech-loader has resulted from a gradual series of improvements, and not from any one great invention. Its essential feature is the prevention of all escape of gas at the breech when the gun is fired by means of an expansive cartridge-case containing its own means of ignition. The earlier breech-loaders were not gas-tight, because the cartridge-cases were either consumable or the load was placed in a strong non-expansive breech-plug. The earliest efficient modern cartridge-case was the pin-fire, patented by Houllier, a Paris gunsmith, in 1847, with a thin weak shell which expanded by the force of the explosion, fitted perfectly in the barrel, and thus formed an efficient gas check. Probably no invention connected with firearms has wrought such changes in the principle of gun-construction as those effected by the expansive cartridge-case. This invention has completely revolutionized the art of gun-making, has been successfully applied to all descriptions of firearms, and has produced a new and important industry—that of cartridge manufacture.

About 1836, C. Lefaucheur, a Paris gunsmith, improved the old Pauly system of breech-loading, but its breech action was a crude mechanism, with single grip worked by a bottom lever. The double grip for the barrels was the subsequent invention of a Birmingham gunmaker. The central-fire cartridge, practically as now in use, was introduced into England in 1861 by Daw. It is said to have been the invention of Pottet, of Paris, improved upon by Schneider, and gave rise to considerable litigation in respect of its patent rights. Daw, who controlled the English patents, was the only exhibitor of central-fire guns and cartridges at the International Exhibition of 1862. In his system the barrels work on a hinge joint, the bottom lever withdraws the holding-down bolt; the cartridge is of the modern type, the cap being detonated by a striker passing through the standing breech to the inner face. The cartridge-case is withdrawn by a sliding extractor fitted to the breech ends of the barrels. Daw was subsequently defeated in his control of the patents by Eley Bros., owing to the patent not having been kept in force in France. The modern breech-loading gun has been gradually and steadily improved since 1860. Westley Richards adopted and improved Matthews' top-lever mechanism. About 1866 the rebounding lock was introduced, and improved in 1869. The treble wedge-fast mechanism for holding down the barrels was originated by W. W. Greener in 1865, and perfected in 1873. A very important improvement was the introduction of the hammerless gun, in which the mechanism for firing is placed entirely within the gun. This was made possible by the introduc-

tion of the central-fire cartridge. In 1862 Daw, and in 1866 Green, introduced hammerless guns in which the cocking was effected by the under lever. These guns did not attain popularity. In 1871 T. Murcott patented a hammerless gun, the first to obtain distinct success. This also was a lever-cocking gun. About the same time Needham introduced the principle of utilising the weight of the barrels to assist in cocking. In 1875 Anson and Dasey utilized the fore-end attached to the barrels to cock the locks. From this date hammerless guns became really popular. Subsequently minor improvements were made by many other gun-makers, including alternative movements introduced by Purdey and Rogers. Improvements were also introduced by Westley Richards, Purdey and others, including cocking by means of the mainspring. In 1874 J. Needham introduced the ejector mechanism, by which each empty cartridge-case is separately and automatically thrown out of the gun when the breech is opened, the necessary force being provided by the mainspring of the lock. W. W. Greener and some other gun-makers have since introduced minor modifications and improvements of this mechanism. Next in turn came Perks and other inventors, who separated the ejector mechanism from the lock work. This very decided improvement is universal to-day. A later innovation in the modern breech-loader is the single trigger mechanism introduced by some of the leading English gun-makers, by which both barrels can be fired in succession by a single trigger. This improvement enables both barrels to be rapidly fired without altering the grip of the right hand, but deprives the shooter of the power of selecting his barrel.

Repeating or magazine shot-guns on the principle of the repeating rifle, with a magazine below the single firing barrel, are also made by some American and continental gun-makers, but as yet have not come into general use, being comparatively cumbersome and not well balanced. The difficulty of a shifting balance as each cartridge is fired has also yet to be overcome. Several varieties of a combination rifle and shot-gun are also made, for a description of which see *RIFLE*.

The chief purposes for which modern shot-guns are required are game-shooting, trap-shooting at pigeons and wild-fowling. The game gun may be any bore from 32 to 20 gauge. The usual standard bore is 12 gauge unless it be for a boy, when it is 30 gauge. The usual weight of the 12-bore double-barrelled game gun is from 6 to 7 lb with barrels 30 in. long, there, however, being a present tendency to barrels of a shorter length. These barrels are made of steel, as being a stronger and more homogeneous material than the barrels formerly produced, which were mostly of Damascus pattern, a mixture of iron and steel. Steel barrels, drilled from the solid block, were originally produced by Whitworth. To-day the makers of steel for this purpose are many. The standard charge for the 12-bore is 42 grains of smokeless powder and 1 oz. to 1½ oz. of shot. Powder of a lighter gravimetric density is occasionally employed, when the weight of the charge is reduced to 33 grains. This charge of powder corresponds to the 3 drams of black powder formerly used. The ordinary game gun should have a killing circle of 30 in. at 30 yds. with the first barrel and at 40 yds. with the second. Improved materials and methods of manufacture, and what is known as "choke" boring of the barrels, have enabled modern gun-makers to regulate the shooting of guns to a nicety. Choke-boring is the constriction of the diameter of the barrel near the muzzle, and was known in America in the early part of the 19th century. In 1875 Pape of Newcastle was awarded a prize for the invention of choke-boring, there being no other claimant. The methods of choke-boring have since been varied and improved by the leading English gun-makers. The pigeon gun is usually heavier than the game gun and more choked. It generally weighs from 7 to 8 lb. Its weight, by club rules, is frequently restricted to 7½ lb and its bore to 12 gauge. The standard wild-fowling gun is a double 8-bore with 30-in. barrels weighing 15 lb. and firing a charge of 7 drams of powder and 2½ to 3 oz. of shot. These guns are also made in both smaller and larger varieties, including a single barrel 4-bore, which is the largest gun that can be used from the shoulder, and single

barrel punt guns of 1½-in. bore, weighing 300 lb. While no conspicuous advance in improved gun-mechanism and invention has been made during the last few years, the materials and methods of manufacture, and the quality and exactitude of the gun-maker's work, have continued gradually and steadily to improve. English, and particularly London-made, guns stand pre-eminent all over the world. (H. S.-K.)

GUNA, a town and military-station in Central India, in the state of Gwalior. Pop. (1901) 11,452. After the Mutiny, it became the headquarters of the Central India Horse, whose commanding officer acts *ex-officio* assistant to the resident of Gwalior; and its trade has developed rapidly since the opening of a station on a branch of the Great Indian Peninsula railway in 1899.

GUNCOTTON, an explosive substance produced by the action of strong nitric acid on cellulose at the ordinary temperature; chemically it is a nitrate of cellulose, or a mixture of nitrates, according to some authorities. The first step in the history of guncotton was made by T. J. Pelouze in 1838, who observed that when paper or cotton was immersed in cold concentrated nitric acid the materials, though not altered in physical appearance, became heavier, and after washing and drying were possessed of self-explosive properties. At the time these products were thought to be related to the nitrated starch obtained a little previously by Henri Braconnot and called *xyloidin*; they are only related in so far as they are nitrates. C. F. Schönbein of Basel published his discovery of guncotton in 1846 (*Phik. Mag.* [3], 31, p. 7), and this was shortly after followed by investigations by R. K. Böttger of Frankfurt and Otto and Knop, all of whom added to our knowledge of the subject, the last-named introducing the use of sulphuric acid along with nitric acid in the nitration process. The chemical composition and constitution of guncotton has been studied by a considerable number of chemists and many divergent views have been put forward on the subject. W. Crum was probably the first to recognize that some hydrogen atoms of the cellulose had been replaced by an oxide of nitrogen, and this view was supported more or less by other workers, especially Hadow, who appears to have distinctly recognized that at least three compounds were present, the most violently explosive of which constituted the main bulk of the product commonly obtained and known as guncotton. This particular product was insoluble in a mixture of ether and alcohol, and its composition could be expressed by the term tri-nitrocellulose. Other products were soluble in the ether-alcohol mixture; they were less highly nitrated, and constituted the so-called collodion guncotton.

The smallest empirical formula for cellulose (*q.v.*) may certainly be written $C_6H_{10}O_5$. How much of the hydrogen and oxygen are in the hydroxylic (OH) form cannot be absolutely stated, but from the study of the acetates at least three hydroxyl groups may be assumed. The oldest and perhaps most reasonable idea represents guncotton as cellulose trinitrate, but this has been much disputed, and various formulae, some based on cellulose as $C_6H_8O_5$, others on a still more complex molecule, have been proposed. The constitution of guncotton is a difficult matter to investigate, primarily on account of the very insoluble nature of cellulose itself, and also from the fact that comparatively slight variations in the concentration and temperature of the acids used produce considerable differences in the products. The nitrates are also very insoluble substances, all the so-called solvents merely converting them into jelly. No method has yet been devised by which the molecular weight can be ascertained. The products of the action of nitric acid on cellulose are not nitro compounds in the sense that picric acid is, but are nitrates or nitric esters.

Guncotton is made by immersing cleaned and dried cotton waste in a mixture of strong nitric and sulphuric acids. The

relative amounts of the acids in the mixture and the time of duration of treatment of the cotton varies somewhat in different works, but the underlying idea is the same, *viz.* employing such an excess of sulphuric over nitric that the latter will be rendered anhydrous or concentrated and maintained as such in solution in the sulphuric acid, and that the sulphuric acid shall still be sufficiently strong to absorb and combine with the water produced during the actual formation of the guncotton. In the recent methods the cotton remains in contact with the acids for two to four hours at the ordinary air temperature (15° C.), in which time it is almost fully nitrated, the main portion, say 90%, having a composition represented by the formula¹ $C_6H_7O_5(NO_3)_3$, the remainder consisting of lower nitrated products, some oxidation products and traces of unchanged cellulose and cellulose sulphates. The acid is then slowly run out by an opening in the bottom of the pan in which the operation is conducted, and water distributed carefully over its surface displaces it in the interstices of the cotton, which is finally subjected to a course of boiling and washing with water. This washing is a most important part of the process. On its thoroughness depends the removal of small quantities of products other than the nitrates, for instance, some sulphates and products from impurities contained in the original cellulose. Cellulose sulphates are one, and possibly the main, cause of instability in guncotton, and it is highly desirable that they should be completely hydrolysed and removed in the washing process. The nitrated product retains the outward form of the original cellulose. In the course of the washing, according to a method introduced by Sir F. Abel, the cotton is ground into a pulp, a process which greatly facilitates the complete removal of acids, &c. This pulp is finally drained, and is then either compressed, while still moist, into slabs or blocks when required for blasting purposes, or it is dried when required for the manufacture of propellants. Sometimes a small quantity of an alkali (*e.g.* sodium carbonate) is added to the final washing water, so that quantities of this alkaline substance ranging from 0.5% to a little over 1% are retained by the guncotton. The idea is that any traces of acid not washed away by the washing process or produced later by a slow decomposition of the substance will be thereby neutralized and rendered harmless. Guncotton in an air-dry state, whether in the original form or after grinding to pulp and compressing, burns with very great rapidity but does not detonate unless confined.

Immediately after the discovery of guncotton Schönbein proposed its employment as a substitute for gunpowder, and General von Lenk carried out a lengthy and laborious series of experiments intending to adapt it especially for artillery use. All these and many subsequent attempts to utilize it, either loose or mechanically compressed in any way, signally failed. However much compressed by mechanical means it is still a porous mass, and when it is confined as in a gun the flame and hot gases from the portion first ignited permeate the remainder, generally causing it actually to detonate, or to burn so rapidly that its action approaches detonation. The more closely it is confined the greater is the pressure set up by a small part of the charge burning, and the more completely will the explosion of the remainder assume the detonating form. The employment of guncotton as a propellant was possible only after the discovery that it could be gelatinized or made into a colloid by the action of so-called solvents, *e.g.* ethylacetate and other esters, acetone and a number of like substances (see *CORDITE*).

When quite dry guncotton is easily detonated by a blow on an anvil or hard surface. If dry and warm it is much more sensitive to percussion or friction, and also becomes electrified by friction under those conditions. The amount of contained moisture exerts a considerable effect on its sensitiveness. With about 2% of moisture it can still be detonated on an anvil, but the action is generally confined to the piece struck. As the quantity of contained water increases it becomes difficult or even impossible to detonate by an ordinary blow. Compressed dry guncotton is easily detonated by an initiative detonator such as mercuric fulminate. Guncotton containing more than 15% of water is unflammable, may be compressed or worked without danger and is much more difficult to detonate by a fulminate

¹ The composition of the cellulose nitrates was reviewed by G. Lunge (*Jour. Amer. Chem. Soc.*, 1901, 23, p. 527), who, assuming the formula $C_6H_8O_5$ for cellulose, showed how the nitrocelluloses described by different chemists may be expressed by the formula $C_6H_7-2xO_5(NO_3)_x$, where *x* has the values 4, 5, 6, . . . 12.

² This formula is retained mainly on account of its simplicity. It also expresses all that is necessary in this connexion.

detonator than when dry.¹ A small charge of dry gun cotton will, however, detonate the wet material, and this peculiarity is made use of in the employment of gun cotton for blasting purposes. A charge of compressed wet gun cotton may be exploded, even under water, by the detonation of a small primer of the dry and waterproofed material, which in turn can be started by a small fulminate detonator. The explosive wave from the dry gun cotton primer is in fact better responded to by the wet compressed material than the dry, and its detonation is somewhat sharper than that of the dry. It is not necessary for the blocks of wet gun cotton to be actually in contact if they be under water, and the peculiar explosive wave can also be conveyed a little distance by a piece of metal such as a railway rail. The more nearly the composition of gun cotton approaches that represented by $C_6H_7O_2(NO_2)_3$, the more stable is it as regards storing at ordinary temperatures, and the higher the igniting temperature. Carefully prepared gun cotton after washing with alcohol-ether need nothing more dissolves may require to be heated to 180-185° C. before igniting. Ordinary commercial gun cottons, containing from 10 to 15% of lower nitrated products, will ignite as a rule some 20-25° lower.

Assuming the above formula to represent gun cotton, there is sufficient oxygen for internal combustion without any carbon being left. The gaseous mixture obtained by burning gun cotton in a vacuum vessel contains steam, carbon monoxide, carbon dioxide, nitrogen, nitric oxide, and methane. When slowly heated in a vacuum vessel until ignition takes place, some nitrogen dioxide, NO_2 , is also produced. When kept for some weeks at a temperature of 100° in steam, a considerable number of fatty acids, some bases, and glucose-like substances result. Under different pressures the relative amounts of the combustion products vary considerably. Under very great pressures carbon monoxide, steam and nitrogen are the main products, but nitric oxide never quite disappears.

Dilute mineral acids have little or no action on gun cotton. Strong sulphuric acid in contact with it liberates first nitric acid and later oxides of nitrogen, leaving a charred residue or a brown solution according to the quantity of acid. It sometimes fuses on contact with strong sulphuric acid, especially when slightly warmed. The alkali hydroxides (e.g. sodium hydroxide) will in a solid state fire it on contact. Strong or weak solutions of these substances also decompose it, producing some alkali nitrate and nitrite, the cellulose molecule being only partially restored, some quantity undergoing oxidation. Ammonia is also active, but not quite in the same manner as the alkali hydroxides. Dry gun cotton heated in ammonia gas detonates at about 70°, and ammonium hydroxide solutions of all strengths slowly decompose it, yielding somewhat complex products. Alkali sulphohydrates reduce gun cotton, or other nitrated celluloses, completely to cellulose. The production of the so-called "artificial silk" depends on this action.

A characteristic difference between gun cotton and collodion cotton is the insolubility of the former in ether or alcohol or a mixture of these liquids. The so-called collodion cottons are nitrated celluloses, but of a lower degree of nitration (as a rule) than gun cotton. They are sometimes spoken of as "lower" or "soluble" cottons or nitrates. The solubility in ether-alcohol may be owing to a lower degree of nitration, or to the temperature conditions under which the process of manufacture has been carried on. If gun cotton be correctly represented by the formula $C_6H_7O_2(NO_2)_3$, it should contain a little more than 14% of nitrogen. Gun cottons are examined for degree of nitration by the nitrometer, in which apparatus they are decomposed by sulphuric acid in contact with mercury, and all the nitrogen is evolved as nitric oxide, NO , which is measured and the weight of its contained nitrogen calculated. Ordinary gun cottons seldom contain more than 13% of nitrogen, and in most cases the amount does not exceed 12.5%. Generally speaking, the lower the nitrogen content of a gun cotton, as found by the nitrometer, the higher the percentage of matters soluble in a mixture of ether-alcohol. These soluble matters are usually considered as "lower" nitrates.

Gun cottons are usually tested by the Abel heat test for stability (see CORDITE). Another heat test, that of Will, consists in heating a weighed quantity of the gun cotton in a stream of carbon dioxide to 130° C., passing the evolved gas over some red-hot copper, and finally collecting them over a solution of potassium hydroxide which retains the carbon dioxide and allows the nitrogen, arising from the gun cotton decomposition, to be measured. This is done at definite time intervals so that the rate of decomposition can be followed. The relative stability is then judged by the amount of nitrogen gas collected in a certain time. Several modifications of this and of the Abel heat test are also in use. (See EXPLOSIVES.) (W. R. E. H.)

GUNDULICH, IVAN (1588-1638), known also as Giovanni Gondola, Servian poet, was born at Ragusa on the 8th of January 1588. His father, Franco Gundulich, once the Ragusan envoy to Constantinople and councillor of the republic, gave him an excellent education. He studied the "humanities" with the Jesuit, Father Musai, and philosophy with Father Ricasoli. After that he studied Roman law and jurisprudence in general. He was member of the Lower Council and once served as the

¹ Air-dried gun cotton will contain 2% or less of moisture.

chief magistrate of the republic. He died on the 8th of December 1638. A born poet, he admired much the Italian poets of his time, from whom he made many translations into Servian. It is believed that he so translated Tasso's *Gerusalemme liberata*. He is known to have written eighteen works, of which eleven were dramas, but of these only three have been fully preserved, others having perished during the great earthquake and fire in 1667. Most of those dramas were translations from the Italian, and were played, seemingly with great success, by the amateurs furnished by the noble families of Ragusa. But his greatest and justly celebrated work is an epic, entitled *Orman*, in twenty cantos. It is the first political epic on the Eastern Question, glorifying the victory of the Poles over Turks and Tatars in the campaign of 1621, and encouraging a league of the Christian nations, under the guidance of Vladislaus, the king of Poland, for the purpose of driving away the Turks from Europe. The fourteenth and fifteenth cantos are lost. It is generally believed that the Ragusan government suppressed them from consideration for the Sultan, the protector of the republic, those two cantos having been violently anti-Turkish.

Orman was printed for the first time in Ragusa in 1826, the two missing cantos being replaced by songs written by Pietro Sorgo (or Sorlocojevich). From this edition the learned Italian, Francesco Appendini, made an Italian translation published in 1827. Since that time several other editions have been made. The best are considered to be the edition of the South Slavonic Academy in Agram (1877) and the edition published in Semdin (1889) by Professor Yovan Boshkovich. In the edition of 1844 (Agram) the last cantos, fourteen and fifteen, were replaced by very fine compositions of the Serbo-Croatian poet, Mazuranich (Mažuranić). The complete works of Gundulich have been published in Agram, 1847, by V. Babukich and by the South Slavonic Academy of Agram in 1899. (C. M.)

GUNG'L, JOSEF (1810-1889), Hungarian composer and conductor, was born on the 1st of December 1810, at Zsámbék, in Hungary. After starting life as a school-teacher, and learning the elements of music from Ofen, the school-choirmaster, he became first oboist at Graz, and, at twenty-five, bandmaster of the 4th regiment of Austrian artillery. His first composition, a Hungarian march, written in 1836, attracted some notice, and in 1843 he was able to establish an orchestra in Berlin. With this band he travelled far, even (in 1849) to America. It is worth recording that Mendelssohn's complete *Middlemarch Night's Dream* music is said to have been first played by Gung'l's band. In 1853 he became bandmaster to the 23rd Infantry Regiment at Brunn, but in 1864 he lived at Munich, and in 1876 at Frankfurt, after (in 1873) having conducted with great success a series of promenade concerts at Covent Garden, London. From Frankfurt Gung'l went to Weimar to live with his daughter, a well-known German opera singer and local prima donna. There he died, on the 31st of January 1889. Gung'l's dances number over 300, perhaps the most popular being the "Ameretten," "Hydropaten," "Casino," "Dreams on the Ocean" waltzes; "In Sailer Mitternacht" polka, and "Blue Violets" mazurka. His Hungarian march was transcribed by Liszt. His music is characterized by the same easy flowing melodies and well-marked rhythm that distinguish the dances of Strauss, to whom alone he can be ranked second in this kind of composition.

GUNNER, or MASTER GUNNER, in the navy, the warrant officer who has charge of the ordnance and ammunition, and of the training of the men at gun drill. His functions in this respect are of less relative importance than they were in former times, when specially trained corps of seamen gunners had not been formed.

GUNNING, PETER (1614-1684), English divine, was born at Hoo, in Kent, and educated at the King's School, Canterbury, and Clare College, Cambridge, where he became a fellow in 1633. Having taken orders, he advocated the royalist cause from the pulpit with much eloquence. In 1644 he retired to Oxford, and held a chaplaincy at New College until the city surrendered to the parliamentary forces in 1646. Subsequently he was chaplain, first to the royalist Sir Robert Shirley of Extington (1629-1656), and then at the Exeter House chapel. After the

Restoration in 1660 he returned to Clare College as master, and was appointed Lady Margaret professor of divinity. He also received the livings of Cottesmore, Rutlandshire, and Stoke Bruarne, Northamptonshire. In 1661 he became head of St John's College, Cambridge, and was elected Regius professor of divinity. He was consecrated bishop of Chichester in 1669, and was translated to the see of Ely in 1674-1675. Holding moderate religious views, he deprecated alike the extremes represented by Puritanism and Roman Catholicism.

His works are chiefly reports of his disputations, such as that which appears in the *Science Universelle* (Paris, 1658), in which the definition of a schism is discussed with two Romanist opponents.

GUNNY, a sort of cloth, the name of which is supposed to be derived from *ganga* or *ganja* of Rumphius, or from *gonia*, a vernacular name of the *Crotolaria juncea*—a plant common in Madras. One of the first notices of the term itself is to be found in Knox's *Ceylon*, in which he says: "The filaments at the bottom of the stem (coir from the coco-nut husk, *Cocos nucifera*) may be made into a coarse cloth called gunny, which is used for bags and similar purposes."

Warden, in *The Linen Trade*, says:

"A very large proportion of the jute grown in Bengal is made into cloth in the districts where it is cultivated, and this industry forms the grand domestic manufacture of all the populous eastern districts of Bengal. It pervades all classes, and penetrates into every household, almost every one, man, woman and child, being in some way engaged in it. Boatmen, husbandmen, palankeen carriers, domestic servants, every one, in fact, being Hindu—for Mussulmans spin cotton only—pass their leisure moments, distaff in hand, spinning gunny twist. It is spun by the *takur* and *dharu*, the former being a kind of spindle, which is turned upon the thigh or the side of the foot, and the latter a reel, on which the thread, when sufficiently twisted, is wound up. Another kind of spinning machine, called a *ghurburna*, is occasionally used. A bunch of the raw material is hung up in every farmer's house, or on the protruding stick of a thatched roof, and every one who has leisure ferms with these spindles some coarse pack-thread, of which ropes are twisted for the use of the loom. The lower Hindu castes, from this pack-thread, spin a finer thread for being made into cloth, and there being a loom in nearly every house, very much of it is woven by the women of the lower class of people. It is especially the employment of the Hindu widow, as it enables her to earn her bread without being a burden on her family. The cloth thus made is of various qualities, such as clothing for the family (especially the women, a great proportion of whom on all the eastern frontier wear almost nothing else), coarse fabrics, bedding, rice and sugar bags, sackings, pack-sheet, &c. Much of it is woven into short lengths and very narrow widths, two or three of which are sometimes sewed into one piece before they are sold. That intended for rice and sugar bags is made about 4 feet long, and from 24 to 27 inches wide, and doubled. A considerable quantity of jute yarn is dyed and woven into cloth for various local purposes, and some of it is also sent out of the district. The principal places where chutes, or jute cloth for gunny bags is made are within a radius of perhaps 150 to 200 miles around Dacca, and there both labour and land are remarkably cheap. The short staple, common jute is generally consumed in the local manufacture, the finer and long staple being reserved for the export trade. These causes create gunny cloth and bags to be sold almost as cheaply as the raw material, which creates an immense demand for them in nearly every market of the world."

Such appeared to be the definition of gunny cloth at the time the above was written—between 1850 and 1860. Most of the Indian cloth for gunny bags is now made by power, and within about 20 m. of Calcutta. In many respects the term gunny cloth is still applied to all and sundry, but there is no doubt that the original name was intended for cloth which was similar to what is now known as "cotton bagging." This particular type of cloth is still largely made in the hand loom, even in Dundee, this method of manufacture being considered, for certain reasons, more satisfactory than the power loom method (see **JUTE** and **BAGGING**).

GUNPOWDER, an explosive composed of saltpetre, charcoal and sulphur. Very few substances have had a greater effect on civilization than gunpowder. Its employment altered the whole art of war, and its influence gradually and indirectly permeated and affected the whole fabric of society. Its direct effect on the arts of peace was but slight, and had but a limited range, which could not be compared to the modern extended employment of high explosives for blasting in mining and engineering work.

It is probably quite incorrect to speak of the *discovery* of gunpowder. From modern researches it seems more likely and more just to think of it as a thing that has developed, passing through many stages—mainly of improvement, but some undoubtedly retrograde. There really is not sufficient solid evidence on which to pin down its invention to one man. As Lieutenant-Colonel H. W. L. Hime (*Gunpowder and Ammunition*, 1904) says, the invention of gunpowder was impossible until the properties of nearly pure saltpetre had become known. The honour, however, has been associated with two names in particular, Berthold Schwartz, a German monk, and Friar Roger Bacon. Of the former Oscar Guttman writes (*Monumenta pulveris pyrii*, 1904, p. 6): "Berthold Schwartz was generally considered to be the inventor of gunpowder, and only in England has Roger Bacon's claim been upheld, though there are English writers who have pleaded in favour of Schwartz. Most writers are agreed that Schwartz invented the first fire-arms, and as nothing was known of an inventor of gunpowder, it was perhaps considered justifiable to give Schwartz the credit thereof. There is some ambiguity as to when Schwartz lived. The year 1354 is sometimes mentioned as the date of his invention of powder, and this is also to be inferred from an inscription on the monument to him in Freiburg. But considering there can be no doubt as to the manufacture in England of gunpowder and cannon in 1344, that we have authentic information of guns in France in 1338 and in Florence in 1326, and that the Oxford MS. *De officio regum* of 1325 gives an illustration of a gun, Berthold Schwartz must have lived long before 1354 to have been the inventor of gunpowder or guns." In Germany also there were powder-works at Augsburg in 1340, in Spandau in 1344, and Liegnitz in 1345.

Roger Bacon, in his *De mirabilis potestate artis et nature* (1242), makes the most important communication on the history of gunpowder. Reference is made to an explosive mixture as known before his time and employed for "diversion, producing a noise like thunder and flashes like lightning." In one passage Bacon speaks of saltpetre as a violent explosive, but there is no doubt that he knew it was not a self-explosive substance, but only so when mixed with other substances, as appears from the statement in *De secretis operibus artis et nature*, printed at Hamburg in 1618, that "from saltpetre and other ingredients we are able to make a fire that shall burn at any distance we please." A great part of his three chapters, 9, 10, 11, long appeared without meaning until the anagrammatic nature of the sentences was realized. The words of this anagram are (chap. 22): "Item ponderis totum 30 sed tamen salis petrae (ursi) 10 sulphuris; et sic facies tonitruum et coruscationem, et scias artificium. Videas tamen utrum loqueri senigmaticum aut secundum veritatem." Hime, in his chapter on the origin of gunpowder, discusses these chapters at length, and gives, omitting the anagram, the translation: "Let the total weight of the ingredients be 30, however, of saltpetre . . . of sulphur; and with such a mixture you will produce a bright flash and a blundering noise, if you know the trick. You may find (by actual experiment) whether I am writing riddles to you or the plain truth." The anagram reads, according to Hime, "salis petrae (recipe) vii part(es), v nov(ellae) corul(i), v et sulphuris" (take seven parts of saltpetre, five of young hazel-wood, and five of sulphur). Hime then goes on to show that Bacon was in possession of an explosive which was a considerable advance on mere incendiary compositions. Bacon does not appear to have been aware of the projecting power of gunpowder. He knew that it exploded and that perhaps people might be blown up or frightened by it; more cannot be said. The behaviour of small quantities of any explosive is hardly ever indicative of its behaviour in large quantities and especially when, under confinement. Hime is of opinion that Bacon blundered upon gunpowder whilst playing with some incendiary composition, such as those mentioned by Marcus Graecus and others, in which

These words were emended by some authors to read *lunus mops can ubi*, the letters of which can be arranged to give *pulvis can-bonum*.

he employed his comparatively pure saltpetre instead of crude nitrum. It has been suggested that Bacon derived his knowledge of these fiery mixtures from the MS. *Liber ignium*, ascribed to Marcus Græcus, in the National Library in Paris (Dutens, *Enquiry into Origin of Discoveries attributed to Moderns*). Certainly this Marcus Græcus appears to have known of some incendiary composition containing the gunpowder ingredients, but it was not gunpowder. Hime seems to doubt the existence of any such person as Marcus Græcus, as he says: "The *Liber ignium* was written from first to last in the period of literary forgeries and pseudographs . . . and we may reasonably conclude that Marcus Græcus is as unreal as the Imaginary Greek original of the tract which bears his name." Albertus Magnus in the *De mirabilibus mundi* repeats some of the receipts given in Marcus Græcus, and several other writers give receipts for Greek fire, rockets, &c. Dutens gives many passages in his work, above-named, from old authors in support of his view that a composition of the nature of gunpowder was not unknown to the ancients. Hime's elaborate arguments go to show that these compositions could only have been of the incendiary type and not real explosives. His arguments seem to hold good as regards not only the Greeks but also the Arabs, Hindus and Chinese (see also FRANKOWSKA).

There seems no doubt that incendiary compositions, some perhaps containing nitre, mostly, however, simply combustible substances as sulphur, naphtha, resins, &c., were employed and projected both for defence and offence, but they were projected or blown by engines and not by themselves. It is quite inconceivable that a real propelling explosive should have been known in the time of Alexander or much later, and not have immediately taken its proper place. In a chapter discussing this question of explosives amongst the Hindus, Hime says: "It is needless to enlarge the list of quotations: incendiaries pursued much the same course in Upper India: as in Greece and Arabia." No trustworthy evidence of an explosive in India is to be found until the 21st of April 1526, the date of the decisive battle of Panipat, in which Ibrahim, sultan of Delhi, was killed and his army routed by Baber the Mogul, who possessed both great and small fire-arms.

As regards also the crusader period (1097-1291), so strange and deadly an agent of destruction as gunpowder could not possibly have been employed in the field without the full knowledge of both parties, yet no historian, Christian or Moslem, alludes to an explosive of any kind, while all of them carefully record the use of incendiaries. The employment of rockets and "wildfire" incendiary composition seems undoubtedly of very old date in India, but the names given to pieces of artillery under the Mogul conqueror of Hindustan point to a European, or at least to a Turkish origin, and it is quite certain that Europeans were retained in the service of Akbar and Aurangzeb. The composition of present day Chinese gunpowder is almost identical with that employed in Europe, so that in all probability the knowledge of it was obtained from Western sources.

In the writings of Bacon there is no mention of guns or the use of powder as a propellant, but merely as an explosive and destructive power. Owing perhaps to this obscurity hanging over the early history of gunpowder, its employment as a propelling agent has been ascribed to the Moors or Saracens. J. A. Conde (*Historia de la dominacion de los Arabes en España*) states that Ismail Ben Firaz, king of Granada, who in 1395 besieged Boza, had among his machines "some that cast globes of fire," but there is not the least evidence that these were guns. The first trustworthy document relative to the use of gunpowder in Europe, a document still in existence, and bearing date February 21, 1326, gives authority to the council of twelve of Florence and others to appoint persons to superintend the manufacture of cannons of brass and iron balls, for the defence of the territory, &c., of the republic. John Barbour, archdeacon of Aberdeen, writing in 1375, states that cannons (crakys of war) were employed in Edward III.'s invasion of Scotland in 1297. An indenture first published by Sir N. H. Nicolas in his *History of the Royal Navy* (London, 1846), and again by

Lieutenant-Colonel H. Blackenbury (*Proc. R.A. Inst.*, 1863), stated to be 1338, contains references to small cannon as among the stores of the Tower, and also mentions "un petit barrel de gonpoudre le quart' plein." If authentic, this is possibly the first mention of gunpowder as such in England, but some doubts have been thrown upon the date of this MS. From a contemporary document in the National Library in Paris it seems that in the same year (1338) there existed in the marine arsenal at Rouen an iron weapon called *pot de feu*, for propelling bolts, together with some saltpetre and sulphur to make powder for the same. Preserved in the Record Office in London are trustworthy accounts from the year 1345 of the purchase of ingredients for making powder, and of the shipping of cannon to France. In 1346 Edward III. appears to have ordered all available saltpetre and sulphur to be bought up for him. In the first year of Richard II. (1377) Thomas Norbury was ordered to buy, amongst other munitions, sulphur, saltpetre and charcoal, to be sent to the castle of Brest. In 1414 Henry V. ordered that no gunpowder should be taken out of the kingdom without special licence, and in the same year ordered twenty pipes of willow charcoal and other articles for the use of the guns.

The manufacture of gunpowder seems to have been carried on as a crown monopoly about the time of Elizabeth, and regulations respecting gunpowder and nitre were made about 1623 (James I.). Powder-mills were probably in existence at Waltham Abbey about the middle or towards the end of the 16th century.

Ingredients and their Action.—Roger Bacon in his anagram gives the first real recipe for gunpowder, viz. (according to Hime, ch. xi.) saltpetre 41·2, charcoal 29·4, sulphur 29·4. Dr John Arderne of Newark, who began to practise about 1350 and was later surgeon to Henry IV., gives a recipe (Sloane MSS. 335. 793), saltpetre 66·6, charcoal 22·2, sulphur 11·1, "which are to be thoroughly mixed on a marble and then sifted through a cloth." This powder is essentially of the same composition as one given in a MS. of Marcus Græcus, but the saltpetre of this formula by Marcus Græcus was undoubtedly answerable for the difference in behaviour of the two compositions. Roger Bacon had not only refined and obtained pure nitre, but had appreciated the importance of thoroughly mixing the components of the powder. Most if not all the early powder was a "loose" mixture of the three ingredients, and the most important step in connexion with the development of gunpowder was undoubtedly the introduction of wet mixing or "incorporating." Whenever this was done, the improvement in the product must have been immediately evident. In the damp or wetted state pressure could be applied with comparative safety during the mixing. The loose powder mixture came to be called "serpentine," after wet mixing it was more or less granulated or cornead and was known as "cornead powder." Cornead powder seems to have been gradually introduced. It is mentioned in the *Fire Book* of Conrad von Schönbögen (in 1429), and was used for hand-guns in England long before 1500. It would seem that cornead powder was used for hand-guns or small arms in the 15th century, but cannot were not made strong enough to withstand its explosion for quite another century (Hime). According to the same writer, in the period 1250-1450, when serpentine only was used, one powder could differ from another in the proportions of the ingredients; in the modern period—say 1700-1886—the powders in use (in each state) differed only as a general rule in the size of the grain, whilst during the transition period—1450-1700—they generally differed both in composition and size of grain.

Cornead or grained powder was adopted in France in 1525, and in 1540 the French utilized an observation that large-grained powder was the best for cannon, and restricted the manufacture to three sizes of grain or corn, possibly of the same composition. Early in the 18th century two or three sizes of grain and powder of one composition appear to have become common. The composition of English powder seems to have settled down to 75 nitre, 15 charcoal, and 10 sulphur, somewhere about the middle of the 18th century.

The composition of gunpowders used in different countries at different times is illustrated in the following tables:—

English Powders (Hime).

	1250.	1350.	1500.	1647.	1670.	1742.	1781.
Saltpetre .	41·2	66·6	50·0	66·6	71·4	75·0	75·0
Charcoal .	29·4	22·2	33·3	33·3	14·3	12·5	15·0
Sulphur .	29·4	11·1	16·6	16·6	14·3	12·5	10·0 ¹

¹ This represents the composition of English powder at present, and no doubt it has remained the same for a longer time than the above date indicates.

GUNPOWDER.

725

Foreign Powders (Hime).

	France.	Sweden.	Germany.	Denmark.	France.	Sweden.	Germany.
	1338.	1560.	1595.	1608.	1650.	1697.	1882.
Saltpetre	50	66-6	52-2	68-3	75-6	73	78
Charcoal	7	16-6	26-1	23-2	13-6	17	19
Sulphur	25	16-6	21-7	8-5	10-8	10	31

† Brown or coco-powder for large charges in guns. The charcoal is not burnt black but roasted until brown, and is made from some variety of straw, not wood.

When reasonably pure, none of the ingredients of gunpowder absorbs any material quantity of moisture from the atmosphere, and the nitre only is a soluble substance. It seems extremely probable that for a long period the three substances were simply mixed dry, indeed sometimes kept separate and mixed just before being required; the consequence must have been that, with every care as to weighing out, the proportions of any given quantity would alter on carriage. Saltpetre is considerably heavier than sulphur or charcoal, and would tend to separate out towards the bottom of the containing vessel if subjected to jolting or vibration. When pure there can only be one kind of saltpetre or sulphur, because they are chemical individuals, but charcoal is not. Its composition, rate of burning, &c., depend not only on the nature of the woody material from which it is made, but quite as much on the temperature and time of heating employed in the making. The woods from which it is made contain carbon, hydrogen and oxygen, and the two latter are never thoroughly expelled in charcoal-making. If they were, the resulting substance would be of no use for gunpowder. 1-3% of hydrogen and 8-15% of oxygen generally remain in charcoals suitable for gunpowder. A good deal of the ferriosity and violence of explosion of a gunpowder depends on the mode of burning of the charcoal as well as on the wood from which it is made.

Properties of Ingredients.—Charcoal is the chief combustible in powder. It must burn freely, leaving as little ash or residue as possible; it must be friable, and grind into a non-gritty powder. The sources from which powder charcoal is made are dogwood (*Rhusassa frangula*), willow (*Salix alba*), and alder (*Betula alnus*). Dogwood is mainly used for small-arm powders. Powders made from dogwood charcoal burn more rapidly than those from willow, &c. The wood after cutting is stripped of bark and allowed to season for two or three years. It is then picked to uniform size and charred in cylindrical iron cases or slips, which can be introduced into slightly larger cylinders set in a furnace. The slips are provided with openings for the escape of gases. The rate of heating as well as the absolute temperature attained have an effect on the product, a slow rate of heating yielding more charcoal, and a high temperature reducing the hydrogen and oxygen in the final product. When heated for seven hours to about 800° C. to 900° C. the remaining hydrogen and oxygen amount to about 2% and 12% respectively. The time of charring is as a rule from 5 to 7 hours. The slips are then removed from the furnace and placed in a larger iron vessel, where they are kept comparatively air-tight until quite cold. The charcoal is then sorted, and stored for some time before grinding. The charcoal is ground, and the powder sifted on a rotating reel or cylinder of fine mesh copper-wire gauze. The sifted powder is again stored for some time before use in closed iron vessels.

Sicilian sulphur is most generally employed for gunpowder, and for complete purification is first distilled and then melted and cast into moulds. It is afterwards ground into a fine powder and sifted as in the case of the charcoal.

Potassium nitrate is eminently suitable as an oxygen-provider, not being deliquescent. Nitrates are continually being produced in surface soils, &c., by the oxidation of nitrogenous substances. Nitric and nitrous acids are also produced by electric discharges through the atmosphere, and these are found eventually as nitrates in soils, &c. Nitre is soluble in water, and much more so in hot than in cold. Crude nitre, obtained from soils or other sources, is purified by recrystallisation. The crude material is dissolved almost to saturation in boiling water: on filtering and then cooling this liquor to about 30° C. almost pure nitre crystallises out, most of the usual impurities still remaining in solution. By rapidly cooling and agitating the nitre solution crystals are obtained of sufficient fineness for the manufacture of powder without special grinding. Nitre contains nearly 48% of oxygen by weight, five-sixths of which is available for combustion purposes. Nearly all the gases of the powder explosion are derived from the nitre. The specific gravity of nitre is 2.2: 200 grams will therefore occupy about 100 cubic centimetres volume. This quantity on its decomposition by heat alone yields 28 grams or 22.400 c.c. of nitrogen, and 80 grams or 56.000 c.c. of oxygen as gases, and 94 grams of potassium oxide, a fusible solid which vaporizes at a very high temperature.

Incorporation.—The materials are weighed out separately, mixed by passing through a sieve, and then uniformly moistened with a certain quantity of water, whilst on the bed of the incorporating mill. This consists of two heavy iron wheels mounted so as to run in a circular bed. The incorporation requires about four hours.

The mechanical action of rollers on the powder paste is a double one: not only crushing but mixing by pushing forwards and twisting sideways. The pasty mass is deflected so that it repeatedly comes under first one roller and then the next by scrapers, set at an angle to the bed, which follow each wheel.

Although the charge is wet it is possible for it to be fired either by the heat developed by the roller friction, by sparks from foreign matters, as bits of stone, &c., or possibly by heat generated by oxidation of the materials. The mills are provided with a drenching apparatus so arranged that in case of one mill firing it and its neighbours will be drowned by water from a cistern or tank immediately above the mill. The product from the incorporation is termed "mill-cake."

After this incorporation in the damp state the ingredients never completely separate on drying, however much shaken, because each particle of nitre is surrounded by a thin layer of water containing nitre in solution, in which the particles of charcoal and sulphur are entangled and retained. After the incorporation, powders are pressed to a certain extent whilst still moist. The density to which a powder is pressed is an important matter in regard to the rate of burning. The effect of high density is to slow down the initial rate of burning. Less dense powders burn more rapidly from the first and tend to put a great strain on the gun. Fouling is usually less with denser powders; and, as would be expected, such powders bear transport better and give less dust than light powders. Up to a certain pressure, hardness, density, and size of grain of a powder have an effect on the rate of burning and therefore on pressure. Glazing or polishing powder grains, also exerts a slight retarding action on burning and enables the powders to resist atmospheric moisture better. Excess of moisture in gunpowder has a marked effect in reducing the explosiveness. All powders are liable to absorb moisture, the quality and kind of charcoal being the main determinant in this respect; hard burnt black charcoal is least absorbent. The material employed in brown powders absorbs moisture somewhat readily. Powder kept in a very damp atmosphere, and especially in a changeable one, spoils rapidly, the salt-nitre coming to the surface in solution and then crystallising out. The excess also break up owing to the formation of large crystals of nitre in the mass. After the pressing of the incorporated powder into a "press-cake," it is broken up or granulated by suitable machines, and the resulting grains separated and sorted by sifting through sieves of determined sizes of mesh. Some dust is formed in this operation, which is sifted away and again worked up under the rollers (for sizes of grains see fig. 1). These grains, cubes, &c., are then either polished by rotating in drums alone or with graphite, which adheres to and coats the surfaces of the grains. This process is generally followed with powders intended for small-arms or moderately small ordnance.

Shaped Powders.—Prisms or prismatic powder are made by breaking up the press-cake into a moderately fine state, whilst still moist, and pressing a certain quantity in a mould. The moulds generally employed consist of a thick plate of bronze in which are a number of hexagonal perforations. Accurately fitting plungers are so applied to these that one can enter at the top and the other at the bottom. The lower plunger being withdrawn to the bottom of the plate the hexagonal hole is charged with the powder and the two plungers set in motion, thus compressing the powder between them. After the desired pressure has been applied the top plunger is withdrawn, and the lower one pushed upward to eject the prism of powder. The axial perforations in prism powders are made by small bronze rods which pass through the lower plunger and fit into corresponding holes in the upper one. If these prisms are made by a steadily applied pressure a density throughout of about 1.78 may be obtained. Further to regulate the rate of burning so that it shall be slow at first and more rapid as the powder is consumed, another form of machine was devised, the cam press, in which the pressure is applied very rapidly to the powder. It receives in fact one blow, which compresses the powder to the same dimensions, but the density of the outer layers of substance of the prism is much greater than in the interior.

The leading idea in connexion with all shaped powder grains, and with the very large sizes, was to regulate the rate of burning so as to avoid extreme pressure when first ignited and to keep up the pressure in the gun as more space was provided in the chamber or tube by the movement of the shot towards the muzzle. In the perforated prismatic powder the ignition is intended to proceed through the perforations; since in a charge the faces of the prisms fit pretty closely together, it was thought that this arrangement would prevent unburnt cores or pieces of powder from being blown out. These larger grain powders necessitated a lengthened bore to take advantage of the slower production of gases and complete combustion of the powder. General T. J. Rodman first suggested and employed the perforated cake cartridge in 1860, the cake having nearly the diameter of the bore and a thickness of 1 to 2 in.

with perforations running parallel with the gun axis. The burning would then start from the comparatively small surfaces of the perforations, which would become larger as the powder burnt away. Experiments bore out this theory perfectly. It was found that small prisms were more convenient to make than large disks, and as the prisms practically fit together into a disk the same result was obtained. This effect of mechanical density on rate of burning is good only up to a certain pressure, above which the gases are driven through the densest form of granular material. After granulating or pressing into shapes, all powders must be dried. This is done by heating in specially ventilated rooms heated by steam pipes. As a rule this drying is followed by the finishing or polishing process. Powders are finally blended, *i.e.* products from different batches or "makes" are mixed so that identical proof results are obtained.

Sizes and Shapes of Powders.—In fig. 1, a to k show the relative sizes and shapes of grain as formerly employed for military purposes, except that the three largest powders, *e, f, g* and *h* are figured half-size to save space, whereas the remainder indicate the actual dimensions of the grains. *q* is for small-arms, all the others are for cannon of various sizes.

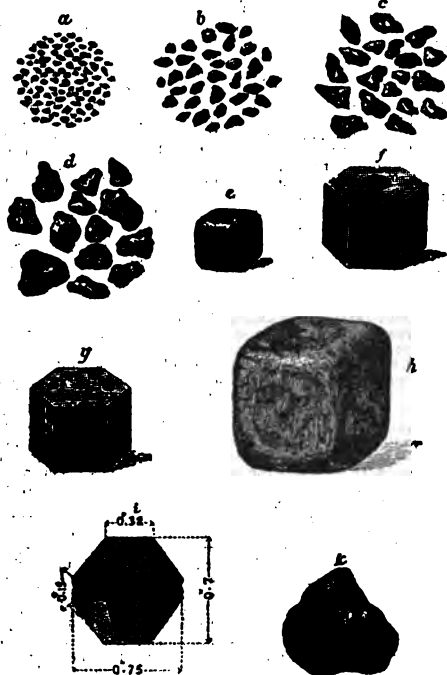

FIG. 1.

Proof of Powder.—In addition to chemical examination powder is passed through certain mechanical tests:—

1. For colour, glaze, texture and freedom from dust.
2. For proper incorporation.
3. For shape, size and proportion of the grains.—The first is judged by eye, and grains of the size required are obtained by the use of sieves of different sizes.
4. Density.—The density is generally obtained in some form of mercury densimeter, the powder being weighed in air and then under mercury. In some forms of the instrument the air can be pumped out so that the weighing takes place *in vacuo*.
5. Moisture and absorption of moisture.—The moisture and hygroscopic test consists in weighing a sample, drying at 100° C. for a certain time, weighing again, &c., until constant. The dried weighed sample can then be exposed to an artificial atmosphere of known moisture and temperature, and the gain in weight per hour similarly ascertained by periodic weighings.
6. Firing proof.—The nature of this depends upon the purpose for which the powder is intended. For sporting powders it consists in the "pattern" given by the shot upon a target at a given distance, or, if fired with a bullet, upon the "figure of merit," or mean radial deviation of a certain number of rounds; also upon the penetrative

power. For military purposes the "muzzle" velocity produced by a powder is ascertained by a chronograph which measures the exact time the bullet or other projectile takes to traverse a known distance between two wire screens. By means of "crusher gauges" the exact pressure per square inch upon certain points in the interior of the bore can be found.

In the chemical examination of gunpowder the points to be ascertained are, in addition to moisture, freedom from chlorides or sulphates, and correct proportion of nitre and sulphur to charcoal.

Products of Fired Powder and Changes taking place on Explosion.—With a mixture of the complexity of gunpowder it is quite impossible to say beforehand what will be the relative amounts of products. The desired products are nitrogen and carbon dioxide as gases, and potassium sulphate and carbonate as solids. But the ingredients of the mixture are not in any simple chemical proportion. Burning in contact with air under one atmosphere pressure, and burning in a closed or partially closed vessel under a considerable number of atmospheres pressure, may produce quite different results. The temperature of a reaction always rises with increased pressure. Although the main function of the nitre is to give up oxygen and nitrogen, of the charcoal to produce carbon dioxide and most of the heat, and of the sulphur by vaporizing to accelerate the rate of burning, it is quite impossible to represent the actions taking place on explosion by any simple or single chemical equation. Roughly speaking, the gases from black powder burnt in a closed vessel have a volume at 0° C. and 760 mm. pressure of about 280 times that of the original powder. The temperature produced under one atmosphere is above 2000° C., and under greater pressures considerably higher.

Experiments have been made by Benjamin Robins (1743), Charles Hutton (1778), Count Rumford (1797), Gay-Lussac (1823), R. Bunsen and L. Schiskoff (1857), T. J. Rodman (1861), C. Karolyi (1863), and later many researches by Sir Andrew Noble and Sir F. A. Abel, and by H. Debus and others, all with the idea of getting at the precise mechanism of the explosion. Debus (*Ann.*, 1882, vols. 212, 213; 1891, vol. 263) discussed at great length the results of researches by Bunsen, Karolyi, Noble and Abel, and others on the combustion of powder in closed vessels in such manner that all the products could be collected and examined and the pressure registered. A Waltham Abbey powder, according to an experiment by Noble and Abel, gave when fired in a closed vessel the following quantities of products calculated from one gram of powder:—

	Fractions of a gram.	Fractions of a molecule or atom.
Potassium carbonate	.2615	.00139 molecule
Potassium sulphate	.1268	.00072 "
" thiosulphate	.1666	.00087 "
" sulphide	.0252	.00017 "
Sulphur	.0012	.00004 atom
Carbon dioxide	.2678	.00668 molecule
Carbon monoxide	.0339	.00121 "
Nitrogen	.1071	.00765 atom
Hydrogen	.0008	.00008 "
Hydrogen sulphide	.0080	.00023 molecule
Potassium thiocyanate	.0004	.00004 "
Nitre	.0003	.00003 "
Ammonium carbonate	.0002	.00002 "

From this, and other results, Debus concluded that Waltham Abbey powder could be represented by the formula $16\text{KNO}_3 + 21 \cdot 18\text{C} + 6 \cdot 63\text{S}$ and that on combustion in a closed vessel the end results could be fairly expressed (rounding off fractions) by $16\text{KNO}_3 + 21\text{C} + 5\text{S} = 5\text{K}_2\text{CO}_3 + \text{K}_2\text{SO}_4 + 21\text{CO}_2 + 13\text{CO} + 3\text{C} + 8\text{N}_2$. Some of the sulphur is lost, part combining with the metal of the apparatus and part with hydrogen in the charcoal. The military powder of most nations can be represented by the formula $16\text{KNO}_3 + 21 \cdot 2\text{C} + 6 \cdot 6\text{S}$, proportions which are reasonably near to a theoretical mixture, that is one giving most complete combustion, greatest gas volume and temperature. The combustion of powder consists of two processes: (i.) oxidation, during which potassium carbonate and sulphate, carbon dioxide and nitrogen are mainly formed, and (ii.) a reduction process in which free carbon acts on the potassium sulphate and free sulphur on the potassium carbonate, producing potassium sulphide and carbon monoxide respectively. Most powders contain more carbon and sulphur than necessary, hence the second stage. In this second stage heat is lost. The potassium sulphide is also the most objectionable constituent as regards fouling.

The energy of a powder is given, according to Berthelot, by multiplying the gas volume by the heat (in calories) produced during burning; Debus shows that a powder composed of 16KNO_3 , 8C and 8S would have the least, and one of composition $16\text{KNO}_3 + 24\text{C} + 18\text{S}$ the greatest, when completely burnt. The greatest capability with the lowest proportion of carbon and sulphur to nitre would be obtained from the mixture $+16\text{KNO}_3 + 22\text{C} + 8\text{S}$.

Smokeless and even noiseless powders seem to have been sought for during the whole gunpowder period. In 1736 one was experimented with in France, but was abandoned owing to difficulties in manufacture. Modern smokeless powders are certainly less noisy than the black powders, mainly because of the absence of metallic salts which although they may be gaseous whilst in the gun are

certainly ejected as solids or become solids at the moment of contact with air.

Brown Powders.—About the middle of the 19th century guns and projectiles were made much larger and heavier than previously, and it was soon found that the ordinary black powders of the most dense form burnt much too rapidly, straining or bursting the pieces. Powders were introduced containing about 3% sulphur and 17-19% of a special form of charcoal made from slightly charred straw, or similar material. This "brown charcoal" contains a considerable amount of the hydrogen and oxygen of the original plant substance. The mechanical processes of manufacture of these brown powders is the same as for black. They, however, differ from black by burning very slowly, even under considerable pressure. This comparative slowness is caused by (1) the presence of a small amount of water even when air-dry; (2) the fact that the brown charcoal is practically very slightly altered colloidous material, which before it can burn completely must undergo a little further resolution or charring at the expense of some heat from the portion of charge first ignited; and (3) the lower content of sulphur. An increase of a few per cent in the sulphur of black powder accelerates its rate of burning, and it may become almost a blasting powder. A decrease in sulphur has the reverse effect. It is really the sulphur vapour that in the early period of combustion spreads the flame through the charge.

Many other powders have been made or proposed in which nitrates or chlorates of the alkalis or of barium, etc., are the oxygen providers and substances as sugar, starch, and many other organic compounds as the combustible elements. Some of these compositions have found employment for blasting or even as sporting powders, but in most cases their objectionable properties of fouling, smoke and mode of exploding have prevented their use for military purposes. The adoption by the French government of the comparatively smokeless nitrocellulose explosive of Paul Vieille in 1897 practically put an end to the old forms of gunpowders. The first smokeless powder was made in 1865 by Colonel E. Schultze (*Ding. Pol. Jour.* 174, p. 323; 175, p. 453) by nitrating wood meal and adding potassium and barium nitrates. It is somewhat similar in composition to the E. C. sporting powder. F. Uchatius, in Austria, proposed a smokeless powder made from nitrated starch, but it was not adopted owing to its hygroscopic nature and also its tendency to detonate.

BIBLIOGRAPHY.—Vannuccio Biringuccio, *De la pirotechnia* (Venice, 1540); Tartaglia, *Questiè e inventiōni diversi* (lib. iii.) (Venice, 1546); Peter Whiteborne, *How to make Saltpetre, Gunpowder, &c.* (London, 1573); Nic. Macchiavelli, *The Art of Warre*, trans. by Whiteborne (London, 1588); Hanzelot, *Recueil de plusieurs machines militaires* (Paris, 1620); Bofflet Langrois, *Modelles artifices de feu* (1620); Kruger, *Chemical Meditations on the Explosion of Gunpowder* (in Latin) (1636); Collado, *On the Invention of Gunpowder* (Spanish) (1641); *The True Way to make all Sorts of Gunpowder and Matches* (1647); Hawksbee, *On Gunpowder* (1686); Winter, *On Gunpowder* (in Latin); Robins, *New Principles of Gunnery* (London, 1742) (new ed. by Hutton, 1805); D'Antoni, *Essenza della polvere* (Turin, 1765) (trans. by Captain Thomson, R.A., London, 1787); Count Rumford, *Experiments on Fired Gunpowder*, *Phil. Trans. Roy. Soc.* (1797); Charles Hutton, *Mathematical Tracts*, vol. iii. (1812); Sir W. Congreve, *A Short Account of Improvements in Gunpowder made by* (London, 1818); Bunsen and Schischoff, "On the Chemical Theory of Gunpowder," *Pogg. Ann.*, 1857, vol. cii.; General Rodman, *Experiments on Metal for Cannon, and Qualities of Cannon Powder* (Boston, 1861); Napoleon III., *Études sur le passé et l'avenir de l'artillerie*, vol. iii. (Paris, 1862); Von Karolyi, "On the Products of the Combustion of Gun Cotton and Gunpowder," *Phil. Mag.* (October 1865); Captain F. M. Smith, *Handbook of the Manufacture and Proof of Gunpowder at Waltham Abbey* (London, 1870); Noble and Abel, *Fired Gunpowder* (London, 1875, 1880); Noble, *Artillery and Explosives* (1906); H. W. L. Hime, *Gunpowder and Ammunition, their Origin and Progress* (1904); O. Guttmann, *The Manufacture of Explosives* (1895), *Monumenta pulveris pyris* (1906); *Notes on Gunpowder and Gun Cotton*, published by order of the secretary of state for war (London, 1907). (See also EXPLOSIVES.) (W. R. E. H.)

GUNPOWDER PLOT, the name given to a conspiracy for blowing up King James I. and the parliament on the 5th of November 1605.

To understand clearly the nature and origin of the famous conspiracy, it is necessary to recall the political situation and the attitude of the Roman Catholics towards the government at the accession of James I. The Elizabethan administration had successfully defended its own existence and the Protestant faith against able and powerful antagonists, but this had not been accomplished without enforcing severe measures of repression and punishment upon those of the opposite faith. The beginning of a happier era, however, was expected with the opening of the new reign. The right of James to the crown could be more readily acknowledged by the Romanists than that of Elizabeth. Pope Clement VIII. appeared willing to

meet the king half-way. James himself was by nature favourable to the Roman Catholics and had treated the Roman Catholic lords in Scotland with great leniency, in spite of their constant plots and rebellions. Writing to Cecil before his accession he maintained, "I am so far from any intention of persecution as I protest to God I reverence their church as our mother church, although clogged with many infirmities and corruptions, besides that I did ever hold persecution as one of the infallible notes of a false church." He declared to Northumberland, the kinsman and master of Thomas Percy, the conspirator, "as for the Catholics, I will neither persecute any that will be quiet and give but an outward obedience to the law, neither will I spare to advance any of them that will be of good service and worthily deserved." It is probable that these small but practical concessions would have satisfied the lay Roman Catholics and the secular priests, but they were very far from contenting the Jesuits, by whom the results of such leniency were especially feared: "What rigour of laws would not compass in so many years," wrote Henry Tichborne, the Jesuit, in 1598, "this liberty and lenity will effectuate in 20 days, to wit the disurfishing of the seminaries, the disanimating of men to come and others to return, the expulsion of the society and confusion as in Germany, extinction of zeal and favour, dishonouring of princes from the hot pursuit of the enterprise. . . . We shall be left as a prey to the wolves that will besides drive our greatest patron [the king of Spain] to stoop to a peace which will be the utter ruin of our edifice, this many years in building." Unfortunately, about this time the Jesuits, who thus thrived on political intrigue, and who were deeply implicated in treasonable correspondence with Spain, had obtained a complete ascendancy over the secular priests, who were for obeying the civil government as far as possible and keeping free from politics. The time, therefore, as far as the Roman Catholics themselves were concerned, was not a propitious one for introducing the moderate concessions which alone James had promised: James, too, on his side, found that religious toleration, though clearly sound in principle, was difficult in practice. During the first few months of the reign all went well. In July 1603 the fines for recusancy were remitted. In January 1604 peaceable Roman Catholics could live unmolested and "serve God according to their consciences without any danger." But James's expectations that the pope would prevent dangerous and seditious persons from entering the country were unfulfilled and the numbers of the Jesuits and the Roman Catholics greatly increased. Rumours of plots came to hand. Cecil, though like his master naturally in favour of toleration, with his experience gained in the reign of Elizabeth, was alarmed at the policy pursued and its results, and great anxiety was aroused in the government and nation, which was in the end shared by the king. It was determined finally to return to the earlier policy of repression. On the 22nd of February 1604 a proclamation was issued banishing priests; on the 28th of November 1604, recusancy fines were demanded from 13 wealthy persons, and on the 10th of February 1605 the penal laws were ordered to be executed. The plot, however, could not have been occasioned by these measures, for it had been already conceived in the mind of Robert Catesby. It was aimed at the repeal of the whole Elizabethan legislation against the Roman Catholics and perhaps derived some impulse at first from the leniency lately shown by the administration, afterwards gaining support from the opposite cause, the return of the government to the policy of repression.

It was in May 1603 that Catesby told Percy, in reply to the latter's declaration of his intention to kill the king, that he was "thinking of a most sure way." Subsequently, about the 1st of November 1603, Catesby sent a message to his cousin Robert Winter at Huddington, near Worcester, to come to London, which the latter refused. On the arrival of a second urgent summons shortly afterwards he obeyed, and was then at a house at Lambeth, probably in January 1604, initiated by Catesby together with John Wright into the plot to blow up the parliament house. Before putting this plan into execution, however,

it was decided to try a "quiet way"; and Winter was sent over to Flanders to obtain the good offices of Juan de Velasco, duke of Frias and constable of Castile, who had arrived there to conduct the negotiations for a peace between England and Spain, in order to obtain the repeal of the penal laws. Winter, having secured nothing but vain promises from the constable, returned to England about the end of April, bringing with him Guy Fawkes, a man devoted to the Roman Catholic cause and recommended for undertaking perilous adventures. Subsequently the three and Thomas Percy, who joined the conspiracy in May, met in a house behind St Clement's and, having taken an oath of secrecy together, heard Mass and received the Sacrament in an adjoining apartment from a priest stated by Fawkes to have been Father Gerard. Later several other persons were included in the plot, viz. Winter's brother Thomas, John Grant, Ambrose Rokewood, Robert Keyes, Sir Everard Digby, Francis Tresham, a cousin of Catesby and Thomas Bates Catesby's servant, all, with the exception of the last, being men of good family and all Roman Catholics. Father Greenway and Father Garnet, the Jesuits, were both cognisant of the plot (see GARNET, HENRY). On the 24th of May 1604 a house was hired in Percy's name adjoining the House of Lords, from the cellar of which they proposed to work a mine. They began on the 11th of December 1604, and by about March had got half-way through the wall. They then discovered that a vault immediately under the House of Lords was available. This was at once hired by Percy, and 36 barrels of gunpowder, amounting to about 1 ton and 12 cwt., were brought in and concealed under coal and faggots. The preparations being completed in May the conspirators separated. Fawkes was despatched to Flanders, where he imparted the plot to Hugh Owen, a zealous Romanist intriguer. Sir Edmund Baynham was sent on a mission to Rome to be at hand when the news came to gain over the pope to the cause of the successful conspirators. An understanding was arrived at with several officers levied for the service of the archduke, that they should return at once to England when occasion arose of defending the Roman Catholic cause. A great hunting match was organized at Danchurch in Warwickshire by Digby, to which large numbers of the Roman Catholic gentry were invited, who were to join the plot after the successful accomplishment of the explosion of the 5th of November, the day fixed for the opening of parliament, and get possession of the princess Elizabeth, then residing in the neighbourhood; while Percy was to seize the infant prince Charles and bring him on horseback to their meeting-place. Guy Fawkes himself was to take ship immediately for Flanders, spread the news on the continent and get supporters. The conspirators imagined that a terrorized and helpless government would readily agree to all their demands. Hitherto the secret had been well kept and the preparations had been completed with extraordinary success and without a single drawback; but a very serious difficulty now confronted the conspirators as the time for action arrived, and disturbed their consciences. The feelings of ordinary humanity shrunk from the destruction of so many persons guiltless of any offence. But in addition, among the peers to be assassinated were included many Roman Catholics and some lords nearly connected in kinship or friendship with the plotters themselves. Several appeals, however, made to Catesby to allow warning to be given to certain individuals were firmly rejected.

On the 26th of October Lord Monteagle, a brother-in-law of Francis Tresham, who had formerly been closely connected with some of the other conspirators and had engaged in Romanist plots against the government, but who had given his support to the new king, unexpectedly ordered supper to be prepared at his house at Haxton, from which he had been absent for more than a year. While at supper about 6 o'clock an anonymous letter was brought by an unknown messenger which, having glanced at, he handed to Ward, a gentleman of his service and an intimate friend of Winter, the conspirator, to be read aloud. The celebrated letter ran as follows:—

"My lord, out of the love I bear to some of your friends, I have a care for your preservation. Therefore I would advise you, as you

tender your life, to devise some excuse to shift of your attendance of this Parliament, for God and man hath concurred to punish the wickedness of this time. And think not slightly of this advertisement, but retire yourself into your country, where you may expect the event in safety, for though there be no appearance of any stir, yet I say they shall receive a terrible blow the Parliament, and yet they shall not see who hurts them. This counsel is not to be contemned, because it may do you good and can do you no harm, for the danger is past as soon as you have burnt the letter: and I hope God will give you the grace to make good use of it, to whose holy protection I commend you."

The authorship of the letter has never been disclosed or proved, but all evidence seems to point to Tresham, and to the probability that he had some days before warned Monteagle and agreed with him as to the best means of making known the plot and preventing its execution, and at the same time of giving the conspirators time to escape (see TRESHAM, FRANCIS).

Monteagle at once started for Whitehall, found Salisbury and other ministers about to sit down to supper, and showed the letter, whereupon it was decided to search the cellar under the House of Lords before the meeting of parliament, but not too soon, so that the plot might be ripe and be fully disclosed. Meanwhile Ward, on the 27th of October, as had evidently been intended, informed Winter that the plot was known, and on the 28th Winter informed Catesby and begged him to give up the whole project. Catesby, however, after some hesitation, finding from Fawkes that nothing had been touched in the cellar, and prevailed upon by Percy, determined to stand firm, hoping that the government had put no credence in Monteagle's letter, and Fawkes returned to the cellar to keep guard as before. On the 4th the king, having been shown the letter, ordered the earl of Suffolk, as lord chamberlain, to examine the buildings. He was accompanied by Monteagle. On arriving at the cellar, the door was opened to him by Fawkes. Seeing the enormous piles of faggots he asked the name of their owner, to which Fawkes replied that they belonged to Percy. His name immediately aroused suspicions, and accordingly it was ordered that a further search should be made by Thomas Knayvet, a Westminster magistrate who, coming with his men at night, discovered the gunpowder and arrested Fawkes on the threshold.

The opinion that the whole plot was the work of Salisbury, that he acted as an *agent provocateur* and lured on his victims to destruction, repeated by some contemporary and later writers and recently formulated and urged with great ability, has no solid foundation. Nor is it even probable that he was aware of its existence till he received Monteagle's letter. Even after its reception complete belief was not placed in the warning. A search was made only to make sure that nothing was wrong and guided only by Monteagle's letter, while no attempt was made to seize the conspirators. The steps taken by Salisbury after the discovery of the gunpowder do not show the possession of any information of the plot or of the persons who were its chief agents outside Fawkes's first statement, and his knowledge is seen to develop according to the successive disclosures and confessions of the latter. Thus on the 7th of November he had no knowledge of the mine, and it is only after Fawkes's examination by torture on the 9th, when the names of the conspirators were drawn from him, that the government was able to classify them according to their guilt and extent of their participation. The inquiry was not conducted by Salisbury alone, but by several commissioners, some of whom were Roman Catholics, and many rivals and secret enemies. To conceal his intrigue from all these would have been impossible, and that he should have put himself in their power to such an extent is highly improbable. Again, the plan agreed upon for disclosing the plot was especially designed to allow the conspirators to escape, and therefore scarcely a method which would have been arranged with Salisbury. Not one of the conspirators, even when all hope of saving life was gone, made any accusation against Salisbury or the government and all died expressing contrition for their crime. Lastly Salisbury had no conceivable motive in concocting a plot of this description. His political power and position in the new reign had been already secured and by very different methods. He was now at the height of his influence, having been created Viscount Craborne

in August 1604 and earl of Salisbury in May 1605; and James had already, more than 16 months before the discovery of the plot, consented to return to the repressive measures against the Romanists. The success with which the conspirators concealed their plot from Salisbury's spies is indeed astonishing, but is probably explained by its very audacity and by the absence of incriminating correspondence, the medium through which the minister chiefly obtained his knowledge of the plans of his enemies.

On the arrest of Fawkes the other conspirators, except Tresham, fled in parties by different ways, rejoining each other in Warwickshire, as had been agreed in case the plot had been successful. Catesby, who with some others had covered the distance of 80 m. between London and his mother's house at Ashby St Legers in eight hours, informed his friends in Warwickshire, who had been awaiting the issue of the plot; of its failure, but succeeded in persuading Sir Everard Digby, by an unscrupulous falsehood, to further implicate himself in his hopeless cause by assuring him that both James and Salisbury were dead; and, according to Father Garnet, this was not the first time that Catesby had been guilty of lies in order to draw men into the plot. He pushed on the same day with his companions in the direction of Wales, where, it was hoped, they would be joined by bands of insurgents. They arrived at Huddington at 2 in the afternoon. On the morning of the 7th the band, numbering about 36 persons, confessed and heard Mass, and then rode away to Holbeche, 2 m. from Stourbridge, in Staffordshire, the house of Stephen Littleton, who had been present at the hunting at Danchurch (see DIGBY, EVERARD), where they arrived at 10 o'clock at night, having on their way broken into Lord Windsor's house at Hewell Grange and taken all the armour they found there. Their case was now desperate. None had joined them: "Not one came to take our part," said Sir Everard Digby, "though we had expected so many." They were being followed by the sheriff and all the forces of the county. All spurned them from their doors when they applied for succour. One by one their followers fled from the house in which the last scene was to be played out. They now began to feel themselves abandoned not only by man but by God; for an explosion of some of their gunpowder, on the morning of the 8th, by which Catesby and some others were scorched, struck terror into their hearts as a judgment from heaven. The assurance of innocence and of a just cause which till now had alone supported them was taken away. The greatness of their crime, its true nature, now struck home to them, and the few moments which remained to them of life were spent in prayer and in repentance. The supreme hour had now arrived. About 11 o'clock the sheriff and his men came up and immediately began firing into the house. Catesby, Percy and the two Wrights were killed, Winter and Rokewood wounded and taken prisoners with the men who still adhered to them. In all eight of the conspirators, including the two Winters, Digby, Fawkes, Rokewood, Keyes and Bates, were executed, while Tresham died in the Tower. Of the priests involved, Garnet was tried and executed, while Greenway and Gerard succeeded in escaping.

So ended the strange and famous Gunpowder Plot. However atrocious its conception and its aims, it is impossible not to feel, together with horror for the deed, some pity and admiration for the guilty persons who took part in it. "There was a crime which it would never have entered into the heart of any man to commit who was not raised above the lowness of the ordinary criminal." They sinned not against the light but in the dark. They erred from ignorance, from a perverted moral sense rather than from any mean or selfish motive, and exhibited extraordinary courage and self-sacrifice in the pursuit of what seemed to them the cause of God and of their country. Their punishment was terrible. Not only had they risked and lost all in the attempt and drawn upon themselves the frightful vengeance of the state, but they saw themselves the means of injuring irretrievably the cause for which they felt such devotion. Nothing could have been more disastrous to the cause of the Roman Catholics than their crime. The laws against them were immediately increased in severity, and the gradual advance towards religious toleration

was put back for centuries. In addition a new, increased and long-enduring hostility was aroused in the country against the adherents of the old faith, not unnatural in the circumstances, but unjust and indiscriminating, because while some of the Jesuits were no doubt implicated, the secular priests and Roman Catholic laity as a whole had taken no part in the conspiracy.

BIBLIOGRAPHY.—The recent controversy concerning the nature and origin of the plot can be followed in *What was the Gunpowder Plot?* by John Gerard, S.J. (1897); *What Gunpowder Plot was*, by S. R. Gardiner (a rejoinder) (1897); *The Gunpowder Plot . . . in reply to Professor Gardiner*, by John Gerard, S.J. (1897); *Thomas Winter's Confession and the Gunpowder Plot*, by John Gerard, S.J. (with facsimiles of his writing) (1898); *Eng. Hist. Rev.* iii. 510 and xii. 791; *Edinburgh Review*, clxxxv. 183; *Athenaeum* 1897, ii. 149, 785, 855; 1898, i. 23, ii. 352, 420; *Academy*, vol. 52 p. 84; *The Nation*, vol. 65 p. 400. A considerable portion of the controversy centres round the question of the authenticity of Thomas Winter's confession, the MS. of which is at Hatfield, supported by Professor Gardiner, but denied by Father Gerard principally on account of the document having been signed "Winter" instead of "Wintour," the latter apparently being the conspirator's usual style of signature. The document was deposited by the 3rd Marquess of Salisbury for inspection at the Record Office, and was pronounced by two experts, one from the British Museum and another from the Record Office, to be undoubtedly genuine. The cause of the variation in the signature still remains unexplained, but ceases to have therefore any great historical importance. The bibliography of the contemporary controversy is given in the article on Henry Garnet in the *Dictionary of National Biography* and in *The Gunpowder Plot* by David Jardine (1857), the latter work still remaining the principal authority on the subject; add to these Gardiner's *Hist. of England*, i., where an excellent account is given; *History of the Jesuits in England*, by Father Ethelred Taunton (1901); Father Gerard's Narrative in *Condition of the Catholics under James I.* (1872), and Father Greenway's Narrative in *Troubles of our Catholic Forefathers*, 1st series (1872), interesting as contemporary accounts, but not to be taken as complete or infallible authorities, of the same nature being *Historia Provinciae Anglicanae Societatis Jesu*, by Henry More, S.J. (1660), pp. 309 et seq.; also *History of Great Britain*, by John Speed (1611), pp. 839 et seq.; *Archaeologia*, xii. 200, xxviii. 422, xxix. 80; *Harleian Miscellany* (1809), iii. 119-135, or *Somers Tracts* (1809), ii. 97-117; M. A. Tierney's ed. of *Dodd's Church History*, vol. iv. (1841); *Treason and Plot*, by Martin Hume (1901); *Notes and Queries*, 7 ser. vi. 8 ser. iv. 408, 497, v. 55, xii. 505, 9 ser. xi. 115; *Add. MSS. Brit. Mus.* 6178; *State Trials*, ii.; *Calendar of State Pap. Dom.* (1603-1610), and the official account, *A True and Perfect Relation of the Whole Proceedings against the late most Barbarous Traitors* (1606), a neither true nor complete narrative; however, now superseded as an authority, reprinted as *The Gunpowder Treason . . . with additions* in 1679 by Thomas Barlow, bishop of Lincoln. A large number of letters and papers in the State Paper Office relating to the plot were collected in one volume in 1819, called *The Gunpowder Plot Book*; these are noted in their proper place in the printed calendars of State Papers, Domestic Series; see also articles on FAWKES, GUY; TRESHAM, FRANCIS; MONTAGLE, WILLIAM PARKER, 4TH BARON; PERCY, THOMAS; CATESBY, ROBERT; GARNET, HENRY; DIGBY, SIR EVERARD. (P. C. V.)

GUN-ROOM, a ship cabin occupied by the officers below the rank of lieutenant, but who are not warrant officers of the class of the boatswain, gunner or carpenter. In the wooden sailing ships it was on the lower deck, and was originally the quarters of the gunner.

GUNTER, EDMUND (1581-1626), English mathematician, of Welsh extraction, was born in Hertfordshire in 1581. He was educated at Westminster school, and in 1599 was elected a student of Christ Church, Oxford. He took orders, became a preacher in 1614, and in 1615 proceeded to the degree of bachelor in divinity. Mathematics, however, which had been his favourite study in youth, continued to engross his attention, and on the 6th of March 1619 he was appointed professor of astronomy in Gresham College, London. This post he held till his death on the 20th of December 1626. With Gunter's name are associated several useful inventions, descriptions of which are given in his treatises on the *Sector*, *Cross-staff*, *Bow*, *Quadrant* and other *Instruments*. He contrived his sector about the year 1606, and wrote a description of it in Latin, but it was more than sixteen years afterwards before he allowed the book to appear in English. In 1620 he published his *Canon triangulorum* (see LOGARITHMS). There is reason to believe that Gunter was the first to discover (in 1622 or 1625) that the magnetic needle does not retain the same declination in the same place at all times. By desire of

James I. he published in 1624 *The Description and Use of His Majesty's Diodes in Whitehall Garden*, the only one of his works which has not been reprinted. He introduced the words cosine and cotangent, and he suggested to Henry Briggs, his friend and colleague, the use of the arithmetical complement (see Briggs' *Arithmetica Logarithmica*, cap. xv.). His practical inventions are briefly noticed below:

Gunter's Chain, the chain in common use for surveying, is 22 yds. long and is divided into 100 links. Its usefulness arises from its decimal or centesimal division, and the fact that 10 square chains make an acre.

Gunter's Line, a logarithmic line, usually laid down upon scales, sectors, &c. It is also called the *line of lines* and the *line of numbers*, being only the logarithms graduated upon a ruler, which therefore serves to solve problems instrumentally in the same manner as logarithms do arithmetically.

Gunter's Quadrant, an instrument made of wood, brass or other substance, containing a kind of stereographic projection of the sphere on the plane of the equinoctial, the eye being supposed to be placed in one of the poles, so that the tropic, ecliptic, and horizon form the arcs of circles, but the hour circles are other curves, drawn by means of several altitudes of the sun for some particular latitude every year. This instrument is used to find the hour of the day, the sun's azimuth, &c., and other common problems of the sphere or globe, and also to take the altitude of an object in degrees.

Gunter's Scale (generally called by seamen the *Gunter*) is a large plane scale, usually 2 ft. long by about 1½ in. broad, and engraved with various lines of numbers. On one side are placed the natural lines (as the line of chords, the line of sines, tangents, rhumbs, &c.), and on the other side the corresponding artificial or logarithmic ones. By means of this instrument questions in navigation, trigonometry, &c., are solved with the aid of a pair of compasses.

GÜNTHER, JOHANN CHRISTIAN (1695-1723), German poet, was born at Striegau in Lower Silesia on the 8th of April 1695. After attending the gymnasium at Schweidnitz, he was sent in 1715 by his father, a country doctor, to study medicine at Wittenberg; but he was idle and dissipated, had no taste for the profession chosen for him, and came to a complete rupture with his family. In 1717 he went to Leipzig, where he was befriended by J. B. Mencke (1674-1732), who recognized his genius; and there he published a poem on the peace of Passarowitz (concluded between the German emperor and the Porte in 1718) which acquired him reputation. A recommendation from Mencke to Frederick Augustus II. of Saxony, king of Poland, proved worse than useless, as Günther appeared at the audience drunk. From that time he led an unsettled and dissipated life, sinking ever deeper into the slough of misery, until he died at Jena on the 15th of March 1723, when only in his 28th year. Goethe pronounces Günther to have been a poet in the fullest sense of the term. His lyric poems as a whole give evidence of deep and lively sensibility, fine imagination, clever wit, and a true ear for melody and rhythm; but an air of cynicism is more or less present in most of them, and dull or vulgar witticisms are not infrequently found side by side with the purest inspirations of his genius.

Günther's collected poems were published in four volumes (Breslau, 1723-1735). They are also included in vol. vi. of Tittmann's *Deutsche Dichter des 17ten Jahrh.* (Leipzig, 1874), and vol. xxxviii. of Kürschner's *Deutsche Nationalliteratur* (1883). A pretended autobiography of Günther appeared at Schweidnitz in 1732, and a life of him by Siebrand at Leipzig in 1738. See Hoffmann's *Leben und Dichten J. Ch. Günthers* (Breslau, 1833); O. Roquette, *Leben und Dichten J. Ch. Günthers* (Stuttgart, 1860); M. Kalbeck, *Neue Beiträge zur Biographie des Dichters C. Günther* (Breslau, 1879).

GÜNTHER OF SCHWARZBURG (1304-1349), German king, was a descendant of the counts of Schwarzburg and the younger son of Henry VII., count of Blankenburg. He distinguished himself as a soldier, and rendered good service to the emperor Louis IV., on whose death in 1347 he was offered the German throne, after it had been refused by Edward III., king of England. He was elected German king at Frankfort on the 30th of January 1349 by four of the electors, who were partisans of the house of Wittelsbach and opponents of Charles of Luxemburg, afterwards the emperor Charles IV. Charles, however, won over many of Günther's adherents, defeated him at Eltville, and Günther, who was now seriously ill, renounced his claims for the sum of 20,000 marks of silver. He died three weeks afterwards at Frankfort,

and was buried in the cathedral of that city; where a statue was erected to his memory in 1353.

See Graf L. Otterodt zu Schwarzenberg, *Günther, Graf von Schwarzburg, erwählter deutscher König* (Leipzig, 1862); and K. Janssen, *Das Königtum Günthers von Schwarzburg* (Leipzig, 1880).

GUNTRAM, or **CONTRAN** (561-592), king of Burgundy, was one of the sons of Clotaire I. On the death of his father (561) he and his three brothers divided the Frankish realm between them, Guntram receiving as his share the valleys of the Saône and Rhone, together with Berry and the town of Orleans, which he made his capital. On the death of Charibert (567), he further obtained the *ciduales* of Saintes, Angoulême and Périgoeux. During the civil war which broke out between the kings of Neustria and Austrasia, his policy was to try to maintain a state of equilibrium. After the assassination of Sigebert (575), he took the youthful Childebert II. under his protection, and, thanks to his assistance against the intrigues of the great lords, the latter was able to maintain his position in Austrasia. After the death of Chilperic (584) he protected the young Clotaire II. in the same way, and prevented Childebert from seizing his dominions. His course was rendered easier by the fact that his own sons had died; consequently, having an inheritance at his disposal, he was able to offer it to whichever of his nephews he wished. The danger to the Frankish realm caused by the expedition of Gundobald (585), and the anxiety which was caused him by the revolts of the great lords in Austrasia finally decided him in favour of Childebert. He adopted him as his son, and recognized him as his heir at the treaty of Andelot (587); he also helped him to crush the great lords, especially Unio and Berthefried, who were conquered in la Woivre. From this time on he ceased to play a prominent part in the affairs of Austrasia. He died in 592, and Childebert received his inheritance without opposition. Gregory of Tours is very indulgent to Guntram, who showed himself on occasions generous towards the church; he almost always calls him "good king Guntram," and in his writings are to be found such phrases as "good king Guntram took as his servant a concubine Veneranda" (iv. 25); but Guntram was really no better than the other kings of his age; he was cruel and licentious, putting his *cubicularius* Comdo to death, for instance, because he was suspected of having killed a buffalo in the Vegeas. He was moreover a coward, and went in such constant terror of assassination that he always surrounded himself with a regular body-guard.

See Krusch, "Zur Chronologie der merowingischen Könige," in the *Forschungen zur deutschen Geschichte*, xxii. 451-490; Ulysse Chevalier, *Bio-bibliographie* (2nd ed.), s.v. "Guntram." (C. Fr.)

GUNTUR, a town and district of British India, in the Madras presidency. The town (pop. in 1901, 30,833) has a station on the Bellary-Beswada branch of the Southern Mahratta railway. It is situated east of the Koadavid hills, and is very healthy. It appears to have been founded in the 18th century by the French. At the time of the cession of the Circars to the English in 1765, Guntur was specially exempted during the life of Bessal Jang, whose personal jagir it was. In 1788 it came into British possession, the cession being finally confirmed in 1823. It has an important trade in cotton, with presses and ginning factories. There is a second-grade college supported by the American Lutheran Mission. Until 1859, Guntur was the headquarters of a district of the same name, and in 1904 a new DISTRICT OF GUNTUR was constituted, covering territory which till then had been divided between Kistna and Nellore. Area, 5733 sq. m. The population on this area in 1901 was 1,490,635. The district is bounded on the E. and N. by the river Kistna; in the W. a considerable part of the boundary is formed by the Gundlankamma river. The greater part consists of a fertile plain irrigated by canals from the Kistna, and producing cotton, rice and other crops.

GUPTA, an empire and dynasty of northern India, which lasted from about A.D. 320 to 480. The dynasty was founded by Chandragupta I., who must not be confounded with his famous predecessor Chandragupta Maurya. He gave his name to the Gupta era, which continued in use for several centuries, dating

from the 26th of February, A.D. 320. Chandragupta was succeeded by Samudragupta (c. A.D. 320-375), one of the greatest of Indian kings, who conquered nearly the whole of India, and whose alliances extended from the Oxus to Ceylon; but his name was at one time entirely lost to history, and has only been recovered of recent years from coins and inscriptions. His empire rivalled that of Asoka, extending from the Hugli on the east to the Jumna and Chambal on the west, and from the foot of the Himalayas on the north to the Nerubudda on the south. His son Chandragupta II. (c. A.D. 375-415) was also known as Vikramaditya (q.v.), and seems to have been the original of the mythical Hindu king of that name. About 388 he conquered the Saka satrap of Surashtra (Kathliwar) and penetrated to the Arabian Sea. His administration is described in the work of Fa-hien, the earliest Chinese pilgrim, who visited India in A.D. 405-411. Pataliputra was the capital of the dynasty, but Ajodhya seems to have been sometimes used by both Samudragupta and Chandragupta II. as the headquarters of government. The Gupta dynasty appears to have fostered a revival of Brahmanism at the expense of Buddhism, and to have given an impulse to art and literature. The golden age of the empire lasted from A.D. 330 to 455, beginning to decline after the latter date. When Skandagupta came to the throne in 455, India was threatened with an irruption of the White Huns, on whom he inflicted a severe defeat, thus saving his kingdom for a time; but about 470 the White Huns (see EPITHALITES) returned to the attack, and the empire was gradually destroyed by their repeated inroads. When Skandagupta died about 480, the Gupta empire came to an end, but the dynasty continued to rule in the eastern provinces for several generations. The last known prince of the imperial line of Guptas was Kāmaragupta II. (c. 535), after whom it passed "by an obscure transition" into a dynasty of eleven Gupta princes, known as "the later Guptas of Magadha," who seem for the most part to have been merely local rulers of Magadha. One of them, however, Adityasena, after the death of the paramount sovereign in 648, asserted his independence. The last known Gupta king was Jivtagupta II., who reigned early in the 8th century. About the middle of the century Magadha passed under the sway of the Pal kings of Bengal.

See J. F. Fleet, *Gupta Inscriptions* (1886); and Vincent A. Smith, *The Early History of India* (2nd ed., Oxford, 1908), pp. 264-295.

GURA, EUGEN (1842-1906), German singer, was born near Saatz in Bohemia, and educated at first for the career of a painter at Vienna and Munich; but later, developing a fine baritone voice, he took up singing and studied it at the Munich Conservatorium. In 1865 he made his debut at the Munich opera, and in the following years he gained the highest reputation in Germany, being engaged principally at Leipzig till 1876 and then at Hamburg till 1883. He sang in 1876 in the *Ring* at Bayreuth, and was famous for his Wagnerian rôles; and his Hans Sachs in *Meister-singer*, as performed in London in 1883, was magnificent. In later years he showed the perfection of art in his singing of German *Lieder*. He died in Bavaria on the 16th of August 1906.

GURDASPUR, a town and district of British India, in the Lahore division of the Punjab. The town had a population in 1901 of 5764. It has a fort (now containing a Brahman monastery) which was famous for the siege it sustained in 1712 from the Moguls. The Sikh leader, Banda, was only reduced by starvation, when he and his men were tortured to death after capitulating.

The District comprises an area of 1859 sq. m. It is bounded on the N. by the native states of Kashmir and Chamba, on the E. by Kangra district and the river Beas, on the S.W. by Amritsar district, and on the W. by Sialkot, and occupies the submontane portion of the Bari Doab, or tract between the Beas and the Ravi. An intrusive spur of the British dominions runs northward into the lower Himalayan ranges, to include the mountain sanatorium of Dalhousie, 7687 ft. above sea-level. This station, which has a large fluctuating population during the warmer months, crowns the most westerly shoulder of a magnificent snowy range, the Dhauladhar, between which and the plain two minor ranges intervene. Below the hills stretches a picturesque

and undulating plateau covered with abundant timber, made green by a copious rainfall, and watered by the streams of the Bari Doab, which, diverted by dams and embankments, now empty their waters into the Beas directly, in order that their channels may not interfere with the Bari Doab canal. The district contains several large *jhils* or swampy lakes, and is famous for its snipe-shooting. It is historically important in connexion with the rise of the Sikh confederacy. The whole of the Punjab was then distributed among the Sikh chiefs who triumphed over the imperial governors. In the course of a few years, however, the maharaja Ranjit Singh acquired all the territory which those chiefs had held. Pathankot and the neighbouring villages in the plain, together with the whole hill portion of the district, formed part of the area ceded by the Sikhs to the British after the first Sikh war in 1846. In 1862, after receiving one or two additions, the district was brought into its present shape. In 1901 the population was 940,334, showing a slight decrease, compared with an increase of 15% in the previous decade. A branch of the North-Western railway runs through the district. The largest town and chief commercial centre is Batala. There are important woollen mills at Dhariwal, and besides their products the district exports cotton, sugar, grain and oil-seeds.

GURGAON, a town and district of British India, in the Delhi division of the Punjab. The town (pop. in 1901, 4765) is the headquarters of the district, but is otherwise unimportant. The district has an area of 1084 sq. m. It is bounded on the N. by Rohtak, on the W. and S.W. by portions of the Alwar, Nabha and Jind native states, on the S. by the Muttra district of the United Provinces, on the E. by the river Jumna and on the N.E. by Delhi. It comprises the southernmost corner of the Punjab province, stretching away from the level plain towards the hills of Rajputana. Two low rocky ranges enter its borders from the south and run northward in a bare and unshaded mass toward the plain country. East of the western ridge the valley is wide and open, extending to the banks of the Jumna. To the west lies the subdivision of Rewari, consisting of a sandy plain dotted with isolated hills. Numerous torrents carry off the drainage from the upland ranges, and the most important among them empty themselves at last into the Najafgarh *jhil*. This swampy lake lies to the east of the civil station of Gurgaon, and stretches long arms into the neighbouring districts of Delhi and Rohtak. Salt is manufactured in wells at several villages. The mineral products are iron ore, copper ore, plumbago and ochre.

In 1803 Gurgaon district passed into the hands of the British after Lord Lake's conquests. On the outbreak of the Mutiny in May 1857, the nawab of Farukhnagar, the principal feudatory of the district, rose in rebellion. The Meos and many Rajput families followed his example. A faithful native officer preserved the public buildings and records at Rewari from destruction; but with this exception, British authority became extinguished for a time throughout Gurgaon. After the fall of the rebel capital, a force marched into the district and either captured or dispersed the leaders of rebellion. The territory of the nawab was confiscated on account of his participation in the Mutiny. Civil administration was resumed under orders from the Panjab government, to which province the district was formally annexed on the final pacification of the country. The population in 1901 was 746,208, showing an increase of 11% in the decade. The largest town and chief trade centre is Rewari. The district is now traversed by several lines of railway, and irrigation is provided by the Agra canal. The chief trade is in cereals, but hardware is also exported.

GURKHA (pronounced *gôrka*; from Sans. *gôu*, a cow, and *raha*, to protect), the ruling Hindu race in Nepal (q.v.). The Gurkhas, or Gurkhalis, claim descent from the rajas of Chitor in Rajputana. When driven out of their own country by the Mahomedan invasion, they took refuge in the hilly districts about Kumaon, whence they gradually invaded the country to the eastward as far as Gurkha, Noakote and ultimately to the valley of Nepal and even Sikkim. They were stopped by the English in an attempt to push south, and the treaty of Segauli,

which ended the Gurkha War of 1814, definitely limited their territorial growth. The Gurkhas of the present day remain Hindus by religion, but show in their appearance a strong admixture of Mongolian blood. They make splendid infantry soldiers, and by agreement with their government about 20,000 have been recruited for the Gurkha regiments of the Indian army. As a rule they are bold, enduring, faithful, frank, independent and self-reliant. They despise other Orientals, but admire and fraternize with Europeans, whose tastes in sport and war they share. They strongly resemble the Japanese, but are of a sturdier build. Their national weapon is the *khukri*, a heavy curved knife, which they use for every possible purpose.

See Capt. Eden Vansittart, *Notes on the Gurkhas* (1898); and P. D. Bonarjee, *The Fighting Races of India* (1899).

GURNALL, WILLIAM (1617-1679), English author, was born in 1617 at King's Lynn, Norfolk. He was educated at the free grammar school of his native town, and in 1631 was nominated to the Lynn scholarship in Emmanuel College, Cambridge, where he graduated B.A. in 1635 and M.A. in 1639. He was made rector of Lavenham in Suffolk in 1644; and before he received that appointment he seems to have officiated, perhaps as curate, at Sudbury. At the Restoration he signed the declaration required by the Act of Uniformity, and on this account he was the subject of a libellous attack, published in 1665, entitled *Covenant-Renouncers Desperate Apostates*. He died on the 12th of October 1679. Gurnall is known by his *Christian in Complete Armour*, published in three volumes, dated 1655, 1658 and 1662. It consists of a series of sermons on the latter portion of the 6th chapter of Ephesians, and is described as a "magazine from whence the Christian is furnished with spiritual arms for the battle, helped on with his armour, and taught the use of his weapon; together with the happy issue of the whole war." The work is more practical than theological; and its quaint fancy, graphic and pointed style, and its fervent religious tone render it still popular with some readers.

See also *An Inquiry into the Life of the Rev. W. Gurnall*, by H. M'Keon (1830), and a biographical introduction by Bishop Ryle to the *Christian in Complete Armour* (1865).

GURNARD (*Trigla*), a genus of fishes forming a group of the family of "mailed cheeks" (*Triglidæ*), and easily recognized by three detached finger-like appendages in front of the pectoral fins, and by their large, angular, bony head, the sides of which are protected by strong, hard and rough bones. The pectoral appendages are provided with strong nerves, and serve not only as organs of locomotion when the fish moves on the bottom, but also as organs of touch, by which it detects small animals on which it feeds. Gurnards are coast-fishes, generally distributed over the tropical and temperate areas; of the forty species known six occur on the coast of Great Britain, viz. the red



Trigla pleuracanthica.

gurnard (*T. pini*), the streaked gurnard (*T. lineata*), the sapphire gurnard (*T. hirundo*), the grey gurnard (*T. gurnardus*), the piper (*T. lyra*) and the long-finned gurnard (*T. obscura* or *T. lucerna*). Although never found very far from the coast, gurnards descend to depths of several hundred fathoms; and as they are bottom-fish they are caught chiefly by means of the trawl. Not rarely, however, they may be seen floating on the surface of the water, with their broad, finely coloured pectoral fins spread out like fans. In very young fishes, which abound in certain localities on the coast in the months of August and September, the pectorals

are comparatively much longer than in the adult, extending to the end of the body; they are beautifully coloured and kept expanded, the little fishes looking like butterflies. When caught and taken out of the water, gurnards emit a grunting noise, which is produced by the vibrations of a diaphragm situated transversely across the cavity of the bladder and perforated in the centre. This grunting noise gave rise to the name "gurnard," which is probably an adaptation or variation of the Fr. *gognard*, grumbler, cf. the Fr. *goudin*, gurnard, from *goudon*, and Ger. *Knurrfisch*. Their flesh is very white, firm and wholesome.

GURNEY, the name of a philanthropic English family of bankers and merchants, direct descendants of Hugh de Gournay, lord of Gournay, one of the Norman noblemen who accompanied William the Conqueror to England. Large grants of land were made to Hugh de Gournay in Norfolk and Suffolk, and Norwich has since that time been the headquarters of the family, the majority of whom were Quakers. Here in 1770 the brothers John and Henry Gurney founded a banking-house, the business passing in 1779 to Henry's son, Bartlett Gurney. On the death of Bartlett Gurney in 1802 the bank became the property of his three cousins, of whom JOHN GURNEY (1758-1809) was the most remarkable. One of his daughters was Elizabeth Fry; another married Sir Thomas Fowell Buxton. Of his sons one was JOSEPH JOHN GURNEY (1788-1847), a well-known philanthropist of the day; another, SAMUEL GURNEY (1786-1856) assumed on his father's death the control of the Norwich bank. Samuel Gurney also took over about the same time the control of the London bill-broking business of Richardson, Overend & Company, in which he was already a partner. This business had been founded in 1800 by Thomas Richardson, clerk to a London bill-discounter, and John Overend, chief clerk in the bank of Smith, Payne & Company at Nottingham, the Gurneys supplying the capital. At that time bill-discounting was carried on in a spasmodic fashion by the ordinary merchant in addition to his regular business, but Richardson considered that there was room for a London house which should devote itself entirely to the trade in bills. This, at that time, novel idea proved an instant success. The title of the firm was subsequently changed to Overend, Gurney & Company, and for forty years it was the greatest discounting-house in the world. During the financial crisis of 1825 Overend, Gurney & Company were able to make short loans to many other bankers. The house indeed became known as "the bankers' banker," and secured many of the previous clients of the Bank of England. Samuel Gurney died in 1856. He was a man of very charitable disposition, and during the latter years of his life charitable and philanthropic undertakings almost monopolized his attention. In 1865 the business of Overend, Gurney & Company, which had come under less competent control, was converted into a joint stock company, but in 1866 the firm suspended payment with liabilities amounting to eleven millions sterling.

GURNEY, EDMUND (1847-1888), English psychologist, was born at Herham, near Walton-on-Thames, on the 29th of March 1847. He was educated at Blackheath and at Trinity College, Cambridge, where he took a high place in the classical tripos and obtained a fellowship. His work for the schools was done, says his friend F. W. H. Myers, "in the intervals of his practice on the piano." Dissatisfied with his own executive skill as a musician, he wrote *The Power of Sound* (1880), an essay on the philosophy of music. He then studied medicine with no intention of practising, devoting himself to physics, chemistry and physiology. In 1880 he passed the second M.B. Cambridge examination in the science of the healing profession. These studies, and his great logical powers and patience in the investigation of evidence, he devoted to that outlying field of psychology which is called "Psychical Research." He asked whether, as universal tradition declares, there is an unexplored region of human faculty transcending the normal limitations of sensible knowledge. That there is such a region it was part of the system of Hegel to declare, and the subject had been metaphysically treated by Hartmann, Schopenhauer, Du Prel, Hamilton and others; as the philosophy

of the Unconscious or Subconscious. But Gurney's purpose was to approach the subject by observation and experiment, especially in the hypnotic field, whereas vague and ill-attested anecdotes had hitherto been the staple of the evidence of metaphysicians. The tendency of his mind was to investigate whatever facts may give a colour of truth to the ancient belief in the persistence of the conscious human personality after the death of the body. Like Joseph Glanvill's, the natural bent of Gurney's mind was sceptical. Both thought the current and traditional reports of supernormal occurrences suggestive and worth investigating by the ordinary methods of scientific observation, and inquiry into evidence at first hand. But the method of Gurney was, of course, much more strict than that of the author of *Sadducismus Triumphatus*, and it included hypnotic and other experiments unknown to Glanvill. Gurney began at what he later saw was the wrong end by studying, with Myers, the "séances" of professed spiritualistic "mediums" (1874-1878). Little but detection of imposture came of this, but an impression was left that the subject ought not to be abandoned. In 1882 the Society for Psychical Research was founded. (See *PSYCHICAL RESEARCH*.) Paid mediums were discarded, at least for the time, and experiments were made in "thought-transference" and hypnotism. Personal evidence as to uninduced hallucinations was also collected. The first results are embodied in the volumes of *Phantasms of the Living*, a vast collection (Podmore, Myers and Gurney), and in Gurney's remarkable essay, *Hallucinations*. The chief consequence was to furnish evidence for the process called "telepathy," involving the provisional hypothesis that one human mind can affect another through no recognized channel of sense. The fact was supposed to be established by the experiments chronicled in the *Proceedings of the Society for Psychical Research*, and it was argued that similar experiences occurred spontaneously, as, for example, in the many recorded instances of "deathbed wraiths" among civilized and savage races. (Tylor, *Primitive Culture*, i. chapter xi., especially pp. 449-450, 1873. Lang, *Making of Religion*, pp. 120-124, 1898.) The dying man is supposed to convey the hallucination of his presence as one living person experimentally conveys his thought to another, by "thought-transference." Gurney's hypnotic experiments, marked by great exactness, patience and ingenuity, were undertaken in 1885-1888. Their tendency was, in Myers's words, "to prove—so far as any one operator's experience in this protean subject can be held to prove anything—that there is sometimes, in the induction of hypnotic phenomena, some agency at work which is neither ordinary nervous stimulation (monotonous or sudden) nor suggestion conveyed by any ordinary channel to the subject's mind." These results, if accepted, of course corroborate the idea of telepathy. (See Gurney, "Hypnotism and Telepathy," *Proceedings S.P.R.* vol. iv.) Experiments by M.M. Gibert, Janet, Richet, Héricourt and others are cited as tending in the same direction. Other experiments dealt with "the relation of the memory in the hypnotic state to the memory in another hypnotic state, and of both to the normal or waking memory." The result of Gurney's labours, cut short by his early death, was to raise and strengthen the presumption that there exists an unexplored region of human faculty which ought not to be neglected by science as if the belief in it were a mere survival of savage superstition. Rather, it appears to have furnished the experiences which, misinterpreted, are expressed in traditional beliefs. That Gurney was credulous and easily imposed upon those who knew him, and knew his penetrating humour, cannot admit; nor is the theory likely to be maintained by those whom bias does not prevent from studying with care his writings. In controversy "he delighted in replying with easy courtesy to attacks envenomed with that *odium plus quam theologicum* which the very allusion to a ghost or the human soul seems in some philosophers to inspire." In discussion of themes unpopular and obscure Gurney displayed the highest tact, patience, good temper, humour and acuteness. There never was a more disinterested student. In addition to his work on music and his psychological writings, he was the author of *Tertium Quid* (1887), a collection of essays, on the whole a protest against one-

sided ideas and methods of discussion. He died at Brighton on 23rd June 1888, from the effects of an overdose of narcotic medicine. (A. L.)

GURWOOD, JOHN (1790-1845), British soldier, began his career in a merchant's office, but soon obtained an ensigncy in the 52nd (1808). With his regiment he served in the "Light Division" of Wellington's army throughout the earlier Peninsular campaigns, and at Ciudad Rodrigo (10th Jan. 1812) he led one of the forlorn hopes and was severely wounded. For his gallant conduct on this occasion Wellington presented Gurwood with the sword of the French governor of Ciudad Rodrigo. A little later, transferring to the 9th Light Dragoons, he was made brigade-major to the Guards' cavalry which had just arrived in the Peninsula. In the latter part of the war he served as brigade-major to Lambert's brigade of the sixth infantry division, and was present at the various actions in which that division played a conspicuous part—the Nivelle, the Nivc, Orthes and Toulouse. At Waterloo Captain Gurwood was for the third time severely wounded. In the first twelve years of the peace he was promoted up to the grade of lieutenant-colonel, and in 1841 became brevet-colonel. He was for many years the duke of Wellington's private secretary, and was entrusted by him with the collection and editing of the *Wellington Despatches*, which occupied Gurwood from 1837 to the end of his life. This work is a monument of industrious skill, and earned its author a Civil List Pension of £200. But overwork and the effects of his wounds had broken his health, and he committed suicide on Christmas day 1843. He was a C.B. and deputy-lieutenant of the Tower.

GUSLA, or GUSLI, an ancient stringed instrument still in use among the Slavonic races. The modern Servian *gusla* is a kind of tambur (see *PANDURA*), consisting of a round, concave body covered with a parchment soundboard; there is but one horse-hair string, and the peg for tuning it is inserted in oriental fashion in the back of the head. The *gusla* is played with a primitive bow called *gondala*. The *guslars* or blind bards of Servia and Croatia use it to accompany their chants. C. G. Anton¹ mentions an instrument of that name in the shape of a half-moon strung with eighteen strings in use among the Tatars. Prosper Merimeé² has taken the *gusla* as the title for a book of Servian poems, which are supposed to have been collected by him among the peasants, but which are thought to have been inspired by the *Vlajko in Dalmatia* of Alberto Fortis.

Among the Russians, the *gusli* is an instrument of a different type, a kind of psaltery having five or more strings stretched across a flat, shallow sound-chest in the shape of a wing. In the *gusli* the strings, of graduated length, are attached to little nails or pins at one end, and at the other they are wound over a rod having screw attachments for increasing and slackening the tension. There is no bridge to determine the vibrating length of the strings. The body of the instrument is shaped roughly like the tail of the grand piano, following the line of the strings; the longest being at the left of the instrument. Matthew Guthrie gives an illustration of the *gusli*.³ (K. S.)

GUSTAVUS I. ERIKSSON (1496-1560), king of Sweden, was born at his mother's estate at Lindholm on Ascension Day 1496. He came of a family which had shone conspicuously in 15th-century politics, though it generally took the anti-national side. His father, Erik Johansson of Rydholm, "a merry and jocose gentleman," but, like all the Swedish Vasas, liable to sudden fierce gusts of temper, was one of the senators who voted for the deposition of Archbishop Trolle, at the *rikdag* of 1517 (see SWEDEN, *History*), for which act of patriotism he lost his head. Gustavus's mother, Cecilia Måndåtter, was closely connected by marriage with the great Sture family. Gustavus's youthful experiences impressed him with a life-long distrust of everything Danish. In his eighteenth year he was sent to the court of his cousin Sten Sture. At the battle of Bränkyrka, when Sture

¹ *Erste Linsen eines Versuchs über den Ursprung der alten Slaven* (Leipzig, 1783-1789), p. 145.

² *La Gusla, ou choix de poésies lyriques recueillies dans la Dalmatie, la Bosnie, la Croatie, &c.* (Paris, 1827).

³ *Dissertationen sur les antiquités de Russie* (St Petersburg, 1795), pl. ii. No. 9, p. 31.

defeated Christian II. of Denmark, the young Gustavus bore the governor's standard, and in the same year (1518) he was delivered with five other noble youths as a hostage to King Christian, who treacherously carried him prisoner to Denmark. He was detained for twelve months in the island fortress of Kalb, on the east coast of Jutland, but contrived to escape to Lübeck in September 1519. There he found an asylum till the 20th of May 1520, when he chartered a ship to Kalmar, one of the few Swedish fortresses which held out against Christian II.

It was while hunting near Lake Mälär that the news of the Stockholm massacre was brought to him by a peasant fresh from the capital, who told him, at the same time, that a price had been set upon his head. In his extremity, Gustavus saw only one way of deliverance, an appeal for help to the sturdy yeomen of the dales. How the dalesmen set Gustavus on the throne and how he and they finally drove the Danes out of Sweden (1521-1523) is elsewhere recorded (see SWEDEN: *History*). But his worst troubles only began after his coronation on the 6th of June 1523. The financial position of the crown was the most important of all the problems demanding solution, for upon that everything else depended. By releasing his country from the tyranny of Denmark, Gustavus had made the free independent development of Sweden a possibility. It was for him to realize that possibility. First of all, order had to be evolved from the chaos in which Sweden had been plunged by the disruption of the Union; and the shortest, perhaps the only, way thereto was to restore the royal authority, which had been in abeyance during ninety years. But an effective reforming monarchy must stand upon a sound financial basis; and the usual revenues of the crown, always inadequate, were so diminished that they did not cover half the daily expenses of government. New taxes could only be imposed with extreme caution, while the country was still bleeding from the wounds of a long war. And men were wanted even more than money. The lack of capable, trustworthy administrators in Sweden was grievous. The whole burden of government weighed exclusively on the shoulders of the new king, a young man of seven and twenty. Half his time was taken up in travelling from one end of the kingdom to the other, and doing purely clerical work for want of competent assistance. We can form some idea of his difficulties when we learn that, in 1533, he could not send an ambassador to Lübeck because not a single man in his council, except himself, knew German. It was this lack of native talent which compelled Gustavus frequently to employ the services of foreign adventurers like Berent von Mehlen, John von Hoja, Konrad von Pyhr and others.

It was not the least of Gustavus's many anxieties that he had constantly to be on the watch lest a formidable democratic rival should encroach on his prerogative. That rival was the Swedish peasantry. He succeeded indeed in putting down the four formidable rebellions which convulsed the realm from 1525 to 1542, but the consequent strain upon his resources was very damaging, and more than once he was on the point of abdicating and emigrating, out of sheer weariness. Moreover he was in constant fear of the Danes. Necessity compelled him indeed (1534-1536) to take part in *Greens Fejde* (Counts' War) (see DENMARK: *History*), as the ally of Christian III., but his exaggerated distrust of the Danes was invincible. "We advise and exhort you," he wrote to the governor of Kalmar, "to put no hope of trust in the Danes, or in their sweet scabbling, inasmuch as they mean nothing at all by it except how best they may deceive and betray us Swedes." Such instructions were not calculated to promote confidence between Swedish and Danish negotiators. A fresh cause of dispute was generated in 1548, when Christian III.'s daughter was wedded to Duke Augustus of Saxony. On that occasion, apparently by way of protest against the decree of the diet of Vesterås (15th of January 1544), declaring the Swedish crown hereditary in Gustavus's family, the Danish king caused to be quartered on his daughter's shield not only the three Danish lions and the Norwegian lion with the axe of St. Olaf, but also "the three crowns" of Sweden. Gustavus, naturally suspicious, was much perturbed by the innovation, and warned all his border officials to be watchful and prepare for the worst.

In 1557 he even wrote to the Danish king protesting against the placing of "the three crowns" in the royal Danish seal beneath the arms of Denmark. Christian III. replied that "the three crowns" signified not Sweden in especial, but the three Scandinavian kingdoms, and that their insertion in the Danish shield was only a reminiscence of the union of Kalmar. But Gustavus was not satisfied, and this was the beginning of "the three crowns" dispute which did so much damage to both kingdoms.

The events which led to the rupture of Gustavus with the Holy See are set forth in the proper place (see SWEDEN: *History*). Here it need only be added that it was a purely political act, as Gustavus, personally, had no strong dogmatic leanings either way. He not unnaturally expressed his amazement when that very juvenile reformer Olavus Petri confidently informed him that the pope was antichrist. He consulted the older and graver Laurentius Andreae, who told him how "Doctor Martinus had clipped the wings of the pope, the cardinals and the big bishops," which could not fail to be pleasing intelligence to a monarch who was never an admirer of episcopacy, while the rich revenues of the church, accumulated in the course of centuries, were a tempting object to the impecunious ruler of an impoverished people. Subsequently, when the Protestant hierarchy was forcibly established in Sweden, matters were much complicated by the absolutist tendencies of Gustavus. The incessant labour, the constant anxiety, which were the daily portion of Gustavus Vasa during the seven and thirty years of his reign, told at last even upon his magnificent constitution. In the spring of 1560, conscious of an ominous decline of his powers, Gustavus summoned his last diet, to give an account of his stewardship. On the 16th of June 1560 the assembly met at Stockholm. Ten days later, supported by his sons, Gustavus greeted the estates in the great hall of the palace, when he took a retrospect of his reign, reminding them of the misery of the kingdom during the union and its deliverance from "that unkind tyrant, King Christian." Four days later the diet passed a resolution confirming the hereditary right of Gustavus's son, Prince Eric, to the throne. The old king's last anxieties were now over and he could die in peace. He expired on the 29th of September 1560.

Gustavus was thrice married. His first wife, Catherine, daughter of Magnus I., duke of Saxe-Lauenburg, bore him in 1533 his eldest son Eric. This union was neither long nor happy, but the blame for its infelicity is generally attributed to the lady, whose abnormal character was reflected and accentuated in her unhappy son. Much more fortunate was Gustavus's second marriage, a year after the death of his first consort, with his own countrywoman, Margaret Lejonhufvud, who bore him five sons and five daughters, of whom, three sons, John, Magnus and Charles, and one daughter, Cecilia, survived their childhood. Queen Margaret died in 1551; and a twelvemonth later Gustavus wedded her niece, Catharine Stenbock, a handsome girl of sixteen, who survived him more than sixty years.

Gustavus's outward appearance in the prime of life is thus described by a contemporary: "He was of the middle height, with a round head, light yellow hair, a fine long beard, sharp eyes, a ruddy countenance . . . and a body as fitly and well proportioned as any painter could have painted it. He was of a sanguine-choleric temperament, and when untroubled and unvexed a bright and cheerful gentleman, easy to get on with, and however many people happened to be in the same room with him, he was never at a loss for an answer to every one of them." Learned he was not, but he had naturally bright and clear understanding, an unusually good memory, and a marvellous capacity for taking pains. He was also very devout, and his morals were irreproachable. On the other hand, Gustavus had his full share of the family failings of irritability and suspiciousness, the latter quality becoming almost morbid under the pressure of adverse circumstances. His energy too not infrequently degenerated into violence, and when crossed he was apt to be tyrannical.

See A. Alberg, *Gustavus Vasa and his Times* (London, 1882); R. N. Bain, *Scandinavia*, chaps. iii. and v. (Cambridge, 1905); P. B. Watson, *The Swedish Revolution under Gustavus Vasa* (London, 1889); O. Sjögren, *Gustaf Vasa* (Stockholm, 1896); C. M. Butler,

The Reformation in Sweden (New York, 1882); *Swediges Historia* (Stockholm, 1877-1881); J. Weidling, *Schwedische Geschichte im Zeitalter der Reformation* (Gotha, 1882). (R. N. B.)

GUSTAVUS II. ADOLPHUS (1594-1632), king of Sweden, the eldest son of Charles IX. and of Christina, daughter of Adolphus, duke of Holstein-Gottorp, was born at Stockholm castle on the 9th of December 1594. From the first he was carefully nurtured to be the future prop of Protestantism by his austere parents. Gustavus was well grounded in the classics, and his linguistic accomplishments were extraordinary. He may be said to have grown up with two mother-tongues, Swedish and German; at twelve he had mastered Latin, Italian and Dutch; and he learnt subsequently to express himself in Spanish, Russian and Polish. But his practical father took care that he should grow up a prince, not a pedant. So early as his ninth year he was introduced to public life; at thirteen he received petitions and conversed officially with the foreign ministers; at fifteen he administered his duchy of Westmanland and opened the Örebro diet with a speech from the throne; indeed from 1610 he may be regarded as his father's co-regent. In all martial and chivalrous accomplishments he was already an adept; and when, a year later, he succeeded to supreme power, his superior ability was as uncontested as it was incontestable.

The first act of the young king was to terminate the fratricidal struggle with Denmark by the peace of Knäred (28th of January 1613). Simultaneously, another war, also an heritage from Charles IX., had been proceeding in the far distant regions round lakes Ilmen, Pelpus and Ladoga, with Great Novgorod as its centre. It was not, however, like the Danish War, a national danger, but a political speculation meant to be remunerative and compensatory, and was concluded very advantageously for Sweden by the peace of Stolbova on the 27th of February 1617 (see SWEDEN: *History*). By this peace Gustavus succeeded in excluding Muscovy from the Baltic. "I hope to God," he declared to the Stockholm diet in 1617, when he announced the conclusion of peace, "that the Russians will feel it a bit difficult to skip over that little brook." The war with Poland which Gustavus resumed in 1621 was a much more difficult affair. It began with an attack upon Riga as the first step towards conquering Livonia. Riga was invested on the 13th of August and surrendered on the 15th of September; on the 3rd of October Mitau was occupied; but so great were the ravages of sickness during the campaign that the Swedish army had to be reinforced by no fewer than 10,000 men. A truce was thereupon concluded and hostilities were suspended till the summer of 1623, in the course of which Gustavus took Kokenhusen and invaded Lithuania. In January 1626 he attacked the Poles at Waihof and scattered the whole of their army after a fifth part of it. This victory, remarkable besides as Gustavus's first pitched battle, completed the conquest of Livonia. As, however, it became every year more difficult to support an army in the Dvina district, Gustavus now resolved to transfer the war to the Prussian provinces of Poland with a view to securing the control of the Vistula, as he had already secured the control of the Dvina. At the end of 1626, the Swedish fleet, with 14,000 men on board, anchored in front of the chain of sand-banks which separates the Frische-Haff from the Baltic. Pillau, the only Baltic port then accessible to ships of war, was at once occupied, and Königsberg shortly afterwards was scared into an unconditional neutrality. July was passed in conquering the bishopric of Ermeland. The surrender of Eibing and Marienburg placed Gustavus in possession of the fertile and easily defensible delta of the Vistula, which he treated as a permanent conquest, making Axel Oxenstjerna its first governor-general. Communications between Danzig and the sea were cut off by the erection of the first of Gustavus's famous entrenched camps at Dirschau. From the end of August 1626 the city was blockaded, and in the meantime Polish irregulars, under the capable Stanislaus Koniecpolski, began to harass the Swedes. But the object of the campaign, a convenient basis of operations, was won; and in October the king departed to Sweden to get reinforcements. He returned in May 1627 with 7000 men, which raised his forces to 14,000, against which Koniecpolski

could only oppose 9000. But his superior strategy frustrated all the efforts of the Swedish king, who in the course of the year was twice dangerously wounded and so disabled that he could never wear armour again. Gustavus had made extensive preparations for the ensuing campaign and took the field with 32,000 men. But once again, though far outnumbered, and unsupported by his own government, the Polish grand-hetman proved more than a match for Gustavus, who, on the 10th of September, broke up his camp and returned to Prussia; the whole autumn campaign had proved a failure and cost him 5000 men. During the ensuing campaign of 1629 Gustavus had to contend against the combined forces of Koniecpolski and 10,000 of Wallenstein's mercenaries. The Polish commander now showed the Swedes what he could do with adequate forces. At Stuhm, on the 29th of June, he defeated Gustavus, who lost most of his artillery and narrowly escaped capture. The result of the campaign was the conclusion of the six years' truce of Altmark, which was very advantageous to Sweden.

And now Gustavus turned his attention to Germany. The motives which induced the Swedish king to intervene directly in the Thirty Years' War are told us by himself in his correspondence with Oxenstjerna. Here he says plainly that it was the fear lest the emperor should acquire the Baltic ports and proceed to build up a sea-power dangerous to Scandinavia. For the same reason, the king rejected the chancellor's alternative of waging a simply defensive war against the emperor by means of the fleet, with Stralsund as his base. He was convinced by the experience of Christian IV. of Denmark that the enemies' harbours could be wrested from them only by a successful offensive war on land; and, while quite alive to the risks of such an enterprise in the face of two large armies, Tilly's and Wallenstein's, each of them larger than his own, he argued that the vast extent of territory and the numerous garrisons which the enemy was obliged to maintain, more than neutralized his numerical superiority. Merely to blockade all the German ports with the Swedish fleet was equally impossible. The Swedish fleet was too weak for that; it would be safer to take and fortify the pick of them. In Germany itself, if he once got the upper hand, he would not find himself without resources. It is so enthusiastic a crusader, but an anxious and farseeing if somewhat speculative statesman who thus opens his mind to us. No doubt religious considerations largely influenced Gustavus. He had the deepest sympathy for his fellow-Protestants in Germany; he regarded them as God's peculiar people, himself as their divinely appointed deliverer. But his first duty was to Sweden; and, naturally and rightly, he viewed the whole business from a predominantly Swedish point of view. Lutherans and Calvinists were to be delivered from a "soul-crushing tyranny"; but they were to be delivered by a foreign if friendly power; and that power claimed as her reward the hegemony of Protestant Europe and all the political privileges belonging to that exalted position.

On the 19th of May 1630 Gustavus solemnly took leave of the estates of the realm assembled at Stockholm. He appeared before them holding in his arms his only child and heiress, the little princess Christina, then in her fourth year, and tenderly committed her to the care of his loyal and devoted people. Then he solemnly took the estates to witness, as he stood there "in the sight of the Almighty," that he had begun hostilities "out of no lust for war, as many will certainly devise and imagine," but in self-defence and to deliver his fellow-Christians from oppression. On the 7th of June 1630 the Swedish fleet set sail, and two days after midsummer day, the whole army, 16,000 strong, was disembarked at Peenemünde. Gustavus's plan was to take possession of the mouths of the Oder Haff, and, resting upon Stralsund in the west and Prussia in the east, penetrate into Germany. In those days rivers were what railways now are, the great military routes; and Gustavus's German war was a war waged along river lines. The opening campaign was to be fought along the line of the Oder. Stettin, the capital of Pomerania, and the key of the Oder line, was occupied and converted into a first-class fortress. He then proceeded to clear Pomerania of the piebald imperial host composed of every nationality under

heaven, and officered by Italians, Irishmen, Czechs, Croats, Danes, Spaniards and Walloons. Gustavus's army has often been described by German historians as an army of foreign invaders; in reality it was far more truly Teutonic than the official defenders of Germany at that period. Gustavus's political difficulties (see SWEDEN: *History*) chained him to his camp for the remainder of the year. But the dismissal of Wallenstein and the declaration in Gustavus's favour of Magdeburg, the greatest city in the Lower Saxon Circle, and strategically the strongest fortress of North Germany, encouraged him to advance boldly. But first, honour as well as expediency moved him to attempt to relieve Magdeburg, now closely invested by the imperialists, especially as his hands had now been considerably strengthened by a definite alliance with France (treaty of Bärwalde, 13th of January 1631). Magdeburg, therefore, became the focus of the whole campaign of 1631; but the obstructive timidity of the electors of Brandenburg and Saxony threw insuperable obstacles in his way, and, on the very day when John George I. of Saxony closed his gates against Gustavus the most populous and prosperous city in North Germany became a heap of smoking ruins (20th of May). Gustavus, still too weak to meet the foe, entrenched himself at Werben, at the confluence of the Havel and Elbe. Only on the 12th of September did the elector of Saxony, alarmed for the safety of his own states, now invaded by the emperor, place himself absolutely at the disposal of Gustavus; and, five days later, at the head of the combined Swedish-Saxon army, though the Swedes did all the fighting, Gustavus routed Tilly at the famous battle of Breitenfeld, north of Leipzig.

The question now was: In what way should Gustavus utilize his advantage? Should he invade the Austrian crown lands, and dictate peace to Ferdinand II. at the gates of Vienna? Or should he pursue Tilly westwards and crush the league at its own hearth and home? Oxenstjerna was the first alternative, but Gustavus decided in favour of the second. His decision has been greatly blamed. More than one modern historian has argued that if Gustavus had done in 1631 what Napoleon did in 1805 and 1809, there would have been a fifteen instead of a thirty years' war. But it should be borne in mind that, in the days of Gustavus, Vienna was by no means so essential to the existence of the Habsburg monarchy as it was in the days of Napoleon; and even Gustavus could not allow so dangerous an opponent as Tilly time to recover himself. Accordingly, he set out for the Rhine, taking Marienberg and Frankfort on his way, and on the 20th of December entered Mainz, where he remained throughout the winter of 1631-1632. At the beginning of 1632, in order to bring about the general peace he so earnestly desired, he proposed to take the field with an overwhelming numerical majority. The signal for Gustavus to break up from the Rhine was the sudden advance of Tilly from behind the Danube. Gustavus pursued Tilly into Bavaria, forced the passage of the Danube at Donauwörth and the passage of the Lech, in the face of Tilly's strongly entrenched camp at Rain, and pursued the flying foe to the fortress of Ingolstadt where Tilly died of his wounds a fortnight later. Gustavus then liberated and garrisoned the long-oppressed Protestant cities of Augsburg and Ulm, and in May occupied Munich. The same week Wallenstein chased John George from Prague and manœuvred the Saxons out of Bohemia. Then, armed as he was with plenipotentiary power, he offered the elector of Saxony peace on his own terms. Gustavus suddenly saw himself exposed to extreme peril. If Tilly had made John George such an offer as Wallenstein was now empowered to make, the elector would never have become Gustavus's ally; would he remain Gustavus's ally now? Hastily quitting his quarters in Upper Swabia, Gustavus hastened towards Nuremberg on his way to Saxony, but finding that Wallenstein and Maximilian of Bavaria had united their forces, he abandoned the attempt to reach Saxony, and both armies confronted each other at Nuremberg which furnished Gustavus with a point of support of the first order. He quickly converted the town into an entrenched and fortified camp. Wallenstein followed the king's example, and entrenched himself on the western bank of

the Regnitz in a camp twelve English miles in circumference. His object was to pin Gustavus fast to Nuremberg and cut off his retreat northwards. Throughout July and August the two armies faced each other immovably. On the 24th of August, after an unsuccessful attempt to storm Alte Veste, the key of Wallenstein's position, the Swedish host retired southwards.

Towards the end of October, Wallenstein, after devastating Saxony, was preparing to go into winter quarters at Lützen, when the king surprised him as he was crossing the Rippach (1st of November) and a rearguard action favourable to the Swedes ensued. Indeed, but for nightfall, Wallenstein's scattered forces might have been routed. During the night, however, Wallenstein re-collected his host for a decisive action, and at day-break on the 6th of November, while an autumn mist still lay over the field, the battle began. It was obviously Gustavus's plan to drive Wallenstein away from the Leipzig road, north of which he had posted himself, and thus, in case of success, to isolate, and subsequently, with the aid of the Saxons in the Elbe fortresses, annihilate him. The king, on the Swedish right wing, succeeded in driving the enemy from the trenches and capturing his cannon. What happened after that is mere conjecture, for a thick mist now obscured the autumn sun, and the battle became a colossal mêlée the details of which are indistinguishable. It was in the midst of that awful obscurity that Gustavus met his death—how or where is not absolutely certain; but it would seem that he lost his way in the darkness while leading the Småland horse to the assistance of his infantry, and was despatched as he lay severely wounded on the ground by a hostile horseman.

By his wife, Marie Eleonora, a sister of the elector of Brandenburg, whom he married in 1620, Gustavus Adolphus had one daughter, Christina, who succeeded him on the throne of Sweden.

See *Sveriges Historia* (Stockholm, 1877, 81), vol. iv.; A. Oxenstjerna, *Skrifter och Brefvefning* (Stockholm, 1900, &c.); G. Björles, *Gustaf Adolf* (Stockholm, 1890); R. N. Bain, *Scandinavia* (Cambridge, 1905); C. R. L. Fletcher, *Gustavus Adolphus* (London, 1892); J. L. Stevens, *History of Gustavus Adolphus* (London, 1885); J. Mankell, *Om Gustaf II. Adolfs politik* (Stockholm, 1881); E. Bluenel, *Gustaf Adolf, Kung af Sveden* (Eksjö, 1894); A. Rydberg, *De diplomatiska förbindelserna mellan Sverige och England 1624-1630* (Upsala, 1890). (R. N. B.)

GUSTAVUS III. (1746-1792), king of Sweden, was the eldest son of Adolphus Frederick, king of Sweden, and Louisa Ulrica of Prussia, sister of Frederick the Great, and was born on the 24th of January 1746. Gustavus was educated under the care of two governors who were amongst the most eminent Swedish statesmen of the day, Carl Gustaf Tessin and Carl Scheffer; but he owed most perhaps to the poet and historian Olof von Dalin. The interference of the state with his education, when he was quite a child, was, however, doubly harmful, as his parents taught him to despise the preceptors imposed upon him by the diet, and the atmosphere of intrigue and duplicity in which he grew up made him precociously experienced in the art of dissimulation. But even his most hostile teachers were amazed by the brilliance of his natural gifts, and, while still a boy, he possessed that charm of manner which was to make him so fascinating and so dangerous in later life, coupled with the strong dramatic instinct which won for him his honourable place in Swedish literature. On the whole, Gustavus cannot be said to have been well educated, but he read very widely; there was scarce a French author of his day with whose works he was not intimately acquainted; while his enthusiasm for the new French ideas of enlightenment was as sincere as, if more critical than, his mother's. On the 4th of November 1766, Gustavus married Sophia Magdalena, daughter of Frederick V. of Denmark. The match was an unhappy one, owing partly to incompatibility of temper, but still more to the mischievous interference of the jealous queen-mother.

Gustavus first intervened actively in politics in 1768, at the time of his father's interregnum, when he compelled the dominant Cap faction to summon an extraordinary diet from which he hoped for the reform of the constitution in a monarchical direction. But the victorious Hats refused to redeem the pledges which they had given before the elections. "That we should have lost the

constitutional battle does not distress us so much," wrote Gustavus, in the bitterness of his heart; "but what does dismay me is to see my poor nation so sunk in corruption as to place its own felicity in absolute anarchy." From the 4th of February to the 25th of March 1772, Gustavus was at Paris, where he carried both the court and the city by storm. The poets and the philosophers paid him enthusiastic homage, and all the distinguished women of the day testified to his superlative merits. With many of them he maintained a lifelong correspondence. But his visit to the French capital was no mere pleasure trip; it was also a political mission. Confidential agents from the Swedish court had already prepared the way for him, and the duc de Choiseul, weary of Swedish anarchy, had resolved to discuss with him the best method of bringing about a revolution in Sweden. Before he departed, the French government undertook to pay the outstanding subsidies to Sweden unconditionally, at the rate of one and a half million livres annually; and the comte de Vergennes, one of the great names of French diplomacy, was transferred from Constantinople to Stockholm. On his way home Gustavus paid a short visit to his uncle, Frederick the Great, at Potsdam. Frederick bluntly informed his nephew that, in concert with Russia and Denmark, he had guaranteed the integrity of the existing Swedish constitution, and significantly advised the young monarch to play the part of mediator and abstain from violence.

On his return to Sweden Gustavus made a sincere and earnest attempt to mediate between the Hats and Caps who were ruining the country between them (see SWEDEN: *History*). On the 21st of June 1772 he opened his first parliament in a speech which awakened strange and deep emotions in all who heard it. It was the first time for more than a century that a Swedish king had addressed a Swedish diet from the throne in its native tongue. The orator laid especial stress on the necessity of the sacrifice of all party animosities to the common weal, and volunteered, as "the first citizen of a free people," to be the mediator between the contending factions. A composition committee was actually formed, but it proved illusory from the first, the patriotism of neither of the factions being equal to the pusillanimity of self-denial. The subsequent attempts of the dominant Caps still further to limit the prerogative, and reduce Gustavus to the condition of a *roi fainéant*, induced him at last to consider the possibility of a revolution. Of its necessity there could be no doubt. Under the sway of the Cap faction, Sweden, already the vassal, could not fail to become the prey of Russia. She was on the point of being absorbed in that northern system, the invention of the Russian vice-chancellor, Count Nikita Panin, which that patient statesman had made it the ambition of his life to realize. Only a swift and sudden *coup d'état* could save the independence of a country isolated from the rest of Europe by a hostile league. At this juncture Gustavus was approached by Jakob Magnus Sprengtporten, a Finnish nobleman of determined character, who had incurred the enmity of the Caps, with the project of a revolution. He undertook to seize the fortress of Sveaborg by a *coup de main*, and, Finland once secured, Sprengtporten proposed to embark for Sweden, meet the king and his friends near Stockholm, and surprise the capital by a night attack, when the estates were to be forced, at the point of the bayonet, to accept a new constitution from the untrammelled king. The plotters were at this juncture reinforced by an ex-ranger from Scania (Skåne), Johan Kristoffer Toll, also a victim of Cap oppression. Toll proposed that a second revolt should break out in the province of Scania, to confuse the government still more, and undertook personally to secure the southern fortress of Kristianstad. After some debate, it was finally arranged that, a few days after the Finnish revolt had begun, Kristianstad should openly declare against the government. Prince Charles, the eldest of the king's brothers, was thereupon hastily to mobilize the garrisons of all the southern fortresses, for the ostensible purpose of crushing the revolt at Kristianstad; but on arriving before the fortress he was to make common cause with the rebels, and march upon the capital from the south, while Sprengtporten attacked it simultaneously from the east. On the 6th of August

1772 Toll succeeded, by sheer bluff, in winning the fortress of Kristianstad. On the 16th Sprengtporten succeeded in surprising Sveaborg. But contrary winds prevented him from crossing to Stockholm, and in the meanwhile events had occurred which made his presence there unnecessary.

On the 16th of August the Cap leader, Ture Rudbeck, arrived at Stockholm with the news of the insurrection in the south, and Gustavus found himself isolated in the midst of enemies. Sprengtporten lay weather-bound in Finland, Toll was five hundred miles away, the Hat leaders were in hiding. Gustavus thereupon resolved to strike the decisive blow without waiting for the arrival of Sprengtporten. He acted with military promptitude. On the evening of the 18th all the officers whom he thought he could trust received secret instructions to assemble in the great square facing the arsenal on the following morning. At ten o'clock on the 19th Gustavus mounted his horse and rode straight to the arsenal. On the way his adherents joined him in little groups, as if by accident, so that by the time he reached his destination he had about two hundred officers in his suite. After parade he reconducted them to the guard-room of the palace and unfolded his plans to them. He then dictated a new oath of allegiance, and every one signed it without hesitation. It absolved them from their allegiance to the estates, and bound them solely to obey their lawful king, Gustavus III. Meanwhile the senate and the governor-general, Rudbeck, had been arrested and the fleet secured. Then Gustavus made a tour of the city and was everywhere received by enthusiastic crowds, who hailed him as a deliverer. On the evening of the 20th heralds perambulated the streets proclaiming that the estates were to meet in the Rikssal on the following day; every deputy absenting himself would be regarded as the enemy of his country and his king. On the 21st, a few moments after the estates had assembled, the king in full regalia appeared, and taking his seat on the throne, delivered that famous philippic, one of the masterpieces of Swedish oratory, in which he reproached the estates for their unpatriotic venality and licence in the past. A new constitution was recited by the estates and accepted by them unanimously. The diet was then dissolved.

Gustavus was inspired by a burning enthusiasm for the greatness and welfare of Sweden, and worked in the same reformatory direction as the other contemporary sovereigns of the "age of enlightenment." He took an active part in every department of business, but relied far more on extra-official counsellors of his own choosing than upon the senate. The effort to remedy the frightful corruption which had been fostered by the Hats and Caps engaged a considerable share of his time and he even found it necessary to put the whole of a supreme court of justice (*Göta Hofrätt*) on its trial. Measures were also taken to reform the administration and the whole course of judicial procedure, and torture as an instrument of legal investigation was abolished. In 1774 an ordinance providing for the liberty of the press was even issued. The national defences were at the same time developed on a "Great Power" scale, and the navy was so enlarged as to become one of the most formidable in Europe. The dilapidated finances were set in good order by the "currency realization ordinance" of 1777. Gustavus also introduced new national economic principles. In 1775 free trade in corn was promoted and a number of oppressive export-tolls were abolished. The poor law was also amended, absolute religious liberty was proclaimed, and he even succeeded in inventing and popularizing a national costume which was in general use from 1778 till his death. His one great economic blunder was the attempt to make the sale of spirits a government monopoly, which was an obvious infringement upon the privileges of the estates. His foreign policy, on the other hand, was at first both wise and wary. Thus, when the king summoned the estates to assemble at Stockholm on the 3rd of September 1778, he could give a brilliant account of his six years' stewardship. Never was a parliament more obsequious or a king more gracious. "There was no room for a single No during the whole session." Yet, short as the session was, it was quite long enough to open the eyes of the deputies to the fact that their political supremacy had

departed. They had changed places with the king. He was now indeed their sovereign lord; and, for all his gentleness, the jealousy with which he guarded, the vigour with which he enforced the prerogative, plainly showed that he meant to remain so. Even the few who were patriotic enough to acquiesce in the change by no means liked it. The diet of 1778 had been obsequious; the diet of 1786 was mutinous. The consequence was that nearly all the royal propositions were either rejected outright or so modified that Gustavus himself withdrew them.

The diet of 1786 marks a turning-point in Gustavus's history. Henceforth we observe a determination on his part to rule without a parliament; a passage, cautious and gradual, yet unfinished, from semi-constitutionalism to semi-absolutism. His opportunity came in 1788, when the political complications arising out of his war with Catherine II. of Russia enabled him by the Act of Unity and Security (on the 17th of February 1789) to override the opposition of the rebellious and grossly unpatriotic gentry, and, with the approbation of the three lower estates, establish a new and revolutionary constitution, in which, though the estates still held the power of the purse, the royal authority largely predominated. Throughout 1789 and 1790 Gustavus, in the national interests, gallantly conducted the unequal struggle with Russia, finally winning in the Svenskund (9th-10th July) the most glorious naval victory ever gained by the Swedish arms, the Russians losing one-third of their fleet and 7000 men. A month later, on the 14th of August 1790, peace was signed between Russia and Sweden at Värälä. Only eight months before, Catherine had haughtily declared that "the odious and revoking aggression" of the king of Sweden would be "forgiven" only if he "testified his repentance" by agreeing to a peace granting a general and unlimited amnesty to all his rebels, and consenting to a guarantee by the Swedish diet ("as it would be imprudent to confide in his good faith alone") for the observance of peace in the future. The peace of Värälä saved Sweden from any such humiliating concession, and in October 1791 Gustavus took the bold but by no means imprudent step of concluding an eight years' defensive alliance with the empress, who thereby bound herself to pay her new ally annual subsidies amounting to 300,000 roubles.

Gustavus now aimed at forming a league of princes against the Jacobins, and every other consideration was subordinated thereto. His profound knowledge of popular assemblies enabled him, alone among contemporary sovereigns, accurately to gauge from the first the scope and bearing of the French Revolution. But he was hampered by poverty and the jealousy of the other European Powers, and, after showing once more his unrivalled mastery over masses of men at the brief Gefle diet (22nd of January-24th of February 1792), he fell a victim to a widespread aristocratic conspiracy. Shot in the back by Anckarström at a midnight masquerade at the Stockholm opera-house, on the 16th of March 1792, he expired on the 20th.

Although he may be charged with many foibles and extravagances, Gustavus III. was indisputably one of the greatest sovereigns of the 18th century. Unfortunately his genius never had full scope, and his opportunity came too late. Gustavus was, moreover, a most distinguished author. He may be said to have created the Swedish theatre, and some of the best acting dramas in the literature are by his hand. His historical essays, notably the famous anonymous eulogy on Torstenson crowned by the Academy, are full of feeling and exquisite in style,—his letters to his friends are delightful. Every branch of literature and art interested him, every poet and artist of his day found in him a most liberal and sympathetic protector.

See R. N. Bain, *Gustavus III. and his Contemporaries* (London, 1904); E. G. Geijer, *Konung Gustaf III.'s efterlemnade papper* (Upsala, 1849-1851); C. T. Odhner, *Sveriges politiska historia under Konung Gustaf III.'s regering* (Stockholm, 1885-1895); B. von Beskow, *Om Gustaf III. såsom Konung och människa* (Stockholm, 1860-1861); O. Levrtin, *Gustaf III. som dramatisk författare* (Stockholm, 1894); *Gustaf III.'s bref till G. M. Armfelt* (Fr.) (Stockholm, 1881); Y. K. Grot, *Catherine II. and Gustavus III.* (Russ.) (St Petersburg, 1884). (R. N. B.)

GUSTAVUS IV. (1778-1837), king of Sweden, the son of Gustavus III. and Queen Sophia Magdalena, was born at Stockholm on the 1st of November 1778. Carefully educated under the direction of Nils von Rosenstam, he grew up serious and conscientious. In August 1796 his uncle the regent Charles, duke of Sudermania, visited St Petersburg for the purpose of arranging a marriage between the young king and Catherine II.'s granddaughter, the grand-duchess Alexandra. The betrothal was actually fixed for the 22nd of September, when the whole arrangement foundered on the obstinate refusal of Gustavus to allow his destined bride liberty of worship according to the rites of the Greek Orthodox Church—a rebuff which undoubtedly accelerated the death of the Russian empress. Nobody seems to have even suspected at the time that serious mental derangement lay at the root of Gustavus's abnormal piety. On the contrary, there were many who prematurely congratulated themselves on the fact that Sweden had now no disturbing genius, but an economical, God-fearing, common-place monarch to deal with. Gustavus's prompt dismissal of the generally detested Gustaf Reuterholm added still further to his popularity. On the 31st of October 1797 Gustavus married Frederica Dorothea, daughter of Charles Frederick, grand-duke of Baden, a marriage which might have led to a war with Russia but for the fanatical hatred of the French republic shared by the emperor Paul and Gustavus IV., which served as a bond of union between them. Indeed the king's horror of Jacobinism was morbid in its intensity, and drove him to adopt all sorts of reactionary measures and to postpone his coronation for some years, so as to avoid calling together a diet; but the disorder of the finances, caused partly by the continental war and partly by the almost total failure of the crops in 1798 and 1799, compelled him to summon the estates to Norrköping in March 1800, and on the 3rd of April Gustavus was crowned. The notable change which now took place in Sweden's foreign policy and its fatal consequences to the country are elsewhere set forth (see *Sweden, History*). By the end of 1808 it was obvious to every thinking Swede that the king was insane. His violence had alienated his most faithful supporters, while his obstinate incompetence paralysed the national efforts. To remove a madman by force was the one remaining expedient; and this was successfully accomplished by a conspiracy of officers of the western army, headed by Adlersparre, the Anckarswärds, and Adlercreutz, who marched rapidly from Skåne to Stockholm. On the 13th of March 1809 seven of the conspirators broke into the royal apartments in the palace unannounced, seized the king, and conducted him to the chateau of Gripsholm; Duke Charles was easily persuaded to accept the leadership of a provisional government, which was proclaimed the same day; and a diet, hastily summoned, solemnly approved of the revolution. On the 20th of March Gustavus, in order to save the crown for his son, voluntarily abdicated; but on the 20th of May the estates, dominated by the army, declared that not merely Gustavus but his whole family had forfeited the throne. On the 5th of June the duke regent was proclaimed king under the title of Charles XIII., after accepting the new liberal constitution, which was ratified by the diet the same day. In December Gustavus and his family were transported to Germany. Gustavus now assumed the title of count of Gottorp, but subsequently called himself Colonel Gustafson, under which pseudonym he wrote most of his works. He led, separated from his family, an erratic life for some years; was divorced from his consort in 1812; and finally settled at St Gall in Switzerland in great loneliness and indigence. He died on the 7th of February 1837, and, at the suggestion of King Oscar II. his body was brought to Sweden and interred in the Riddarholmskyrka. From him descend both the Baden and the Oldenburg princely houses on the female side.

See H. G. Trölle-Wachtmeister, *Anteckningar och minnen* (Stockholm, 1889); B. von Beskow, *Lifnadsminnen* (Stockholm, 1870); K. V. Key-Aberg, *De diplomatiska förbindelserna mellan Sverige och Storbritannien under Gustaf IV.'s krig emot Napoleon* (Upsala, 1890); Colonel Gustafson, *Le Journal du prince marié*, &c. (St Gall, 1855); *Memorial des Officiers Gustafsons* (Leipzig, 1829). (R. N. B.)

GUSTAVUS V. (1858-), king of Sweden, son of Oscar II., king of Sweden and Norway, and Queen Sophia Wilhelmina, was

born at Drottningholm on the 16th of June 1622. He entered the army, and was, like his father, a great traveller. As crown prince he held the title of duke of Württemberg. He married in 1681 Victoria (b. 1662), daughter of Frederick William Louis, grand duke of Baden, and of Louise, princess of Prussia. The duchess of Baden was the granddaughter of Sophia, princess of Sweden, and the marriage of the crown prince thus effected a union between the Bernadotte dynasty and the ancient Swedish royal house of Vasa. During the absence or illness of his father Gustavus repeatedly acted as regent, and was therefore already thoroughly versed in public affairs when he succeeded to the Swedish throne on the 3d of December 1707, the crown of Norway having been separated from that of Sweden in 1705. He took as his motto "With the people for the Fatherland."

The crown prince, Oscar Frederick William Gustavus Adolphus, duke of Scania (b. 1882), married in 1905 Princess Margaret of Connaught (b. 1882), niece of King Edward VII. A son was born to them at Stockholm on the 22d of April 1906, and another son in the following year. The king's two younger sons were William, duke of Sudermania (b. 1884), and Eric, duke of Westmanland (b. 1889).

GUSTAVUS ADOLPHUS UNION (GUSTAV-ADOLF-STIFTUNG; GUSTAV-ADOLF-VEREIN, EVANGELISCHER VEREIN DER GUSTAV-ADOLF-STIFTUNG), a society formed of members of the Evangelical Protestant churches of Germany, which has for its object the aid of feeble sister churches, especially in Roman Catholic countries. The project of forming such a society was first broached in connection with the bicentennial celebration of the battle of Lützen on the 6th of November 1822; a proposal to collect funds for a monument to Gustavus Adolphus having been agreed to, it was suggested by Superintendent Grossmann that the best memorial to the great champion of Protestantism would be the formation of a union for propagating his ideas. For some years the society was limited in its area, and its operations, being practically confined to Leipzig and Dresden, but at the Reformation festival in 1841 it received a new impulse through the energy and eloquence of Karl Zimmermann (1803-1877), court preacher at Darmstadt, and in 1845 a general meeting was held at Frankfurt-on-the-Main, where no fewer than twenty-nine branch associations belonging to all parts of Germany except Bavaria and Austria were represented. The want of a positive creed tended to make many of the stricter Protestant churches doubtful of the usefulness of the union, and the stricter Lutherans have always held aloof from it. On the other hand, its negative attitude in relation to Roman Catholicism secured for it the sympathy of the masses. At a general convention held in Berlin in September 1846 a keen dispute arose about the admission of the Königsberg delegate, Julius Rupp (1800-1884), who in 1845 had been deprived for publicly repudiating the Athanasian Creed and became one of the founders of the "Free Congregations"; and at one time it seemed likely that the society would be completely broken up. Amid the political revolutions of the year 1848 the whole movement fell into stagnation; but in 1849 another general convention (the seventh), held at Breslau, showed that, although the society had lost both in membership and income, it was still possessed of considerable vitality. From that date the Gustav-Adolf-Verein has been more definitely "evangelical" in its tone than formerly; and under the direction of Karl Zimmermann it greatly increased both in numbers and in wealth. It has built over 2000 churches and assisted with some two million pounds over 5000 different communities. Apart from its influence in maintaining Protestantism in hostile areas, there can be no doubt that the union has had a great effect in helping the various Protestant churches of Germany to realize the number and importance of their common interests.

See K. Zimmermann, *Geschichte des Gustav-Adolf-Vereins* (Darmstadt, 1877).

GÜSTROW, a town of Germany, in the grand duchy of Mecklenburg-Schwerin, on the Nebel and the railway from Lübeck to Stettin, 20 m. S. of Rostock. Pop. (1875), 10,023; (1905) 17,163. The principal buildings are the castle, erected in the middle of the 16th century and now used as a workhouse;

the cathedral, dating from the 13th century; and restored in 1868, containing many fine monuments and possessing a square tower 100 ft. high; the Pfarrkirche, with fine altar-paintings; the town hall (Rathaus), dating from the 16th century; the music hall, and the theatre. Among the educational establishments are the ducal gymnasium, which possesses a library of 15,000 volumes, a modern and a commercial school. The town is one of the most prosperous in the duchy, and has machine works, foundries, tanneries, sawmills, breweries, distilleries, and manufactories of tobacco, glass, candles and soap. There is also a considerable trade in wool, corn, wood, butter and cattle, and an annual cattle show and horse races are held.

Güstrow, capital of the Mecklenburg duchy of that name, or of the Wind district, was a place of some importance as early as the 12th century, and in 1259 it became the residence of Henry Borwin II., prince of Mecklenburg, from whom it received Schwermia privileges. From 1316 to 1436 the town was the residence of the princes of the Wende, and from 1556 to 1605 of the dukes of Mecklenburg-Güstrow. In 1628 it was occupied by the imperial troops, and Wallenstein resided in it during part of the years 1628 and 1629.

GUTENBERG, JOHANN (c. 1398-1468), German printer, is supposed to have been born c. 1398-1399 at Mainz of well-to-do parents, his father being Friele zum Gebaefisch and his mother Elzgen Wyrlich (or, from her birthplace, zu Gutenberg, the name he adopted). He is assumed to be mentioned under the name of "Hönchen" in a copy of a document of 1420, and again in a document of c. 1427-1428, but it is not stated where he then resided. On January 16, 1430, his mother arranged with the city of Mainz about an annuity belonging to him; but when, in the same year, some families who had been expelled a few years before were permitted to return to Mainz, Gutenberg appears not to have availed himself of the privilege, as he is described in the act of reconciliation (dated March 28) as "not being in Mainz." It is therefore assumed that the family had taken refuge in Strassburg, where Gutenberg was residing later. There he is said to have been in 1434, and to have seized and imprisoned the town clerk of Mainz for a debt due to him by the corporation of that city, releasing him, however, at the representations of the mayor and councillors of Strassburg; and relinquishing at the same time all claims to the money (310 Rhenish guilders = about 2400 mark). Between 1436 and 1439 certain documents

it is difficult to know which of the Gutenberg documents can be trusted and which not. Schorbach, in his recent biography of Gutenberg, accepts and describes 27 of them (*Festschrift*, 1900, p. 163 sqq.), 17 of which are known only from (not always accurate) copies or transcripts. Under ordinary circumstances history might be based on them. But it is certain that some so-called Gutenberg documents, not included in the above 27, are forgeries. Fr. J. Bodmann (1754-1820), for many years professor and librarian at Mainz, forged at least two, one (dated July 20, 1459) he even provided with four forged seals; the other (dated Strassburg, March 24, 1474) purported to be an autograph letter of Gutenberg to a fictitious sister of his named Bertha. Of these two documents French and German texts were published about 1800-1802; the forger lived for twenty years afterwards but never undeceived the public. He enriched the Gutenberg literature with other fabrications; in fact Bodmann had trained himself for counterfeiting MSS. and documents; he openly boasted of his abilities in this respect, and used them, sometimes to amuse his friends who were searching for Gutenberg documents, sometimes for himself to fill up gaps in Gutenberg's life. (For two or three more specimens of his capacities see A. Wyss in *Zeitschr. für Allg. u. Gesch. Schlemens*, xv. 9: sqq.) To one of his friends (Professor Gottlieb Fischer, who preceded him as librarian of Mainz) one or two other fabrications may be ascribed. There are, moreover, serious misgivings as to documents said to have been discovered about 1740 (when the citizens of Strassburg claimed the honour of the invention for their city) by Jacob Wencker (the then archivist of Strassburg) and J. D. Schoepflin (professor and canon of St. Thomas's at Strassburg). For instance, of the above document of 1434 no original has ever come to light; while the draft of the transaction, alleged to have been written at the time in a register of contracts, and to have been found about 1740 by Wencker, has also disappeared with the register itself. The document (now only known from a copy said to have been taken by Wencker from the draft) is upheld as genuine by Schorbach, who favours an invention of printing at Strassburg, but Bockenheimer, though supporting Gutenberg and Mainz, declares it to be a fiction (*Gutenberg-Fest*, Mainz, 1900, pp. 24-33). Again, suspicions are justified

represent him as having been engaged there in some experiments requiring money, with Andreas Dritzehn, a fellow-citizen, who became not only security for him but his partner to carry out Gutenberg's plan for polishing stones and the manufacture of looking-glasses, for which a lucrative sale was expected at the approaching pilgrimage of 1440 (subsequently postponed; according to the documents, although there is no evidence for this postponement) to Aix-la-Chapelle. Money was lent for this purpose by two other friends. In 1438 another partnership was arranged between Gutenberg, Andreas Dritzehn, and Andreas and Anton Heimann, and that this had in view the art of printing has been inferred from the word "drucken" used by one of the witnesses in the law proceedings which soon after followed. An action was brought, after the death of Dritzehn, by his two brothers to force Gutenberg to accept them as partners in their brother's place, but the decision was in favour of the latter. In 1441 Gutenberg became surety to the St Thomas Chapter at Strassburg for Johann Karle, who borrowed 100 guilders (about £16) from the chapter, and on November 17, 1442, he himself borrowed 80 livres through Martin Brechter (or Breiter) from the same chapter. Of his whereabouts from the 12th of March 1444 (when he paid a tax at Strassburg) to the 17th of October 1448 nothing certain is known. But on the latter date we find him at Mainz, borrowing 150 gold guilders of his kinsman, Arnold Gelthus, against an annual interest of 7½ gold guilders. We do not know whether the interest on this debt has ever been paid, but the debt itself appears never to have been paid off, as the contract of this loan was renewed (*vidimus*) on August 23, 1503, for other parties. It is supposed that soon afterwards Gutenberg must have been able to show some convincing results of his work, for it appears that about 1450 Johann Fust (*q.v.*) advanced him 800 guilders to promote it, on no security except that of "tools" still to be made. Fust seems also to have undertaken to advance him 300 guilders a year for expenses, wages, house-rent, parchment, paper, ink, &c., but he does not appear to have ever done so. If at any time they disagreed, Gutenberg was to return the 800 guilders, and the "tools" were to cease to be security. It is not known to what purpose Gutenberg devoted the money advanced to him. In the minutes of the law-suit of 1455 he himself says that he had to make his "tools" with it. But he is presumed to have begun a large folio Latin Bible, and to have printed during its progress some smaller books¹ and likewise the Letter of Indulgence (granted on the 12th of April 1451 by Pope Nicholas V. in aid of John II., king of Cyprus, against the Turks), of 31 lines, having the earliest printed date 1454, of which several copies are preserved in various European libraries. A copy of the 1455 issue of the same Indulgence is in the Rylands Library at Manchester (from the Althorp Library).

It is not known whether any books were printed while this partnership between Gutenberg and Fust lasted. Trithemius (*Ann. Hirsang.* ii. 421) says they first printed, from wooden

with respect to the documents recording Gutenberg's lawsuit of 1439 at Strassburg. Bockenheim explains at great length (*l.c.* pp. 41-72) that they are forgeries. He even explains (*ibid.* pp. 97-107) that the so-called Helmsperger document of November 6, 1455, may be a fabrication of the Faust von Aschaffenburg family, who endeavoured to claim Johann Faust as their ancestor. There are also (1) a fragment of a fictitious "press," said to have been constructed by Gutenberg in 1441, and to have been discovered (1) at Mainz in 1846; (2) a forged imprint with the date 1458 in a copy of Pope Gregory's *Dialogues*, really printed at Strassburg about 1470; (3) a forged rubric in a copy of the *Tractatus de celebratione missarum*, from which it would appear that Johann Gutenberg and Johann Nummeiner had presented it on June 19, 1463, to the Carthusian monastery near Mainz; (4) four forged copies of the Indulgence of 1455, in the Culemann Collection in the Kätner Museum at Hanover, &c. (see further, Hensel, "The so-called Gutenberg Documents," in *The Library*, 1909).

¹ Among these were perhaps (1) one or two editions of the work of Donatus, *De octo partibus orationis*, 27 lines to a page, of one of which two leaves, now in the Paris National Library, were discovered at Mainz in the original binding of an account book, one of them having, but in a later hand, the year 1451 (?); (2) the *Türk-Kalendar* for 1455 (preserved in the Hof-Bibliothek at Munich); (3) the *Cissianus* (preserved in the Cambridge Univ. Libr.), and perhaps others now lost.

blocks, a vocabulary called *Catholicon*, which cannot have been the *Catholicon* of Johannes de Janua, a folio of 748 pages in two columns of 66 lines each, printed in 1460, but was perhaps a small glossary now lost.² The Latin *Bible of 42 lines*, a folio of 1282 printed pages, in two columns with spaces left for illuminated initials (so called because each column contains 42 lines, and also known as the *Maurus Bible*, because the first copy described was found in the library of Cardinal Mazarin), was finished before the 15th of August 1456;³ German bibliographers now claim this Bible for Gutenberg, but, according to bibliographical rules, it must be ascribed to Peter Schöffer, perhaps in partnership with Fust. It is in smaller type than the *Bible of 36 lines*, which letter is called either (a) the *Bamberg Bible*, because nearly all the known copies were found in the neighbourhood of Bamberg, or (b) *Scheldhorn's Bible*, because J. G. Schelhorn was the first who described it in 1760, or (c) *Pfister's Bible*, because its printing is ascribed to Albrecht Pfister of Bamberg, who used the same type for several small German books, the chief of which is Böhmer's *Erdstein* (1461, 4to), 88 leaves, with 85 woodcuts, a book of Tables in German rhyme. Some bibliographers believe this 36-line Bible to have been begun, if not entirely printed, by Gutenberg during his partnership with Fust, as its type occurs in the 31-line Letters of Indulgence of 1454, was used for the 37-line Donatus (of 1457?), and, finally, when found in Pfister's possession in 1461, appears to be old and worn, except the additional letters k, w, s required for German, which are clear and sharp like the types used in the Bible. Again, others profess to prove (Dziatzko, *Gutenberg's früheste Druckerpraxis*) that B² was a reprint of B¹.

Gutenberg's work, whatever it may have been, was not a commercial success, and in 1455 Fust had to come forward with another 800 guilders to prevent a collapse. But some time before November 1455 the latter demanded repayment of his advances (see the Helmsperger Notarial Document of November 6, 1455, in Dziatzko's *Beiträge zur Gutenbergfrage*, Berlin, 1889), and took legal proceedings against Gutenberg. We do not know the end of these proceedings, but if Gutenberg had prepared any printing materials it would seem that he was compelled to yield up the whole of them to Fust; that the latter removed them to his own house at Mainz, and there, with the assistance of Peter Schöffer, issued various books until the sack of the city in 1462 by Adolphus II. caused a suspension of printing for three years, to be resumed again in 1465.

We have no information as to Gutenberg's activity, and very little of his whereabouts, after his separation from Fust. In a document dated June 21, 1457, he appears as witness on behalf of one of his relatives, which shows that he was then still at Mainz. Entries in the registers of the St Thomas Church at Strassburg make it clear that the annual interest on the money which Gutenberg on the 17th of November 1442 (see above) had borrowed from the chapter of that church was regularly paid till the 11th of November 1457, either by himself or by his

² Ulrich Zell states, in the Cologne Chronicle of 1499, that Gutenberg and Fust printed a Bible in large type like that used in missals. It has been said that this description applies to the 42-line Bible, as its type is as large as that of most missals printed before 1500, and that the size now called missal type (double pica) was not used in missals until late in the 16th century. This is no doubt true of the smaller missals printed before 1500, some of which are in even smaller type than the 42-line Bible. But many of the large folio missals, as that printed at Mainz by Peter Schöffer in 1483, the Carthusian missal printed at Spire by Peter Drach about 1490, and the Dominican missal printed by Andrea de Torresanis at Venice in 1496, are in as large type as the 36-line Bible. Peter Schöffer (1425-1502) of Gernsbach, between Mainz and Mannheim, who was a copyist in Paris in 1449, and whom Fust called his servant (*famulus*), is said by Trithemius to have discovered an easier way of founding characters, whence Lambinet and others concluded that Schöffer invented the punch. Schöffer himself, in the colophon of the Psalter of 1457, a work which some suppose to have been planned and partly printed by Gutenberg, claims only the mode of printing rubrics and coloured capitals.

³ The Leipzig copy of this Bible (which formerly belonged to Herr Klemm of Dresden) has at the end the M.S. year 1453 in old Arabic numerals. But certain circumstances connected with this date make it look very suspicious.

surely, Martin Brechter. But the payment due on the latter date appears to have been delayed, as an entry in the register of that year shows that the chapter had incurred expenses in taking steps to have both Gutenberg and Brechter arrested. This time the difficulties seem to have been removed, but on and after the 11th of November 1458 Gutenberg and Brechter remained in default. The chapter made various efforts, all recorded in their registers, to get their money, but in vain. Every year they recorded the arrears with the expenses to which they were put in their efforts to arrest the defaulters, till at last in 1474 (six years after Gutenberg's death) their names are no longer mentioned.

Meantime Gutenberg appears to have been printing, as we learn from a document dated February 26, 1468, that a syndic of Mainz, Dr Conrad Homery (who had formerly been in the service of the elector Count Diether of Ysenburg), had at one time supplied him, not with money, but with some formes, types, tools, implements and other things belonging to printing, which Gutenberg had left after his death, and which had, and still, belonged to him (Homery); this material had come into the hands of Adolf, the archbishop of Mainz, who handed or sent it back to Homery, the latter undertaking to use it in no other town but Mainz, nor to sell it to any person except a citizen of Mainz, even if a stranger should offer him a higher price for the things: This material has never yet been identified, so that we do not know what types Gutenberg may have had at his disposal; they could hardly have included the types of the *Catholicon* of 1460, as is suggested, this work being probably executed by Heinrich Bechtermünze (d. 1467), who afterwards removed to Eltville, or perhaps by Peter Schöffer, who, about 1470, advertises the book as his property (see K. Burger, *Buchhändler-Anzeigen*). It is uncertain whether Gutenberg remained in Mainz or removed to the neighbouring town of Eltville, where he may have been engaged for a while with the brothers Bechtermünze, who printed there for some time with the types of the 1460 *Catholicon*. On the 17th of January 1469 he accepted the post of salaried courtier from the archbishop Adolf, and in this capacity received annually a suit of livery together with a fixed allowance of oven and wine. Gutenberg seems to have died at Mainz at the beginning of 1468, and was, according to tradition, buried in the Franciscan church in that city. His relative Arnold Gehlius erected a monument to his memory near his supposed grave, and forty years afterwards Ivo Wittig set up a memorial tablet at the legal college at Mainz. No books bearing the name of Gutenberg as printer are known; nor is any genuine portrait of him known, those appearing upon medals, statues or engraved plates being all fictions.

In 1808 the firm of L. Rosenthal, at Munich, acquired a *Missale speciale* on paper, which Otto Hupp, in two treatises published in 1808 and 1902, asserts to have been printed by Gutenberg about 1450, seven years before the 1457 Psalter. Various German bibliographers, however, think that it could not have been printed before 1480, and, judging from the facsimiles published by Hupp, this date seems to be approximately correct.

On the 24th of June 1900 the five-hundredth anniversary of Gutenberg's birth was celebrated in several German cities, notably in Mainz and Leipzig, and most of the recent literature on the invention of printing dates from that time.

So we may note that in 1902 a vellum fragment of an Astronomical Calendar was discovered by the librarian of Wiesbaden, Dr G. Zedler (*Die älteste Gutenbergtype*, Mainz, 1902), apparently printed in the 36-line Bible type, and as the position of the sun, moon and other planets described in this document suits the years 1420, 1448 and 1467, he ascribes the printing of this Calendar to the year 1447. A paper fragment of a poem in German, entitled *Weltgericht*, said to be printed in the 36-line Bible type, appears to have come into the possession of Herr Eduard Beck at Mainz in 1892, and was presented by him in 1903 to the Gutenberg Museum in that city. Zedler published a facsimile of it in 1904 (for the *Gutenberg Gesellschaft*), with a description, in which he places it before the 1447 Calendar,

c. 1444-1447. Moreover, fragments of two editions of Donatus' different from that of 1451 (?) have recently been found; see Schwenke in *Centraltbl. für Bibliothekswesen* (1908).

The recent literature upon Gutenberg's life and work and early printing in general includes the following: A. von der Liade, *Geschichte und Erfindung* (Stuttgart, 1878); *id. Geschichte der Buchdruckerkunst* (Berlin, 1886); J. H. Hessels, *Gutenberg, Was he the Inventor of Printing?* (London, 1882); *id. Haarlem, the Birthplace of Printing, and Mainz* (London, 1886); O. Hartwig, *Festschrift zum fünfzigjährigen Geburtstag von Johann Gutenberg* (Leipzig, 1900), which includes various treatises by Schenk zu Schwalbberg, K. Schorbach, &c.; P. Schwenke, *Untersuchungen zur Geschichte des ersten Buchdrucks* (Berlin, 1900); A. Börckel, *Gutenberg, sein Leben, &c.* (Gießen, 1897); *id. Gutenberg und seine berühmten Nachfolger im ersten Jahrhundert der Typographie* (Frankfurt, 1900); F. Schneider, *Mainz und seine Drucker* (1900); G. Zedler, *Gutenberg-Forschungen* (Leipzig, 1901); J. H. Hessels, *The so-called Gutenberg Documents* (London, 1910). For other works on the subject see **TYPOGRAPHY**, (J. H. H.).

GÜTERSLOH, a town of Germany, in the Prussian province of Westphalia, 11 m. S.W. from Bielefeld by the railway to Dortmund. Pop. (1905), 7375. It is a seat of silk and cotton industries, and has a large trade in Westphalian hams and sausages. Printing, brewing and distilling are also carried on, and the town is famous for its rye-bread (*Pumpernickel*). Gütersloh has two Evangelical churches, a Roman Catholic church, a synagogue, a school and other educational establishments.

See Eickhoff, *Geschichte der Stadt und Gemeinde Gütersloh* (Gütersloh, 1904).

GUTHRIE, SIR JAMES (1859—), Scottish painter, and one of the leaders of the so-called Glasgow school of painters, was born at Greenock. Though in his youth he was influenced by John Pettie in London, and subsequently studied in Paris, his style, which is remarkable for grasp of character, breadth and spontaneity, is due to the lessons taught him by observation of nature, and to the example of Crawhall, by which he benefited in Lincolnshire in the early 'eighties of the last century. In his early works, such as "The Gipsy Fires are Burning, for Daylight is Past and Gone" (1882), and the "Funeral Service in the Highlands," he favoured a thick impasto, but with growing experience he used his colour with greater economy and reticence. Subsequently he devoted himself almost exclusively to portraiture. Sir James Guthrie, like so many of the Glasgow artists, achieved his first successes on the Continent, but soon found recognition in his native country. He was elected associate of the Royal Scottish Academy in 1888, and full member in 1892, succeeded Sir George Reid as president of the Royal Scottish Academy in 1902, and was knighted in 1903. His painting "Schoolmates" is at the Ghent Gallery. Among his most successful portraits are those of his mother, Mr R. Garroway, Major Hotchkiss, Mrs. Fergus, Professor Jack, and Mrs. Watson.

GUTHRIE, THOMAS (1803-1873), Scottish divine, was born at Brechin, Forfarshire, on the 12th of July 1803. He entered the university of Edinburgh at the early age of twelve, and continued to attend classes there for more than ten years. On the 2nd of February 1825 the presbytery of Brechin licensed him as a preacher in connexion with the Church of Scotland, and in 1826 he was in Paris studying natural philosophy, chemistry, and comparative anatomy. For two years he acted as manager of his father's bank, and in 1830 was inducted to his first charge, Arbriot, in Forfarshire, where he adopted a vivid dramatic style of preaching adapted to his congregation of peasants, farmers and weavers. In 1837 he became the colleague of John Sym in the pastorate of Old Greyfriars, Edinburgh, and at once attracted notice as a great pulpit orator. Towards the close of 1840 he became minister of St John's church, Victoria Street, Edinburgh. He declined invitations both from London and from India. He was an enthusiastic supporter of the movement which led to the Disruption of 1843; and his name is thenceforth associated with the Free Church, for which he collected £126,000 from July 1845 to June 1846 to provide manses for the seceding ministers. In 1844 he became a teetotaler. In 1847 he began the greatest work of his life by the publication of his first "Plea for Ragged Schools." This

pamphlet elicited a beautiful and sympathetic letter from Lord Jeffrey. A Ragged School was opened on the Castle Hill, which has been the parent of many similar institutions elsewhere, though Guthrie's relation to the movement is best described as that of an apostle rather than a founder. He insisted on bringing up all the children in his school as Protestants; and he thus made his schools proselytizing as well as educational institutions. This interference with religious liberty led to some controversy; and ultimately those who differed from Guthrie founded the United Industrial School, giving combined secular and separate religious instruction. In April 1847 the degree of D.D. was conferred on Guthrie by the university of Edinburgh; and in 1850 William Hanna (1808-1882), the biographer and son-in-law of Thomas Chalmers, was inducted as his colleague in Free St John's Church.

In 1850 Guthrie published *A Plea on behalf of Drunkards and against Drunkenness*, which was followed by *The Gospel in Ezekiel* (1853); *The City: its Sins and Sorrows* (1857); *Christ and the Inheritance of the Saints* (1858); *Seedtime and Harvest of Ragged Schools* (1860), consisting of his three *Pleas for Ragged Schools*. These works had an enormous sale, and portions of them were translated into French and Dutch. His advocacy of temperance had much to do with securing the passing of the Forbes Mackenzie Act, which secured Sunday closing and shortened hours of sale for Scotland. Mr Gladstone specially quoted him in support of the Light Wines Bill (1860). In 1862 he was moderator of the Free Church General Assembly; but he seldom took a prominent part in the business of the church courts. His remarkable oratorical talents, rich humour, genuine pathos and inimitable power of story-telling, enabled him to do good service to the total abstinence movement. He was one of the vice-presidents of the Evangelical Alliance. In 1864, his health being seriously impaired, he resigned public work as pastor of Free St John's (May 17), although his nominal co-operation with the congregation ceased only with his death. Guthrie had occasionally contributed papers to *Good Words*, and, about the time of his retirement from the ministry, he became first editor of the *Sunday Magazine*, himself contributing several series of papers which were afterwards published separately. In 1865 he was presented with £1000 as a mark of appreciation from the public. His closing years were spent mostly in retirement; and after an illness of several months' duration he died at St Leonards-on-Sea on the 24th of February 1873.

In addition to the books mentioned above he published a number of books which had a remarkable circulation in England and America, such as *Speaking in the Heart* (1862); *The Way to Life* (1862); *Man and the Gospel* (1863); *The Angel's Song* (1865); *The Parables* (1866); *Our Father's Business* (1867); *Out of Harass* (1867); *Early Faith* (1868); *Studies of Character from the Old Testament* (1868-1870); *Sundays Abroad* (1871).

See *Autobiography of Thomas Guthrie, D.D.*, and *Memoir*, by his son (2 vols., London, 1874-1875).

GUTHRIE, THOMAS ANSTEEY (1856-), known by the pseudonym of F. Anstey, English novelist, was born in Kensington, London, on the 8th of August 1856. He was educated at King's College, London, and at Trinity Hall, Cambridge, and was called to the bar in 1880. But the popular success of his story *Vice-Versa* (1882) with its topsy-turvy substitution of a father for his schoolboy son, at once made his reputation as a humorist of an original type. He published in 1883 a serious novel, *The Giant's Robe*; but, in spite of its excellence, he discovered (and again in 1889 with *The Pariah*) that it was not as a serious novelist but as a humorist that the public insisted on regarding him. As such his reputation was further confirmed by *The Black Poodle* (1884), *The Tinted Venus* (1885), *A Fallen Idol* (1886), and other works. He became an important member of the staff of *Punch*, in which his "Voices populi" and his humorous parodies of a reciter's stock-piece ("Burglar Bill," &c.) represent his best work. In 1901 his successful farce *The Man from Blankley's*, based on a story which originally appeared in *Punch*, was first produced at the Prince of Wales's Theatre, in London.

GUTHRIE, the capital of Oklahoma, U.S.A., and the county-seat of Logan county, extending on both sides of Cottonwood

creek, and lying one mile south of the Cimarron river. Pop. (1890) 5333, (1900) 10,006, (1907) 11,652 (28% negroes); (1910) 11,654. It is served by the Atchison, Topoka & Santa Fé, the Chicago, Rock Island & Pacific, the Missouri, Kansas & Texas, the Fort Smith & Western, and the St Louis, El Reno & Western railways. The city is situated about 940 ft. above the sea, in a prairie region devoted largely to stock-raising and the cultivation of Indian corn, wheat, cotton and various fruits, particularly peaches. Guthrie is one of the headquarters of the Federal courts in the state, the other being Muskogee. The principal public buildings at Guthrie are the state Capitol, the Federal building, the City hall, the Carnegie library, the Methodist hospital and a large Masonic temple. Among the schools are St Joseph's Academy and a state school for the deaf and dumb. Guthrie has a considerable trade with the surrounding country and has cotton gins, a cotton compress, and foundries and machine shops; among its manufactures are cotton-seed oil, cotton goods, flour, cereals, lumber, cigars, brooms and furniture. The total value of the factory product in 1905 was \$2,100,662. The municipality owns and operates the water-works. The city was founded in 1880, when Oklahoma was opened for settlement; in 1890 it was made the capital of the Territory, and in 1907 when Oklahoma was made a state, it became the state capital.

GUTHRUM (GOORUM) (d. 890), king of East Anglia, first appears in the *English Annals* in the year 875, when he is mentioned as one of three Danish kings who went with the host to Cambridge. He was probably engaged in the campaigns of the next three years, and after Alfred's victory at Edington in 878, Guthrum met the king at Aller in Somersetshire and was baptized there under the name of Æthelstan. He stayed there for twelve days and was greatly honoured by his godfather Alfred. In 890 Guthrum-Æthelstan died: he is then spoken of as "se norðerna cyning" (probably "the Norwegian king," referring to the ultimate origin of his family, and we are told that he was the first (Scandinavian) to settle East Anglia. Guthrum is perhaps to be identified with Gormr (= Guthrum) hinn heimski or hinn ríki of the Scandinavian sagas, the foster-father of Hörðakautr, the father of Gormr the old. There is a treaty known as the peace of Alfred and Guthrum.

GUTSCHMID, ALFRED; BARON VON (1835-1887), German historian and Orientalist, was born on the 1st of July at Loschwitz (Dresden). After holding chairs at Kiel (1866), Königsberg (1873), and Jena (1876), he was finally appointed professor of history at Tübingen, where he died on the 2nd of March 1887. He devoted himself to the study of Eastern language and history in its pre-Greek and Hellenistic periods and contributed largely to the literature of the subject.

WORKS.—*Über die Fragmente des Pompeius Trogus* (supplementary vol. of *Jahrbücher für klass. Phil.*, 1857); *Die makedonische Anagraphe* (1864); *Beiträge zur Gesch. des alten Orients* (Leipzig, 1858); *Neue Beiträge zur Gesch. des alt. Or.*, vol. i. *Die Assyriologie in Deutschland* (Leipzig, 1876); *Die Glaubwürdigkeit der armenischen Gesch. des Monats Xheren* (1877); *Untersuchungen über die syrische Epitome des eusebischen Canonis* (1886); *Untersuch. über die Gesch. des Königreichs Osroene* (1887); *Gesch. Irans* (Alexander the Great to the fall of the Arsacidae) (Tübingen, 1887). He wrote on Persia and Phoenicia in the 9th edition of the *Encyc. Brit.* A collection of minor works entitled *Kleine Schriften* was published by F. Röhl at Leipzig (1899-1904; 5 vols.), with complete list of his writings. See article by Röhl in *Allgemeine deutsche Biographie*, xlix. (1904).

GUTS-MUTHS, JOHANN CHRISTOPH FRIEDRICH (1750-1839), German teacher and the principal founder of the German school system of gymnastics, was born at Quedlinburg on the 9th of August 1750. He was educated at the gymnasium of his native town and at Halle University; and in 1785 he went to Schnepfenthal, where he taught geography and gymnastics. His method of teaching gymnastics was expounded by him in various handbooks; and it was chiefly through them that gymnastics very soon came to occupy such an important position in the school system of Germany. He also did much to introduce a better method of instruction in geography. He died on the 21st of May 1839.

His principal works are *Gymnastik für die Jugend* (1793); *Spiele zur Übung und Erholung des Körpers und Geistes für die Jugend* (1796); *Turnbuch* (1817); *Handbuch der Geographie* (1810); and a number of books constituting a *Bibliothek für Pädagogik, Schullehrer, und die gesammte pädagogische Literatur Deutschlands*. He also contributed to the *Vollständiges Handbuch der neuesten Erdbeschreibung*, and along with Jacobi published *Deutsches Land und deutsches Volk*, the first part, *Deutsches Land*, being written by him.

GUTTA (Latin for "drop"), an architectural term given to the small frusta of conical or cylindrical form carved below the triglyph and under the regula of the entablature of the Doric Order. They are sometimes known as "trunnels," a corruption of "tree-nail," and resemble the wooden pins which in framed timber work or in joinery are employed to fasten together the pieces of wood; these are supposed to be derived from the original timber construction of the Doric temple, in which the pins, driven through the regula, secured the latter to the taenia, and, according to C. Chippiez and F. A. Choisy, passed through the taenia to hold the triglyphs in place. In the earliest examples of the Doric Order at Corinth and Selinus, the guttae are completely isolated from the architrave, and in Temple C at Selinus the guttae are 3 or 4 in. in front of it, as if to enable the pin to be driven in more easily. In later examples they are partly attached to the architrave. Similar guttae are carved under the mutules of the Doric cornice, representing the pins driven through the mutules to secure the rafters. In the temples at Bassae, Paestum and Selinus, instances have been found where the guttae had been carved separately and sunk into holes cut in the soffit of the mutules and the regula. Their constant employment in the Doric temples suggests that, although originally of constructive origin, they were subsequently employed as decorative features.

GUTTA PERCHA, the name applied to the evaporated milky fluid or latex furnished by several trees chiefly found in the islands of the Malay Archipelago. The name is derived from two Malay words, *getah* meaning gum, and *percha* being the name of the tree—probably a *Bassia*—from which the gum was (erroneously) supposed to be obtained.

Botanical Origin and Distribution.—The actual tree is known to the Malays as *laban*, and the product as *getah laban*. The best gutta percha of Malaya is chiefly derived from two trees, and is known as *getah laban merah* (red) or *getah laban sutra* (silky). The trees in question, which belong to the natural order Sapotaceae, have now been definitely identified, the first as *Dichopsis gutta* (Bentham and Hooker), otherwise *Isonandra gutta* (Hooker) or *Palaquium gutta* (Burck), and the second as *Dichopsis oblongifolia* (Burck). Allied trees of the same genus and of the same natural order yield similar but usually inferior products. Among them may be mentioned species of *Paysona* (*getah suandie*).

Gutta percha trees often attain a height of 70 to 100 ft. and the trunk has a diameter of from 2 to 3 ft. They are stated to be mature when about thirty years old. The leaves of *Dichopsis*, which are obovate-lanceolate, with a distinct pointed apex, occur in clusters at the end of the branches, and are bright green and smooth on the upper surface but on the lower surface are yellowish-brown and covered with silky hairs. The leaves are usually about 6 in. long and about 2 in. wide at the centre. The flowers are white, and the seeds are contained in an ovoid berry about 1 in. long.

The geographical distribution of the gutta percha tree is almost entirely confined to the Malay Peninsula and its immediate neighbourhood. It includes a region within 6 degrees north and south of the equator and 95°–110° longitude, where the temperature ranges from 66° to 90° F. and the atmosphere is exceedingly moist. The trees may be grown from seeds or from cuttings. Some planting has taken place in Malaya, but little has so far been done to acclimatize the plant in other regions. Recent information seems to point to the possibility of growing the tree in Ceylon and on the west coast of Africa.

Preparation of Gutta Percha.—The gutta is furnished by the greyish milky fluid known as the latex, which is chiefly secreted in cylindrical vessels or cells situated in the cortex, that is, between the bark and the wood (or cambium). Latex also

occurs in the leaves of the tree to the extent of about 9% of the dried leaves, and this may be removed from the powdered leaves by the use of appropriate solvents, but the process is not practicable commercially. The latex flows slowly where an incision is made through the bark, but not nearly so freely, even in the rainy season, as the india-rubber latex. On this account the Malays usually fell the tree in order to collect the latex, which is done by chopping off the branches and removing circles of the bark, forming cylindrical channels about an inch wide at various points about a foot apart down the trunk. The latex exudes and fills these channels, from which it is removed and converted into gutta by boiling in open vessels over wood fires. The work is usually carried on in the wet season when the latex is more fluid and more abundant. Sometimes when the latex is thick water is added to it before boiling.

The best results are said to be obtained from mature trees about thirty years old, which furnish about 2 to 3 lb of gutta. Older trees do not appear to yield larger amounts of gutta, whilst younger trees are said to furnish less and of inferior quality. The trees have been so extensively felled for the gutta that there has been a great diminution in the total number during recent years, which has not been compensated for by the new plantations which have been established.

Uses of Gutta Percha.—The Chinese and Malays appear to have been acquainted with the characteristic property of gutta percha of softening in warm water and of regaining its hardness when cold, but this plastic property seems to have been only utilized for ornamental purposes, the construction of walking-sticks and of knife handles and whips, &c.

The brothers Tradescant brought samples of the curious material to Europe about the middle of the 17th century. It was then regarded as a form of wood, to which the name of "mazer" wood was given on account of its employment in making mazers or goblets. A description of it is given in a book, published by John Tradescant in 1656 entitled *Museum Tradescantianum or a Collection of Rarities preserved at South Lambeth near London*. Many of the curiosities collected from all parts of the world by the Tradescants subsequently formed the nucleus of the Ashmolean Museum at Oxford which was opened in 1683, but the specimen of "mazer wood" no longer exists.

In 1843 samples of the material were sent to London by Dr William Montgomerie of Singapore, and were exhibited at the Society of Arts, and in the same year Dr José d'Almeida sent samples to the Royal Asiatic Society. Gutta percha was also exhibited at the Great Exhibition of 1857.

Dr Montgomerie's communication to the Society of Arts led to many experiments being made with the material. Casts of medals were successfully produced, and Sir William Siemens, in conjunction with Werner von Siemens, then made the first experiments with the material as an insulating covering for cables and telegraph wires, which led to the discovery of its important applications in this connexion and to a considerable commercial demand for the substance.

The value of gutta percha depends chiefly on its quality, that is its richness in true gutta and freedom from resin and other impurities which interfere with its physical characters, and especially its insulating power or inability to conduct electricity.

The chief use of gutta percha is now for electrical purposes. Other minor uses are in dentistry and as a means of taking impressions of medals, &c. It has also found application in the preparation of belting for machinery, as well as for the construction of the handles of knives and surgical instruments, whilst the inferior qualities are used for waterproofing.

Commercial Production.—The amount of gutta percha exported through Singapore from British and Dutch possessions in the East is subject to considerable fluctuation, depending chiefly on the demand for cable and telegraph construction. In 1886 the total export from Singapore was 40,411 cwt., of which Great Britain took 31,666 cwt.; in 1896 the export was 51,982 cwt. of which 29,722 cwt. came to Great Britain; while in 1905, 42,688 cwt. were exported (19,517 cwt. to Great Britain). It has to be remembered that the official returns include not only

gutta percha of various grades of quality but also other inferior products sold under the name of gutta percha, some of which are referred to below under the head of substitutes. The value of gutta percha cannot therefore be correctly gauged from the value of the imports. In the ten years 1896-1906 the best qualities of gutta percha fetched from 4s. to about 7s. per lb. Gutta percha, however, is used for few and special purposes, and there is no free market, the price being chiefly a matter of arrangement between the chief producers and consumers.

Characters and Properties.—Gutta percha appears in commerce in the form of blocks or cakes of a dirty grayish appearance, often exhibiting a reddish tinge, and just soft enough to be indented by the nail. It is subject to considerable adulteration, various materials, such as coco-nut oil, being added by the Malays to improve its appearance. The solid, which is fibrous in texture, hard and inelastic but not brittle at ordinary temperature, becomes plastic when immersed in hot water or if otherwise raised to a temperature of about 65°-66° C. in the case of gutta of the first quality, the temperature of softening being dependent on the quality of the gutta employed. In this condition it can be drawn out into threads, but is still inelastic. On cooling again the gutta resumes its hardness without becoming brittle. In this respect gutta percha differs from india-rubber or caoutchouc, which does not become plastic and unlike gutta percha is elastic. This property of softening on heating and solidifying when cooled again, without change in its original properties, enables gutta percha to be worked into various forms, rolled into sheets or drawn into ropes. The specific gravity of the best gutta percha lies between 0.96 and 1. Gutta percha is not dissolved by most liquids, although some remove resinous constituents; the best solvents are oil of turpentine, coal-tar oil, carbon bisulphide and chloroform, and light petroleum when hot. Gutta percha is not affected by alkaline solutions or by dilute acids. Strong sulphuric acid chars it when warm, and nitric acid effects complete oxidation.

When exposed to air and light, gutta percha rapidly deteriorates, oxygen being absorbed, producing a brittle resinous material.

Chemical Composition.—Chemically, gutta percha is not a single substance but a mixture of several constituents. As the proportions of these constituents in the crude material are not constant, the properties of gutta percha are subject to variation. For electrical purposes it should have a high insulating power and dielectric strength and a low inductive capacity; the possession of these properties is influenced by the resinous constituents present.

The principal constituent of the crude material is the pure gutta, a hydrocarbon of the empirical formula $C_{20}H_{30}$. It is therefore isomeric with the hydrocarbon of caoutchouc and with that of oil of turpentine. Accompanying this are at least two oxygenated resinous constituents—albane $C_{20}H_{30}O$ and fluavil $C_{20}H_{30}O_2$ —which can be separated from the pure gutta by the use of solvents. Pure gutta is not dissolved by ether and light petroleum in the cold, whereas the other constituents are removed by these liquids. The true gutta exhibits in an enhanced degree the valuable properties of gutta percha, and the commercial value of the raw material is frequently determined by ascertaining the proportion of true gutta present, the higher the proportion of this the more valuable is the gutta percha. The following are the results of analyses of gutta percha from trees of the genus *Dichopsis* or *Palaquium*:

	Gutta per cent.	Resin per cent.
<i>Dichopsis</i> (or <i>Palaquium</i>) <i>oblongifolia</i>	88.8	11.2
" " " <i>gutta</i>	82.0	18.0
" " " <i>polyantha</i>	49.3	50.7
" " " <i>pustulata</i> ;	47.8	52.2
" " " <i>Maingyi</i> ;	24.4	75.6

The hydrocarbon of gutta percha, gutta, is closely related in chemical constitution to caoutchouc. When distilled at a high temperature both are resolved into a mixture of two simpler hydrocarbons, isoprene (C_5H_8) and caoutchoucine or dipentene ($C_{10}H_{16}$), and the latter by further heating can be resolved into isoprene, a hydrocarbon of known constitution which has been produced synthetically and spontaneously reverts to caoutchouc. The precise relationship of isoprene to gutta has not been ascertained, but recently Harries has further elucidated the connexion between gutta and caoutchouc by showing that under the action of ozone both break up into larvulinic aldehyde and hydrogen peroxide, but differ in the proportions of these products they furnish. The two materials must therefore be regarded as very closely related in chemical constitution. Like caoutchouc, gutta percha is able to combine with sulphur, and this vulcanized product has found some commercial applications.

Manufacture of Gutta Percha.—Among the earliest patents taken out for the manufacture of gutta percha were those of Charles Hancock, the first of which is dated 1843.

Before being used for technical purposes the raw gutta percha is cleaned by machinery whilst in the plastic state. The chopped or

sliced material is washed by mechanical means in hot water and forced through a sieve or strainer of fine wire gauze to remove dirt. It is then knepaded or "masticated" by machinery to remove the enclosed water, and is finally transferred whilst still hot and plastic to the rolling-machine, from which it emerges in sheets of different thickness. Sometimes chemical treatment of the crude gutta percha is resorted to for the purpose of removing the resinous constituents by the action of alkaline solutions or of light petroleum.

Substitutes for Gutta Percha.—For some purposes natural and artificial substitutes for gutta percha have been employed. The similar products furnished by other plants than those which yield gutta percha are among the more important of the natural substitutes, of which the material known as "balata" or "Surinam gutta percha," is the most valuable. This is derived from a tree, *Mimusops balata* (bullet tree), belonging to the same natural order as gutta percha trees, viz. Sapotaceae. It is a large tree, growing to a height of 80 to 100 ft. or more, which occurs in the West Indies, in South America, and is especially abundant in Dutch and British Guiana. The latex which furnishes balata is secreted in the cortex between the bark and wood of the tree. As the latex flows freely the trees are tapped by making incisions in the same fashion as in india-rubber trees, and the balata is obtained by evaporating the milky fluid. Crude balata varies in composition. It usually contains nearly equal proportions of resin and true gutta. The latter appears to be identical with the chief constituent of gutta percha. The proportions of balata correspond with its composition, and it may therefore be classed as an inferior gutta percha. Balata fetches from 1s. 6d. to 2s. 8d. per lb.

Among the inferior substitutes for gutta percha may be mentioned the evaporated latices derived from *Eurytopermann Parkii* (she-butter tree of West Africa or karite of the Sudan), *Calotropis gigantea* (Madar tree of India), and *Dyera costulata* of Malaya and Borneo, which furnishes the material known as "Pontianac." All these contain a small amount of gutta-like material associated with large quantities of resinous and other constituents. They fetch only a few pence per lb. and are utilized for waterproofing purposes.

Various artificial substitutes for gutta percha have been invented chiefly for use as insulating materials. These often consist of mixtures of bitumen with linseed and other oils, resins, &c., in some cases incorporated with inferior grades of gutta percha.

For further information respecting gutta percha, and for figures of the trees, the following works may be consulted: Jumele, *Les Plantes à caoutchouc et à gutta* (Paris, Challamel, 1903); Obach, "Cantor Lectures on Gutta Percha," *Journal of the Society of Arts*, 1898. (W. R. D.)

GUTTER (*O. Fr. goutiere, mod. goutibre, from Lat. gutta, drop*), in architecture, a horizontal channel or trough contrived to carry away the water from a flat or sloping roof to its discharge down a vertical pipe or through a spout or gargoyle; more specifically, but loosely, the similar channel at the side of a street, below the pavement. In Greek and Roman temples the cymatium of the cornice was the gutter, and the water was discharged through the mouths of lions, whose heads were carved on the same. Sometimes the cymatium was not carried along the flanks of a temple, in which case the rain fell off the lower edge of the roof tiles. In mediæval work the gutter rested partly on the top of the wall and partly on corbel tables, and the water was discharged through gargoyles. Sometimes, however, a parapet or pierced balustrade was carried on the corbel table enclosing the gutter. In buildings of a more ordinary class the parapet is only a continuation of the wall below, and the gutter is set back and carried in a trough resting on the lower end of the roof timbers. The safest course is to have an eaves gutter which projects more or less in front of the wall and is secured to and carried by the rafters of the roof. In Renaissance architecture generally the pierced balustrade of the Gothic and transition work was replaced by a balustrade with vertical balusters. In France a compromise was effected, whereby instead of the horizontal coping of the ordinary balustrade a richly carved cresting was employed, of which the earliest example is in the first court of the Louvre by Pierre Lescot. This exists throughout the French Renaissance, and it is one of its chief characteristic features.

GUTZKOW, KARL FERDINAND (1811-1878), German novelist and dramatist, was born on the 17th of March 1811 at Berlin, where his father held a clerkship in the war office. After leaving school he studied theology and philosophy at the university of his native town, and while still a student, began his literary career by the publication in 1831 of a periodical entitled *Forum der Journalisten*. This brought him to the notice of Wolfgang

Menzel, who invited him to Stuttgart to assist in the editorship of the *Literaturblatt*. At the same time he continued his university studies at Jena, Heidelberg and Munich. In 1832 he published anonymously at Hamburg *Briefe eines Narven an eine Närrin*, and in 1833 appeared at Stuttgart *Maka-Cura, Geschichte eines Gottes*, a fantastic and satirical romance. In 1835 he went to Frankfurt, where he founded the *Deutsche Revue*. In the same year appeared *Wally, die Zweiflerin*, from the publication of which may be said to date the school of writers who, from their opposition to the literary, social and religious traditions of romanticism, received the name of "Young Germany." The work was directed specially against the institution of marriage and the belief in revelation; and whatever interest it might have attracted from its own merits was enhanced by the action of the German federal diet, which condemned Gutzkow to three months' imprisonment, decreed the suppression of all he had written or might yet write, and prohibited him from exercising the functions of editor within the German confederation. During his term of imprisonment at Mannheim, Gutzkow employed himself in the composition of his treatise *Zur Philosophie der Geschichte* (1836). On obtaining his freedom he returned to Frankfurt, whence he went in 1837 to Hamburg. Here he inaugurated a new epoch of his literary activity by bringing out his tragedy *Richard Savage* (1839), which immediately made the round of all the German theatres. Of his numerous other plays the majority are now neglected; but a few have obtained an established place in the repertory of the German theatre—especially the comedies *Zopf und Schwert* (1844), *Das Urbild des Tartuffe* (1847), *Der Königsleutnant* (1849) and the blank verse tragedy, *Uriel Acosta* (1847). In 1847 Gutzkow went to Dresden, where he succeeded Tieck as literary adviser to the court theatre. Meanwhile he had not neglected the novel. *Seraphine* (1838) was followed by *Blasphemie und seine Söhne*, a satire on the educational theories of the time. Between 1850 and 1852 appeared *Die Ritter vom Geiste*, which may be regarded as the starting-point for the modern German social novel. *Der Zauberer von Rom* is a powerful study of Roman Catholic life in southern Germany. The success of *Die Ritter vom Geiste* suggested to Gutzkow the establishment of a journal on the model of Dickens's *Household Words*, entitled *Unterhaltungen am häuslichen Herd*, which first appeared in 1852 and was continued till 1862. In 1864 he had an epileptic fit, and his productions show henceforth decided traces of failing powers. To this period belong the historical novels *Hohenschaungau* (1868) and *Prits Ellrodt* (1872), *Lebensbilder* (1870-1872), consisting of autobiographic sketches, and *Die Söhne Pestalozzi* (1870), the plot of which is founded on the story of Kaspar Hauser. On account of a return of his nervous malady, Gutzkow in 1873 made a journey to Italy, and on his return took up his residence in the country near Heidelberg, whence he removed to Frankfort-on-Main, dying there on the 16th of December 1878. With the exception of one or two of his comedies, Gutzkow's writings have fallen into neglect. But he exerted a powerful influence on the opinions of modern Germany; and his works will always be of interest as the mirror in which the intellectual and social struggles of his time are best reflected.

An edition of Gutzkow's collected works appeared at Jena (1873-1876, new ed., 1879). E. Wolff has published critical editions of Gutzkow's *Meisterdramen* (1892) and *Wally die Zweiflerin* (1909). His more important novels have been frequently reprinted. For Gutzkow's life see his various autobiographical writings such as *Aus der Knabenzeit* (1852), *Rückblicke auf mein Leben* (1876), &c. For an estimate of his life and work see J. Proels, *Das junge Deutschland* (1892); also H. H. Houben, *Studien über die Dramen Gutzkows* (1898) and *Gutzkow-Funde* (1901).

GÜTZLAFF, KARL FRIEDRICH AUGUST (1803-1851), German missionary to China, was born at Pyritz in Pomerania on the 8th of July 1803. When still apprenticed to a saddler in Stettin, he made known his missionary inclinations to the king of Prussia, through whom he went to the Pädagogium at Halle, and afterwards to the mission institute of Jänike in Berlin. In 1826, under the auspices of the Netherlands Missionary Society, he went to Java, where he was able to learn Chinese.

Leaving the society in 1828, he went to Singapore, and in August of the same year removed to Bangkok, where he translated the Bible into Siamese. In 1829 he married an English lady, who aided him in the preparation of a dictionary of Cochinchinese, but she died in August 1831 before its completion. Shortly after her death he sailed to Macao in China, where, and subsequently at Hong Kong, he worked at a translation of the Bible into Chinese, published a Chinese monthly magazine, and wrote in Chinese various books on subjects of useful knowledge. In 1834 he published at London a *Journal of Three Voyages along the Coast of China in 1831, 1832 and 1833*. He was appointed in 1835 joint Chinese secretary to the English commission, and during the opium war of 1840-42 and the negotiations connected with the peace that followed he rendered valuable service by his knowledge of the country and people. The Chinese authorities refusing to permit foreigners to penetrate into the interior, Gützlaff in 1844 founded an institute for training native missionaries, which was so successful that during the first four years as many as forty-eight Chinese were sent out from it to work among their fellow-countrymen. He died at Hong Kong on the 9th of August 1851.

Gützlaff also wrote *A Sketch of Chinese History, Ancient and Modern* (London, 1834), and a similar work published in German at Stuttgart in 1847; *China Opened* (1838); and *The Life of Taou-Kwang* (1851; German edition published at Leipzig in 1852). A complete collection of his Chinese writings is contained in the library at Munich.

GUY OF WARWICK, English hero of romance. Guy, son of Siward or Seguard of Wallingford, by his prowess in foreign wars wins in marriage Félice (the Phyllis of the well-known ballad), daughter and heiress of Roalt, earl of Warwick. Soon after his marriage he is seized with remorse for the violence of his past life, and, by way of penance, leaves his wife and fortune to make a pilgrimage to the Holy Land. After years of absence he returns in time to deliver Winchester for King Æthelstan from the invading northern kings, Anclaph (Anlaf or Olaf) and Gonclaph, by slaying in single fight their champion the giant Colbrand. Local tradition fixes the duel at Hyde Mead near Winchester. Making his way to Warwick he becomes one of his wife's bedesmen, and presently retires to a hermitage in Arden, only revealing his identity at the approach of death. The versions of the Middle English romance of Guy which we possess are adaptations from the French, and are cast in the form of a *roman d'aventures*, opening with a long recital of Guy's wars in Lombardy, Germany and Constantinople, and embellished with fights with dragons and surprising feats of arms. The kernel of the tradition evidently lies in the fight with Colbrand, which represents, or at least is symbolic of an historical fact. The religious side of the legend finds parallels in the stories of St Eustachius and St Alexius,² and makes it probable that the Guy-legend, as we have it, has passed through monastic hands. Tradition seems to be at fault in putting Guy's adventures under Æthelstan. The Anlaf of the story is probably Olaf Tryggvason, who, with Sweyn of Denmark, harried the southern counties of England in 993 and pitched his winter quarters in Southampton. Winchester was saved, however, not by the valour of an English champion, but by the payment of money. This Olaf was not unnaturally confused with Anlaf Cuaran or Havelok (q.v.).

The name Guy (perhaps a Norman form of A. S. *wig*-war) may be fairly connected with the family of Wigod, lord of Wallingford under Edward the Confessor, and a Filicia, who belongs to the 12th century and was perhaps the Norman poet's patroness, occurs in the pedigree of the Ardens, descended from Thurkill of Warwick and his son Siward. Guy's Cliffe, near Warwick, where in the 14th century Richard de Beauchamp, earl of Warwick, erected a chantry, with a statue of the hero, does not correspond with the site of the hermitage as described in the

¹ Some writers have supposed that the fight with Colbrand symbolizes the victory of Brunanburh. Anclaph and Gonclaph would then represent the cousins Anlaf Sitricson and Anlaf Godfreyson (see HAVELOK).

² See the English legends in C. Horstmann, *Allenglische Legenden*. Neue Folge (Heilbronn, 1881).

romance. The bulk of the legend is obviously fiction, even though it may be vaguely connected with the family history of the Ardens and the Wallingford family, but it was accepted as authentic fact in the chronicle of Pierre de Langtoft (Peter of Langtoft) written at the end of the 13th century. The adventures of Reynbrun, son of Guy, and his tutor Heraud of Arden, who had also educated Guy, have much in common with his father's history, and form an interpolation sometimes treated as a separate romance. There is a certain connexion between Guy and Count Guido of Tours (fl. 800), and Alcuin's advice to the count is transferred to the English hero in the *Speculum Gy of Warewyke* (c. 1327), edited for the Early English Text Society by G. L. Morrill, 1898.

The French romance (Brit., Mus. Harl. MS. 3775) has not been printed, but is described by Émile Littré in *Hist. litt. de la France* (xxii., 841-851, 1852). A French prose version was printed in Paris, 1525, and subsequently (see G. Brunet, *Manuel du libraire*, s. v. "Guy de Warwick"); the English metrical romance exists in four versions, dating from the early 14th century; the text was edited by J. Zupitza (1875-1876) for the E.E.T.S. from Cambridge University Lib. Paper MS. Ff. 2, 38, and again (3 pts. 1883-1891, extra series, Nos. 42, 49, 59), from the Auchinleck and Caius College MSS. The popularity of the legend is shown by the numerous versions in English: *Guy of Warwick*, translated from the Latin of Girardus Cornubiensis (fl. 1350) into English verse by John Lydgate between 1442 and 1468; *Guy of Warwick*, a poem (written in 1617 and licensed, but not printed) by John Lane, the MS. of which (Brit. Mus.) contains a sonnet by John Milton, father of the poet; *The Famous History of Guy, Earl of Warwick* (c. 1607), by Samuel Rowlands; *The Booke of the Most Victorious Prince Guy of Warwick* (William Copland, no date); other editions by J. Cawood and C. Bates; chap-books and ballads of the 17th and 18th centuries; *The Tragical History, Admirable Achievements and Curious Events of Guy, Earl of Warwick*, a tragedy (1661) which may possibly be identical with a play on the subject written by John Day and Thomas Dekker, and entered at Stationers' Hall on the 15th of January 1618/19; three verse fragments are printed by Hales and Furnivall in their edition of the Percy Folio MS. vol. ii.; an early French MS. is described by J. A. Herbert (*An Early MS. of Gui de Warwick*, London, 1905).

See also M. Weyrauch *Die mittellengl. Fassungen der Sage von Guy* (2 pts., Breslau, 1899 and 1901); J. Zupitza in *Sittensber. d. phil.-hist. Kl. d. kgl. Akad. d. Wiss.* (vol. lxiv., Vienna, 1874), and *Zur Literaturgeschichte des Guy von Warwick* (Vienna, 1873); a learned discussion of the whole subject by H. L. Ward, *Catalogue of Romances* (i. 471-501, 1883); and an article by S. L. Lee in the *Dictionary of National Biography*.

GUY, THOMAS (1644-1724), founder of Guy's Hospital, London, was the son of a lighterman and coal-dealer at Southwark. After serving an apprenticeship of eight years with a bookseller, he in 1668 began business on his own account. He dealt largely in Bibles, which had for many years been poorly and incorrectly printed in England. These he at first imported from Holland, but subsequently obtained from the university of Oxford the privilege of printing. Thus, and by an extremely thrifty mode of life, and more particularly by investment in government securities, the subscription of these into the South Sea Company, and the subsequent sale of his stock in 1720, he became master of an immense fortune. He died unmarried on the 17th of December 1724. In 1707 he built three wards of St Thomas's Hospital, which institution he otherwise subsequently benefited; and at a cost of £18,793, 16s. he erected Guy's Hospital, leaving for its endowment £219,499; he also endowed Christ's Hospital with £400 a year, and in 1678 endowed almshouses at Tamworth, his mother's birthplace, which was represented by him in parliament from 1695 to 1707. The residue of his estate, which went to distant relatives, amounted to about £80,000.

See *A True Copy of the Last Will and Testament of Thomas Guy, Esq.* (London, 1725); J. Noorthouck, *A New Hist. of London*, bk. iii. ch. i. p. 684 (1773); Nichols, *Literary Anecdotes*, iii. 599 (1812); Charles Knight, *Shadow of the Old Booksellers*, pp. 3-23 (1865); and *A Biographical History of Guy's Hospital*, by S. Wilkes and G. T. Bettany (1892).

GUYON, JEANNE MARIE BOUVIER DE LA MOTHE (1648-1712), French quietist writer, was born at Montargis, where her family were persons of consequence, on the 13th of April 1648. If her somewhat hysterical autobiography may be trusted she was much neglected in her youth; most of her time

was spent as a boarder in various convent schools. Here she went through all the religious experiences common to ascetic young women; these were turned in a definitely mystical direction by the duchesse de Béthune, daughter of the disgraced minister, Fouquet, who spent some years at Montargis after her father's fall. In 1664 Jeanne Marie was married to a rich invalid of the name of Guyon, many years her senior. Twelve years later he died, leaving his widow with three small children and a considerable fortune. All through her unhappy married life the mystical attraction had grown steadily in violence; it now attached itself to a certain Father Lacombe, a Barnabite monk of weak character and unstable intellect. In 1681 she left her family and joined him; for five years the two rambled about together in Savoy and the south-east of France, spreading their mystical ideas. At last they excited the suspicion of the authorities; in 1686 Lacombe was recalled to Paris, put under surveillance, and finally sent to the Bastille in the autumn of 1687. He was presently transferred to the castle of Lourdes, where he developed softening of the brain and died in 1715. Meanwhile Madame Guyon had been arrested in January 1688, and been shut up in a convent as a suspected heretic. Thence she was delivered in the following year by her old friend, the duchesse de Béthune, who had returned from exile to become a power in the devout court-circle presided over by Madame de Maintenon. Before long Madame Guyon herself was introduced into this pious assemblage. Its members were far from critical; they were intensely interested in religion; and even Madame Guyon's bitterest critics bear witness to her charm of manner, her imposing appearance, and the force and eloquence with which she explained her mystical ideas. So much was Madame de Maintenon impressed, that she often invited Madame Guyon to give lectures at her girls' school of St Cyr. But by far the greatest of her conquests was Fénelon, now a rising young director of consciences, much in favour with aristocratic ladies. Dissatisfied with the formalism of average Catholic piety, he was already thinking out a mystical theory of his own; and between 1689 and 1693 they corresponded regularly. But as soon as ugly reports about Lacombe began to spread, he broke off all connexion with her. Meanwhile the reports had reached the prudent ears of Madame de Maintenon. In May 1693 she asked Madame Guyon to go no more to St Cyr. In the hope of clearing her orthodoxy, Madame Guyon appealed to Bossuet, who decided that her books contained "much that was intolerable, alike in form and matter." To this judgment Madame Guyon submitted, promised to "dogmatize no more," and disappeared into the country (1693). In the next year she again petitioned for an inquiry, and was eventually sent, half as a prisoner, half as a penitent, to Bossuet's cathedral town of Meaux. Here she spent the first half of 1695; but in the summer she escaped without his leave, bearing with her a certificate of orthodoxy signed by him. Bossuet regarded this flight as a gross act of disobedience; in the winter Madame Guyon was arrested and shut up in the Bastille. There she remained till 1703. In that year she was liberated, on condition she went to live on her son's estate near Blois, under the eye of a stern bishop. Here the rest of her life was spent in charitable and pious exercises; she died on the 9th of June 1717. During these latter years her retreat at Blois became a regular place of pilgrimage for admirers, foreign quite as often as French. Indeed, she is one of the many prophetesses whose fame has stood highest out of their own country. French critics of all schools of thought have generally reckoned her an hysterical degenerate; in England and Germany she has as often roused enthusiastic admiration.

AUTHORITIES.—*Vie de Madame Guyon, écrite par elle-même* (really a compilation made from various fragments) (3 vols., Paris, 1791). There is a life in English by T. C. Upham (New York, 1854); and an elaborate study by L. Guérrier (Paris, 1881). For a remarkable review of this latter work see Brunetière, *Nouvelles Études critiques*, vol. ii. The complete edition of Madame Guyon's works, including the autobiography and five volumes of letters, runs to forty volumes (1767-1791); the most important works are published separately, *Opuscules spirituels* (2 vols., Paris, 1790). They have

been several times translated into English. See also the literature of the article on QUETIEM; and H. Delacroix, *Études sur le mysticisme* (Paris, 1908). (St. C.)

GUYON, RICHARD DEBAUFRE (1803-1856), British soldier, general in the Hungarian revolutionary army and Turkish pasha, was born at Walcot, near Bath, in 1803. After receiving a military education in England and in Austria he entered the Hungarian hussars in 1823, in which he served until after his marriage with a daughter of Baron Spleny, a general officer in the imperial service. At the outbreak of the Hungarian War in 1848, he re-entered active service as an officer of the Hungarian Honvéds, and he won great distinction in the action of Sakoro (September 29, 1848) and the battle of Schwechat (October 30). He added to his reputation as a leader in various actions in the winter of 1848-1849, and after the battle of Kopolna was made a general officer. He served in important and sometimes independent commands to the end of the war, after which he escaped to Turkey. In 1852 he entered the service of the sultan. He was made a pasha and lieutenant-general without being required to change his faith, and rendered distinguished service in the campaign against the Russians in Asia Minor (1854-55). General Guyon died of cholera at Scutari on the 12th of October 1856.

See A. W. Kinglake, *The Patriot and the Hero General Guyon* (1856).

GUYOT, ARNOLD HENRY (1807-1884), Swiss-American geologist and geographer, was born at Boudevillers, near Neuchâtel, Switzerland, on the 26th of September 1807. He studied at the college of Neuchâtel and in Germany, where he began a lifelong friendship with Louis Agassiz. He was professor of history and physical geography at the short-lived Neuchâtel "Academy" from 1839 to 1848, when he removed, at Agassiz's instance, to the United States, settling in Cambridge, Massachusetts. For several years he was a lecturer for the Massachusetts State Board of Education, and he was professor of geology and physical geography at Princeton from 1854 until his death there on the 8th of February 1884. He ranked high as a geologist and meteorologist. As early as 1838, he undertook, at Agassiz's suggestion, the study of glaciers, and was the first to announce, in a paper submitted to the Geological Society of France, certain important observations relating to glacial motion and structure. Among other things he noted the more rapid flow of the centre than of the sides, and the more rapid flow of the top than of the bottom of glaciers; described the laminated or "ribbed" structure of the glacial ice, and ascribed the movement of glaciers to a gradual molecular displacement rather than to a sliding of the ice mass as held by de Saussure. He subsequently collected important data concerning erratic boulders. His extensive meteorological observations in America led to the establishment of the United States Weather Bureau, and his *Meteorological and Physical Tables* (1852, revised ed. 1884) were long standard. His graded series of text-books and wall-maps were important aids in the extension and popularization of geological study in America. In addition to text-books, his principal publications were: *Earth and Man, Lectures on Comparative Physical Geography in its Relation to the History of Mankind* (translated by Professor C. C. Felton, 1849); *A Memoir of Louis Agassiz* (1883); and *Creation, or the Biblical Cosmogony in the Light of Modern Science* (1884).

See James D. Dana's "Memoir" in the *Biographical Memoirs of the National Academy of Science*, vol. ii. (Washington, 1886).

GUYOT, YVES (1843-), French politician and economist, was born at Dinan on the 6th of September 1843. Educated at Rennes, he took up the profession of journalism, coming to Paris in 1867. He was for a short period editor-in-chief of *L'Indépendant du midi* of Nîmes, but joined the staff of *La Rappel* on its foundation, and worked subsequently on other journals. He took an active part in municipal life, and waged a keen campaign against the prefecture of police, for which he suffered six months' imprisonment. He entered the chamber of deputies in 1885 as representative of the first arrondissement of Paris and was *rapporteur général* of the budget of 1888. He became minister of public works under the premiership of P. E.

Tirard in 1886, retaining his portfolio in the cabinet of C. L. de Freycinet until 1892. Although of strong liberal views, he lost his seat in the election of 1893 owing to his militant attitude against socialism. An uncompromising free-trader, he published *La Comédie protectionniste* (1905; Eng. trans. *The Comedy of Protection*); *La Science économique* (1st ed. 1881; 3rd ed. 1907); *La Prostitution* (1882); *La Tyrannie socialiste* (1893), all three translated into English; *Les Confits du travail et leur solution* (1903); *La Démocratie individualiste* (1907).

GUYTON DE MORVEAU, LOUIS BERNARD, BARON (1737-1816), French chemist, was born on the 4th of January 1737, at Dijon, where his father was professor of civil law at the university. As a boy he showed remarkable aptitude for practical mechanics, but on leaving school he studied law in the university of Dijon, and in his twenty-fourth year became advocate-general in the parlement of Dijon. This office he held till 1782. Devoting his leisure to the study of chemistry, he published in 1772 his *Digressions académiques*, in which he set forth his views on phlogiston, crystallization, &c., and two years later he established in his native town courses of lectures on materia medica, mineralogy and chemistry. An essay on chemical nomenclature, which he published in the *Journal de physique* for May 1782, was ultimately developed with the aid of A. L. Lavoisier, C. L. Berthollet and A. F. Fourcroy, into the *Méthode d'une nomenclature chimique*, published in 1787, the principles of which were speedily adopted by chemists throughout Europe. Constantly in communication with the leaders of the Lavoisierian school, he soon became a convert to the anti-phlogistic doctrine; and he published his reasons in the first volume of the section "Chymie, Pharmacie et Metallurgie" of the *Encyclopédie méthodique* (1786), the chemical articles in which were written by him, as well as some of those in the second volume (1792). In 1794 he was appointed to superintend the construction of balloons for military purposes, being known as the author of some aeronautical experiments carried out at Dijon some ten years previously. In 1791 he became a member of the Legislative Assembly, and in the following year of the National Convention, to which he was re-elected in 1795, but he retired from political life in 1797. In 1798 he acted as provisional director of the Polytechnic School, in the foundation of which he took an active part, and from 1800 to 1814 he held the appointment of master of the mint. In 1811 he was made a baron of the French Empire. He died in Paris on the 2nd of January 1816.

Besides being a diligent contributor to the scientific periodicals of the day, Guyton wrote *Mémoire sur l'éducation publique* (1762); a satirical poem entitled *Le Roi scolastique, ou le Jésuite croqué* (1763); *Discours publics et éloges* (1775-1782); *Plaidoyers sur plusieurs questions de droit* (1785); and *Traité des moyens de désinfecter l'air* (1801), describing the disinfecting powers of chlorine, and of hydrochloric acid gas which he had successfully used at Dijon in 1773. With Hugues Maret (1726-1788) and Jean François Durande (d. 1794), he also published the *Éléments de chimie théorique et pratique* (1776-1777).

GUZMICS, IZIDOR (1786-1839), Hungarian theologian; was born on the 7th of April 1786 at Vámos-Csaád, in the county of Sopron. At Sopron (Oedenburg) he was instructed in the art of poetry by Paul Horváth. In October 1805 he entered the Benedictine order, but left it in August of the following year, only again to assume the monastic garb on the 10th of November 1806. At the monastery of Pannonhegy he applied himself to the study of Greek under Farkas Tóth and in 1812 he was sent to Pesth to study theology. Here he read the best German and Hungarian authors, and took part in the editorship of the *Nemzeti* (National) *Pfuarikus*, and in the translation of Johann Hübnér's *Lexicon*. On obtaining the degree of doctor of divinity in 1816, he returned to Pannonhegy, where he devoted himself to dogmatic theology and literature, and contributed largely to Hungarian periodicals. The most important of his theological works are: *A kath. anyaszentegyházak hitéleti tanítása* (The Doctrinal Teaching of the Holy Catholic Church), and *A keresztényeknek vallásbeli egyesüléséről* (On Religious Unity among Christians), both published at Pesth in 1822; also a Latin treatise entitled *Theologia Christiana fundamentalis et theologia dogmatica* (4 vols.; Győr, 1828-1829). His translation of

Theocritus in hexameters was published in 1824. His versions of the *Oedipus* of Sophocles and of the *Iphigenia* of Euripides were rewarded by the Hungarian Academy, of which in 1838 he was elected honorary member. In 1831 he was appointed abbot of the wealthy Benedictine house at Bakonybél, a village in the county of Veszprém. There he built an asylum for 150 children, and founded a school of harmony and singing. He died on the 1st of September 1839.

GWADAR, a port on the Makran coast of Baluchistan, about 290 m. W. of Karachi. Pop. (1903), 4,150. In the last half of the 18th century it was handed over by the khan of Kalat to the sultan of Muscat, who still exercises sovereignty over the port, together with about 300 sq. m. of the adjoining country. It is a place of call for the steamers of the British India Navigation Company.

GWALIOR, a native state of India, in the Central India agency, by far the largest of the numerous principalities comprised in that area. It is the dominion of the Sindhia family. The state consists of two well-defined parts which may roughly be called the northern and the southern. The former is a compact mass of territory, bounded N. and N.W. by the Chambal river, which separates it from the British districts of Agra and Etawah, and the native states of Dholpur, Karauli and Jaipur of Rajputana; E. by the British districts of Jalaun, Jhansi, Lalitpur and Saugor; S. by the states of Bhopal, Tonk, Khilchipur and Rajgarh; and W. by those of Jhalawar, Tonk and Kotah of Rajputana. The southern, or Malwa, portion is made up of detached or semi-detached districts, between which are interposed parts of other states, which again are mixed up with each other in bewildering intricacy. The two portions together have a total area of 25,041 sq. m. Pop. (1901), 2,933,001, showing a decrease of 13% in the decade.

The state may be naturally divided into plain, plateau and hilly country. The plain country extends from the Chambal river in the extreme southwards for about 80 m., with a maximum width from east to west of about 120 m. This plain, though broken in its southern portion by low hills, has generally an elevation of only a few hundred feet above sea-level. In the summer season the climate is very hot, the shade temperature rising frequently to 112° F., but in the winter months (from November to February inclusive) it is usually temperate and for short periods extremely cold. The average rainfall is 30 in., but the period 1891-1901 was a decade of low rainfall, and distress was caused by famine. South of this tract there is a gradual ascent to the Central India plateau, and at Sipri the general level is 1500 ft. above the sea. On this plateau lies the remainder of the state, with the exception of the small district of Amjhara in the extreme south. The elevation of this region gives it a moderate climate during the summer as compared with the plain country, while the winter is warmer and more equable. The average rainfall is 28 in. The remaining portion of the state, classed as hilly, comprises only the small district of Amjhara. This is known as the Bhil country, and lies among the Vindhya mountains with a mean elevation of about 1800 ft. The rainfall averages 23 in. In the two years 1899 and 1900 the monsoon was very weak, the result being a severe famine which caused great mortality among the Bhil population. Of these three natural divisions the plateau possesses the most fertile soil, generally of the kind known as "black cotton," but the low-lying plain has the densest population. The state is watered by numerous rivers. The Nerbudda, flowing west, forms the southern boundary. The greater part of the drainage is discharged into the Chambal, which forms the north-western and northern and eastern boundary. The Sind, with its tributaries the Kuwari, Asar and Sankh, flows through the northern division. The chief products are wheat, millets, pulses of various kinds, maize, rice, linseed and other oil-seeds; poppy, yielding the Malwa opium; sugar-cane, cotton, tobacco, indigo, garlic, turmeric and ginger. About 60% of the population are employed in agricultural and only 13% in industrial occupations, the great majority of the latter being home workers. There is a leather factory at Morar; cotton-presses at Morena, Baghana

and Ujjain; ginning factories at Agar, Nalkhera, Shajapur and Sonkach; and a cotton-mill at Ujjain. The cotton industry alone shows possibilities of considerable development, there being 55,000 persons engaged in it at the time of the census of 1901.

The population is composed of many elements, among which Brahmans and Rajputs are specially numerous. The prevailing religion is Hinduism, 84% of the people being Hindus and only 6% Mahomedans. The revenue of the state is about one million sterling; and large reserves have been accumulated, from which two millions were lent to the government of India in 1887, and later on another million for the construction of the Gwalior-Agra and Indore-Neemuch railways. The railways undertaken by the state are: (1) from Bina on the Indian Midland to Goona; (2) an extension of this line to Baran, opened in 1899; (3) from Bhopal to Ujjain; (4) two light railways, from Gwalior to Sipri and Gwalior to Bhind, which were opened by the viceroy in November 1899. On the same occasion the viceroy opened the Victoria College, founded to commemorate the Diamond Jubilee; and the Memorial Hospital, built in memory of the maharaja's father. British currency has been introduced instead of Chandori rupees, which were much depreciated. The state maintains three regiments of Imperial Service cavalry, two battalions of infantry and a transport corps.

History.—The Sindhia family, the rulers of the Gwalior state, belong to the Mahratta nation and originally came from the neighbourhood of Poona. Their first appearance in Central India was early in the 18th century in the person of Ranoji (d. 1745), a scion of an impoverished branch of the family, who began his career as the peshwa's slipper-carrier and rose by his military abilities to be commander of his bodyguard. In 1726, together with Malhar Rao Holkar, the founder of the house of Indore, he was authorized by the peshwa to collect tribute (*chauth*) in the Malwa districts. He established his headquarters at Ujjain, which thus became the first capital of Sindhia's dominions.

Ranoji's son and successor, Jayapa Sindhia, was killed at Nagaur in 1759, and was in his turn succeeded by his son Jankoji Sindhia. But the real founder of the state of Gwalior was Mahadji Sindhia, a natural son of Ranoji, who, after narrowly escaping with his life from the terrible slaughter of Panipat in 1761 (when Jankoji was killed), obtained with some difficulty from the peshwa a re-grant of his father's possessions in Central India (1769). During the struggle which followed the death of Madhu Rao Peshwa in 1772 Mahadji seized every occasion for extending his power and possessions. In 1775, however, when Raghoba Peshwa threw himself on the protection of the British, the reverses which Mahadji encountered at their hands—Gwalior being taken by Major Popham in 1780—opened his eyes to their power. By the treaty of Salbai (1782) it was agreed that Mahadji should withdraw to Ujjain, and the British retire north of the Jumna. Mahadji, who undertook to open negotiations with the other belligerents, was recognized as an independent ruler, and a British resident was established at his court. Mahadji, aided by the British policy of neutrality, now set to work to establish his supremacy over Hindustan proper. Realizing the superiority of European methods of warfare, he availed himself of the services of a Savoyard soldier of fortune, Benoit de Boigne, whose genius for military organization and command in the field was mainly instrumental in establishing the Mahratta power. Mahadji's disciplined troops made him invincible. In 1785 he re-established Shah Alam on the imperial throne at Delhi, and as his reward obtained for the peshwa the title of *nakil-ul-mullak* or vicergerent of the empire, contenting himself with that of his deputy. In 1788 he took advantage of the cruelties practised by Ghulam Kadir on Shah Alam, to occupy Delhi, where he established himself as the protector of the aged emperor. Though nominally a deputy of the peshwa he was now ruler of a vast territory, including the greater part of Central India and Hindustan proper, while his lieutenants exacted tribute from the chiefs of Rajputana. There can be no doubt that he looked with apprehension on the growing power of

the British; but he wholly avoided any serious collision with them.

Mahadji died in 1794, and was succeeded by his adopted son, Daulat Rao Sindhia, a grandson of his brother Tukoji. When, during the period of anarthy that followed the deaths of the peshwa, Madha Rao II., in 1795 and of Tukoji Holkar in 1797, the Mahratta leaders fought over the question of supremacy, the peshwa, Baji Rao II., the titular head of the Mahratta confederation, fled from his capital and placed himself under British protection by the treaty of Bassein (December 31, 1802). This interposition of the British government was resented by the confederacy, and it brought on the Mahratta War of 1803. In the campaign that followed a combined Mahratta army, in which Daulat Rao's troops furnished the largest contingent, was defeated by General Arthur Wellesley at Assaye and Argaum in Central India; and Lord Lake routed Daulat Rao's European-trained battalions in Northern India at Agra, Aligarh and Laswari. Daulat Rao was then compelled to sign the treaty of Sarji Anjanagan (December 30, 1803), which stripped him of his territories between the Jumna and Ganges, the district of Bessach in Gujarat and other lands in the south. By the same treaty he was deprived of the forts of Gwalior and Gohad; but these were restored by Lord Cornwallis in 1805, when the Chambal river was made the northern boundary of the state. By a treaty signed at Burhanpur in 1807 Daulat Rao further agreed to maintain a subsidiary force, to be paid out of the revenues of the territories ceded under the treaty of Sarji Anjanagan. When, however, in 1816 he was called upon to assist in the suppression of the Pindaris, though by the treaty of Gwalior (1817) he promised his co-operation, his conduct was so equivocal that in 1818 he was forced to sign a fresh treaty by which he ceded Ajmere and other lands.

Daulat Rao died without issue in 1807, and his widow, Baiza Bai (d. 1860), adopted Mukut Rao, a boy of eleven belonging to a distant branch of the family, who succeeded as Jankoji Rao Sindhia. His rule was weak; the state was distracted by interminable palace intrigues and military mutinies, and affairs went from bad to worse when, in 1843, Jankoji Rao, who left no heir, was succeeded by another boy, adopted by his widow, Tara Bai, under the name of Jayaji Rao Sindhia. The growth of turbulence and misrule now induced Lord Ellenborough to interpose, and a British force under Sir Hugh Gough advanced upon Gwalior (December 1843). The Mahratta troops were defeated simultaneously at Maharajpur and Punnar (December 29), with the result that the Gwalior government signed a treaty ceding territory with revenue sufficient for the maintenance of a contingent force to be stationed at the capital, and limiting the future strength of the Gwalior army, while a council of regency was appointed during the minority to act under the resident's advice. In 1857 the Gwalior contingent joined the mutineers; but the maharaja himself remained loyal to the British, and fled from his capital until the place was retaken and his authority restored by Sir Hugh Rose (Lord Strathnairn) on the 19th of June 1858. He was rewarded with the districts of Neemuch and Amjhera, but Gwalior fort was occupied by British troops and was only restored to his son in 1886 by Lord Dufferin. Jayaji Rao, who died in 1886, did much for the development of his state. He was created a G.C.S.I. in 1861, and subsequently became a councillor of the empress, a G.C.B. and C.I.E.

His son, the maharaja, Madhava Rao Sindhia, G.C.S.I., was born in 1877. During his minority the state was administered for eight years by a council of regency. He was entrusted with ruling powers in 1894, and in all respects continued the reforming policy of the council, while paying personal attention to every department, being a keen soldier, an energetic administrator, and fully alive to the responsibilities attaching to his position. He was created an honorary aide-de-camp to the king-emperor and an honorary colonel in the British army. He went to China as orderly officer to General Gaselee in 1907, and provided the expedition with a hospital ship at his own expense, while his Imperial Service Transport Corps proved a useful auxiliary to the British army in the Chitral and Tirah expeditions.

The CITY OF GWALIOR is 76 m. by rail S. of Agra, and had a population in 1901 of 219,433. This total includes the new town of Lashkar or "the Camp" which is the modern capital of the state and old Gwalior. The old town has a threefold interest: first as a very ancient seat of Jain worship; secondly for its example of palace architecture of the best Hindu period (1406-1516); and thirdly as an historic fortress. There are several remarkable Hindu temples within the fort. One, known as the *Sar Beha*, is beautifully adorned with bas-reliefs. It was finished in A.D. 1093, and, though much dilapidated, still forms a most picturesque fragment. An older Jain temple has been used as a mosque. Another temple in the fortress of Gwalior is called the *Teli-Mandir*, or "Oilman's Temple." This building was originally dedicated to Vishnu, but afterwards converted to the worship of Siva. The most striking part of the Jain remains at Gwalior is a series of caves or rock-cut sculptures, excavated in the rock on all sides, and numbering nearly a hundred, great and small. Most of them are mere niches to contain statues, though some are cells that may have been originally intended for residences. One curious fact regarding them is that, according to inscriptions, they were all excavated within the short period of about thirty-three years, between 1441 and 1474. Some of the figures are of colossal size; one, for instance, is 57 ft. high, which is taller than any other in northern India.

The palace built by Man Singh (1486-1516) forms the most interesting example of early Hindu work of its class in India. Another palace of even greater extent was added to this in 1516; both Jehangir and Shah Jahan added palaces to these two—the whole making a group of edifices unequalled for picturesqueness and interest by anything of their class in Central India. Among the apartments in the palace was the celebrated chamber, named the *Baradari*, supported on 12 columns, and 45 ft. square, with a stone roof, forming one of the most beautiful palace-halls in the world. It was, besides, singularly interesting from the expedients to which the Hindu architect was forced to resort to imitate the vaults of the Moslems. Of the buildings, however, which so excited the admiration of the emperor Baber, probably little now remains. The fort of Gwalior, within which the above buildings are situated, stands on an isolated rock. The face is perpendicular and where the rock is naturally less precipitous it has been steeped. Its greatest length from north-east to south-west is a mile and a half, and the greatest breadth 900 yds. The rock attains its maximum height of 343 ft. at the northern end. A rampart, accessible by a steep road, and farther up by huge steps cut out of the rock, surrounds the fort. The citadel stands at the north-eastern corner of the enclosure, and presents a very picturesque appearance. The old town of Gwalior, which is of considerable size, but irregularly built, and extremely dirty, lies at the eastern base of the rock. It contains the tomb of Mahommed Ghaus, erected during the early part of Akbar's reign. The fort of Gwalior was traditionally built by one Surya Sen; the raja of the neighbouring country. In 1196 Gwalior was captured by Mahommed Ghori; it then passed into the hands of several chiefs until in 1559 Akbar gained possession of it, and made it a state prison for captives of rank. On the dismemberment of the Delhi empire, Gwalior was seized by the Jat rana of Gohad. Subsequently it was garrisoned by Sindhia, from whom it was wrested in 1780 by the forces of the East India Company, and to whom it was finally restored by the British in 1836. The modern town contains the palace of the chief, a college, a high school, a girls' school, a service school to train officials, a law school, hospitals for men and for women, a museum, paper-mills, and a printing-press issuing a state gazette.

GWALIOR RESIDENCY, an administrative unit in the Central India agency, comprises Gwalior state and eleven smaller states and estates. Its total area is 17,325 sq. m., and its population in 1901 was 2,877,612. Of the area, 17,000 sq. m. belong to Gwalior State, and the agency also includes the small states of Raghugarh, Khandadhana, Paron, Garha, Umri and Bhadsura, with the Chhabra *pargana* of Tonk.

GWEDDORÉ, a hamlet and tourist resort of Co. Donegal, Ireland, on the Londonderry & Lough Swilly & Letterkenny

railway. The river Clady, running past the village from the Nacuss Loughs, affords salmon and trout fishing. The fine surrounding scenery culminates to the east in the wild mountain Errigal (2666 ft.) at the upper end of the loughs. The place owes its popularity as a resort to Lord George Hill (d. 1879), who also laboured for the amelioration of the conditions of the peasantry on his estate, and combated the Rundale system of minute repartition of property. In 1889, during the troubles which arose out of evictions, Gweedore was the headquarters of the Irish constabulary, when District Inspector Martin was openly murdered on attempting to arrest a priest on his way to Mass.

GWILT, JOSEPH (1784-1863), English architect and writer, was the younger son of George Gwilt, architect surveyor to the county of Surrey, and was born at Southwark on the 11th of January 1784. He was educated at St. Paul's school, and after a short course of instruction in his father's office was in 1801 admitted a student of the Royal Academy, where in the same year he gained the silver medal for his drawing of the tower and steeple of St. Dunstan-in-the-East. In 1811 he published a *Treatise on the Equilibrium of Arches*, and in 1815 he was elected F.S.A. After a visit to Italy in 1816, he published in 1818 *Notizie architettoniche italiane, or Concise Notices of the Buildings and Architects of Italy*. In 1825 he published an edition of Sir William Chambers's *Treatise on Civil Architecture*; and among his other principal contributions to the literature of his profession are a translation of the *Architecture of Vitruvius* (1826), a *Treatise on the Rudiments of Architecture, Practical and Theoretical* (1826), and his valuable *Encyclopaedia of Architecture* (1842), which was published with additions by Wyatt Papworth in 1867. In recognition of Gwilt's advocacy of the importance to architects of a knowledge of mathematics, he was in 1833 elected a member of the Royal Astronomical Society. He took a special interest in philology and music, and was the author of *Rudiments of the Anglo-Saxon Tongue* (1829), and of the article "Music" in the *Encyclopaedia metropolitana*. His principal works as a practical architect were Markee Castle near Sligo in Ireland, and St. Thomas's church at Charlton in Kent. He died on the 14th of September 1863.

GWYN, NELL [ELIZABETH] (1650-1687), English actress, and mistress of Charles II., was born on the 2nd of February 1650?, probably in an alley off Drury Lane, London, although hereof also claims to have been her birthplace. Her father, Thomas Gwyn, appears to have been a broken-down soldier of a family of Welsh origin. Of her mother little is known save that she lived for some time with her daughter, and that in 1679 she was drowned, apparently when intoxicated, in a pond at Chelsea. Nell Gwyn, who sold oranges in the precincts of Drury Lane Theatre, passed, at the age of fifteen, to the boards, through the influence of the actor Charles Hart and of Robert Duncan or Dungen, an officer of the guards who had interest with the management. Her first recorded appearance on the stage was in 1665 as Cydaria, Montezuma's daughter, in Dryden's *Indian Emperor*, a serious part ill-suited to her. In the following year she was Lady Wealthy in the Hon. James Howard's comedy *The English Monsieur*. Pepys was delighted with the playing of "pretty, witty Nell," but when he saw her as Florimel in Dryden's *Secret Love, or the Maiden Queen*, he wrote "so great a performance of a comical part was never, I believe, in the world before" and, "so done by Nell her merry part as cannot be better done in nature" (*Diary*, March 26, 1667). Her success brought her other leading rôles—Bellario, in Beaumont and Fletcher's *Philaster*; Flora, in Rhodens *Flora's Vagaries*; Samira, in Sir Robert Howard's *Surprizal*; and she remained a member of the Drury Lane company until 1669, playing continuously save for a brief absence in the summer of 1667 when she lived at Epsom as the mistress of Lord Buckhurst, afterwards 6th earl of Dorset (q.v.). Her last appearance was as Almahide to the Almansor of Hart, in Dryden's *The Conquest of Granada* (1670), the production of which had been postponed some months for her return to the stage after the birth of her first son by the king.

As an actress Nell Gwyn was largely indebted to Dryden, who

seems to have made a special study of her airy, irresponsible personality, and who kept her supplied with parts which suited her. She excelled in the delivery of the risky prologues and epilogues which were the fashion, and the poet wrote for her some specially daring examples. It was, however, as the mistress of Charles II. that she endeared herself to the public. Partly, no doubt, her popularity was due to the disgust inspired by her rival, Louise de Kéroualle, Duchess of Portsmouth, and to the fact that, while the Frenchwoman was a Catholic, she was a Protestant. But very largely it was the result of exactly those personal qualities that appealed to the monarch himself. She was *piquant* rather than pretty, short of stature, and her chief beauty was her reddish-brown hair. She was illiterate, and with difficulty scrawled an awkward E. G. at the bottom of her letters, written for her by others. But her frank recklessness, her generosity, her invariably good temper, her ready wit, her infectious high spirits and amazing indiscretions appealed irresistibly to a generation which welcomed in her the living antithesis of Puritanism. "A true child of the London streets," she never pretended to be superior to what she was, nor to interfere in matters outside the special sphere assigned her; she made no ministries, she appointed to no bishoprics, and for the high issues of international politics she had no concern. She never forgot her old friends, and, as far as is known, remained faithful to her royal lover from the beginning of their intimacy to his death, and, after his death, to his memory.

Of her two sons by the king, the elder was created Baron Hedington and earl of Burford and subsequently duke of St. Albans; the younger, James, Lord Beaulieu, died in 1680, while still a boy. The king's death-bed request to his brother, "Let not poor Nelly starve," was faithfully carried out by James II., who paid her debts from the Secret Service fund; provided her with other moneys, and settled on her an estate with reversion to the duke of St. Albans. But she did not long survive her lover's death. She died in November 1687, and was buried on the 17th, according to her own request, in the church of St. Martin-in-the-Fields, her funeral sermon being preached by the vicar, Thomas Tenison, afterwards archbishop of Canterbury, who said "such to her praise." Tradition credits the foundation of Chelsea Hospital to her influence over the king.

See Peter Cunningham's *The Story of Nell Gwyn*, edited by Gordon Goodwin (1903); Waldron's edition of John Downes's *Recessus Anglicanus* (1789); Osmond Airy, *Charles II.* (1904); Pepys, *Diary*; Evelyn, *Diary and Correspondence*; *Origin and Early History of the Royal Hospital at Chelsea*, edited by Major-General G. Hutt (1872); *Memoirs of the Life of Elizabeth Gwyn* (1759); Burnet, *History of My Own Time*, part 1, edited by Osmond Airy (Oxford, 1899); *Louise de Kéroualle, Duchess of Portsmouth*, by H. Foxe, translated by Mrs. Crawford (1887).

GWYNIAD, the name given to a fish of the genus *Coregonus* or White fish (*C. clupeoides*), inhabiting the large lakes of North Wales and the north of England. At Ullswater it is known by the name of "schelly," at Loch Lomond by that of "powen." It is tolerably abundant in Lake Bala, keeping to the deepest portions of the lake for the greater part of the year, but appearing in shoals near the shores at certain seasons. It is well flavoured, like all the species of *Coregonus*, but scarcely attains to the weight of a pound. The name *gwyniad* is a Welsh word, and signifies "shining"; and it is singular that a similar fish in British Columbia, also belonging to the family of Salmonidae, is called by the natives "gwanat," from the silvery lustre of its scales, the word having in their language the same meaning as the Welsh "gwyniad."

GYANTSE, one of the large towns of Tibet. It lies S.E. of Shigatse, 230 m. from the Indian frontier and 145 m. from Lhasa. Its central position at the junction of the roads from India and Bhutan with those from Ladakh and Central Asia leading to Lhasa makes it a considerable distributing trade centre. Its market is the third largest in Tibet, coming after Lhasa and Shigatse, and is especially celebrated for its woollen cloth and carpet manufactures. Here caravans come from Ladakh, Nepal and upper Tibet; bringing gold, borax, salt, wool, mink and furs, to exchange for tea, tobacco, sugar, cotton goods,

bracketed and hardware. The town is compactly built of stone houses, with wooden balconies facing the main street, whence narrow lanes strike off into uninviting slums, and contains a fort and monastery. In the British expedition of 1904 Gyntas formed the first objective of the advance, and the force was bivouaced here in the mission post of Changlo for some time. The Tibetans made a night attack on the post, and were beaten off with some difficulty, but subsequently the British attacked and stormed the fort or jong. Under the treaty of 1904 a British trade agent is stationed at Gyntas.

GYGES, founder of the third or Mermnad dynasty of Lydian kings, he reigned 687-652 B.C. according to H. Gelsler, 690-652 B.C. according to H. Winckler. The chronology of the Lydian kings given by Herodotus has been shown by the Assyrian inscriptions to be about twenty years in excess. Gyges was the son of Dasyteus, who, when recalled from banishment in Cappadocia by the Lydian king Sadyattes—called Candaules "the Dog-strangler" (a title of the Lydian Heracles) by the Greeks—sent his son back to Lydia instead of himself. Gyges soon became a favourite of Sadyattes and was despatched by him to fetch Tude, the daughter of Azanous of Mysia, whom the Lydian king wished to make his queen. On the way Gyges fell in love with Tude, who complained to Sadyattes of his conduct. Forewarned that the king intended to punish him with death, Gyges assassinated Sadyattes in the night and seized the throne with the help of Arseus of Mysia, the captain of the Carian bodyguard, whom he had won over to his cause. Civil war ensued, which was finally ended by an appeal to the oracle of Delphi and the confirmation of the right of Gyges to the crown by the Delphian god. Further to secure his title he married Tude. Many legends were told among the Greeks about his rise to power. That found in Herodotus, which may be traced to the poet Archilochus of Paros, described how "Candaules" insisted upon showing Gyges his wife when undressed, which so enraged her that she gave Gyges the choice of murdering her husband and making himself king, or of being put to death himself. Plato made Gyges a shepherd, who discovered a magic ring by means of which he murdered his master and won the affection of his wife (Hdt. i. 2-14; Plato, *Rep.* 359; Justin i. 7; Cicero, *De off.* iii. 9). Once established on the throne Gyges devoted himself to consolidating his kingdom and making it a military power. The Troed was conquered, Colophon captured from the Greeks, Smyrna besieged and alliances entered into with Ephesus and Miletus. The Cimmerii, who had ravaged Asia Minor, were beaten back, and an embassy was sent to Assur-bani-pal at Nineveh (about 650 B.C.) in the hope of obtaining his help against the barbarians. The Assyrians, however, were otherwise engaged, and Gyges turned to Egypt, sending his faithful Carian troops along with Ionian mercenaries to assist Psammetichus in shaking off the Assyrian yoke (660 B.C.). A few years later he fell in battle against the Cimmerii under Dugdammê (called Lygdams by Strabo i. 3: 21), who took the lower town of Sardis. Gyges was succeeded by his son Ardyas.

See Nicolaus Damascenus, quoting from the Lydian historian Xanthus, in C. Müller, *Fragmenta historicorum Græcorum*, iii.; R. Schubert, *Geschichte der Könige von Lydien* (1884); M. G. Radet, *La Lydie et le monde grec au temps de Mermnades* (1892-1893); H. Gelsler, "Das Zeitalter des Gyges" (*Rhein. Mus.*, 1875); H. Winckler, *Altorientalische Forschungen*, i. (1893); Macan's edition of Herodotus. (A. H. S.)

GYLIPIPPUS, a Spartan general of the 5th century B.C.; he was the son of Cleandridas, who had been expelled from Sparta for accepting Athenian bribes (446 B.C.) and had settled at Thurii. His mother was probably a helot, for Gylippus is said to have been, like Lysander and Callicratidas, a *molax* (see *HELOT*). When Alcibiades urged the Spartans to send a general to lead the Syracusan resistance against the Athenian expedition, Gylippus was appointed, and his arrival was undoubtedly the turning point of the struggle (414-413). Though at first his long hair, his threadbare cloak and his staff furnished the subject of many a jest, and his harsh and overbearing manner caused grave discontent, yet the rapidity and decisiveness of his movements, was the sympathy and respect of the Syracusans. Diodorus (xiii. 28-32);

probably following Timæus, represents him as inducing the Syracusans to pass sentence of death on the captive Athenian generals, but we need have no hesitation in accepting the statement of Philistus (Plutarch, *Nicias*, 28), a Syracusan who himself took part in the defence, and Thucydides (vii. 86), that he tried, though without success, to save their lives, wishing to take them to Sparta as a signal proof of his success. Gylippus fell, as his father had done, through avarice; entrusted by Lysander with an immense sum which he was to deliver to the ephors at Sparta, he could not resist the temptation to enrich himself and, on the discovery of his guilt, went into exile.

Thucydides vi. 93-104. vii.; Plutarch, *Nicias*, 19, 21, 27, 28, *Lysander*, 16, 17; Diodorus xiii. 7, 8, 28-32; Polyænus i. 39. 42). See SYRACUSE (for the siege operations), commentaries on Thucydides and the Greek histories.

GYLLENBOURG-EHRENSVÄRD, THOMASINE CHRISTINE, BARONESS (1775-1856); Danish author, was born on the 9th of November 1775, at Copenhagen. Her maiden name was Eustens. Her great beauty early attracted notice, and before she was seventeen she married the famous writer Peter Andreas Heiberg. To him she bore in the following year a son, afterwards illustrious as the poet and critic Johan Ludvig Heiberg. In 1800 her husband was exiled, and she obtained a divorce, marrying in December 1801 the Swedish Baron K. F. Ehrensvärd, himself a political fugitive. Her second husband, who presently adopted the name of Gyllembourg, died in 1815. In 1822 she followed her son to Kiel, where he was appointed professor, and in 1825 she returned with him to Copenhagen. In 1827 she first appeared as an author by publishing her romance of *The Palombus Family* in her son's newspaper *Flyvende Post*. In 1828 the same journal contained *The Magic Ring*, which was immediately followed by *En Hverdags historie* (*An Everyday Story*). The success of this anonymous work was so great that the author adopted until the end of her career the name of "The Author of *An Everyday Story*." In 1833-1834 she published three volumes of *Old and New Novels*. *New Stories* followed in 1835 and 1836. In 1839 appeared two novels, *Mattomas the Younger and Ricidar*; in 1840, *One in All*; in 1841, *Near and Far*; in 1843, *A Correspondence*; in 1844, *The Cross Ways*; in 1845, *Two Generations*. From 1849 to 1851 the Baroness Ehrensvärd-Gyllembourg was engaged in bringing out a library edition of her collected works in twelve volumes. On the 2nd of July 1856 she died in her son's house at Copenhagen. Not until then did the secret of her authorship transpire; for throughout her life she had preserved the closest reticence on the subject even with her nearest friends. The style of Madame Ehrensvärd-Gyllembourg is clear and sparkling; for English readers no closer analogy can be found than between her and Mrs Gaskell, and *Cranford* might well have been written by the witty Danish authoress.

See J. L. Heiberg, *Peter Andreas Heiberg og Thomsine Gyllembourg* (Copenhagen, 1882), and L. Kornelius-Hybel, *Nogle Bemærkninger om P. A. Heiberg og Fru Gyllembourg* (Copenhagen, 1883).

GYLLENSTJERNÄ, JOHAN, COUNT (1635-1686), Swedish statesman, completed his studies at Upsala and then visited most of the European states and laid the foundations of that deep insight into international politics which afterwards distinguished him. On his return home he met King Charles X. in the Danish islands and was in close attendance upon him till the monarch's death in 1660. He began his political career at the diet which assembled in the autumn of the same year. An aristocrat by birth and inclination, he was nevertheless a true patriot and demanded the greatest sacrifices from his own order in the national interests. He was therefore one of those who laboured most zealously for the recovery of the crown lands. In the Upper House he was the spokesman of the gentry against the magnates, whose inordinate privileges he would have curtailed or abolished. His adversaries vainly endeavoured to gain him by favour, for as court-marshal and senator he was still more hostile to the dominant patricians who followed the adventurous policy of Magnus de la Gardie. Thus he opposed the French alliance which de la Gardie carried through in 1672, and consistently advocated economy in domestic and neutrality in foreign affairs. On the outbreak of the war in 1675 he was the

most loyal and energetic supporter of the young Charles XI, and finally his indispensable counsellor. Indeed, it may be said, that the political principles which he instilled into the youthful monarch were faithfully followed by Charles during the whole of his reign. In 1679 Gyllenstjerna was appointed the Swedish plenipotentiary at the peace congress of Lund. The alliance which he then concluded with Denmark bound the two northern realms together in a common foreign policy, and he sought besides to facilitate their harmonious co-operation by every means in his power. In 1680, after bringing home Charles XI's Danish bride from Copenhagen, he was appointed governor-general of Scania (Skåne), but expired a few weeks later.

See M. Hoyer, *Öfversigt af Sveriges yttra politik under åren 1676-1680* (Upsala, 1875).

GYMKHANA, a display of miscellaneous sports, originally at the military stations of India. The word would seem to be a colloquial remodelling of the Hindustani *gend-khana*, ball-house or racket-court, by substituting for *gend* the first syllable of the English word "gymnastics." The definition given in Yule's *Glossary* is as follows: "A place of public resort at a station, where the needful facilities for athletics and games . . . are provided." The name of the place was afterwards applied to the games themselves, and the word is now used almost exclusively in this sense. According to Yule the first use of it that can be traced was, on the authority of Major John Trotter, at Rurki in the year 1861, when a gymkhana was instituted there. Gymkhana sports were invented to relieve the monotony of Indian station life, and both officers and men from the ranks took part in them. The first meetings consisted of promiscuous horse and pony races at catch weights. To these were soon added a second variety, originally called the *paḡā* (funny races), the one generally known outside India, which consisted of miscellaneous races and competitions of all kinds, some serious and some amusing, on horseback, on foot and on bicycles. Among these may be mentioned the usual military sports; such as tent-pegging, lemon-cutting and obstacle racing; rickshaw racing; tilting at the ring, sack, pillow, hurdle, egg-and-spoon, blindfold, threading-the-needle and many other kinds of races depending upon the inventive powers of the committees in charge.

GYMNASTICS AND GYMNASIUM, terms signifying respectively a system of physical exercises practised either for recreation or for the purpose of promoting the health and development of the body, and the building where such exercises are carried on. The gymnasium of the Greeks was originally the school where competitors in the public games received their training, and was so named from the circumstance that these competitors exercised naked (*γυμνός*). The gymnasium was a public institution as distinguished from the palaestra, which was a private school where boys were trained in physical exercises, though the term palaestra is also often used for the part of a gymnasium specially devoted to wrestling and boxing. The athletic contests for which the gymnasium supplied the means of training and practice formed part of the social life of the Greeks from the earliest times. They were held in honour of heroes and gods; sometimes forming part of a periodic festival, sometimes of the funeral rites of a deceased chief. In course of time the Greeks grew more attached to such sports; their free active life, spent to a great extent in the open air, fostered the liking almost into a passion. The victor in any athletic contest, though he gained no money prize, was rewarded with the honour and respect of his fellow citizens; and a victory in the great religious festivals was counted an honour for the whole state. In these circumstances the training of competitors for the greater contests became a matter of public concern; and accordingly special buildings were provided by the state, and their management entrusted to public officials. The regulation of the gymnasium at Athens is attributed by Pausanias (i. 39. 3) to Theseus. Solon made several laws on the subject; but according to Galen it was reduced to a system in the time of Cleisthenes. Ten *gymnasiarchs*, one from each tribe, were appointed annually. These performed in rotation the duties of their office, which were to maintain and pay the persons who

were training for public contests, to conduct the games at the great Athenian festivals, to exercise general supervision over the morals of the youths, and to adorn and keep up the gymnasium. This office was one of the ordinary *ἀστροπύλας* (public services), and great expense was entailed on the holders. Under them were ten *ἐπιθροναίτες*, whose duty was to watch the conduct of the youths at all times, and especially to be present at all their games. The practical teaching and selecting of the suitable exercises for each youth were in the hands of the *παιδαγωγοί* and *γυμναστές*, the latter of whom also superintended the effect on the constitution of the pupils, and prescribed for them when they were unwell. The *αἰθίλας* oiled and rubbed dust on the bodies of the youths; acted as surgeons, and administered the drugs prescribed. According to Galen there was also a teacher of the various games of ball. The gymnasia built to suit these various purposes were large buildings, which contained not merely places for each kind of exercise, but also a stadium, baths, covered porticoes for practice in bad weather, and outer portions where the philosophers and men of letters read public lectures and held disputations.

The gymnasium of the Greeks did not long remain an institution exclusively devoted to athletic exercises. It soon began to be applied to other uses even more important. The development arose naturally through the recognition by the Greeks of the important place in education occupied by physical culture, and of the relation between exercise and health. The gymnasium accordingly became connected with education on the one hand and with medicine on the other. Due training of the body and maintenance of the health and strength of children were the chief part of earlier Greek education. Except the time devoted to letters and music, the education of boys was conducted in the gymnasia, where provision was made, as already mentioned, for their moral as well as their physical training. As they grew older, conversation and social intercourse took the place of the more systematic discipline. Philosophers and sophists assembled to talk and to lecture in the gymnasia, which thus became places of general resort for the purpose of all less systematic intellectual pursuits, as well as for physical exercises. In Athens there were three great public gymnasia—Academy, Lyceum and Cynosarges—each of which was consecrated to a special deity with whose statue it was adorned; and each was rendered famous by association with a celebrated school of philosophy. Plato's teaching in the Academy has given immortality to that gymnasium; Aristotle conferred lustre on the Lyceum; and the Cynosarges was the resort of the Cynics. Plato when treating of education devotes much consideration to gymnastics (see especially *Rep.* iii. and various parts of *Lysis*); and according to Plato it was the sophist Prodicus who first pointed out the connexion between gymnastics and health. Having found such exercises beneficial to his own weak health, he formulated a method which was adopted generally, and which was improved by Hippocrates. Galen lays the greatest stress on the proper use of gymnastics, and throughout ancient medical writers we find that special exercises are prescribed as the cure for special diseases.

The Greek institution of the gymnasium never became popular with the Romans, who regarded the training of boys in gymnastics with contempt as conducive to idleness and immorality, and of little use from a military point of view; though at Sparta gymnastic training had been chiefly valued as encouraging warlike tastes and promoting the bodily strength needed for the use of weapons and the endurance of hardship. Among the Romans of the republic, the games in the Campus Martius, the duties of camp life, and the enforced marches and other hardships of actual warfare, served to take the place of the gymnastic exercises required by the Greeks. The first public gymnasium at Rome was built by Nero and another by Commodus. In the middle ages, though jousts and feats of horsemanship and field sports of various kinds were popular, the more systematic training of the body which the Greeks had associated with the gymnasium fell into neglect; while the therapeutic value of special exercises as understood by Hippocrates and Galen appears to have been lost sight of. Rousseau, in his *Emile*, was the first in modern times to call attention to the injurious consequences of such

indifference, and he insisted on the importance of physical culture as an essential part of education. It was probably due in some measure to his influence that F. L. Jahn and his followers in Germany, encouraged by the Prussian minister Stein, established the *Turnplätze*, or gymnastic schools, which played an important part during the War of Liberation, and in the political agitations which followed the establishment of the German confederation by the Congress of Vienna. The educational reformers Pestalozzi and Froebel emphasized the need for systematic physical training in any complete scheme of education.

The later development of the classical gymnasium (when it had become the school of intellectual culture rather than of exclusively physical exercise), and not the original idea, has been perpetuated in the modern use of the word in Germany, where the name "gymnasium" is given to the highest grade of secondary school, and the association of the word with athleticism has been entirely abandoned. On the other hand, in England, France and elsewhere in Europe, as well as in America, the history of the word has been precisely the reverse; the connexion of the gymnasium with philosophy and mental culture has been dropped, and it indicates a building exclusively intended for the practice of physical exercises. But whereas the Greeks received training in the gymnasium for contests which are now designated as *athletic sports* (*q.v.*), gymnastics in the modern sense is a term restricted to such exercises as are usually practised indoors, with or without the aid of mechanical appliances, as distinguished from sports or games practised in the open air.

It was not until near the end of the 19th century that gymnastics were recognized in England as anything more than a recreation; their value as a specifically therapeutic agent, or as an article in the curriculum of elementary schools, was not realized. More recently, however, educationists have urged with increasing insistence the need for systematic physical training, and their views received greater attention when evidence of deterioration in the physique of the people began to accumulate. During the first decade of the 20th century more than one commission reported to parliament in England in favour of more systematic and general physical training being encouraged or even made compulsory by public authority. Voluntary associations were formed for encouraging such training and providing facilities for it. Gymnastics had already for several years been an essential part of the training of army recruits with exceedingly beneficial results, and gymnasia had been established at Aldershot and other military centres. Physical exercises, although not compulsory, obtained a permanent place in the code for elementary schools in Great Britain; and much care has been taken to provide a syllabus of exercises adapted for the improvement of the physique of the children. These exercises are partly gymnastic and partly of the nature of drill; they do not in most cases require the use of appliances, and are on that account known as "free movements," which numbers of children go through together, accompanied whenever possible by music. On the other hand at the larger public schools and universities there are elaborate gymnasia equipped with a great variety of apparatus, the skilful use of which demands assiduous practice; and this is encouraged by annual contests between teams of gymnasts representing rival institutions.

The appliances vary to some extent in different gymnasia, some of the more complicated requiring a greater amount of space and involving a larger cost than is often practicable. But where these considerations are negligible, substantial uniformity is to be found in the equipment of gymnasia not designed for specifically medical purposes. The simplest, and in many respects the most generally useful, of all gymnastic apparatus is the dumb-bell. It was in use in England as early as the time of Elizabeth, and it has the advantage that it admits of being exactly proportioned to the individual strength of each learner, and can be adjusted in weight as his strength increases. The exercises that may be performed with the dumb-bell, combined with a few simple drill-like movements, give employment to all parts of the body and to both sides equally. Dumb-bell exercises, therefore, when

arranged judiciously and with knowledge, are admirably suited for developing the physique, and are extensively employed in schools both for boys and girls. The bar-bell is merely a two-handed dumb-bell, and its use is similar in principle. The Indian club is also in use in most gymnasia; but the risk of overstraining the body by its unskilful handling makes it less generally popular than the dumb-bell. All these appliances may be, and often are, used either in ordinary schoolrooms or elsewhere outside the gymnasium. The usual fixed sorts of apparatus, the presence of which (or of some of them) in a building may be said to constitute it a gymnasium, are the following: a leaping-rope; a leaping-pole; a vaulting-horse; a horizontal bar, so mounted between two upright posts that its height from the ground may be adjusted as desired; parallel bars, used for exercises to develop the muscles of the trunk and arms; the trapeze consisting of a horizontal bar suspended by ropes at a height of 4 to 5 ft. from the ground; the bridge ladder; the plank; the inclined plane; the mast; swinging rings; the prepared wall; the horizontal beam.

Before the end of the 19th century the therapeutic value of gymnastics was fully realized by the medical profession; and a number of medical or surgical gymnasia came into existence, provided with specially devised apparatus for the treatment of different physical defects or weaknesses. The exercises practised in them are arranged upon scientific principles based on anatomical and physiological knowledge; and these principles have spread thence to influence largely the practice of gymnastics in schools and in the army. A French medical writer enumerates seven distinct groups of maladies, each including a number of different complaints, for which gymnastic exercises are a recognized form of treatment; and there are many malformations of the human body, formerly believed to be incurable, which are capable of being greatly remedied if not entirely corrected by regular gymnastic exercises practised under medical direction.

The value of gymnastics both for curing defects, and still more for promoting health and the development of normal physique, is recognized even more clearly on the continent of Europe than in Great Britain. In Germany the government not only controls the practice of gymnastics but makes it compulsory for every child and adult to undergo a prescribed amount of such physical training. In France also, physical training by gymnastics is under state control; in Sweden, Denmark, Switzerland, Italy, Russia, systems more or less distinct enjoy a wide popularity; and in Finland gymnastics are practised on lines that exhibit national peculiarities. The Finns introduce an exceptional degree of variety into their exercises as well as into the appliances devised to assist them; women are scarcely less expert than men in the performance of them; and the enthusiasm with which the system is supported produces the most beneficial results in the physique of the people. International gymnastic contests have become a feature of the revived Olympic Games (see *ATHLETIC SPORTS*), and in those held at Athens in 1906 a team of Danish ladies took part in the competition and proved by their skilful performance that gymnastics may be practised with as much success by women as by men.

The chief work on the ancient gymnastics is Krause, *Gymnastik und Agonistik der Hellenen* (1841); of more recent works mention may be made of Jäger, *Gymnastik der Hellenen* (1881); L. Grasberger, *Erziehung und Unterricht im klassischen Altertum* (1881); J. P. Mahaffy, *Old Greek Education* (1883); A. S. Wilkins, *National Education in Greece* (1873); E. Paz, *Histoire de la gymnastique* (1886); Wickenhagen, *Antike und moderne Gymnastik* (1891); Beckler-Göll, *Charicles II.*; Brugna, *Gymnastium apud Græcos descriptio* (1855); Petersen, *Das Gymnasium der Griechen* (1838). See also N. Laisné, *Gymnastique pratique* (Paris, 1870); Collineau, *La Gymnastique* (Paris, 1884); *L'Hypisme à l'école* (Paris, 1889); P. de Coubertin, *La Gymnastique utilitaire* (Paris, 1905); H. Nissen, *Rational Home Gymnastics* (Boston, 1903). (R. J. M.)

GYMNOSOPHISTS (Lat. *gymnosophistæ*, from Gr. *γυμνός*, *sophistês*, "naked philosophers"), the name given by the Greeks to certain ancient Hindu philosophers who pursued asceticism to the point of regarding food and clothing as detrimental to purity of thought. From the fact that they often

lived as hermits in forests, the Greeks also called them *Hylotiboi* (cf. the *Vāna-prasthās* in Sanskrit writings). Diogenes Laërtius (ix. 61 and 63) refers to them, and asserts that Pyrrho of Elis, the founder of pure scepticism, came under their influence, and on his return to Elis imitated their habits of life, to what extent does not appear. Strabo (xv. 711, 714) divides them into Brahmins and Sarmans (or Shamans). See JAINA.

GYMNOSPERMS, in Botany. The Gymnosperms, with the Angiosperms, constitute the existing groups of seed-bearing plants or Phanerogams: the importance of the seed as a distinguishing feature in the plant kingdom may be emphasized by the use of the designation Spermophyta for these two groups, in contrast to the Pteridophyta and Bryophyta in which true seeds are unknown. Recent discoveries have, however, established the fact that there existed in the Palaeozoic era fern-like plants which produced true seeds of a highly specialised type; this group, for which Oliver and Scott proposed the term *Pteridospermae* in 1904, must also be included in the Spermophyta. Another instance of the production of seeds in an extinct plant which further reduces the importance of this character as a distinguishing feature is afforded by the Palaeozoic genus *Lepidocarpon* described by Scott in 1901; this lycopodiaceous type possessed an integumented megaspore, to which the designation seed may be legitimately applied (see PALAEOBOTANY: *Palaeozoic*).

As the name Gymnosperm (Gr. *γυμνός*, naked, *σπέρμα*, seed) implies, one characteristic of this group is the absence of an ovary or closed chamber containing the ovules. It was the English botanist Robert Brown who first recognized this important distinguishing feature in conifers and cycads in 1825; he established the gymnospermy of these seed-bearing classes as distinct from the angiospermy of the monocotyledons and dicotyledons. As Sachs says in his history of botany, "no more important discovery was ever made in the domain of comparative morphology and systematic botany." As Coulter and Chamberlain express it, "the habits of the Gymnosperms to-day indicate that they either are not at home in the more genial conditions affected by Angiosperms, or have not been able to maintain themselves in competition with this group of plants."

These naked-seeded plants are of special interest on account of their great antiquity, which far exceeds that of the Angiosperms, and as comprising different types which carry us back to the Palaeozoic era and to the forests of the coal period. The best known and by far the largest division of the Gymnosperms is that of the cone-bearing trees (pines, firs, cedars, larches, &c.), which play a prominent part in the vegetation of the present day, especially in the higher latitudes of the northern hemisphere; certain members of this class are of considerable antiquity, but the conifers as a whole are still vigorous and show but little sign of decadence. The division known as the Cycadophyta is represented by a few living genera of limited geographical range and by a large number of extinct types which in the Mesozoic era (see PALAEOBOTANY: *Mesozoic*) played a conspicuous part in the vegetation of the world. Among existing Cycadophyta we find surviving types which, in their present isolation, their close resemblance to fossil forms, and in certain morphological features, constitute links with the past that not only connect the present with former periods in the earth's history, but serve as sign-posts pointing the way back along one of the many lines which evolution has followed.

It is needless to discuss at length the origin of the Gymnosperms. The two views which find most favour in regard to the Coniferales and Cycadophyta are: (1) that both have been derived from remote filicinean ancestors; (2) that the cycads are the descendants of a fern-like stock, while conifers have been evolved from lycopodiaceous ancestors. The line of descent of recent cycads is comparatively clear in so far as they have undoubted affinity with Palaeozoic plants which combined cycadean and filicinean features; but opinion is much more divided as to the nature of the phylum from which the conifers are derived. The Cordaitales (see PALAEOBOTANY: *Palaeozoic*) are represented by extinct forms only, which occupied a prominent

position in the Palaeozoic period; these plants exhibit certain features in common with the living Araucariaceae, and others which invite a comparison with the maidenhair tree (*Ginkgo biloba*), the solitary survivor of another class of Gymnosperms, the Ginkgoales (see PALAEOBOTANY: *Mesozoic*). The Gnetales are a class apart, including three living genera, of which we know next to nothing as regards their past history or line of descent. Although there are several morphological features in the three genera of Gnetales which might seem to bring them into line with the Angiosperms, it is usual to regard these resemblances as parallel developments along distinct lines rather than to interpret them as evidence of direct relationship.

Gymnospermae.—Trees or shrubs; leaves vary considerably in size and form. Flowers unisexual, except in a few cases (Gnetales) without a perianth. Monoecious or dioecious. Ovules naked, rarely without carpellary leaves, usually borne on carpophylls, which assume various forms. The single megaspore enclosed in the nucellus is filled with tissue (prothallus) before fertilization, and contains two or more archegonia, consisting usually of a large egg-cell and a small neck, rarely of an egg-cell only and no neck (*Gnetum* and *Welwitschia*). Microspore spherical or oval, with or without a bladder-like extension of the exine, containing a prothallus of two or more cells, one of which produces two non-motile or motile male cells. Cotyledons two or several. Secondary xylem and phloem produced by a single cambium, or by successive cambial zones; no true vessels (except in the Gnetales) in the wood, and no companion-cells in the phloem.

- I. *Pteridospermae* (see PALAEOBOTANY, PALAEOZOIC).
- II. *Cycadophyta*.
 - A. Cycadales (recent and extinct).
 - B. Bennettitales (see PALAEOBOTANY: *Mesozoic*).
- III. *Cordaitales* (see PALAEOBOTANY: *Palaeozoic*).
- IV. *Ginkgoales* (recent and extinct).
- V. *Coniferales*.
 - A. Taxaceae.
 - B. Pinaceae.

There is no doubt that the result of recent research and of work now in progress will be to modify considerably the grouping of the conifers. The family *Araucariaceae*, represented by *Araucaria* and *Agathis*, should perhaps be separated as a special class and a rearrangement of other genera more in accord with a natural system of classification will soon be possible; but for the present its twofold subdivision may be retained.

- VI. *Gnetales*.
 - A. Ephedroideae.
 - B. Gnetoideae.
 - C. Welwitschioidae (Tumboideae).

CYCADOPHYTA.—A. *Cycadales*.—Stems tuberous or columnar, not infrequently branched, rarely epiphytic (Peruvian species of *Zamia*); fronds pinnate, bi-pinnate in the Australian genus *Bowsonia*. Dioecious; flowers in the form of cones, except the female flowers of *Cycas*, which consist of a rosette of leaf-like carpels at the apex of the stem. Seeds albuminous, with one integument; the single embryo, usually bearing two partially fused cotyledons, is attached to a long tangled suspensor. Stems and roots increase in diameter by secondary thickening, the secondary wood being produced by one cambium or developed from successive cambium-rings.

The cycads constitute a homogeneous group of a few living members confined to tropical and sub-tropical regions. As a fairly typical and well-known example of the Cycadaceae, a species of the genus *Cycas* (e.g. *C. circinalis*, *C. revoluta*, &c.) is briefly described. The stout columnar stem may reach a height of 20 metres, and a diameter of half a metre; it remains either unbranched or divides near the summit into several short and thick branches, each branch terminating in a crown of long pinnate leaves. The surface of the stem is covered with rhomboidal areas, which represent the persistent bases of foliage- and scale-leaves. In some species of *Cycas* there is a well-defined alternation of transverse zones on the stem, consisting of larger areas representing foliage-leaf bases, and similar but smaller areas formed by the bases of scale-leaves (*F* and *S*, fig. 1). The scale-leaves clothing the terminal bud are linear-lanceolate in form, and of a brown or yellow colour; they are pushed aside as the stem-axis elongates and becomes shrivelled, finally falling off, leaving projecting bases which are eventually cut off at a still lower level. Similarly, the dead fronds fall off, leaving a ragged petiole, which is afterwards separated from the stem by an absciss-layer a short distance above the base. In some species of *Cycas* the leaf-bases do not persist as a permanent covering to the stem, but the surface

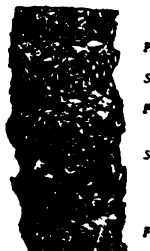

FIG. 1.—Stem of *Cycas*. *F*, foliage-leaf bases; *S*, scale-leaf bases.

is covered with a wrinkled bark, as in *Cycas siamensis*, which has a stem of unusual form (fig. 2). Small tuberous shoots, comparable on a large scale with the bulbils of *Lycopodium Selago*, are occasionally produced in the axils of some of the persistent leaf-bases; these are characteristic of sickly plants, and serve as a means of vegetative reproduction. In the genus *Cycas* the female flower is peculiar among cycads in consisting of a terminal crown of separate leaf-like carpels several inches in length; the apical portion of each carpellary leaf may be broadly triangular in form, and deeply dissected on the margins into narrow woolly appendages like rudimentary pinnae.



FIG. 2.—*Cycas siamensis*.

From the lower part of a carpel are produced several laterally placed ovules, which become bright red or orange on ripening; the bright fleshy seeds, which in some species are as large as a goose's egg, and the tawny spreading carpels produce a pleasing combination of colour in the midst of the long dark-green fronds, which curve gracefully upwards and outwards from the summit of the columnar stem. In *Cycas* the stem apex, after producing a cluster of carpellary leaves, continues to elongate and produces more bud-scales, which are afterwards pushed aside as a fresh crown of fronds is developed.

The young leaves of *Cycas* consist of a straight rachis bearing numerous linear pinnae, traversed by a single midrib; the pinnae are circinately coiled like the leaf of a fern (fig. 3). The male flower of *Cycas* conforms to the type of structure characteristic of the cycads, and consists of a long cone of numerous sporophylls bearing many oval pollen-sacs on their lower faces. The type described serves as a convenient representative of its class. There are eight other living genera, which may be classified as follows:—

Classification.—A. *Cycadeae*.—Characterized by (a) the alternation of scale- and foliage-leaves (fig. 1) on the branched or unbranched stem; (b) the growth of the main stem through the female flower; (c) the presence of a prominent single vein in the linear pinnae; (d) the structure of the female flower, which is peculiar in not having the form of a cone, but consists of numerous independent carpels, each of which bears two or more lateral ovules. Represented by a single genus, *Cycas*. (Tropical Asia, Australia, &c.).

B. *Zamiaceae*.—The stem does not grow through the female flower; both male and female flowers are in the form of cones. (a) *Stangeriaceae*.—Characterized by the fern-like venation of the pinnae, which have a prominent midrib, giving off at a wide angle simple or forked and occasionally anastomosing lateral veins. A single genus, *Stangeria*, confined to South Africa. (b) *Eusamiaceae*.—The pinnae are traversed by several parallel veins. *Bowenia*, an Australian cycad, is peculiar in having bi-pinnate fronds (fig. 5). The various genera are distinguished from one another by the shape and manner of attachment of the pinnae, the form of the carpellary scales, and to some extent by anatomical characters. *Encephalartos* (South and Tropical Africa).—Large cones; the carpellary scales terminate in a peltate distal expansion. *Macrozamia* (Australia).—Similar to *Encephalartos* except in the presence of a spinous projection from the swollen distal end of the carpels. *Zamia* (South America, Florida, &c.).—Stem short and often divided into several columnar branches. Each carpel terminates in a peltate head. *Ceratozamia* (Mexico).—Similar in habit to *Macrozamia*, but distinguished by the presence of two horn-like Young Fronds, spinous processes on the apex of the carpels.

Mitocyclus (Cuba).—Like *Zamia*, except that the ends of the stamens are flat, while the apices of the carpels are peltate. *Dioon* (Mexico) (fig. 4).—Characterized by the woolly scale-leaves and carpels; the latter terminate in a thick laminar expansion of triangular form, bearing two placental cushions, on which the ovules are situated. *Bowenia* (Australia).—Bi-pinnate fronds; stem short and tuberous (fig. 5).

The stems of cycads are often described as unbranched; it is true that in comparison with conifers, in which the numerous branches, springing from the main stem, give a characteristic form to the tree, the tuberous or columnar stem of the Cycadaceae constitutes a striking distinguishing feature. Branching, however, occurs not infrequently; in *Cycas* the tall stem often produces several candelabra-like arms; in *Zamia*

Stem and leaf.

the main axis may break up near the base into several cylindrical branches; in species of *Dioon* (fig. 4) lateral branches are occasionally produced. The South African *Encephalartos* frequently produces several branches. Probably the oldest example of this genus in cultivation is in the Botanic Garden of Amsterdam, its age is considered by Professor de Vries to be about two thousand years; although an accurate determination of age is impossible, there is no doubt that many cycads grow very slowly and are remarkable for longevity. The thick armour of petiole-bases enveloping the stem is a characteristic Cycadean feature; in *Cycas* the alternation of scale-leaves and fronds is more clearly shown than in other cycads; in *Encephalartos*, *Dioon*, &c., the persistent scale-leaf bases are almost equal in size to those of the foliage-leaves, and there is no regular alternation of zones such as characterizes some species of *Cycas*. Another type of stem is illustrated by *Stangeria* and *Zamia*, also by a few forms of *Cycas* (fig. 2), in which the fronds fall off



From a photograph of a plant in the Peradeniya Gardens, Ceylon, by Professor R. H. Yapp.

FIG. 4.—*Dioon edule*.

From a photograph of a plant in the Peradeniya Gardens, Ceylon, by Professor R. H. Yapp.



FIG. 5.—*Bowenia spectabilis*: frond.

completely, leaving a comparatively smooth stem. The *Cycas* type of frond, except as regards the presence of a midrib in each pinna, characterizes the cycads generally, except *Bowenia* and *Stangeria*.

In the monotypic genus *Bowenia* the large fronds, borne singly on the short and thick stem, are bi-pinnate (fig. 5); the segments, which are broadly ovate or rhomboidal, have several forked spreading veins, and resemble the large pinnules of some species of *Adiantum*. In *Stangeria*, also a genus represented by one species (*S. paradoxa* of South Africa), the long and comparatively broad pinnae, with an entire or irregularly incised margin, are very fern-like, a circumstance which led Kunze to describe the plant in 1835 as a species of the fern *Lomaria*. In rare cases the pinnae of cycads are lobed or branched: in *Dioon spinulosum* (Central America) the margin of the segments bears numerous spinous processes; in some species of *Encephalartos*, e.g. *E. horridus*, the lamina is deeply lobed; and in a species of the Australian genus *Macrozamia*, *M. heteromera*, the narrow pinnae are dichotomously branched almost to the base (fig. 6), and resemble the frond of some species of the fern *Schizaea*, or the fossil genus *Baiera* (Ginkgoales). An interesting species of *Cycas*, *C. Micholitzii*, has recently been described by Sir William Thistlethorn-Dyer from Annam, where it was collected by one of Messrs Sanders & Son's collectors, in which the pinnae instead of being of the usual simple type are



FIG. 6.—*Macrozamia heteromera*. A, part of and in a species of the Australian genus frond; B, single pinna. *Macrozamia*, *M. heteromera*, the narrow pinnae are dichotomously branched almost to the base (fig. 6), and resemble the frond of some species of the fern *Schizaea*, or the fossil genus *Baiera* (Ginkgoales). An interesting species of *Cycas*, *C. Micholitzii*, has recently been described by Sir William Thistlethorn-Dyer from Annam, where it was collected by one of Messrs Sanders & Son's collectors, in which the pinnae instead of being of the usual simple type are

dichotomously branched as in *Macrozamia heteromera*. In *Ceratonia* the broad petiole-base is characterized by the presence of two lateral spinous processes, suggesting stipular appendages, comparable, on a reduced scale, with the large stipules of the Marattiaceae among Ferns. The vernation varies in different genera; in *Cycas* the rachis is straight and the pinnae circinate-coiled (fig. 3); in *Encephalartos*, *Dioon*, &c., both rachis and segments are straight; in *Zamia* the rachis is bent or slightly coiled, bearing straight pinnae. The young leaves arise on the stem-apex as conical protuberances with winged borders on which the pinnae appear as rounded humps, usually in basipetal order; the scale-leaves in their young condition resemble fronds, but the lamina remains undeveloped. A feature of interest in connexion with the phylogeny of cycads is the presence of long hairs clothing the scale-leaves, and forming a cap on the summit of the stem-apex or attached to the bases of petioles; on some fossil cycadean plants these outgrowths have the form of scales, and are identical in structure with the rammenta (paleae) of the majority of ferns.

The male flowers of cycads are constructed on a uniform plan, and in all cases consist of an axis bearing crowded, spirally disposed sporophylls. These are often wedge-shaped and angular in some cases they consist of a short, thick stalk, terminating in a petate expansion, or prolonged upwards in the form of a triangular lamina. The sporangia (pollen-sacs), which occur on the under-side of the stamens, are often arranged in more or less definite groups or sori, interspersed with hairs (paraphyses); dehiscence takes place along a line marked out by the occurrence of smaller and thinner-walled cells bounded by larger and thicker-walled elements, which form a fairly prominent cap-like "annulus" near the apex of the sporangium, not unlike the annulus characteristic of the Schizaeaceae among ferns. The sporangial wall, consisting of several layers of cells, encloses a cavity containing numerous oval spores (pollen-grains). In structure a cycadean sporangium recalls those of certain ferns (Marattiaceae, Osmundaceae and Schizaeaceae), but in the development of the spores there are certain peculiarities not met with among the Vascular Cryptogams. With the exception of *Cycas*, the female flowers are also in the form of cones, bearing numerous carpellary scales. In *Cycas revoluta* and *C. circinalis* each leaf-like carpel may produce several laterally attached ovules, but in *C. Normanbyana* the carpel is shorter and the ovules are reduced to two, this latter type brings us nearer to the carpels of *Dioon*, in which the flower has the form of a cone, and the distal end of the carpels is longer and more leaf-like than in the other genera of the *Zamiaceae*, which are characterized by shorter carpels with thick petate heads bearing two ovules on the morphologically lower surface. The cones of cycads attain in some cases (e.g. *Encephalartos*) a considerable size, reaching a length of more than a foot. Cases have been recorded (by Thiselton-Dyer in *Encephalartos* and by Wieland in *Zamia*) in which the short carpellary cone-scales exhibit a foliaceous form. It is interesting that no monostrobous cycadean cone has been described in which ovuliferous and staminate appendages are borne on the same axis: in the Bennettitales (see PALAEOBOTANY: Mesozoic) flowers were produced bearing on the same axis both androecium and gynoecium.

The pollen-grains when mature consist of three cells, two small and one large cell; the latter grows into the pollen-tube, as in the *Microspores* and *Megaspores*. A remarkable exception to this rule has recently been recorded by Caldwell, who found that in *Micropitys Calotoma* the body-cells may be eight or even ten in number and the sperm-cells twice as numerous. One of the most important discoveries made during the latter part of the 19th century was that by Ikeno, a Japanese botanist, who first demonstrated the existence of motile male cells in the genus *Cycas*. Similar spermatozooids were observed in some species of *Zamia* by H. J. Webber, and more recent work enables us to assume that all cycads produce ciliated male gametes. Before following the growth of the pollen-grain after pollination, we will briefly describe the structure of a cycadean ovule. An ovule consists of a conical nucellus surrounded by a single integument. At an early stage of development a large cell makes its appearance in the central region of the nucellus; this increases in size and eventually forms three cells; the lowest of these grows vigorously and constitutes the megaspore (embryo-sac), which ultimately absorbs the greater part of the nucellus. The megaspore-nucleus divides repeatedly, and cells are produced from the peripheral region inwards, which eventually fill the sporocavity with a homogeneous tissue (prothallus); some of the superficial cells at the micropylar end of the megaspore increase in size and divide by a tangential wall into two, an upper cell which gives rise to the short two-celled neck of the archegonium, and a lower cell which develops into a large egg-cell. Each megaspore may contain 2 to 6 archegonia. During the growth of the ovum nourishment is supplied from the contents of the cells immediately surrounding the egg-cell, as in the development of the ovum of *Pinus* and other conifers. Meanwhile the tissue in the apical region of the nucellus has been undergoing disorganization, which results in the formation of a pollen-chamber (fig. 7, C) immediately above the megaspore. Pollination in cycads has always been described as anemophilous, but according to recent observations by Pearson on South African species it seems probable that, at least in some

cases, the pollen is conveyed to the ovules by animal agency. The pollen-grains find their way between the carpophylls, which at the time of pollination are slightly apart owing to the elongation of the internodes of the flower-axis, and pass into the pollen-chamber; the large cell of the pollen-grain grows out into a tube (P), which penetrates the nucellar tissue and often branches repeatedly; the pollen-grain itself, with the prothallus-cells, projects freely into the pollen-chamber (fig. 7). The nucleus of the outermost (second small cell (fig. 7, G) divides, and one of the daughter-nuclei passes out of the cell, and may enter the lowest (first) small cell. The outermost cell, by the division of the remaining nucleus, produces two large spermatozooids (fig. 8, a, a). In *Micropitys* 16 sperm-cells are produced. In the course of division two bodies appear in the cytoplasm, and behave as centrosomes; during the karyokinesis; they gradually become threadlike and coil round each daughter nucleus. This thread gives rise to a spiral ciliated band lying in a depression on the body of each spermatozoid; the large spermatozoid eventually escape from the pollen-tube, and are able to perform ciliary movements in the watery liquid which occurs between the thin papery remnant of nucellar tissue and the archegonial necks. Before fertilization a neck-canal cell is formed by the division of the ovum-nucleus. After the body of a spermatozoid has coalesced with the egg-nucleus the latter divides repeatedly and forms a mass of tissue which grows more vigorously in the lower part of the fertilized ovum, and extends upwards towards the apex of the ovum as a peripheral layer of parenchyma surrounding a central space. By further growth this tissue gives rise to a proembryo, which consists, at the micropylar end, of a sac; the tissue at the chalazal end grows into a long and tangled suspensor, terminating in a mass of cells, which is eventually differentiated into a radicle, plumule and two cotyledons. In the ripe seed the integument assumes the form of a fleshy envelope, succeeded internally by a hard woody shell, internal to which is a thin papery membrane—the apical portion of the nucellus—which is easily dissected out as a conical cap covering the apex of the endosperm. A thorough examination of cycadean seeds has recently been made by Miss Stopes, more particularly with a view to a comparison of their vascular supply with that in Palaeozoic gymnospermous seeds (*Flora*, 1904). The first leaves borne on the seedling axis are often scale-like, and these are followed by two or more larger laminae, which foreshadow the pinnae of the adult frond.

The anatomical structure of the vegetative organs of recent cycads is of special interest as affording important evidence of relationship with extinct types, and with other groups of recent plants. Bronnigart, who was the first to investigate in detail the anatomy of a cycadean stem, recognized an agreement, as regards the secondary wood, with Dicotyledons and Gymnosperms, rather than with Monocotyledons. He drew attention also to certain structural similarities between *Cycas* and *Ginkgo*. The main anatomical features of a cycad stem may be summarized as follows: the centre is occupied by a large parenchymatous pith traversed by numerous secretory canals, and in some genera by cauline vascular bundles (e.g. *Encephalartos* and *Macrozamia*). In addition to these cauline strands (confined to the stem and not connected with the leaves), collateral bundles are often met with in the pith, which form the vascular supply of terminal flowers borne at intervals on the apex of the stem. These latter bundles may be seen in sections of old stems to pursue a more or less horizontal course, passing outwards through the main woody cylinder. This lateral course is due to the more vigorous growth of the axillary branch formed near the base of each flower, which is a terminal structure, and, except in the female flower of *Cycas*, puts a limit to the apical growth of the stem. The vigorous lateral branch therefore continues the line of the main axis. The pith is encircled by a cylinder of secondary wood, consisting of single or multiple radial rows of tracheids separated by broad medullary rays composed of large parenchymatous cells; the tracheids bear numerous bordered

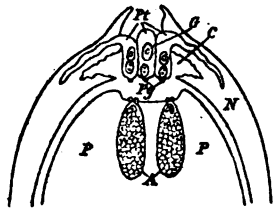

FIG. 7.—*Zamia*. Part of Ovule in longitudinal section. (After Webber.) P, Prothallus. Pt, Pollen-tube. Pg, Pollen-grain. N, Nucellus. G, Generative cell (second cell of pollen-tube).



FIG. 8.—*Zamia*. Proximal end of Pollen-tube. a, a, Spermatozooids from G of fig. 7; Pg, pollen-grain; c, proximal cell (first cell). (After Webber.)

pits on the radial walls. The large medullary rays give to the wood a characteristic parenchymatous or lax appearance, which is in marked contrast to the more compact wood of a conifer. The protoxylem-elements are situated at the extreme inner edge of the secondary wood, and may occur as small groups of narrow, spirally-pitted elements scattered among the parenchyma which abuts on the main mass of wood. Short and reticulately-pitted tracheal cells, similar to tracheids, often occur in the circummedullary region of cycadean stems. In an old stem of *Cycas*, *Encephalartos* or *Macrozamia* the secondary wood consists of several rather unevenly concentric zones, while in some other genera it forms a continuous mass as in conifers and normal dicotyledons. These concentric rings of secondary xylem and phloem (fig. 9) afford a characteristic cycadean feature. After the cambium has been active for some time producing secondary xylem and phloem, the latter consisting of sieve-tubes, phloem parenchyma and fine-walled fibres, a second cambium is developed in the pericycle; this produces a second vascular zone, which is in turn followed by a third cambium, and so on, until several hollow cylinders are developed. It has been recently shown that several cambium-zones may remain in a state of activity, so that the formation of a new cambium does not necessarily mark a cessation of growth in the more internal meristematic rings. It occasionally happens that groups of xylem and phloem are developed internally to some of the vascular rings; these are characterized by an inverse orientation of the tissues, the xylem being centrifugal and the phloem centripetal in its development. The broad cortical region, which contains many secretory canals, is traversed by numerous vascular bundles (fig. 9, c) some of which pursue a more or less vertical course, and by frequent anastomoses with one another form a loose reticulum of vascular strands; others are leaf-traces on their way from the stem to the leaves. Most of these cortical bundles are collateral in structure, but in some the xylem and phloem are concentrically arranged; the secondary origin of these bundles from procambium-strands was described by Mettenius in his classical paper of 1860. During the increase in thickness of a cycadean stem successive layers of cork-tissue are formed by phellogen in the persistent bases of leaves (fig. 9, pd), which increase in size to adapt themselves to the growth of the vascular zones. The leaf-traces of cycads are remarkable both on account of their course and their anatomy. In a transverse section of a stem (fig. 9) one sees some vascular bundles following a horizontal or slightly oblique course in the cortex, stretching for a longer or shorter distance in a direction concentric with the woody cylinder. From each leaf-base two main bundles spread right and left through the cortex of the stem (fig. 9, ll), and as they curve gradually towards the vascular ring they present the appearance of two rather flat ogee curves, usually spoken of as the leaf-trace girdles (fig. 9, ll). The distal ends of these girdles give off several branches, which traverse the petiole and rachis as

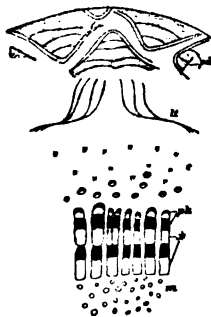

FIG. 9.—*Macrozamia*. Diagrammatic transverse section of part of stem. (After Worsdell.)
pd, Periderm in leaf-bases.
ll, Leaf-traces in cortex.
ph, Phloem.
x, Xylem.
m, Medullary bundles.
c, Cortical bundles.

verses by numerous vascular bundles (fig. 9, c) some of which pursue a more or less vertical course, and by frequent anastomoses with one another form a loose reticulum of vascular strands; others are leaf-traces on their way from the stem to the leaves. Most of these cortical bundles are collateral in structure, but in some the xylem and phloem are concentrically arranged; the secondary origin of these bundles from procambium-strands was described by Mettenius in his classical paper of 1860. During the increase in thickness of a cycadean stem successive layers of cork-tissue are formed by phellogen in the persistent bases of leaves (fig. 9, pd), which increase in size to adapt themselves to the growth of the vascular zones. The leaf-traces of cycads are remarkable both on account of their course and their anatomy. In a transverse section of a stem (fig. 9) one sees some vascular bundles following a horizontal or slightly oblique course in the cortex, stretching for a longer or shorter distance in a direction concentric with the woody cylinder. From each leaf-base two main bundles spread right and left through the cortex of the stem (fig. 9, ll), and as they curve gradually towards the vascular ring they present the appearance of two rather flat ogee curves, usually spoken of as the leaf-trace girdles (fig. 9, ll). The distal ends of these girdles give off several branches, which traverse the petiole and rachis as

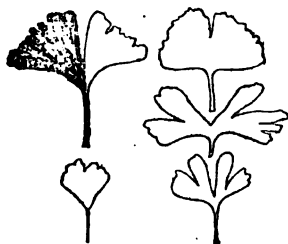

FIG. 10.—*Ginkgo biloba*. Leaves.

numerous collateral bundles. The complicated girdle-like course is characteristic of the leaf-traces of most recent cycads, but in some cases, e.g. in *Zamia floridana*, the traces are described by Wieland in his recent monograph on American fossil cycads (*Carnegie Institution Publications*, 1906) as possessing a more direct course similar to that in Mesozoic genera. A leaf-trace, as it passes through the cortex, has a collateral structure, the protoxylem being situated at the inner edge of the xylem; when it reaches the leaf-base the position of the spiral tracheids is gradually altered, and the endarch arrangement (protoxylem internal) gives place to a mesarch structure (protoxylem more or less central and not on the edge of the xylem strand). In a bundle examined in the basal portion of a leaf the bulk of the xylem is found to be centrifugal in position, but internally to the protoxylem there is a group of centripetal tracheids; higher up in the petiole the xylem is mainly centripetal, the centrifugal wood being represented

by a small arc of tracheids external to the protoxylem and separated from it by a few parenchymatous elements. Finally, in the passage of the frond the centrifugal xylem may disappear, the protoxylem being now exarch in position and abutting on the phloem. Similarly in the sporophylls of some cycads the bundles are endarch near the base and mesarch near the distal end of the stamen or carpel. The vascular system of cycadean seedlings presents some features worthy of note; centripetal xylem occurs in the cotyledonary bundles associated with transfusion-tracheids. The bundles from the cotyledons pursue a direct course to the stele of the main axis, and do not assume the girdle-form characteristic of the adult plant. This is of interest from the point of view of the comparison of recent cycads with extinct species (*Bennettites*), in which the leaf-traces follow a much more direct course than in modern cycads. The mesarch structure of the leaf-bundles is met with in a less pronounced form in the flower-peduncles of some cycads. This fact is of importance as showing that the type of vascular structure, which characterized the stems of many Palaeozoic genera, has not entirely disappeared from the stems of modern cycads; but the mesarch bundle is now confined to the leaves and peduncles. The roots of some cycads resemble the stems in producing several cambium-rings; they possess 2 to 8 protoxylem-groups, and are characterized by a broad pericycle zone. A common phenomenon in cycads is the production of roots which grow upwards (apogeotropic), and appear as coralline branched structures above the level of the ground; some of the cortical cells of these roots are hypertrophied, and contain numerous filaments of blue-green Algae (*Nostocaceae*), which live as endoparasites in the cell-cavities.



FIG. 11.—*Ginkgo adiantoides*. Fossil (Eocene) leaf from the Island of Mull.

GINNCOALES.—This class-designation has been recently proposed to give emphasis to the isolated position of the genus *Ginkgo* (*Salisburia*) among the Gymnosperms. *Ginkgo biloba*, the maiden-hair tree, has usually been placed by botanists in the Taxaceae in the neighbourhood of the yew (*Taxus*), but the proposal by Eichler in 1852 to constitute a special family, the *Salisburieae*, indicated a recognition of the existence of special characteristics which distinguish the genus from other members of the Coniferales. The discovery by the Japanese botanist Hirase of the development of ciliated spermatozooids in the pollen-tube of *Ginkgo*, in place of the non-motile male cells of typical conifers, served as a cogent argument in favour of separating the genus from the Coniferales and placing it in a class of its own. In 1712 Kaempfer published a drawing of a Japanese tree, which he described under the name *Ginkgo*; this term was adopted in 1771 by Linnaeus, who spoke of Kaempfer's plant as *Ginkgo biloba*. In 1797

Smith proposed to use the name *Salisburia adiantifolia* in preference to the "uncouth" genus *Ginkgo* and "incorrect" specific term *biloba*. Both names are still in common use. On account of the resemblance of the leaves to those of some species of *Adiantum*, the appellation maiden-hair tree has long been given to *Ginkgo biloba*. *Ginkgo* is of special interest on account of its isolated position among existing plants, its restricted geographical distribution, and its great antiquity (see PALAEOBOTANY: *Mesozoic*). This solitary survivor of an ancient stock is almost extinct, but a few old and presumably wild trees are recorded by travellers in parts of China. *Ginkgo* is common as a sacred tree in the gardens of temples in the Far East, and often cultivated in North America and Europe. *Ginkgo biloba*, which may reach a height of over 30 metres, forms a tree of pyramidal shape with a smooth grey bark. The leaves (figs. 10 and 11) have a long, slender petiole terminating in a fan-shaped lamina, which may be entire, divided by a median incision into two wedge-shaped lobes, or subdivided into several narrow segments. The venation is like that of many ferns, e.g. *Adiantum*: the lowest vein in each half of the lamina follows a course parallel to the edge, and gives off numerous branches, which fork repeatedly as they spread in a palmate manner towards the leaf margin. The foliage-leaves occur either scattered on long shoots of unlimited growth, or at the apex of short shoots (spurs), which may eventually elongate into long shoots.

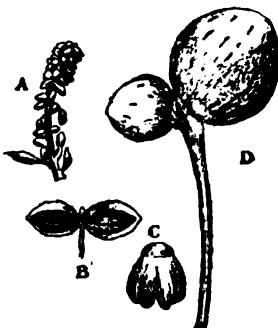

FIG. 12.—*Ginkgo biloba*. A, Male flower; B, C, single stamens; D, female flower.

The flowers are dioecious. The male flowers (fig. 12), borne in the axil of scale-leaves, consist of a stalked central axis bearing loosely disposed stamens; each stamen consists of a slender filament terminating in a small apical scale, which bears usually two, but not infrequently three or four pollen-sacs (fig. 12, C). The axis of the flower is a shoot bearing leaves in the form of stamens. A mature pollen-grain contains a prothallus of 3 to 5 cells (Fig. 13, Pg); the caune extends over two-thirds of the circumference, leaving

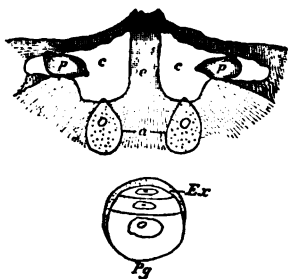

FIG. 13.—*Ginkgo*. Apex of Ovule, and Pollen-grain. (After Hirase.)
 p. Pollen-tube (proximal end).
 c. Pollen-chamber.
 e. Upward prolongation of megaspore.
 a. Archegonia.
 Pg. Pollen-grain.
 Ex. Exine.

egg-cell surmounted by two neck-cells cut off shortly before fertilization. After the entrance of the pollen-grain the pollen-chamber becomes roofed over by a blunt protuberance of nucellar tissue. The megaspore (embryo-sac) continues to grow after pollination until the greater part of the nucellus is gradually destroyed; it also gives rise to a vertical outgrowth, which projects from the apex of the megaspore as a short, thick column (fig. 13, e) supporting the remains of the nucellar tissue which forms the roof of the pollen-chamber (fig. 13, c). Surrounding the pitted wall of the ovum there is a definite layer of large cells, no doubt representing a tapetum, which, as in cycads and conifers, plays an important part in nourishing the growing egg-cell. The endosperm detached from a large *Ginkgo* ovule after fertilization bears a close resemblance to that of a cycad; the apex is occupied by a depression, on the floor of which two small holes mark the position of the archegonia, and the outgrowth from the megaspore apex projects from the centre as a short peg. After pollination the pollen-tube grows into the nucellar tissue, as in cycads, and the pollen-grain itself (fig. 13, Pg) hangs down into the pollen-chamber; two large spirally ciliated spermatozooids are produced, their manner of development agreeing very closely with that of the corresponding cells in *Cycas* and *Zamia*. After fertilization the ovum-nucleus divides and cell-formation proceeds rapidly, especially in the lower part of the ovum, in which the cotyledon and axis of the embryo are differentiated; the long, tangled suspensor of the cycadean embryo is not found in *Ginkgo*. It is often stated that fertilization occurs after the ovules have fallen, but it has been demonstrated by Hirase that this occurs while the ovules are still attached to the tree. The ripe seed, which grows as large as a rather small plum, is enclosed by a thick, fleshy envelope covering a hard woody shell with two or rarely three longitudinal keels. A papery remnant of nucellus lines the inner face of the woody shell, and, as in cycadean seeds, the apical portion is readily separated as a cap covering the summit of the endosperm.

The morphology of the female flowers has been variously interpreted by botanists; the peduncle bearing the ovules has been described as homologous with the petiole of a foliage-leaf and as a shoot-structure, the collar-like envelope at the base of the ovules being referred to as a second integument or arillus, or as the representative of a carpel. The evidence afforded by normal and abnormal flowers appears to be in favour of the following interpretation: The peduncle is a shoot bearing two or more carpels. Each ovule is enclosed at the base by an envelope or collar homologous with the lamina of a leaf; the fleshy and hard coats of the nucellus constitute a single integument. The stalk of an ovule, considerably reduced in normal flowers and much larger in some abnormal flowers, is homologous with a leaf-stalk, with which it agrees in the structure and number of vascular bundles. The facts on which this description is based are derived partly from anatomical evidence, and in part from an account given by a Japanese botanist, Fujii, of several abnormal female flowers; in some cases the collar at the base of an ovule, often described as an arillus, is found to pass gradually into the lamina of a leaf bearing marginal ovules (fig. 14, B). The occurrence of more than two ovules on one peduncle is by no means rare; a

particularly striking example is described by Fujii, in which an unusually thick peduncle bearing several stalked ovules terminates in a scaly bud (fig. 14, A, B). The frequent occurrence of more than two pollen-sacs and the equally common occurrence of additional ovules have been regarded by some authors as evidence in favour of the view that ancestral types normally possessed a greater number of these organs than are usually found in the recent species. This view receives support from fossil evidence. Close to the apex of a shoot the vascular bundles of a leaf make their appearance as double strands, and the leaf-traces in the upper part of a shoot have the form of distinct bundles, which in the older part of the shoot form a continuous ring. Each double leaf-trace passes through four internodes before becoming a part of the stele; the double nature of the trace is a characteristic feature. Secretory sacs occur abundantly in the leaf-lamina, where they appear as short lines between the veins; they are abundant also in the cortex and pith of the shoot, in the fleshy integument of the ovule, and elsewhere. The secondary wood of the shoot and root conforms in the main to the coniferous type; in the short shoots the greater breadth of the medullary rays in the more internal part of B, leaf bearing marginal ovule. (After the xylem recalls the Fujii.)



FIG. 14.—*Ginkgo*. Abnormal female flowers. A, Peduncle; B, scaly bud; the more internal part of B, leaf bearing marginal ovule. (After the xylem recalls the Fujii.)

cycadean type. The secondary phloem contains numerous thick-walled fibres, parenchymatous cells, and large sieve-tubes with plates on the radial walls; swollen parenchymatous cells containing crystals are commonly met with in the cortex, pith and medullary-ray tissues. The wood consists of tracheids, with circular bordered pits on their radial walls, and in the late summer wood pits are unusually abundant on the tangential walls. A point of anatomical interest is the occurrence in the vascular bundles of the cotyledons, scale-leaves, and elsewhere of a few centripetally developed tracheids, which give to the xylem-strands a meshwork structure such as characterizes the foliar bundles of cycads. The root is diarch in structure, but additional protoxylem-strands may be present at the base of the main root; the pericycle consists of several layers of cells.

This is not the place to discuss in detail the past history of *Ginkgo* (see PALAEOBOTANY: Mesozoic). Among Palaeozoic genera there are some which bear a close resemblance to the recent type in the form of the leaves; and petrified Palaeozoic seeds, almost identical with those of the maidenhair tree, have been described from French and English localities. During the Triassic and Jurassic periods the genus *Baiera*—no doubt a representative of the *Ginkgo* genus—was widely spread throughout Europe and in other regions; *Ginkgo* itself occurs abundantly in Mesozoic and Tertiary rocks, and was a common plant in the Arctic regions as elsewhere during the Jurassic and Lower Cretaceous periods. Some unusually perfect *Ginkgo* leaves have been found in the Eocene leaf-beds between the lava-flows exposed in the cliffs of Mull (fig. 11). From an evolutionary point of view, it is of interest to note the occurrence of filicinean and cycadean characters in the maidenhair tree. The leaves at once invite a comparison with ferns; the numerous long hairs which form a delicate woolly covering on young leaves recall the hairs of certain ferns, but agree more closely with the long filamentous hairs of recent cycads. The spermatozooids constitute the most striking link with both cycads and ferns. The structure of the seed, the presence of two neck-cells in the archegonia, the late development of the embryo, the partially-fused cotyledons and certain anatomical characters, are features common to *Ginkgo* and the cycads. The maidenhair tree is one of the most interesting survivals from the past; it represents a type which, in the Palaeozoic era, may have been merged into the extinct class Cordaitales. Through the succeeding ages the *Ginkgo*ales were represented by numerous forms, which gradually became more restricted in their distribution and fewer in number during the Cretaceous and Tertiary periods, terminating at the present day in one solitary survivor.

CONFIFERALES.—Trees and shrubs characterized by a copious branching of the stem and frequently by a regular pyramidal form. Leaves simple, small, linear or short and scale-like, usually persisting for more than one year. Flowers monoecious or dioecious, unisexual, without a perianth, often in the form of cones, but never terminal on the main stem.

The plants usually included in the Coniferae constitute a less homogeneous class than the Cycadales. Some authors use the term Coniferae in a restricted sense as including those genera which have the female flowers in the form of cones, the other genera, characterized by flowers of a different type, being placed in the Taxaceae, and often spoken of as Taxoideae.

In order to avoid confusion in the use of the term Coniferae, we may adopt as a class-designation the name Coniferales, including both the Coniferae—using the term in a restricted sense—and the Taxaceae. The most striking characteristic of the majority of the Coniferales is the regular manner of the monopodial branching and the pyramidal shape. *Araucaria imbricata*, the Monkey-puzzle tree, *A. excelsa*, the Norfolk Island pine, many pines and firs, cedars and other genera illustrate the pyramidal form. The mammoth redwood tree of California, *Sequoia (Wellingtonia) gigantea*, which represents the tallest Gymnosperm, is a good example of the regular tapering main stem and narrow pyramidal form. The cypresses afford instances of tall and narrow trees similar in habit to Lombardy poplars. The common cypress (*Cupressus sempervirens*), as found wild in the mountains of Crete and Cyprus, is characterized by long and spreading branches, which give it a cedar-like habit. A pendulous or weeping habit is assumed by some conifers, e.g. *Picea excelsa* var. *virgata* represents a form in which the main branches attain a considerable horizontal extension, and trail themselves like snakes along the ground. Certain species of *Pinus*, the yews (*Taxus*) and some other genera grow as bushes, which in place of a main mast-like stem possess several repeatedly-branched leading shoots. The unfavourable conditions in Arctic regions have produced a dwarf form, in which the main shoots grow close to the ground. Artificially induced dwarfed plants of *Pinus*, *Cupressus*, *Sciadopitys* (umbrella pine) and other genera are commonly cultivated by the Japanese. The dying off of older branches and the vigorous growth of shoots nearer the apex of the stem produce a form of tree illustrated by the stone pine of the Mediterranean region (*Pinus Pinea*), which Turner has rendered familiar in his "Childe Harold's Pilgrimage" and other pictures of Italian scenery. Conifers are not infrequently seen in which a lateral branch has bent sharply upwards to take the place of the injured main trunk. An upward tendency of all the main lateral branches, known as fastigation, is common in some species, producing well-marked varieties, e.g. *Cephalotaxus pedunculata* var. *fastigiata*; this fastigate habit may arise as a sport on a tree with spreading branches. Another departure from the normal is that in which the juvenile or seedling form of shoot persists in the adult tree; the numerous coniferous plants known as species of *Retinospora* are examples of this. The name *Retinospora*, therefore, does not stand for a true genus, but denotes persistent young forms of *Juniperus*, *Thuja*, *Cupressus*, &c., in which the small scaly leaves of ordinary species are replaced by the slender, needle-like leaves, which stand out more or less at right angles from the branches. The flat branchlets of *Cupressus*, *Thuja* (arbor vitae), *Thujopsis dolabrata* (Japanese arbor vitae) are characteristic of certain types of conifers; in some cases the horizontal extension of the branches induces a dorsiventral structure. A characteristic feature of the genus *Agathis* (*Dammara*) the Kauri pine of New Zealand, is the deciduous habit of the branches; these become detached from the main trunk leaving a well-defined abscission-surface, which appears as a depressed circular scar on the stem. A new genus of conifers, *Taxuaria*, has recently been described from the island of Formosa; it is said to agree in habit with the Japanese *Cryptomeria*, but the cones appear to have a structure which distinguishes them from those of any other genus.

With a few exceptions conifers are evergreen, and retain the leaves for several years (10 years in *Araucaria imbricata*, 8 to 10 in *Picea excelsa*, 5 in *Taxus baccata*; in *Pinus* the needles usually fall in October of their third year). The larch (*Larix*) sheds its leaves in the autumn, in the Chinese larch (*Pseudolarix Kaempferi*) the leaves turn a bright yellow colour before falling. In the swamp cypress (*Taxodium distichum*) the tree assumes a rich brown colour in the autumn, and sheds its leaves together with the branchlets which bear them; deciduous branches occur also in some other species, e.g. *Sequoia sempervirens* (redwood), *Thuja occidentalis*, &c. The leaves of conifers are characterized by their small size, e.g. the needle-form represented by *Pinus*, *Cedrus*, *Larix*, &c., the linear flat or angular leaves, appressed to the branches, of *Thuja*, *Cupressus*, *Libocedrus*, &c. The flat and comparatively broad leaves of *Araucaria imbricata*, *A. Bidwillii*, and some species of the southern genus *Podocarpus* are traversed by several parallel veins, as are also the still larger leaves of *Agathis*, which may reach a length of several inches. In addition to the foliage-leaves several genera also possess scale-leaves of various kinds, represented by bud-scales in *Pinus*, *Picea*, &c., which frequently persist for a time at the base of a young shoot which has pushed its way through the yielding cap of protecting scales, while in some conifers the bud-scales adhere together, and after being torn near the base are carried up by the growing axis as a thin brown cap. The cypresses, araucarias and some other genera have no true bud-scales, in some species, e.g. *Araucaria Bidwillii*, the occurrence of small foliage-leaves, which have functioned as bud-scales, at intervals on the shoots affords a measure of seasonal growth. The occurrence of long and short shoots is a characteristic feature of many conifers. In *Pinus* the needles occur in pairs, or in clusters of 3 or 5 at the apex of a small and inconspicuous short shoot of limited growth (spur), which is enclosed at its base by a few scale-leaves, and borne on a branch of unlimited growth in the axil of a scale-leaf. In the Californian *Pinus monophylla* each spur bears usually one needle, but two are not uncommon; it would seem that rudiments of two needles are always produced, but, as a rule, only one develops into a needle. In

Sciadopitys similar spurs occur, each bearing a single needle, which in its grooved surface and in the possession of a double vascular bundle bears traces of an origin from two needle-leaves. A peculiarity of these leaves is the inverse orientation of the vascular tissue; each of the two veins has its phloem next the upper and the xylem towards the lower surface of the leaf; this unusual position of the xylem and phloem may be explained by regarding the needle of *Sciadopitys* as being composed of a pair of leaves borne on a short axillary shoot and fused by their margins (fig. 15, A). Long and short shoots occur also in *Cedrus* and *Larix*, but in these genera the spurs are longer and stouter, and are not shed with the leaves; this kind of short shoot, by accelerated apical growth, often passes into the condition of a long shoot on which the leaves are scattered and separated by comparatively long internodes, instead of being crowded into tufts such as are borne on the ends of the spurs. In the genus *Phyllocladus* (New Zealand, &c.) there are no green foliage-leaves, but in their place flattened branches (phyllodes) borne in the axils of small scale-leaves. The cotyledons are often two in number, but sometimes (e.g. *Pinus*) as many as fifteen; these leaves are usually succeeded by foliage-leaves in the form of delicate spreading needles, and these primordial leaves are bowed, sooner or later, by the adult type of leaf, except in *Retinospora*, which retain the juvenile foliage. In addition to the first foliage-leaves and the adult type of leaf, there are often produced leaves which are intermediate both in shape and structure between the seedling and adult foliage. Dimorphism or heterophylly is fairly common. One of the best known examples is the Chinese juniper (*Juniperus chinensis*), in which branches with spinous leaves, longer and more spreading than the ordinary adult leaf, are often found associated with the normal type of branch. In some cases, e.g. *Sequoia sempervirens*, the fertile branches bear leaves which are less spreading than those on the vegetative shoots. Certain species of the southern hemisphere genus *Dacrydium* afford particularly striking instances of heterophylly, e.g. *D. Kirkii* of New Zealand, in which some branches bear small and appressed leaves, while in others the leaves are much longer and more spreading. A well-known fossil conifer from Triassic strata—*Volzia heterophylla*—also illustrates a marked dissimilarity in the leaves of the same shoot. The variation in leaf-form and the tendency of leaves to arrange themselves in various ways on different branches of the same plant are features which are important to bear in mind in the identification of fossil conifers. In this connexion we may note the striking resemblance between some of the New Zealand Alpine Veronicas, e.g. *Veronica Hectori*, *V. cupressoides*, &c. (also *Polycladus cupressinus*, a Composite), and some of the cypresses and other conifers with small appressed leaves. The long linear leaves of some species of *Podocarpus*, in which the lamina is traversed by a single vein, recall the pinnae of *Cycas*; the branches of some *Dacrydium* and other forms closely resemble those of lycopods; these superficial resemblances, both between different genera of conifers and between conifers and other plants, coupled with the usual occurrence of fossil coniferous twigs without cones attached to them, render the determination of extinct types a very unsatisfactory and frequently an impossible task.

A typical male flower consists of a central axis bearing numerous spirally-arranged sporophylls (stamens), each of which consists of a slender stalk (filament) terminating distally in a more *Flowers*, or less prominent knob or triangular scale, and bearing two or more pollen-sacs (microsporangia) on its lower surface. The pollen-grains of some genera (e.g. *Pinus*) are furnished with bladder-like extensions of the outer wall, which serve as aids to wind-dispersal. The stamens of *Araucaria* and *Agathis* are peculiar in bearing several long and narrow free pollen-sacs; these may be compared with the sporangiophores of the horsetails (*Equisetum*); in *Taxus* (yew) the filament is attached to the centre of a large circular distal expansion, which bears several pollen-sacs on its under surface. In the conifers proper the female reproductive organs have the form of cones, which may be styled flowers or inflorescences according to different interpretations of their morphology. In the Taxaceae the flowers have a simpler structure. The female flowers of the *Abietineae* may be taken as representing a common type. A pine cone reaches maturity in two years; a single year suffices for the full development in *Larix* and several other genera. The axis of the cone bears numerous spirally disposed flat scales (cone-scales), each of which, if examined in a young cone, is found to be double, and to consist of a lower and an upper portion. The latter is a thin flat scale bearing a median ridge or keel (e.g. *Abies*), on each side of which is situated an inverted ovule, consisting of a nucellus surrounded by a single integument. As the cone grows in size and becomes woody the lower half of the cone-scale, which we may call the carpellary scale, may remain small, and is so far outgrown by the upper half (sperminiferous scale) that it is hardly recognizable in the mature cone. In many species of *Abies* (e.g. *Abies pectinata*, &c.) the ripe cone differs from those of *Pinus*, *Picea* and *Cedrus* in the large size of the carpellary scales, which project as conspicuous thin appendages beyond the distal margins of the broader and more woody sperminiferous scales; the long carpellary scale is a prominent feature also in the cone of the Douglas pine (*Pseudotsuga Douglasii*). The female flowers (cones) vary considerably in size; the largest are the more or less spherical cones of *Araucaria*—a single cone of *A. imbricata* may produce as many as 300 seeds, one seed to each fertile cone-scale—and the long pendent

cones, 1 to 2 ft. in length, of the sugar pine of California (*Pinus Lambertiana*) and other species. Smaller cones, less than an inch long, occur in the larch, *Athrotaxis* (Tasmania), *Fitzroya* (Patagonia and Tasmania), &c. In the *Taxodiaceae* and *Araucariaceae* the cones are similar in appearance to those of the *Abietineae*, but they differ in the fact that the scales appear to be single, even in the young condition; each cone-scale in a genus of the *Taxodiaceae* (*Sequoia*, &c.) bears several seeds, while in the *Araucariaceae* (*Araucaria* and *Agathis*) each scale has one seed. The *Cupressineae* have cones composed of a few scales arranged in alternate whorls; each scale bears two or more seeds, and shows no external sign of being composed of two distinct portions. In the junipers the scales become fleshy as the seeds ripen, and the individual scales fuse together in the form of a berry. The female flowers of the *Taxaceae* assume another form; in *Microcachrys* (Tasmania) the reproductive structures are spirally disposed, and form small globular cones made up of red fleshy scales, to each of which is attached a single ovule enclosed by an integument and partially invested by an arillus; in *Dacrydium* the carpellary leaves are very similar to the foliage leaves—each bears one ovule with two integuments, the outer of which constitutes an arillus. Finally in the yew, a type of the family *Taxaceae*, the ovules occur singly at the apex of a lateral branch, enclosed when ripe by a conspicuous red or yellow fleshy arillus, which serves as an attraction to animals, and thus aids in the dispersal of the seeds.

It is important to draw attention to some structural features exhibited by certain cone-scales, in which there is no external sign indicative of the presence of a carpellary and a seminiferous scale. In *Araucaria Cookii* and some allied species each scale has a small pointed projection from its upper face near the distal end; the scales of *Cunninghamia* (China) are characterized by a somewhat ragged membranous projection extending across the upper face between the seeds and the distal end of the scale; in the scales of *Athrotaxis* (Tasmania) a prominent rounded ridge occupies a corresponding position. These projections and ridges may be homologous with the seminiferous scale of the pines, firs, cedars, &c. The simplest interpretation of the cone of the *Abietineae* is that which regards it as a flower consisting of an axis bearing several open carpels, which in the adult cone may be very small or large and prominent, the scale bearing the ovules being regarded as a placental outgrowth from the flat and open carpel. In *Araucaria* the cone-scale is regarded as consisting of a flat carpel of which the placenta has not grown out into the scale-like structure. The seminiferous scale of *Pinus*, &c., is also spoken of sometimes as a ligular outgrowth from the carpellary leaf. Robert Brown was the first to give a clear description of the morphology of the *Abietineae* cone in which carpels bear naked ovules; he recognized gymnospermy as an important distinguishing feature in conifers as well as in cycads. Another view is to regard the cone as an inflorescence, each carpellary scale being a bract bearing in its axil a shoot the axis of which has not been developed; the seminiferous scale is believed to represent either a single leaf or a fused pair of leaves belonging to the partially suppressed axillary shoot. In 1869 van Tieghem laid stress on anatomical evidence as a key to the morphology of the cone-scales; he drew attention to the fact that the collateral vascular bundles of the seminiferous scale are inversely orientated as compared with those of the carpellary scale; in the latter the xylem of each bundle is next the upper surface, while in the seminiferous scale the phloem occupies that position. The conclusion drawn from this was that the seminiferous scale (fig. 15, B, Sc) is the first and only leaf of an axillary shoot (b) borne on that side of the shoot, the axis of which is suppressed, opposite the subtending bract (fig. 15, A, B, C, Br). Another view is to apply to the seminiferous scale an explanation similar to that suggested by von Mohl in the case of the double needle of *Sciadopitys*, and to consider the seed-bearing scale as being made up of a pair of leaves (fig. 15, A, a, a) of an axillary shoot (b) fused into one by their posterior margins (fig. 15, A). The latter view receives support from abnormal cones in which carpellary scales subtend axillary shoots, of which the first two leaves (fig. 15, C, P, P) are often harder and browner than the others; forms have been described transitional between axillary shoots, in which the leaves are separate, and others in which two of the leaves are more or less completely fused. In a young cone the seminiferous scale appears as a hump of tissue at the base or in the axil of the carpellary scale, but Celakovsky, a strong supporter of the axillary-bud theory, attaches little or no importance to this kind of evidence, regarding the present manner of development as being merely an example of a short cut adopted in the course of evolution, and replacing the original production of a branch in the axil of each carpellary scale. Eichler, one of the chief supporters of the simpler view, does not recognize in the inverse orientation of the vascular bundles an argument in support of the axillary-bud theory, but points out that the seminiferous scale, being an outgrowth from the surface of the carpellary scale, would, like outgrowths from an ordinary leaf, naturally have its bundles inversely orientated. In such cone-scales as show little or no external indication of being double in origin, e.g. *Araucaria* (fig. 15, D) *Sequoia*, &c., there are always two sets of bundles: the upper set, having the phloem uppermost, as in the seminiferous scale of *Abies* or *Pinus*, are regarded as belonging to the outgrowth from the carpellary scale and specially developed to supply the ovules. Monstrous cones are fairly common; these in some instances lend

support to the axillary-bud theory, and it has been said that this theory owes its existence to evidence furnished by abnormal cones. It is difficult to estimate the value of abnormalities as evidence bearing on morphological interpretation; the chief danger lies perhaps in attaching undue weight to them, but there is also a risk of minimizing their importance. Monstrosities at least demonstrate possible lines of development, but when the abnormal forms of growth in various directions are fairly evenly balanced, trustworthy deductions become difficult. The occurrence of buds in the axils of carpellary scales may, however, simply mean that buds, which are

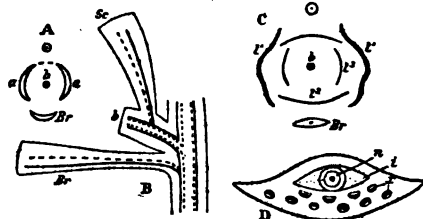

(C and D after Worsdell.)

FIG. 15.—Diagrammatic treatment of:

- A, Double needle of *Sciadopitys* (a, a, leaves; b, shoot; Br, bract).
B, seminiferous scale as leaf of axillary shoot (b, shoot; Sc, seminiferous scale; Br, bract).
C, seminiferous scale as fused pair of leaves (P, P, first, second and third leaves; b, shoot; Br, bract).
D, cone-scale of *Araucaria* (n, nucellus; i, integument; x, xylem).

usually undeveloped in the axils of sporophylls, occasionally afford evidence of their existence. Some monstrous cones lend no support to the axillary-bud theory. In *Larix* the axis of the cone often continues its growth; similarly in *Cephalotaxus* the cones are often proliferous. (In rare cases the proliferated portion produces male flowers in the leaf-axils.) In *Larix* the carpellary scale may become leafy, and the seminiferous scale may disappear. Androgynous cones may be produced, as in the cone of *Pinus rigida* (fig. 16), in which the lower part bears stamens and the upper portion carpellary and seminiferous scales. An interesting case has been figured by Masters, in which scales of a cone of *Cupressus Lawsoniana* bear ovules on the upper surface and stamens on the lower face. One argument that has been adduced in support of the axillary bud theory is derived from the Palaeozoic type *Cordaites*, in which each ovule occurs on an axis borne in the axil of a bract. The whole question is still unsolved, and perhaps insoluble. It may be that the interpretation of the female cone of the *Abietineae* as an inflorescence, which finds favour with many botanists, cannot be applied to the cones of *Agathis* and *Araucaria*. Without expressing any decided opinion as to the morphology of the double cone-scale of the *Abietineae*, preference may be felt in favour of regarding the cone-scale of the *Araucariaceae* as a simple carpellary leaf bearing a single ovule. A discussion of this question may be found in a paper on the *Araucariaceae* by Seward and Ford, published in the *Transactions of the Royal Society of London* (1906). *Cordaites* is an extinct type which in certain respects resembles *Ginkgo*, cycads and the *Araucariaceae*, but its agreement with true conifers is probably too remote to justify our attributing much weight to the bearing of the morphology of its female flowers on the interpretation of that of the *Coniferae*. The greater simplicity of the Eichler theory may prejudice us in its favour; but, on the other hand, the arguments advanced in favour of the axillary-bud theories are perhaps not sufficiently cogent to lead us to accept an explanation based chiefly on the uncertain evidence of monstrosities.

A pollen-grain when first formed from its mother-cell consists of a single cell; in this condition it may be carried by the nucellus of the ovule (e.g. *Taxus*, *Cupressus*, &c.), or more usually (*Pinus*, *Larix*, &c.) it reaches maturity before the dehiscence of the microsporangium. The nucleus of the microspore divides and gives rise to a small cell within the large cell, a second small cell is then produced; this is the structure of the ripe pollen-grain in some conifers (*Taxus*, &c.). The large cell grows out as a pollen-tube; the second of the two small cells (body-cell) wanders into the tube, followed by the nucleus of the first small cell (stalk-cell). In *Taxus* the body-cell eventually divides into two, in which the products of division are of unequal size, the larger constituting the male generative cell, which fuses with the nucleus of the egg-cell. In *Juniperus* the products of division of the



FIG. 16.—Abnormal Cone of *Pinus rigida*. (After Masters.)

Microspores and megaspores.

body-cell are equal, and both function as male generative cells. In the *Abietineae* cell-formation in the pollen-grain is carried farther. Three small cells occur inside the cavity of the microspore; two of them collapse and the third divides into two, forming a stalk-cell and a larger body-cell. The latter ultimately divides in the apex of the pollen-tube into two non-motile generative cells. Evidence has lately been adduced of the existence of numerous nuclei in the pollen-tubes of the *Araucariaceae*, and it seems probable that in this as in several other respects this family is distinguished from other members of the Coniferales. The precise method of fertilization in the Scots Pine was followed by V. H. Blackman, who also succeeded in showing that the nuclei of the sporophyte generation contain twice as many chromosomes as the nuclei of the gametophyte. Other observers have in recent years demonstrated a similar relation in other genera between the number of chromosomes in the nuclei of the two generations. The ovule is usually surrounded by one integument, which projects beyond the tip of the nucellus as a wide-open lobed funnel, which at the time of pollination folds inward, and so assists in bringing the pollen-grains on to the nucellus. In some conifers (e.g. *Taxus*, *Cephalotaxus*, *Dacrydium*, &c.) the ordinary integument is partially enclosed by an arillus or second integument. It is held by some botanists (Čelakovský) that the seminiferous scale of the *Abietineae* is homologous with the arillus or second integument of the *Taxaceae*, but this view is too strained to gain general acceptance. In *Araucaria* and *Saxegothaea* the nucellus itself projects beyond the open micropyle and receives the pollen-grains direct. During the growth of the cell which forms the megaspore the greater part of the nucellus is absorbed, except the apical portion, which persists as a cone above the megaspore; the partial disorganization of some of the cells in the centre of the nucellar cone forms an irregular cavity, which may be compared with the larger pollen-chamber of *Ginkgo* and the cycads. In each ovule one megaspore comes to maturity, but, exceptionally, two may be present (e.g. *Pinus sylvestris*). It has been shown by Lawson that in *Sequoia sempervirens* (*Annals of Botany*, 1904) and by other workers in the genera that several megaspores may attain a fairly large size in one prothallus. The megaspore becomes filled with tissue (prothallus), and from some of the superficial cells archegonia are produced, usually three to five in number, but in rare cases ten to twenty or even sixty may be present. In the genus *Sequoia* there may be as many as sixty archegonia (Arnold and Lawson) in one megaspore; these occur either separately or in some parts of the prothallus they may form groups as in the *Cupressineae*; they are scattered through the prothallus instead of being confined to the apical region as in the majority of conifers. Similarly in the *Araucariaceae* and in *Widdringenia* the archegonia are numerous and scattered and often sunk in the prothallus tissue. In *Libocedrus decurrens* (*Cupressineae*) Lawson describes the archegonia as varying in number from 6 to 24 (*Annals of Botany* xii, 1907). An archegonium consists of a large oval egg-cell surmounted by a short neck composed of one or more tiers of cells, six to eight cells in each tier. Before fertilization the nucleus of the egg-cell divides and cuts off a ventral canal-cell; this cell may represent a second egg-cell. The egg-cells of the archegonia may be in lateral contact (e.g. *Cupressineae*) or separated from one another by a few cells of the prothallus, each ovum being immediately surrounded by a layer of cells distinguished by their granular contents and large nuclei. During the development of the egg-cell, food material is transferred from these cells through the pitted wall of the ovum. The tissue at the apex of the megaspore grows slightly above the level of the archegonia, so that the latter come to lie in a shallow depression. In the process of fertilization the two male generative nuclei, accompanied by the pollen-tube nucleus and that of the stalk-cell, pass through an open pit at the apex of the pollen-tube into the protoplasm of the ovum. After fertilization the nucleus of the egg divides, the first stages of karyokinesis being apparent even before complete fusion of the male and female nuclei has occurred. The result of this is the production of four nuclei, which eventually take up a position at the bottom of the ovum and become separated from one another by vertical cell-walls; these nuclei divide again, and finally three tiers of cells are produced, four in each tier. In the *Abietineae* the cells of the middle tier elongate and push the lowest tier deeper into the endosperm; the cells of the bottom tier may remain in lateral contact and produce together one embryo, or they may separate (*Pinus*, *Jambertus*, &c.) and form four potential embryos. The ripe albuminous seed contains a single embryo with two or more cotyledons. The seeds of many conifers are provided with large thin wings, consisting in some genera (e.g. *Pinus*) of the upper cell-layers of the seminiferous scale, which have become detached and, in some cases, adhere loosely to the seed as a thin membrane; the loose attachment may be of use to the seeds when they are blown against the branches of trees, in enabling them to fall away from the wing and drop to the ground. The seeds of some genera depend on animals for dispersal, the carpellary scale (*Microcachrys*) or the outer integument being brightly coloured and attractive. In some *Abietineae* (e.g. *Pinus* and *Picea*)—in which the cone-scales persist for some time after the seeds are ripe—the cones hang down and so facilitate the fall of the seeds; in *Cedrus*, *Araucaria* and *Abies* the scales become detached and fall with the seeds, leaving the bare vertical axis of the cone on the tree. In all cases, except some species of *Araucaria* (sect. *Colymbea*) the germination is epigeal. The seedling plants of some Conifers (e.g. *Arctostaphylos*

andricata) are characterized by a carrot-shaped hypocotyl, which doubtless serves as a food-reservoir.

The roots of many conifers possess a narrow band of primary xylem-tracheids with a group of narrow spiral protoxylem-elements at each end (diarch). A striking feature in the roots of several genera, excluding the *Abietineae*, is the occurrence of thick and somewhat irregular bands of thickening on the cell-walls of the cortical layer next to the endodermis. These bands, which may serve to strengthen the central cylinder, have been compared with the netting surrounding the delicate wall of an inflated balloon. It is not always easy to distinguish a root from a stem; in some cases (e.g. *Sequoia*) the primary tetrarch structure is easily identified in the centre of an old root, but in other cases the primary elements are very difficult to recognize. The sudden termination of the secondary tracheids against the pith-cells may afford evidence of root-structure as distinct from stem-structure, in which the radial rows of secondary tracheids pass into the irregularly-arranged primary elements next the pith. The annual rings in a root are often less clearly marked than in the stem, and the xylem-elements are frequently larger and thinner. The primary vascular bundles in a young conifer stem are collateral, and like those of a Dicotyledon, they are arranged in a circle round a central pith and enclosed by a common endodermis. It is in the nature of the secondary xylem that the Coniferales are most readily distinguished from the Dicotyledons and Cycadaceae; the wood is homogeneous in structure, consisting almost entirely of tracheids with circular or polygonal bordered pits on the radial walls, more particularly in the late summer wood. In many genera xylem-parenchyma is present, but never in great abundance. A few Dicotyledons, e.g. *Drimys* (*Magnoliaceae*) closely resemble conifers in the homogeneous character of the wood, but in most cases the presence of large spring vessels, wood-fibres and abundant parenchyma affords an obvious distinguishing feature.

The abundance of petrified coniferous wood in rocks of various ages has led many botanists to investigate the structure of modern genera with a view to determining how far anatomical characters may be used as evidence of generic distinctions. There are a few well-marked types of wood which serve as convenient standards of comparison, but these cannot be used except in a few cases to distinguish individual genera. The genus *Pinus* serves as an illustration of wood of a distinct type characterized by the absence of xylem-parenchyma, except such as is associated with the numerous resin-canals that occur abundantly in the wood, cortex and medullary rays; the medullary rays are composed of parenchyma and of horizontal tracheids with irregular ingrowths from their walls. In a radial section of a pine stem each ray is seen to consist in the median part of a few rows of parenchymatous cells with large oval simple pits in their walls, accompanied above and below by horizontal tracheids with bordered pits. The pits in the radial walls of the ordinary xylem-tracheids occur in a single row or in a double row, of which the pits are not in contact, and those of the two rows are placed on the same level. The medullary rays usually consist of a single tier of cells, but in the *Pinus* type of wood broader medullary rays also occur and are traversed by several resin-canals. In the wood of *Cupressus*, *Cedrus*, *Abies* and several other genera, parenchymatous cells occur in association with the xylem-tracheids and take the place of the resin-canals of other types. In the Araucarian type of wood (*Araucaria* and *Agathis*) the bordered pits, which occur in two or three rows on the radial walls of the tracheids, are in mutual contact and polygonal in shape, the pits of the different rows are alternate and not on the same level; in this type of wood the annual rings are often much less distinct than in *Cupressus*, *Pinus* and other genera. In *Taxus*, *Torreya* (California and the Far East) and *Cephalotaxus* the absence of resin-canals and the presence of spiral thickening-bands on the tracheids constitute well-marked characteristics. An examination of the wood of branches, stems and roots of the same species or individual usually reveals a fairly wide variation in some of the characters, such as the abundance and size of the medullary rays, the size and arrangement of pits, the presence of wood-parenchyma—characters to which undue importance has often been attached in systematic anatomical work. The phloem consists of sieve-tubes, with pitted areas on the lateral as well as on the inclined terminal walls, phloem-parenchyma and, in some genera, fibres. In the *Abietineae* the phloem consists of parenchyma and sieve-tubes only, but in most other forms tangential rows of fibres occur in regular alternation with the parenchyma and sieve-tubes. The characteristic companion-cells of Angiosperms are represented by phloem-parenchyma cells with albuminous contents; other parenchymatous elements of the bast contain starch or crystals of calcium oxalate. When tracheids occur in the medullary rays of the xylem these are replaced in the phloem-region by irregular parenchymatous cells known as albuminous cells. Resin-canals, which occur abundantly in the xylem, phloem or cortex, are not found in the wood of the yew. *Cephalotaxus* (*Taxaceae*) is also peculiar in having resin-canals in the pith (cf. *Ginkgo*). One form of *Cephalotaxus* is characterized by the presence of short tracheids in the pith, in shape like ordinary parenchyma, but in the possession of bordered pits and lignified walls agreeing with ordinary xylem-tracheids; it is probable that these short tracheids serve as reservoirs for storing rather than for conducting water. The vascular bundle entering the stem from a leaf with a single vein passes by a more or less direct course into the

central cylinder of the stem, and does not assume the girdle-like form characteristic of the cycadean leaf-trace. In species of which the leaves have more than one vein (e.g. *Araucaria imbricata*, &c.) the leaf-trace leaves the stele of the stem as a single bundle which splits up into several strands in its course through the cortex. In the wood of some conifers, e.g. *Araucaria*, the leaf-traces persist for a considerable time, perhaps indefinitely, and may be seen in tangential sections of the wood of old stems. The leaf-trace in the Coniferales is simple in its course through the stem, differing in this respect from the double leaf-trace of *Ginkgo*. A detailed account of the anatomical characters of conifers has been published by Professor D. P. Penhallow of Montreal and Dr. Cohen of Berlin which will be found useful for diagnostic purposes. The characters of leaves most useful for diagnostic purposes are the position of the stomata, the presence and arrangement of resin-canals, the structure of the mesophyll and vascular bundles. The presence of hypodermal fibres is another feature worthy of note, but the occurrence of these elements is too closely connected with external conditions to be of much systematic value. A pine needle grown in continuous light differs from one grown under ordinary conditions in the absence of hypodermal fibres, in the absence of the characteristic infoldings of the mesophyll cell-walls, in the smaller size of the resin-canals, &c. The endodermis in *Pinus*, *Picea* and many other genera is usually a well-defined layer of cells enclosing the vascular bundles, and separated from them by a tissue consisting in part of ordinary parenchyma and to some extent of isodiametric tracheids; but this tissue, usually spoken of as the pericycle, is in direct continuity with other stem-tissues as well as the pericycle. The occurrence of short tracheids in close proximity to the veins is a characteristic of coniferous leaves; these elements assume two distinct forms—(1) the short isodiametric tracheids (transfusion tracheids) closely associated with the veins; (2) longer tracheids extending across the mesophyll at right angles to the veins, and no doubt functioning as representatives of lateral veins. It has been suggested that transfusion-tracheids represent, in part at least, the centripetal xylem, which forms a distinctive feature of cycadean leaf-bundles; these short tracheids form conspicuous groups laterally attached to the veins in *Cunninghamia*, abundantly represented in a similar position in the leaves of *Sequoia*, and scattered through the so-called pericycle in *Pinus*, *Picea*, &c. It is of interest to note the occurrence of precisely similar elements in the mesophyll of *Lepidodendron* leaves. An anatomical peculiarity in the veins of *Pinus* and several other genera is the continuity of the medullary rays, which extend as continuous plates from one end of the leaf to the other. The mesophyll of *Pinus* and *Cedrus* is characterized by its homogeneous character and by the presence of infoldings of the cell-walls. In many leaves, e.g. *Abies*, *Tsuga*, *Larix*, &c., the mesophyll is heterogeneous, consisting of palisade and spongy parenchyma. In the leaves of *Araucaria imbricata*, in which palisade-tissue occurs in both the upper and lower part of the mesophyll, the resin-canals are placed between the veins; in some species of *Podocarpus* (sect. *Nageia*) a canal occurs below each vein. In *Tsuga*, *Torreya*, *Cephalotaxus*, *Sequoia*, &c., a single canal occurs below the midrib; in *Larix*, *Abies*, &c., two canals run through the leaf parallel to the margins. The stomata are frequently arranged in rows, their position being marked by two white bands of wax on the leaf-surface.

The chief home of the Coniferales is in the northern hemisphere, where certain species occasionally extend into the Arctic circle and penetrate beyond the northern limit of dicotyledonous trees. Wide areas are often exclusively occupied by conifers, which give the landscape a sombre aspect, suggesting a comparison with the forest vegetation of the Coal period. South of the tree-limit a belt of conifers stretches across north Europe, Siberia and Canada. In northern Europe this belt is characterized by such species as *Picea excelsa* (spruce), which extends south to the mountains of the Mediterranean region; *Pinus sylvestris* (Scottish fir), reaching from the far north to western Spain, Persia and Asia Minor; *Juniperus communis*, &c. In north Siberia *Pinus Cembra* (*Cembra* or *Arolla Pinus*) has a wide range; also *Abies sibirica* (Siberian silver fir), *Larix sibirica* and *Juniperus Sabina* (savin). In the North American area *Picea alba*, *P. nigra*, *Larix americana*, *Abies balsamea* (balsam fir), *Tsuga canadensis* (hemlock spruce), *Pinus Strobus* (Weymouth pine), *Thuja occidentalis* (white cedar), *Taxus canadensis* are characteristic species. In the Mediterranean region occur *Cupressus sempervirens*, *Pinus Pinea* (stone pine), species of juniper, *Cedrus atlantica*, *C. Libani*, *Callitris quadrivalvis*, *Pinus montana*, &c. Several conifers of economic importance are abundant on the Atlantic side of North America—*Juniperus virginiana* (red cedar, used in the manufacture of lead pencils, and extending as far south as Florida), *Taxodium distichum* (swamp cypress), *Pinus rigida* (pitch pine), *P. mitis* (yellow pine), *P. taeda*, *P. palustris*, &c. On the west side of the American continent conifers play a still more striking rôle; among them are *Chamaecyparis nukaensis*, *Picea sitchensis*, *Libocedrus decurrens*, *Pseudotsuga Douglasii* (*Douglas fir*), *Sequoia sempervirens*, *S. gigantea* (the only two surviving species of this generic type are now confined to a few localities in California, but were formerly widely spread in Europe and elsewhere), *Pinus Coulteri*, *P. Lambertiana*, &c. Farther south, a few representatives of such genera as *Abies*, *Cupressus*, *Pinus* and juniper are found in the Mexican Highlands, tropical America and the West Indies. In

the far East conifers are richly represented; among them occur *Pinus densiflora*, *Cryptomeria japonica*, *Cephalotaxus*, species of *Abies*, *Larix*, *Thujaopsis*, *Sciadopitys verticillata*, *Pseudolarix Kaempferi*, &c. In the Himalaya occur *Cedrus deodara*, *Taxus*, species of *Cupressus*, *Pinus excelsa*, *Abies Webbiana*, &c. The continent of Africa is singularly poor in conifers. *Cedrus atlantica*, a variety of *Abies Pinsapo*, *Juniperus thurifera*, *Callitris quadrivalvis*, occur in the north-west region, which may be regarded as the southern limit of the Mediterranean region. The greater part of Africa north of the equator is without any representatives of the conifers; *Juniperus procera* flourishes in Somaliland and on the mountains of Abyssinia; a species of *Podocarpus* occurs on the Cameroon mountains, and *P. milanjianus* is widely distributed in east tropical Africa. *Widdingtonia Whytei*, a species closely allied to *W. juniperoides* of the Cedarberg mountains of Cape Colony, is recorded from Nyassaland and from N.E. Rhodesia; while a third species, *W. cupressoides*, occurs in Cape Colony. *Podocarpus elongata* and *P. Thunbergii* (yellow wood) form the principal timber trees in the belt of forest which stretches from the coast mountains of Cape Colony to the north-east of the Transvaal. *Libocedrus tetragona*, *Fitzroya patagonica*, *Araucaria brasiliensis*, *A. imbricata*, *Saxegothaea* and others are met with in the Andes and other regions in South America. *Athrotaxis* and *Microcachrys* are characteristic Australian types. *Phyllocladus* occurs also in New Zealand, and species of *Dacrydium*, *Araucaria*, *Agathis* and *Podocarpus* are represented in Australia, New Zealand and the Malay regions.

GNETALES.—These are trees or shrubs with simple leaves. The flowers are dioecious, rarely monoecious, provided with one or two perianths. The wood is characterized by the presence of vessels in addition to tracheids. There are no resin-canals. The three existing genera, usually spoken of as members of the Gnetales, differ from one another more than is consistent with their inclusion in a single family; we may therefore better express their diverse characters by regarding them as types of three separate families—(1) *Ephedraceae*, genus *Ephedra*; (2) *Welwitschiaceae*, genus *Welwitschia*; (3) *Gnetales*, genus *Gnetum*. Our knowledge of the Gnetales leaves much to be desired, but such facts as we possess would seem to indicate that this group is of special importance as foreshadowing, more than any other Gymnosperms, the Angiosperm type. In the more heterogeneous structure of the wood and in the possession of true vessels the Gnetales agree closely with the higher flowering plants. It is of interest to note that the leaves of *Gnetum*, while typically Dicotyledonous in appearance, possess a Gymnospermous character in the continuous and plate-like medullary rays of their vascular bundles. The presence of a perianth is a feature suggestive of an approach to the floral structure of Angiosperms; the prolongation of the integument furnishes the flowers with a substitute for a stigma and style. The genus *Ephedra*, with its prothallus and archegonia, which are similar to those of other Gymnosperms, may be safely regarded as the most primitive of the Gnetales. In *Welwitschia* also the megaspore is filled with prothallus-tissue, but single egg-cells take the place of archegonia. In certain species of *Gnetum* described by Karsten the megaspore contains a peripheral layer of protoplasm, in which scattered nuclei represent the female reproductive cells; in *Gnetum Gnetum* a similar state of things exists in the upper half of the megaspore, while the lower half agrees with the megaspore of *Welwitschia* in being full of prothallus-tissue, which serves merely as a reservoir of food. Lottys has described the occurrence of special cells at the apex of the prothallus of *Gnetum Gnetum*, which he regards as imperfect archegonia (fig. 17, C, a); he suggests they may represent vestigial structures pointing back to some ancestral form beyond the limits of the present group. The Gnetales probably had a separate origin from the other Gymnosperms; they carry us nearer to the Angiosperms, but we have as yet no satisfactory evidence that they represent a stage in the direct line of Angiospermic evolution. It is not improbable that the three genera of this ancient phylum survive as types of a blindly-ending branch of the Gymnosperms; but be that as it may, it is in the Gnetales more than in any other Gymnosperms that we find features which help us to obtain a dim prospect of the lines along which the Angiosperms may have been evolved.

Ephedra.—This genus is the only member of the Gnetales represented in Europe. Its species, which are characteristic of warm temperate latitudes, are usually much-branched shrubs. The finer branches are green, and bear a close resemblance to the stems of *Equisetum* and to the slender twigs of *Casuarina*; the surface of the long internodes is marked by fine longitudinal ribs, and at the nodes are borne pairs of inconspicuous scale-leaves. The flowers are small, and borne on axillary shoots. A single male flower consists of an axis enclosed at the base by an inconspicuous perianth formed of two concrescent leaves and terminating in two, or as many as eight, shortly stalked or sessile anthers. The female flower is enveloped in a closely fitting sac-like investment, which must be regarded as a perianth; within this is an orthotropous ovule surrounded by a single integument prolonged upwards as a beak-like micropyle. The flower may be described as a bud bearing a pair of leaves which become fused and constitute a perianth, the apex of the shoot forming an ovule. In function the perianth may be compared with a unilocular ovary containing a single ovule; the projecting integument, which at the time of pollination excretes a drop of liquid, serves the same purpose as the style and stigma of an angiosperm. The megaspore

is filled with tissue as in typical Gymnosperms, and from some of the superficial cells 3 to 3 archegonia are developed, characterized by long multicellular necks. The archegonia are separated from one another, as in *Pinus*; by some of the prothallus-tissue, and the cells next the egg-cells (tapetal layer) contribute food-material to their development. After fertilization, some of the uppermost bracts below each flower become red and fleshy; the perianth develops into a woody shell, while the integument remains membranous. In some species of *Ephedra*, e.g. *E. altissima*, the fertilized eggs grow into tubular proembryos, from the tip of each of which embryos begin to be developed, but only one comes to maturity. In *Ephedra helvetica*, as described by Jaccard, no proembryo or suspensor is formed; but the most vigorous fertilized egg, after undergoing several divisions, becomes attached to a tissue, termed the columella, which serves the purpose of a primary suspensor; the columella appears to be formed by the lignification of certain cells in the central region of the embryo-sac. At a later stage some of the cells in the upper (micropylar) end of the embryo divide and undergo considerable elongation, serving the purpose of a secondary suspensor. The secondary wood of *Ephedra* consists of tracheids, vessels and parenchyma; the vessels are characterized by their wide lumen and by the large simple or slightly-bordered pits on their oblique end-walls.

Gnetum.—This genus is represented by several species, most of which are climbing plants, both in tropical America and in warm regions of the Old World. The leaves, which are borne in pairs at the tumid nodes, are oval in form and have a Dicotyledonous type of venation. The male and female inflorescences have the form of simple or paniculate spikes. The spike of an inflorescence bears whorls of flowers at each node in the axis of concrescent bracts accompanied by numerous sterile hairs (paraphyses); in a male inflorescence numerous flowers occur at each node, while in a female inflorescence the number of flowers at each node is much smaller. A male flower consists of a single angular perianth, through the open apex of which the flower-axis projects as a slender column terminating in two anthers. The female flowers, which are more complex in

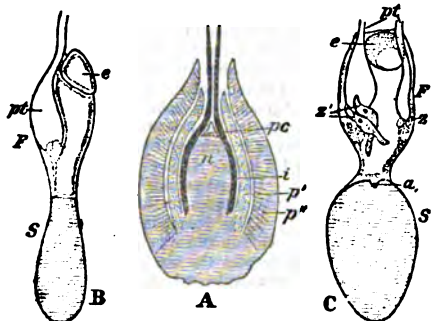

FIG. 17.—*Gnetum Gnetum*. (After Lotsy.)

- | | |
|----------------------|------------------------------------|
| A, Female Flower. | a, Imperfect Archegonia. |
| n, Nucellus. | a', Partially developed Megaspore. |
| pc, Pollen-chamber. | F, Fertile half. |
| i, Integument. | S; Sterile half. |
| p', Inner Perianth. | pt, Pollen-tube. |
| p'', Outer Perianth. | z, Zygote. |
| B, C, Megaspore. | z', Prothallus. |

structure, are of two types, complete and incomplete; the latter occur in association with male flowers in a male inflorescence. A complete female flower consists of a nucellus (fig. 17, A, n), surrounded by a single integument (fig. 17, A, i), prolonged upwards as a narrow tube and succeeded by an inner and an outer perianth (fig. 17, A, p' and p''). The whole flower may be looked upon as an adventitious bud bearing two pairs of leaves; each pair becomes concrescent and forms a perianth, the apex of the shoot being converted into an orthotropous ovule. The incomplete female flowers are characterized by the almost complete suppression of the inner perianth. Several embryo-sacs (megaspores) are present in the nucellus of a young ovule, but one only attains full size, the smaller and partially developed megaspores (fig. 17, B and C, e) being usually found in close association with the surviving and fully-grown megaspore. In *Gnetum Gnetum*, as described by Lotsy, a mature embryo-sac contains in the upper part a large central vacuole and a peripheral layer of protoplasm, including several nuclei, which take the place of the archegonia of *Ephedra*; the lower part of the embryo-sac, separated from the upper by a constriction, is full of parenchyma. The upper part of the megaspore may be spoken of as the fertile half (fig. 17, B and C, F), and the lower part, which serves only as food-reservoir for the growing embryo, may be termed the sterile half (fig. 17, B and C, S). (Coulter, *Bot. Gazette*, xlvii, 1908, regards this tissue as belonging to the nucellus.) At the time of pollination the long tubular

integument secretes a drop of fluid at its apex, which holds the pollen-grains, brought by the wind, or possibly to some extent by insect agency, and by evaporation these are drawn on to the top of the nucellus, where partial disorganization of the cells has given rise to an irregular pollen-chamber (fig. 17, A, pc). The pollen-tube, containing two generative and one vegetative nucleus, pierces the wall of the megaspore and then becomes swollen (fig. 17, B and C, pt); finally the two generative nuclei pass out of the tube and fuse with two of the nuclei in the fertile half of the megaspore. As the result of fertilization, the fertilized nuclei of the megaspore become surrounded by a cell-wall, and constitute zygotes, which may attach themselves either to the wall of the megaspore or to the end of a pollen-tube (fig. 17, C, z and z'); they then grow into long tubes or proembryos, which make their way towards the prothallus (C, z'), and eventually embryos are formed from the ends of the proembryo tubes. One embryo only comes to maturity. The embryo of *Gnetum* forms an out-growth from the hypocotyl, which serves as a feeder and draws nourishment from the prothallus. The fleshy outer portion of the seed is formed from the outer perianth, the woody shell being derived from the inner perianth. The climbing species of *Gnetum* are characterized by the production of several concentric cylinders of secondary wood and bast, the additional cambium-rings being products of the pericycle, as in *Cycas* and *Macrozamia*. The structure of the wood agrees in the main with that of *Ephedra*.

Welwitschia.—This is by far the most remarkable member of the Gnetales, both as regards habit and the form of its flowers. In a supplement to the systematic work of Engler and Prantl the well-known name *Welwitschia*, instituted by Hooker in 1864 in honour of Welwitsch, the discoverer of the plant, is superseded by that of *Tumboa*, originally suggested by Welwitsch. The genus is confined to certain localities in Damaraland and adjoining territory on the west coast of tropical South Africa. A well-grown plant projects less than a foot above the surface of the ground; the stem, which may have a circumference of more than 12 ft., terminates in a depressed crown resembling a circular table with a median groove across the centre and prominent broad ridges concentric with the margin. The thick tuberous stem becomes rapidly narrower, and passes gradually downwards into a tap-root. A pair of small strap-shaped leaves succeed the two cotyledons of the seedling, and persist as the only leaves during the life of the plant; they retain the power of growth in their basal portion, which is sunk in a narrow groove near the edge of the crown, and the tough lamina, 6 ft. in length, becomes split into narrow strap-shaped or thong-like strips which trail on the ground. Numerous circular pits occur on the concentric ridges of the depressed and wrinkled crown, marking the position of former inflorescences borne in the leaf-axil at different stages in the growth of the plant. An inflorescence has the form of a dichotomously-branched cyme bearing small erect cones; those containing the female flowers attain the size of a fir-cone, and are scarlet in colour. Each cone consists of an axis, on which numerous broad and thin bracts are arranged in regular rows; in the axil of each bract occurs a single flower; a male flower is enclosed by two opposite pairs of leaves, forming a perianth surrounding a central sterile ovule encircled by a ring of stamens united below, but free distally as short filaments, each of which terminates in a trilobed anther. The integument of the sterile ovule is prolonged above the nucellus as a spirally-twisted tube expanded at its apex into a flat stigma-like organ. A complete and functional female flower consists of a single ovule with two integuments, the inner of which is prolonged into a narrow tubular micropyle, like that in the flower of *Gnetum*. The megaspore of *Welwitschia* is filled with a prothallus-tissue before fertilization, and some of the prothallus-cells function as egg-cells; these grow upwards as long tubes into the apical region of the nucellus, where they come into contact with the pollen-tubes. After the egg-cells have been fertilized by the non-motile male cells they grow into tubular proembryos, producing terminal embryos. The stem is traversed by numerous collateral bundles, which have a limited growth, and are constantly replaced by new bundles developed from strands of secondary meristem. One of the best-known anatomical characteristics of the genus is the occurrence of numerous spindle-shaped or branched fibres with enormously-thickened walls studded with crystals of calcium oxalate. Additional information has been published by Professor Pearson of Cape Town based on material collected in Damaraland in 1904 and 1906-1907. In 1906 he gave an account of the early stages of development of the male and female organs and, among other interesting statements in regard to the general biology of *Welwitschia*, he expressed the opinion that, as Hooker suspected, the ovules are pollinated by insect-agency. In a later paper Pearson considerably extended our knowledge of the reproduction and gametophyte of this genus.

AUTHORITIES.—General: Benth and Hooker, *Genera Plantarum* (London, 1862-1883); Engler and Prantl, *Die natürlichen Pflanzenfamilien* (Leipzig, 1889 and 1897); Strasburger, *Die Coniferen und Gnetales* (Jena, 1872); *Die Angiospermen und die Gymnospermen* (Jena, 1879); *Histologische Beiträge*, iv. (Jena, 1892); Coulter and Chamberlain, *Morphology of Spermatophytes* (New York, 1901); Rendle, *The Classification of Flowering Plants*, vol. i. (Cambridge, 1904); "The Origin of Gymnosperms" (A discussion at the Linnean Society; *New Phytologist*, vol. v. 1906). Cycadales: Mettenius, "Beiträge zur Anatomie der Cycadeen," *Abh. k. sächs.*

Ger. Wiss. (1866); Treub, "Recherches sur les Cycadées," *Ann. Bot. Jard. Buitensorg*, ii. (1884); Solms-Laubach, "Die Sprossfolge der Stangeria, &c.," *Bot. Zeit.* xviii. (1896); Worsdell, "Anatomy of Macrozamia," *Ann. Bot.* x. (1896) (also papers by the same author, *Ann. Bot.*, 1898, *Trans. Linn. Soc.* v., 1900); Scott, "The Anatomical Characters presented by the Peduncle of Cycadaceae," *Ann. Bot.* xi. (1897); Lang, "Studies in the Development and Morphology of Cycadean Sporangia, No. 1.," *Ann. Bot.* xi. (1897); No. 11., *Ann. Bot.* xiv. (1900); Webber, "Development of the Antherozoids of Zamia," *Bot. Gaz.* (1897); Ikono, "Untersuchungen über die Entwicklung, &c., bei *Cycas revoluta*," *Journ. Coll. Sci. Japan*, xii. (1898); Wieland, "American Fossil Cycads," Carnegie Institution Publication (1906); Stopes, "Beiträge zur Kenntnis der Fortpflanzungsorgane der Cycadeen," *Flora* (1904); Caldwell, "Microcycas Calocoma," *Bot. Gaz.* xiv., 1907 (also papers on this and other Cycads in the *Bot. Gaz.*, 1907-1909); Matte, *Recherches sur l'appareil libéro-ligneux des Cycadées* (Caen, 1904). **Ginkgoales**: Hirase, "Études sur la fécondation, &c., de *Ginkgo biloba*," *Journ. Coll. Sci. Japan*, xii. (1898); Seward and Gowan, "Ginkgo biloba," *Ann. Bot.* xiv. (1900) (with bibliography); Ikeno, "Contribution à l'étude de la fécondation chez le *Ginkgo biloba*," *Ann. Sci. Nat.* xiii. (1901); Sprecher, *Le Ginkgo biloba* (Geneva, 1907). **Coniferales**: "Report of the Conifer Conference" (1891) *Journ. R. Hort. Soc.* xiv. (1892); Beissner, *Handbuch der Nadelholzkunde* (Berlin, 1891); Masters, "Comparative Morphology of the Coniferae," *Journ. Linn. Soc.* xxvii. (1891); *ibid.* (1895), &c.; Penhallow, "The Generic Characters of the North American Taxaceae and Coniferae," *Proc. and Trans. R. Soc. Canada*, ii. (1896); Blackman, "Fertilization in *Pinus sylvestris*," *Phil. Trans.* (1898) (with bibliography); Worsdell, "Structure of the Female Flowers in Conifers," *Ann. Bot.* xiv. (1900) (with bibliography); *ibid.* (1899); Veitch, *Manual of the Coniferae* (London, 1900); Penhallow, "Anatomy of North American Coniferales," *American Naturalist* (1904); Engler and Pilger, *Das Pflanzenreich, Taxaceae* (1903); Seward and Ford, "The Araucariaceae, recent and extinct," *Phil. Trans. R. Soc.* (1906) (with bibliography); Lawson, "*Sequoia sempervirens*," *Annals of Botany* (1904); Robertson, "*Torreya Californica*," *New Phytologist* (1904); Coker, "Gametophyte and Embryo of *Taxodium*," *Bot. Gazette* (1903); E. C. Jeffrey, "The Comparative Anatomy and Phylogeny of the Coniferales, part i. The Genus *Sequoia*," *Mem. Boston Nat. Hist. Soc.* v. No. 10 (1903); Gotham, "Zur Anatomie bester und fossiler Gymnospermen-Hölzer," *K. Preuss. Geol. Landes.* (Berlin, 1905) (for more recent papers, see *Ann. Bot.*, *New Phytologist*, and *Bot. Gazette*, 1906-1909). **Gnastales**: Hooker, "On *Welwitschia mirabilis*," *Trans. Linn. Soc.* xxiv. (1864); Bower, "Germination, &c., in *Gnetum*," *Journ. Mic. Sci.* xxii. (1882); *ibid.* (1881); Jaccard, "Recherches embryologiques sur l'*Ephedra helvetica*," *Diss. Inaug. Lausanne* (1894); Karsten, "Zur Entwicklungsgeschichte der Gattung *Gnetum*," *Cohn's Beiträge*, vi. (1893); Lott, "Contributions to the Life-History of the genus *Gnetum*," *Ann. Bot. Jard. Buitensorg*, xvi. (1899); Land, "*Ephedra trifurca*," *Bot. Gazette* (1904); Pearson, "Some observations on *Welwitschia mirabilis*," *Phil. Trans. R. Soc.* (1906); Pearson, "Further Observations on *Welwitschia*," *Phil. Trans. R. Soc.* vol. 200 (1909). (A. C. Sx.)

GYMNOSTOMACEAE, an order of Ciliate Infusoria (*g.v.*), characterized by a closed mouth, which only opens to swallow food actively, and body cilia forming a general or partial investment (rarely represented by a girdle of membranelles), but not differentiated in different regions. With the Aspirotracheaceae (*g.v.*) it formed the Holotricha of Stein.

GYMPIE, a mining town of March county, Queensland, Australia, 107 m. N. of Brisbane, and 61 m. S. of Maryborough by rail. Pop. (1901) 11,959. Numerous gold mines are worked in the district, which also abounds in copper, silver, antimony, cinnabar, bismuth and nickel. Extensive undeveloped coal-beds lie 40 m. N. at Miva. Gympie became a municipality in 1880.

GYNAECIUM (Gr. *gynaecion*, from *gynē*, woman), that part in a Greek house which was specially reserved for the women, in contradistinction to the "andron," the men's quarters; in the larger houses there was an open court with peristyles round, and as a rule all the rooms were on the same level; in smaller houses the servants were placed in an upper storey, and this seems to have been the case to a certain extent in the Homeric house of the Odyssey. "Gynaecionitis" is the term given by Procopius to the space reserved for women in the Eastern Church, and this separation of the sexes was maintained in the early Christian churches where there were separate entrances and accommodation for the men and women, the latter being placed in the triforium gallery, or, in its absence, either on one side of the church, the men being on the other, or occasionally in the aisles, the nave being occupied by the men.

GYNAECOLOGY (from Gr. *gynē*, *gynaikos*, a woman, and

logos, discourse), the name given to that branch of medicine which concerns the pathology and treatment of affections peculiar to the female sex.

Gynaecology may be said to be one of the most ancient branches of medicine. The papyrus of Ebers, which is one of the oldest known works on medicine and dates from 1550 B.C., contains references to diseases of women, and it is recorded that specialism in this branch was known amongst Egyptian medical practitioners. The Vedas contain a list of therapeutic agents used in the treatment of gynaecological diseases. The treatises on gynaecology formerly attributed to Hippocrates (460 B.C.) are now said to be spurious, but the wording of the famous oath shows that he was at least familiar with the use of gynaecological instruments. Diocles Carystius, of the Alexandrian school (4th century B.C.), practised this branch, and Praxagoras of Cos, who lived shortly after, opened the abdomen by laparotomy. While the Alexandrine school represented Greek medicine, Greeks began to practise in Rome, and in the first years of the Christian era gynaecologists were much in demand (Häser). A speculum for gynaecological purposes has been found in the ruins of Pompeii, and votive offerings of anatomical parts found in the temples show that various gynaecological malformations were known to the ancients. Writers who have treated of this branch are Celsus (50 B.C.-A.D. 7) and Soranus of Ephesus (A.D. 98-138), who refers in his works to the fact that the Roman midwives frequently called to their aid practitioners who made a special study of diseases of women. These midwives attended the simpler gynaecological ailments. This was no innovation, as in Athens, as mentioned by Hyginus, we find one Agnodice, a midwife, disguising herself in man's attire so that she might attend lectures on medicine and diseases of women. After instruction she practised as a gynaecologist. This being contrary to Athenian law she was prosecuted, but was saved by the wives of some of the chief men testifying on her behalf. Besides Agnodice we have Sotira, who wrote a work on menstruation which is preserved in the library at Florence, while Aspasia is mentioned by Aetius as the author of several chapters of his work. It is evident that during the Roman period much of the gynaecological work was in the hands of women. Martial alludes to the "*feminae medicae*" in his epigram on Leda. These women must not be confounded with the midwives who on monuments are always described as "obstetrices." Galen devotes the sixth chapter of his work *De locis affectis* to gynaecological ailments. During the Byzantine period may be mentioned the work of Oribasius (A.D. 325) and Moschion (2nd century A.D.) who wrote a book in Latin for the use of matrons and midwives ignorant of Greek.

In modern times James Parsons (1705-1770) published his *Elenchus gynaecopathologicus et obstetricarius*, and in 1755 Charles Perry published his *Mechanical account and explication of the hysterical passion and of all other nervous disorders incident to the sex, with an appendix on cancers*. In the early part of the 19th century fresh interest in diseases of women awakened. Joseph Récamier (1774-1852) by his writings and teachings advocated the use of the speculum and sound. This was followed in 1840 by the writings of Simpson in England and Huguier in France. In 1845 John Hughes Bennett published his great work on inflammation of the uterus, and in 1850 Tilt published his book on ovarian inflammation. The credit of being the first to perform the operation of ovariectomy is now credited to McDowell of Kentucky in 1809, and to Robert Lawson Tait (1845-1899) in 1883 the first operation for ruptured ectopic gestation.

Menstruation.—Normal menstruation comprises the escape of from 4 to 6 oz. of blood together with mucus from the uterus at intervals of twenty-eight days (more or less). The flow begins at the age of puberty, the average age of which in England is between fourteen and sixteen years. It ceases between forty-five and fifty years of age, and this is called the menopause or climacteric period, commonly spoken of as "the change of life." Both the age of puberty and that of the menopause may supervene earlier or later according to local conditions. At both times the menstrual flow may be replaced by haemorrhage from distant organs (epistaxis, haematemesis, haemoptysis); this is called *vicarious menstruation*. Menstruation is usually but not necessarily coincident with ovulation. The usual

disorders of menstruation are: (1) *amenorrhoea* (absence of flow), (2) *dysmenorrhoea* (painful flow), (3) *menorrhagia* (excessive flow), (4) *metrorrhagia* (excessive and irregular flow). Amenorrhoea may arise from physiological causes, such as pregnancy, lactation, the menopause; constitutional causes, such as phthisis, anaemia and chlorosis, febrile disorders, some chronic intoxications, such as morphinomania, and some forms of cerebral disease; local causes, which include malformations or absence of one or more of the genital parts, such as absence of ovaries, uterus or vagina, atresia of vagina, imperforate cervix, disease of the ovaries, or sometimes imperforate hymen. The treatment of amenorrhoea must be directed towards the cause. In anaemia and phthisis menstruation often returns after improvement in the general condition, with good food and good sanitary conditions, an outdoor life and the administration of iron or other tonics. In local conditions of imperforate hymen, imperforate cervix or ovarian disease, surgical interference is necessary. Amenorrhoea is permanent when due to absence of the genital parts. The causes of dysmenorrhoea are classified as follows: (1) ovarian, due to disease of the ovaries or Fallopian tubes; (2) obstructive, due to some obstacle to the flow, as stenosis, flexions and malpositions of the uterus, or malformations; (3) congestive, due to subinvolution, chronic inflammation of the uterus or its lining membrane, fibroid growths and polypi of the uterus, cardiac or hepatic disease; (4) neuralgic; (5) membranous. The foremost place in the treatment of dysmenorrhoea must be given to aperients and purgatives administered a day or two before the period is expected. By this means congestion is reduced. Hot baths are useful, and various drugs such as hyoscyamus, cannabis indica, phenalgin, ammonol or phenacetin have been prescribed. Medicinal treatment is, however, only palliative, and flexions and malpositions of the uterus must be corrected, stenosis treated by dilatation, fibroid growths if present removed, and endometritis when present treated by local applications or curetting according to its severity. Menorrhagia signifies excessive bleeding at the menstrual periods. Constitutional causes are purpura, haemophilia, excessive food and alcoholic drinks and warm climates; while local causes are congestion and displacements of the uterus, endometritis, subinvolution, retention of the products of conception, new growths in the uterus such as mucous and fibroid polypi, malignant growths, tubo-ovarian inflammation and some ovarian tumours. Metrorrhagia is a discharge of blood from the uterus, independent of menstruation. It always arises from disease of the uterus or its appendages. Local causes are polypi, retention of the products of conception, extra uterine gestation, haemorrhages in connexion with pregnancy, and new growths in the uterus. In the treatment of both menorrhagia and metrorrhagia the local condition must be carefully ascertained. When pregnancy has been excluded, and constitutional causes treated, efforts should be made to relieve congestion. Uterine haemostatics, as ergot, ergotin, tincture of hydrastis or hamamelis, are of use, together with rest in bed. Fibroid polypi and other new growths must be removed. Irregular bleeding in women over forty years of age is frequently a sign of early malignant disease, and should on no account be neglected.

Diseases of the External Genital Organs.—The vulva comprises several organs and structures grouped together for convenience of description (see REPRODUCTIVE SYSTEM). The affections to which these structures are liable may be classified as follows: (1) Injuries to the vulva, either accidental or occurring during parturition; these are generally rupture of the perinaeum. (2) *Vulvitis*. Simple vulvitis is due to want of cleanliness, or irritating discharges, and in children may result from threadworms. The symptoms are heat, itching and throbbing, and the parts are red and swollen. The treatment consists of rest, thorough cleanliness and fomentations. Infective vulvitis is nearly always due to gonorrhoea. The symptoms are the same as in simple vulvitis, with the addition of mucopurulent yellow discharge and scalding pain on micturition; if neglected, extension of the disease may result. The treatment consists of rest in bed, warm medicated baths several times a day or fomentations of boracic acid. The parts must be kept thoroughly clean and discharges swabbed away. Diphtheritic vulvitis occasionally occurs, and erysipelas of the vulva may follow wounds, but since the use of antiseptics is rarely seen. (3) Vascular disturbances may occur in the vulva, including varix, haematoma, oedema and gangrene; the treatment is the same as for the same disease in other parts. (4) The vulva is likely to be affected by a number of cutaneous affections, the most important being erythema, eczema, herpes, lichen, tubercle, elephantiasis, vulvitis pruriginosa, syphilis and kraurosis. These affections present the same characters as in other parts of the body. *Kraurosis vulvae*, first described by Lawson Tait in 1875, is an atrophic change accompanied by pain and a yellowish discharge; the cause is unknown. Pruritis vulvae is due to parasites, or to irritating discharges, as leucorrhoea, and is frequent in diabetic subjects. The hymen may be occasionally imperforate and require incision. Cysts and painful carunculae may occur on the clitoris. Any part of the vulva may be the seat of new growths, simple or malignant.

Diseases of the Vagina.—(1) Malformations. The vagina may be absent in whole or in part or may present a septum. Stenosis of the vagina may be a barrier to menstruation. (2) Displacements of the vagina; (a) cystocoele, which is a hernia of the bladder into the vagina; (b) rectocoele, a hernia of the rectum into the vagina. The

cause of these conditions is relaxation of the tissues due to parturition. The palliative treatment consists in keeping up the parts by the insertion of a pessary; when this fails operative interference is called for. (3) Fistulae may form between the vagina and bladder or vagina and rectum; they are generally caused by injuries during parturition or the late stages of carcinoma. Persistent fistulae require operative treatment. The vagina normally secretes a thin opalescent acid fluid derived from the lymph serum and the shedding of squamous epithelium. This fluid normally contains the vagina bacillus. In pathological conditions of the vagina this secretion undergoes changes. For practical purposes three varieties of *vaginitis* may be described: (a) simple catarrhal vaginitis is due to the same causes as simple vulvitis, and occasionally in children is important from a medico-legal aspect when it is complicated by vulvitis. The symptoms are heat and discomfort with copious mucopurulent discharge. The only treatment required is rest, with vaginal douches of warm unirritating lotions such as boracic acid or subacetate of lead. (b) Gonorrhoeal vaginitis is most common in adults. The patient complains of pain and burning, pain on passing water and discharge which is generally green or yellow. The results of untreated gonorrhoeal vaginitis are serious and far-reaching. The disease may spread up the genital passages, causing endometritis, salpingitis and septic peritonitis, or may extend into the bladder, causing cystitis. Strict rest should be enjoined, douches of carbolic acid (1 in 40) or of perchloride of mercury (1 in 2000) should be ordered morning and evening, the vagina being packed with tampons of iodoform gauze. Saline purgatives and alkaline diuretics should be given. (c) Chronic vaginitis (leucorrhoea or "the whites") may follow acute conditions and persist indefinitely. The vagina is rarely the seat of tumours, but cysts are common.

Diseases of the Uterus.—The uterus undergoes important changes during life, chiefly at puberty and at the menopause. At puberty it assumes the pear shape characteristic of the mature uterus. At the menopause it shares in the general atrophy of the reproductive organs. It is subject to various disorders and misplacements. (a) *Displacements of the Uterus*.—The normal position of the uterus, when the bladder is empty, is that of anteversion. We have therefore to consider the following conditions as pathological: ante-flexion, retroflexion, retroversion, inversion, prolapse and procidentia. Slight anteversion or bending forwards is normal; when exaggerated it gives rise to dysmenorrhoea, sterility and reflex nervous phenomena. This condition is usually congenital and is often associated with under-development of the uterus, from which the sterility results. The treatment is by dilatation of the canal or by a plastic operation. Retroflexion is a bending over of the uterus backwards, and occurs as a complication of retroversion (or displacement backwards). The causes are (1) any cause tending to make the fundus or upper part of the uterus extra heavy, such as tumours or congestion, (2) loss of tone of the uterine walls, (3) adhesions formed after cellulitis, (4) violent muscular efforts, (4) weakening of the uterine supports from parturition. The symptoms are dysmenorrhoea, pain on defaecation and constipation from the pressure of the fundus on the rectum; the patient is often sterile. The treatment is the replacing of the uterus in position, where it can be kept by the insertion of a pessary; failing this, operative treatment may be required. Retroversion when pathological is rarer than retroflexion. It may be the result of injury or is associated with pregnancy or a fibroid. The symptoms are those of retroflexion with feeling of pain and weight in the pelvis and desire to micturate followed by retention of urine due to the pressure of the cervix against the base of the bladder. The uterus must be skillfully replaced in position; when pessaries fail to keep it there the operation of hysteropexy gives excellent results.

Inversion occurs when the uterus is turned inside out. It is only possible when the cavity is dilated, either after pregnancy or by a polypus. The greater number of cases follow delivery and are acute. Chronic inversions are generally due to the weight of a polypus. The symptoms are menorrhagia, metrorrhagia and bladder troubles; on examination a tumour-like mass occupies the vagina. Reduction of the condition is often difficult, particularly when the condition has lasted for a long time. The tumour which has caused the inversion must be excised. Prolapse and procidentia are different degrees of the same variety of displacement. When the uterus lies in the vagina it is spoken of as prolapse, when it protrudes through the vulva it is procidentia. The causes are directly due to increased intra-abdominal pressure, increased weight of the uterus by fibroids, violent straining, chronic cough and weakening of the supporting structures of the pelvic floor, such as laceration of the vagina and perinaeum. Traction on the uterus from below (as a cervical tumour) may be a cause; advanced age, laborious occupations and frequent pregnancies are indirect causes. The symptoms are a "bearing down" feeling, pain and fatigue in walking, trouble with micturition and defaecation. The condition is generally obvious on examination. As a rule the uterus is easy to replace in position. A rubber ring pessary will often serve to keep it there. If the perinaeum is very much torn it may be necessary to repair it. Various operations for retaining the uterus in position are described. (b) *Enlargements of the Uterus* (hypertrophy or hyperplasia). This condition may sometimes involve the uterus as a whole or may be most marked in the body or in the cervix. It follows chronic congestion or inflammatory

prolapse, or any condition interfering with the circulation. The symptoms comprise local discomfort and sometimes dysmenorrhœa, leucorrhœa or menorrhagia. When the elongation occurs in the cervical portion the only possible treatment is amputation of the cervix. Atrophy of the uterus is normal after the menopause. It may follow the removal of the tubes and ovaries. Some constitutional diseases produce the same result, as tuberculosis, chlorosis, chronic morphinism and certain diseases of the central nervous system.

(c) *Injuries and Diseases resultant from Pregnancy.*—The most frequent of these injuries is laceration of the cervix uteri, which is frequent in precipitate labour. Once the cervix is torn the raw surfaces become covered by granulations and later by cicatricial tissue, but as a rule they do not unite. The torn lips may become unhealthy, and the congestion and œdema spread to the body of the uterus. A lacerated cervix does not usually give rise to symptoms; these depend on the accompanying endometritis, and include leucorrhœa, aching and a feeling of weight. Lacerations are to be felt digitally. As lacerations predispose to abortion the operation of trachelorrhaphy or repair of the cervix is indicated. Perforation of the uterus may occur from the use of the sound in diseased conditions of the uterine walls. Superinvolution means premature atrophy following parturition. Subinvolution is a condition in which the uterus fails to return to its normal size and remains enlarged. Retention of the products of conception may cause irregular hæmorrhages and may lead to a diagnosis of tumour. The uterus should be carefully explored.

(d) *Inflammations Acute and Chronic.*—The mucous membrane lining the cervical canal and body of the uterus is called the endometrium. Acute inflammation or endometritis may attack it. The chief causes are sepsis following labour or abortion, extension of a gonorrhœal vaginitis, or gangrene or infection of a uterine myoma. The puerperal endometritis following labour is an avoidable disease due to lack of scrupulous aseptic precautions.

Gonorrhœal endometritis is an acute form associated with copious purulent discharge and well-marked constitutional disturbance. The temperature ranges from 99° to 105° F., associated with pelvic pain, and rigors are not uncommon. The tendency is to recovery with more or less protracted convalescence. The most serious complications are extension of the disease and later sterility. Rest in bed and intrauterine irrigation, followed by the introduction of iodoform pencils into the uterine cavity, should be resorted to, while pain is relieved by hot fomentations and sitz baths. Chronic endometritis may be the sequela of the acute form, or may be septic in origin, or the result of chronic congestion, acute retroflexion or subinvolution following delivery or abortion. The varieties are glandular, interstitial, hæmorrhagic and senile. The symptoms are disturbance of the menstrual function, headache, pain and pelvic discomfort, and more or less profuse thick leucorrhœal discharge. The treatment consists in attention to the general health, with suitable laxatives and local injections, and in obstinate cases curettage is the most effectual measure. The disease is frequently associated with adenomatous disease of the cervix, formerly called erosion. In this disease there is a new formation of glandular elements, which enlarge and multiply, forming a soft velvety areola dotted with pink spots. This was formerly erroneously termed ulceration. The cause is unknown. It occurs in virgins as well as in mothers, but it often accompanies lacerations of the cervix. The symptoms are indefinite pain and leucorrhœa. The condition is visible on inspection with a speculum. The treatment is swabbing with iodized phenol or curettage. The body of the uterus may also be the seat of adenomatous disease. Tuberculosis may attack the uterus; this usually forms part of a general tuberculosis.

(e) *New Growths in the Uterus.*—The uterus is the most common seat of new growths. From the researches of von Gurit, compiled from the Vienna Hospital Reports, embracing 15,880 cases of tumour, females exceed males in the proportion of seven to three, and of this large majority uterine growths account for 25%. When we consider its periodic monthly engorgements and the alternate hypertrophy and involution it undergoes in connexion with pregnancy, we can anticipate the special proneness of the uterus to new growths. Tumours of the uterus are divided into benign and malignant. The benign tumours known as fibroids or myomata are very common. They are stated by Bayle to occur in 20% of women over 35 years of age, but happily in a great number of cases they are small and give rise to no symptoms. They are definitely associated with the period of sexual activity and occur more frequently in married women than in single, in the proportion of two to one (Winckel). It is doubtful if they ever originate after the menopause. Indeed if uncomplicated by changes in them they share in the general atrophy of the sexual organs which then takes place. They are divided according to their position in the tissues into intramural, subserous and submucous (the last when it has a pedicle forms a polypus), or as to the part of the uterus in which they develop into fibroids of the cervix and fibroids of the body. Intramural and submucous fibroids give rise to hæmorrhage. The menses may be so increased that the patient is scarcely ever free from hæmorrhage. The pressure of the growth may cause dysmenorrhœa, or pressure on the bladder and rectum may cause dysuria, retention or rectal tenesmus. The uterus may be displaced by the weight of the tumour. Secondary

changes take place in fibroids, such as mucous degeneration, fatty metamorphosis, calcification, septic infection (sloughing fibroid) and malignant (sarcomatous) degeneration.

The modes in which fibroids imperil life are hæmorrhage (the commonest of all), septic infection, which is one of the most dangerous, impaction when it fits the true pelvis so tightly that the tumour cannot rise, twisting of the pedicle by rotation, leading to sloughing and intestinal and urinary obstruction. When fibroids are complicated by pregnancy, impaction and consequent abortion may take place, or a cervical myoma may offer a mechanical obstacle to delivery or lead to serious post partum hæmorrhage. In the treatment of fibroids various drugs (ergot, hamamelis, hydrastis canadensis) may be tried to control the hæmorrhage, and repose and the injection of hot water (120° F.) are sometimes successful, together with electrical treatment. Surgical measures are needed, however, in severe recurrent hæmorrhage, intestinal obstruction, sloughing and the co-existence of pregnancy. An endeavour must be made if possible to enucleate the fibroid, or hysterectomy (removal of the uterus) may be required. The operation of removal of the ovaries to precipitate the menopause has fallen into disuse.

(f) *Malignant Disease of the Uterus.*—The varieties of malignant disease met with in the uterus are sarcoma, carcinoma and chorion-epithelioma malignum. Sarcomata may occur in the body and in the neck. They occur at an earlier age than carcinomata. Marked enlargement and hæmorrhage are the symptoms. The differential diagnosis is microscopic. Extirpation of the uterus is the only chance of prolonging life.

The age at which women are most subject to carcinoma (cancer) of the uterus is towards the decline of sexual life. Of 3385 collected cases of cancer of the uterus 1169 occurred between 40 and 50, and 856 between 50 and 60. In contradistinction to fibroid tumours it frequently arises after the menopause. It may be divided into cancer of the body and cancer of the neck (cervix). Cancer of the neck of the uterus is almost exclusively confined to women who have been pregnant (Bland-Sutton). Predisposing causes may be injuries during delivery. The symptoms which induce women to seek medical aid are hæmorrhage, foetid discharge, and later pain and cachexia. An unfortunate belief amongst the public that the menopause is associated with irregular bleeding and offensive discharges has prevented many women from seeking medical advice until too late. It cannot be too widely understood that cancer of the cervix is in its early stages a purely local disease, and if removed in this stage usually results in cure. So important is the recognition of this fact in the saving of human life that at the meeting of the British Medical Association in April 1909 the council issued for publication a special appeal to medical practitioners, midwives and nurses, and directed it to be published in British and colonial medical and nursing journals. It will be useful to quote here a part of the appeal directed to midwives and nurses: "Cancer may occur at any age and in a woman who looks quite well, and who may have no pain, no wasting, no foul discharge and no profuse bleeding. To wait for pain, wasting, foul discharge or profuse bleeding is to throw away the chance of successful treatment. The early symptoms of cancer of the womb are:—(1) bleeding which occurs after the change of life, (2) bleeding after sexual intercourse or after a vaginal douche, (3) bleeding, slight or abundant, even in young women, if occurring between the usual monthly periods, and especially when accompanied by a bad-smelling or watery blood-tinged discharge, (4) this watery discharge occurring at any age." On examination the cervix presents certain characteristic signs, though these may be modified according to the variety of cancer present. Hard nodules or definite loss of substance, extreme friability and bleeding after slight manipulation, are suspicious. Epithelial cancer of the cervix may assume a proliferating ulcerative type, forming the well-known "cauliflower" excrescence. The treatment of cancer of the cervix is free removal at the earliest possible moment. Cancer of the body of the uterus is rare before the 45th year. It is most frequent at or subsequent to the menopause. The majority of the patients are nulliparæ (Bland-Sutton). The signs are fitful hæmorrhages after the menopause, followed by profuse and offensive discharges. The uterus on examination often feels enlarged. The diagnosis being made, hysterectomy (removal of the uterus) is the only treatment. Cancer of the body of the uterus may complicate fibroids. Chorion-epithelioma malignum (deciduoma) was first described in 1889 by Sänger and Pflicfer. It is a malignant disease presenting microscopic characters resembling decidua. It occurs in connexion with recent pregnancy, and particularly with the variety of abortion termed hydatid mole. In many cases it destroys life with a rapidity unequalled by any other kind of growth. It quickly ulcerates and infiltrates the uterine tissues, forming metastatic growths in the lung and vagina. Clinically it is recognized by the occurrence after pregnancy of violent hæmorrhages, progressive cachexia and fever with rigors. Recent suggestions have been made as to chorion-epithelioma being the result of pathological changes in the lutein tissue of the ovary. The growth is usually primary in the uterus, but may be so in the Fallopian tubes and in the vagina. A few cases have been recorded unconnected with pregnancy. The virulence of chorion-epithelioma varies, but in the present state of our knowledge immediate removal of the primary growth along with the affected organ is the only treatment.

Diseases of the Fallopian Tubes.—The Fallopian tubes or oviducts

are liable to inflammatory affections; tuberculosis, sarcomata, cancer, chorion-epithelioma and tubal pregnancy. Salpingitis (inflammation of the oviducts) is nearly always secondary to septic infection of the genital tract. The chief causes are septic endometritis following labour or abortion, gangrene of a myoma, gonorrhoea, tuberculosis and cancer of the uterus; it sometimes follows the specific fevers. When the pus escapes from the tubes into the coelom it sets up pelvic peritonitis. When the inflammation is adjacent to the ostium it leads to the matting together of the tubal fimbriae and gives them to an adjacent organ. This seals the ostium. The occluded tube may now have an accumulation of pus in it (pyosalpinx). When in consequence of the sealing of the ostium the tube becomes distended with serous fluid it is termed hydrosalpinx. Haematosalpinx is a term applied to the non-gravid tube distended with blood; later the tubes may become sclerosed. Acute septic salpingitis is ushered in by a rigor, the temperature rising to 103°, 104° F., with severe pain and constitutional disturbance. The symptoms may become merged in those of general peritonitis. In chronic disease there is a history of puerperal trouble followed by sterility, with excessive and painful menstruation. Acute salpingitis requires absolute rest, opium suppositories and hot fomentations. With urgent symptoms removal of the inflamed adnexa must be resorted to. Chronic salpingitis often renders a woman an invalid. Permanent relief can only be afforded by surgical intervention. Tuberculous salpingitis is usually secondary to other tuberculous infections. The Fallopian tubes may be the seat of malignant disease. This is rarely primary. By far the most important of the conditions of the Fallopian tubes is tubal pregnancy (or ectopic gestation). It is now known that fertilization of the human ovum by the spermatozoon may take place even when the ovum is in its follicle in the ovary, for oosperms have been found in the ovary and Fallopian tubes as well as in the uterus. Belief in ovarian pregnancy is of old standing, and had been regarded as possible but unproved, no case of an early embryo in its membranes in the sac of an ovary being forthcoming, until the remarkable case published by Dr Catherine van Tussemboeck of Amsterdam in 1809 (Bland-Sutton). Tubal pregnancy is most frequent in the left tube; it sometimes complicates uterine pregnancy; rarely both tubes are pregnant. When the oosperm lodges in the ampulla or isthmus it is called tubal gestation; when it is retained in the portion traversing the uterine wall it is called tubo-uterine gestation. Wherever the fertilized ovum remains and implants its villi the tube becomes turgid and swollen, and the abdominal ostium gradually closes. The ovum in this situation is liable to apoplexy, forming tubal mole. When the abdominal ostium remains pervious the ovum may escape into the coelomic cavity (tubal abortion); death from shock and haemorrhage into the abdominal cavity may result. When neither of these occurrences has taken place the ovum continues to grow inside the tube, the rupture of the distended tube usually taking place between the sixth and the tenth week. The rupture of the tube may be intraperitoneal or extraperitoneal. The danger is death from haemorrhage occurring during the rupture, or adhesions may form, the retained blood forming a haematocoele. The ovum may be destroyed or may continue to develop. In rare cases rupture may not occur, the tube bulging into the peritoneal cavity; and the foetus may break through the membranes and lie free among the intestines, where it may die, becoming encysted or calcified. The tubal placenta possesses foetal structures, the true decidua forming in the uterus. The signs suggestive of tubal pregnancy before rupture are missed periods, pelvic pains and the presence of an enlarged tube. When rupture takes place it is attended in both varieties with sudden and severe pain and more or less marked collapse, and a tumour may or may not be felt according to the situation of the rupture. There is a general "feeling of something having given way." If diagnosed before rupture, the sac must be removed by abdominal section. In intraperitoneal rupture immediate operation affords the only chance of saving life. In extraperitoneal rupture the foetus may occasionally remain alive until full term and be rescued by abdominal section, if the condition is recognized, or a false labour may take place, accompanied by death of the foetus.

Diseases of the Ovaries and Parovarium.—The ovaries undergo striking changes at puberty, and again at the menopause, after which there is a gradual shrinkage. One or both may be absent or malformed, or they are subject to displacements, being either undescended, contained in a hernia or prolapsed. Either of these conditions, if a source of pain, may necessitate their removal. The ovary is also subject to haemorrhage or apoplexy. Acute inflammations (oöphoritis) are constantly associated with salpingitis or other septic conditions of the genital tract or with an attack of mumps. The relation of oöphoritis to mumps is at present unknown. Acute oöphoritis may culminate in abscess but more usually adhesions are formed. The surgical treatment is that of pyosalpinx. Chronic inflammation may follow acute or be consequent on pelvic cellulitis. Its constant features are more or less pain followed by sterility. The ovary may be the seat of tuberculosis, which is generally secondary to other lesions. Suppuration and abscess of the ovary also occur. Periöphoritis, or chronic inflammation in the neighbourhood, may also involve the gland. The cause of cirrhosis of the ovaries is unknown, though it may be associated with cirrhotic liver. The change is met with in women between 20 and

40 years of age, the ovaries being in a shrunken, hard, wrinkled condition. Under ovarian neuralgia are grouped indefinite painful symptoms occurring frequently in neurotic and alcoholic subjects, and often worse during menstruation. The treatment, whether local or operative, is usually unsatisfactory. The ovary is frequently the seat of tumours, dermoids and cysts. Cysts may be simple, unilocular or multilocular, and may attain an enormous size. The largest on record was removed by Dr Elizabeth Reifsnnyder of Shanghai, and contained 100 litres of fluid, and the patient recovered. The operation is termed ovariectomy. Dermoid cysts containing skin, bones, teeth and hair, are of frequent growth in the ovary, and have attained the weight of from 20 to 40 kilogrammes. In one case a girl weighed 27 kilogrammes and her tumour 44 kilogrammes (Keen). Papillomatous cysts also occur in the ovary. Parovarian and Gärtnerian cysts are found, and adenomata form 20% of all ovarian cysts. Occasionally the tunic of peritoneum surrounding the ovary becomes distended with serous fluid. This is termed ovarian hydrocoele. Ovarian fibroids occur, and malignant disease (sarcoma and carcinoma) is fairly frequent, sarcoma being the most usual ovarian tumour occurring before puberty. Carcinoma of the ovary is rarely primary, but it is a common situation for secondary cancer to that of the breast, gall-bladder or gastro-intestinal tract. The treatment of all rapidly-growing tumours of the ovary is removal.

Diseases of the Pelvic Peritoneum and Connective Tissue.—Women are excessively liable to peritoneal infections. (1) Septic infection often follows acute salpingitis and may give rise to pelvic peritonitis (perimetritis), which may be adhesive, serous or purulent. It may follow the rupture of ovarian or dermoid cysts, rupture of the uterus, extra uterine pregnancy or extension from pyosalpinx. The symptoms are severe pain, fever, 103° F. and higher, marked constitutional disturbances, vomiting, restlessness, even delirium. The abdomen is fixed and tympanitic. Its results are the formation of adhesions causing abnormal positions of the organs, or chronic peritonitis may follow. The treatment is rest in bed, opium, hot stupes to the abdomen and quinine. (2) Epithelial infections take place in the peritoneum in connection with other malignant growths. (3) Hydroperitonium, a collection of free fluid in the abdominal cavity, may be due to tumours of the abdominal viscera or to tuberculosis of the peritoneum. (4) Pelvic cellulitis (parametritis) signifies the inflammation of the connective tissue between the folds of the broad ligament (mesometrium). The general causes are septic changes following abortion, delivery at term (especially instrumental delivery), following operations on the uterus or salpingitis. The symptoms are chill followed by severe intrapelvic pain and tension, fever 100° to 102° F. There may be nausea and vomiting, diarrhoea, rectal tenseness and dysuria. If consequent on parturition the lochia cease or become offensive. On examination there is tenderness and swelling in one flank and the uterus becomes fixed and immovable in the exudate as if embedded in plaster of Paris. The illness may go to resolution if treated by rest, opium, hot stupes or icebags and glycerine tampons, or may go on to suppuration forming pelvic abscess, which signifies a collection of pus between the layers of the broad ligament. The pus in a pelvic abscess may point and escape through the walls of the vagina, rectum or bladder. It occasionally points in the groin. If the pus can be localized an incision should be made and the abscess drained. The tumours which arise in the broad ligament are haematocoele, solid tumours (as myomata, lipomata and sarcomata), and echinococcus colonies (hydatids).

BIBLIOGRAPHY.—Albutt, Playfair and Eden, *System of Gynaecology* (1906); McNaughton Jones, *Manual of Diseases of Women* (1904); Bland-Sutton and Giles, *Diseases of Women* (1906); C. Lockyer, "Lutein Cysts in association with Chorio-Epithelioma," *Journal of Obstetrics and Gynaecology* (January, 1905); W. Stewart McKay, *History of Ancient Gynaecology*; Hart and Barbour, *Diseases of Women*; Howard Kelly, *Operative Gynaecology*. (H. L. H.)

GYÖNGYÖSI, ISTVÁN (STEPHEN) (1620-1704), Hungarian poet, was born of poor but noble parents in 1620. His abilities early attracted the notice of Count Ferencz Wesselényi, who in 1640 appointed him to a post of confidence in Füleke castle. Here he remained till 1653, when he married and became an assessor of the judicial board. In 1681 he was elected as a representative of his county at the diet held at Soprony (Oedenburg). From 1686 to 1693, and again from 1700 to his death in 1704, he was deputy lord-lieutenant of the county of Gömör. Of his literary works the most famous is the epic poem *Murányi Veus* (Caschau, 1664), in honour of his benefactor's wife Maria Szécsi, the heroine of Murány. Among his later productions the best known are *Rássa-Kaszoró*, or Rose-Wreath (1690), *Kemény-János* (1693), *Cupidó* (1695), *Painodia* (1695) and *Chariklia* (1700).

The earliest edition of his collected poetical works is by Dugonics (Pressburg and Pest, 1796); the best modern selection is that of Toldy, entitled *Gyöngyösi István válogatott poézai munkái* (Select poetical works of Stephen Gyöngyösi, 2 vols., 1864-1865).

GYÖR (Ger. Raab), a town of Hungary, capital of a county of the same name, 88 m. W. of Budaapest by rail. Pop. (1900)

27,758. It is situated at the confluence of the Raab with the Danube, and is composed of the inner town and three suburbs. Győr is a well-built town, and is the seat of a Roman Catholic bishop. Amongst its principal buildings are the cathedral, dating from the 12th century, and rebuilt in 1639-1654; the bishop's palace; the town hall; the Roman Catholic seminary for priests and several churches. There are manufactures of cloth, machinery and tobacco, and an active trade in grain and horses. Twenty miles by rail W.S.W. of the town is situated Csorna, a village with a Premonstratensian abbey, whose archives contain numerous valuable historical documents.

Győr is one of the oldest towns in Hungary and occupies the site of the Roman *Arabona*. It was already a place of some importance in the 10th century, and its bishopric was created in the 11th century. It was a strongly fortified town which resisted successfully the attacks of the Turks, into whose hands it fell by treachery in 1594, but they retained possession of it only for four years. Montecucculi made Győr a first-class fortress, and it remained so until 1783, when it was abandoned. At the beginning of the 19th century, the fortifications were re-erected, but were easily taken by the French in 1809, and were again stormed by the Austrians on the 28th of June 1849.

About 11 m. S.E. of Győr on a spur of the Bakony Forest lies the famous Benedictine abbey of Pannonhalma (Ger. *St. Marienberg*; Lat. *Mons Sancti Martini*), one of the oldest and wealthiest abbeys of Hungary. It was founded by King St. Stephen, and the original deed from 1001 is preserved in the archives of the abbey. The present building is a block of palaces, containing a beautiful church, some of its parts dating from the 12th century, and lies on a hill 1200 ft. high. The church has a tower 130 ft. high. In the convent there are a seminary for priests, a normal school, a gymnasium and a library of 120,000 vols. The chief abbot has the rank of a bishop, and is a member of the Upper House of the Hungarian parliament, while in spiritual matters he is subordinate immediately to the Roman curia.

GYP, the pen name of SIBYLLE GABRIELLE MARIE ANTOINETTE RIQUET DE MIRABEAU, Comtesse de Martel de Janville (1850-) French writer, who was born at the château of Koetsal in the Morbihan. Her father, who was the grandson of the vicomte de Mirabeau and great-nephew of the orator, served in the Papal Zouaves, and died during the campaign of 1860. Her mother, the comtesse de Mirabeau, in addition to some graver compositions, contributed to the *Figaro* and the *Vie parisienne*, under various pseudonyms, papers in the manner successfully developed by her daughter. Under the pseudonym of "Gyp" Madame de Martel, who was married in 1866, sent to the *Vie parisienne*, and later to the *Revue des deux mondes*, a large number of social sketches and dialogues, afterwards reprinted in volumes. Her later work includes stories of a more formal sort, essentially differing but little from the shorter studies. The following list includes some of the best known of Madame de Martel's publications, nearly seventy in number: *Petit Bob* (1882); *Autour du mariage* (1883); *Ce que femme veut* (1883); *Le Monde à côté* (1884); *Sans voiles* (1885); *Autour du divorce* (1886); *Dans le train* (1886); *Mademoiselle Loulou* (1888); *Bob au salon* (1888-1889); *L'Éducation d'un prince* (1890); *Passionnelle* (1891); *Ohé! la grande vie* (1891); *Une Élection à Tigre-sur-mer* (1891); an account of "Gyp's" experiences in support of a Boulangist candidate; *Mariage civil* (1892); *Ces bons docteurs* (1892); *Du haut en bas* (1893); *Mariage de chiffon* (1894); *Leurs âmes* (1895); *Le Cœur d'Ariane* (1895); *Le Bonheur de Ginette* (1896); *Totote* (1897); *Lune de miel* (1898); *Israël* (1898); *L'Entrée* (1899); *Le Pays des champs* (1900); *Trop de chic* (1900); *Le Friquet* (1901); *La Fie* (1902); *Un Mariage chic* (1903); *Un Ménage dernier cri* (1903); *Maman* (1904); *Le Cœur de Pierre* (1905). From the first "Gyp" writing of a society to which she belonged, displayed all the qualities which have given her a distinct, if not pre-eminent, position among writers of her class. Those qualities included an intense faculty of observation, much skill in *lanuendo*, a mordant wit combined with some breadth of humour, and a singular power of animating

ordinary dialogues without destroying the appearance of reality. Her Parisian types of the spoiled child, of the precocious school-girl, of the young bride, and of various masculine figures in the gay world, have become almost classical, and may probably survive as faithful pictures of luxurious manners in the 19th century. Some later productions, inspired by a violent anti-Semitic and Nationalist bias, deserve little consideration. An earlier attempt to dramatize *Autour du mariage* was a failure, not owing to the audacities which it shares with most of its author's works, but from lack of cohesion and incident. More successful was *Mademoiselle Ève* (1895), but indeed "Gyp's" successes are all achieved without a trace of dramatic faculty. In 1901 Madame de Martel furnished a sensational incident in the Nationalist campaign during the municipal elections in Paris. She was said to have been the victim of a kidnapping outrage or piece of horseplay provoked by her political attitude, but though a most circumstantial account of the outrages committed on her and of her adventurous escape was published, the affair was never clearly explained or verified.

GYPSUM, a common mineral consisting of hydrous calcium sulphate, named from the Gr. *γύψος*, a word used by Theophrastus to denote not only the raw mineral but also the product of its calcination, which was employed in ancient times, as it still is, as a plaster. When crystallized, gypsum is often called selenite, the *σελήνη* of Dioscorides, so named from *σέληνη*, "the moon," probably in allusion to the soft moon-like reflection of light from some of its faces, or, according to a legend, because it is found at night when the moon is on the increase. The granular, marble-like gypsum is termed alabaster (*q.v.*).

Gypsum crystallizes in the monoclinic system, the habit of the crystals being usually either prismatic or tabular; in the latter case the broad planes are parallel to the faces of the clinopinacoid. The crystals may become lenticular by curvature of certain faces. In the characteristic type represented in fig. 1, *f* represents the prism, *l* the hemi-pyramid and *P* the clinopinacoid. Twins are common, as in fig. 2, forming in some cases arrow-headed and swallow-tailed crystals. Cleavage is perfect parallel to the clinopinacoid, yielding thin plates, often diamond-shaped, with pearly lustre; these flakes are usually flexible, but may be brittle, as in the gypsum of Montmartre. Two other cleavages are recognized, but they are imperfect. Crystals of gypsum, when occurring

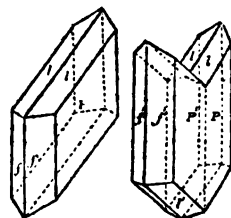

FIG. 1.

FIG. 2.

in clay, may enclose much muddy matter; in other cases a large proportion of sand may be mechanically entangled in the crystals without serious disturbance of form; whilst certain crystals occasionally enclose cavities with liquid and an air-bubble. Gypsum not infrequently becomes fibrous. This variety occurs in veins, often running through gypseous marls, with the fibres disposed at right angles to the direction of the vein. Such gypsum when cut and polished has a pearly opalescence, or satiny sheen, whence it is called *satim-spar* (*q.v.*).

Gypsum is so soft as to be scratched even by the finger-nail ($H = 1.5$ to 2). Its specific gravity is about 2.3. The mineral is slightly soluble in water, one part of gypsum being soluble, according to G. K. Cameron, in 372 parts of pure water at 26° C. Waters percolating through gypseous strata, like the Keuper marls, dissolve the calcium sulphate and thus become permanently hard or "selenitic." Such water has special value for brewing pale ale, and the water used by the Burton breweries is of this character; hence the artificial dissolving of gypsum in water for brewing purposes is known as "burtonization."

Deposits of gypsum are formed in boilers using selenitic water. Pure gypsum is colourless or white, but it is often tinted, especially in the alabaster variety, grey, yellow or pink. Gypsum crystallizes with two molecules of water, equal to about 21% by

weight, and consequently has the formula $\text{CaSO}_4 \cdot 2\text{H}_2\text{O}$. By exposure to strong heat all the water may be expelled, and the substance then has the composition of anhydrite (*g.v.*). When the calcination, however, is conducted at such a temperature that only about 75% of the water is lost, it yields a white pulverulent substance, known as "plaster of Paris," which may readily be caused to recombine with water, forming a hard cement. The gypsum quarries of Montmartre, in the north of Paris, were worked in Tertiary strata, rich in fossils. Gypsum is largely quarried in England for conversion into plaster of Paris, whence it is sometimes known as "plaster stone," and since much is sent to the Staffordshire potteries for making moulds it is also termed "potter's stone." The chief workings are in the Keuper marls near Newark in Nottinghamshire, Fauld in Staffordshire and Chellaston in Derbyshire. It is also worked in Permian beds in Cumberland and Westmorland, and in Purbeck strata near BATTLE in Sussex.

Gypsum frequently occurs in association with rock-salt, having been deposited in shallow basins of salt water. Much of the calcium in sea-water exists as sulphate; and on evaporation of a drop of sea-water under the microscope this sulphate is deposited as acicular crystals of gypsum. In salt-lagoons the deposition of the gypsum is probably effected in most cases by means of micro-organisms. Waters containing sulphuretted hydrogen, on exposure to the air in the presence of limestone, may yield gypsum by the formation of sulphuric acid and its interaction with the calcium carbonate. In volcanic districts gypsum is produced by the action of sulphuric acid, resulting from the oxidation of sulphurous vapours, on lime-bearing minerals, like labradorite and augite, in the volcanic rocks; hence gypsum is common around solfataras. Again, by the oxidation of iron-pyrites and the action of the resulting sulphuric acid on limestone or on shells, gypsum may be formed; whence its origin in most clays. Gypsum is also formed in some cases by the hydration of anhydrite, the change being accompanied by an increase of volume to the extent of about 60%. Conversely gypsum may, under certain conditions, be dehydrated or reduced to anhydrite.

Some of the largest known crystals of selenite have been found in southern Utah, where they occur in huge geodes, or crystallized cavities, in deposits from the old salt-lakes. Fine crystals, sometimes curiously bent, occur in the Permian rocks of Friedrichroda, near Gotha, where there is a grotto called the Marienglashöhle, close to Rheinhardbrunn. Many of the best localities for selenite are in the New Red Sandstone formation (Trias and Permian), notably the salt-mines of Hall and Hallein, near Salzburg, and of Bex in Switzerland. Excellent crystals, usually of a brownish colour arranged in groups, are often found in the brine-chambers and the launders used in salt-works. Selenite also occurs in fine crystals in the sulphur-bearing marls of Girgenti and other Sicilian localities; whilst in Britain very bold crystals are yielded by the Kimeridge clay of Shotover Hill near Oxford. Twisted crystals and rosettes of gypsum found in the Mammoth Cave, Kentucky, have been called "oulopholites" (*οὔλος*, "woolly"; *φωλέος*, "cave").

In addition to the use of gypsum in cement-making, the mineral finds application as an agricultural agent in dressing land, and it has also been used in the manufacture of porcelain and glass. Formerly it was employed, in the form of thin cleavage-plates, for glazing windows, and seems to have been, with mica, called *lapis specularis*. It is still known in Germany as *Marienglas* and *Franzenis*. Delicate cleavage-plates of gypsum are used in microscopic petrography for the determination of certain optical constants in the rock-forming minerals. (F. W. R.*)

GYROSCOPE AND GYROSTAT. These are scientific models or instruments designed to illustrate experimentally the dynamics of a rotating body such as the spinning-top, hoop and bicycle, and also the precession of the equinox and the rotation of the earth.

The gyroscope (Gr. *γῑρος*, ring, *σκοπεῖν*, to see) may be distinguished from the gyrostat (*γῑρος*, and *στατικός*, stationary) as an instrument in which the rotating wheel or disk is mounted

in gimbals so that the principal axis of rotation always passes through a fixed point (fig. 1). It can be made to imitate the motion of a spinning-top of which the point is placed in a smooth agate cup as in Maxwell's dynamical top (figs. 2, 3). (*Collected Works*, i. 248.) A bicycle wheel, with a prolongation of the axle placed in a cup, can also be made to serve (fig. 4).

The gyrostat is an instrument designed by Lord Kelvin (*Natural Philosophy*, § 345) to illustrate the more com-

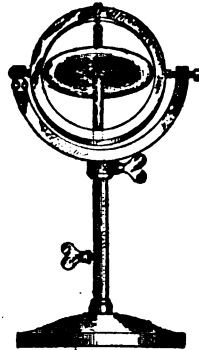

Fig. 1.

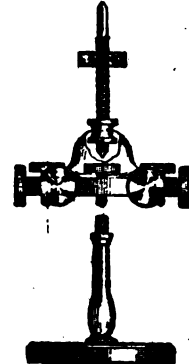

Fig. 2.

pllicated state of motion of a spinning body when free to wander about on a horizontal plane, like a top spun on the pavement, or a hoop or bicycle on the road. It consists essentially of a massive fly-wheel concealed in a metal casing, and its behaviour on a table, or with various modes of suspension or support, described in Thomson and Tait, *Natural Philosophy*, serves to illustrate the curious reversal of the ordinary laws of statical equilibrium due to the *gyrostatic domination* of the interior invisible fly-wheel, when rotated rapidly (fig. 5).

The toy shown in figs. 6 and 7, which can be bought for a shilling, is acting as a gyroscope in fig. 6 and a gyrostat in fig. 7.

The gyroscope, as represented in figs. 2 and 3 by Maxwell's dynamical top, is provided with screws by which the centre of gravity can be brought into coincidence with the point of support. It can

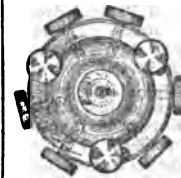

Fig. 3.

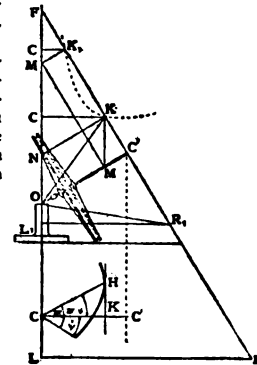

Fig. 4.

then be used to illustrate Poinso's theory of the motion of a body under no force, the gyroscope being made kinetically unsymmetrical by a setting of the screws. The discussion of this movement is required for Jacobi's theorems on the allied motion of a top and of a body under no force (Poinso, *Théorie nouvelle de la rotation des corps*, Paris, 1857; Jacobi, *Werke*, ii. Note B, p. 476).

To imitate the movement of the top the centre of gravity is displaced from the point of support so as to give a preponderance. When the motion takes place in the neighbourhood of the downward vertical, the bicycle wheel can be made to serve again

GYROSCOPE AND GYROSTAT

mounted as in fig. 8 by a stalk in the prolongation of the axle, suspended from a universal joint at O; it can then be spun by hand and projected in any manner.

The first practical application of the gyroscopic principle was invented and carried out (1744) by Serson, with a spinning top

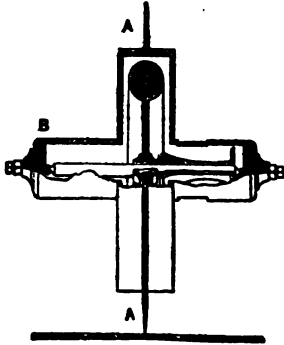

FIG. 5.



FIG. 6.



FIG. 7.

with a polished upper plane surface for giving an artificial horizon at sea, undisturbed by the motion of the ship, when the real horizon was obscured. The instrument has been perfected by Admiral Georges Ernest Fleurbaey (fig. 9), and is interesting

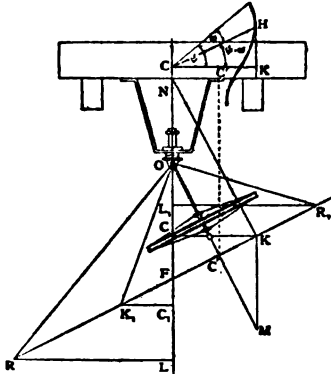

FIG. 8.

theoretically as showing the correction required practically for the rotation of the earth. Gilbert's barogyroscope is devised for the same purpose of showing the earth's rotation; a description of it, and of the latest form employed by Föppel, is given in the *Encyc. d. math. Wiss.*, 1904, with bibliographical references in the article "Mechanics of Physical Apparatus." The rotation of the fly-wheel is maintained here by an electric motor, as devised by G. M. Hopkins, and described in the *Scientific American*, 1878. To demonstrate the rotation of the earth by the constancy in direction of the axis of a gyroscope is a suggestion that has often been made; by E. Sang in 1836, and others. The experiment was first carried out with success by Foucault in 1851, by a simple pendulum swung in the dome of the Pantheon, Paris, and it has been repeated frequently (*Mémoires sur le pendule*, 1889).



FIG. 9.

A gyroscopic fly-wheel will preserve its original direction in space only when left absolutely free in all directions, as required in the experiments above. If employed in steering, as of a torpedo, the gyroscope must act through the intermediary of a light relay; but if direct-acting, the reaction will cause precession of the axis, and the original direction is lost.

The gyrostatic principle, in which one degree of freedom is suppressed in the axis, is useful for imparting steadiness and

stability in a moving body; it is employed by Schlick to mitigate the rolling of a ship and to maintain the upright position of Brennan's monorail car.

Lastly, as an application of gyroscopic theory, a stretched chain of fly-wheels in rotation was employed by Kelvin as a mechanical model of the rotary polarization of light in an electromagnetic field; the apparatus may be constructed of bicycle wheels connected by short links, and suspended vertically.

Theory of the Symmetrical Top.

1. The physical constants of a given symmetrical top, expressed in C.G.S. units, which are employed in the subsequent formulæ, are denoted by M, h, C and A . M is the weight in grammes (g) as given by the number of grammes weights which equilibrate the top when weighed in a balance; h is the distance OG in centimetres (cm.) between G the centre of gravity and O the point of support, and Mh may be called the preponderance in g.-cm.; Mh and M can be measured by a spring balance holding up in a horizontal position the axis OC in fig. 8 suspended at O . Then gMh (dyne-cm. or ergs) is the moment of gravity about O when the axis OC is horizontal, $gMh \sin \theta$ being the moment when the axis OC makes an angle θ with the vertical, and $g = 981$ (cm./s²) on the average; C is the moment of inertia of the top about OG , and A about any axis through O at right angles to OC , both measured in g.-cm.².

To measure A experimentally, swing the top freely about O in small plane oscillation, and determine the length, l cm., of the equivalent simple pendulum; then

$$(1) \quad l = A/Mh, \quad A = Mhl.$$

Next make the top, or this simple pendulum, perform small conical revolutions, nearly coincident with the downward vertical position of equilibrium, and measure s , the mean angular velocity of the conical pendulum in radians / second; and T its period in seconds; then

$$(2) \quad 4\pi^2/T^2 = \omega^2 = g/l = gMh/A;$$

and $f = \omega/2\pi$ is the number of revolutions per second, called the frequency, $T = 2\pi/f$ is the period of a revolution, in seconds.

2. In the popular explanation of the steady movement of the top at a constant inclination to the vertical, depending on the composition of angular velocity, such as given in Poynter's *Spinning Tops*, or Worthington's *Dynamics of Rotation*, it is asserted that the moment of gravity is always generating an angular velocity about an axis OB perpendicular to the vertical plane COC' through the axis of the top OC' ; and this angular velocity, compounded with the resultant angular velocity about an axis OI , nearly coincident with OC' , causes the axes OI and OC' to keep taking up a new position by moving at right angles to the plane COC' , at a constant precessional angular velocity, say μ rad./sec., round the vertical OC (fig. 4).

If, however, the axis OC' is prevented from taking up this precessional velocity, the top at once falls down; thence all the ingenious attempts—for instance, in the swinging cabin of the Bessemer ship—to utilize the gyroscope as a mechanical directive agency have always resulted in failure (*Engineer*, October 1874), unless restricted to actuate a light relay, which guides the mechanism, as in steering a torpedo.

An experimental verification can be carried out with the gyroscope in fig. 1; so long as the vertical spindle is free to rotate in its socket, the rapidly rotating wheel will resist the impulse of tapping on the gimbal by moving to one side; but when the pinch screw prevents the rotation of the vertical spindle in the massive pedestal, this resistance to the tapping at once disappears, provided the friction of the table prevents the movement of the pedestal; and if the wheel has any preponderance, it falls down.

Familiar instances of the same principles are observable in the movement of a hoop, or in the steering of a bicycle; it is essential that the handle of the bicycle should be free to rotate to secure the stability of the movement.

The bicycle wheel, employed as a spinning top, in fig. 4, can also be held by the stalk, and will thus, when rotated rapidly, convey a distinct muscular impression of resistance to change of direction, if brandished.

3. A demonstration, depending on the elementary principles of dynamics, of the exact conditions required for the steady movement of a spinning top to spin steadily at a constant inclination θ to the vertical OC , is given here before proceeding to the more complicated question of the general motion, when θ , the inclination of the axis, is varying of steady motion.

It is a fundamental principle in dynamics that if OH is a vector representing to scale the angular momentum of a system, and if Oh is the vector representing the axis of the impressed couple or torque, then OH will vary so that the velocity of H is represented to scale by the impressed couple Oh , and if the top is moving freely about O , Oh is at right angles to the vertical plane COC' , and

$$(1) \quad Oh = gMh \sin \theta.$$

In the case of the steady motion of the top, the vector OH lies in the vertical plane COC', in OK suppose (fig. 4), and has a component OC = G about the vertical and a component OC' = G', suppose, about the axis OC; and G' = CR, if R denotes the angular velocity of the top with which it is spun about OC.

If μ denotes the constant precessional angular velocity of the vertical plane COC', the components of angular velocity and momentum about OA are μ sin θ and Aμ sin θ, OA being perpendicular to OC' in the plane COC'; so that the vector OK has the components

(2) $OC' = G'$, and $C'K = Aμ \sin \theta$,

and the horizontal component

(3) $CK = OC' \sin \theta - C'K \cos \theta$
 $= G' \sin \theta - Aμ \sin \theta \cos \theta$.

The velocity of K being equal to the impressed couple Ok,

(4) $gMh \sin \theta = μ \cdot CK = \sin \theta (G'μ - Aμ^2 \cos \theta)$,

and dropping the factor sin θ,

(5) $Aμ^2 \cos \theta - G'μ + gMh = 0$, or $Aμ^2 \cos \theta - CRμ + Aμ^2 = 0$,

the condition for steady motion.

Solving this as a quadratic in μ, the roots μ₁, μ₂ are given by

(6) $μ_1, μ_2 = \frac{G'}{2A \cos \theta} \left[1 \pm \sqrt{1 - \frac{4A^2 \cos^2 \theta}{G'^2}} \right]$;

and the minimum value of G' = CR for real values of μ is given by

(7) $\frac{G'^2}{4A^2 \cos^2 \theta} = \cos \theta \cdot \frac{CR}{A} = 2\sqrt{(\cos \theta)}$;

for a smaller value of R the top cannot spin steadily at the inclination θ to the upward vertical.

Interpreted geometrically in fig. 4

(8) $μ = gMh \sin \theta / CK = Aμ^2 / KN$, and $μ = C'K / A \sin \theta = KM / A$,

(9) $KM \cdot KN = Aμ^2$,

so that K lies on a hyperbola with OC, OC' as asymptotes.

4. Suppose the top or gyroscope, instead of moving freely about the point O, is held in a ring or frame which is compelled to rotate about the vertical axis OC with constant angular velocity μ; then if N denotes the couple of reaction of the frame, keeping the top from falling, acting in the plane COC', equation (4) § 3 becomes modified into

(1) $gMh \sin \theta - N = μ \cdot CK = \sin \theta (G'μ - Aμ^2 \cos \theta)$,

(2) $N = \sin \theta (Aμ^2 \cos \theta - G'μ + gMh)$
 $= A \sin \theta \cos \theta (\mu - \mu_1)(\mu - \mu_2)$;

and hence, as μ increases through μ₁ and μ₂, the sign of N can be determined, positive or negative, according as the tendency of the axis is to fall or rise.

When G' = CR is large, μ₂ is large, and

(3) $μ \approx gMh / C' = Aμ^2 / CR$,

the same for all inclinations, and this is the precession observed in the spinning top and centrifugal machine of fig. 10. This is true accurately when the axis OC' is horizontal, and then it agrees with the result of the popular explanation of § 2.

If the axis of the top OC' is pointing upward, the precession is in the same direction as the rotation, and an increase of μ makes N negative, and the top rises; conversely a decrease of the precession μ causes the axis to fall (Perry, *Spinning Tops*, p. 48).

If the axis points downward, as in the centrifugal machine with upper support, the precession is in the opposite direction to the rotation, and to make the axis approach the vertical position the precession must be reduced.

This is effected automatically in the Weston centrifugal machine (fig. 10) used for the separation of water and molasses, by the friction of the indiarubber cushions above the support; or else the spindle is produced downwards below the drum a short distance, and turns in a hole in a weight resting on the bottom of the case, which weight is dragged round until the spindle is upright; this second arrangement is more effective when a liquid is treated in the drum, and wave action is set up (*The Centrifugal Machine*, C. A. Matthey).

Similar considerations apply to the stability of the whirling bowl in a cream-separating machine.

We can write equation (1)

(4) $N = (Aμ^2 \sin \theta - μ \cdot CK) = (Aμ^2 - KM \cdot KN) \sin \theta / A$,

so that N is negative or positive, and the axis tends to rise or fall according as K moves to the inside or outside of the hyperbola of free motion. Thus a tap on the axis tending to hurry the precession is

equivalent to an impulse couple giving an increase to C'K, and will make K move to the interior of the hyperbola and cause the axis to rise; the steering of a bicycle may be explained in this way; but K₁ will move to the exterior of the hyperbola, and so the axis will fall in this second more violent motion.

Friction on the point of the top may be supposed to act like a tap in the direction opposite to the precession; and so the axis of a top spun violently rises at first and up to the vertical position, but falls away again as the motion dies out. Friction considered as acting in regarding the rotation may be compared to an impulse couple tending to reduce OC', and so make K and K₁ both move to the exterior of the hyperbola, and the axis falls in both cases. The axis may rise or fall according to the direction of the frictional couple, depending on the shape of the point; an analytical treatment of the varying motion is very intractable; a memoir by E. G. Gallop may be consulted in the *Trans. Camb. Phil. Soc.*, 1903.

The earth behaves in precession like a large spinning top, of which the axis describes a circle round the pole of the ecliptic of mean angular radius θ, about 23½°, in a period of 26,000 years, so that R/μ = 26000 × 365;

(5) $CRμ \sin \theta = CR^2 \sin 23\frac{1}{2}^\circ / 26000 \times 365$,

one 12 millionth part of ¼ CR², the rotation energy of the earth.

5. If the precession is absent, by making the C.G coincide with O, and if Aμ is inessential compared with G',

(1) $N = -G'μ \sin \theta$,

the formula which suffices to explain most gyroscopic action.

Thus a carriage running round a curve experiences, in consequence of the rotation of the wheels, an increase of pressure Z on the outer track, and a diminution Z on the inner, giving a couple, if a is the gauge,

(2) $Za = G'μ$,

tending to help the centrifugal force to upset the train; and if c is the radius of the curve, b of the wheels, C their moment of inertia, and v the velocity of the train,

(3) $μ = v/c$, $G' = C/b$,

(4) $Z = C^2 abc(dynes)$,

so that Z is the fraction C/Mab of the centrifugal force Mv²/c, or the fraction C/Mh of its transference of weight, with h the height of the centre of gravity of the carriage above the road. A Brennan carriage on a monorail would lean over to the inside of the curve at an angle α, given by

(5) $\tan \alpha = G'μ/gMh = G'/gMhc$.

The gyroscopic action of a dynamo, turbine, and other rotating machinery on a steamer, paddle or screw, due to its rolling and pitching, can be evaluated in a similar elementary manner (Worthington, *Dynamics of Rotation*), and Schlick's gyroscopic apparatus is intended to mitigate the oscillation.

6. If the axis OC in fig. 4 is inclined at an angle α to the vertical, the equation (2) § 4 becomes

(1) $N = \sin \theta (Aμ^2 \cos \theta - G'μ) + gMh \sin (\alpha - \theta)$.

Suppose, for instance, that OC is parallel to the earth's axis, and that the frame is fixed in the meridian; then α is the co-latitude, and μ is the angular velocity of the earth, the square of which may be neglected; so that, putting N = 0, α = θ = E,

(2) $gMh \sin E - G'μ \sin (\alpha - E) = 0$,

(3) $\tan E = \frac{G'μ \sin \alpha}{gMh + G'μ \cos \alpha} \approx \frac{G'μ}{gMh} \sin \alpha$.

This is the theory of Gilbert's barogyroscope, described in Appell's *Mécanique rationnelle*, ii. 387: it consists essentially of a rapidly rotated fly-wheel, mounted on knife-edges by an axis perpendicular to its axis of rotation and pointing east and west; spun with considerable angular momentum G', and provided with a slight precession μh, it should tilt to an angle E with the vertical, and thus demonstrate experimentally the rotation of the earth.

In Foucault's gyroscope (*Comptes rendus*, 1852; Perry, p. 105) the precession is made zero, and the axis points to Foucault's pole, when free to move in the meridian.

Generally, if constrained to move in any other plane, the axis seeks the position nearest to the polar axis, like a dipping needle with respect to the magnetic pole. (*A systematic working model of the magnetic compass*, by Sir W. Thomson, British Association Report, Montreal, 1884. A. S. Chessin, St Louis Academy of Science, January 1902.)

A spinning top with a polished upper plane surface will provide an artificial horizon at sea, when the real horizon is obscured. The first instrument of this kind was constructed by Seron, and is described in the *Gentleman's Magazine*, *Gyroscopic* vol. xxiv., 1754; also by Segner in his *Specimen theoriae turbinum* (Hale, 1755). The inventor was sent to sea by the Admiralty to test his instrument, but he was lost in the wreck of the "Victory," 1744. A copy of the Seron top, from the royal collection, is now in the Museum of King's College, London. Troughton's Nautical Top (1819) is intended for the same purpose. The instrument is in favour with French navigators, perfected by

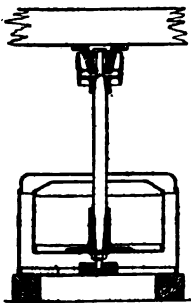

FIG. 10.

Gyroscopic action of railway wheels.

Constrained motion of the gyroscope.

Centrifugal machine.

The barogyroscope.

Admiral Fleuriais (fig. 9); but it must be noticed that the horizon given by the top is inclined to the true horizon at the angle E given by equation (3) above; and if μ_1 is the precessional angular velocity as given by (3) § 4, and $T = 2\pi/\mu_1$, its period in seconds,

$$(4) \quad \tan E = \frac{\mu \cos \text{lat}}{\mu_1} = \frac{T \cos \text{lat}}{86400}, \text{ or } E = \frac{T \cos \text{lat}}{8\pi}$$

If E is expressed in minutes, taking $\mu = 2\pi/86400$; thus making the true latitude E nautical miles to the south of that given by the top (*Revue maritime*, 1890; *Comptes rendus*, 1896).

This can be seen by elementary consideration of the theory above, for the velocity of the vector OC' of the top due to the rotation of the earth is

$$(5) \quad \mu \cdot OC' \cos \text{lat} = gMh \sin E = \mu_1 \cdot OC' \sin E, \\ \sin E = \frac{\mu \cos \text{lat}}{\mu_1}, \text{ or } E = \frac{T \cos \text{lat}}{8\pi}$$

in which 8π can be replaced by 25 , in practice; so that the Fleuriais gyroscopic horizon is an illustration of the influence of the rotation of the earth and of the need for its allowance.

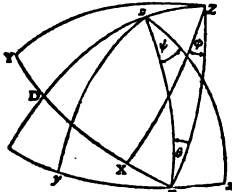

FIG. 11.

ϕ, ψ , such that the successive turning of the axes Ox, Oy, Oz through the angles (i.) ψ about Oz, (ii.) θ about Oe, (iii.) ϕ about OZ, brings them into coincidence with OX, OY, OZ, as shown in fig. 11, representing the concave side of a spherical surface. The component angular velocities about OD, OE, OZ are

$$(1) \quad \psi \sin \theta, \theta, \phi + \psi \cos \theta; \\ \text{so that, denoting the components about OX, OY, OZ by P, Q, R,} \\ (2) \quad P = \theta \cos \phi + \psi \sin \theta \sin \phi, \\ Q = -\theta \sin \phi + \psi \sin \theta \cos \phi, \\ R = \phi + \psi \cos \theta.$$

Consider, for instance, the motion of a fly-wheel of preponderance Mh , and equatorial moment of inertia A , of which the axis OC is held in a light ring ZCX at a constant angle γ with OZ, while OZ is held by another ring zZ, which constrains it to move round the vertical Oz at a constant inclination θ with constant angular velocity μ , so that

$$(3) \quad P = \mu \sin \theta \sin \phi, \quad Q = \mu \sin \theta \cos \phi, \quad R = \phi + \mu \cos \theta.$$

With CXF a quadrant, the components of angular velocity and momentum about OF, OY, are

$$(4) \quad P \cos \gamma - R \sin \gamma, \quad Q, \quad \text{and } A(P \cos \gamma - R \sin \gamma), \quad A Q, \\ \text{so that, denoting the components of angular momentum of the fly-wheel about OC, OX, OY, OZ by } K \text{ or } G', \quad h_1, \quad h_2, \quad h_3, \\ (5) \quad h_1 = A(P \cos \gamma - R \sin \gamma) \cos \gamma + K \sin \gamma, \\ (6) \quad h_2 = A Q, \\ (7) \quad h_3 = -A(P \cos \gamma - R \sin \gamma) \sin \gamma + K \cos \gamma; \\ \text{and the dynamical equation}$$

$$(8) \quad \frac{dh_1}{dt} - h_2 Q + h_3 P = N,$$

with K constant, and with preponderance downward

$$(9) \quad N = gMh \cos \gamma Y \sin \gamma - gMh \sin \gamma \sin \theta \cos \phi, \\ (10) \quad \frac{d^2 \phi}{dt^2} \sin \gamma + A \mu^2 \sin \gamma \sin^2 \theta \sin \phi \cos \phi \\ + A \mu^2 \cos \gamma \sin \theta \cos \theta \cos \phi - (K \mu + gMh) \sin \theta \cos \phi = 0.$$

The position of relative equilibrium is given by

$$(11) \quad \cos \phi = 0, \text{ and } \sin \phi = \frac{K \mu + gMh}{A \mu^2 \sin \gamma \sin \theta}.$$

For small values of μ the equation becomes

$$(12) \quad \frac{d^2 \phi}{dt^2} \sin \gamma - (K \mu + gMh) \sin \theta \cos \phi = 0,$$

so that $\phi = \frac{1}{2}\pi$ gives the position of stable equilibrium, and the period of a small oscillation is $2\pi\sqrt{A \sin \gamma / (K \mu + gMh) \sin \theta}$.

In the general case, denoting the periods of vibration about $\phi = \frac{1}{2}\pi, -\frac{1}{2}\pi$, and the sidelong position of equilibrium by $2\pi/(\omega_1, \omega_2 \text{ or } \omega_3)$, we shall find

$$(13) \quad \omega_1^2 = \frac{\sin \theta}{A \sin \gamma} [gMh + K \mu - A \mu^2 \cos(\gamma - \theta)],$$

$$(14) \quad \omega_2^2 = \frac{\sin \theta}{A \sin \gamma} [-gMh - K \mu + A \mu^2 \cos(\gamma + \theta)],$$

$$(15) \quad \omega_3 = \omega_1 \omega_2 / \mu \sin \theta.$$

The first integral of (11) gives

$$(16) \quad \frac{1}{2} A \left(\frac{d\phi}{dt} \right)^2 \sin \gamma + \frac{1}{2} A \mu^2 \sin \gamma \sin^2 \theta \sin^2 \phi$$

$- A \mu^2 \cos \gamma \sin \theta \cos \theta \sin \phi + (K \mu + gMh) \sin \theta \sin \phi - H = 0,$ and putting $\tan(\frac{1}{2}\pi + \frac{1}{2}\phi) = s$, this reduces to

$$(17) \quad \frac{ds}{dt} = \pi\sqrt{Z}$$

where Z is a quadratic in s^2 , so that s is a Jacobian elliptic function of t , and we have

$\tan(\frac{1}{2}\pi + \frac{1}{2}\phi) = C(\text{tn}, \text{dn}, \text{nc}, \text{ or } \text{cn})/n$, according as the ring ZC performs complete revolutions, or oscillates about a sidelong position of equilibrium, or oscillates about the stable position of equilibrium $\phi = \frac{1}{2}\pi$.

Suppose Oz is parallel to the earth's axis, and μ is the diurnal rotation, the square of which may be neglected, then if Gilbert's barogyroscope of § 6 has the knife-edges turned in azimuth to make an angle β with E, and W., so that OZ lies in the horizon at an angle E.B.N., we must put $\gamma = \frac{1}{2}\pi$, $\cos \theta = \sin \alpha \sin \beta$; and putting $\phi = \frac{1}{2}\pi - \delta + E$, where δ denotes the angle between Zs and the vertical plane ZT through the zenith δ ,

(18) $\sin \theta \cos \delta = \cos \alpha$, $\sin \theta \sin \delta = \sin \alpha \cos \beta$; so that equations (9) and (10) for relative equilibrium reduce to

$$(19) \quad gMh \sin E = KQ = K \mu \sin \theta \cos \phi = K \mu \sin \theta \sin(\delta - E),$$

and will change (3) § 6 into

$$(20) \quad \tan E = \frac{K \mu \sin \alpha \cos \beta}{gMh + K \mu \cos \alpha}$$

a multiplication of (3) § 6 by $\cos \beta$ (Gilbert, *Comptes rendus*, 1882). Changing the sign of K or h and E and denoting the revolutions/second of the gyroscope wheel by F, then in the preceding notation, T denoting the period of vibration as a simple pendulum,

$$(21) \quad \tan E = \frac{K \mu \sin \alpha \cos \beta}{gMh - K \mu \cos \alpha} = \frac{F \sin \alpha \cos \beta}{86400 A/T^2 C - F \cos \alpha}$$

so that the gyroscope would reverse if it were possible to make $F \cos \alpha > 86400 A/T^2 C$ (Föppl, *Mösch. Ber.*, 1904). A gyroscope pendulum is made by the addition to it of a fly-wheel, balanced and mounted, as in Gilbert's barogyroscope, is a ring movable about an axis fixed in the pendulum, in the vertical plane of motion.

As the pendulum falls away to an angle θ with the upward vertical, and the axis of the fly-wheel makes an angle ϕ with the vertical plane of motion, the three components of angular momentum are

$$(22) \quad h_1 = K \cos \phi, \quad h_2 = A\theta + K \sin \phi, \quad h_3 = A\phi,$$

where h_1 is the component about the axis of the ring and K of the fly-wheel about its axis; and if L, M', N denote the components of the couple of reaction of the ring, L may be ignored, while N is zero, with $P = 0, Q = \theta, R = 0$, so that

$$(23) \quad M' = h_2, \quad N = A\theta + K\phi \cos \phi,$$

$$(24) \quad 0 = h_1 - h_2 \theta = A\phi - K\theta \cos \phi.$$

For the motion of the pendulum, including the fly-wheel,

$$(25) \quad MK\dot{\psi} = gMH \sin \theta - M' \\ = gMH \sin \theta - A\dot{\theta} - K\dot{\phi} \cos \phi.$$

If θ and ϕ remain small,

$$(26) \quad A\dot{\theta} = K\dot{\phi}, \quad A\dot{\phi} = K(\theta - \alpha),$$

$$(27) \quad (MK^2 + A)\dot{\theta} + (K^2/A)(\theta - \alpha) - gMH\theta = 0;$$

so that the upright position will be stable if $K^2 > gMHA$, or the rotation energy of the wheel greater than $1/2A/C$ times the energy acquired by the pendulum in falling between the vertical and horizontal position; and the vibration will synchronize with a simple pendulum of length

$$(28) \quad (MK^2 + A)/(K^2/gA - MH).$$

This gyroscopic pendulum may be supposed to represent a ship among waves, or a carriage on a monorail, and so affords an explanation of the gyroscopic action essential in the apparatus of Schlich and Brennan.

8. Careful scrutiny shows that the steady motion of a top is not steady absolutely; it reveals a small nutation superposed, so that a complete investigation requires *General methods* of a return to the equations of unsteady motion, and for the *the top* small oscillation to consider them in a penultimate form.

In the general motion of the top the vector OH of resultant angular momentum is no longer compelled to lie in the vertical plane COC' (fig. 4), but since the axis Oh of the gravity couple is always horizontal, H will describe a curve in a fixed horizontal plane through C. The vector OC' of angular momentum about the axis will be constant in length, but vary in direction; and OK will be the component angular momentum in the vertical plane COC', if the planes through C and C' perpendicular to the lines OC and OC' intersect in the line KH; and if KH is the component angular momentum perpendicular to the plane COC', the resultant angular momentum OH has the three components OC', C'K, KH, represented in Euler's angles by

$$(1) \quad KH = A\dot{\theta}/dt, \quad C'K = A \sin \theta \dot{\phi}/dt, \quad OC' = C'.$$

Drawing KM vertical and KN parallel to OC', then

$$(2) \quad KM = A\dot{\theta}/dt, \quad KN = CR - A \cos \theta \dot{\phi}/dt = (C - A)R + A\dot{\phi}/dt$$

so that in the spherical top, with $C = A$, $KN = A\dot{\phi}/dt$.

The velocity of H is in the direction KH perpendicular to the plane COC', and equal to gMA sin theta or A n^2 sin theta, so that if a point in the axis OC' at a distance A n^2 from O is projected on the horizontal plane through C in the point P on CK, the curve described by P, turned forwards through a right angle, will be the hodograph of H; this is expressed by

(3) A n^2 sin theta d(theta + phi) = i A n^2 sin theta d(phi) = d(rho e^i)

where rho e^i is the vector CH; and so the curve described by P and the motion of the axis of the top is derived from the curve described by H by a differentiation.

Resolving the velocity of H in the direction CH,

(4) d(CH)/dt = A n^2 sin theta sin KCH = A n^2 sin theta KH/CH, (5) d(CH^2)/dt = A n^2 sin theta d(theta)/dt.

and integrating

(6) CH^2 = A^2 n^4 (E - cos theta), (7) OH^2 = A^2 n^4 (F - cos theta), (8) C'H^2 = A^2 n^4 (D - cos theta)

where D, E, F are constants, connected by

(9) F = E + G^2/2A^2 n^2 = D + G^2/2A^2 n^2.

Then

(10) KH^2 = OH^2 - OK^2, (11) OK^2 sin^2 theta = CC'^2 = G^2 - 2GG' cos theta + G'^2, (12) A^2 n^2 theta (d theta/dt)^2 = 2A^2 n^2 (F - cos theta) sin^2 theta - G^2 + 2GG' cos theta - G'^2; and putting cos theta = z,

(13) (dz/dt)^2 = 2n^2 (F - z) (1 - z^2) - (G^2 - 2GG'z + G'^2)/A^2 = 2n^2 (E - z) (1 - z^2) - (G' - Gz)^2/A^2 = 2n^2 (D - z) (1 - z^2) - (G - G'z)^2/A^2 = 2n^2 Z suppose.

Denoting the roots of Z = 0 by z1, z2, z3, we shall have them arranged in the order

(14) z1 > 1 > z2 > z3 > -1, (15) (dz/dt)^2 = 2n^2 (z1 - z) (z2 - z) (z - z3),

(16) dt = integral from z1 to z of dz / sqrt(Z),

an elliptic integral of the first kind, which with

(17) m = pi * sqrt((z1 - z2) / (z1 - z3)), z^2 = (z1 - z2) / (z1 - z3),

can be expressed, when normalized by the factor sqrt((z1 - z2)/2), by the inverse elliptic function in the form

(18) mt = integral from z1 to z of sqrt((z1 - z2) ds) / (z1 - z2) sqrt(4(z1 - s)(s - z2)) = sn^-1 sqrt((z1 - z2) / (z1 - z3)) cn^-1 sqrt((z1 - z) / (z1 - z3)) dn^-1 sqrt((z1 - z) / (z1 - z3)) (19) s - z1 = (z1 - z2) sn^2 mt, z2 - s = (z1 - z2) cn^2 mt, z1 - z = (z1 - z2) dn^2 mt

(20) z = z1 sn^2 mt + z2 cn^2 mt.

Interpreted dynamically, the axis of the top keeps time with the beats of a simple pendulum of length

(21) L = l / (1 - z1(z1 - z2)),

suspended from a point at a height 1/2(z1 + z2) above O, in such a manner that a point on the pedulum at a distance

(22) 1/2(z1 - z2) l = D/L

from the point of suspension moves so as to be always at the same level as the centre of oscillation of the top.

The polar co-ordinates of H are denoted by rho, phi in the horizontal plane through C; and, resolving the velocity of H perpendicular to CH,

(23) rho d(phi)/dt = A n^2 sin theta cos KCH.

(24) rho^2 d(phi)/dt = A n^2 sin theta CK = A n^2 (G' - G cos theta)

(25) phi = integral from G' - Gz to G' - Gz/A of (G' - Gz)/2A n dz / sqrt(Z)

an elliptic integral, of the third kind, with pole at z = E; and then

(26) -psi = KCH = tan^-1 KH/CH = tan^-1 A sin theta d(theta)/dt / (G' - G cos theta) = tan^-1 sqrt(Z) / (G' - Gz)/A n^2

which determines psi.

Otherwise, from the geometry of fig. 4,

(27) C'K sin phi = OC - OC' cos theta,

(28) A sin^2 theta d(phi)/dt = G - G' cos theta,

(29) phi = integral from G - G'z to G - G'z/A of (G - G'z) dz / (1 - z^2) A = integral from G - G'z to G - G'z/A of (G + G'z) dz / (1 + z^2) A

the sum of two elliptic integrals of the third kind, with pole at z = +/- 1; and the relation in (25) (26) shows the addition of these two integrals into a single integral, with pole at z = E.

The motion of a sphere, rolling and spinning in the interior of a spherical bowl, or on the top of a sphere, is found to be of the same character as the motion of the axis of a spinning top about a fixed point.

The curve described by H can be identified as a Poincaré herpolhode, that is, the curve traced out by rolling a quadric surface with centre fixed at O on the horizontal plane through C; and Darboux has shown also that a deformable hyperboloid made of the generating lines, with O and H at opposite ends of a diameter and one generator fixed in OC, can be moved so as to describe the curve H; the tangent plane of the hyperboloid at H being normal to the curve of H; and then the other generator through O will coincide in the movement with OC', the axis of the top; thus the Poincaré herpolhode curve H is also the trace made by rolling a line of curvature on an ellipsoid confocal to the hyperboloid of one sheet, on the plane through C.

Kirchhoff's Kinetic Analogue asserts also that the curve of H is the projection of a tortuous elastica, and that the spherical curve of C' is a hodograph of the elastica described with constant velocity.

Writing the equation of the focal ellipse of the Darboux hyperboloid through H, enlarged to double scale so that O is the centre,

(30) x^2/a^2 + y^2/b^2 + z^2/c^2 = 1,

with a^2 + lambda, b^2 + lambda, lambda denoting the squares of the semiaxes of a confocal ellipsoid, and lambda changed into mu and nu for a confocal hyperboloid of one sheet and of two sheets.

(31) lambda > 0 > mu > -b^2 > nu > -a^2,

then in the deformation of the hyperboloid, lambda and nu remain constant at H; and utilizing the theorems of solid geometry on confocal quadrics, the magnitudes may be chosen so that

(32) a^2 + lambda + b^2 + mu + nu = OH^2 = 1/2 b^2 (F - z) = rho^2 + OC'^2,

(33) a^2 + mu = 1/2 b^2 (z1 - z) = rho^2 - rho'^2,

(34) b^2 + mu = 1/2 b^2 (z2 - z) = rho^2 - rho''^2,

(35) mu = 1/2 b^2 (z3 - z) = rho^2 - rho'''^2,

(36) rho'''^2 < 0 < rho''^2 < rho^2 < rho'^2,

(37) F = z1 + z2 + z3,

(38) lambda - 2mu + nu = k^2 z, lambda - nu = k^2,

(39) lambda - mu = (1 + z) / (lambda - z), mu - nu = (1 - z) / (lambda - z)

with z = cos theta, theta denoting the angle between the generating lines through H; and with OC = s, OC' = s', the length k has been chosen so that in the preceding equations

(40) s/k = G/2A n, s'/k = G'/2A n;

and s, s', k may replace G, G', 2A n; then

(41) dz / (1 - z^2) = (1/d phi) (d phi) = 4KH^2 / k^2,

while from (33-39)

(42) dz / (1 - z^2) = 4(a^2 + mu) (b^2 + mu) mu / (k^2 (mu - lambda) (mu - nu))

which verifies that KH is the perpendicular from O on the tangent plane of the hyperboloid at H, and so proves Darboux's theorem.

Planes through O perpendicular to the generating lines cut off a constant length HQ = s, HQ' = s', so the line of curvature described by H in the deformation of the hyperboloid, the intersection of the fixed confocal ellipsoid lambda and hyperboloid of two sheets nu, rolls on a horizontal plane through C and at the same time on a plane through C' perpendicular to OC'.

Produce the generating line HQ to meet the principal planes of the confocal system in V, T, P; these will also be fixed points on the generator; and putting

(43) (HV, HT, HP) / HQ = D / (A, B, C),

then

(44) Ax^2 + By^2 + Cz^2 = D rho^2

is a quadric surface with the squares of the semiaxes given by HV, HQ, HT, HQ, and with HQ the normal line at H, and so touching the horizontal plane through C; and the direction cosines of the normal being

(45) x/HV, y/HT, z/HP,

(46) A^2 x^2 + B^2 y^2 + C^2 z^2 = D^2 rho^2,

the line of curvature, called the polhode curve by Poincaré, being the intersection of the quadric surface (44) with the ellipsoid (46).

There is a second surface associated with (44), which rolls on the plane through C', corresponding to the other generating line HQ' through H, so that the same line of curvature rolls on two planes at a constant distance from O, s and s'; and the motion of the top is made up of the combination. This completes the statement of Jacobi's theorem (Werke, ii. 480) that the motion of a top can be resolved into two movements of a body under no force.

Conversely, starting with Poincaré's polhode and herpolhode given in (44) (46), the normal plane is drawn at H, cutting the principal axes of the rolling quadric in X, Y, Z; and then

(47) a^2 + mu = z.OX, b^2 + mu = y.OY, mu = s.OZ,

this determines the deformable hyperboloid of which one generator through H is a normal to the plane through C; and the other generator is inclined at an angle phi, the inclination of the axis of the top, while the normal plane or the parallel plane through O revolves with angular velocity d(phi)/dt.

The curvature is useful in drawing a curve of H; the diameter of curvature D is given by

GYROSCOPE AND GYROSTAT

$$(48) \quad D = \frac{d\psi}{d\theta} = \frac{1}{2} \frac{h^2 \sin^2 \theta}{h - \beta \cos \theta} \frac{d\theta}{d\psi} = \frac{h^2}{KM \cdot KN}$$

The curvature is zero and H passes through a point of inflexion when C' comes into the horizontal plane through C; ψ will then be stationary and the curve described by C' will be looped.

In a state of steady motion, ψ oscillates between two limits s_2 and s_1 which are close together, so putting $s_2 = s_1$, the coefficient of s in Z is

$$(49) \quad 2s_1 s_2 + s_2^2 = -1 + \frac{GG'}{A^2 n^2} = -1 + \frac{(OM \cos \theta + ON)(OM + ON \cos \theta)}{OM \cdot ON}$$

$$(50) \quad 2s_1 s_2 = \frac{OM^2 + ON^2}{OM \cdot ON} \cos \theta, \quad s_1 = \frac{OM^2 + ON^2}{2OM \cdot ON}$$

$$(51) \quad 2(s_1 - s_2) = \frac{OM^2 - 2OM \cdot ON \cos \theta + ON^2}{OM \cdot ON} = \frac{MN^2}{OM \cdot ON}$$

With $s_2 = s_1, \kappa = 0, K = \frac{1}{2}\pi$; and the number of beats per second of the axis is

$$(52) \quad \frac{m}{\tau} = \frac{n}{\pi} \sqrt{\frac{s_1 - s_2}{2}} = \frac{MN}{\sqrt{(OM \cdot ON)}} \frac{n}{2\pi}$$

beating time with a pendulum of length

$$(53) \quad L = \frac{l}{\sqrt{(s_1 - s_2)}} = \frac{4OM \cdot ON}{MN^2} l$$

The wheel making $R/2\pi$ revolutions per second,

$$(54) \quad \frac{\text{beats/second}}{\text{revolutions/second}} = \frac{MN}{\sqrt{(OM \cdot ON)}} \frac{n}{\pi} = \frac{C}{A} \frac{MN}{OC^2}$$

from (8) (9) § 3; and the apsidal angle is

$$(55) \quad \mu \frac{1}{m} = \frac{A\mu}{An} \frac{n}{m} \frac{1}{\pi} = \frac{ON}{\sqrt{(OM \cdot ON)}} \frac{2\sqrt{(OM \cdot ON)}}{MN} \cdot \frac{1}{2}\pi = \frac{ON}{MN^2}$$

and the height of the equivalent conical pendulum λ is given by

$$(56) \quad \frac{\lambda}{l} = \frac{h^2}{h^2} \frac{n^2}{m^2} \frac{OM}{n} = \frac{KC}{KC} = \frac{OL}{OC^2}$$

if OR drawn at right angles to OK cuts KC' in R, and RL is drawn horizontal to cut the vertical CO in L; thus if OC' represents l to scale, then OL will represent λ .

9. The gyroscope motion in fig. 4 comes to a stop when the rim of the wheel touches the ground; and to realize the motion when the axis is inclined at a greater angle with the upward vertical, the stalk is pivoted in fig. 8 in a lug screwed to the axle of a bicycle hub, fastened vertically in a bracket bolted to a beam. The wheel can now be spun by hand, and projected in any manner so as to produce a desired gyroscopic motion, undulating, looped, or with cusps if the stalk of the wheel is dropped from rest.

As the principal part of the motion takes place now in the neighbourhood of the lowest position, it is convenient to measure the angle θ from the downward vertical, and to change the sign of τ and G.

Equation (18) § 8 must be changed to

$$(1) \quad m\dot{t} = m\dot{s} \sqrt{\frac{s_2 - s}{2}} = \int_{s_2}^s \frac{\sqrt{(s_2 - s) ds}}{\sqrt{(4Z)}}$$

$$(2) \quad Z = (s - F)(1 - s^2) - (G^2 - 2GG's + G^2)/2A^2 n^2 \\ = (s - D)(1 - s^2) - (G - G's)^2/2A^2 n^2 \\ = (s - E)(1 - s^2) - (G' - Gs)^2/2A^2 n^2 \\ = (s_1 - s)(s - s_2)(s - s_3)$$

$$(3) \quad 1 > s_1 > s > s_2 > -1, D, E > s_1 \\ (4) \quad s_1 + s_2 + s_3 = F = D - G^2/2A^2 n^2 = E - G'^2/2A^2 n^2$$

and expressed by the inverse elliptic function

$$(5) \quad m\dot{t} = sn^{-1} \sqrt{\frac{s_2 - s}{s_1 - s_2}} = cn^{-1} \sqrt{\frac{s - s_2}{s_1 - s_2}} = dn^{-1} \sqrt{\frac{s - s_1}{s_1 - s_1}}$$

$$(6) \quad s = s_2 sn^2 m\dot{t} + s_1 cn^2 m\dot{t}, \quad s^2 = (s_1 - s_2) / (s_1 - s_2)$$

Equation (25) and (29) § 8 is changed to

$$(7) \quad \varpi = \frac{1}{2} \int \frac{G - G's}{s - E} \frac{ds}{A} = \frac{1}{2} \int \frac{G' - GE}{s - E} \frac{ds}{A} - \frac{G}{2A}$$

$$(8) \quad \psi = \int \frac{G's - G}{1 - s^2} \frac{ds}{A} = \frac{1}{2} \int \frac{G' + G}{1 - s^2} \frac{ds}{A} - \frac{1}{2} \int \frac{G' - G}{1 + s^2} \frac{ds}{A}$$

while ψ and ϖ change places in (26).

The Jacobian elliptic parameter of the third elliptic integral in (7) can be given by v , where

$$(9) \quad v = \int_{E'}^s \frac{(s_1 - s) ds}{E \sqrt{(4Z)}} = \int_{s_1}^s + \int_{s_2}^s = K + (1 - f)K',$$

where f is a real fraction,

$$(10) \quad (1 - f)K' = \int_{E'}^s \frac{(s_1 - s) ds}{E \sqrt{(4Z)}}$$

$$(11) \quad fK' = \int_{s_1}^E \frac{(s_1 - s) ds}{s_1 \sqrt{(4Z)}} \\ = sn^{-1} \sqrt{\frac{E - s_1}{s_1 - s_1}} = cn^{-1} \sqrt{\frac{s_1 - E}{s_1 - s_1}} = dn^{-1} \sqrt{\frac{s_1 - E}{s_1 - s_1}}$$

with respect to the modulus κ' .

Then, with $s = E$, and

$$(12) \quad 2Z_E = -(G' - GE)/An^2$$

if II denotes the apsidal angle of ϖ , and T the time of a single beat of the axis, up or down,

$$(13) \quad \text{II} + \frac{GT}{2A} = \int_{s_2}^s \frac{\sqrt{(s_1 - s) ds}}{s - E \sqrt{(4Z)}} \\ = \frac{1}{2} \pi f + Ksn/K'$$

in accordance with the theory of the complete elliptic integral of the third kind.

Interpreted geometrically on the deformable hyperboloid, flattened in the plane of the focal ellipse, if OQ is the perpendicular from the centre on the tangent HP, $AQ = am/fK'$, and the eccentric angle of P, measured from the minor axis, is $am(1-f)K'$, the eccentricity of the focal ellipse being the modulus κ' .

A point L is taken in QP such that

$$(14) \quad QL/OA = zn/fK',$$

$$(15) \quad QV, QT, QP = OA(zs, zc, zd)/fK';$$

and with

$$(16) \quad mT = K, \quad m/n = \sqrt{(s_1 - s_2)}/2 = OA/k,$$

$$(17) \quad \frac{GT}{2A} = \frac{G}{2An} \frac{k}{OA} K = \frac{OH}{OA} K,$$

$$(18) \quad \text{II} = \frac{1}{2} \pi f + \frac{OL + OH}{OA} K = \frac{1}{2} \pi f + \frac{HL}{OA} K.$$

By choosing for f a simple rational fraction, such as $\frac{1}{2}, \frac{1}{3}, \frac{1}{4}, \frac{1}{5}$, an algebraical case of motion can be constructed (*Annals of Mathematics*, 1904).

Thus with $G' - GE = 0$, we have $E = s_1$ or s_2 , never s_3 ; $f = 0$ or 1 ; and P is at A or B on the focal ellipse; and then

$$(19) \quad \varpi = -pt, \quad p = G/2A,$$

$$(20) \quad \psi + pt = \tan^{-1} \frac{n\sqrt{(2Z)}}{2p(s - E)},$$

$$(21) \quad \sin \theta \exp(\psi + pt) = i\sqrt{(s_1 - s_2)(s - s_1)} + \sqrt{(s_1 - s)(s - s_2)}, \\ s_1 = \frac{1 + 2s_2}{s_1 + s_2}, \quad \sqrt{\frac{s_1 - s_2}{2}} = \frac{G}{2An}, \quad \frac{p}{n} = \frac{G'}{2An}, \text{ or}$$

$$(22) \quad \sin \theta \exp(\psi + pt) = i\sqrt{(s_1 - s_2)(s - s_1)} + \sqrt{(s_1 - s)(s - s_2)}, \\ s_2 = \frac{1 + 2s_1}{s_1 + s_2}, \quad \sqrt{\frac{s_1 - s_2}{2}} = \frac{G}{2An}, \quad \frac{p}{n} = \frac{G'}{2An}$$

Thus $s_2 = 0$ in (22) makes $G' = 0$; so that if the stalk is held out horizontally and projected with angular velocity $2p$ about the vertical axis OC without giving any spin to the wheel, the resulting motion of the stalk is like that of a spherical pendulum, and given by

$$(23) \quad \sin \theta \exp(\psi + pt) = i\sqrt{\left(\frac{2p}{n^2} \cos \theta\right) + \sqrt{(\sin^2 \theta - 2 \frac{p^2}{n^2} \cos \theta)}} \\ = i \sin \alpha \sqrt{(\sec \alpha + \cos \theta)} + \sqrt{(\sec \alpha - \cos \theta)} (\cos \alpha - \cos \theta),$$

if the axis falls in the lowest position to an angle α with the downward vertical.

With $s_2 = 0$ in (21) and $s_3 = -\cos \beta$, and changing to the upward vertical measurement, the motion is given by

$$(24) \quad \sin \theta \exp i\varpi = e^{-i\mu t} \sqrt{(\cos \beta \cos \theta)} + i\sqrt{(\cos \beta \cos \theta - \cos^2 \theta)},$$

and the axis rises from the horizontal position to a series of cusps; and the mean precessional motion is the same as in steady motion with the same rotation and the axis horizontal.

The special case of $f = \frac{1}{2}$ may be stated here; it is found that

$$(25) \quad \frac{p}{2} \exp(\varpi - pt) = \sqrt{\frac{(1+x)(x-x')}{2}} + i\sqrt{\frac{(1-x)(x+x')}{2}},$$

$$(26) \quad p^2 = a^2(x - x')^2,$$

$$(27) \quad \frac{1}{2} \lambda \sin \theta \exp(\psi - pt) = (L - 1 + x - x') \sqrt{\frac{(1-x)(x+x')}{2}} \\ + i(L - 1 + x + x') \sqrt{\frac{(1+x)(x-x')}{2}}$$

$$(28) \quad L = \frac{1}{2}(1 - \kappa) + \lambda p/n,$$

so that $p = 0$ and the motion is made algebraical by taking $L = \frac{1}{2}(1 - \kappa)$. The stereoscopic diagram of fig. 12 drawn by T. I. Dewar shows these curves for $\kappa = \frac{1}{2}, \frac{1}{3}$, and $\frac{1}{4}$ (cusps).

10. So far the motion of the axis OC' of the top has alone been considered; for the specification of any point of the body, Euler's third angle ϕ must be introduced, representing the angular displacement of the wheel with respect to the stalk. This is given by

$$(1) \quad \frac{d\phi}{dt} + \cos \theta \frac{d\psi}{dt} = R,$$

$$(2) \quad \frac{d(\phi + \psi)}{dt} = \left(1 - \frac{C}{A}\right) R + \frac{G' + G}{A(1 + \cos \theta)}$$

$$\frac{d(\phi - \psi)}{dt} = \left(1 - \frac{C}{A}\right) R + \frac{G' - G}{A(1 - \cos \theta)}$$

It will simplify the formulas by cancelling a secular term if we make $C = A$, and the top is then called a spherical top; OH becomes the axis of instantaneous angular velocity, as well as of resultant angular momentum.

When this secular term is restored in the general case, the axis OI of angular velocity is obtained by producing Q'H to I, making

$$(3) \quad \frac{HI}{O'H} = \frac{A - C}{C}, \quad \frac{HI}{O'I} = \frac{A - C}{A}$$

and then the four vector components OC', CK, KH, HI give a resultant vector OI, representing the angular velocity ω , such that

$$(4) \quad OI/QI = \omega/R.$$

The point I is then fixed on the generating line QH of the deformable hyperboloid, and the other generator through I will cut the fixed generator OC of the opposite system in a fixed point O'.

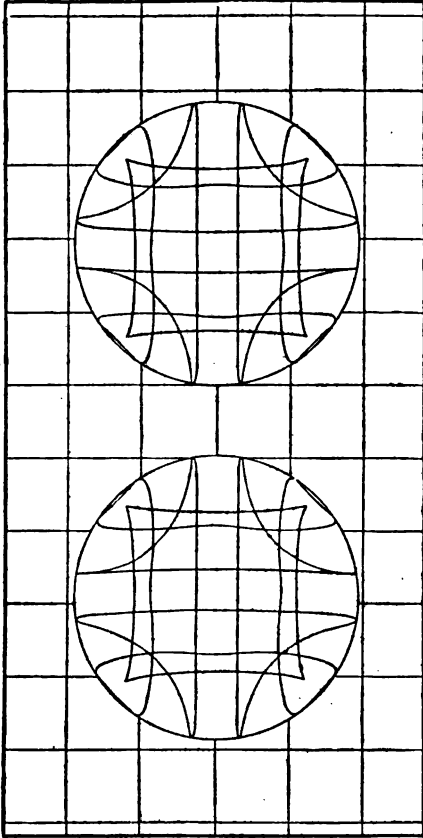

FIG. 12.

such that IO' is of constant length, and may be joined up by a link, which constrains I to move on a sphere.

In the spherical top then,

$$(5) \quad \frac{1}{2}(\phi + \psi) = \int \frac{G' + G}{1+z} \frac{dz}{2A}, \quad \frac{1}{2}(\phi - \psi) = \int \frac{G' - G}{1-z} \frac{dz}{2A}$$

depending on the two elliptic integrals of the third kind, with pole at $z = \pm 1$; and measuring θ from the downward vertical, their elliptic parameters are—

$$(6) \quad v_1 = \int_1^z \frac{\sqrt{(z_2 - z_1) dz}}{\sqrt{(4Z)}} = f_1 K' i,$$

$$(7) \quad v_2 = \int_{-1}^z \frac{\sqrt{(z_2 - z_1) dz}}{\sqrt{(4Z)}} = K + (1 - f_2) K' i$$

$$(8) \quad f_1 K' = \int_1^z \frac{\sqrt{(z_2 - z_1) dz}}{\sqrt{(-4Z)}} \\ = \eta n^{-1} \sqrt{\frac{z_2 - z_1}{1 - z_1}} = c n^{-1} \sqrt{\frac{1 - z_2}{1 - z_1}} = d n^{-1} \sqrt{\frac{1 - z_2}{1 - z_1}}$$

$$(9) \quad (1 - f_2) K' = \int_{-1}^z \frac{\sqrt{(z_2 - z_1) dz}}{\sqrt{(-4Z)}} \\ = \eta n^{-1} \sqrt{\frac{-1 - z_1}{z_2 - z_1}} = c n^{-1} \sqrt{\frac{1 + z_2}{z_2 - z_1}} \\ = d n^{-1} \sqrt{\frac{1 + z_2}{z_2 - z_1}}$$

Then if $v' = K + (1 - f') K' i$ is the parameter corresponding to $z = D$, we find

$$(10) \quad f = f_2 - f_1, \quad f' = f_2 + f_1,$$

$$(11) \quad v' = v_2 + v_1, \quad v = v_2 - v_1.$$

The most symmetrical treatment of the motion of any point fixed in the top will be found in Klein and Sommerfeld, *Theorie des Kreisels*, to which the reader is referred for details; four new functions, $\alpha, \beta, \gamma, \delta$, are introduced, defined in terms of Euler's angles, θ, ψ, ϕ , by

$$(12) \quad \alpha = \cos \frac{1}{2} \theta \exp \left\{ \begin{matrix} \phi + \psi \\ -\phi + \psi \end{matrix} \right\} i,$$

$$(13) \quad \beta = i \sin \frac{1}{2} \theta \exp \left\{ \begin{matrix} -\phi + \psi \\ \phi - \psi \end{matrix} \right\} i,$$

$$(14) \quad \gamma = i \sin \frac{1}{2} \theta \exp \left\{ \begin{matrix} \phi - \psi \\ -\phi - \psi \end{matrix} \right\} i,$$

$$(15) \quad \delta = \cos \frac{1}{2} \theta \exp \left\{ \begin{matrix} -\phi - \psi \\ \phi + \psi \end{matrix} \right\} i.$$

Next Klein takes two functions or co-ordinates λ and Λ , defined by

$$(16) \quad \lambda = \frac{x + yi}{r - z}, \quad \Lambda = \frac{r + z}{r - z}$$

and Λ the same function of X, Y, Z , so that λ, Λ play the part of stereographic representations of the same point (x, y, z) or (X, Y, Z) on a sphere of radius r , with respect to poles in which the sphere is intersected by Oz and OZ .

These new functions are shown to be connected by the bilinear relation

$$(17) \quad \lambda = \frac{2\Lambda + \beta}{\gamma\Lambda + \delta}, \quad \alpha\delta - \beta\gamma = 1,$$

in accordance with the annexed scheme of transformation of co-ordinates—

	Z	H	Z
ξ	α^2	β^2	$2\alpha\beta$
η	γ^2	δ^2	$2\gamma\delta$
ζ	$\alpha\gamma$	$\beta\delta$	$\alpha\delta + \beta\gamma$

where

$$(18) \quad \xi = x + yi, \quad \eta = -x + yi, \quad \zeta = -z,$$

$$Z = X + Yi, \quad H = -X + Yi, \quad \bar{Z} = -Z;$$

and thus the motion in space of any point fixed in the body defined by Λ is determined completely by means of $\alpha, \beta, \gamma, \delta$; and in the case of the symmetrical top these functions are elliptic transcendents, to which Klein has given the name of *multiplicative elliptic functions*; and

$$(19) \quad \alpha\delta = \cos^2 \frac{1}{2} \theta, \quad \beta\gamma = -\sin^2 \frac{1}{2} \theta,$$

$$\alpha\delta - \beta\gamma = 1, \quad \alpha\delta + \beta\gamma = \cos \theta,$$

$$\sqrt{(-4\alpha\beta\gamma\delta)} = \sin \theta;$$

while, for the motion of a point on the axis, putting $\Lambda = 0$, or ∞ ,

$$(20) \quad \lambda = \beta/\delta = i \tan \frac{1}{2} \theta e^{i\psi}, \quad \text{or } \lambda = \alpha/\gamma = -i \cot \frac{1}{2} \theta e^{i\psi},$$

and

$$(21) \quad \alpha\beta = \frac{1}{2} i \sin \theta e^{i\psi}, \quad \alpha\gamma = \frac{1}{2} i \sin \theta e^{i\psi},$$

giving orthogonal projections on the planes GKH, CHK; and

$$(22) \quad \frac{d\beta}{d\lambda} = \frac{d\alpha}{d\lambda} = \frac{d\gamma}{d\lambda} = \frac{d\delta}{d\lambda} = \frac{1}{2} \frac{d\theta}{d\lambda} e^{i\psi},$$

the vectorial equation in the plane GKH of the herpolhode of H for a spherical top.

When f_1 and f_2 in (9) are rational fractions, these multiplicative elliptic functions can be replaced by algebraical functions, qualified by factors which are exponential functions of the time t ; a series of quasi-algebraical cases of motion can thus be constructed, which become purely algebraical when the exponential factors are cancelled by a suitable arrangement of the constants.

Thus, for example, with $f = 0, f' = 1, f_1 = \frac{1}{2}, f_2 = \frac{1}{2}$, as in (24) § 9, where P and P' are at A and B on the focal ellipse, we have for the spherical top

$$(23) \quad (1 + \cos \theta) \exp(\phi + \psi - q t) i \\ = \sqrt{(\sec \beta - \cos \theta)} \sqrt{(\cos \beta - \cos \theta)} + i(\sqrt{\sec \beta + \cos \theta}) \sqrt{\cos \theta},$$

$$(24) \quad (1 - \cos \theta) \exp(\phi - \psi - q' t) i \\ = \sqrt{(\sec \beta - \cos \theta)} \sqrt{(\cos \beta - \cos \theta)} + i(\sqrt{\sec \beta - \cos \theta}) \sqrt{\cos \theta},$$

$$(25) \quad g, q' = n \sqrt{(2 \sec \beta)} = n \sqrt{(2 \cos \beta)};$$

and thence $\alpha, \beta, \gamma, \delta$ can be inferred.

The physical constants of a given symmetrical top have been denoted in § 1 by M, h, A, C, and f, n, T ; to specify a given state of general motion we have G, G' or CR, D, E, or F, which may be called the dynamical constants; or κ, v, w, v_1, v_2 , or f, f', f_1, f_2 , the analytical constants; or the geometrical constants, such as $\alpha, \beta, \delta, \delta', h$ of a given articulated hyperboloid.

There is thus a triply infinite series of a state of motion; the choice of a typical state can be made geometrically on the hyperboloid, flattened in the plane of the local ellipse, of which α is the ratio of the semiaxes a and β , and $\text{am}(1 - f) K'$ is the eccentric angle from the minor axis of the point of contact P of the generator HQ, so that two analytical constants are settled thereby; and the point H may be taken arbitrarily on the tangent line PQ, and HQ' is then the other tangent of the focal ellipse; in which case θ_1 and θ_2 are the angles between the tangents HQ, HQ', and between the focal distances HS, HS', and h^2 will be HS.HS', while HQ, HQ' are δ, δ' .

As H is moved along the tangent line HQ, a series of states of motion can be determined, and drawn with accuracy.

11. Equation (5) § 3 with slight modification will serve with the same notation for the steady rolling motion at a constant inclination α to the vertical of a body of revolution, such as a disk, hoop, wheel, cask, wine-glass, plate, dish, bowl, spinning top, gyrostator, or bicycle, on a horizontal plane, or a surface of revolution, as a coin in a conical lamp-shade.

The point O is now the intersection of the axis GC' with the vertical through the centre B of the horizontal circle described by the centre of gravity, and through the centre M of the horizontal circle described by P, the point of contact (fig. 13). Collected into a particle at G, the body swings round the vertical OB as a conical pendulum, of height AB or GL equal to $g/p^2 \sin \alpha$, and GA would be the direction of the thread, of tension $gM(GA/GL)$ dynes. The reaction with the plane at P will be an equal parallel force; and its moment round G will provide the couple which causes the velocity of the vector of angular momentum appropriate to the steady motion; and this moment will be

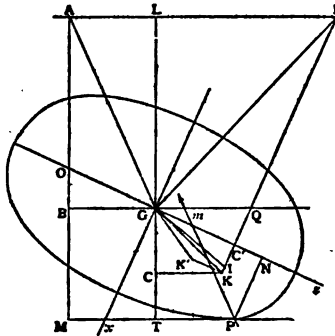

FIG. 13.

$gM.Gm$ dyne-cm. or ergs, if the reaction at P cuts GB in m.

Draw GR perpendicular to GK to meet the horizontal AL in R, and draw RQC'K perpendicular to the axis Gs, and KC perpendicular to LG.

The velocity of the vector GK of angular momentum is ρ times the horizontal component, and

- (1) horizontal component $/A\rho \sin \alpha = KC/KC'$,
- so that'
- (2) $gM.Gm = A\rho^2 \sin \alpha (KC/KC')$,
- (3) $\frac{A}{M} \frac{KC'}{KC} \frac{g}{\rho^2 \sin \alpha} Gm = CQ.Gm.$

The instantaneous axis of rotation of the case of a gyrostator would be OP; drawing GI parallel to OP, and KK' parallel to OG, making $\tan K'GC' = (A/C) \tan IGC'$; then if GK represents the resultant angular momentum, K'K will represent the part of it due to the rotation of the fly-wheel. Thus in the figure for the body rolling as a solid, with the fly-wheel clamped, the points m and Q move to the other side of G. The gyrostator may be supposed swung round the vertical at the end of a thread PA' fastened at A' where Pm produced cuts the vertical AB, and again at the point where it crosses the axis GO. The discussion of the small oscillation superposed on the state of steady motion requisite for stability is given in the next paragraph.

12. In the theoretical discussion of the general motion of a gyrostator rolling on a horizontal plane the safe and shortest plan apparently is to write down the most general equations of motion, and afterwards to introduce any special condition.

Drawing through G the centre of gravity any three rectangular axes Gx, Gy, Gz the notation employed is

- u, v, w , the components of linear velocity of G;
- p, q, r , the components of angular velocity about the axes,
- h_1, h_2, h_3 , the components of angular momentum;
- $\theta_1, \theta_2, \theta_3$, the components of angular velocity of the co-ordinate axes;
- x, y, z , the co-ordinates of the point of contact with the horizontal plane;
- X, Y, Z , the components of the reaction of the plane;
- α, β, γ , the direction cosines of the downward vertical.

The geometrical equations, expressing that the point of contact is at rest on the plane, are

- (1) $u - ry + qz = 0,$
- (2) $v - ps + rz = 0,$
- (3) $w - qx + py = 0.$

The dynamical equations are

- (4) $du/dt - \theta_2 w + \theta_3 v = g\alpha + X/M,$
- (5) $dv/dt - \theta_1 w + \theta_3 u = g\beta + Y/M,$
- (6) $dw/dt - \theta_1 v + \theta_2 u = g\gamma + Z/M,$
- and
- (7) $dh_1/dt - \theta_2 h_2 + \theta_3 h_3 = \gamma Z - sY,$
- (8) $dh_2/dt - \theta_1 h_3 + \theta_3 h_1 = sX - zZ,$
- (9) $dh_3/dt - \theta_1 h_1 + \theta_2 h_2 = sY - \gamma X.$

In the special case of the gyrostator where the surface is of revolution round Gs, and the body is kinetically symmetrical about Gs, we take Gy horizontal and Gsz through the point of contact so that $y = 0$; and denoting the angle between Gs and the downward vertical by θ (fig. 13)

- (10) $\alpha = \sin \theta, \beta = 0, \gamma = \cos \theta.$
 - The components of angular momentum are
 - (11) $h_1 = A\rho, h_2 = Aq, h_3 = Cr + K,$
- where A, C denote the moment of inertia about Gx, Gz, and K is the angular momentum of a fly-wheel fixed in the interior with its axis parallel to Gz; K is taken as constant during the motion.

The axis Gs being fixed in the body,

- (12) $\theta_1 = \dot{\theta}, \theta_2 = \dot{\theta} \cos \theta - \dot{\theta} \sin \theta, \theta_3 = \dot{\theta} \cot \theta.$
- With $\gamma = 0$, (1), (2), (3) reduce to
- (13) $u = -gz, v = ps - rz, w = qx;$

and, denoting the radius of curvature of the meridian curve of the rolling surface by ρ ,

$$(14) \frac{dx}{dt} = \rho \cos \theta \frac{d\theta}{dt} = -g\rho \cos \theta, \frac{dz}{dt} = -\rho \sin \theta \frac{d\theta}{dt} = g\rho \sin \theta;$$

so that

- (15) $\frac{du}{dt} = -\frac{dg}{dt}z - g^2\rho \sin \theta,$
- (16) $\frac{dv}{dt} = \frac{dp}{dt}z - \frac{dr}{dt}x + pq\rho \sin \theta + g\rho \cos \theta,$
- (17) $\frac{dw}{dt} = \frac{dq}{dt}x - g^2\rho \cos \theta.$

The dynamical equations (4) ... (9) can now be reduced to

- (18) $\frac{X}{M} = -\frac{dg}{dt}z - p^2 \cos \theta + g^2(x - \rho \sin \theta) + prx \cot \theta - g \sin \theta,$
- (19) $\frac{Y}{M} = \frac{dp}{dt}z - \frac{dr}{dt}x - pq(x + s \cot \theta - \rho \sin \theta) + g\rho \cos \theta,$
- (20) $\frac{Z}{M} = \frac{dq}{dt}x + q^2(s - \rho \cos \theta) + p^2s - prx - g \cos \theta,$
- (21) $-sY = A \frac{dp}{dt} - A pq \cot \theta + qh_3,$
- (22) $-sX - zZ = A \frac{dq}{dt} + A p^2 \cot \theta - ph_1,$
- (23) $sY = \frac{dh_2}{dt} - C \frac{dr}{dt} = -Cq \frac{d\theta}{dt}$

Eliminating Y between (19) and (23),

$$(24) \left(\frac{C}{M} + s^2\right) \frac{d\theta}{dt} - xz \frac{dp}{dt} + pqx(x + z \cot \theta - \rho \sin \theta) - g\rho x \cos \theta = 0,$$

$$(A) \left(\frac{C}{M} + s^2\right) \frac{dr}{dt} - xz \frac{dp}{dt} - px(x + s \cot \theta - \rho \sin \theta) + rz\rho \cos \theta = 0.$$

Eliminating Y between (19) and (21)

- (25) $\left(\frac{A}{M} + s^2\right) \frac{dq}{dt} - xz \frac{dr}{dt} - A pq \cot \theta + p^2 h_2 - pqz(x + z \cot \theta - \rho \sin \theta) + g\rho z \cos \theta = 0,$
- (B) $-xz \frac{dr}{dt} + \left(\frac{A}{M} + s^2\right) \frac{dp}{dt} + \frac{A}{M} p \cot \theta - \frac{h_1}{M} + ps(x + z \cot \theta - \rho \sin \theta) - rz\rho \cos \theta = 0.$

In the special case of a gyrostator rolling on the sharp edge of a circle passing through G, $s = 0, \rho = 0$, (A) and (B) reduce to

- (26) $p = \left(\frac{C}{Mx^2} + 1\right) \frac{dr}{dt} = \left(\frac{1}{Mx^2} + \frac{1}{C}\right) \frac{dh_2}{dt},$
- (27) $\frac{dp}{dt} + p \cot \theta = \frac{h_2}{A}, \frac{d}{dt} \frac{p \sin \theta}{A} = \frac{h_2 \sin \theta}{A},$
- (28) $\frac{d^2 h_2}{dt^2} + \frac{dh_2}{dt} \cot \theta = \frac{CMx^2}{A(Mx^2 + C)} h_2,$

a differential equation of a hypergeometric series, of the form of Legendre's zonal harmonic of fractional order s , given by

- (29) $\pi(s+1) = CM^2/A(Mx^2 + C).$

For a sharp point, $x = 0, \rho = 0$, and the previous equations are obtained of a spinning top.

The elimination of X and Z between (18) (20) (22), expressed symbolically as

$$(30) \quad (22) - s(18) + x(20) = 0,$$

gives

$$(C) \left(\frac{A}{M} + s^2 + s^2\right) \frac{dq}{dt} - p^2 \frac{h_1}{M} + \left(\frac{A}{M} + s^2\right) p^2 \cot \theta + p^2 xz + g^2 p(x \cos \theta - s \sin \theta) - prx(x + s \cot \theta) - g(x \cos \theta - s \sin \theta) = 0,$$

and this combined with (A) and (B) will lead to an equation the integral of which is the equation of energy.

13. The equations (A) (B) (C) are intractable in this general form; but the restricted case may be considered when the axis moves in steady motion at a constant inclination α to the vertical; and the stability is secured if a small nutation of the axis can be superposed. It is convenient to put $\rho = \Omega \sin \theta$, so that Ω is the angular velocity of the plane Gsz about the vertical; (A) (B) (C) become

$$(A^*) \left(\frac{C}{M} + x^2 \right) \frac{d^2 \theta}{dt^2} - 2x \sin \theta \frac{d\Omega}{dt} - \Omega^2 (x \sin \theta - 2x \cos \theta - \rho \sin^2 \theta) + r\omega \rho \cos \theta = 0,$$

$$(B^*) -x \frac{d^2 \rho}{dt^2} + \left(\frac{A}{M} + \rho^2 \right) \sin \theta \frac{d\Omega}{dt} - 2\Omega \left(\frac{A}{M} + \rho^2 \right) \cos \theta + \Omega^2 x \sin \theta (x - \rho \sin \theta) - r\omega \rho \cos \theta = 0,$$

$$(C^*) \left(\frac{A}{M} + x^2 + \rho^2 \right) \frac{d^2 \theta}{dt^2} + 2x\rho (x \cos \theta - s \sin \theta) - \Omega \frac{A}{M} \sin \theta + \Omega^2 \left(\frac{A}{M} + \rho^2 \right) \sin \theta \cos \theta + \Omega^2 x \sin^2 \theta - D \rho x (x \sin \theta + z \cos \theta) - z (x \cos \theta - s \sin \theta) = 0.$$

The steady motion and nutation superposed may be expressed by
 (1) $\theta = a + L, \sin \theta = \sin a + L \cos a, \cos \theta = \cos a - L \sin a,$
 $\Omega = \mu + N, r = R + Q,$

where L, N, Q are small terms, involving a factor $e^{i\omega t}$, to express the periodic nature of the nutation; and then if a, c denote the mean value of x, s, at the point of contact

- (2) $x = a + L \rho \cos a, s = c - L \rho \sin a,$
 - (3) $x \sin \theta + z \cos \theta = a \sin a + c \cos a + L(a \cos a - c \sin a),$
 - (4) $x \cos \theta - s \sin \theta = a \cos a - c \sin a - L(a \sin a + c \cos a).$
- Substituting these values in (C*) with $d\theta/dt = -\sigma \theta/dt = \pi L$, and ignoring products of the small terms, such as L^2, LN, \dots

$$(C^{**}) \left(\frac{A}{M} + a^2 + c^2 \right) L \omega^2 - (\mu + N) \left(\frac{CR + K}{M} + \frac{CQ}{M} \right) (\sin a + L \cos a) + (a^2 + 2\mu N) \left(\frac{A}{M} + c^2 - 2L\rho c \sin a \right) (\sin a \cos a + L \cos a) + (a^2 + 2\mu N) [ac - L\rho(a \sin a - c \sin a)] (\sin^2 a + L \sin 2a) - (\mu + N)(R + Q)(a + L\rho \cos a) (a \sin a + c \cos a) + L(a \cos a - c \sin a) - z(a \cos a - c \sin a) + zL(a \sin a + c \cos a - \rho) = 0,$$

which is equivalent to

- (5) $-\mu \frac{CR + K}{M} \sin a + \mu^2 \left(\frac{A}{M} + c^2 \right) \sin a \cos a + \mu^2 ac \sin^2 a - \mu Ra (a \sin a + c \cos a) - z(a \cos a - c \sin a) = 0,$
 the condition of steady motion; and
- (6) $DL + EQ + FN = 0,$

where

$$(7) D = \left(\frac{A}{M} + a^2 + c^2 \right) \pi^2 - \frac{CK + K}{M} \cos a - 2\mu^2 \rho c \sin^2 a \cos a + \mu^2 \left(\frac{A}{M} + c^2 \right) \cos a - \mu^2 \rho (a \sin a - c \sin a) \sin^2 a + \mu^2 ac \sin 2a - \mu R \rho \cos a (a \sin a + c \cos a) - \mu Ra (a \cos a - c \sin a) + z(a \sin a + c \cos a - \rho),$$

$$(8) E = -\mu \frac{C}{M} \sin a - \mu a (a \sin a + c \cos a),$$

$$(9) F = -\frac{CR + K}{M} \sin a + 2\mu \left(\frac{A}{M} + c^2 \right) \sin a \cos a + 2\mu ac \sin^2 a - \mu Ra (a \sin a + c \cos a).$$

With the same approximation (A*) and (B*) are equivalent to

$$(A^{**}) \left(\frac{C}{M} + a^2 \right) \frac{Q}{L} - ac \sin a \frac{N}{L} - \mu a (a \sin a + c \cos a - \rho) \sin^2 a + R \rho \cos a = 0,$$

$$(B^{**}) -ac \frac{Q}{L} + \left(\frac{A}{M} + c^2 \right) \sin a \frac{N}{L} - \frac{CR + K}{M} + 2\mu \left(\frac{A}{M} + c^2 \right) \cos a + \mu c \sin a (a - \rho \sin a) - R \rho \cos a = 0.$$

The elimination of L, Q, N will lead to an equation for the determination of μ^2 , and μ^2 must be positive for the motion to be stable. If b is the radius of the horizontal circle described by G in steady motion round the centre B,

(10) $b = \nu \mu = (cP - aR)/\mu = c \sin a - aR/\mu,$ and drawing GL vertically upward of length $\lambda = g/\mu^3$, the height of the equivalent conical pendulum, the steady motion condition may be written

$$(11) (CR + K)\mu \sin a - \mu^2 \sin a \cos a = -gM(a \cos a - c \sin a) + M(\mu^2 c \sin a - \mu Ra) (a \sin a + c \cos a) = \frac{1}{2} M(b\lambda - (a \sin a + c \cos a) - a \cos a + c \sin a) = gM \cdot PT,$$

LG produced cuts the plane in T.

Interpreted dynamically, the left-hand side of this equation represents the velocity of the vector of angular momentum about G, so that the right-hand side represents the moment of the applied force about G, in this case the reaction of the plane, which is parallel to GA, and equal to $gM \cdot GA/GL$; and so the angle AGL must be less than the angle of friction, or slipping will take place.

Spinning upright, with $a=0, \alpha=0$, we find $F=0, Q=0$, and

$$(12) \frac{CR + K}{M} + 2\mu \left(\frac{A}{M} + c^2 \right) - R \rho \cos a = 0,$$

$$(13) \left(\frac{A}{M} + c^2 \right) \mu^2 = \mu \frac{CR + K}{M} - \mu^2 \left(\frac{A}{M} + c^2 \right) + \mu R \rho c - g(c - \rho),$$

$$(14) \left(\frac{A}{M} + c^2 \right) \mu^2 = \frac{1}{2} \left(\frac{CK + R}{M} + R \rho \right) - g \left(\frac{A}{M} + c^2 \right) (c - \rho).$$

Thus for a top spinning upright on a rounded point, with $K=0$, the stability requires that

$$(15) R > 2hk \sqrt{g(c-\rho)} / (h^2 + c\rho),$$

where h, k are the radii of gyration about the axis Gs, and a perpendicular axis at a distance c from G; this reduces to the preceding case of § 3 (7) when $\rho=0$.

Generally, with $\alpha=0$, but $a \neq 0$, the condition (A) and (B) becomes

$$(16) \left(\frac{C}{M} + a^2 \right) \frac{Q}{L} = 2\mu ac - R \rho \cos a - ac \frac{Q}{L} = \frac{CR + K}{M} + R \rho c - 2\mu \left(\frac{A}{M} + a^2 \right),$$

so that, eliminating Q/L ,

$$(17) 2 \left[\left(\frac{A}{M} + c^2 \right) \left(\frac{C}{M} + a^2 \right) - a^2 c^2 \right] \mu = \left(\frac{C}{M} + a^2 \right) \left(\frac{CR + K}{M} \right) + \frac{C}{M} R \rho c,$$

the condition when a coin or platter is rolling nearly flat on the table.

Rolling along in a straight path, with $a = \frac{1}{2}\pi, c=0, \mu=0, E=0$; and

$$(18) N/L = (CR + K)/A,$$

$$(19) D = \left(\frac{A}{M} + a^2 \right) \pi^2 + g(a - \rho),$$

$$F = -\frac{CR + K}{M} - R a^2,$$

$$(20) \frac{N}{L} = -\frac{D}{F} = \frac{\left(\frac{A}{M} + a^2 \right) \pi^2 + g(a - \rho)}{\left(\frac{CR + K}{M} \right) + R a^2},$$

$$(21) \left(\frac{A}{M} + a^2 \right) \pi^2 L = \frac{CR + K}{A} \left[\left(\frac{C}{M} + a^2 \right) R + \frac{K}{M} \right] - z(a - \rho).$$

Thus with $K=0$, and rolling with velocity $V = Ra$, stability requires

$$(22) \frac{V^2}{zg} > \frac{a - \rho}{2} \frac{C}{A(Ma^2 + 1)} > \frac{1}{2} \frac{A}{C} \frac{a - \rho}{Ca^2 + 1}$$

or the body must have acquired velocity greater than attained by rolling down a plane through a vertical height $\frac{1}{2}(a - \rho)A/C$.

On a sharp edge, with $\rho=0$, a thin uniform disk or a thin ring requires

$$(23) V^2/zg > a/6 \text{ or } a/8.$$

The gyrost at can hold itself upright on the plane without advance when $R=0$, provided

$$(24) K^2/AM - z(a - \rho) \text{ is positive.}$$

For the stability of the monorail carriage of § 5 (6), ignoring the rotary inertia of the wheels by putting $C=0$, and replacing K by G^2 the theory above would require

$$(25) \frac{G^2}{A} \left(aV + \frac{G}{C} \right) > gk.$$

For further theory and experiments consult Routh, *Advanced Rigid Dynamics*, chap. v., and Thomson and Tait, *Natural Philosophy*, § 345; also Bourlet, *Traité des bicyclettes* (analysed in Appell, *Mécanique rationnelle*, ii. 297, and Carvallo, *Journal de l'école polytechnique*, 1900); Whipple, *Quarterly Journal of Mathematics*, vol. xxx., for mathematical theories of the bicycle, and other bodies.

14. Lord Kelvin has studied theoretically and experimentally the vibration of a chain of stretched gyrostatic wheels. (*Proc. London Math. Soc.*, 1875; J. Perry, *Spinning Tops*, for a diagram.) Suppose each gyrost at to be equivalent dynamically to a fly-wheel of axis l length $2l$, and that each connecting link is a light cord or steel wire of length $2l$, stretched to a tension T.

Denote by x, y the components of the slight displacement from the central straight line of the centre of a fly-wheel; and let ρ, ψ, τ denote the direction cosines of the axis of a fly-wheel, and ϵ, ζ, η the direction cosines of a link, distinguishing the different bodies by a suffix.

Then with the previous notation and to the order of approximation required,

$$(1) \theta_1 = -a_1 \dot{q}_1 / dl, \theta_2 = \dot{d} \rho / dl,$$

$$(2) h_1 = A \rho_1, h_2 = A \rho_2, h_3 = K_3,$$

to be employed in the dynamical equations

$$(3) \frac{dh_1}{dt} - \theta_1 h_2 + \theta_2 h_3 = L_1 \dots$$

in which $\theta_1 h_1$ and $\theta_2 h_2$ can be omitted.

For the k th fly-wheel

$$(4) -A \dot{\rho}_k + K \dot{\rho}_k = T a_k (\rho_{k-1} - \rho_k) + T a_k (\rho_{k+1} - \rho_k),$$

$$(5) A \dot{\rho}_k + K \dot{\rho}_k = -T a_k (\rho_k - \rho_{k-1}) - T a_k (\rho_k - \rho_{k+1});$$

and for the motion of translation

$$(6) M \dot{x}_k = T (\rho_{k+1} - \rho_k), M \dot{y}_k = T (\rho_{k+1} - \rho_k),$$

while the geometrical relations are

$$(7) x_{k+1} - x_k = a (\rho_{k+1} + \rho_k) + 2l r_{k01},$$

$$(8) y_{k+1} - y_k = a (\rho_{k+1} + \rho_k) + 2l r_{k02}.$$

Putting

$$(9) x + y = w, \rho + \sigma = \alpha, r + s = \beta,$$

these three pairs of equations may be replaced by the three equations

$$\begin{aligned} (10) \quad & A\dot{\theta}_1 - K\dot{\theta}_2 + 2T a \dot{\theta}_3 - T a (\epsilon_{21} + \epsilon_1) = 0, \\ (11) \quad & M\dot{\theta}_1 - T (\epsilon_{21} + \epsilon_1) = 0, \\ (12) \quad & w_{21} - w_2 - a(\dot{\theta}_1 + \dot{\theta}_2) - 2l\epsilon_{21} = 0. \end{aligned}$$

For a vibration of circular polarization assume a solution $\theta_1, \theta_2, \theta_3 = (L, P, Q) \exp(\mu t + i c t)$, so that c/μ is the time-lag between the vibration of one fly-wheel and the next; and the wave velocity is

$$\begin{aligned} (14) \quad & U = 2(a+l)\mu/c. \\ \text{Then} \\ (15) \quad & P(-A\mu^2 + K\mu + 2Ta) - QTa(\epsilon^2 + 1) = 0, \\ (16) \quad & -LM\mu^2 - QT(\epsilon^2 - 1) = 0, \\ (17) \quad & L(\epsilon^2 - 1) - Pa(\epsilon^2 + 1) - 2Ql\epsilon^2 = 0, \end{aligned}$$

leading, on elimination of L, P, Q , to

$$\begin{aligned} (18) \quad & \cos c = \frac{(2Ta + Kn - A\mu^2)(1 - M\mu^2/T) - M\mu a^2}{2Ta + Kn - A\mu^2 + M\mu a^2}, \\ (19) \quad & 2 \sin^2 \frac{1}{2}c = \frac{M\mu^2 2Ta(a+l) + Kn - A\mu^2}{2Ta + Kn - A\mu^2 + M\mu a^2}. \end{aligned}$$

With $K=0, A=0$, this reduces to Lagrange's condition in the vibration of a string of beads.

- Putting
- (20) $\rho = M/2(a+l)$, the mass per unit length of the chain,
 - (21) $\alpha = K/2(a+l)$, the gyrostatic angular momentum per unit length,
 - (22) $a = A/2(a+l)$, the transverse moment of inertia per unit length,
 - (23) $\frac{1}{2}c = (a+l)\mu/U$,

equation (19) can be written

$$(24) \quad \left\{ \frac{(a+l)\mu}{\sin(a+l)\mu/U} \right\}^2 = \frac{T a + \alpha \mu - a \mu^2}{T + (\alpha - a \mu^2)/a}$$

In a continuous chain of such gyrostatic links, with a and l infinitesimal,

$$(26) \quad U^2 = \frac{T}{\rho} \left\{ 1 + \frac{\alpha - a \mu^2}{T + (\alpha - a \mu^2)/a} \right\}$$

for the vibration of helical nature like circular polarization. Changing the sign of μ for circular polarization in the opposite direction

$$(27) \quad U^2 = \frac{T}{\rho} \left\{ 1 - \frac{\alpha + a \mu^2}{T - (\alpha + a \mu^2)/a} \right\}.$$

In this way a mechanical model is obtained of the action of a magnetized medium on polarized light, α representing the equivalent of the magnetic field, while a may be ignored as insensible (J. Larmor, *Proc. Lond. Math. Soc.*, 1890; *Aether and Matter*, Appendix E).

We notice that U^2 in (26) can be positive, and the gyrostatic chain stable, even when T is negative, and the chain is supporting a thrust, provided α is large enough, and the thrust does not exceed

$$\begin{aligned} (28) \quad & \text{while } U^2 \text{ in (27) will not be positive and the straight chain will be unstable unless the tension exceeds} \\ (29) \quad & \end{aligned}$$

15. *Gyrostal suspended by a Thread.*—In the discussion of the small vibration of a single gyrostal fly-wheel about the vertical position when suspended by a single thread of length $2l=b$, the suffix h can be omitted in the preceding equations of § 14, and we can write

$$\begin{aligned} (1) \quad & A\dot{\theta} - K\dot{\phi} + T a \dot{\theta} - T a \epsilon = 0, \\ (2) \quad & M\dot{\theta} + T a = 0, \text{ with } T = gM, \\ (3) \quad & w - a\dot{\theta} - b\dot{\epsilon} = 0. \end{aligned}$$

Assuming a periodic solution of these equations (4) $w, \theta, \epsilon = (L, P, Q) \exp n t i$, and eliminating L, P, Q , we obtain

$$(5) \quad (-A n^2 + K n + g M a) (g - n^2 b) - g M n^2 a^2 = 0,$$

and the frequency of a vibration in double beats per second is $\pi/2\pi$, where π is a root of this quartic equation.

For upright spinning on a smooth horizontal plane, take $b = \infty$ and change the sign of a , then

$$\begin{aligned} (6) \quad & A n^2 - K n + g M a = 0, \\ \text{so that the stability requires} \\ (7) \quad & K^2 > 4g A M a. \end{aligned}$$

Here A denotes the moment of inertia about a diametral axis through the centre of gravity; when the point of the fly-wheel is held in a small smooth cup, $b=0$, and the condition becomes

$$\begin{aligned} (8) \quad & (A + M a^2) n^2 - K n + g M a = 0, \\ \text{requiring for stability, as before in § 3,} \\ (9) \quad & K^2 > 4g(A + M a^2) M a. \end{aligned}$$

For upright spinning inside a spherical surface of radius b , the

sign of a must be changed to obtain the condition at the lowest point, as in the gyroscopic horizon of Fleuriais.

For a gyrostal spinning upright on the summit of a sphere of radius b , the signs of a and b must be changed in (5), or else the sign of g , which amounts to the same thing.

Denoting the components of horizontal displacement of the point of the fly-wheel by ξ, η , then

$$(10) \quad b \ddot{\xi} = \xi, \quad b \ddot{\eta} = \eta, \quad b \ddot{\omega} = \xi + \eta = \lambda \text{ (suppose),}$$

If the point is forced to take the motion (ξ, η, t) by components of force X, Y, Z , the equations of motion become

$$\begin{aligned} (12) \quad & -A\ddot{\theta} + K\dot{\phi} = Y a - Z a g, \\ (13) \quad & A\dot{\theta} + K\dot{\phi} = -X a + Z a g, \\ (14) \quad & M\ddot{\omega} = X + Y i, \quad M(\dot{\xi} - \dot{\eta}) = Z; \end{aligned}$$

so that (15) $A\dot{\theta} - K\dot{\phi} + g M a \dot{\omega} + M a \dot{\omega} = M a \dot{\omega}'$,

or (16) $(A + M a^2) \ddot{\theta} - K \dot{\theta} + g M a \dot{\omega} + M a \dot{\omega} = M a \dot{\omega}'$.

Thus if the point of the gyrostal is made to take the periodic motion given by $\lambda = R \exp n t i$, $\zeta = 0$, the forced vibration of the axis is given by $\theta = P \exp n t i$, where

$$(17) \quad P \{ -(A + M a^2) n^2 + K n + g M a \} - R M n^2 a = 0;$$

and so the effect may be investigated on the Fleuriais gyroscopic horizon of the motion of the ship.

Suppose the motion λ is due to the suspension of the gyrostal from a point on the axis of a second gyrostal suspended from a fixed point.

Distinguishing the second gyrostal by a suffix, then $\lambda = b \dot{\omega}_1$, if b denotes the distance between the points of suspension of the two gyrostals; and the motion of the second gyrostal influenced by the reaction of the first, is given by

$$(18) \quad \begin{aligned} (A_1 + M_1 b^2) \ddot{\theta}_1 - K_1 \dot{\theta}_1 \\ = -g(M_1 h_1 + M b) \dot{\omega}_1 - b(X + Y i) \\ = -g(M_1 h_1 + M b) \dot{\omega}_1 - M b(a \dot{\omega}' + \dot{\lambda}); \end{aligned}$$

so that, in the small vibration,

$$(19) \quad \frac{R}{b} \{ -(A_1 + M_1 b^2) n^2 + K_1 n + g(M_1 h_1 + M b) \} = M a \dot{\omega}' (a P + R),$$

(20) $R \{ -(A_1 + M_1 b^2) n^2 + M_1 n^2 + K_1 n + g(M_1 h_1 + M b) \} - P M a^2 \dot{\omega}' = 0$. Eliminating the ratio of P to R , we obtain

$$(21) \quad \{ -(A + M a^2) n^2 + K n + g M a \} \times \{ -(A_1 + M_1 b^2) n^2 + M_1 n^2 + K_1 n + g(M_1 h_1 + M b) \} - M_1^2 a^2 \dot{\omega}'^2 = 0,$$

a quartic for n , giving the frequency $n/2\pi$ of a fundamental vibration. Change the sign of g for the case of the gyrostals spinning upright, one on the top of the other, and so realize the gyrostal on the top of a gyrostal described by Maxwell.

In the gyrostatic chain of § 14, the tension T may change to a limited pressure, and U^2 may still be positive, and the motion stable; and so a motion is realized of a number of spinning tops, superposed in a column.

16. *The Flexure Joint.*—In Lord Kelvin's experiment the gyrostals are joined up by equal light rods and short lengths of elastic wire with rigid attachment to the rod and case of a gyrostal, so as to keep the system still, and free from entanglement and twisting due to pivot friction of the fly-wheels.

When this gyrostatic chain is made to revolve with angular velocity n in relative equilibrium as a plane polygon passing through O_x the axis of rotation, each gyrostatic case moves as if its axis produced was attached to O_x by a flexure joint. The instantaneous axis of resultant angular velocity bisects the angle $\pi - \theta$, if the axis of the case makes an angle θ with O_x , and, the components of angular velocity being n about O_x , and $-n$ about the axis, the resultant angular velocity is $2n \cos \frac{1}{2}(\pi - \theta) = 2n \sin \frac{1}{2}\theta$; and the components of this angular velocity are

$$\begin{aligned} (1) \quad & -2n \sin \frac{1}{2}\theta \sin \frac{1}{2}\theta = -n(1 - \cos \theta), \text{ along the axis, and} \\ (2) \quad & -2n \sin \frac{1}{2}\theta \cos \frac{1}{2}\theta = -n \sin \theta, \text{ perpendicular to the axis of the case.} \end{aligned}$$

The flexure joint behaves like a pair of equal bevel wheels engaging. The component angular momentum in the direction O_x is therefore

$$(3) \quad L = -A n \sin \theta \cos \theta - C n (1 - \cos \theta) \sin \theta + K n \sin \theta,$$

and $L n$ is therefore the couple acting on the gyrostal.

If a denotes the angle which a connecting link makes with O_x , and T denotes the constant component of the tension of a link parallel to O_x , the couple acting is

$$\begin{aligned} (4) \quad & T a \cos \theta_1 (\tan \alpha_{2,1} + \tan \alpha_1) - 2 T a \sin \theta_2, \\ \text{which is to be equated to } L n, \text{ so that} \\ (5) \quad & -A n^2 \sin \theta_2 \cos \theta_1 - C n (1 - \cos \theta_1) \sin \theta_1 + K n \sin \theta_1 \\ & - 2 T a \cos \theta_2 (\tan \alpha_{2,1} + \tan \alpha_2) + 2 T a \sin \theta_2 = 0. \end{aligned}$$

In addition (6) $M n^2 x_2 + T (\tan \alpha_{2,1} - \tan \alpha_2) = 0$,

with the geometrical relation (7) $x_{2,1} - x_2 = a (\sin \theta_{2,1} + \sin \theta_2) - 2 l \sin \alpha_{2,1} = 0$.

When the polygon is nearly coincident with O_x , these equations can be replaced by

(8) $(-An^2 + Kn + \frac{1}{2}Ta)\theta_1 - Ta(a_{21} + a_2) = 0,$

(9) $Mn^2x_2 + T(a_{21} - a_2) = 0,$

(10) $2a_1 - x_2 - a(\theta_{21} + \theta_2) - 2la_2 = 0,$

and the rest of the solution proceeds as before in § 14; putting

(11) $x_2, \theta_2, a_2 = (L, P, Q) \exp ckt.$

A half wave length of the curve of gyrostats is covered when $ck = \pi$, so that π/c is the number of gyrostats in a half wave, which is therefore of wave length $2\pi(a+f)/c$.

A plane polarized wave is given when $\exp ckt$ is replaced by $\exp (nt + ckt)i$, and a wave circularly polarized when w, ω, σ of § 14 replace this x, θ, a .

Gyroscopic Pendulum.—The elastic flexure joint is useful for supporting a rod, carrying a fly-wheel, like a gyroscopic pendulum.

Expressed by Euler's angles, θ, ϕ, ψ , the kinetic energy is

(12) $T = \frac{1}{2}A(\dot{\theta}^2 + \sin^2\theta\dot{\phi}^2) + \frac{1}{2}C'(1 - \cos\theta)\dot{\psi}^2 + \frac{1}{2}C(\dot{\phi} + \dot{\psi} \cos\theta)^2,$

where A refers to rod and gyroscope about the transverse axis at the point of support, C' refers to rod about its axis of length, and C refers to the revolving fly-wheel.

The elimination of ψ between the equation of conservation of angular momentum about the vertical, viz.

(13) $A \sin^2\theta \dot{\phi} - C'(1 - \cos\theta) \dot{\psi} + C(\dot{\phi} + \dot{\psi} \cos\theta) \cos\theta = G,$ a constant, and the equation of energy, viz.

(14) $T - \frac{1}{2}Mh \cos\theta = H,$ a constant, with θ measured from the downward vertical, and

(15) $\dot{\phi} + \dot{\psi} \cos\theta = R,$ a constant, will lead to an equation for $d\theta/dt$, or ds/dt , in terms of $\cos\theta$ or s , the integral of which is of hyper-elliptic character, except when $A = C'$.

In the suspension of fig. 8, the motion given by ϕ is suppressed in the stalk, and for the fly-wheel ϕ gives the rubbing angular velocity of the wheel on the stalk; the equations are now

(16) $T = \frac{1}{2}A(\dot{\theta}^2 + \sin^2\theta\dot{\phi}^2) + \frac{1}{2}C'\cos^2\theta\dot{\psi}^2 + \frac{1}{2}CR^2 = H + gMh \cos\theta,$

(17) $A \sin^2\theta \dot{\phi} + C' \cos^2\theta \dot{\psi} + CR \cos\theta = G,$

and the motion is again of hyperelliptic character, except when $A = C'$, or $C' = 0$. To realize a motion given completely by the elliptic function, the suspension of the stalk must be made by a smooth ball and socket, or else a Hooke universal joint.

Finally, there is the case of the general motion of a top with a spherical rounded point on a smooth plane, in which the centre of gravity may be supposed to rise and fall in a vertical line. Here

(18) $T = \frac{1}{2}(A + Mh^2 \sin^2\theta)\dot{\phi}^2 + \frac{1}{2}A \sin^2\theta \dot{\psi}^2 + \frac{1}{2}CR^2 = H - gMh \cos\theta,$ with θ measured from the upward vertical, and

(19) $A \sin^2\theta \dot{\phi} + CR \cos\theta = G,$

where A now refers to a transverse axis through the centre of gravity. The elimination of ψ leads to an equation for $s = \cos\theta$, of the form

(20) $\left(\frac{ds}{dt}\right)^2 = 2g \frac{Z}{h(1-s^2 + A/Mh^2)} - 2g \frac{h(s_2 - s)(s_1 - s)(s_3 - s)}{(s_4 - s)(s - s_4)},$

with the arrangement

(21) $s_1, s_2 > / > s_3 > s_4 > - / > s_4;$

so that the motion is hyperelliptic.

AUTHORITIES.—In addition to the references in the text the following will be found useful:—*Ast. Notices*, vol. i.; *Comptes rendus*, Sept. 1842; Paper by Professor Magnus translated in Taylor's *Foreign Scientific Memoirs*, n.s., pt. 3, p. 210; *Ast. Notices*, xiii, 221-248; *Theory of Foucault's Gyroscope Experiments*, by the Rev. Baden Powell, F.R.S.; *Ast. Notices*, vol. xv.; articles by Major J. C. Barnard in *Silliman's Journal*, 2nd ser., vols. xxiv, and xxv.; E. Hunt on "Rotatory Motion," *Proc. Phil. Soc. Glasgow*, vol. iv.; J. Clerk Maxwell, "On a Dynamical Top," *Trans. R.S.E.*, vol. xxi.; *Phil. Mag.* 4th ser. vols. 7, 13, 14; *Proc. Royal Irish Academy*, vol. viii.; Sir William Thomson on "Gyrostat," *Nature*, xv, 297; G. T. Walker, "The Motion of a Celt," *Quar. Jour. Math.*, 1896; G. T. Walker, *Math. Ency.* iv, 1, xi, 1; Gallop, *Proc. Camb. Phil. Soc.* xii, 82, pt. 2, 1903, "Rise of a Top"; Price's *Infinitesimal Calculus*, vol. iv.; Worms, *The Earth and its Mechanism*; Routh, *Rigid Dynamics*; A. G. Webster, *Dynamics* (1904); H. Crabtree, *Spinning Tops and Gyroscopic Motion* (1909). For a complete list of the mathematical works on the subject of the Gyroscope and Gyrostat from the outset, Professor Cayley's Report to the British Association (1862) on the *Progress of Dynamics* should be consulted. Modern authors will be found cited in Klein and Sommerfeld, *Theorie des Kessels* (1897), and in the *Encyclopädie der mathematischen Wissenschaften*. (G. G.)

GYTHIUM, the harbour and arsenal of Sparta, from which it was some 30 m. distant. The town lay at the N.W. extremity of the Laconian Gulf, in a small but fertile plain at the mouth of the Gythius. Its reputed founders were Heracles and Apollo, who frequently appear on its coins: the former of these names may

point to the influence of Phoenician traders, who, we know, visited the Laconian shores at a very early period. In classical times it was a community of *perioeci*, politically dependent on Sparta, though doubtless with a municipal life of its own. In 455 B.C., during the first Peloponnesian War, it was burned by the Athenian admiral Tolmides. In 370 B.C. Epaminondas besieged it unsuccessfully for three days. Its fortifications were strengthened by the tyrant Nabis, but in 195 B.C. it was invested and taken by Titus and Lucius Quintus Flamininus, and, though recovered by Nabis two or three years later, was recaptured immediately after his murder (192 B.C.) by Philopoemen and Aulus Atilius and remained in the Achaean League until its dissolution in 146 B.C. Subsequently it formed the most important of the Eleutherolaconian towns, a group of twenty-four, later eighteen, communities leagued together to maintain their autonomy against Sparta and declared free by Augustus. The highest officer of the confederacy was the general (*στρατηγός*), who was assisted by a treasurer (*ραμίας*), while the chief magistrates of the several communities bore the title of ephors (*ἑφοροι*).

Pausanias (iii. 21 f.) has left us a description of the town as it existed in the reign of Marcus Aurelius, the agora, the Acropolis, the island of Craneae (Marathonisi) where Paris celebrated his nuptials with Helen, the Migonion or precinct of Aphrodite Migonitis (occupied by the modern town of Marathonisi or Gythium), and the hill Larysium (Koumaro) rising above it. The numerous remains extant, of which the theatre and the buildings partially submerged by the sea are the most noteworthy, all belong to the Roman period.

The modern town is a busy and flourishing port with a good harbour protected by Craneae, now connected by a mole with the mainland: it is the capital of the prefecture (*πολις*) of *Δακωλυκή* with a population in 1907 of 61,522.

See G. Weber, *De Gythico et Lacedaemoniorum rebus navalibus* (Heidelberg, 1833); W. M. Leake, *Travels in the Morea*, i. 244 foll.; E. Curtius, *Peloponnesos*, ii. 267 foll. Inscriptions: Le Bas-Foucart, *Voyage archéologique*, ii. Nos. 238-248 f.; Collitz-Bechtel, *Sammlung d. griech. Dialekt-Inschriften*, iii. Nos. 4562-4573; *British School Annual*, x. 179 foll. Excavations: 'A. Σουλῆς, *Ἐραπειὰ τῆς Ἀρχ. Ἐραπειας*, 1891, 69 foll. (M. N. T.)

GYULA-FEHÉRVÁR (Ger. *Karlsburg*), a town of Hungary, in Transylvania, in the county of Alsó-Fehér, 73 m. S. of Kolozsvár by rail. Pop. (1900) 11,507. It is situated on the right bank of the Maros, on the outskirts of the Transylvanian Erzgebirge or Ore Mountains, and consists of the upper town, or citadel, and the lower town. Gyula-Fehérvár is the seat of a Roman Catholic bishop, and has a fine Roman Catholic cathedral, built in the 11th century in Romanesque style, and rebuilt in 1443 by John Hunyady in Gothic style. It contains among other tombs that of John Hunyady. Near the cathedral is the episcopal palace, and in the same part of the town is the Bathyaneum, founded by Bishop Count Bathyány in 1794. It contains a valuable library with many incunabula and old manuscripts, amongst which is one of the *Nidelungenlied*, an astronomical observatory, a collection of antiquities, and a mineral collection. Gyula-Fehérvár carries on an active trade in cereals, wine and cattle.

Gyula-Fehérvár occupies the site of the Roman colony *Apulum*. Many Roman relics found here, and in the vicinity, are preserved in the museum of the town. The bishopric was founded in the 11th century by King Ladislaus I. (1078-1095). In the 16th century, when Transylvania separated from Hungary, the town became the residence of the Transylvanian princes. From this period dates the castle, and also the buildings of the university, founded by Gabriel Bethlen, and now used as barracks. After the reversion of Transylvania in 1713 to the Habsburg monarchy the actual strong fortress was built in 1716-1735 by the emperor Charles VI., whence the German name of the town.

H The eighth symbol in the Phoenician alphabet, as in its descendants, has altered less in the course of ages than most alphabetic symbols. From the beginning of Phoenician records it has consisted of two uprights connected by transverse bars, at first either two or three in number. The uprights are rarely perpendicular and the cross bars are not so precisely arranged as they are in early Greek and Latin inscriptions. In these the symbol takes the form of two rectangles H out of which the ordinary H develops by the omission of the cross bars at top and bottom. It is very exceptional for this letter to have more than three cross bars, though as many as five are occasionally found in N.W. Greece. Within the same inscription the appearance of the letter often varies considerably as regards the space between and the length of the uprights. When only one bar is found it regularly crosses the uprights about the middle. In a few cases the rectangle is closed at top and bottom but has no middle cross bar H . The Phoenician name for the letter was Heth (Hét). According to Semitic scholars it had two values, (1) a glottal spirant, a very strong h , (2) an unvoiced velar spirant like the German ch in ach . The Greeks borrowed it with the value of the ordinary aspirate and with the name $\eta\alpha$. Very early in their history, however, most of the Greeks of Asia Minor lost the aspirate altogether, and having then no further use for the symbol with this value they adopted it to represent the long e -sound, which was not originally distinguished by a different symbol from the short sound (see E). With this value its name has always been $\eta\alpha$ in Greek. The alphabet of the Asiatic Greeks was gradually adopted elsewhere. In official documents at Athens H represented the rough breathing or aspirate 'till 403 B.C.; henceforth it was used for η . The Western Greeks, however, from whom the Romans obtained their alphabet, retained their aspirate longer than those of Asia Minor, and hence the symbol came to the Romans with the value not of a long vowel but of the aspirate, which it still preserves. The Greek aspirate was itself the first or left-hand half of this letter H , while the smooth breathing ' was the right-hand portion H . At Tarentum H is found for H in inscriptions. The Roman aspirate was, however, a very slight sound which in some words where it was etymologically correct disappeared at an early date. Thus the cognate words of kindred languages show that the Lat. *anser* "goose" ought to begin with h , but nowhere is it so found. In none of the Romance languages is there any trace of initial or medial h , which shows that vulgar Latin had ceased to have the aspirate by 240 B.C. The Roman grammarians were guided to its presence by the Sabine forms where f occurred; as the Sabines said *fasena* (sand), it was recognised that the Roman form ought to be *harena*, and so for *haedus* (goat), *hordeum* (barley), &c. Between vowels h was lost very early, for *ne-hemo* (no man) is throughout the literature *nemo*, *bi-himus* (two winters old) *bimus*. In the Ciceronian age greater attention was paid to reproducing the Greek aspirates in borrowed words, and this led to absurd mistakes in Latin words, mistakes which were satirized by Catullus in his epigram (84) upon Arrius, who said *chommoda* for *commoda* and *hinsidias* for *insidias*. In Umbrian h was often lost, and also used without etymological value to mark length, as in *comakota* (=Lat. *commota*), a practice to which there are some doubtful parallels in Latin.

In English the history of h is very similar to that in Latin. While the parts above the glottis are in position to produce a vowel, an aspirate is produced without vibration of the vocal chords, sometimes, like the pronunciation of Arrius, with considerable effort as a reaction against the tendency to "drop the h 's." Though h survives in Scotland, Ireland and America as well as in the speech of cultivated persons, the sound in most of the vulgar dialects is entirely lost. Where it is not ordinarily lost, it disappears in unaccented syllables, as "Give it 'im" and the like. Where it is lost, conscious attempts to restore it on

the part of uneducated speakers lead to absurd misplacements of h and to its restoration in Romance words when it never was pronounced, as *humble* (now recognized as standard English), *humour* and even *honour*. (P. 61.)

HAAG, CARL (1820—), a naturalized British painter, court painter to the duke of Saxe-Coburg and Gotha, was born in Bavaria, and was trained in the academies at Nuremberg and Munich. He practised first as an illustrator and as a painter, in oil, of portraits and architectural subjects; but after he settled in England, in 1847, he devoted himself to water colours, and was elected associate of the Royal Society of Painters in Water Colours in 1850 and member in 1853. He travelled much, especially in the East, and made a considerable reputation by his firmly drawn and carefully elaborated paintings of Eastern subjects. Towards the end of his professional career Carl Haag quitted England and returned to Germany.

See *A History of the "Old Water-Colour" Society, now the Royal Society of Painters in Water Colours*, by John Lewis Roget (2 vols., London, 1891).

HAAKON (Old Norse *Hákon*), the name of several kings of Norway, of whom the most important are the following:—

HAAKON I., surnamed "the Good" (d. 961), was the youngest son of Harald Haarfager. He was fostered by King Aethelstan of England, who brought him up in the Christian religion, and on the news of his father's death in 933 provided him with ships and men for an expedition against his half-brother Erik, who had been proclaimed king. On his arrival in Norway Haakon gained the support of the landowners by promising to give up the rights of taxation claimed by his father over inherited real property. Erik fled, and was killed a few years later in England. His sons allied themselves with the Danes, but were invariably defeated by Haakon, who was successful in everything he undertook except in his attempt to introduce Christianity, which aroused an opposition he did not feel strong enough to face. He was killed at the battle of Fitje in 961, after a final victory over Erik's sons. So entirely did even his immediate circle ignore his religion that a court skald composed a poem on his death representing his welcome by the heathen gods into Valhalla.

HAAKON IV., surnamed "the Old" (1204-1263), was declared to be the son of Haakon III., who died shortly before the former's birth in 1204. A year later the child was placed under the protection of King Inge, after whose death in 1217 he was chosen king; though until 1223 the church refused to recognize him, on the ground of illegitimacy, and the Pope's dispensation for his coronation was not gained until much later. In the earlier part of his reign much of the royal power was in the hands of Earl Skule, who intrigued against the king until 1239, when he proceeded to open hostility and was put to death. From this time onward Haakon's reign was marked by more peace and prosperity than Norway had known for many years, until in 1263 a dispute with the Scottish king concerning the Hebrides, a Norwegian possession, induced Haakon to undertake an expedition to the west of Scotland. A division of his army seems to have repulsed a large Scottish force at Largs (though the later Scottish accounts claim this battle as a victory), and, having won back the Norwegian possessions in Scotland, Haakon was wintering in the Orkneys, when he was taken ill and died on the 15th of December 1263. A great part of his fleet had been scattered and destroyed by storms. The most important event in his reign was the voluntary submission of the Icelandic commonwealth. Worn out by internal strife fostered by Haakon's emissaries, the Icelandic chiefs acknowledged the Norwegian king as overlord in 1262. Their example was followed by the colony of Greenland.

HAAKON VII. (1872—), the second son of Frederick VIII., king of Denmark, was born on the 3rd of August 1872, and was usually known as Prince Charles of Denmark. When in 1905 Norway decided to separate herself from Sweden the Norwegians

offered their crown to Charles, who accepted it and took the name of Haakon VII., being crowned at Trondhjem in June 1906. The king married Maud, youngest daughter of Edward VII., king of Great Britain, their son, Prince Olav, being born in 1903.

HAARLEM, a town of Holland in the province of North Holland, on the Spaarne, having a junction station 11 m. by rail W. of Amsterdam. It is connected by electric and steam tramways with Zandvoort, Leiden, Amsterdam and Alkmaar. Pop. (1900) 65,189. Haarlem is the seat of the governor of the province of North Holland, and of a Roman Catholic and a Jansenist bishopric. In appearance it is a typical Dutch town, with numerous narrow canals and quaintly gabled houses. Of the ancient city gates the Spaarnewouder or Amsterdam gate alone remains. Gardens and promenades have taken the place of the old ramparts, and on the south the city is bounded by the Frederiks and the Flora parks, between which runs the fine avenue called the Dreef, leading to the Haarlemmer Hout or wood. In the Frederiks Park is a pump-room supplied with a powerful chalybeate water from a spring, the Wilhelmina-bron, in the Haarlemmer Polder not far distant, and in connexion with this there is an orthopaedic institution adjoining. In the great market place in the centre of the city are gathered together the larger number of the most interesting buildings, including the quaint old Fleschers' Hall, built by Lieven de Key in 1603, and now containing the archives; the town hall; the old Stadsdoelen, where the burgesses met in arms; the Groote Kerk, or Great Church; and the statue erected in 1856 to Laurens Janszoon Koster, the printer. The Great Church, dedicated to St Bavo, with a lofty tower (255 ft.), is one of the most famous in Holland, and dates from the end of the 13th and the beginning of the 16th centuries. Its great length (460 ft.) and the height and steepness of its vaulted cedar-wood roof (1538) are very impressive. The choir-stalls and screen (1510) are finely carved, and of further interest are the ancient pulpit sounding-board (1432), some old stained glass, and the small models of ships, copies dating from 1638 of yet earlier models originally presented by the Dutch-Swedish Trading Company. The church organ was long considered the largest and finest in existence. It was constructed by Christian Müller in 1738, and has 4 keyboards, 64 registers and 5000 pipes, the largest of which is 15 in. in diameter and 32 ft. long. Among the monuments in the church are those of the poet Willem Bilderdijk (d. 1831) and the engineer Frederik Willem Conrad (d. 1808), who designed the sea-slucies at Katwyk. In the belfry are the *damiaaltjes*, small bells presented to the town, according to tradition, by William I., count of Holland (d. 1222), the crusader. The town hall was originally a palace of the counts of Holland, begun in the 12th century, and some old 13th-century beams still remain; but the building was remodelled in the beginning of the 17th century. It contains a collection of antiquities (including some beautiful goblets) and a picture gallery which, though small, is celebrated for its fine collection of paintings by Frans Hals. The town library contains several *incunabula* and an interesting collection of early Dutch literature. At the head of the scientific institutions of Haarlem may be placed the Dutch Society of Sciences (*Hollandsche Maatschappij van Wetenschappen*), founded in 1752, which possesses valuable collections in botany, natural history and geology. Teyler's Stichting (*i.e.* foundation), enlarged in modern times, was instituted by the will of Pieter Teyler van der Hulst (d. 1778), a wealthy merchant, for the study of theology, natural science and art, and has lecture-theatres, a large library, and a museum containing a physical and a geological cabinet, as well as a collection of paintings, including many modern pictures, and a valuable collection of drawings and engravings by old masters. The Dutch Society for the Promotion of Industry (*Nederlandsche Maatschappij ter Bevordering van Nijverheid*), founded in 1777, has its seat in the Pavillon Welgelegen, a villa on the south side of the Frederiks Park, built by the Amsterdam banker John Hope in 1778, and afterwards acquired by Louis Bonaparte, king of Holland. The colonial museum and the museum of industrial art were established in this villa by the society in 1871 and 1877, respectively. Besides these there

are a museum of ecclesiastical antiquities, chiefly relating to the bishopric of Haarlem; the old weigh-house (1598) and the orphanage for girls (1608), originally an almshouse for old men, both built by the architect Lieven de Key of Ghent.

The staple industries of Haarlem have been greatly modified in the course of time. Cloth weaving and brewing, which once flourished exceedingly, declined in the beginning of the 16th century. A century later, silk, lace and damask weaving were introduced by French refugees, and became very important industries. But about the close of the 18th century this remarkable prosperity had also come to an end, and it was not till after the Belgian revolution of 1830-1831 that Haarlem began to develop the manufactures in which it is now chiefly engaged. Cotton manufacture, dyeing, printing, bleaching, brewing, type-founding, and the manufacture of tram and railway carriages are among the more important of its industries. One of the printing establishments has the reputation of being the oldest in the Netherlands, and publishes the oldest Dutch paper, *De Oprechte Haarlemmer Courant*. Market-gardening, especially horticulture, is extensively practised in the vicinity, so that Haarlem is the seat of a large trade in Dutch bulbs, especially hyacinths, tulips, fritillaries, spiraeas and japonicas.

Haarlem, which was a prosperous place in the middle of the 12th century, received its first town charter from William II., count of Holland and king of the Romans, in 1245. It played a considerable part in the wars of Holland with the Frisians. In 1492 it was captured by the insurgent peasants of North Holland, was re-taken by the duke of Saxony, the imperial stadholder, and deprived of its privileges. In 1572 Haarlem joined the revolt of the Netherlands against Spain, but on the 13th of July 1573, after a seven months' siege, was forced to surrender to Alva's son Frederick, who exacted terrible vengeance. In 1577 it was again captured by William of Orange and permanently incorporated in the United Netherlands.

See Karl Hegel, *Siedle und Gilden* (Leipzig, 1891); Allan, *Geschiedenis en beschrijving van Haarlem* (Haarlem, 1871-1888).

HAARLEM LAKE (Dutch *Haarlemmer Meer*), a commune of the province of North Holland, constituted by the law of the 16th of July 1855. It has an area of about 46,000 acres, and its population increased from 7237 in 1860 to 16,621 in 1900. As its name indicates, the commune was formerly a lake, which is said to have been a relic of a northern arm of the Rhine which passed through the district in the time of the Romans. In 1531 the Haarlemmer Meer had an area of 6430 acres, and in its vicinity were three smaller sheets of water—the Leidsche Meer or Leiden Lake, the Spiering Meer, and the Oude Meer or Old Lake, with a united area of about 7600 acres. The four lakes were formed into one by successive inundations, whole villages disappearing in the process, and by 1647 the new Haarlem Lake had an area of about 37,000 acres, which a century later had increased to over 42,000 acres. As early as 1643 Jan Adriaanszoon Leeghwater proposed to endike and drain the lake; and similar schemes, among which those of Nikolaas Samuel Cruquius in 1742 and of Baron van Lijnden van Hemmen in 1820 are worthy of special mention, were brought forward from time to time. But it was not till a furious hurricane in November 1836 drove the waters as far as the gates of Amsterdam, and another on Christmas Day sent them in the opposite direction to submerge the streets of Leiden, that the mind of the nation was seriously turned to the matter. In August 1837 the king appointed a royal commission of inquiry; the scheme proposed by the commission received the sanction of the Second Chamber in March 1839, and in the following May the work was begun. A canal was first dug round the lake for the reception of the water and the accommodation of the great traffic which had previously been carried on. This canal was 38 m. in length, 123-146 ft. wide, and 8 ft. deep, and the earth which was taken out of it was used to build a dike from 30 to 54 yds. broad containing the lake. The area enclosed by the canal was rather more than 70 sq. m., and the average depth of the lake 13 ft. 1½ in., and as the water had no natural outfall it was calculated that probably 2000 million tons would have to be raised by mechanical means.

This amount was 200 million tons in excess of that actually discharged. Pumping by steam-engines began in 1848, and the lake was dry by the 1st of July 1852. At the first sale of the highest lands along the banks on the 16th of August 1853, about £28 per acre was paid; but the average price afterwards was less. The whole area of 42,096 acres recovered from the waters brought in 9,400,000 lorins, or about £780,000, exactly covering the cost of the enterprise; so that the actual cost to the nation was only the amount of the interest on the capital, or about £368,000. The soil is of various kinds, loam, clay, sand and peat; most of it is sufficiently fertile, though in the lower portions there are barren patches where the scanty vegetation is covered with an ochreous deposit. Mineral springs occur containing a very high percentage (3.245 grams per litre) of common salt; and in 1893 a company was formed for working them. Corn, seeds, cattle, butter and cheese are the principal produce. The roads which traverse the commune are bordered by pleasant-looking farm-houses built after the various styles of Holland, Friesland or Brabant. Hoofddorp, Venneperdorp or Niouw Vennepe, Abbenes and the vicinities of the pumping-stations are the spots where the population has clustered most thickly. The first church was built in 1855; in 1877 there were seven. In 1854 the city of Leiden laid claim to the possession of the new territory, but the courts decided in favour of the nation.

HAASE, FRIEDRICH (1827—), German actor, was born on the 1st of November 1827, in Berlin, the son of a valet to King Frederick William IV., who became his godfather. He was educated for the stage under Ludwig Tieck and made his first appearance in 1846 in Weimar, afterwards acting at Prague (1849-1851) and Karlsruhe (1852-1855). From 1860 to 1866 he played in St Petersburg, then was manager of the court theatre in Coburg, and in 1869 (and again in 1882-1883) visited the United States. He was manager of the Stadt Theater in Leipzig from 1870 to 1876, when he removed to Berlin, where he devoted his energies to the foundation and management of the Deutsches Theater. He finally retired from the stage in 1898. Haase's aristocratic appearance and elegant manner fitted him specially to play high comedy parts. His chief rôles were those of Rochefortier in the *Partie Piquet*; Richelleu; Savigny in *Der feiner Diplomat*, and der Fürst in *Der geheime Agent*. He is the author of *Ungeschminkte Briefe* and *Was ich erlebte 1846-1898* (Berlin, 1898).

See Simon, *Friedrich Haase* (Berlin, 1898).

HAASE, FRIEDRICH GOTTLIEB (1808-1867), German classical scholar, was born at Magdeburg on the 4th of January 1808. Having studied at Halle, Greifswald and Berlin, he obtained in 1834 an appointment at Schulpforta, from which he was suspended and sentenced to six years' imprisonment for identifying himself with the *Burschenschaften* (students' associations). Having been released after serving one year of his sentence, he visited Paris, and on his return in 1840 he was appointed professor at Breslau, where he remained till his death on the 16th of August 1867. He was undoubtedly one of the most successful teachers of his day in Germany, and exercised great influence upon all his pupils.

He edited several classic authors: Xenophon (*Anabasis* *revisata*, 1833); Thucydides (1840); Velleius Paterculus (1858); Seneca the philosopher (and ed., 1877, not yet superseded); and Tacitus (1855); the introduction to which is a masterpiece of Latin. His *Vorlesungen über lateinische Sprachwissenschaft* was published after his death by F. A. Eckstein and H. Peter (1874-1880). See C. Bursian, *Geschichte der klassischen Philologie in Deutschland* (1883); G. Fickert, *Friedrich Haasi memoria* (1868), with a list of works; T. Oelner in *Rübenahl* (*Schlesische Provinzialblätter*), vii. Heft 3 (Breslau, 1868).

HAAST, SIR JOHANN FRANZ JULIUS VON (1824-1887), German and British geologist, was born at Bonn on the 1st of May 1824. He received his early education partly in that town and partly in Cologne, and then entered the university at Bonn, where he made a special study of geology and mineralogy. In 1858 he started for New Zealand to report on the suitability of the colony for German emigrants. He then became acquainted with Dr von Hochstetter, and rendered assistance to him in the preliminary geological survey which von Hochstetter had under-

taken. Afterwards Dr Haast accepted offers from the governments of Nelson and Canterbury to investigate the geology of those districts, and the results of his detailed labours greatly enriched our knowledge with regard to the rocky structure, the glacial phenomena and the economic products. He discovered gold and coal in Nelson, and he carried on important researches with reference to the occurrence of *Dinornis* and other extinct wingless birds (Moas). His *Geology of the Provinces of Canterbury and Westland, N.Z.*, was published in 1879. He was the founder of the Canterbury museum at Christchurch, of which he became director, and which he endeavoured to render the finest collection in the southern hemisphere. He was surveyor-general of Canterbury from 1861 to 1871, and professor of geology at Canterbury College. He was elected F.R.S. in 1867; and he was knighted for his services at the time of the colonial exhibition in London in 1887. He died at Wellington, N.Z., on the 15th of August 1887.

HABABS (AZ-HIBBERS), a nomadic pastoral people of Hamitic stock, living in the coast region north-west of Massawa. Physically they are Beja, by language and traditions Abyssinians. They were Christians until the 19th century, but are now Mahomedans. Their sole wealth consists in cattle.

HABAKKUK, the name borne by the eighth book of the Old Testament "Minor Prophets." It occurs twice in the book itself (i. 1, iii. 1) in titles, but nowhere else in the Old Testament. The meaning of the name is uncertain. If Hebrew, it might be derived from the root *חָבַץ* (to embrace) as an intensive term of affection. It has also been connected more plausibly with an Assyrian plant name; *ḥambakku* (Delitzsch, *Assyrischer Handwörterbuch*, p. 281). The Septuagint has Ἄμβρακη. Of the person designated, no more is known than may be inferred from the writing which bears his name. Various legends are connected with him, of which the best known is given in the Apocryphal story of "Bel and the Dragon" (v. 33-39); but none of these has any historic value.¹

The book itself falls into three obvious parts, viz. (1) a dialogue between the prophet and God (i. 2-ii. 4); (2) a series of five woes pronounced on wickedness (ii. 5-ii. 20); (3) a poem describing the triumphant manifestation of God (iii.). There is considerable difficulty in regard to the interpretation of (1), on which that of (2) will turn; while (3) forms an independent section, to be considered separately.

In the dialogue, the prophet cries to God against continued violence and injustice, though it is not clear whether this is done *within* or to Israel (i. 2-4). The divine answer declares that God raises up the Chaldeans, whose formidable resources are invincible (i. 5-11). The prophet thereupon calls God's attention to the tyranny which He apparently allows to triumph, and declares his purpose to wait till an answer is given to his complaint (i. 12-ii. 2). God answers by demanding patience, and by declaring that the righteous shall live by his faithfulness (ii. 3-4).

The interpretation of this dialogue which first suggests itself is that the prophet is referring to wickedness *within* the nation, which is to be punished by the Chaldeans as a divine instrument; in the process, the tyranny of the instrument itself calls for punishment, which the prophet is bidden to await in patient fidelity. On this view of the dialogue, the subsequent woes will be pronounced against the Chaldeans, and the date assigned to the prophecy will be about 600 B.C., i.e. soon after the battle of Carchemish (605 B.C.), when the Chaldean victory over Egypt inaugurated a period of Chaldean supremacy which lasted till the Chaldeans themselves were overthrown by Cyrus in 538 B.C. Grave objections, however, confront this interpretation, as is admitted even by such recent defenders of it as Davidson and Driver. Is it likely that a prophet would begin a complaint against Chaldean tyranny (admittedly central in the prophecy) by complaining of that wickedness of his fellow-countrymen which seems partly to justify it? Are not the terms of reference in

¹ These legends are collected in Hastings, *D. B.* vol. ii. p. 272. He is the watchman of Is. xxi. 6 (cf. Hab. ii. 1); the son of the Shunammite (2 Kings iv. 16); and is miraculously lifted by his hair to carry his own dinner to Daniel in the lions' den (*supra*).

i. 2 f. and 2. 12 f. too similar for the supposition that two distinct, even contradictory, complaints are being made (cf. "wicked" and "righteous" in i. 4 and i. 13, interchanged in regard to Israel, on above theory)? And if i. 5-11 is a genuine prophecy of the raising up of the Chaldeans, whence comes that long experience of their rule required to explain the *detailed* denunciation of their tyranny? To meet the last objection, Davidson supposes i. 5-11 to be really a reference to the past, prophetic in form only, and brings down the whole section to a later period of Chaldaean rule, "hardly, one would think, before the deportation of the people under Jehoiachin in 597" (p. 40). Driver prefers to bisect the dialogue by supposing i. 2-11 to be written at an earlier period than i. 12 f. (p. 57). The other objections, however, remain, and have provoked a variety of theories from Old Testament scholars, of which three call for special notice. (1) The first of these, represented by Giesebrecht,¹ Nowack and Wellhausen, refers i. 2-4 to Chaldaean oppression of Israel, the same subject being continued in i. 12 f. Obviously, the reference to the Chaldeans as a divine instrument could not then stand in its present place, and it is accordingly regarded as a misplaced earlier prophecy. This is the minimum of critical procedure required to do justice to the facts. (2) Budde, followed by Cornill, also regards i. 2-4 as referring to the oppression of Israel by a foreign tyrant, whom, however, he holds to be Assyria. He also removes i. 5-11 from its present place, but makes it part of the divine answer, following ii. 4. On this view, the Chaldeans are the divine instrument for punishing the tyranny of the Assyrians, to whom the following woes will therefore refer. The date would fall between Josiah's reformation (621) and his death (609). This is a plausible and even attractive theory; its weakness seems to lie in the absence of any positive evidence in the prophecy itself, as is illustrated by the fact that even G. A. Smith, who follows it, suggests "Egypt from 608-605" as an alternative to Assyria (p. 124). (3) Marti (1904) abandons the attempt to explain the prophecy as a unity, and analyses it into three elements, viz. (a) The original prophecy by Habakkuk, consisting of i. 5-10, 14 f., belonging to the year 605, and representing the emergent power of the Chaldeans as a divine scourge of the faithless people; (b) Woes against the Chaldeans, presupposing not only tyrannous rule over many peoples, but the beginning of their decline and fall, and therefore of date about 540 B.C. (ii. 5-19); (c) A psalm of post-exilic origin, whose fragments, i. 2-4, 12 a, 13, ii. 1-4, have been incorporated into the present text from the margins on which they were written, its subject being the suffering of the righteous. Each of these three theories² encounters difficulties of detail; none can be said to have secured a dominant position. The great variety of views amongst competent critics is significant of the difficulty of the problem, which can hardly be regarded as yet solved; this divergence of opinion perhaps points to the impossibility of maintaining the unity of ch. i. and ii., and throws the balance of probability towards some such analysis as that of Marti, which is therefore accepted in the present article.

In regard to the poem which forms the third and closing chapter of the present book of Habakkuk, there is much more general agreement. Its most striking characteristic lies in the superscription ("A prayer of Habakkuk the prophet, set to Shigionoth"), the subscription ("For the chief musician, on my stringed instruments"), and the insertion of the musical term "Selah" in three places (v. 3, 9, 13). These liturgical notes make extremely probable the supposition that the poem has been taken from some collection like that of our present book of Psalms, probably on the ground of the authorship asserted by the superscription there attached to it. It cannot, however, be said that the poem itself supports this assertion,

¹ Followed by Peake in *The Problem of Suffering*, pp. 4 f., 151 f., to whose appendix (A) reference may be made for further details of recent criticism.

² For the less probable theories of Rothstein, Lauterburg, Happel and Peiser (amongst others), cf. Marti's *Commentary*, pp. 328 f. and 332. Stevenson (*The Expositor*, 1902) states clearly the difficulties for those who regard ch. i. as a unity. He sees two independent sections, 2-4+12-13, and 5-11+14-17.

which carries no more intrinsic weight than the Davidic titles of the Psalms. The poem begins with a prayer that God will renew the historic manifestation of the exodus, which inaugurated the national history and faith; a thunderstorm moving up from the south is then described, in which God is revealed (3-7); it is asked whether this manifestation, whose course is further described, is against nature only (8-11); the answer is given that it is for the salvation of Israel against its wicked foes (12-15); the poet describes the effect in terror upon himself (16) and declares his confidence in God, even in utter agricultural adversity (17-19). As Wellhausen says (p. 171): "The poet appears to believe that in the very act of describing enthusiastically the ancient deed of deliverance, he brings home to us the new; we are left sometimes in doubt whether he speaks of the past to suggest the new by analogy, or whether he is concerned directly with the future, and simply paints it with the colours of the past." In any case, there is nothing in this fine poem to connect it with the conception of the Chaldeans as a divine instrument. It is the nation that speaks through the poet (cf. v. 14), but at what period of its post-exilic history we have no means of inferring.

Our estimate of the theological teaching of this book will naturally be influenced by the particular critical theory which is adopted. The reduction of the book to four originally independent sections requires that the point of each be stated separately. When this is done, it will, however, be found that there is a broad unity of subject, and of natural development in its treatment, such as to some extent justifies the instinct or the judgment of those who were instrumental in effecting the combination of the separate parts. (1) The poem (iii.), though possibly latest in date,³ claims first consideration, because it avowedly moves in the circle of primitive ideas, and supplicates a divine intervention, a direct and immediate manifestation of the transcendent God. He is conceived as controlling or overcoming the forces of nature; and though an earlier mythology has supplied some of the ideas, yet, as with the opening chapters of Genesis, they are transfigured by the moral purpose which animates them, the purpose to subdue all things that could frustrate the destiny of God's anointed (v. 13). The closing verses strike that deep note of absolute dependence on God, which is the glory of the religion of the Old Testament and its chief contribution to the spirit of the Gospels. (2) The prophecy of the Chaldeans as the instruments of the divine purpose involves a different, yet related, conception of the divine providence. The philosophy of history, by which Hebrew prophets could read a deep moral significance into national disaster and turn the flank of relentless attack, became one of the most important elements in the nation's faith. If the world-powers were hard as flint in their dealings with Israel, the people of God were steeled to such moral endurance that each clash of their successive onsets kindled some new flame of devotion. Through the Chaldeans God worked a work which required centuries of life and literature to disclose its fulness (i. 5). (3) When we turn from this view of the Chaldeans to the denunciation of their tyranny in "taunt songs" (ii. 5-20), we have simply a practical application of the doctrine of divine government. God being what He is, at once moral and all-powerful, the immoral life is doomed to overthrow, whether the immorality consist in grasping rapacity, proud self-aggrandizement, cruel exaction, exulting triumph or senseless idolatry. (4) Yet, because the doom so often tarries, there arises the problem of the suffering of the innocent and the upright. How can God look down with tolerance that seems favour on so much that conflicts with His declared will and character? This is the great problem of Israel, finding its supreme expression for all time in the book of Job (*q.v.*). In that book the solution of the problem of innocent suffering lies hidden from the sufferer, even to the end, for he is not admitted with the reader to the secret of the prologue; it is the practical solution of faithfulness resting on faith which is offered to us. So here, with the principle of ii. 4, "the righteous shall live by his faithfulness." The different application of these words in the New Testament to "faith" ³ Earlier, however, than Pa, lxxvii. 17-20, which is drawn from it.

is well known (Rom. i. 17; Gal. iii. 11; Heb. x. 38) though the difference is apt to be exaggerated by those who forget how much of the element of *ἰσχυρῶς* lies in Paul's conception of *ἰσχυρῶς*. In G. A. Smith's words, "as Paul's adaptation, 'the just shall live by faith,' has become the motto of evangelical Christianity, so we may say that Habakkuk's original of it has been the motto and the fame of Judaism: 'the righteous shall live by his faithfulness.'"

The Hebrew text of this impressive and varied book is unfortunately corrupt in many places; even so cautious a critic as Driver accepts or favourably notices eighteen textual emendations in the three chapters, and suspects the text in at least seven other cases. For the interpretation of the book in detail, the English reader will find Driver's commentary (1906) the most useful.

References to earlier literature will be found in the following noteworthy studies of recent date: Davidson, "Nahum, Habakkuk and Zephaniah," in *Cambridge Bible* (1896); Nowack, *Die kleinen Propheten* (Häker) (1897); Wellhausen, *Die kleinen Propheten* (1898); G. A. Smith, "The Book of the Twelve Prophets," in *The Expositor's Bible*, vol. ii. (1898); Driver, article, "Habakkuk," in *Hastings' Dictionary of the Bible*, vol. ii. pp. 269-272 (1900); Budde, article "Habakkuk," in *Encyc. Biblica*, vol. ii., c. 1921-1928 (1901); Stevenson, "The Interpretation of Habakkuk," in *The Expositor* (1902), pp. 388-401; Peake, *The Problem of Suffering in the Old Testament* (1904), pp. 4-11 and app. A. "Recent Criticism of Habakkuk"; Marti, *Dodekapropheten* (K. H. C.) (1904); Driver, "Minor Prophets," vol. ii., in *Century Bible* (1906); Duhm, *Das Buch Habakkuk* (Text, Übersetzung und Erklärung), 1906 (regards the book as a unity belonging to the time of Alexander the Great). Max L. Margolis discusses the anonymous Greek version of Habakkuk iii. in a volume of *Old Test. and Semitic Studies: in Memory of William Rainey Harper* (Chicago, 1908). (H. W. R. *)

HABDALA (lit. "separation"), a Hebrew term chiefly appropriated to ceremonies at the conclusion of Sabbath and festivals, marking the separation between times sacred and secular. On the Saturday night the ceremony consists of three items: (a) benediction over a cup of wine (common to many other Jewish functions); (b) benediction over a lighted taper, of which possibly the origin is utilitarian, as no light might be kindled on the Sabbath day, but the rite may be symbolical; and (c) benediction over a box of sweet-smelling spices. The origin of the latter has been traced to the bowl of burning spice which in Talmudic times was introduced after each meal. But here too symbolic ideas must be taken into account. Both the light and the spices would readily fit into the conception of the Sabbath "Over-soul" of the mystics. (I. A.)

HABEAS CORPUS, in English law, a writ issued out of the High Court of Justice commanding the person to whom it is directed to bring the body of a person in his custody before that or some other court for a specified purpose.

There are various forms of the writ, of which the most famous is that known as *habeas corpus ad subjiciendum*, the well-established remedy for violation of personal liberty. From the earliest records of the English law no free man could be detained in custody except on a criminal charge or conviction or for a civil debt. That right is expressed in the Great Charter in the words: "Nullus liber homo capiatur vel imprisonetur aut dissolvatur aut ullatenus aut exuletur aut aliquo modo destruat nec super eum ibimus nec super eum mittemus, nisi per legale iudicium parium suorum, vel per legem terrae."¹ The writ is a remedial mandatory writ of right existing by the common law, i.e. it is one of the extraordinary remedies—such as *mandamus*, *certiorari* and prohibitions, which the superior courts may grant. While "of right," it is not "of course," and is granted only on application to the High Court or a judge thereof, supported by a sworn statement of facts setting up at least a probable case of illegal confinement. It is addressed to the person in whose custody another is detained, and commands him to bring his prisoner before the court immediately after the receipt of the writ, together with the day and cause of his being taken and detained, to undergo and receive (*ad subjiciendum et recipiendum*) whatsoever the court awarding the writ "may consider of concerning him in that behalf."

It is often stated that the writ is founded on the article of the Great Charter already quoted; but there are extant instances
See Hallam, *Const. Hist.* vol. i., c. vii. (12th ed.) p. 384.

of the issue of writs of *habeas corpus* before the charter. Other writs having somewhat similar effect were in use at an early date, e.g. the writ *de odio et atia*, used as early as the 12th century to prevent imprisonment on vexatious appeals of felony, and the writ of mainprise (*de manscapcione*), long obsolete if not abolished in England but which it was attempted to use in India so late as 1870. In the case of imprisonment on accusation of crime the writ issued from the court of king's bench (or from the chancery), and on its return the court judged of the legality of the imprisonment, and discharged the prisoner or admitted him to bail or remanded him to his former custody according to the result of the examination.

By the time of Charles I. the writ was fully established as the appropriate process for checking illegal imprisonment by inferior courts or by public officials. But it acquired its full and present constitutional importance by legislation.

In Darnel's case (1627) the judges held that the command of the king was a sufficient answer to a writ of *habeas corpus*. The House of Commons thereupon passed resolutions to the contrary, and after a conference with the House of Lords the measure known as the Petition of Right was passed (1627, 3 Car. I. c. i.) which, *inter alia*, recited (s. 5) that, contrary to the Great Charter and the good laws and statutes of the realm, divers of the king's subjects had of late been imprisoned without any cause shown, and when they were brought up on *habeas corpus ad subjiciendum*, and no cause was shown other than the special command of the king signified by the privy council, were nevertheless remanded to prison, and executed "that no freeman in any such manner as is before mentioned be imprisoned or detained." The Petition of Right was disregarded in Selden's case (1629), when it was successfully returned to a *habeas corpus* that Selden and others were committed by the king's special command "for notable contempts against the king and his government and for stirring up sedition against him."² This led to legislation in 1640 by which, after abolishing the Star Chamber, the right to a *habeas corpus* was given to test the legality of commitments by command or warrant of the king or the privy council.³

The reign of Charles II. was marked by further progress towards securing the freedom of the subject from wrongful imprisonment. Lord Clarendon was impeached, *inter alia*, for causing many persons to be imprisoned against law and to be conveyed in custody to places outside England. In 1668 a writ of *habeas corpus* was issued to test the legality of an imprisonment in Jersey. Though the authority of the courts had been strengthened by the Petition of Right and the act of 1640, it was still rendered insufficient by reason of the insecurity of judicial tenure, the fact that only the chancellor (a political as well as a legal officer) and the court of king's bench had undoubted right to issue the writ, and the inability or hesitation of the competent judges to issue the writ except during the legal term, which did not cover more than half the year. A series of bills was passed through the Commons between 1668 and 1675, only to be rejected by the other House. In Jenkes's case (1676) Lord Chancellor Nottingham refused to issue the writ in vacation in a case in which a man had been committed by the king in council for a speech at Guildhall, and could get neither bail nor trial. In 1679, but rather in consequence of Lord Clarendon's arbitrary proceedings⁴ than of Jenkes's case, a fresh bill was introduced which passed both Houses (it is said the upper House by the counting of one stout peer as ten) and became the famous Habeas Corpus Act of 1679 (31 Car. II. c. 2). The passing of the act was largely due to the experience and energy of Lord Shaftesbury, after whom it was for some time called. The act, while a most important landmark in the constitutional history of England, in no sense creates any right to personal freedom, but is essentially a procedure act for improving the legal mechanism by means of which that acknowledged right may be enforced.⁵

¹ Hallam, *Const. Hist.* vol. ii., c. viii. (12th ed.) p. 2.

² *Ibid.* c. ix. (12th ed.) p. 98.

³ *Ibid.* vol. iii., c. xiii. (12th ed.) p. 12.

⁴ Dicey, *Law of the Constitution* (6th ed.), p. 217.

It declares no principles and defines no rights, but is for practical purposes worth a hundred articles guaranteeing constitutional liberty.¹

In the manner characteristic of English legislation the act is limited to the particular grievances immediately in view and is limited to imprisonment for criminal or supposed criminal matters, leaving untouched imprisonment on civil process or by private persons. It recites that great delays have been used by sheriffs and gaolers in making returns of writs of *habeas corpus* directed to them; and for the prevention thereof, and the more speedy relief of all persons imprisoned for criminal or supposed criminal matters, it enacts in substance as follows: (1) When a writ of *habeas corpus* is directed to a sheriff or other person in charge of a prisoner, he must within 3, 10 or 20 days, according to the distance of the place of commitment, bring the body of his prisoner to the court, with the true cause of his detainer or imprisonment—unless the commitment was for treason or felony plainly expressed in the warrant of commitment. (2) If any person be committed for any crime—unless for treason or felony plainly expressed in the warrant—it shall be lawful for such person or persons (other than persons convicted or in execution by legal process) *in time of vacation*, to appeal to the lord chancellor as a judge, who shall issue a *habeas corpus* returnable immediately, and on the return thereof shall discharge the prisoner on giving security for his appearance before the proper court—unless the party so committed is detained upon a legal process or under a justice's warrant for a non-bailable offence. Persons neglecting for two terms to pray for a *habeas corpus* shall have none in vacation. (3) Persons set at large on *habeas corpus* shall not be recommitted for the same offence unless by the legal order and process of the court having cognizance of the case. (4) A person committed to prison for treason or felony shall, if he requires it, in the first week of the next term or the first day of the next session of oyer and terminer, be indicted in that term or session or else admitted to bail, unless it appears on affidavit that the witnesses for the crown are not ready; and if he is not indicted and tried in the second term or session after commitment, or if after trial he is acquitted, he shall be discharged from imprisonment. (5) No inhabitant of England (except persons contracting, or, after conviction for felony, electing to be transported) shall be sent prisoner to Scotland, Ireland, Jersey, &c., or any place beyond the seas. Stringent penalties are provided for offences against the act. A judge delaying *habeas corpus* forfeits £500 to the party aggrieved. Illegal imprisonment beyond seas renders the offender liable in an action by the injured party to treble costs and damages to the extent of not less than £500, besides subjecting him to the penalties of *praemunire* and to other disabilities. "The great rank of those who were likely to offend against this part of the statute was," says Hallam, "the cause of this unusual severity." Indeed as early as 1591 the judges had complained of the difficulty of enforcing the writ in the case of imprisonment at the instance of magnates of the realm. The effect of the act was to impose upon the judges under severe sanction the duty of protecting personal liberty in the case of criminal charges and of securing speedy trial upon such charges when legally framed; and the improvement of their tenure of office at the revolution, coupled with the veto put by the Bill of Rights on excessive bail, gave the judicature the independence and authority necessary to enable them to keep the executive within the law and to restrain administrative development of the scope or penalties of the criminal law; and this power of the judiciary to control the executive, coupled with the limitations on the right to set up "act of state" as an excuse for infringing individual liberty is the special characteristic of English constitutional law.

It is to be observed that neither at common law nor under the act of 1679 was the writ the appropriate remedy in the case of a person convicted either on indictment or summarily. It properly applied to persons detained before or without trial or sentence; and for convicted persons the proper remedy was by writs of

¹ Dicey, *Law of the Constitution* (6th ed.), p. 195.

error or *certiorari* to which a writ of *habeas corpus* might be used as ancillary.

As regards persons imprisoned for debt or on civil process the writ was available at common law to test the legality of the detention: but the practice in these cases is unaffected by the act of 1679, and is of no present interest, since imprisonment on civil process is almost abolished. As regards persons in private custody, e.g. persons not *sui juris* detained by those not entitled to their guardianship or lunatics, or persons kidnapped, *habeas corpus ad subjiciendum* seems not to have been the ordinary common law remedy. The appropriate writ for such cases was that known as *de homine replegiando*. The use of this writ in most if not all criminal cases was forbidden in 1553; but it was used in the 17th century in a case of kidnapping (Designy's case, 1682), and against Lord Grey for abducting his wife's sister (1682), and in the earl of Banbury's case to recover his wife (1704). The latest recorded instance of its use is Trebilcock's case (1736), in which a ward sought to free himself from the custody of his guardian.

Since that date the *habeas corpus ad subjiciendum* has been used in cases of illegal detention in private custody. In 1758 questions arose as to its application to persons in naval or military custody, including pressed men, which led to the introduction of a bill in parliament and to the consultation by the House of Lords of the judges (see Wilmot's *Opinions*, p. 77). In the same year the writ was used to release the wife of Earl Ferrers from his custody and maltreatment, and was unsuccessfully applied for by John Wilkes to get back his wife, who was separated from him by mutual agreement. But perhaps the most interesting instances of that period are the case of the negro Somerset (1771), who was released from a claim to hold him as a slave in England; and that of the Hottentot Venus (1810), where an alien woman on exhibition in England was brought before the court by Zachary Macaulay in order to ascertain whether she was detained against her will.

The experience of the 18th century disclosed defects in the procedure for obtaining liberty in cases not covered by the act of 1679. But it was not till 1816 that further legislation was passed for more effectually securing the liberty of the subject. The act of 1816 (56 Geo. III. c. 100), does not touch cases covered by the act of 1679. It enacts (1) that a writ of *habeas corpus* shall be issued in vacation time in favour of a person restrained of his liberty otherwise than for some criminal or supposed criminal matter (except persons imprisoned for debt or by civil process); (2) that though the return to the writ be good and sufficient in law, the judge shall examine into the truth of the facts set forth in such return, and if they appear doubtful the prisoner shall be bailed; (3) that the writ shall run to any port, harbour, road, creek or bay on the coast of England, although not within the body of any county. The last clause was intended to meet doubts on the applicability of *habeas corpus* in cases of illegal detention on board ship, which had been raised owing to a case of detention on a foreign ship in an English port.

It will appear from the foregoing statement that the issue and enforcement of the writ rests on the common law as strengthened by the acts of 1627, 1640, 1679 and 1816, and subject also to the regulations as to procedure contained in the *Crown Office Rules*, 1906. The effect of the statutes is to keep the courts always open for the issue of the writ. It is available to put an end to all forms of illegal detention in public or private custody. In the case of the Canadian prisoners (1830) it was used to obtain the release of persons sentenced in Canada for participating in the rebellion of 1837, who were being conveyed throughout England in custody on their way to imprisonment in another part of the empire, and it is matter of frequent experience for the courts to review the legality of commitments under the Extradition Acts and the Fugitive Offenders Act 1881, of fugitives from the justice of a foreign state or parts of the king's dominions outside the British Islands.

In times of public danger it has occasionally been thought necessary to "suspend" the Habeas Corpus Act 1679 by special and temporary legislation. This was done in 1794 (by an act

annually renewed until 1801) and again in 1817, as to persons arrested and detained by his majesty for conspiring against his person and government. The same course was adopted in Ireland in 1866 during a Fenian rising. It has been the practice to make such acts annual and to follow their expiration by an act of indemnity. In cases where martial law exists the use of the writ is *ex hypothesi* suspended during conditions amounting to a state of war within the realm or the British possession affected (e.g. the Cape Colony and Natal during the South African War), and it would seem that the acts of courts martial during the period are not the subject of review by the ordinary courts. The so-called "suspension of the Habeas Corpus Act" bears a certain similarity to what is called in Europe "suspending the constitutional guarantees" or "proclaiming a state of siege," but "is not in reality more than suspension of one particular remedy for the protection of personal freedom."

There are various other forms of the writ according to the purpose for which it is granted. Thus *habeas corpus ad respondendum* is used to bring up a prisoner confined by the process of an inferior court in order to charge him in another proceeding (civil or criminal) in the superior court or some other court. As regards civil proceedings, this form of the writ is now rarely used, owing to the abolition of arrest on mesne process and the restriction of imprisonment for debt, or in execution of a civil judgment. The right to issue the writ depends on the common law, supplemented by an act of 1802. It is occasionally used for the purpose of bringing a person in custody for debt or on a criminal charge before a criminal court to be charged in respect of a criminal proceeding; but the same result may be obtained by means of an order of a secretary of state, made under s. 11 of the Prison Act 1898, or by the written order of a court of criminal jurisdiction before which he is required to take his trial on indictment (Criminal Law Amendment Act 30 & 31 Vict. c. 35, s. 10).

Other forms are *ad satisfaciendum*; *ad faciendum et recipiendum*, to remove into a superior court proceedings under which the detainee is in custody; *ad testificandum*, where a prisoner is required as a witness, issued under an act of 1804 (s. 11), which is in practice replaced by orders under s. 11 of the Prison Act 1898 (*supra*) or the order of a judge under s. 9 of the Criminal Procedure Act 1853; and *ad deliberandum et recipias*, to authorize the transfer from one custody to another for purposes of trial, which is in practice superseded by the provisions of the Prison Acts 1865, 1871 and 1898, and the Criminal Law Amendment Act 1867 (*supra*).

The above forms are now of little or no importance; but the procedure for obtaining them and the forms of writ are included in the *Crown Office Rules* 1906.

Ireland.—The common law of Ireland as to the writs of *habeas corpus* is the same as that in England. The writ has in past times been issued from the English court of king's bench into Ireland; but does not now so issue. The acts of 1803 and 1816 already mentioned apply to Ireland. The Petition of Right is not in terms applicable to Ireland. The Habeas Corpus Act 1679 does not apply to Ireland; but its equivalent is supplied by an act of 1781-1782 of the Irish parliament (21 & 22 Geo. III. c. 11). Sec. 16 contains a provision empowering the chief governor and privy council of Ireland by a proclamation under the great seal of Ireland to suspend the act during such time only as there shall be an actual invasion or rebellion in Ireland; and it is enacted that during the currency of the proclamation no judge or justices shall bail or try any person charged with being concerned in the rebellion or invasion without an order from the lord lieutenant or lord deputy and senior of the privy council. In Ireland by an act of 1881 the Irish executive was given an absolute power of arbitrary and preventive arrest on suspicion of treason or of an act tending to interfere with the maintenance of law and order; but the warrant of arrest was made conclusive. This act continued by annual renewals until 1906, when it expired.

Scotland.—The writ of *habeas corpus* is unknown to Scots law, nor will it issue from English courts into Scotland. Under a Scots act of 1701 (c. 6) provision is made for preventing wrongous imprisonment and against undue delay in trials. It was applied to treason felony in 1848. The right to speedy trial is now regulated by s. 43 of the Criminal Procedure Scotland Act 1887. These enactments are as to Scotland equivalent to the English Act of 1679. Under the Court of Exchequer Scotland Act 1856 (19 & 20 V. c. 56) provision is made for bringing before the court of session persons and proceedings before inferior courts and public officers—which is analogous to the powers to issue *habeas corpus* in such cases out of the English court of exchequer (now the revenue side of the king's bench division).

British Possessions.—The act of 1679 expressly applies to Wales, Berwick-on-Tweed, Jersey and Guernsey, and the act of 1816 also extends to the Isle of Man. The court of king's bench has also issued the writ to the king's foreign dominions beyond seas, e.g. to St Helena, and so late as 1861 to Canada (Anderson's case 1861, 30 L.J.Q.B. 129). In consequence of the last decision it was provided

by the Habeas Corpus Act 1862 that no writ of *habeas corpus* should issue out of England by authority of any court or judge "into any colony or foreign dominion of the crown where the crown has a lawfully established court of justice having authority to grant or issue the writ and to ensure its due execution in the 'colony' or dominion" (25 & 26 V. c. 20). The expression "foreign dominion" is meant to apply to places outside the British Islands, and does not include the Isle of Man or the Channel Islands (see *re Brown* [1864], 33 L.J.Q.B. 193).

In Australasia and Canada and in most if not all the British possessions whose law is based on the common law, the power to issue and enforce the writ is possessed and is freely exercised by colonial courts, under the charters or statutes creating and regulating the courts. The writ is freely resorted to in Canada, and in 1905, 1906, two appeals came to the privy council from the dominion, one with reference to an extradition case, the other with respect to the right to expel aliens.

Under the Roman-Dutch law as applied in British Guiana the writ was unknown and no similar process existed (2nd report of West Indian law commissioners). But by the Supreme Court Ordinance of 1893 that court possesses (*inter alia*) all the authorities, powers and functions belonging to or incident to a superior court of record in England, which appears to include the power to issue the writ of *habeas corpus*. Under the Roman-Dutch law as applied to South Africa free persons appear to have a right to release under a writ *de libero homine exhibendo*, which closely resembles the writ of *habeas corpus*, and the procedure described as "manifestation" used in the kingdom of Aragon (Hallam, *Middle Ages*, vol. ii., c. iv.). The writ of *habeas corpus* has not been formally adopted or the Habeas Corpus Acts formally extended to South Africa; but in the Cape Colony, under the charter of justice and colonial legislation, the supreme court on petition grants a remedy equivalent to that obtained in England by writ of *habeas corpus*; and the remedy is sometimes so described (*Koko v. Batis*, 1879, 9 Buchanan, 45, 64, arising out of a rising in Griqualand). During and after the South African War of 1899-1902 many attempts were made by this procedure to challenge or review the sentences of courts martial; see *re Fourie* (1900), 18 Cape Rep. 8.

The laws of Ceylon being derived from the Roman-Dutch law, the writ of *habeas corpus* is not indigenous; but, under s. 49 of the Supreme Court Ordinance 1889, the court or a judge has power to grant and issue "mandates in the nature of writs of *habeas corpus*." The chartered high courts in India have power to issue and enforce the writ of *habeas corpus*. The earliest record of its use was in 1775, when it was directed to Warren Hastings. It has been used to test the question whether Roman Catholic religious orders could enter India, and in 1870 an attempt was made thereby to challenge the validity of a warrant in the nature of a *lettre de cachet* issued by the viceroy (Ind. L. Rep. 6 Bengal, 392, 456, 498), and it has also been applied to settle controversies between Hindus and missionaries as to the custody of a young convert (*R. v. Vasulkar*, 1870, 5 Bengal, 418), and between a Mahomedan husband and his mother-in-law as to the custody of a girl-wife (*Khatija Bibi*, 1870, 5 Bengal, 557).

United States.—Before the Declaration of Independence some of the North American colonies had adopted the act of 1679; and the federal and the other state legislatures of the United States have founded their procedure on that act. The common law as to the writ of *habeas corpus* has been inherited from England, and has been generally made to apply to commitments and detentions of all kinds. Difficult questions, unknown to English law, have arisen from the peculiar features of the American state-system. Thus the constitution provides that "the privilege of the writ of *habeas corpus* shall not be suspended unless when, in cases of rebellion or invasion, the public safety may require it"; and it has been the subject of much dispute whether the power of suspension under this provision is vested in the president or the congress. The weight of opinion seems to lean to the latter alternative. Again, conflicts have arisen between the courts of individual states and the courts of the union. It seems that a state court has no right to issue a *habeas corpus* for the discharge of a person held under the authority of the federal government. On the other hand, the courts of the union issue the writ only in those cases in which the power is expressly conferred on them by the constitution.

AUTHORITIES.—Paterson, *Liberty of the Subject* (1877); Short and Mellor, *Crown Practice* (1890); American: Church on *Habeas Corpus* (2nd ed. 1893).

HABERDASHER, a name for a tradesman who sells by retail small articles used in the making or wearing of dress, such as sewing cottons or silks, tapes, buttons, pins and needles and the like. The sale of such articles is not generally carried on alone, and a "haberdashery counter" usually forms a department of

drapers' shops. The word, found in Chaucer, and even earlier (1311), is of obscure origin; the suggestion that it is connected with an Icelandic *hapriask*, "haversack," is, according to the *New English Dictionary*, impossible. *Hapertas* occurs in an early Anglo-French customs list, which includes articles such as were sold by haberdashers, but this word may itself have been a misspelling of "haberdash." The obscurity of origin has left room for many conjectures such as that of Minsheu that "haberdasher" was perhaps merely a corruption of the German *Habt ihr das?* "Have you that?" or *Habe das, Herr*, "Have that, sir," used descriptively for a general dealer in miscellaneous wares. The Haberdashers' Company is one of the greater Livery Companies of the City of London. Originally a branch of the mercers, the fraternity took over the selling of "small wares," which included not only articles similar to those sold as "haberdashery" now, but such things as gloves, daggers, glass, pens, lanterns, mousetraps and the like. They were thus on this side connected with the Milliners. On the other hand there was early a fusion with the old guild of the "Hurers," or cap makers, and the hatters, and by the reign of Henry VII. the amalgamation was complete. There were long recognized two branches of the haberdashers, the haberdashers of "small wares," and the haberdashers of hats (see further LIVERY COMPANIES). The haberdashers are named, side by side with the *capellarii*, in the White Book (*Liber Albus*) of the city of London (see *Munimenta Gildhallae Londiniensis*, ed. H. T. Riley, Rolls Series, 12, 1850-1862), and a haberdasher forms one of the company of pilgrims in the *Canterbury Tales* (Prologue, 361).

HABINGTON, WILLIAM (1605-1654), English poet, was born at Hendlip Hall, Worcestershire, on the 4th of November 1605. He belonged to a well-known Catholic family. His father, Thomas Habington (1560-1647), an antiquary and historical scholar, had been implicated in the plots on behalf of Mary queen of Scots; his uncle, Edward Habington, was hanged in 1586 on the charge of conspiring against Elizabeth in connexion with Anthony Babington; while to his mother, Mary Habington, was attributed the revelation of the Gunpowder Plot. The poet was sent to the college at St Omer, but, pressure being brought to bear on him to induce him to become a Jesuit, he removed to Paris. He married about 1632 Lucy, second daughter of Sir William Herbert, first Baron Powys. This lady he had addressed in the volume of lyrical poems arranged in two parts and entitled *Castara*, published anonymously in 1634. In 1635 appeared a second edition enlarged by three prose characters, fourteen new lyrics and eight touching elegies on his friend and kinsman, George Talbot. The third edition (1640) contains a third part consisting of a prose character of "A Holy Man" and twenty-two devotional poems. Habington's lyrics are full of the far-fetched "conceits" which were fashionable at court, but his verse is quite free from the prevailing looseness of morals. Indeed his reiterated praises of *Castara's* virtue grow wearisome. He is at his best in his reflective poems on the uncertainty of human life and kindred topics. He also wrote a *Historie of Edward the Fourth* (1640), based on notes provided by his father; a tragi-comedy, *The Queene of Arragon* (1640), published without his consent by his kinsman, the earl of Pembroke, and revived at the Restoration; and six essays on events in modern history, *Observations upon History* (1641). Anthony à Wood insinuated that during the Commonwealth the poet "did run with the times, and was not unknown to Oliver the usurper." He died on the 30th of November 1654.

The works of Habington have not been collected. *The Queene of Arragon* was reprinted in Dodsley's "Old Plays," vol. ix. (1825); *Castara* was edited by Charles Elton (1812), and by E. Arber with a compact and comprehensive introduction (1870) for his "English Reprints."

HABIT (through the French from Lat. *habitus*, from *habere*, to have, hold, or, in a reflective sense, to be in a certain condition; in many of the English senses the French use *habitude*, not *habit*), condition of body or mind, especially one that has become permanent or settled by custom or persistent repetition, hence custom, usage. In botany and zoology the term is used both in the above sense of instinctive action of animals and tendencies

of plants, and also of the manner of growth or external appearance of a plant or animal. From the use of the word for external appearances comes its use for fashion in dress, and hence as a term for a lady's riding dress and for the particular form of garment adopted by the members of a religious order, like "cowl" applied as the mark of a monk or nun.

HABITAT (a French word derived from *habiter*, Lat. *habitare*, to dwell), in botany and zoology, the term for the locality in which a particular species of plants or animals thrives.

HABSBERG, or **HARSBURG**, the name of the famous family from which have sprung the dukes and archdukes of Austria from 1282, kings of Hungary and Bohemia from 1526, and emperors of Austria from 1804. They were also Roman emperors and German kings from 1438 to 1806, and kings of Spain from 1516 to 1700, while the minor dignities held by them at different times are too numerous to mention.

The name Habsburg, a variant of an older form, Habichtsburg (hawk's castle), was taken from the castle of Habsburg, which was situated on the river Aar not far from its junction with the Rhine. The castle was built about 1020 by Werner, bishop of Strassburg, and his brother, Radbot, the founder of the abbey of Muri. These men were grandsons of a certain Guntram, who, according to some authorities, is identical with a Count Guntram who flourished during the reign of the emperor Otto the Great, and whose ancestry can be traced back to the time of the Merovingian kings. This conjecture, however, is extremely problematical. Among Radbot's sons was one Werner, and Werner and his son Otto were called counts of Habsburg, Otto being probably made landgrave of upper Alsace late in the 11th or early in the 12th century. At all events Otto's son Werner (d. 1167), and the latter's son Albert (d. 1199), held this dignity, and both landgraves increased the area of the Habsburg lands. Albert became count of Zürich and protector of the monastery of Säckingen, and obtained lands in the cantons of Unterwalden and Lucerne; his son Rudolph, having assisted Frederick of Hohenstaufen, afterwards the emperor Frederick II., against the emperor Otto IV., received the county of Aargau. Both counts largely increased their possessions in the districts now known as Switzerland and Alsace, and Rudolph held an influential place among the Swabian nobility. After his death in 1232 his two sons, Albert and Rudolph, divided his lands and founded the lines of Habsburg-Habsburg and Habsburg-Laufenburg. Rudolph's descendants, counts of Habsburg-Laufenburg, were soon divided into two branches, one of which became extinct in 1408 and the other seven years later. Before this date, however, Laufenburg and some other districts had been sold to the senior branch of the family, who thus managed to retain the greater part of the Habsburg lands.

Rudolph's brother Albert (d. 1239), landgrave of Alsace, married Hedwig of Kyburg (d. 1260), and from this union there was born in 1218 Rudolph, the founder of the greatness of the house of Habsburg, and the first of the family to ascend the German throne. Through his mother he inherited a large part of the lands of the extinct family of Zähringen; he added in other ways to his possessions, and was chosen German king in September 1273. Acting vigorously in his new office, he defeated and killed his most formidable adversary, Ottakar II., king of Bohemia, in 1278, and in December 1282 he invested his sons, Albert and Rudolph, with the duchies of Austria and Styria, which with other lands had been taken from Ottakar. This was an event of supreme moment in the history of the Habsburgs, and was the first and most important stage in the process of transferring the centre of their authority from western to eastern Europe, from the Rhine to the Danube. On Rudolph's death in July 1291 the German crown passed for a time away from the Habsburgs, but in July 1298 it was secured by his son, Albert, whose reign, however, was short and uneventful. But before 1308, the year of Albert's death; the long and troubled connexion of the Habsburgs with Bohemia had already begun. In 1306 Wenceslas III., the last Bohemian king of the Přemyslide dynasty, was murdered. Seizing the opportunity and declaring that the vacant kingdom was an imperial fief, King Albert

bestowed it upon his eldest son, Rudolph, and married this prince to Elizabeth, widow of Wenceslas II. and stepmother of Wenceslas III. But Rudolph died in 1307, and his father's attempt to keep the country in his own hands was ended by his murder in 1308.

Albert's successor as German king was Henry of Luxemburg (the emperor Henry VII.), and this election may be said to initiate the long rivalry between the houses of Habsburg and Luxemburg. But the immediate enemy of the Habsburgs was not a Luxemburg but a Wittelsbach. Without making any definite partition, Albert's five remaining sons spent their time in governing their lands until 1314, when one of them, Frederick called the Fair, forsook this comparatively uneventful occupation and was chosen by a minority of the electors German king in succession to Henry VII. At the same time the Wittelsbach duke of Bavaria, Louis, known to history as the emperor Louis the Bavarian, was also chosen. War was inevitable, and the battle of Mühldorf, fought in September 1322, sealed the fate of Frederick. Louis was victorious: his rival went into an honourable captivity, and the rising Habsburg sun underwent a temporary eclipse.

For more than a century after Frederick's death in 1330 the Habsburgs were exiles from the German throne. But they were not inactive. In 1335 his two surviving brothers, Albert and Otto, inherited Carinthia and part of Carniola by right of their mother, Elizabeth; in 1363 Albert's son Rudolph received Tirol; and during the same century part of Istria, Trieste and other districts were acquired. All King Albert's six sons had died without leaving male issue save Otto, whose family became extinct in 1344, and Albert, the ancestor of all the later Habsburgs. Of Albert's four sons two also left no male heirs, but the remaining two, Albert III. and Leopold III., were responsible for a division of the family which is of some importance. By virtue of a partition made upon their brother Rudolph's death in 1365 Albert and his descendants ruled over Austria, while Leopold and his sons took Styria, Carinthia and Tirol, Alsace remaining undivided as heretofore.

Towards the middle of the 15th century the German throne had been occupied for nearly a hundred years by members of the Luxemburg family. The reigning emperor Sigismund, who was also king of Hungary and Bohemia, was without sons, and his daughter Elizabeth was the wife of Albert of Habsburg, the grandson and heir of Duke Albert III., who had died in 1395. Sigismund died in December 1437, leaving his two kingdoms to his son-in-law, who was crowned king of Hungary in January 1438 and king of Bohemia in the following June. Albert was also chosen and crowned German king in succession to Sigismund, thus beginning the long and uninterrupted connexion of his family with the imperial throne, a connexion which lasted until the dissolution of the Holy Roman Empire in 1806. He did not, however, enjoy his new dignities for long, as he died in October 1439 while engaged in a struggle with the Turks. Albert left no sons, but soon after his death one was born to him, called Ladislaus, who became duke of Austria and king of Hungary and Bohemia. Under the guardianship of his kinsman, the emperor Frederick III., the young prince's reign was a troubled one, and when he died unmarried in 1457 his branch of the family became extinct, and Hungary and Bohemia passed away from the Habsburgs, who managed, however, to retain Austria.

Leopold III., duke of Carinthia and Styria, who was killed in 1386 at the battle of Sempach, had four sons, of whom two only, Frederick and Ernest, left male issue. Frederick and his only son, Sigismund, confined their attention mainly to Tirol and Alsace, leaving the larger destinies of the family in the hands of Ernest of Carinthia and Styria (d. 1424) and his sons, Frederick and Albert and after the death of King Ladislaus in 1457 these two princes and their cousin Sigismund were the only representatives of the Habsburgs. In February 1440 Frederick of Styria was chosen German king in succession to his kinsman Albert. He was a weak and incompetent ruler, but a stronger and abler man might have shrunk from the task of administering his heterogeneous and unruly realm. Although very important

in the history of the house of Habsburg, Frederick's long reign was a period of misfortune, and the motto which he assumed, A.E.I.O.U. (*Austriae est imperare orbi universo*), seemed at the time a particularly foolish boast. He acted as guardian both to Ladislaus of Hungary, Bohemia and Austria, and to Sigismund of Tirol, and in all these countries his difficulties were increased by the hostility of his brother Albert. Having disgusted the Tirolese he gave up the guardianship of their prince in 1446, while in Hungary and Bohemia he did absolutely nothing to establish the authority of his ward; in 1452 the Austrians besieged him in Vienna Neustadt and compelled him to surrender the person of Ladislaus, thus ending even his nominal authority. When the young king died in 1457 the Habsburgs lost Hungary and Bohemia, but they retained Austria, which, after some disputing, Frederick and Albert divided between themselves, the former taking lower and the latter upper Austria. This arrangement was of short duration. In 1461 Albert made war upon his brother and forced him to resign lower Austria, which, however, he recovered after Albert's death in December 1463. Still more unfortunate was the German king in Switzerland. For many years the Swiss had chafed under the rule of the Habsburgs; during the reign of Rudolph I. they had shown signs of resentment as the kingly power increased; and the struggle which had been carried on for nearly two centuries had been almost uniformly in their favour. It was marked by the victory of Morgarten over Duke Leopold I. in 1315, and by that of Sempach over Leopold III. in 1386, by the conquest of Aargau at the instigation of the emperor Sigismund early in the 15th century, and by the final struggle for freedom against Frederick III. and Sigismund of Tirol. Taking advantage of some dissensions among the Swiss, the king saw an opportunity to recover his lost lands, and in 1443 war broke out. But his allies, the men of Zürich, were defeated, and when in August 1444 some French mercenaries, who had advanced to his aid, suffered the same fate at St Jakob, he was compelled to give up the struggle. A few years later Sigismund became involved in a war with the same formidable foe; he too was worsted, and the "Perpetual Peace" of 1474 ended the rule of the Habsburgs in Switzerland. This humiliation was the second great step in the process of removing the Habsburgs from western to eastern Europe. In 1453, just after his coronation as emperor at Rome, Frederick legalized the use of the title archduke, which had been claimed spasmodically by the Habsburgs since 1361. This title is now peculiar to the house of Habsburg.

The reverses suffered by the Habsburgs during the reign of Frederick III. were many and serious, but an improvement was at hand. The emperor died in August 1493, and was followed on the imperial throne by his son Maximilian I., perhaps the most versatile and interesting member of the family. Before his father's death Maximilian had been chosen German king, or king of the Romans, and had begun to repair the fortunes of his house. He had married Mary, daughter and heiress of Charles the Bold, duke of Burgundy; he had driven the Hungarians from Vienna and the Austrian archduchies, which Frederick had, perforce, allowed them to occupy; and he had received Tirol on the abdication of Sigismund in 1490. True it is that upon Mary's death in 1482 part of her inheritance, the rich and prosperous Netherlands, held that her husband's authority was at an end, while another part, the two Burgundies and Artois, had been seized by the king of France; nevertheless, after a protracted struggle the German king secured almost the whole of Charles the Bold's lands for his son, the archduke Philip, the duchy of Burgundy alone remaining in the power of France after the conclusion of the peace of Senlis in 1493. Maximilian completed his work by adding a piece of Bavaria, Görz and then Gradiska to the Habsburg lands.

After Sigismund's death in 1496 Maximilian and Philip were the only living male members of the family. Philip married Joanna, daughter of Ferdinand and Isabella of Spain, and died in 1506 leaving two sons, Charles and Ferdinand. Charles succeeded his father in the Netherlands; he followed one grand-father, Ferdinand, as king of Spain in 1516, and when the other,

Maximilian, died in 1519 he became the emperor Charles V., and succeeded to all the hereditary lands of the Habsburgs. But provision had to be made for Ferdinand, and in 1521 this prince was given the Austrian archduchies, Austria, Styria, Carinthia and Carniola; in the same year he married Anne, daughter of Wladislaus, king of Hungary and Bohemia, and when his childless brother-in-law, King Louis, was killed at the battle of Mohacs in August 1526 he claimed the two kingdoms, both by right of his wife and by treaty. After a little trouble Bohemia passed under his rule, but Hungary was more recalcitrant. A long war took place between Ferdinand and John Zapolya, who was also crowned king of Hungary, but in 1538 a treaty was made and the country was divided, the Habsburg prince receiving the western and smaller portion. However, he was soon confronted with a more formidable foe, and he spent a large part of his subsequent life in defending his lands from the attacks of the Turks.

The Habsburgs had now reached the summit of their power. The prestige which belonged to Charles as head of the Holy Roman Empire was backed by the wealth and commerce of the Netherlands and of Spain, and by the riches of the Spanish colonies in America. In Italy he ruled over Sardinia, Naples and Sicily, which had passed to him with Spain, and the duchy of Milan, which he had annexed in 1535; to the Netherlands he had added Friesland, the bishopric of Utrecht, Gröningen and Gelderland, and he still possessed Franche-Comté and the fragments of the Habsburg lands in Alsace and the neighbourhood. Add to this Ferdinand's inheritance, the Austrian archduchies and Tirol, Bohemia with her dependent provinces, and a strip of Hungary, and the two brothers had under their sway a part of Europe the extent of which was great, but the wealth and importance of which were immeasurably greater. Able to scorn the rivalry of the other princely houses of Germany, the Habsburgs saw in the kings of the house of Valois the only foemen worthy of their regard.

When Charles V. abdicated he was succeeded as emperor, not by his son Philip, but by his brother Ferdinand. Philip became king of Spain, ruling also the Netherlands, Franche-Comté, Naples, Sicily, Milan and Sardinia, and the family was definitely divided into the Spanish and Austrian branches. For Spain and the Spanish Habsburgs the 17th century was a period of loss and decay, the seeds of which were sown during the reign of Philip II. The northern provinces of the Netherlands were lost practically in 1609 and definitely by the treaty of Westphalia in 1648; Roussillon and Artois were annexed to France by the treaty of the Pyrenees in 1659, while Franche-Comté and a number of towns in the Spanish Netherlands suffered a similar fate by the treaty of Nijmegen in 1678. Finally Charles II., the last Habsburg king of Spain, died childless in November 1700, and his lands were the prize of the War of the Spanish Succession. The Austrian Habsburgs fought long and valiantly for the kingdom of their kinsman, but Louis XIV. was too strong for them, and by the peace of Rastatt Spain passed from the Habsburgs to the Bourbons. However, the Austrian branch of the family received in 1714 the Italian possessions of Charles II., except Sicily, which was given to the duke of Savoy, and also the southern Netherlands, which are thus often referred to as the Austrian Netherlands; and retained the duchy of Mantua, which it had seized in 1708.

Ferdinand I., the founder of the line of the Austrian Habsburgs, arranged a division of his lands among his three sons before his death in 1564. The eldest, Maximilian II., received Austria, Bohemia and Hungary, and succeeded his father as emperor; he married Maria, a daughter of Charles V., and though he had a large family his male line became extinct in 1619. The younger sons were Ferdinand, ruler of Tirol, and Charles, archduke of Styria. The emperor Maximilian II. left five sons, two of whom, Rudolph and Matthias, succeeded in turn to the imperial throne, but, as all the brothers were without male issue, the family was early in the 17th century threatened with a serious crisis. Rudolph died in 1612, the reigning emperor Matthias was old and ill, and the question of the succession to

the Empire, to the kingdoms of Hungary and Bohemia, and to the hereditary lands of the Habsburgs became acute. Turning to the collateral branches of the family, the sons of the archduke Ferdinand were debarred from the succession owing to their father's morganatic marriage with Philippine Welser, and the only hope of the house was in the sons of Charles of Styria. To prevent the Habsburg monarchy from falling to pieces the emperor's two surviving brothers renounced their rights, and it was decided that Ferdinand, a son of Charles of Styria, should succeed his cousin Matthias. The difficulties which impeded the completion of this scheme were gradually overcome, and the result was that when Matthias died in 1619 the whole of the lands of the Austrian Habsburgs was united under the rule of the emperor Ferdinand II. Tirol, indeed, a few years later was separated from the rest of the monarchy and given to the emperor's brother, the archduke Leopold, but this separation was ended when Leopold's son died in 1665.

The arbitrary measures which followed Ferdinand's acquisition of the Bohemian crown contributed to the outbreak of the Thirty Years' War, but in a short time the Bohemians were subdued, and in 1627, following a precedent set in 1547, the emperor declared the throne hereditary in the house of Habsburg. The treaty of Westphalia which ended this war took comparatively little from the Habsburgs, though they ceded Alsace to France; but the Empire was greatly weakened, and its ruler was more than ever compelled to make his hereditary lands in the east of Europe the base of his authority, finding that he derived more strength from his position as archduke of Austria than from that of emperor. Ferdinand III. succeeded his father Ferdinand II., and during the long reign of the former's son, Leopold I., the Austrian, like the Spanish, Habsburgs were on the defensive against the aggressive policy of Louis XIV., and in addition they had to withstand the assaults of the Turks. In two ways they sought to strengthen their position. The unity of the Austrian lands was strictly maintained, and several marriages kept up a close and friendly connexion with Spain. A series of victories over the sultan during the later part of the 17th century rolled back the tide of the Turkish advance, and the peace of Karlowitz made in 1699 gave nearly the whole of Hungary to the Habsburgs. Against France Austria was less successful, and a number of humiliations culminated in 1714 in the failure to secure Spain, to which reference has already been made.

The hostility of Austria and France, or rather of Habsburg and Bourbon, outlived the War of the Spanish Succession. In 1717 Spain conquered Sardinia, which was soon exchanged by Austria for Sicily; other struggles and other groupings of the European powers followed, and in 1735, by the treaty of Vienna, Austria gave up Naples and Sicily and received the duchies of Parma and Piacenza. These surrenders were doubtless inevitable, but they shook the position of the house of Habsburg in Italy. However, a domestic crisis was approaching which threw Italian affairs into the shade. Charles VI., who had succeeded his brother, Joseph I., as emperor in 1711, was without sons, and his prime object in life was to secure the succession of his elder daughter, Maria Theresa, to the whole of his lands and dignities. But in 1713, four years before the birth of Maria Theresa, he had first issued the famous *Pragmatic Sanction*, which declared that the Habsburg monarchy was indivisible and that in default of male heirs a female could succeed to it. Then after the death of his only son and the birth of Maria Theresa the emperor bent all his energies to securing the acceptance of the Pragmatic Sanction. Promulgated anew in 1724, it was formally accepted by the estates of the different Habsburg lands; in 1731 it was guaranteed by the imperial diet. By subordinating every other interest to this, Charles at length procured the assent of the various powers of Europe to the proposed arrangement; he married the young princess to Francis Stephen, duke of Lorraine, afterwards grand-duke of Tuscany, and when he died on the 20th of October 1740 he appeared to have realized his great ambition. With the emperor's death the house of Habsburg, strictly speaking, became extinct, its place being taken by the house of Habsburg-Lorraine, which sprang from the union of

GENEALOGICAL TABLE OF THE HOUSE OF HABSBURG-LORRAINE.

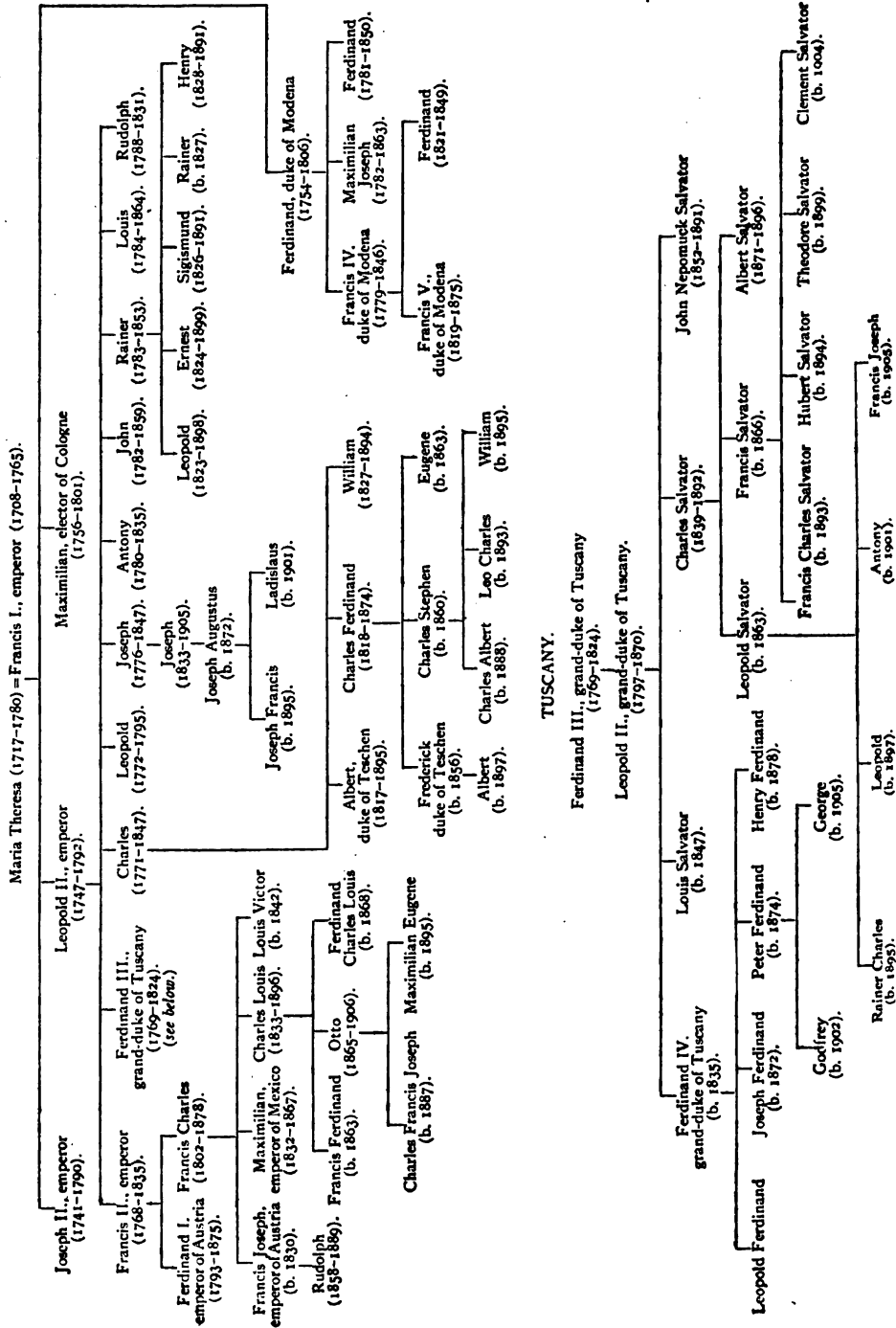

Maria Theresa and Francis Stephen; and it is interesting to note that the present Habsburgs are only descended in the female line from Rudolph I. and Maximilian I.

Immediately after the death of Charles the Pragmatic Sanction was forgotten. A crowd of claimants called for various parts of the Habsburg lands; Frederick the Great, talking less but acting more, invaded and conquered Silesia, and it seemed likely that the dissolution of the Habsburg monarchy would at no long interval follow the extinction of the Habsburg race. A Wittelsbach prince, Charles Albert, elector of Bavaria, the emperor Charles VII., and not Francis Stephen, was chosen emperor in January 1742, and by the treaty of Breslau, made later in the same year, nearly all Silesia was formally surrendered to Prussia. But the worst was now over, and when in 1748 the peace of Aix-la-Chapelle, which practically confirmed the treaty of Breslau, had cleared away the dust of war, Maria Theresa and her consort were found to occupy a strong position in Europe. In the first place, in September 1745, Francis had been chosen emperor; then the imperial pair ruled Hungary and Bohemia, although the latter kingdom was shorn of Silesia; in spite of French conquests the Austrian Netherlands remained in their hands; and in Italy Francis had added Tuscany to his wife's heritage, although Parma and Piacenza had been surrendered to Spain and part of Milan to the king of Sardinia. The diplomatic *volte-face* and the futile attempts of Maria Theresa to recover Silesia which followed this treaty belong to the general history of Europe.

The emperor Francis I. died in 1765 and was succeeded by his son Joseph II., an ambitious and able prince, whose aim was to restore the Habsburgs and the Empire to their former great positions in Europe, and whose pride did not prevent him from learning from Frederick the Great, the despoiler of his house. His projects, however, including one of uniting Bavaria with Austria, which was especially cherished, failed completely, and when he died in February 1790 he left his lands in a state of turbulence which reflected the general condition of Europe. The Netherlands had risen against the Austrians, and in January 1790 had declared themselves independent; Hungary, angered by Joseph's despotic measures, was in revolt, and the other parts of the monarchy were hardly more contented. But the 18th century saw a few successes for the Habsburgs. In 1718 a successful war with Turkey was ended by the peace of Passarowitz, which advanced the Austrian boundary very considerably to the east, and although by the treaty of Belgrade, signed twenty-one years later, a large part of this territory was surrendered, yet a residuum, the banate of Temesvar, was permanently incorporated with Hungary. The struggle over the succession to Bavaria, which was concluded in 1779 by the treaty of Teschen, was responsible for adding Innviertel, or the quarter of the Inn, to Austria; the first partition of Poland brought eastern Galicia and Lodomeria, and in 1777 the sultan ceded Bukovina. Joseph II. was followed by his brother, Leopold II., who restored the Austrian authority in the Netherlands, and the latter by his son Francis II., who resigned the crown of the Holy Roman Empire in August 1806, having two years before taken the title of emperor of Austria as Francis I.

Before the abdication of the emperor Francis in 1806 Austria had met and suffered from the fury of revolutionary France, but the cessions of territory made by her at the treaties of Campo Formio (1797), of Lunéville (1801) and of Presburg (1805) were of no enduring importance. This, however, cannot be said for the treaties of Paris and of Vienna, which in 1814 and 1815 arranged the map of Europe upon the conclusion of the Napoleonic wars. These were highly favourable to the Habsburgs. In eastern and central Europe Austria regained her former position, the lands ceded to Bavaria and also eastern Galicia, which had been in the hands of Russia since 1800, being restored; she gave up the Austrian Netherlands, soon to be known as Belgium, to the new kingdom of the Netherlands, and acquiesced in the arrangement which had taken from her the Breisgau and the remnant of the Habsburg lands upon the Rhine. In return for these losses Austria became the dominant

power in Italy. A mass of northern Italy, including her former possessions in Milan and the neighbourhood, and also the lands recently forming the republic of Venice, was made into the kingdom of Lombardy-Venetia, and this owned the emperor of Austria as king. Across the Adriatic Dalmatia was added to the Habsburg monarchy, the population of which, it has been estimated, was increased at this time by over four millions.

The illiberal and oppressive character of the Austrian rule in Italy made it very unpopular; it was hardly less so in Hungary and Bohemia, and the advent of the year 1848 found the subject kingdoms eager to throw off the Habsburg yoke. The whole monarchy was quickly in a state of revolution, in the midst of which the emperor Ferdinand, who had succeeded his father Francis in 1835, abdicated, and his place was taken by his young nephew Francis Joseph. The position of the Habsburg monarchy now seemed desperate. But it was strong in its immemorial tradition, which was enough to make the efforts of the Frankfurt parliament to establish German unity under Prussian hegemony abortive; it was strong also in the general loyalty to the throne of the imperial army; and its counsels were directed by statesmen who knew well how to exploit in the interests of the central power the national rivalries within the monarchy. With the crushing of the Hungarian revolt by the emperor Nicholas I. of Russia in 1849 the monarchy was freed from the most formidable of its internal troubles; in 1850 the convention of Olmütz restored its influence in Germany.

Though the *status quo* was thus outwardly re-established, the revolutions of 1848 had really unchained forces which made its maintenance impossible. In Germany Prussia was steadily preparing for the inevitable struggle with Austria for the mastery; in France Napoleon III. was preparing to pose as the champion of the oppressed nationalities which had once more settled down sullenly under the Habsburg yoke. The alliance of the French emperor and the king of Sardinia, and the Italian war of 1859 ended in the loss of Lombardy to the Habsburgs. Seven years later the crushing defeat of Königgrätz not only ended their long rule in Italy, based on the tradition of the medieval empire, by leading to the cession of Venetia to the new Italian kingdom, but led to their final exclusion from the German confederation, soon to become, under the headship of Prussia, the German empire.

By the loss of the predominance in Germany conceded to it by the treaties of Vienna, and by the shifting of its "centre of gravity" eastward, the Habsburg monarchy, however, perhaps gained more than it lost. One necessary result, indeed, was the composition (*Ausgleich*) with Hungary in 1867, by which the latter became an independent state (Francis Joseph being crowned king at Pest in June 1867) bound to the rest of the monarchy only by the machinery necessary for the carrying out of a common policy in matters of common interest. This at least restored the loyalty of the Hungarians to the Habsburg dynasty; it is too soon yet to say that it secured permanently the essential unity of the Habsburg monarchy. By the system of the Dual Monarchy the rest of the Austrian emperor's dominions (Cis-Leithan) were consolidated under a single central government, the history of which has been mainly that of the rival races within the empire struggling for political predominance. Since the development of the constitution has been consistently in a democratic direction and the Slavs are in a great majority, the tendency has been for the German element—strong in its social status and tradition of predominance—to be swamped by what it regards as an inferior race; and a considerable number of Austrian "Germans" have learned to look not to their Habsburg rulers, but to the power of the German empire for political salvation. The tendency eastwards of the monarchy was increased when in 1878 the congress of Berlin placed Bosnia and Herzegovina under Austrian rule. Old ambitions were now revived at the expense of the Ottoman empire, the goal of which was the port of Salonica; and not the least menacing aspect of the question of the near East has been that the rivalry of Italy and the Habsburg monarchy has been transferred to the Balkan peninsula. Yet, in spite of internal

dissensions arising out of questions fundamentally insoluble, and in spite of the constant threat of external complications that may lead to war, the Habsburg monarchy as the result of the changes in the 19th and 20th centuries is seemingly stronger than ever. The shadow of universal claims to empire and sonorous but empty titles have vanished, but so have the manifold rivalries and entanglements which accompanied the Habsburg rule in Italy and the Netherlands and Habsburg preponderance in Germany. The monarchy is stronger because its sphere is more defined; because as preserving the *pax Romana* among the jostling races of eastern Europe, it is more than ever recognized as an essential element in the maintenance of European peace, and is recognized as necessary and beneficial even by the ambitious and restless nationalities that chafe under its rule.

A few words must be said about the cadet branches of the Habsburg family. When, in 1765, Francis I. died and Joseph II. became emperor, the grand-duchy of Tuscany passed by special arrangement not to Joseph, but to his younger brother Leopold. Then in 1791, after Leopold had succeeded Joseph as emperor, he handed over the grand-duchy to his second son, Ferdinand (1769-1824). In 1801 this prince was deposed by Napoleon and Tuscany was seized by France. Restored to the Habsburgs in the person of Ferdinand in 1814, it remained under his rule, and then under that of his son Leopold (1797-1870), until the rising of 1859, when the Austrians were driven out and the grand-duchy was added to the kingdom of Sardinia. A similar fate attended the duchy of Modena, which had passed to the Habsburgs through the marriage of its heiress Mary Beatrice of Este (d. 1829) with the archduke Ferdinand (1754-1806), brother of the emperor Leopold II. From 1814 to 1846 this duchy was governed by Ferdinand's son, Duke Francis IV., and from 1846 to 1859 by his grandson, Francis V. This family became extinct on the death of Francis V. in 1875.

† In addition to his successor Francis II., and to Ferdinand, grand-duke of Tuscany, the emperor Leopold II. had eight sons, five of whom, including the archduke John (1782-1859), who saw a good deal of service during the Napoleonic Wars and was chosen regent (*Reichsverweser*) of Germany in 1848, have now no living male descendants. Thus the existing branches of the family are descended from Leopold's five other sons. The descendants of Leopold, the dispossessed grand-duke of Tuscany, were in 1909 represented by his son, Ferdinand (b. 1835), who still claimed the title of grand-duke of Tuscany, and his son and grandsons; by the numerous descendants of the archduke Charles Salvator (1839-1892); and by the archduke Louis Salvator (b. 1847), a great traveller and a voluminous writer. The grand-duke's fourth son was the archduke John Nepomuck Salvator, who, after serving in the Austrian army, resigned all his rights and titles and under the name of Johann Orth took command of a sailing vessel. He is supposed to have been drowned off the coast of South America in 1891, but reports of his continued existence were circulated from time to time after that date. Of the emperor Leopold's other sons the archduke Charles, perhaps the most distinguished soldier of the family, left four sons, including Albert, duke of Teschen (1817-1895), who inherited some of his father's military ability. Charles's family was in 1909 represented by his grandsons, the sons of the archduke Charles Ferdinand (1818-1874). The archduke Joseph (1776-1847), palatine of Hungary, was represented by a grandson, Joseph Augustus (b. 1872), and the archduke Rainer (1783-1853), viceroy of Lombardy-Venetia, by a son Rainer (b. 1827), and by several grandsons.

The eldest and reigning branch of the family was in 1909 represented by the emperor Francis Joseph, whose father was the archduke Francis Charles (1802-1878), and whose grandfather was the emperor Francis II. Francis Joseph's only son Rudolph died in 1889; consequently the heir to the Habsburg monarchy was the emperor's nephew Francis Ferdinand (b. 1863), the eldest of the three sons of his brother Charles Louis (1833-1896). In 1875 Francis Ferdinand inherited the wealth of the Este family and took the title of archduke of Austria-Este; in 1900 he contracted a morganatic marriage with Sophie, countess of

Chotek, renouncing for his sons the succession to the monarchy. Thus after Francis Ferdinand this would pass to the sons of his brother, the archduke Otto (1865-1906). One of the emperor's three brothers was Maximilian, emperor of Mexico from 1863 to 1867.

With the exception of Charles V. the Habsburgs have produced no statesmen of great ability, while several members of the family have displayed marked traces of insanity. Nevertheless they secured, and for over 550 years they kept, the first place among the potentates of Europe; a dignity in origin and theory elective becoming in practice hereditary in their house. This position they owe to some extent to the tenacity with which they have clung to the various lands and dignities which have passed into their possession, but they owe it much more to a series of fortunate marriages and opportune deaths. The union of Maximilian and Mary of Burgundy, of Philip the Handsome and Joanna of Spain, of Ferdinand and Anna of Hungary and Bohemia; the death of Ottakar of Bohemia, of John, the only son of Ferdinand and Isabella of Spain, of Louis of Hungary and Bohemia—these are the corner-stones upon which the Habsburg monarchy has been built.

For the origin and early history of the Habsburgs see G. de Roo, *Annales rerum ab Austriacis Habsburgicis gentis principibus a Rudolpho I. usque ad Carolum V. gestarum* (Innsbruck, 1902, fol.); M. Herrgott, *Genealogia diplomatica angustis gentis Habsburgicæ* (Vienna, 1737-1738); E. M. Fürst von Lichnowsky, *Geschichte des Hauses Habsburg* (Vienna, 1836-1844); A. Schulte, *Geschichte der Habsburger in den ersten drei Jahrhunderten* (Innsbruck, 1887); T. von Liebenau, *Die Anfänge des Hauses Habsburg* (Vienna, 1883); W. Merz, *Die Habsburg* (Aarau, 1896); W. Gisi, *Der Ursprung der Häuser Zähringen und Habsburg* (1888); and F. Weirlich, *Stammfahne zur Geschichte des Hauses Habsburg* (Vienna, 1893). For the history of the Habsburg monarchy see Langl, *Die Habsburg und die denkwürdigen Stätten ihrer Umgebung* (Vienna, 1895); and E. A. Freeman, *Historical Geography of Europe* (1881). Two English books on the subject are J. Gilbert-Smith, *The Cradle of the Hapsburgs* (1907); and A. R. and E. Colquhoun, *The Whirlpool of Europe, Austria-Hungary and the Hapsburgs* (1906). (A. W. H. 9)

HACHETTE, JEAN NICOLAS PIERRE (1769-1834), French mathematician, was born at Mézières, where his father was a bookseller, on the 6th of May 1769. For his early education he proceeded first to the college of Charleville, and afterwards to that of Reims. In 1788 he returned to Mézières, where he was attached to the school of engineering as draughtsman to the professors of physics and chemistry. In 1793 he became professor of hydrography at Collioure and Port-Vendre. While there he sent several papers, in which some questions of navigation were treated geometrically, to Gaspard Monge, at that time minister of marine, through whose influence he obtained an appointment in Paris. Towards the close of 1794, when the École Polytechnique was established, he was appointed along with Monge over the department of descriptive geometry. There he instructed some of the ablest Frenchmen of the day, among them S. D. Poisson, F. Arago and A. Fresnel. Accompanying Guyton de Morveau in his expedition, earlier in the year, he was present at the battle of Fleurus, and entered Brussels with the French army. In 1816, on the accession of Louis XVIII., he was expelled from his chair by government. He retained, however, till his death the office of professor in the faculty of sciences in the École Normale, to which he had been appointed in 1810. The necessary royal assent was in 1823 refused to the election of Hachette to the Académie des Sciences, and it was not till 1831, after the Revolution, that he obtained that honour. He died at Paris on the 16th of January 1834. Hachette was held in high esteem for his private worth, as well as for his scientific attainments and great public services. His labours were chiefly in the field of descriptive geometry, with its application to the arts and mechanical engineering. It was left to him to develop the geometry of Monge, and to him also is due in great measure the rapid advancement which France made soon after the establishment of the École Polytechnique in the construction of machinery.

Hachette's principal works are his *Deux Suppléments à la Géométrie descriptive de Monge* (1811 and 1818); *Éléments de géométrie à trois dimensions* (1817); *Collection des œuvres de géométrie, &c.*

(1806 and 1817); *Applications de géométrie descriptive* (1817); *Traité de géométrie descriptive*, 2c. (1822); *Traité élémentaire des machines* (1811); *Correspondance sur l'École Polytechnique* (1804-1813). He also contributed many valuable papers to the leading scientific journals of his time.

For a list of Hachette's writings see the *Catalogue of Scientific Papers of the Royal Society of London*; also F. Amigo, *Œuvres* (1855); and Silvestre, *Notice sur J. N. P. Hachette* (Bruxelles, 1836).

HACHETTE, JEANNE, French heroine. Jeanne Lainé, or Fourquet, called Jeanne Hachette, was born about 1454. We have no precise information about her family or origin. She is known solely for her act of heroism which on the 27th of June 1472 saved Beauvais when it was on the point of being taken by the troops of Charles the Bold, duke of Burgundy. The town was defended by only 300 men-at-arms, commanded by Louis de Balagny. The Burgundians were making an assault, and one of their number had actually planted a flag upon the battlements, when Jeanne, axe in hand, flung herself upon him, hurled him into the moat, tore down the flag, and revived the drooping courage of the garrison. In gratitude for this heroic deed, Louis XI. instituted a procession in Beauvais called the Procession of the Assault, and married Jeanne to her chosen lover Colin Pilon, loading them with favours.

See Georges Valat, *Jeanne Hachette* (Abbeville, 1898).

HACHETTE, LOUIS CHRISTOPHE FRANÇOIS (1806-1864), French publisher, was born at Rethel, in the Ardennes on the 5th of May 1806. After studying three years at a normal school with the view of becoming a teacher, he was in 1822 on political grounds expelled from the seminary. He then studied law, but in 1826 he established in Paris a publishing business for the issue of works adapted to improve the system of school instruction, or to promote the general culture of the community. He published manuals in various departments of knowledge, dictionaries of modern and ancient languages, educational journals, and French, Latin and Greek classics annotated with great care by the most eminent authorities. Subsequently to 1850 he, in conjunction with other partners, published a cheap railway library, scientific and miscellaneous libraries, an illustrated library for the young, libraries of ancient literature, of modern foreign literature, and of modern foreign romance, a series of guide-books and a series of dictionaries of universal reference. In 1855 he also founded *Le Journal pour tous*, a publication with a circulation of 150,000 weekly. Hachette also manifested great interest in the formation of mutual friendly societies among the working classes, in the establishment of benevolent institutions, and in other questions relating to the amelioration of the poor, on which subjects he wrote various pamphlets; and he lent the weight of his influence towards a just settlement of the question of international literary copyright. He died on the 31st of July 1864.

HACHURE (French for "hatching"), the term for the conventional lines used in hill or mountain shading upon a map (q.v.) to indicate the slope of the surface, the depth of shading being greatest where the slope is steepest. The method is less accurate than that of contour lines, but gives an indication of the trend and extent of a range or mountain system, especially upon small-scale maps.

HACIENDA (O. Span. *faciendo*, from the Latin, meaning "things to be done"), a Spanish term for a landed estate. It is commonly applied in Spanish America to a country estate, on which stock-raising, manufacturing or mining may be carried on, usually with a dwelling-house for the owner's residence upon it. It is thus used loosely for a country house.

HACKBERRY, a name given to the fruit of *Celtis occidentalis*, belonging to the natural botanical order *Ulmaceae*, to which also belongs the elm (*Ulmus*). It is also known under the name of "sugar-berry," "beaver-wood" and "nettle-tree." The hackberry tree is of middle size, attaining from 60 to 80 ft. in height (though sometimes reaching 130 ft.), and with the aspect of an elm. The leaves are ovate in shape, with a very long taper point, rounded and usually very oblique at the base, usually glabrous above and soft-pubescent beneath. The soft filmy flowers appear early in the spring before the expansion of the

leaves. The fruit is oblong, about half to three-quarters of an inch long, of a reddish or yellowish colour when young, turning to a dark purple in autumn. This tree is distributed through the deep shady forests bordering river banks from Canada (where it is very rare) to the southern states. The fruit has a sweetish and slightly astringent taste, and is largely eaten in the United States. The seeds contain an oil like that of almonds. The bark is tough and fibrous like hemp, and the wood is heavy, soft, fragile and coarse-grained, and is used for making fences and furniture. The root has been used as a dye for linens.

HACKENSACK, a town and the county-seat of Bergen county, New Jersey, U.S.A., on the Hackensack river, 13 m. N. of Jersey City. Pop. (1890), 6004; (1900), 9443, of whom 2009 were foreign-born and 515 were negroes; (1905) 11,008; (1910) 14,050. It is served by the New York, Susquehanna & Western, and the New Jersey & New York railways, both being controlled by the Erie Company; and indirectly by the West Shore (at Bogota, $\frac{1}{2}$ m. S.E.). Electric lines connect Hackensack with Newark, Passaic and Paterson, and with New York ferries. The town extends from the low bank of the river W. to the top of a ridge, about 40 ft. higher up, from which there are good views to the S. and E. Hackensack is principally a residential town, though there are a number of manufacturing establishments in and near it. Silk and silk goods and wall-paper are the principal manufactures. In 1905 the value of the town's factory product was \$1,488,358, an increase of 90.3% since 1900. There are an historic mansion-house and an interesting old Dutch church, both erected during the 18th century; and a monument marks the grave of General Enoch Poor (1736-1780), an officer in the War of Independence, who was born at Andover, Mass., entered the Continental Army from New Hampshire, and took part in the campaign against Burgoyne, in the battle of Monmouth and in General Sullivan's expedition against the Iroquois. Hackensack was settled by the Dutch about 1640, and was named after the Hackensack Indians, a division of the Unami Delawares, who lived in the valleys of the Hackensack and Passaic rivers, and whose best-known chief was Oritany, a friend of the whites. Hackensack is coextensive with the township of New Barbadoes, first incorporated with considerably larger territory in 1693.

HACKET, JOHN (1592-1670), bishop of Lichfield and Coventry, was born in London and educated at Westminster and Trinity College, Cambridge. On taking his degree he was elected a fellow of his college, and soon afterwards wrote the comedy of *Loiola* (London, 1648), which was twice performed before James I. He was ordained in 1618, and through the influence of John Williams (1582-1650) became rector in 1621 of Stoke Hammond, Bucks, and Kirkby Underwood, Lincolnshire. In 1623 he was chaplain to James, and in 1624 Williams presented him to the livings of St Andrew's, Holborn, and Cheam, Surrey. When the so-called "root-and-branch bill" was before parliament in 1641, Hacket was selected to plead in the House of Commons for the continuance of cathedral establishments. In 1645 his living of St Andrew's was sequestered, but he was allowed to retain the rectory of Cheam. On the accession of Charles II. his fortunes improved; he frequently preached before the king, and in 1661 was consecrated bishop of Lichfield and Coventry. His best-known book is the excellent biography of his patron, Archbishop Williams, entitled *Scrinia reservata: a Memorial offered to the great Deservings of John Williams, D.D.* (London, 1693).

HACKETT, HORATIO BALCH (1808-1875), American biblical scholar, was born in Salisbury, Massachusetts, on the 27th of December 1808. He was educated at Phillips-Andover Academy, at Amherst College, where he graduated as valedictorian in 1830, and at Andover Theological Seminary, where he graduated in 1834. He was adjunct professor of Latin and Greek Languages and Literature at Brown University in 1835-1838 and professor of Hebrew Literature there in 1838-1839, was ordained to the Baptist ministry in 1839—he had become a Baptist at Andover as the result of preparing a paper on baptism in the New Testament and the Fathers—and in 1839-1868 he was professor of

Biblical literature and interpretation in Newton Theological Institution where his most important work was the introduction of the modern German methods of Biblical criticism, which he had learned from Moses Stuart at Andover and with which he made himself more familiar in Germany (especially under Tholuck at Halle) in 1841. He travelled in Egypt and Palestine in 1852, and in 1858-1859 in Greece, becoming proficient in modern Greek. From 1870 until his death in Rochester, New York, on the end of November 1875, he was professor of Biblical literature and New Testament exegesis in the Rochester Theological Seminary. He was a great teacher but a greater critical and exegetical scholar.

He wrote *Christian Memorials of the War* (1864); an English version of Winer's *Grammar of the Chaldee Language* (1844); *Exercises in Hebrew Grammar* (1847); and various articles on the Semitic language and literature in periodicals; but his best-known work was in general commentary on the Bible and translation, and in the special text study of the New Testament. Under these two headings fall: *Illustrations of Scripture; suggested by a Tour through the Holy Land* (1835); the American revision, with Ezra Abbot, of Smith's *Dictionary of the Bible*, to the British edition of which he had contributed about thirty articles; *Commentary on the Original Text of the Acts of the Apostles* (1852; 2nd edition, 1858), for many years the best English commentary; *Notes on the Greek Text of the Epistle of Paul to Philemon*, and a *Revised Version of Philemon*, both published in 1860; the English versions, in Schaff's edition of Lange's *Commentaries*, of Van Oosterzee's *Philemon* and Braune's *Philippians*; and for the American Bible Union Version of the Bible he translated the books of Ruth and Judges, and aided T. J. Conant in editorial revision; and he was one of the American translators for the English Bible revision.

See *Memorials of Horatio Balch Hackett* (Rochester, N.Y., 1876), edited by G. H. Whittemore.

HACKETT, JAMES HENRY (1800-1871), American actor, was born in New York. After an unsuccessful entry into business, in 1826 he went on the stage, where he soon established a reputation as a player of eccentric character parts. As Falstaff he was no less successful in England than in America. At various times he went into management, and he was the author of *Notes and Comments on Shakespeare* (1863).

His son, **JAMES KETELTAS HACKETT** (1860-), born at Wolfe Island, Ontario, and educated at the College of the City of New York, also became an actor. He came into prominence at the Lyceum in Daniel Frohman's company, and afterwards had considerable success in romantic parts. As a manager he stood outside the American syndicate of theatres, and organized several companies to play throughout the United States. In 1897 he married Mary Manning, the Anglo-American actress.

HACKLÄNDER, FRIEDRICH WILHELM VON (1816-1877). German novelist and dramatist, was born at Birtscheid near Aix-la-Chapelle on the 1st of November 1816. Having served an apprenticeship in a commercial house, he entered the Prussian artillery, but, disappointed at not finding advancement, returned to business. A soldier's life had a fascination for him, and he made his debut as an author with *Bilder aus dem Soldatenleben im Frieden* (1841). After a journey to the east, he was appointed secretary to the crown prince of Württemberg, whom he accompanied on his travels. *Wachstübchenabenteuer*, a continuation of his first work, appeared in 1845, and it was followed by *Bilder aus dem Soldatenleben im Kriege* (1840-1850). As a result of a tour in Spain in 1854, appeared *Ein Winter in Spanien* (1855). In 1857 he founded, in conjunction with Edmund von Zoller, the illustrated weekly, *Über Land und Meer*. In 1859 Hackländer was appointed director of royal parks and public gardens at Stuttgart, and in this post did much towards the embellishment of the city. In 1859 he was attached to the headquarters staff of the Austrian army during the Italian war; in 1861 he was raised to an hereditary knighthood in Austria; in 1864 he retired into private life, and died on the 6th of July 1877. Hackländer's literary talent is confined within narrow limits. There is much in his works of lively, adventurous and even romantic description, but the character-drawing is feeble and superficial.

Hackländer was a voluminous writer; the most complete edition of his works is the third, published at Stuttgart in 1876, in 60 volumes. There is also a good selection in 20 volumes (1881). Among his novels, *Namenlose Geschichten* (1851); *Eugen Süßfried* (1852); *Krieg und*

Frieden (1859), and the comedies *Der geheime Agent* (1850) and *Magnetische Kuren* (1851) may be specially mentioned. His autobiography appeared in 1878 under the title, *Der Roman meines Lebens* (2 vols.). See H. Morning, *Erinnerungen an F. W. Hackländer* (1878).

HACKNEY, a north-eastern metropolitan borough of London, England, bounded W. by Stoke Newington and Islington, and S. by Shoreditch, Bethnal Green and Poplar, and extending N. and E. to the boundary of the county of London. Pop. (1901), 219,272. It is a poor and populous district, in which the main thoroughfares are Kingsland Road, continued N. as Stoke Newington Road and Stamford Hill; Mare Street, continued N.W. as Clapton Road to Join Stamford Hill; and Lea Bridge Road running N.E. towards Walthamstow and Low Leyton. The borough includes the districts of Clapton in the north, Homerton in the east, and Dalston and part of Kingsland in the west. On the east lies the open flat valley of the Lea, which flows in several branches, and is bordered, immediately outside the confines of the borough, by the extensive reservoirs of the East London water-works. In these low lands lie the Hackney Marshes (338 acres; among several so-called marshes in the Lea valley), and the borough also contains part of Victoria Park and a number of open spaces collectively called the Hackney Commons, including Mill Fields, Hackney Downs, London Fields, &c. The total area of open spaces exceeds 500 acres. The tower of the ancient parish church of St Augustine, with the chapel of the Rowe family, still stands, and is the only historic building of importance. Among institutions are the German hospital, Dalston, Metropolitan hospital, Kingsland Road, and Eastern Fever hospital, Homerton; and the Hackney polytechnic institute, with which is incorporated the Sir John Cass institute. Cass (1666-1718), a merchant of the city of London, also a member of parliament and sheriff, bequeathed £1000 for the foundation of a free school; in 1732 the bequest was increased in accordance with an unfinished codicil to his will, and the income provided from it is now about £6000, some 250 boys and girls being educated. The parliamentary borough of Hackney comprises north, central and south divisions, each returning one member; and the northern division includes the metropolitan borough of Stoke Newington. The metropolitan borough of Hackney includes part of the Hornsey parliamentary division of Middlesex. The borough council consists of a mayor, 10 aldermen and 60 councillors. Area, 3,288.9 acres.

In the 13th century the name appears as *Hackensaye* or *Hacquensye*, but no certain derivation is advanced. Roman and other remains have been found in Hackney Marshes. In 1290 the bishop of London was lord of the manor, which was so held until 1550, when it was granted to Thomas, Lord Wentworth. In 1607 it came into the hands of the Tyssen family. Extensive property in the parish also belonged to the priory of the Knights Hospitallers of St John of Jerusalem at Clerkenwell. From the 16th to the early 19th century there were many fine residences in Hackney. The neighbourhood of Hackney had at one time an evil reputation as the haunt of highwaymen.

HACKNEY (from Fr. *haquensé*, Lat. *equus*, an ambling horse or mare, especially for ladies to ride; the English "hack" is simply an abbreviation), originally a riding-horse. At the present day, however, the hackney (as opposed to a thoroughbred) is bred for driving as well as riding (see *Horse: Breeds*). From the hiring-out of hackneys, the word came to be associated with employment for hire (so "a hack," as a general term for "drudge"), especially in combination, e.g. hackney-chair, hackney-coach, hackney-boat. The hackney-coach, a coach with four wheels and two horses, was a form of hired public conveyance (see *CARRIAGE*).

HADAD, the name of a Syrian deity, is met with in the Old Testament as the name of several human persons; it also occurs in compound forms like Benhadad and Hadadezer. The divinity primarily denoted by it is the storm-god who was known also as Ramman, Bir and Dadda. The Syrian kings of Damascus seem to have habitually assumed the title of Benhadad, or son of Hadad (three of this name are mentioned in Scripture), just as a series of Egyptian monarchs are known to have been

accustomed to call themselves sons of Amon-Ra. The word Hadadrimmon, for which the inferior reading Hadarrimmon is found in some MSS. in the phrase "the mourning of (or at) Hadadrimmon" (Zech. xii. 11), has been a subject of much discussion. According to Jerome and all the older Christian interpreters, the mourning for something that occurred at a place called Hadadrimmon (Maximianopolis) in the valley of Megiddo is meant, the event alluded to being generally held to be the death of Josiah (or, as in the Targum, the death of Ahab at the hands of Hadadrimmon); but more recently the opinion has been gaining ground that Hadadrimmon is merely another name for Adonis (q.v.) or Tammuz, the allusion being to the mournings by which the Adonis festivals were usually accompanied (Hitzig on Zech. xii. 11, Isa. xvii. 8; Movers, *Phönizier*, i. 196). T. K. Cheyne (*Encycl. Bibl.* s.v.) points out that the Septuagint reads simply Rimmon, and argues that this may be a corruption of Migdon (Megiddo), in itself a corruption of Tammuz-Adon. He would read the verse, "In that day there shall be a great mourning in Jerusalem, as the mourning of the women who weep for Tammuz-Adon" (*Adon* means lord).

HADDINGTON, EARL OF, a Scottish title bestowed in 1627 upon Thomas Hamilton, earl of Melrose (1563-1637). Thomas, who was a member of the great family of Hamilton, being a son of Thomas Hamilton of Priestfield, was a lawyer who became a lord of session as Lord Drumcairn in 1592. He was on very friendly terms with James VI., his legal talents being useful to the king, and he was one of the eight men who, called the Octavians, were appointed to manage the finances of Scotland in 1596. Having also become king's advocate in 1596, Hamilton was entrusted with a large share in the government of his country when James went to London in 1603; in 1612 he was appointed secretary of state for Scotland, and in 1613 he was created Lord Binning and Byres. In 1616 he became lord president of the court of session, and three years later was created earl of Melrose, a title which he exchanged in 1627 for that of earl of Haddington. After the death of James I. the earl resigned his offices of president of the court of session and secretary of state, but he served Charles I. as lord privy seal. He died on the 29th of May 1637. Haddington, who was both scholarly and wealthy, left a large and valuable collection of papers, which is now in the Advocates' library at Edinburgh. James referred familiarly to his friend as *Tam o' the Covegate*, his Edinburgh residence being in this street.

The earl's eldest son THOMAS, the 2nd earl (1600-1640), was a covenanter and a soldier, being killed by an explosion at Dungleas castle on the 30th of August 1640. His sons, THOMAS (d. 1645) and JOHN (d. 1660), became respectively the 3rd and 4th earls of Haddington, and John's grandson THOMAS (1679-1735) succeeded his father CHARLES (c. 1650-1685), as 6th earl in 1685, although he was not the eldest but the second son. This curious circumstance arose from the fact that when Charles married Margaret (d. 1700), the heiress of the earldom of Rothes, it was agreed that the two earldoms should be left separate; thus the eldest son John became earl of Rothes while Thomas became earl of Haddington. Thomas was a supporter of George I. during the rising of 1715, and was a representative peer for Scotland from 1716 to 1734. He died on the 28th of November 1735.

The 6th earl was a writer, but in this direction his elder son, CHARLES, Lord Binning (1697-1732), is perhaps more celebrated. After fighting by his father's side at Sheriffmuir in 1715 and serving as member of parliament for St Germans, Binning died at Naples on the 27th of December 1732. His eldest son, THOMAS (c. 1720-1794), became the 7th earl in 1735, and the latter's grandson THOMAS (1780-1858) became the 9th earl in 1828. The 9th earl had been a member of parliament from 1802 to 1827, when he was made a peer of the United Kingdom as Baron Melros of Tynninghame, a title which became extinct upon his death. In 1834 he became lord-lieutenant of Ireland under Sir Robert Peel, leaving office in the following year, and in Peel's second administration (1841-1846) he served as first lord of the admiralty and then as lord privy seal. When he died without

sons on the 1st of December 1858 the earldom passed to his kinsman, GEORGE BAILLIE (1802-1876), a descendant of the 6th earl. This nobleman took the name of Baillie-Hamilton, and his son GEORGE (b. 1827) became 11th earl of Haddington in 1870.

See *State Papers of Thomas, Earl of Melrose*, published by the Abbotsford Club in 1837, and Sir W. Fraser, *Memorials of the Earls of Haddington* (1889).

HADDINGTON, a royal, municipal and police burgh, and county town of Haddingtonshire, Scotland. Pop. (1901), 3993. It is situated on the Tyne, 18 m. E. of Edinburgh by the North British railway, being the terminus of a branch line from Longniddry Junction. Five bridges cross the river, on the right bank of which lies the old and somewhat decayed suburb of Nungate, interesting as having contained the Giffordgate, where John Knox was born, and where also are the ruins of the pre-Reformation chapel of St Martin. The principal building in the town is St Mary's church, a cruciform Decorated edifice in red sandstone, probably dating from the 13th century. It is 210 ft. long, and is surmounted by a square tower 90 ft. high. The nave, restored in 1892, is used as the parish church, but the choir and transepts are roofless, though otherwise kept in repair. In a vault is a fine monument in alabaster, consisting of the recumbent figures of John, Lord Maitland of Thirlestane (1543-1595), chancellor of Scotland, and his wife. The laudatory sonnet composed by James VI. is inscribed on the tomb. In the same vault John, duke of Lauderdale (1616-1682), is buried. In the choir is the tombstone which Carlyle erected over the grave of his wife, Jane Baillie Welsh (1801-1866), a native of the town. Other public edifices include the county buildings in the Tudor style, in front of which stands the monument to George, 8th marquess of Tweeddale (1787-1876), who was such an expert and enthusiastic coachman that he once drove the mail from London to Haddington without taking rest; the corn exchange, next to that of Edinburgh the largest in Scotland; the town house, with a spire 150 ft. high, in front of which is a monument to John Home, the author of *Douglas*; the district asylum to the north of the burgh; the western district hospital; the Tenterfield home for children; the free library and the Knox Memorial Institute. This last-named building was erected in 1879 to replace the old and famous grammar school, where John Knox, William Dunbar, John Major and possibly George Buchanan and Sir David Lindsay were educated. John Brown (1722-1787), a once celebrated dissenting divine, author of the *Self-Interpreting Bible*, ministered in the burgh for 36 years and is buried there; his son John the theologian (1754-1832), and his grandson Samuel (1817-1856), the chemist, noted for his inquiries into the atomic theory, were natives. Samuel Smiles (1812-1904), author of *Character, Self-Help* and other works, was also born there, and Edward Irving was for years mathematical master in the grammar school. In Hardgate Street is "Bothwell Castle," the town house of the earl of Bothwell, where Mary Queen of Scots rested on her way to Dunbar. The ancient market cross has been restored. The leading industries are the making of agricultural implements, manufactures of woollens and sacking, brewing, tanning and coach-building, besides corn mills and engineering works.

The burgh is the retail centre for a large district, and its grain markets, once the largest in Scotland, are still of considerable importance. Haddington was created a royal burgh by David I. It also received charters from Robert Bruce, Robert II. and James VI. In 1139 it was given as a dowry to Ada, daughter of William de Warenne, earl of Surrey, on her marriage to Prince Henry, the only son of David I. It was occasionally the residence of royalty, and Alexander II. was born there in 1198. Lying in the direct road of the English invaders, the town was often ravaged. It was burned by King John in 1216 and by Henry III. in 1244. Fortified in 1548 by Lord Grey of Wilton, the English commander, it was besieged next year by the Scots and French, who forced the garrison to withdraw. So much slaughter had gone on during that period of storm and stress that it was long impossible to excavate in any direction without coming

on human remains. The town has suffered much periodically from floods. One of the most memorable of these occurred on the 4th of October 1775, when the Tyne rose 8 ft. 9 in. above its bed and inundated a great part of the burgh. An inscription in the centre of the town records the event and marks the point to which the water rose.

There are many interesting places within a few miles of Haddington. Five miles E. is Whittingehame House, and 5 m. N.E. is the thriving village of East Linton (pop. 919). About 2½ m. N. lies Athelstaneford (locally, Elshinford), so named from the victory of Hungus, king of the Picts, in the 8th century over the Northumbrian Athelstane. On a hill near Drem, 3½ m. N. by W., are traces of a Romano-British settlement, and the remains of the priest's house of the Knights Templars, to whom the barony once belonged. On the coast is the pretty village of Aberlady on a fine bay, and in the neighbourhood are some of the finest golf links in Scotland, such as Luffness, Gullane, Archerfield and Muirfield. On Gosford Bay is Gosford House, an 18th-century mansion, the seat of the earl of Wemyss. At Gladamuir, 3½ m. W. of Haddington, alleged by some to have been the birthplace of George Heriot, Principal Robertson was minister and wrote most of his *History of Scotland*. Of the old seat of the Douglases at Longniddry few traces remain, and in the chapel, now in ruins, at the eastern end of the village, John Knox is said to have preached occasionally. At Gifford, 4 m. to the S., John Witherspoon (1722-1794), president of the College of New Jersey (Princeton), and Charles Nisbet (1736-1804), president of Dickinson College, Carlisle, Pennsylvania, were born. A little to the south of Gifford are Yester House, a seat of the marquess of Tweeddale, finely situated in a park of old trees, and the ruins of Yester Castle. The cavern locally known as Hobgoblin Hall is described in *Marmion*, and is associated with all kinds of manifestations of the black art. Lennoxlove, 1½ m. to the S., a seat of Lord Blantyre, was originally called Letthington, and for a few centuries was associated with the Maitlands. Amisfield, adjoining Haddington on the N.E., is another seat of the earl of Wemyss.

HADDINGTONSHIRE, or **EAST LOTHIAN**, a south-eastern county of Scotland, bounded N. by the Firth of Forth, N.E. by the North Sea, E., S.E. and S. by Berwickshire, and S.W. and W. by Edinburghshire. It covers an area of 171,011 acres, or 267 sq. m. Its sea-coast measures 41 m. The Bass Rock and Fidra Isle belong to the shire, and there are numerous rocks and reefs off the shore, especially between Dunbar and Gullane Bay. Broadly speaking, the northern half of the shire slopes gently to the coast, and the southern half is hilly. Several of the peaks of the Lammermuirs exceed 1500 ft., and the more level tract is broken by Traprain Law (724) in the parish of Prestonkirk, North Berwick Law (612), and Garleton Hill (590) to the north of the county town. The only important river is the Tyne, which rises to the south-east of Bothwick in Mid-Lothian, and, taking a generally north-easterly direction, reaches the sea just beyond the park of Tynninghame House, after a course of 28 m., for the first 7 m. of which it belongs to its parent shire. It is noted for a very fine variety of trout, and salmon are sometimes taken below the linn at East Linton. The Whiteadder rises in the parish of Whittingehame, but, flowing towards the south-east, leaves the shire and at last joins the Tweed near Berwick. There are no natural lakes, but in the parish of Stenton is found Pressmennan Loch, an artificial sheet of water of somewhat serpentine shape, about 2 m. in length, with a width of some 400 yds., which was constructed in 1819 by damming up the ravine in which it lies. The banks are wooded and picturesque, and the water abounds with trout.

Geology.—The higher ground in the south, including the Lammermuir Hills, is formed by shales, greywackes and grits of Ordovician and Silurian age; a narrow belt of the former lying on the north-western side of the latter, the strike being S.W. to N.E. The granitic mass of Priestlaw and other felsitic rocks have been intruded into these strata. The lower Old Red Sandstone has not been observed in this county, but the younger sandstones and conglomerates fill up ancient depressions in the Silurian and Ordovician, such as that running northward from Oldhamstocks towards Dunbar and the valley of Lauderdale. A faulted-in tract of the same formation, about 1 m. in breadth, runs westward from Dunbar to near Gifford. Carboniferous rocks form the remainder of the county. The Calciferous Sandstone series, shales, thin limestones and sandstones, is exposed on the south-eastern coast; but between Gifford and North Berwick and from Aberlady to Dunbar it is represented by a great thickness of volcanic rocks consisting of tuffs and coarse breccias in the lower beds, and of porphyritic and andesitic lavas above. These rocks are well exposed on the coast, in the Garleton Hills and Traprain Law; the latter and North Berwick Law are volcanic

necks or vents. The Carboniferous Limestone series which succeeds the Calciferous Sandstone consists of a middle group of sandstones, shales, coals and ironstones, with a limestone group above and below. The coal-field is synclinal in structure, Fort Seton being about the centre; it contains ten seams of coal, and the area covered by it is some 30 sq. m. Glacial boulder clay lies over much of the lower ground, and ridges of gravel and sand flank the hills and form extensive sheets. Traces of old raised sea-beaches are found at several points along the coast. At North Berwick, Tynninghame and elsewhere there are stretches of blown sand. Limestone is worked at many places, and hematite was formerly obtained from the Garleton Hills.

Climate and Agriculture.—Though the county is exposed to the full sweep of the east wind during March, April and May, the climate is on the whole mild and equable. The rainfall is far below the average of Great Britain, the mean for the year being 25 in., highest in midsummer and lowest in spring. The average temperature for the year is 47°·5 F., for January 38° and for July 59°. Throughout nearly the whole of the 19th century East Lothian agriculture was held to be the best in Scotland, not so much in consequence of the natural fertility of the soil as because of the enterprise of the cultivators, several of whom, like George Hope of Fenton Barns (1811-1876), brought scientific farming almost to perfection. Mechanical appliances were adopted with exceptional alacrity, and indeed some that afterwards came into general use were first employed in Haddington. Drill sowing of turnips dates from 1734. The threshing machine was introduced by Andrew Meikle (1719-1811) in 1787, the steam plough in 1864, and the reaping machine soon after its invention, while tile draining was first extensively used in the county. East Lothian is famous for the richness of its grain and green crops, the size of its holdings (average 200 acres) and the good housing of its labourers. The soils vary. Much of the Lammermuirs is necessarily unproductive, though the lower slopes are cultivated, a considerable tract of the land being very good. In the centre of the shire occurs a belt of tenacious yellow clay on a tilly subsoil which is not adapted for agriculture. Along the coast the soil is sandy, but farther inland it is composed of rich loam and is very fertile. The land about Dunbar is the most productive, yielding a potato—the "Dunbar red"—which is highly esteemed in the markets. Of the grain crops oats and barley are the principal, and their acreage is almost a constant, but wheat, after a prolonged decline, has experienced a revival. Turnips and potatoes are cultivated extensively, and with marked success, and constitute nearly all the green crops raised. Although pasture-land is below the average, live-stock are reared profitably. About one-sixteenth of the total area is under wood.

Other Industries.—Fisheries are conducted from Dunbar, North Berwick, Port Seton and Prestonpans, the catch consisting chiefly of cod, haddock, whiting and shellfish. Fireclay as well as limestone is worked, and there are some stone quarries, but the manufactures are mainly agricultural implements; pottery, woollens, artificial manures, feeding-stuffs and salt, besides brewing. Coal of a very fair quality is extensively worked at Tranent, Ormiston, Macmerry and near Prestonpans, the coal-field having an area of about 30 sq. m. Limestone is found throughout the greater part of the shire. A vein of hematite of a peculiarly fine character was discovered in 1866 at Garleton Hill, and wrought for some years. Ironstone has been mined at Macmerry.

The North British Company possess the sole running powers in the county, through which is laid their main line to Berwick and the south. Branches are sent off at Drem to North Berwick, at Longniddry to Haddington and also to Gullane, at Smeaton (in Mid-Lothian) to Macmerry, and at Ormiston to Gifford.

Population and Government.—The population was 37,377 in 1891, and 38,665 in 1901, when 459 persons spoke Gaelic and English, and 7 spoke Gaelic only. The chief towns are Dunbar (pop. in 1901, 3581), Haddington (3993), North Berwick (2899), Prestonpans (2614) and Tranent (2584). The county, which returns one member to Parliament, forms part of the sheriffdom of the Lothians and Peebles, and there is a resident sheriff-substitute at Haddington, who sits also at Dunbar, Tranent

and North Berwick. The shire is under school-board jurisdiction, and besides high schools at Haddington and North Berwick, some of the elementary schools earn grants for higher education. The county council spends a proportion of the "residue" grant in supporting short courses of instruction in technical subjects (chiefly agriculture), in experiments in the feeding of cattle and the growing of crops, and in defraying the traveling expenses of technical students.

History.—Of the Celts, who were probably the earliest inhabitants, traces are found in a few place names and circular camps (in the parishes of Garvald and Whittinghame) and-hill forts (in the parish of Bolton). After the Roman occupation, of which few traces remain, the district formed part of the Saxon kingdom of Northumbria until 1018, when it was joined to Scotland by Malcolm II. It was comparatively prosperous till the wars of Bruce and Baliol, but from that period down to the union of the kingdoms it suffered from its nearness to the Border and from civil strife. The last battles fought in the county were those of Dunbar (1650) and Prestonpans (1745).

See J. Miller, *History of Haddington* (1844); D. Croal, *Sketches of East Lothian* (Haddington, 1873); John Martine, *Reminiscences of the County of Haddington* (Haddington, 1890, 1894); Dr Wallace James, *Writs and Charters of Haddington* (Haddington, 1898).

HADDOCK (*Gadus aeglefinus*), a fish which differs from the cod in having the mental barbel very short, the first anal fin with 22 to 25 rays, instead of 17 to 20, and the lateral line dark instead of whitish; it has a large blackish spot above each pectoral fin—associated in legend with the marks of St Peter's finger and thumb, the haddock being supposed to be the fish from whose mouth he took the tribute-money. It attains to a weight of 15 lb. and is one of the most valuable food fishes of Europe, both fresh and smoked, the "finnan haddie" of Scotland being famous. It is common round the British and Irish coasts, and generally distributed along the shores of the North Sea, extending across the Atlantic to the coast of North America.

HADDON HALL, one of the most famous ancient mansions in England. It lies on the left bank of the river Wye, 2 m. S.E. of Bakewell in Derbyshire. It is not now used as a residence, but the fabric is maintained in order. The building is of stone and oblong in form, and encloses two quadrangles separated by the great banqueting-hall and adjoining chambers. The greater part is of two storeys, and surmounted by battlements. To the south and south-east lie terraced gardens, and the south front of the eastern quadrangle is occupied by the splendid ball-room or long gallery. At the south-west corner of the mansion is the chapel; at the north-east the Peveril tower. The periods of building represented are as follows. Norman work appears in the chapel (which also served as a church for the neighbouring villagers), also in certain fundamental parts of the fabric, notably the Peveril tower. There are Early English and later additions to the chapel; the banqueting-hall, with the great kitchen adjacent to it, and part of the Peveril tower are of the 14th century. The eastern range of rooms, including the state-room, are of the 15th century; the western and north-western parts were built shortly after 1500. The ball-room is of early 17th-century construction, and the terraces and gardens were laid out at this time. A large number of interesting contemporary fittings are preserved, especially in the banqueting-hall and kitchen; and many of the rooms are adorned with tapestries of the 16th and 17th centuries, some of which came from the famous works at Mortlake in Surrey.

A Roman altar was found and is preserved here, but no trace of Roman inhabitants has been discovered. Haddon was a manor which before the Conquest and at the time of the Domesday Survey belonged to the king, but was granted by William the Conqueror to William Peverel, whose son, another William Peverel, forfeited it for treason on the accession of Henry II. Before that time, however, the manor of Haddon had been granted to the family of Avenell, who continued to hold it until one William Avenell died without male issue and his property was divided between his two daughters and heirs, one of whom married Richard Vernon, whose successors acquired

the other half of the manor in the reign of Edward III. Sir George Vernon, who died in 1561, was known as the "King of the Peak" on account of his hospitality. His daughter Dorothy married John Manners, second son of the earl of Rutland, who is said to have lived for some time in the woods round Haddon Hall, disguised as a gamekeeper, until he persuaded Dorothy to elope with him. On Sir George's death without male issue Haddon passed to John Manners and Dorothy, who lived in the Hall. Their grandson John Manners succeeded to the title of earl of Rutland in 1641, and the duke of Rutland is still lord of the manor.

See *Victoria County History, Derbyshire*; S. Rayner, *History and Antiquities of Haddon Hall* (1836-1837); Haddon Hall, *History and Antiquities of Haddon Hall* (1867); G. le Blanc Smith, *Haddon, the Manor, the Hall, its Lords and Traditions* (London, 1906).

HADEN, SIR FRANCIS SEYMOUR (1818-1910), English surgeon and etcher, was born in London on the 16th of September 1818, his father, Charles Thomas Haden, being a well-known doctor and amateur of music. He was educated at University College school and University College, London, and also studied at the Sorbonne, Paris, where he took his degree in 1840. He was admitted as a member of the College of Surgeons in London in 1842. Besides his many-sided activities in the scientific world, during a busy and distinguished career as a surgeon, he followed the art of original etching with such vigour that he became not only the foremost British exponent of that art but was the principal cause of its revival in England. By his strenuous efforts and perseverance, aided by the secretarial ability of Sir W. R. Drake, he founded the Royal Society of Painter-Etchers and Engravers. As president he ruled the destinies of that society with a strong hand from its first beginnings in 1880. In 1843-1844, with his friends Duval, Le Cannes and Col. Guibout, he had travelled in Italy and made his first sketches from nature. Haden attended no art school and had no art teachers, but in 1845, 1846, 1847 and 1848 he studied portfolios of prints belonging to an old second-hand dealer named Love, who had a shop in Bunhill Row, the old Quaker quarter of London. These portfolios he would carry home, and arranging the prints in chronological order, he studied the works of the great original engravers, Dürer, Lucas van Leyden and Rembrandt. These studies, besides influencing his original work, led to his important monograph on the etched work of Rembrandt. By lecture and book, and with the aid of the memorable exhibition at the Burlington Fine Arts Club in 1877, he endeavoured to give a just idea of Rembrandt's work, separating the true from the false, and giving altogether a nobler idea of the master's mind by taking away from the list of his works many dull and unseemly plates that had long been included in the lists. His reasons are founded upon the results of a study of the master's works in chronological order, and are clearly expressed in his monograph, *The Etched Work of Rembrandt critically reconsidered*, privately printed in 1877, and in *The Etched Work of Rembrandt True and False* (1895). Notwithstanding all this study of the old masters of his art, Haden's own plates are perhaps more individual than any artist's, and are particularly noticeable for a fine original treatment of landscape subjects, free and open in line, clear and well divided in mass, and full of a noble and dignified style of his own. Even when working from a picture his personality dominates the plate, as for example in the large plate he etched after J. M. W. Turner's "Calais Pier," which is a classical example of what interpretative work can do in black and white. Of his original plates, more than 250 in number, one of the most notable was the large "Breaking up of the Agamemnon." An early plate, rare and most beautiful, is "Thames Fisherman." "Mytton Hall" is broad in treatment, and a fine rendering of a shady avenue of yew trees leading to an old manor-house in sunlight. "Sub Tegmine" was etched in Greenwich Park in 1859; and "Early Morning—Richmond," full of the poetry and freshness of the hour, was done, the artist has said, actually at sunrise. One of the rarest and most beautiful of his plates is "A By-Road in Tipperary"; "Combe Bottom" is another; and "Shere Mill Pond" (both the small study and the larger plate), "Sunset in

Ireland," "Penton Hook," "Grim Spain" and "Evening Fishing, Longparish," are also notable examples of his genius. A catalogue of his works was begun by Sir William Drake and completed by Mr N. Harrington (1880). During later years Haden began to practise the sister art of mezzotint engraving, with a measure of the same success that he had already achieved in pure etching and in dry-point. Some of his mezzotints are: "An Early Riser," a stag seen through the morning mists, "Grayling Fishing" and "A Salmon Pool on the Spey." He also produced some remarkable drawings of trees and park-like country in charcoal.

Other books by Haden not already mentioned are—*Études à Peau forte* (Paris, 1865); *About Etching* (London, 1878-1879); *The Art of the Painter-Etcher* (London, 1890); *The Relative Claims of Etching and Engraving to rank as Fine Arts and to be represented in the Royal Academy* (London, 1883); *Address to Students of Winchester School of Art* (Winchester, 1888); *Cremation: a Pamphlet* (London, 1875); and *The Disposal of the Dead, a Plea for Legislation* (London, 1888). As the last two indicate, he was an ardent champion of a system of "earth to earth" burial.

Among numerous distinctions he received the Grand Prix, Paris, in 1880 and 1900, and was made a member of the Institut de France, Académie des Beaux-Arts and Société des Artistes Français. He was knighted in 1894, and died on the 1st of June 1910. He married in 1847 a sister of the artist J. A. M. Whistler; and his elder son, Francis Seymour Haden (b. 1850), had a distinguished career as a member of the government in Natal from 1881 to 1893, being made a C.M.G. in 1890. (C.H.*)

HADENDOA (from Beja *Hada*, chief, and *endowa*, people), a nomad tribe of Africans of "Hamitic" origin. They inhabit that part of the eastern Sudan extending from the Abyssinian frontier northward nearly to Suakin. They belong to the Beja people, of which, with the Bisharin and the Ababda, they are the modern representatives. They are a pastoral people, ruled by a hereditary chief who is directly responsible to the (Anglo-Egyptian) Sudan government. Although the official capital of the Hadendoa country is Miktinab, the town of Fillik on an affluent of the Atbara is really their headquarters. A third of the total population is settled in the Suakin country. Osman Digna, one of the best-known chiefs during the Madhia, was a Hadendoa, and the tribe contributed some of the fiercest of the dervish warriors in the wars of 1883-98. So determined were they in their opposition to the Anglo-Egyptian forces that the name Hadendoa grew to be nearly synonymous with "rebel." But this was the result of Egyptian misgovernment rather than religious enthusiasm; for the Hadendoa are true Beja, and Mahomedans only in name. Their elaborate hairdressing gained them the name of "Fuzzy-wuzzies" among the British troops. They earned an unenviable reputation during the wars by their hideous mutilations of the dead on the battlefields. After the reconquest of the Egyptian Sudan (1896-98) the Hadendoa accepted the new order without demur.

See *Anglo-Egyptian Sudan*, edited by Count Gleichen (London, 1905); Sir F. R. Wingate, *Mahdism and the Egyptian Sudan* (London, 1891); G. Sergi, *Africa: Anthropology of the Hamitic Race* (1897); A. H. Keane, *Ethnology of the Egyptian Sudan* (1884).

HADERSLEBEN (Dan. *Haderslev*), a town of Germany, in the Prussian province of Schleswig-Holstein, 31 m. N. from Flensburg. Pop. (1905) 9289. It lies in a pleasant valley on the Hadersleben fjord, which is about 9 m. in length, and communicates with the Little Belt, and at the junction of the main line of railway from Woycons with three vicinal lines. The principal buildings are the beautiful church of St Mary, dating from the 13th century, the theological seminary established in 1870, the gymnasium and the hospital. The industries include iron-founding, tanning, and the manufacture of machines, tobacco and gloves. The harbour is only accessible to small vessels.

Hadersleben is first mentioned in 1228, and received municipal rights from Duke Waldemar II. in 1292. It suffered considerably during the wars between Schleswig and Holstein in the 15th

century. In November 1864 it passed with Schleswig to Prussia. Two Danish kings, Frederick II. and Frederick III., were born at Hadersleben.

See A. Sach, *Der Ursprung der Stadt Hadersleben* (Hadersleben, 1892).

HADING, JANE (1859-), French actress, whose real name was Jeanne Alfrédine Tréfontaine, was born on the 25th of November 1859 at Marseilles, where her father was an actor at the Gymnase. She was trained at the local Conservatoire and was engaged in 1873 for the theatre at Algiers, and afterwards for the Khedivial theatre at Cairo, where she played, in turn, coquette, soubrette and *ingénue* parts. Expectations had been raised by her voice, and when she returned to Marseilles she sang in operetta, besides acting in *Ruy Blas*. Her Paris début was in *La Chaste Suzanne* at the Palais Royal, and she was again heard in operetta at the Renaissance. In 1883 she had a great success at the Gymnase in *Le Maître de forges*. In 1884 she married Victor Koning (1842-1894), the manager of that theatre, but divorced him in 1887. In 1888 she toured America with Coquelin, and on her return helped to give success to Lavedan's *Prince d'Aurec*, at the Vaudeville. Her reputation as one of the leading actresses of the day was now established not only in France but in America and England. Her later repertoire included *Le Demi-monde*, Capus's *La Châtelaine*, Maurice Donnay's *Retour de Jérusalem*, *La Princesse Georges* by Dumax fils, and Émile Bergerat's *Plus que reine*.

HADLEIGH, a market town in the Sudbury parliamentary division of Suffolk, England; 70 m. N.E. from London, the terminus of a branch of the Great Eastern railway. Pop. of urban district (1901), 3245. It lies pleasantly in a well-wooded country on the small river Brett, a tributary of the Stour. The church of St Mary is of good perpendicular work, with Early English tower and Decorated spire. The Rectory Tower, a turreted gate-house of brick, dates from c. 1405. The guild-hall is a Tudor building, and there are other examples of this period. There are a town-hall and corn exchange, and an industry in the manufacture of matting and in malling. Hadleigh was one of the towns in which the woollen industry was started by Flemings, and survived until the 18th century. Among the rectors of Hadleigh several notable names appear, such as Rowland Taylor, the martyr, who was burned at the stake outside the town in 1555, and Hugh James Rose, during whose tenancy of the rectory an initiatory meeting of the leaders of the Oxford Movement took place here in 1833.

Hadleigh, called by the Saxons *Heapele-leag*, appears in Domesday Book as *Hetlega*. About 885 Æthelred, lady of the Mercians, with the consent of Æthelred her husband, gave Hadleigh to Christ Church, Canterbury. The dean and chapter of Canterbury have held possession of it ever since the Dissolution. In the 17th century Hadleigh was famous for the manufacture of cloth, and in 1618 was sufficiently important to receive incorporation. It was constituted a free borough under the title of the mayor, aldermen and burgesses of Hadleigh. In 1635, in a list of the corporate towns of Suffolk to be assessed for ship money, Hadleigh is named as third in importance. In 1636, owing to a serious visitation of the plague, 200 families were thrown out of work, and in 1687 so much had its importance declined that it was deprived of its charter. An unsuccessful attempt to recover it was made in 1701. There is evidence of the existence of a market here as early as the 13th century. James I., in his charter of incorporation, granted fairs on Monday and Tuesday in Whitsun week, and confirmed an ancient fair at Michaelmas and a market on Monday.

HADLEY, ARTHUR TWining (1856-), American political economist and educationist, president of Yale University, was born in New Haven, Connecticut, on the 23rd of April 1856. He was the son of James Hadley, the philologist, from whom, as from his mother—whose brother, Alexander Catlin Twining (1801-1884), was an astronomer and authority on constitutional law—he inherited unusual mathematical ability. He graduated at Yale in 1876 as valedictorian, having taken prizes in English, classics and astronomy; studied political

science at Yale (1876-1877) and at Berlin (1878-1879); was a tutor at Yale in 1879-1883, instructor in political science in 1883-1886, professor of political science in 1886-1891, professor of political economy in 1891-1899, and dean of the Graduate School in 1892-1895; and in 1899 became president of Yale University—the first layman to hold that office. He was commissioner of the Connecticut bureau of labour statistics in 1885-1887. As an economist he first became widely known through his investigation of the railway question and his study of railway rates, which antedated the popular excitement as to rebates. His *Railroad Transportation, its History and Laws* (1885) became a standard work, and appeared in Russian (1886) and French (1887); he testified as an expert on transportation before the Senate committee which drew up the Interstate Commerce Law; and wrote on railways and transportation for the Ninth and Tenth Editions (of which he was one of the editors) of the *Encyclopædia Britannica*, for Lalor's *Cyclopædia of Political Science, Political Economy, and Political History of the United States* (3 vols., 1881-1884), for *The American Railway* (1888), and for *The Railroad Gazette* in 1884-1891, and for other periodicals. His idea of the broad scope of economic science, especially of the place of ethics in relation to political economy and business, is expressed in his writings and public addresses. In 1907-1908 he was Theodore Roosevelt professor of American History and Institutions in the university of Berlin.

Among his other publications are: *Economics: an Account of the Relations between Private Property and Public Welfare* (1896); *The Education of the American Citizen* (1901); *The Relations between Freedom and Responsibility in the Evolution of Democratic Government* (1903, in Yale Lectures on the Responsibilities of Citizenship); *Baccalaureate Addresses* (1907); and *Standards of Public Morality* (1907), being the Kennedy Lectures for 1906.

HADLEY, JAMES (1821-1872), American scholar, was born on the 30th of March 1821 in Fairfield, Herkimer county, New York, where his father was professor of chemistry in Fairfield Medical College. At the age of nine an accident lamed him for life. He graduated from Yale in 1842, having entered the Junior class in 1840; studied in the Theological Department of Yale, and in 1844-1845 was a tutor in Middlebury College. He was tutor at Yale in 1845-1848, assistant professor of Greek in 1848-1851, and professor of Greek, succeeding President Woolsey, from 1851 until his death in Hew Haven on the 14th of November 1872. As an undergraduate he showed himself an able mathematician, but the influence of Edward Elbridge Salisbury, under whom Hadley and W. D. Whitney studied Sanskrit together, turned his attention toward the study of language. He knew Greek, Latin, Sanskrit, Hebrew, Arabic, Armenian, several Celtic languages and the languages of modern Europe; but he published little, and his scholarship found scant outlet in the college class-room. His most original written work was an essay on Greek accent, published in a German version in Curtius's *Studien zur griechischen und lateinischen Grammatik*. Hadley's *Greek Grammar* (1860; revised by Frederic de Forest Allen, 1884) was based on Curtius's *Schulgrammatik* (1852, 1855, 1857, 1859), and long held its place in American schools. Hadley was a member of the American Committee for the revision of the New Testament, was president of the American Oriental Society (1871-1872), and contributed to Webster's dictionary an essay on the *History of the English Language*. In 1873 were published his *Introduction to Roman Law* (edited by T. D. Woolsey) and his *Essays, Philological and Critical* (edited by W. D. Whitney).

See the memorial by Noah Porter in *The New Englander*, vol. xxxii. (Jan. 1873), pp. 35-55; and the sketch by his son, A. T. Hadley, in *Biographical Memoirs of the National Academy of Sciences*, vol. v. (1905), pp. 247-254.

HADLEY, a township of Hampshire county, Massachusetts, U.S.A., on the Connecticut river, about 20 m. N. of Springfield, served by the Boston & Maine railway. Pop. (1900), 1789; (1905, state census), 1895; (1910) 1999. Area, about 20 sq. m. The principal villages are Hadley (or Hadley Center) and North Hadley. The level country along the river is well adapted to tobacco culture, and the villages are engaged in the manufacture of tobacco and brooms. Hadley was settled in 1659 by members

of the churches in Hartford and Wethersfield, Connecticut, who were styled "Strict Congregationalists" and withdrew from these Connecticut congregations because of ecclesiastical and doctrinal laxity there. At first the town was called Norwottuck, but within a year or two it was named after Hadleigh in England, and was incorporated under this name in 1661. Hopkins Academy (1815) developed from Hopkins school, founded here in 1664. The English regicides Edward Whalley and his son-in-law William Goffe found a refuge at Hadley from 1664 apparently until their deaths, and there is a tradition that Goffe or Whalley in 1675 led the people in repelling an Indian attack. From 1675 to 1713 Hadley, being in almost constant danger of attack from the Indians, was protected by a palisade enclosure and by stockades around the meeting-house. From Hadley, Hatfield was set apart in 1670, South Hadley in 1753, and Amherst in 1759.

See Alice M. Walker, *Historic Hadley* (New York, 1906); and Sylvester Judd, *History of Hadley* (Northampton, 1863; new ed., 1905).

HADRAMUT, a district on the south coast of Arabia, bounded W. by Yemen, E. by Oman and N. by the Dahna desert. The modern Arabs restrict the name to the coast between Balhâf and Sihut, and the valley of the Wadi Hadramut in the interior; in its wider and commonly accepted signification it includes also the Mahra and Gara coasts extending eastwards to Mirbat; thus defined, its limits are between 14° and 18° N. and 47° 30' to 55° E., with a total length of 550 m. and a breadth of 150 m.

The coastal plain is narrow, rarely exceeding 10 m. in width, and in places the hills extend to the seashore. The principal ports are Mukalla and Shihir, both considerable towns, and Kusair and Raida, small fishing villages; inland there are a few villages near the foot of the hills, with a limited area of cultivation irrigated by springs or wells in the hill torrent beds. Behind the littoral plain a range of mountains, or rather a high plateau, falling steeply to the south and more gently to the north, extends continuously from the Yemen highlands on the west to the mouth of the Hadramut valley, from which a similar range extends with hardly a break to the border of Oman. Its crest-line is generally some 30 m. from the coast, and its average height between 4000 and 5000 ft. A number of wadis or ravines cutting deeply into the plateau run northward to the main Wadi Hadramut, a broad valley lying nearly east and west, with a total length from its extreme western heads on the Yemen highlands to its mouth near Sihut of over 500 m. Beyond the valley and steadily encroaching on it lies the great desert extending for 300 m. to the borders of Nejd. The most westerly village in the main valley is Shabwa, in ancient days the capital, but now almost buried by the advancing desert. Lower down the first large villages are Henân and Ajlania, near which the wadis 'Amd, Duwân and el 'Ain unite, forming the W. Kasr. In the W. Duwân and its branches are the villages of Haura, el Hâjrîn, Kaidun and al Khurêba. Below Haura for some 60 m. there is a succession of villages with fields, gardens and date groves; several tributaries join on either side, among which the W. bin Ali and W. Adim from the south contain numerous villages. The principal towns are Shibâm, al Ghurfa, Saiyua, Tariba, el Ghuraf, Tarim, formerly the chief place, 'Ainat and el Kasim. Below the last-named place there is little cultivation or settled population. The shrines of Kabr Sâlih and Kabr Hud are looked on as specially sacred, and are visited by numbers of pilgrims. The former, which is in the Wadi Ser about 20 m. N.W. of Shibâm, was explored by Theodore Bent in 1894; the tomb itself is of no interest, but in the neighbourhood there are extensive ruins with Himyaritic inscriptions on the stones. Kabr Hud is in the main valley some distance east of Kasim; not far from it is Bir Borhut, a natural grotto, where fumes of burning sulphur issue from a number of volcanic vents; al-Masudi mentions it in the 10th century as an active volcano. Except after heavy rain, there is no running water in the Hadramut valley, the cultivation therefore depends on artificial irrigation from wells. The principal crops are wheat, millet, indigo, dates and tobacco; this latter, known as Hamum tobacco, is of excellent quality.

Hadramut has preserved its name from the earliest times; it occurs in Genesis as Hazarmaveth and Hadoram, sons of Joktan; and the old Greek geographers mention Adramytia and Chadramotites in their accounts of the frankincense country. The numerous ruins discovered in the W. Duwân and Adim, as well as in the main valley, are evidences of its former prosperity and civilization.

The people, known as Hadramî (plural Hadârim), belong generally to the south Arabian stock, claiming descent from Ya'rab bin Kahtân. There is, however, a large number of

Seyyids or descendants of the Prophet, and of townsmen of northern origin, besides a considerable class of African or mixed descent. Van den Berg estimates the total population of Hadramut (excluding the Mahra and Gāra) at 150,000, of which he locates 50,000 in the valley between Shibām and Tarim, 25,000 in the W. Duwān and its tributaries, and 25,000 in Mukalla, Shihr and the coast villages, leaving 50,000 for the non-agricultural population scattered over the rest of the country, probably an excessive estimate.

The Seyyids, descendants of Hosain, grandson of Mahomet, form a numerous and highly respected aristocracy. They are divided into families, the chiefs of which are known as Munsibs, who are looked on as the religious leaders of the people, and are even in some cases venerated as saints. Among the leading families are the Sheikh Abu Bakr of Aināt, the el-Aidrūs of Shihr and the Sakkāf of Saiyun. They do not bear arms, nor occupy themselves in trade or manual labour or even agriculture; though owning a large proportion of the land, they employ slaves or hired labourers to cultivate it. As compared with the other classes, they are well educated, and are strict in their observance of religious duties, and owing to the respect due to their descent, they exercise a strong influence both in temporal and spiritual affairs.

The tribesmen, as in Arabia generally, are the predominant class in the population; all the adults carry arms; some of the tribes have settled towns and villages, others lead a nomadic life, keeping, however, within the territory which is recognized as belonging to the tribe. They are divided into sections or families, each headed by a chief or abu (lit. father), while the head of the tribe is called the mukaddam or sultan; the authority of the chief depends largely on his personality: he is the leader in peace and in war, but the tribesmen are not his subjects; he can only rule with their support. The most powerful tribe at present in Hadramut is the Kaiti, a branch of the Yāfa tribe whose settlements lie farther west. Originally invited by the Seyyids to protect the settled districts from the attacks of marauding tribes, they have established themselves as practically the rulers of the country, and now possess the coast district with the towns of Shihr and Mukalla, as well as Haura, Hajrēn and Shibām in the interior. The head of the family has accumulated great wealth, and risen to the highest position in the service of the nizām of Hyderabad in India, as Jamadar, or commander of an Arab levy composed of his tribesmen, numbers of whom go abroad to seek their fortune. The Kathiri tribe was formerly the most powerful; they occupy the towns of Saiyun, Tarim and el-Ghuraf in the richest part of the main Hadramut valley. The chiefs of both the Kaiti and Kathiri are in political relations with the British government, through the resident at Aden (q.v.). The 'Amudi in the W. Duwān, and the Nahdi, Awāmīr and Tamīmī in the main valley, are the principal tribes possessing permanent villages; the Saibān, Hamūmī and Manāhīl occupy the mountains between the main valley and coast.

The townsmen are the free inhabitants of the towns and villages as distinguished from the Seyyids and the tribesmen: they do not carry arms, but are the working members of the community, merchants, artificers, cultivators and servants, and are entirely dependent on the tribes and chiefs under whose protection they live. The servile class contains a large African element, brought over formerly when the slave trade flourished on this coast; as in all Mahomedan countries they are well treated, and often rise to positions of trust.

As already mentioned, a large number of Arabs from Hadramut go abroad; the Kaiti tribesmen take service in India in the irregular troops of Hyderabad; emigration on a large scale has also gone on, to the Dutch colonies in Java and Sumatra, since the beginning of the 19th century. According to the census of 1885, quoted by Van den Berg in his *Report* published by the government of the Dutch East Indies in 1886, the number of Arabs in those colonies actually born in Arabia was 2500, while those born in the colonies exceeded 20,000; nearly all of the former are from the towns in the Hadramut valley between Shibām and Tarim. Mukalla and Shihr have a considerable

trade with the Red Sea and Persian Gulf ports, as well as with the ports of Aden, Dhafar and Muscat; a large share of this is in the hands of Parsee and other British Indian traders who have established themselves in the Hadramut ports. The principal imports are wheat, rice, sugar, piece goods and hardware. The exports are small; the chief items are honey, tobacco and sharks' fins. In the towns in the interior the principal industries are weaving and dyeing.

The Mahra country adjoins the Hadramut proper, and extends along the coast from Sihut eastwards to the east of Kamar Bay, where the Gāra coast begins and stretches to Mirbat. The sultan of the Mahra, to whom Sokotra also belongs, lives at Kishin, a poor village consisting of a few scattered houses about 30 m. west of Rās Fartak. Sihut is a similar village 20 m. farther west. The mountains rise to a height of 4000 ft. within a short distance of the coast, covered in places with trees, among which are the myrrh- and frankincense-bearing shrubs. These gums, for which the coast was celebrated in ancient days, are still produced; the best quality is obtained in the Gāra country, on the northern slope of the mountains. Dhafar and the mountains behind it were visited and surveyed by Mr Bent's party in 1894. There are several thriving villages on the coast, of which el-Hafa is the principal port of export for frankincense; 9000 cwt. is exported annually to Bombay.

Ruins of Sabæan buildings were found by J. T. Bent in the neighbourhood of Dhafar, and a remarkable cove or small harbour was discovered at Khor Rori, which he identified with the ancient port of Moscha.

AUTHORITIES.—L. Van den Berg, *Le Hadramut et les colonies arabes* (Batavia, 1885); L. Hirach, *Reise in Südarabien* (Leiden, 1897); J. T. Bent, *Southern Arabia* (London, 1895); A. von Wrde, *Reise in Hadramut* (Brunswick, 1870); H. J. Carter, *Trans. Bombay As. Soc.* (1845), 47-51; *Journal R.G.S.* (1837). (R. A. W.)

HADRIA [mod. *Atri* (q.v.)], perhaps the original terminal point of the Via Caecilia, Italy. It belonged to the Præetutii. It became a colony of Rome in 290 B.C. and remained faithful to Rome. The coins which it issued (probably during the Punic Wars), are remarkable. The crypt of the cathedral of the modern town was originally a large Roman cistern; another forms the foundation of the ducal palace; and in the eastern portion of the town there is a complicated system of underground passages for collecting and storing water.

See *Notizie degli scavi* (1902), 3.

(T. As.)

HADRIAN (PUBLIUS AELIUS HADRIANUS), Roman emperor A.D. 117-138, was born on the 24th of January A.D. 76, at Italica in Hispania Baetica (according to others, at Rome), where his ancestors, originally from Hadria in Picenum, had been settled since the time of the Scipios. On his father's death in 85 or 86 he was placed under the guardianship of two fellow-countrymen, his kinsman Ulpius Trajanus (afterwards the emperor Trajan), and Caelius Attianus (afterwards prefect of the praetorian guard). He spent the next five years at Rome, but at the age of fifteen he returned to his native place and entered upon a military career. He was soon, however, recalled to Rome by Trajan, and appointed to the offices of *decemvir stlitibus iudicandis*, *praefectus feriarum Latinarum*, and *sevir turmae equitum Romanorum*. About 95 he was military tribune in lower Moesia. In 97 he was sent to upper Germany to convey the congratulations of the army to Trajan on his adoption by Nerva; and, in January of the following year, he hastened to announce the death of Nerva to Trajan at Cologne. Trajan, who had been set against Hadrian by reports of his extravagance, soon took him into favour again, chiefly owing to the goodwill of the empress Plotina, who brought about the marriage of Hadrian with (Vibia) Sabina, Trajan's great-niece. In 101 Hadrian was quaestor, in 105 tribune of the people, in 106 praetor. He served with distinction in both Dacian campaigns; in the second Trajan presented him with a valuable ring which he himself had received from Nerva, a token of regard which seemed to designate Hadrian as his successor. In 107 Hadrian was *legatus praetorius* of lower Pannonia, in 108 *consul suffectus*, in 112 *archon* at Athens, *legatus* in the Parthian campaign (113-117), in 117 *consul designatus* for the following year, in 119 *consul* for the third and last time only for four months. When Trajan, owing to a severe illness, decided to return home from the East, he left Hadrian in command of the army and governor of Syria. On the 9th of August 117, Hadrian, at Antioch, was informed

of his adoption by Trajan, and, on the 11th, of the death of the latter at Selinus in Cilicia. According to Dio Cassius (lxxx. 1) the adoption was entirely fictitious, the work of Plotina and Attianus, by whom Trajan's death was concealed for a few days in order to facilitate the elevation of Hadrian. Whichever may have been the truth, his succession was confirmed by the army and the senate. He hastened to propitiate the former by a donative of twice the usual amount, and excused his hasty acceptance of the throne to the senate by alleging the impatient zeal of the soldiers and the necessity of an emperor for the welfare of the state.

Hadrian's first important act was to abandon as untenable the conquests of Trajan beyond the Euphrates (Assyria, Mesopotamia and Armenia), a recurrence to the traditional policy of Augustus. The provinces were unsettled, the barbarians on the borders restless and menacing, and Hadrian wisely judged that the old limits of Augustus afforded the most defensible frontier. Mesopotamia and Assyria were given back to the Parthians, and the Armenians were allowed a king of their own. From Antioch Hadrian set out for Dacia to punish the Roxolani, who, incensed by a reduction of the tribute hitherto paid them, had invaded the Danubian provinces. An arrangement was patched up, and while Hadrian was still in Dacia he received news of a conspiracy against his life. Four citizens of consular rank were accused of being concerned in it, and were put to death by order of the senate before he could interfere. Hurrying back to Rome, Hadrian endeavoured to remove the unfavourable impression produced by the whole affair and to gain the goodwill of senate and people. He threw the responsibility for the executions upon the prefect of the praetorian guard, and swore that he would never punish a senator without the assent of the entire body, to which he expressed the utmost deference and consideration. Large sums of money and games and shows were provided for the people, and, in addition, all the arrears of taxation for the last fifteen years (about £10,000,000) were cancelled and the bonds burnt in the Forum of Trajan. Trajan's scheme for the "alimentation" of poor children was carried out upon a larger scale under the superintendence of a special official called *praefectus alimentorum*.

The record of Hadrian's journeys¹ through all parts of the empire forms the chief authority for the events of his life down to his final settlement in the capital during his last years. They can only be briefly touched upon here. His first great journey probably lasted from 121 to 126. After traversing Gaul he visited the Germanic provinces on the Rhine, and crossed over to Britain (spring, 122), where he built the great rampart from the Tyne to the Solway, which bears his name (see BRITAIN: Roman). He returned through Gaul into Spain, and then proceeded to Mauretania, where he suppressed an insurrection. A war with the Parthians was averted by a personal interview with their king (123). From the Parthian frontier he travelled through Asia Minor and the islands of the Aegean to Athens (autumn, 125), where he introduced various political and commercial changes, was initiated at the Eleusinia, and presided at the celebration of the greater Dionysia. After visiting Central Greece and Peloponnesus, he returned by way of Sicily to Rome (end of 126). The next year was spent at Rome, and, after a visit to Africa, he set out on his second great journey (September 128). He travelled by way of Athens, where he completed and dedicated the buildings (see ATHENS) begun during his first visit, chief of which was the Olympieum or temple of Olympian Zeus, on which occasion Hadrian himself assumed the name of Olympius. In the spring of 129 he visited Asia Minor and Syria, where he invited the kings and princes of the East to a meeting (probably at Samosata). Having passed the winter at Antioch, he set out for the south (spring, 130). He ordered Jerusalem to be rebuilt (see JERUSALEM) under the name of Aelia Capitolina, and made his way through Arabia to Egypt, where he restored

¹ The chronology of Hadrian's journeys—indeed, of the whole reign—is confused and obscure. In the above the article by von Rohden in Pauly-Wissowa's *Realencyclopädie* has been followed. Weber's (see Bibliog.) is the most important discussion.

the tomb of Pompey at Pelusium with great magnificence. After a short stay at Alexandria he took an excursion up the Nile, during which he lost his favourite Antinous. On the 21st of November 130, Hadrian (or at any rate his wife Sabina) heard the music which issued at sunrise from the statue of Memnon at Thebes (see MEMNON). From Egypt Hadrian returned through Syria to Europe (his movements are obscure), but was obliged to hurry back to Palestine (spring, 133) to give his personal attention (this is denied by some historians) to the revolt of the Jews, which had broken out (autumn, 131, or spring, 132) after he had left Syria. The founding of a Roman colony on the site of Jerusalem (Dio Cass. lxxx. 12) and the prohibition of circumcision (Spartianus, *Hadrianus*, 14) are said to have been the causes of the war, but authorities differ considerably as to this and as to the measures which followed the revolt (see art. JEWS; also E. Schürer, *Hist. of the Jewish People*, Eng. tr., div. 1, vol. ii. p. 288; and S. Krauss in *Jewish Encyc. s.v. "Hadrian"*), which lasted till 135. Leaving the conduct of affairs in the hands of his most capable general, Julius Severus, in the spring of 134 Hadrian returned to Rome. The remaining years of his life were spent partly in the capital, partly in his villa at Tibur. His health now began to fail, and it became necessary for him to choose a successor, as he had no children of his own. Against the advice of his relatives and friends he adopted L. Ceionius Commodus under the name of L. Aelius Caesar, who was in a feeble state of health and died on the 1st of January 138, before he had an opportunity of proving his capabilities. Hadrian then adopted Arrius Antoninus (see ANTONINUS PIUS) on condition that he should adopt M. Annius Verus (afterwards the emperor Marcus Aurelius) and the son of L. Aelius Caesar, L. Ceionius Commodus (afterwards the emperor Commodus). Hadrian died at Baiae on the 10th of July 138.

He was without doubt one of the most capable emperors who ever occupied the throne, and devoted his great and varied talents to the interests of the state. One of his chief objects was the abolition of distinctions between the provinces and the mother country, finally carried out by Caracalla, while at the same time he did not neglect reforms that were urgently called for in Italy. Provincial governors were kept under strict supervision; extortion was practically unheard of; the *jus Latii* was bestowed upon several communities; special officials were instituted for the control of the finances; and the emperor's interest in provincial affairs was shown by his personal assumption of various municipal offices. New towns were founded and old ones restored; new streets were laid out and aqueducts, temples and magnificent buildings constructed. In Italy itself the administration of justice and the finances required special attention. Four *legati juridici* (or simply *juridici*) of consular rank were appointed for Italy, who took over certain important judicial functions formerly exercised by local magistrates (cases of *fideicommissa*, the nomination of guardians). The judicial council (*consilium Augusti*, later called *consistorium*), composed of persons of the highest rank (especially jurists), became a permanent body of advisers, although merely consultative. Roman law owes much to Hadrian, who instructed Salvius Julianus to draw up an *edictum perpetuum*, to a great extent the basis of Justinian's *Corpus juris* (see M. Schanz, *Geschichte der römischen Literatur*, iii. p. 167). In the administration of finance, in addition to the remission of arrears already mentioned, a revision of claims was ordered to be made every fifteen years, thereby anticipating the "indications" (see CALENDAR; CHRONOLOGY). Direct collection of taxes by imperial procurators was substituted for the system of farming, and a special official (*advocatus fisci*) was instituted to look after the interests of the imperial treasury. The gift of "coronary gold" (*aerum coronarium*), presented to the emperor on certain occasions, was entirely remitted in the case of Italy, and partly in the case of the provinces. The administration of the postal service throughout the empire was taken over by the state, and municipal officials were relieved from the burden of maintaining the imperial posts. Humane regulations as to the treatment of slaves were strictly

with regard both to one another and their common origin. His earliest attempt in the *General Morphology* was succeeded by many others, and his efforts in this direction may perhaps be held to culminate in the paper he read before the fourth International Zoological Congress, held at Cambridge in 1898, when he traced the descent of the human race in twenty-six stages from organisms like the still-existing *Monera*, simple structureless masses of protoplasm, and the unicellular *Protista*, through the chimpanzees and the *Pithecanthropus erectus*, of which a few fossil bones were discovered in Java in 1894, and which he held to be undoubtedly an intermediate form connecting primitive man with the anthropoid apes.

Not content with the study of the doctrine of evolution in its zoological aspects, Haeckel also applied it to some of the oldest problems of philosophy and religion. What he termed the integration of his views on these subjects he published under the title of *Die Welträtsel* (1899), which in 1901 appeared in English as *The Riddle of the Universe*. In this book, adopting an uncompromising monistic attitude, he asserted the essential unity of organic and inorganic nature. According to his "carbon-theory," which has been far from achieving general acceptance, the chemico-physical properties of carbon in its complex albuminoid compounds are the sole and the mechanical cause of the specific phenomena of movement which distinguish organic from inorganic substances, and the first development of living protoplasm, as seen in the *Monera*, arises from such nitrogenous carbon-compounds by a process of spontaneous generation. Psychology he regarded as merely a branch of physiology, and psychical activity as a group of vital phenomena which depend solely on physiological actions and material changes taking place in the protoplasm of the organism in which it is manifested. Every living cell has psychic properties, and the psychic life of multicellular organisms is the sum-total of the psychic functions of the cells of which they are composed. Moreover, just as the highest animals have been evolved from the simplest forms of life, so the highest faculties of the human mind have been evolved from the soul of the brute-beasts, and more remotely from the simple cell-soul of the unicellular Protozoa. As a consequence of these views Haeckel was led to deny the immortality of the soul, the freedom of the will, and the existence of a personal God.

Haeckel's literary output was enormous, and at the time of the celebration of his sixtieth birthday at Jena in 1894 he had produced 42 works with 13,000 pages, besides numerous scientific memoirs. In addition to the works already mentioned, he wrote *Freie Wissenschaft und freie Lehre* (1877) in reply to a speech in which Virchow objected to the teaching of the doctrine of evolution in schools, on the ground that it was an unproved hypothesis; *Die systematische Phylogenie* (1894), which has been pronounced his best book; *Anthropogenie* (1874, 5th and enlarged edition 1903), dealing with the evolution of man; *Über unsere gegenwärtige Kenntnis vom Ursprung des Menschen* (1898, translated into English as *The Last Link*, 1898); *Der Kampf um den Entwicklungsgedanken* (1905, English version, *Last Words on Evolution*, 1906); *Die Lebenswunder* (1904), a supplement to the *Riddle of the Universe*; books of travel, such as *Indische Reisebriefe* (1882) and *Aus Insulinde* (1901), the fruits of journeys to Ceylon and to Java; *Kunstformen der Natur* (1904), with plates representing beautiful marine animal forms; and *Wanderbilder* (1905), reproductions of his oil-paintings and water-colour landscapes.

There are biographies by W. Bölsche (Dresden, 1900, translated into English by Joseph McCabe, with additions, London, 1906) and by Breitenbach (Odenkirchen, 1904). See also Walther May; *Ernst Haeckel; Versuch einer Chronik seines Lebens und Werbens* (Leipzig, 1909).

HAEMATITE, or **HEMATITE**, a mineral consisting of ferric oxide (Fe_2O_3), named from the Greek word $\alpha\iota\mu\alpha$, "blood," in allusion to its typical colour, whence it is called also red iron ore. When crystallized, however, haematite often presents a dark colour, even iron-black; but on scratching the surface, the powder of the streak shows the colour of dried blood. Haematite crystallizes in the rhombohedral system, and is isomorphous

with corundum (Al_2O_3). The habit of the crystals may be rhombohedral, pyramidal or tabular, rarely prismatic. In fig. 1 the crystal, from Elba, shows a combination of the fundamental rhombohedron (R), an obtuse rhombohedron (s), and the hexagonal bipyramid (n). Fig. 2 is a tabular crystal in which the basal pinacoid (o) predominates. Haematite has no distinct cleavage, but may show, in consequence of a lamellar structure, a tendency to parting along certain planes.

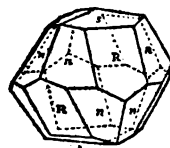

FIG. 1.

Crystallized haematite, such as that from the iron-mines of Elba, presents a steel-grey or iron-black colour, with a brilliant metallic lustre, sometimes beautifully iridescent. The splendent surface has suggested for this mineral such names as specular iron ore, looking-glass ore, and iron glance (*fer oligiste* of French writers). The hardness of the crystallized haematite is about 6, and the specific gravity 5.2. The so-called "iron roses" (*Eisenrosen*) of Switzerland are rosette-like aggregates of hexagonal tabular crystals, from fissures in the gneissose rocks of the Alps. Specular iron ore occurs in the form of brilliant metallic scales on many lavas, as at Vesuvius and Etna, in the Auvergne and the Eifel, and notably in the Island of Ascension, where the mineral forms beautiful tabular crystals. It seems to be a sublimation-product formed in volcanoes by the interaction of the vapour of ferric chloride and steam.



FIG. 2.

Specular haematite forms a constituent of certain schistose rocks, such as the Brazilian tabirite. In the Marquette district of Michigan (Lake Superior) schistose specular ore occurs in important deposits, associated with a Jasper rock, in which the ore alternates with bands of red quartzite. Micaceous iron ore consists of delicate steel-grey scales of specular haematite, unctuous to the touch, used as a lubricant and also as a pigment. It is worked in Devonshire under the name of shining ore. Very thin laminae of haematite, blood-red by transmitted light, occur as microscopic enclosures in certain minerals, such as carnallite and sun-stone, to which they impart colour and lustre.

Much haematite occurs in a compact or massive form, often mammillary, and presenting on fracture a fibrous structure. The reniform masses are known as kidney ore. Such red ore is generally neither so dense nor so hard as the crystals. It often passes into an earthy form, termed soft red ore, and when mixed with more or less clay constitutes red ochre, ruddle or reddie (Ger. *Rödel*).

The hard haematite is occasionally cut and polished as an ornamental stone, and certain kinds have been made into beads simulating black pearls. It was worked by the Assyrians for their engraved cylinder-seals, and was used by the gnostics for amulets. Some of the native tribes in the Congo basin employ it as a material for axes. The hard fibrous ore of Cumberland is known as pencil ore, and is employed for the burnishers used by bookbinders and others. Santiago de Compostela in Spain furnishes a considerable supply of haematite burnishers.

Haematite is an important ore of iron (*q.v.*), and is extensively worked in Elba, Spain (Bilbao), Scandinavia, the Lake Superior region and elsewhere. In England valuable deposits occur in the Carboniferous Limestone of west Cumberland (Whitehaven district) and north Lancashire (Ulverston district). The hard ore is siliceous, and fine crystallized specimens occur in association with smoky quartz. The ore is remarkably free from phosphorus, and is consequently valued for the production of pig-iron to be converted into Bessemer steel. (F. W. R.)

HAEMATOCELE (Gr. $\alpha\iota\mu\alpha$, blood, and $\kappa\eta\lambda\eta$, tumour), the medical term for a localized collection of blood in the tunica vaginalis or cord. It is usually the result of a sudden blow or severe strain, but may arise from disease. At first it forms a smooth, fluctuating, opaque swelling, but later becomes hard and firm. In chronic cases the walls of the tunica vaginalis

undergo changes. The treatment of a case seen soon after the injury is directed towards keeping the patient at rest, elevating the parts, and applying an evaporating lotion or ice-bag. In chronic cases it may be necessary to lay open the cavity and remove the coagulum.

HAEMOPHILIA, the medical term for a condition of the vascular system, often running in families, the members of which are known as "bleeders," characterized by a disposition towards bleeding, whether with or without the provocation of an injury to the tissue. When this bleeding is spontaneous it comes from the mucous membranes, especially from the nose, but also from the mouth, bowel and bronchial tubes. Slight bruises are apt to be followed by extravasations of blood into the tissues; the swollen joints (knee especially) of a bleeder are probably due, in a bright instance, to the escape of blood into the joint cavity or synovial membrane. It is always from the smallest vessels that the blood escapes, and may do so in such quantities as to cause death in a few hours.

HAEMORRHAGE (Gr. *αἷμα*, blood, and *ῥήγναι*, to burst), a general term for any escape of blood from a blood-vessel (see BLOOD). It commonly results from injury, as the tearing or cutting of a blood-vessel, but certain forms result from disease, as in scurvy and purpura. The chief varieties of hæmorrhage are *arterial*, *venous* and *capillary*. Bleeding from an artery is of a bright red colour, and escapes from the end of the vessel nearest the heart in jets synchronous with the heart's beat. Bleeding from a vein is of a darker colour; the flow is steady, and the bleeding is from the distal end of the vessel. Capillary bleeding is a general oozing from a raw surface. By *extravasation of blood* is meant the pouring out of blood into the areolar tissues, which become boggy. This is termed a *bruise* or *æchymosis*. *Epistaxis* is a term given to bleeding from the nose. *Hæmatemesis* is vomiting of blood, the colour of which may be altered by digestion, as is also the case in *melaena*, or passage of blood with the faeces, in which the blood becomes dark and tarry-looking from the action of the intestinal fluids. *Hæmoptysis* denotes an escape of blood from the air-passages, which is usually bright red and frothy from admixture with air. *Hæmaturia* means passage of blood with the urine.

Cessation of bleeding may take place from natural or from artificial means. Natural arrest of hæmorrhage arises from (1) the coagulation of the blood itself, (2) the diminution of the heart's action as in fainting, (3) changes taking place in the cut vessel causing its retraction and contraction. In the surgical treatment of hæmorrhage minor means of arresting bleeding are: cold, which is most valuable in general oozing and local extravasations; very hot water, 130° to 160° F., a powerful hæmostatic; position, such as elevation of the limb, valuable in bleeding from the extremities; styptics or astringents, applied locally, as perchloride of iron, tannic acid and others, the most valuable being suprarenal extract. In arresting hæmorrhage temporarily the chief thing is to press directly on the bleeding part. The pressure to be effectual need not be severe, but must be accurately applied. If the bleeding point cannot be reached, the pressure should be applied to the main artery between the bleeding point and the heart. In small blood-vessels pressure will be sufficient to arrest hæmorrhage permanently. In large vessels it is usual to pass a ligature round the vessel and tie it with a reef-knot. Apply the ligature, if possible, at the bleeding point, tying both ends of the cut vessel. If this cannot be done, the main artery of the limb must be exposed by dissection at the most accessible point between the wound and the heart, and there ligatured.

Hæmorrhage has been classified as—(1) primary, occurring at the time of the injury; (2) reactionary, or within twenty-four hours of the accident, during the stage of reaction; (3) secondary, occurring at a later period and caused by faulty application of a ligature or septic condition of the wound. In severe hæmorrhage, as from the division of a large artery, the patient may collapse and death ensue from syncope. In this case stimulants and strychnine may be given, but they should be avoided until it is certain the bleeding has been properly controlled, as they

tend to increase it. Transfusion of blood directly from the vein of a healthy person to the blood-vessels of the patient, and infusion of saline solution into a vein, may be practised (see SNOCK). In a congenital condition known as *hæmophylia* (q.v.) it is difficult to stop the flow of blood.

The surgical procedure for the treatment of an open wound is—(1) arrest of hæmorrhage; (2) cleansing of the wound and removal of any foreign bodies; (3) careful apposition of its edges and surfaces—the edges being best brought in contact by sutures of aseptic silk or catgut, the surfaces by carefully applied pressure; (4) free drainage, if necessary, to prevent accumulation either of blood or serous effusion; (5) avoidance of sepsis; (6) perfect rest of the part. These methods of treatment require to be modified for wounds in special situations and for those in which there is much contusion and laceration. When a special poison has entered the wound at the time of its infliction or at some subsequent date, it is necessary to provide against septic conditions of the wound itself and blood-poisoning of the general circulation.

HAEMORRHOIDS, or **HÆMORRHOÏDA** (from Gr. *αἷμα*, blood, and *ῥέω*, to flow), commonly called *piles*, swellings formed by the dilatation of veins of the lowest part of the bowel, or of those just outside the margin of its aperture. The former, *internal piles*, are covered by mucous membrane; the latter, *external piles*, are just beneath the skin. As the veins of the lining of the bowel become dilated they form definite bulgings within the bowel, and, at last increasing in size, escape through the anus when a motion is being passed. Growing still larger, they may come down spontaneously when the individual is standing or walking, and they are apt to be a grave source of pain or annoyance. Eventually they may remain constantly protruded—nevertheless, they are still *internal piles* because they arise from the interior of the bowel. Though a pile is sometimes solitary, there are usually several of them. They are apt to become inflamed, and the inflammation is associated with heat, pain, discharge and general uneasiness; ulceration and bleeding are also common symptoms, hence the term "bleeding piles." The *external pile* is covered by the thin dark-coloured skin of the anal margin. Severe pressure upon the large abdominal veins may retard the upward flow of blood to the heart and so give rise to piles; this is apt to happen in the case of disease of the liver, malignant and other tumours, and pregnancy. General weakness of the constitution or of the blood-vessels and habitual constipation may be predisposing causes of piles. The exciting cause may be vigorous straining at stool or exposure to damp, as from sitting on the wet ground. Piles are often only a symptom, and in their treatment this fact should be kept in view; if the cause is removed the piles may disappear. But in some cases it may be impossible to remove the cause, as when a widely-spreading cancerous growth of the rectum, or of the interior of the pelvis or abdomen, is blocking the upward flow of blood in the veins. Sometimes when a pile has been protruded, as during defæcation, it is tightly grasped by spasmodic contraction of the circular muscular fibres which guard the outlet of the bowel, and it then becomes swollen, engorged and extremely painful; the strangulation may be so severe that the blood in the vessels coagulates and the pile mortifies. This, indeed, is nature's attempt at curing a pile, but it is distressing, and, as a rule, it is not entirely successful.

The palliative treatment of piles consists in obtaining a daily and easy action of the bowels, in rest, cold bathing, astringent injections, lotions and ointments. The radical treatment consists in their removal by operation, but this should not be contemplated until palliative treatment has failed. The operation consists in drawing the pile well down, and strangling the vessels entering, and leaving its base, either by a strong ligature tightly applied, by crushing, or by cautery. Before dealing with the pile the anus is vigorously dilated in order that the pile may be dealt with with greater precision, and also that the temporary paralysis of the sphincter muscle, which follows the stretching, may prevent the occurrence of painful and spasmodic contractions subsequently. The ligatures by which the base of the piles are strangulated

slough off with the pile in about ten days, and in about ten days more the individual is, as a rule, well enough to return to his work. If, for one reason or another, no operation is to be undertaken, and the piles are troublesome, relief may be afforded by warm sponging and by Sitz-baths, the pile being gently dried afterwards by a piece of soft linen, smeared with vaseline, and carefully returned into the bowel. Under surgical advice, cocaine or morphia may be brought in contact with the tender parts, either in the form of lotion, suppository or ointment. In operating upon internal piles it is undesirable to remove all the external piles around the anus, lest the contraction of the circumferential scar should cause permanent narrowing of the orifice. If, as often happens, blood clots in the vein of an external pile, the small, hard, tender swelling may be treated with anodyne fomentations, or it may be rendered insensative by the ether spray and opened by a small incision, the clot being turned out.

(E. O.*)

HAEMOSPORIDIA, in zoology, an order of Ectospora, which although comparatively few in number and very inconspicuous in size and appearance, have of late years probably attracted greater attention and been more generally studied than any other Sporozoa; the reason being that they include the organisms well known as malarial parasites. In spite, however, of much and careful recent research—to a certain extent, rather, as a result of it—it remains the case that the Haemosporidia are, in some respects, the group of the Ectospora about which our knowledge is, for the time being, in the most unsatisfactory condition. Such important questions, indeed, as the scope and boundaries of the group, its exact origin and affinities, the rank and interclassification of the forms admittedly included in it, are answered quite differently by different workers. For example, one well-known Sporozoan authority (M. Lühe) has recently united the two groups, Haemosporidia and Haemoflagellates, bodily into one, while others (e.g. Novy and McNeal) deny that there is any connexion whatever between "Cytosoa" and Trypanosomes. Again, the inclusion or exclusion of forms like *Piroplasma* and *Halteridium* is also the subject of much discussion. The present writer accepts here the view that the Haemosporidia are derived from Haemoflagellates which have developed a gregariniform (Sporozoan) phase at the expense, largely or entirely, of the flagelliform one. The not inconsiderable differences met with among different types are capable of explanation on the ground that certain forms have advanced farther than others along this particular line of evolution. In other words, it is most probable that the Haemosporidia are to be regarded as comprising various parasites which represent different stages intermediate between, on the one side, a Flagellate, and on the other, a typical chlamydo-spore-forming Ectosporan parasite. While, however, it is easy enough sharply to separate off all Haemosporidia from other Ectospora, it is a very difficult matter to define their limits on the former side. Two principal criteria which a doubtful haemal parasite might very well be required to satisfy in order to be considered as a Haemosporidian rather than a Haemoflagellate are (a) the occurrence of schizogony during the "corpuscular" phase in the Vertebrate host, and (b) the formation of many germs ("sporozoites") from the zygote; so long as these conditions were complied with, the present writer, at all events, would not feel he was countenancing any protozoological heresy in allowing for the possibility of a Flagellate (perhaps trypaniform) phase or features being present at some period or other in the life-cycle.¹ To render this article complete, however, one or two well-known parasites, hitherto referred to this order, must also be mentioned, which, judged by the above (arbitrary) standard, are, it may be, on the Haemoflagellate side of the dividing line (e.g. *Halteridium*, according to Schaudinn).

The chief characters which distinguish the Haemosporidia from other Ectospora are the following. They are invariably blood parasites, and for part or all of the trophic period come into intimate relation with the cellular elements in the blood. There

¹ Compare, for example, the flagellated granules of certain Coccidia, which point unmistakably to a Flagellate ancestry.

is always an alternation of hosts and of generations, an Invertebrate being the definitive host, in which sexual conjugation is undergone and which is to be regarded as the primary one, a Vertebrate being the intermediate or secondary one. The zygote or sporont is at first capable of movement and known as an ookinete. No resistant spores (chlamydo-spores) are formed, the ultimate germs or sporozoites always being free in the oocyst and not enclosed by sporocysts.

To Sir E. Ray Lankester is due the honour of discovering the first Haemosporidian, a discovery which did not take place until after most of the other kinds of Sporozoa were known. In 1871 this author described the parasite of the frog, which he later termed *Drepanidium ranarum*. The next discovery was the great and far-reaching one of Laveran, who in 1883 described all the characteristic phases of the malarial parasite which are met with in human blood. While regarding the organism as the cause of the disease, Laveran did not at once recognise its animal and Sporozoan nature, but considered it rather as a vegetable, and termed it *Oscillaria malariae*. As in the case of the Trypanosomes, we owe to Danilewsky (1885-1889) the first serious attempts to study the comparative anatomy and life-history of these parasites, from a zoological point of view. Danilewsky first named them Haemosporidia, and distinguished between *Haemocytozoa* and *Leucocytozoa*. To the brilliant researches of R. Ross and Grassi in the closing years of the 19th century is due the realization of the essential part played by the gnat or mosquito in the life-cycle and transmission of the parasites; and to MacCallum belongs the credit of first observing the true sexual conjugation, in the case of a *Halteridium*. Since then, thanks to the labours of Argutinsky and Schaudinn, our knowledge of the malarial parasites has steadily increased. Until quite recently, however, very little was known about the Haemosporidia of cold-blooded Vertebrates; but in 1903 Siegel and Schaudinn demonstrated that the same rôle is performed in their case by a leech or a tick, and since then many new forms have been described.

The Haemosporidia are widely distributed and of very general occurrence among the chief classes of Vertebrates. Among Invertebrates they are apparently limited to blood-sucking insects, ticks and leeches.¹ As already stated, the universal habitat of the parasites in the Vertebrate is the blood; as a result, of course, they are to be met with in the capillaries of practically all the important organs of the body; and it is to be noted that while certain phases (e.g. growing trophozoites, mature gametocytes) are found in the peripheral circulation, others (e.g. schizogonous "rosettes," young gametocytes) occur in the internal organs, liver, kidneys, &c., where the circulation is sluggish. The relation of the parasites to the blood-cells varies greatly. Most attack, probably exclusively, the red blood corpuscles (haematids); a few, however, select the leucocytes, and are therefore known as Leucocytozoa. In the case of Mammalian and Avian forms (malarial parasites) Schaudinn and Argutinsky have shown that the trophic and schizogonic phases are not really endoglobular but closely attached to the corpuscle, hollowing out a depression or space into which they nestle; the gametocytes, on the other hand, are actually intercellular. Forms parasitic in cold-blooded Vertebrates, on the contrary, are always, so far as is known, endoglobular when in relation with the corpuscles; and the same is apparently the case with the Mammalian parasite, *Piroplasma*. Although in no instance so far described is the parasite actually intranuclear (as certain Coccidia are), in one or two cases (e.g. *Karyolysus* of lizards and certain species of *Haemogregarina*) it reacts markedly upon the nucleus and soon causes its disintegration. While many Haemosporidia (e.g. malarial parasites, with the exception of *Halteridium*) remain in connexion with the same corpuscle throughout the whole period of growth and schizogony, the new generation of merozoites first being set free from the broken-down cell, others (the Haemo-

Occurrence
habitat
effects on
host.

¹ A possible exception is a doubtful species of *Haemogregarina*, which has been described from the walls of the blood-vessels of an Annelid.

gregarines, broadly speaking, and also *Halteridium*) leave one corpuscle after a short time, wander about free in the plasma, and then seek out another; and this may be repeated until the parasite is ready for schizogony, which generally occurs in the corpuscle.

As in the case of Trypanosomes (*q.v.*), normally—that is to say, when in an accustomed, tolerant host, and under natural conditions—Haemosporidia are non-pathogenic and do not give rise to any ill-effects in the animals harbouring them. When, however, the parasites gain an entry into the blood of man or other unadapted animals,¹ they produce, as is well known, harmful and often very serious effects. There are three recognized types of malarial fever, each caused by a distinct form and characterized by the mode of manifestation. Two, the so-called benign fevers, are intermittent; namely, tertian and quartan fever, in which the fever recurs every second and third day respectively. This is due to the fact that schizogony takes different lengths of time in the two cases, 48 hours in the one, 72 in the other; the height of the fever-period coincides with the break-down of the corpuscle at the completion of the process, and the liberation of great numbers of merozoites in the blood. The third type is the dangerous aëstivo-autumnal or pernicious malaria, in which the fever is irregular or continuous during long periods.

A very general symptom is anaemia, which is sometimes present to a marked extent, when it may lead to a fatal termination. This is the result of the very considerable destruction of the blood-corpuscles which takes place, the haemoglobin of which is absorbed by the parasites as nutriment. A universal feature connected with this mode of nutrition is the production, in the cytoplasm of the parasite, of a brown pigment, termed melanin; this does not represent reserve material, but is an excreted by-product derived from the haemoglobin. These pigment-grains are at length liberated into the blood-stream and become deposited in the various organs, spleen, liver, kidneys, brain, causing pronounced pigmentation.

Another type of fever, more acute and more generally fatal, is that produced by forms belonging to the genus *Piroplasma*, in cattle, dogs, horses and other domestic animals in different regions of the globe; and recently Wilson and Chowning have stated that the "spotted fever of the Rockies" is a human piroplasmiasis caused by *P. hominis*. The disease of cattle is known variously as Texas-fever, Tristeza, Red-water, Southern cattle-fever, &c. In this type of illness the endogenous multiplication of the parasites is very great and rapid, and brings about an enormous diminution in the number of healthy red blood corpuscles. Their sudden destruction results in the liberation of large quantities of haemoglobin in the plasma, which turns deep-red in colour; and hence haemoglobinuria, which occurs only rarely in malaria, is a constant symptom in piroplasmiasis.

The parasite of pernicious malaria, here termed *Laverania malariae*, will serve very well as a type of the general life-cycle (fig. 1). Slight differences shown by the other malarial parasites

(*Plasmodium*) will be mentioned in passing, but the main divergences which other Haemosporidian types exhibit are best considered separately. With the bite of an infected mosquito, the minute sickle-like sporozoites are injected into the blood. They rapidly penetrate into the blood corpuscles, in which they appear as small irregular, more or less amoeboid trophozoites. A vacuole next arises in the cytoplasm, which increases greatly in size, and gives rise to the well-known, much discussed ring-form of the parasite, in which it resembles a signet-ring, the nucleus forming a little thickening to one side. Some authorities (*e.g.* Argutinsky) have regarded this structure as being really a greatly distended vesicular nucleus, and, to a large extent, indeed, an artifact, resulting from imperfect fixation; but Schaudinn considers it is a true vacuole, and explains it on the ground of the rapid nutrition

and growth. Later on this vacuole disappears, and the grains of pigment make their appearance. The trophozoite is now large and full-grown, and has become rounded and ready for schizogony. The nucleus of the schizont divides several times (more or less directly, by simple or multiple fission) to form a number of daughter-nuclei, which take up a regular position near the periphery. Around these the cytoplasm becomes segmented, giving rise to the well-known *corps en rosace*. Eventually the merozoites, in the form of little round uninuclear bodies, are liberated from the now broken-down corpuscle, leaving behind a certain amount of residual cytoplasm containing the pigment grains. Besides the difference in the time taken by the complete process of schizogony in the various species (see above), there are distinctions in the composition of the rosettes. Thus, in *Laverania*, the number of merozoites formed is very variable; in *Plasmodium vivax* (the tertian parasite) there are only few (9 to 12) merozoites, but in *P. malariae* (the quartan form) they are more numerous, from 32 to 24. The liberated merozoites proceed to infect fresh blood corpuscles and a new endogenous cycle is started.

After asexual multiplication has gone on for some time, sexual forms become developed. According to Schaudinn, the stimulus which determines the production of gametocytes instead of schizonts is the reaction of the host (at the height of a fever period) upon the parasites. A young trophozoite which is becoming a gametocyte is distinguished from one which gives rise to a schizont by its much slower rate of growth, and the absence of any vacuoles in its cytoplasm. The gametocytes themselves are characterized by their peculiar shape, like that of a sausage, whence they are very generally known as "crescents." Male and female gametocytes are distinguished (roughly) by the arrangement of the pigment-grains; in the former, they are fairly evenly scattered throughout the cytoplasm, but in the megagametocytes the pigment tends to be aggregated centrally, around the nucleus. As they become full-grown and mature, however, the gametocytes lose their crescentic form and assume that of an oval, and finally of a sphere. At the same time, they are set free from the remains of the blood corpuscle. The spherical stage is practically the limit of development in the Vertebrate host, although, sometimes, the nucleus of the microgametocyte may proceed to division. The "crescents" of the pernicious parasite afford a very important diagnostic difference from the gametocytes of both species of *Plasmodium*, which have the ordinary, rounded shape of the schizonts. In the case of the latter, points such as their slower growth, their less amoeboid character, and their size furnish the means of distinction.

When a gnat or mosquito sucks blood, all phases of the parasite in the peripheral circulation at that point may succeed in passing into the insect. If this occurs all trophic and schizogonic phases are forthwith digested, and the survival of the sexual phases depends entirely upon whether the insect is a gnat or mosquito. Only in the latter case can further development of the gametocytes go on; in other words, only the genus *Anopheles*, and not the genus *Culex*, furnishes specific hosts for the malarial parasites. This is a biological fact of considerable importance in connexion with the prophylactic measures against malaria. In the stomach of an *Anopheles*, the gametocytes quickly proceed to gamete-formation. The nucleus of the microgametocyte divides up, and the daughter-nuclei pass to the periphery. The surface of the body grows out into long, whip-like processes, of which there are usually 6 to 8 (probably the typical number is 8); each is very motile, in this respect strongly resembling a flagellum. This phase may also develop in drawn blood, which has, of course, become suddenly cooled by the exposure; and it seems evident that it is the change in temperature, from the warm to the cold-blooded host, which brings about the development of the actual sexual elements. Earlier observers regarded the phase just described as representing another parasite altogether, of a Flagellate nature—whence the well-known term, *Polymitus*-form; and even more recent workers, such as Labbé who connected it with the malarial parasite,

¹ For an interesting account of the biological relations between parasites and their hosts, and the penalty Man pays for his roving propensities, the reader should see Lankester's article in the *Quarterly Review*, July 1904.

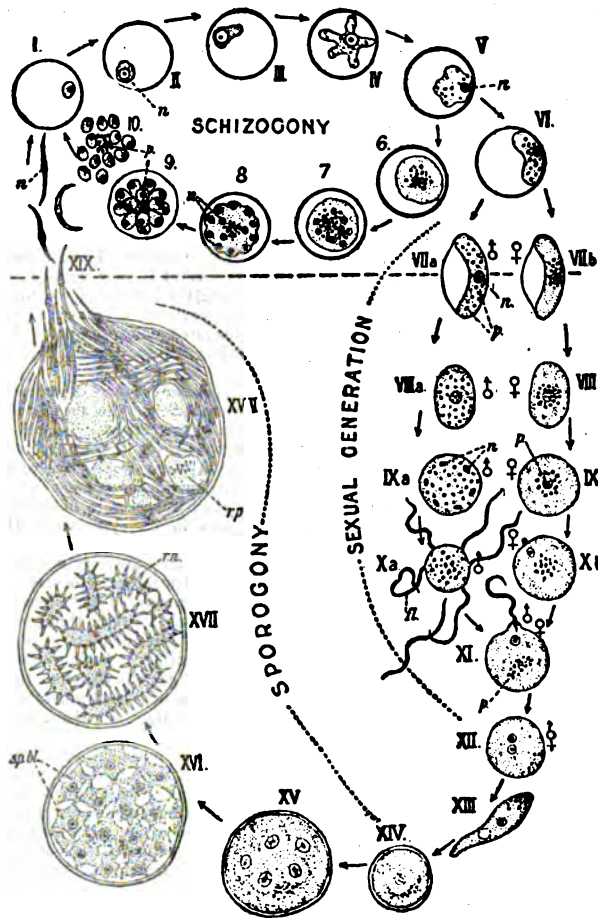

From Lankester's *Treatise on Zoology*.

FIG. 1.—Diagram of the complete life-cycle of the parasite of pernicious malaria, *Laverania malariae*, Gr. et Fel. The stages on the upper side of the dotted line are those found in human blood; below the dotted line are seen the phases through which the parasite passes in the intermediate host, the mosquito. Plan and arrangement chiefly after Neveu-Lemaire; details of the figures founded on those of Grassi, Schaudinn (Leuckart's *Zoologische Wandtafeln*), Ross and others.

- I.-V. and 6-10 show the asexual generation.
- VI.-XIII., The sexual generation.
- XIII., The motile zygote.
- XIV.-XIX., Sporogony.
- I.-III., Young amoebulae in blood-corpuses.
- IV., Older, actively amoeboid trophozoite.
- V., Still older, less amoeboid trophozoite.
- 6, Mature schizont.
- 7, Schizont, with nucleus dividing up.
- 8, Young rosette stage.
- 9, Fully formed rosette stage.
- 10, Merozoites free in the blood by breaking down of the corpuscle.
- VI., Young indifferent gametocyte.
- VII., σ , Male crescent.
- VII., β , Female crescent.
- VIII., σ and β , The gametocytes becoming oval.

- IX., σ and β , Spherical gametocytes; in the male (IX. σ) the nucleus has divided up.
- X., σ and β , Formation of gametes; in the male (X. σ) the so-called flagella or male gametes (β) are thrown out, one of them is seen detached; in the female (X. β) a portion of the nucleus has been expelled.
- XI., A male gamete penetrating a female gamete at a cone of reception formed near the nucleus.
- XII., Zygote with two pronuclei in proximity.
- XIII., Zygote in the motile stage (vermicule or ookinete).
- XIV., Encysted zygote (oöcyst).
- XV., Commencing multiplication of the nuclei in the oöcyst.
- XVI., Oöcyst with numerous sporoblasts.

failed to appreciate its true significance, and considered it rather as a degeneration-appearance. The micro-gametes soon liberate themselves from the residual cytoplasm of the parent and swim away in search of a megagamete; each is a very slender, wavy filament, composed largely of chromatic substance. The finer details of structure of the microgamete of a malarial parasite cannot be said, however, to be thoroughly known, and it is by no means impossible that its structure is really trypaniform, as, according to Schaudinn's great work, is the case with the merozoites and sporozoites.

The megagametocyte becomes a megagamete directly after a process of maturation, which consists in the expulsion of a certain amount of nuclear substance. The actual conjugation is quite similar to the process in Coccidia, and the resulting zygote perfectly homologous. In the present case, however, the zygote does not at once secrete an oocyst, with a thick resistant wall; on the contrary, it changes its shape, and becomes markedly gregariniform and active, and is known for this reason as an ookinete. The ookinete passes through the epithelial layer of the stomach, the thinner and more pointed end leading the way, and comes to rest in the connective tissue forming the outer layer of the stomach-wall (fig. 2). Here it becomes rounded and cyst-like, and grows considerably; for only a thin, delicate cyst-membrane is secreted, which does not impede the absorption of nutriment. Meanwhile, the nucleus has divided into several,

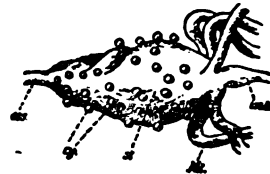

From Lankester's *Treatise on Zoology*.

FIG. 2.—Stomach of a mosquito, with cysts of Haemosporidia. (After Ross.)

- oes, Oesophagus. *Mt*, Malpighian tubules.
- st, Stomach.
- cy, Cysts.
- int, Intestine.

around each of which the cytoplasm becomes segmented. Each of these segments ("blastophores," "zoidophores") is entirely comparable to a sporoblast in the Coccidian oocyst, the chief difference being that it never forms a spore; moreover the segments or sporoblasts in the oocyst of a malarial parasite are irregular in shape and do not become completely separated from one another, but remain connected by thin cytoplasmic strands. Repeated multiplication of the sporoblast-nuclei next takes place, with the result that a great number of little nuclei are found all round the periphery. A corresponding number of fine cytoplasmic processes grow out from the surface, each carrying a nucleus with it, and in this manner a

XVII., Commencing formation of sporozoites.

XVIII., Full-grown oocyst crammed with ripe sporozoites; on one side the cyst has burst and the sporozoites are escaping.

XIX., Free sporozoites showing their changes of form.

σ , Nucleus of the parasite crammed with ripe sporozoites; on one side the cyst has burst and the sporozoites are escaping.

β , Melanin pigment.

β , Flagella.

sp. M., Sporoblasts.

r. n., Residual nuclei.

r. p., Residual protoplasm.

huge number of slender, slightly sickle-shaped germs or sporozoites ("blasts," "zooids" &c.) are formed. Each oocyst may contain from hundreds to thousands of sporozoites.

When the sporogony (which lasts about 10 days) is completed, the oocyst ruptures and the sporozoites are set free into the body-cavity, leaving behind a large quantity of residual cytoplasm, including pigment grains, &c. The sporozoites are carried about by the blood-stream; ultimately, however, apparently by virtue of some chemotactic attraction, they practically all collect in the salivary glands, filling the secretory cells and also invading the ducts. When the mosquito next bites a man, numbers of them are injected, together with the minute drop of saliva, into his blood, where they begin a fresh endogenous cycle.

There is only one other point with regard to the life-history that need be mentioned. With the lapse of time all trophic and schizogonic (asexual) phases of the parasite in the blood die off. But it has long been known that malarial patients, apparently quite cured, may suddenly exhibit all the symptoms again, without having incurred a fresh infection. Schaudinn has investigated the cause of this recurrence, and finds that it is due to the power of the megagametocytes, which are very resistant and long-lived, to undergo a kind of parthenogenesis under favourable conditions and give rise to the ordinary asexual schizonts, which in turn can repopulate the host with all the other phases. Microgametocytes, on the other hand, die off in time if they cannot pass into a mosquito.

Various types of form are to be met with among the Haemosporidia. In one, characteristic of most (though not of absolutely all) parasites of warm-blooded Vertebrates, the trophozoites are of irregular amoeboid shape; hence this section is generally known as the *Haemamoebidae*. In another type, characteristic of the parasites of cold-blooded Vertebrates, the body possesses a definite, vermiform, i.e. gregariniform shape, which is retained during the intracorporeal as well as during the free condition; this section comprises the *Haemogregarinidae*. Allied to this latter type of form are the trophozoites of *Piroplasma*, which are normally pear-shaped; they differ, however, in being very minute, and, moreover, exhibit considerable polymorphism, rod-like (so-called bacillary) and ring-forms being of common occurrence. It is important to note that in a certain species of *Haemogregarina* (fig. 3)

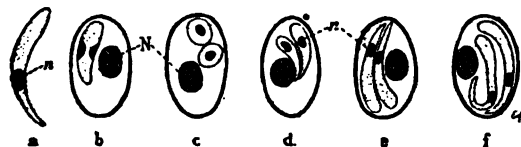

From Lankester's *Treatise on Zoology*.

FIG. 3.—*Haemogregarina bigemina*, Laveran, from the blood of blennies. (After Laveran, magnified about 1800 diameters.)

- a, The form of the parasite found free in the blood-plasma. N, Nucleus of the blood corpuscle. n, Nucleus of the parasite. The outline of the blood-corpuscle is indicated by a thick black line.
- b, Parasite within a blood-corpuscle, preparing for division; the nucleus has already divided.
- c, The parasite has divided into two rounded corpuscles,

the young trophozoites markedly resemble *Piroplasma* in their pyriform appearance; and a further point of agreement between the two forms is mentioned below. Lastly there is the Avian genus *Halleridium*, the trophozoites of which are characteristically bean-shaped or reniform. True *Haemogregarinae* also differ in other slight points from "Haemamoebae." Thus the young endoglobular trophozoite does not exhibit a ring (vacuolar) phase; and the cytoplasm never contains, at any period, the characteristic melanin pigment above noted. In some species of *Haemogregarina* the parasite, while intracorporeal, becomes surrounded by a delicate membrane, the cytocyst; on entering upon an active, "free" period, the cytocyst is ruptured and left behind with the remains of the corpuscle. A very interesting cytological feature is the occurrence, in one or two *Haemosporidia*, of nuclear dimorphism, i.e. of a larger and smaller chromatic body, probably comparable to the trophic and kinetic nuclei of a Trypanosome, or of the "Leishman-Donovan"

bodies. Schaudinn was the first to notice this character, in *Piroplasma canis*, and his observation has since been confirmed by Lühe.¹ Moreover, Kramp has also noticed nuclear dimorphism in the ookinete of a species of *Haemogregarina* in a leech (as the Invertebrate host)—a highly important observation.

As regards the life-history, the endogenous (schizogonic) cycle is known in many cases. Sometimes schizogony takes the primitive form of simple binary (probably) longitudinal fission; this is the case in *Piroplasma* (fig. 4) and also in *Haemogregarina bigemina* just referred to. From this result the pairs of individuals ("twins") so often found in the corpuscles. In addition, however, at any rate in *Piroplasma*, it is probable that multiple division (more allied to ordinary schizogony) also takes place; such is the case, according to Laveran, in *P. equi*, and the occurrence at times of four parasites in a corpuscle, arranged in a cruciform manner, is most likely to be thus explained. Labbé has described schizogony in *Halleridium*

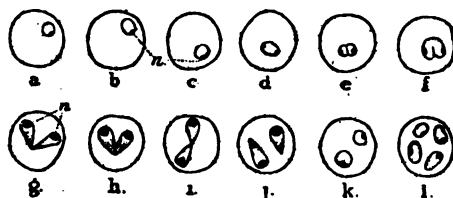

From Lankester's *Treatise on Zoology*.

FIG. 4.—Development and schizogony of *Piroplasma bigemina* in the blood-corpuscles of the ox. (After Laveran and Nicolle.)

- a, Youngest form. g, h, i, j, Various forms of the twin parasite.
- b, Slightly older. k and l, Doubly infected corpuscles.
- c and d, Division of the nucleus. e and f, Division of the body of the parasite.

danilewskyi as taking place in a rather peculiar manner; the parasite becomes much drawn-out and halter-like, and the actual division is restricted to its two ends, two clumps of merozoites being formed, at first connected by a narrow strand of unused cytoplasm, which subsequently disappears. Some doubt, however, attaches to this account, as no one else appears to have seen the process. For the rest, schizogony takes place more or less in the customary way, allowing for variations in the mode of arrangement of the merozoites. It remains to be noted that in *Karyolysus lacertarum*, according to Labbé, two kinds of schizont are developed, which give rise, respectively, to micromerozoites and megamerozoites, in either case enclosed in a delicate cytocyst. This probably corresponds to an early sexual differentiation (such as is found among certain Coccidia (q.v.), the micromerozoites producing eventually microgametocytes, the others megagametocytes.

It has now been recognized for some time that the sexual (exogenous) part of the life-cycle of all the *Haemamoebidae* takes place in an Invertebrate (Insectan) host, and is fundamentally similar to that above described in those cases where it has been followed. In contradistinction to the malarial parasites, this host, in the Avian forms (*Haemoproteus* and *Halleridium*),² is a species of *Culex* and not of *Anopheles*; in other words, gamete-formation, conjugation and subsequent sporozoite-formation in these cases will only go on in the former. On the other hand, in the case of the *Haemogregarinae*, it was thought until quite lately that the entire life-history, including conjugation and sporogony, went on in the Vertebrate host; and only in 1902 Hintze described what purported to be the complete life-history of *Lankesterella (Drepanidium) ranarum* undergone in the frog. This view was rendered obsolete by the work of Siegel and Schaudinn, who demonstrated the occurrence of an alternation of hosts and of generations in the case of *Haemogregarina stepanovi*, parasite in a tortoise, and in *Karyolysus lacertarum*; the Invertebrate hosts in which, in both cases, the sexual process is undergone, being respectively a leech (*Placobdella*) and a tick (*Ixodes*). With this discovery the main distinction (as supposed) between the *Haemosporidia* of warm and of cold-blooded Vertebrates vanished. It was further acknowledged by Schaudinn (under whom Hintze

¹ This does away with one of the principal reasons on account of which some authorities consider *Piroplasma (Leishmania) donovani* as quite distinct from other *Piroplasmata* (see TRYPANOSOMES).

² It must not be forgotten that one species of *Halleridium* (*H. [Trypanosomorpho] noctuae*) is said to have well-marked trypaniform phases in its life-cycle; these are preferably considered under Trypanosomes (q.v.), and therefore, to avoid repetition, are only thus alluded to here. Whether *H. danilewskyi* also becomes trypaniform in certain phases, and how far it really agrees with the criteria of a *Haemosporidia* above postulated, are matters which are not yet definitely known.

had worked) that the latter had been misled by Coccidian cysts and spores, which he took for those of *Lambasterella*. The gametogony and sporogony of *Haemogregarina stepanovi* in the leech agree in essential particulars with the process above described. The microgametes are extremely minute, and the sporozoites, which are developed in the salivary glands, where the motile ookinetes finally come to rest, are extremely "spirochaetiform"—the full significance of this latter fact being, perhaps, not appreciated.

Christophers recently described some remarkable phases which he regarded as belonging to the cycle of *Haemogregarina gerbilli* (one of the few Mammalian *Haemogregarinae* known) in a louse (*Haematopinus*). In a private communication, however, the author states that he has probably mistaken phases in the development of an ordinary gregarine parasite in the louse for part of the life-cycle of this *Haemogregarina*.

The Mammalian parasite *Piroplasma* is the one about whose life-history our knowledge is most vague. Besides the typical and generally occurring forms, others have also been observed in the blood, but it is doubtful how far these are to be looked upon as normal; for instance, Bowhill and Le Doux have described, in various species, a phase in which a long, slender pseudopodial-like outgrowth is present, with a swelling at the distal end. It is, moreover, quite uncertain which are the sexual forms, comparable to gametocytes. Doëlein regards large pear-shaped forms as such (megagametocytes?), which become spherical when maturing; and Nocard and Motaş have figured amoeboid, irregular forms, with the nucleus fragmented and possessing flagella-like processes (possibly microgametes?). In the Invertebrate host is well known to be, in the case of all species, a tick; thus bovine piroplasmiasis (*P. bigeminum*) in America is conveyed by *Rhipicephalus annulatus* (*Boophilus bovis*), canine piroplasmiasis (*P. canis*) in South Africa by *Haemaphysalis leachi* (and perhaps *Dermacentor reticulatus*), and so on. The manner in which the infection is transmitted by the tick varies greatly. In some cases (e.g. *P. bigeminum* and *P. canis*) only the generation subsequent to that which receives the infection (by feeding on an infected ox) can transmit it back again to another ox; in other words, true hereditary infection of the ova in the mother-tick is found to occur. The actual period in the life of the daughter-tick at which it can convey the infection apparently varies. On the other hand, in the case of East African coast-fever, Theiler found that hereditary infection does not occur, the same generation transmitting the parasite (*P. parvum*) at different periods of life. Little is certainly known regarding the phases of the parasite which are passed through in the tick. Lignières has observed a kind of multiple fission in the stomach, several very minute bodies, consisting mostly of chromatin, being formed, which may serve for endogenous reproduction. Koch has published an account of certain curious forms of *P. bigeminum*, in which the body is produced into many stiff, ray-like processes, giving the appearance of a star; according to him fusion of such forms takes place, and the resulting zygote becomes rounded, perhaps transitional to the pear-shaped forms.

The classification and nomenclature of the Haemosporidia are in a very unsettled condition. For an account of the various systems and modifications hitherto adopted, the article of Minchin (see under SPOROZOA: *Bibliography*), should be consulted.

With the realization that the life-history in the case of the "Haemamoebae" and the *Haemogregarinae* is fundamentally similar in type, the chief reason for grouping them as distinct sub-orders has disappeared. It is most convenient to regard them as separate, but closely allied families, the *Plasmodiidae* ("Haemamoebidae") and the *Haemogregarinidae*. The *Piroplasmata*, on the other hand, constitute another family, which is better placed in a distinct section or sub-order. In addition there are, as already noted, two or three genera whose systematic position must be considered as quite uncertain. One is the well-known *Halleridium* of Labbé, parasitic in various birds; the type-species is *H. danilewskyi* (Gr. and Fel.). Another is the much-debated parasite of white blood-corpuses (leucocytes), originally described in birds by Danilewsky under the name of *Leucocytosom*, a form of which has been recently observed in Mammals.

In conclusion, the chief members of the above-mentioned families may be enumerated.

Fam. *Plasmodiidae* ("Haemamoebidae").

Genus *Laverania*, Gr. and Fel. (syn. *Haemamoebas*, Ross), for *L. malariae*, Gr. and Fel. (syn. *L. s. Plasmodium*, s. "Haemamoeba," &c., *praecox s. immaculatum*, &c.), the parasite of pernicious malaria. Genus *Plasmodium*, March. and Celli (syn. "Haemamoeba") for *P. vivax* and *P. malariae*, the tertian and quartan parasite, respectively. There is also a form known in apes, *P. kochi*. Genus *Haemoproetus*, Kruse (syn. *Protosoma*), for *H. danilewskyi* (syn. *Protosoma praxii*, *Plasmodium praecox*, &c.), parasitic in numerous birds. Recently, another form has been described, from reptiles, which Castellani and Willey have termed *Haemocystidium simondi*.

Remarks.—The distinguishing characters of the malarial parasites

have been mentioned above. Some authorities would include *Laverania* in the genus *Plasmodium*, as differing only slightly from the other two forms. It has, moreover, been suggested by Sergent that all three are merely different phases of the same parasite, predominating at different seasons; this idea cannot be regarded, however, as in any way proved so far. From what is known of the

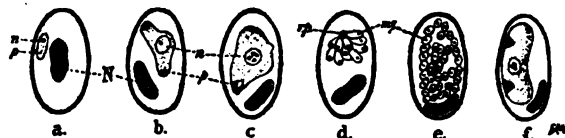

From Lankester's *Treatise on Zoology*.

FIG. 5.—*Haemoproetus danilewskyi*, Kruse (parasite of various birds). X about 1200. a, b, c and f from the chaffinch; d and e from the lark. (After Labbé.)

- a, Young trophozoite in a blood-corpuse.
b and c, Older trophozoite.
d, Precocious sporulation with few merozoites.
e, Sporulation of a full-grown

- schizont, with numerous merozoites.
f, Gametocyte.
N, Nucleus of blood-corpuse.
n, Nucleus of parasite.
p, Pigment.
m, Merozoites.
r, p, Residual protoplasm.

morphology and mode of manifestation of these forms, the differences between *Laverania* and the two species of *Plasmodium* are considerably more pronounced than those between *P. vivax* and *P. malariae*; if the latter are to be considered as distinct species, the first-named is probably generically distinct. Lühe, it may be noted, in his recent comprehensive account of the Haematozoa, also takes this view. Lastly, whatever be the correct solution of the above problem, there is certainly not sufficient justification for including the Avian genus *Haemoproetus*, as also only a species of *Plasmodium*, which is done by some. Its different Vertebrate habitat, and also the fact that its Insectan definitive host is *Culex* and not *Anopheles*, differentiate it sharply from *Laverania* and *Plasmodium*.

Fam. *Haemogregarinidae*.—The different genera are characterized

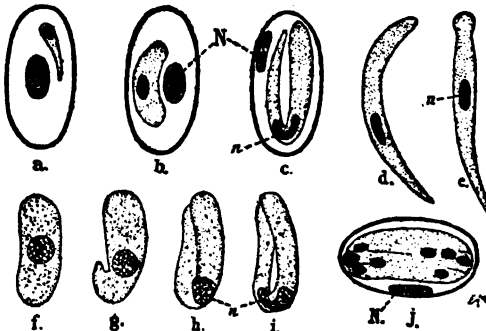

From Lankester's *Treatise on Zoology*.

FIG. 6.—*Haemogregarina stepanovi*, Danilewsky (par. *Emyz* and *Cistudo*), phases of the schizogony. (a-c and j after Laveran; f-i after Börner.) X1000 to 1200 diameters.

- a, Blood-corpuse with young trophozoite.
b, Older trophozoite.
c, Full-grown trophozoite, ready to leave the corpuse.
d and e, Trophozoites free in the blood-plasma, showing changes of form.
f-i, Trophozoites, still within the blood-corpuse (not drawn), showing the structure of the nucleus, the coarse chromatinoid granules in the protoplasm and the manner in

- which the parasite grows into the U-shaped *Haemogregarina* without increase of body-mass.
j, Commencement of sporulation; the nucleus has divided into eight nuclei, and the body of the parasite is beginning to divide up into as many merozoites within a blood-corpuse.
N, Nucleus of the blood-corpuse.
n, Nucleus of the parasite.

chiefly by their size relative to the blood-corpuses, and their disposition in the latter. Here, again, it has been suggested to unite the various types all in one genus, *Haemogregarina*, but this seems at least premature when it is remembered how little is known in most cases of the life-cycle, which may prove to exhibit important divergences.

Genus *Haemogregarina*, Danilewsky (syn. *Danilewskyia*, Labbé).

The body of the parasite exceeds the blood-corpuscle in length, when adult, and is bent upon itself, like a U. A very great number of species are known, mostly from reptiles and fishes; among them may be mentioned *H. stepanovi* (fig. 6), from *Emys* and *Cistudo*, whose sexual-cycle in a leech has been worked out by Siegel (see above), *H. delagei*, from *Raja*, *H. bigemina*, from blennies, and *H. simondi*, from soles. Recently one or two Mammalian forms have been observed, *H. gerbilli*, from an Indian rat (*Gerbillus*), and *H. jaculi*, from the ferret.

Genus *Lankesterella*, Labbé (syn. *Drepanidium*, Lankester). The parasite is not more than three-quarters the length of the corpuscle. *L. ranarum* from *Rana* is the type-species; another, recently described by Fantham, is *L. trilonis*, from the newt.

Genus *Karyolysus*, Labbé. The parasite does not exceed the corpuscle in length; the forms included in this genus, moreover,

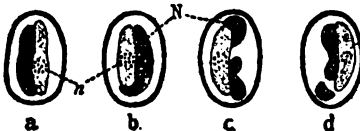

From Lankester's *Treatise on Zoology*.

FIG. 7.—*Karyolysus lacertarum* (Danil.), in the blood-corpuscles of *Lacerta muralis*, showing the effects of the parasite upon the nucleus of the corpuscle. In *c* and *d* the nucleus is broken up. N, Nucleus of the corpuscle; P, nucleus of the parasite, seen as a number of masses of chromatin, not enclosed by a distinct membrane. (After Marceau.)

although not actually intranuclear, have a marked karyolytic and disintegrating action upon the nucleus of the corpuscle. The type-species is the well-known *K. lacertarum*, of lizards; another is *K. (Haemogregarina) viperini*, from *Tropidonotus*.

In the section of the *Piroplasmata* there is only the genus *Piroplasma*, Patton (synn. *Babesia*, Starcovici, *Pyrosoma*, Smith and Kilborne), the principal species of which are as follows: *P. bigemina*, the cause of Texas cattle-fever, tick-fever (Rinder-malaria) of South Africa, and *P. bovis*, causing haemoglobinuria of cattle in Southern Europe; there is some uncertainty as to whether these two are really distinct; *P. canis*, *P. ovis* and *P. equi* associated, respectively, with those animals. Lately, a very small form, *P. parvum*, has been described by Theiler in Rhodesia, which causes East-African coast-fever; and another, *P. muris*, has been observed in white rats by Fantham.

BIBLIOGRAPHY.—(The older literature is enumerated in most treatises on Sporozoa—see bibliography under SPOROZOA). P. Argutinsky, "Malaria-studien," *Arch. mikr. Anat.* 59, p. 315, pls. 18-21 (1901), and *op. cit.* 61, p. 331, pl. 18 (1902); A. Balfour, "Haemogregarine of Mammals," *J. Trop. Med.* 8, p. 241, 8 figs. (1905); C. A. Bentley, "Leucocytozoan of the Dog," *B.M.J.* (1905), 1, pp. 988 and 1078; N. Berestneff, "Über einen neuen Blutparasiten der indischen Frösche," *Arch. Protistenk.* 2, p. 343, pl. 8 (1903); "Über das *Leucocytozoon danilewskyi*," *op. cit.* 3, p. 376, pl. 13 (1904); A. Billet, "Contribution à l'étude du paludisme et de son hématozoaire en Algérie," *Ann. Inst. Pasteur*, 16, p. 186 (1902); (Notes on various Haemogregarines), *C. R. Soc. Biol.* 56, pp. 482, 484, 607 and 741 (1904); C. Börner, "Untersuchungen über Hämospordien," *Zentralbl. wiss. Zool.* 69, p. 398, 1 pl. (1901); T. Bowhill, "Equine piroplasmia," *etc.*, *J. Hyg.* 5, p. 7, pls. 1-3 (1905); Bowhill and C. le Doux, "Contribution to the Study of *Piroplasma canis*," *op. cit.* 4, p. 217, pl. 11 (1904); E. Brumpt and C. Labbé, "Description de quelques nouvelles espèces de trypanosomes et d'hémogregarines," *etc.*, *C. R. Ac. Sci.* 139, p. 613 (1904); A. Castellani and A. Willey, "Observations on the Haematozoa of Vertebrates in Ceylon," *Spolia Zeylan.* 2, p. 78, 1 pl. (1904), and *Q. J. Micr. Sci.* 49, p. 383, pl. 24 (1905); S. R. Christophers, "Haemogregarina gerbilli," *Sci. Mem. India*, 18, 15 pp., 1 pl. (1905); H. B. Fantham, "Lankesterella trilonis, n. sp.," *etc.*, *Zool. Anz.* 29, p. 257, 17 figs. (1905); "Piroplasma muris," *etc.*, *Q. J. Micr. Sci.* 50, p. 493, pl. 28 (1906); C. Graham-Smith, "A new Form of Parasite found in the Red Blood-Corpuscles of Moles," *J. Hyg.* 5, p. 453, pls. 13 and 14 (1905); R. Hintze, "Lebensweise und Entwicklung von *Lankesterella minima*," *Zool. Jahrb. Anat.* 15, p. 693, pl. 36 (1902); S. James, "On a Parasite found in the White Blood-Corpuscles of Dogs," *Sci. Mem. India*, 14, 12 pp., 1 pl. (1905); R. Koch, "Vorläufige Mitteilungen über die Ergebnisse einer Forschungsreise nach Ostafrika," *Deutsch. med. Wochenschr.*, 1905, p. 1865, 24 figs.; A. Labbé, "Recherches sur les parasites endoglobulaires du sang des vertébrés," *Arch. zool. exp.* (3) 11, p. 95, 10 pls. (1904); R. Laveran, "Sur quelques hémogregarines des ophiidiens," *C. R. Ac. Sci.* 135, p. 1036, 13 figs. (1902); "Sur une Haemamoeba d'une mésozoë (*Parus major*)," *C. R. Soc. Biol.* 54, p. 1121, 10 figs. (1902); "Sur la piroplasmose bovine bacilliforme," *C. R. Ac. Sci.* 138, p. 648, 18 figs. (1903); "Contribution à l'étude de *Haemamoeba zimmermanni*," *C. R. Soc. Biol.* 55, p. 620, 7 figs. (1903);

"Sur une hémogregarine des gerboises," *C. R. Ac. Sci.* 141, p. 295, 9 figs. (1905); (On different Haemogregarines), *C. R. Soc. Biol.* 59, pp. 175, 176, with figs. (1903); "Haemocytozoa. Essai de classification," *Bull. Inst. Pasteur*, 3, p. 809 (1905); Laveran and F. Mesnil, "Sur les hématozoaires des poissons marins," *C. R. Ac. Sci.* 135, p. 567 (1902); "Sur quelques protozoaires parasites d'une tortue d'Asie," *l.c.* p. 609, 14 figs. (1902); Laveran and Nègre, "Sur un protozoaire parasite de *Hyalomma aegyptium*," *C. R. Soc. Biol.* 58, p. 964, 6 figs. (1903); (for various earlier papers by these authors, reference should be made to the *C. R. Ac. Sci.* and *C. R. Soc. Biol.* for previous years); C. Labbé, "On Piscine Haemogregarines," *C. R. Ac. Sci.* 139, p. 576 (1904), and *C. R. Soc. Biol.* 59, p. 304 (1905); J. Lignières, "Sur la 'Tristeza,'" *Ann. Inst. Pasteur*, 15, p. 121, pl. 6 (1901); "La Piroplasmose bovine: nouvelles recherches," *etc.*, *Arch. parasit.* 7, p. 398, pl. 4 (1903); M. Lühe, "Die im Blute schmarotzenden Protozoen," in *Mense's Handbuch der Tropenkrankheiten* (Leipzig, 1906), 3, 1; F. Marceau, "Note sur le *Karyolysus lacertarum*," *Arch. parasit.* 4, p. 135, 46 figs. (1901); W. MacCallum, "On the Haematozoan Infection of Birds," *J. Exp. Med.* 3, p. 117, pl. 12 (1898); G. Mauser, "Die Malaria perniciosa," *Centrbl. Bakter.* (1) 32, Orig. p. 695, 3 pls. (1902); C. Nicolle (On various Reptilian Haemogregarines), *C. R. Soc. Biol.* 56, pp. 330, 608 and 912, with figs. (1904); Nicolle and C. Comte, "Sur le rôle de *Hyalomma* . . . dans l'infection hémogregarinienne," *op. cit.* 58, p. 1045 (1905); Norcard and Motas, "Contribution à l'étude de la piroplasmose canine," *Ann. Inst. Pasteur*, 16, p. 256, pls. 5 and 6 (1902); G. Nuttall and G. Graham-Smith, "Canine piroplasmia," *J. Hygiene*, p. 237, pl. 9 (1905); F. Schaudinn, "Der Generationswechsel der Coccidien und Hämospordien," *Zool. Centrbl.* 6, p. 675 (1899); "Studien über krankheitsverzeugende Protozoen—II. *Plasmodium vivax*," *Arch. Kais. Gesundheitsamt.* 19, p. 169, pls. 4-6 (1902); E. and E. Sergeant (On different Haemogregarines), *C. R. Soc. Biol.* 56, pp. 130, 132 (1904), *op. cit.* 58, pp. 56, 57, 670 (1905); J. Siegel, "Die geschlechtliche Entwicklung von *Haemogregarina*," *etc.*, *Arch. Protistenk.* 2, p. 339, 7 figs. (1903); P. L. Simond, "Contribution à l'étude des hématozoaires endoglobulaires des reptiles," *Ann. Inst. Pasteur*, 15, p. 319, 1 pl. (1901); T. Smith and F. Kilborne, "Investigations into the Nature, Causation and Prevention of Texas Cattle Fever," *Rep. Bureau Animal Industry, U.S.A.*, 9 and 10, p. 177, pla. (1893); A. Theiler, "The *Piroplasma bigemina* of the Immune Ox," *J. Army Med. Corps*, 3, pp. 469, 599, 1 pl. (1904); J. Vassal, "Sur une hématozoaire endoglobulaire nouveau d'un mammifère," *Ann. Inst. Pasteur*, 19, p. 224, pl. 10 (1905); L. B. Wilson and W. Chowning, "Studies in *Piroplasmis hominis*," *J. Infect. Diseases*, 1, p. 31, 2 pls. (1904). (H. M. Wo.)

HAETZER, or HETZER, LUDWIG (d. 1529), Swiss divine, was born in Switzerland, at Bischofsfeld in Thurgau. He studied at Freiburg-im-Breisgau, and began his career in a chaplaincy at Wädenswil, on the Lake of Zürich. At this time his attachment to the old faith was tempered by a mystical turn, and by a devotion to the prophetic writings of the Old Testament, which he studied in the original. By 1523 we find him in Zürich, where he published, at first anonymously and in Latin (*Judicium Dei*), later with his name and in German (Sept. 24, 1523), a small tract against the religious use of images, and bearing the motto attached to all his subsequent works, "O Got erküss die (or dein) Gefangenen" ("O God, set the prisoners free"). An attempt to give effect to the teaching of this (frequently reprinted) tract was followed by a public religious disputation, of which Haetzer drew up the official account. In 1524 he brought out a tract on the conversion of the Jews, and published a German version of Johann Bugenhagen's brief exposition of the epistles of St Paul (Ephesians to Hebrews); in the dedication (dated Zürich, June 29, 1524) he undertakes to translate Bugenhagen's comment on the Psalter. He then went to Augsburg, bearing Zwingli's introduction to Johann Frosch. Here he came for a time under the influence of Urbanus Regius, and was for a short time the guest of Georg Regel. Returning to Zürich, he was in intercourse with leading Anabaptists (though his own position was simply the disuse of infant baptism) till their expulsion in January 1525. Again resorting to Augsburg, and resuming work as corrector of the press for his printer Silvan Ottmar, he pushed his views to the extreme of rejecting all sacraments, reaching something like the mystical standpoint of the early Quakers. He was expelled from Augsburg in the autumn of 1525, and made his way through Constance to Basel, where Oecolampadius received him kindly. He translated into German the first treatise of Oecolampadius on the Lord's Supper (in which the words of institution are taken figuratively), and proceeding to Zürich in November, published

his version there in February 1526, with a preface disclaiming connexion with the Anabaptists. His relations with Zwingli were difficult; returning to Basel he published (July 18, 1526) his translation of Malachi, with Oecolampadius's exposition, and with a preface reflecting on Zwingli. This he followed by a version of Isaiah xxxvi.-xxxvii. He next went to Strassburg, and was received by Wolfgang Capito. At Strassburg in the late autumn of 1526 he fell in with Hans Dengk or Denck, who collaborated with him in the production of his *opus magnum*, the translation of the Hebrew Prophets, *Alle Propheten nach hebraischer Sprach vertuetscht*. The preface is dated Worms, 3 April 1527; and there are editions, Worms, 13 April 1527, folio; Augsburg, 22 June 1527, folio; Worms, 7 Sept. 1527, 16^o; and Augsburg, 1528, folio. It was the first Protestant version of the prophets in German, preceding Luther's by five years, and highly spoken of by him. Haetzer and Denck now entered on a propagandist mission from place to place, with some success, but of short duration. Denck died at Basel in November 1527. Haetzer was arrested at Constance in the summer of 1528. After long imprisonment and many examinations he was condemned on the 3rd of February 1529 to die by the sword, and the sentence was executed on the following day. His demeanour on the scaffold impressed impartial witnesses, Hans Zwick and Thomas Blaurer, who speak warmly of his fervour and courage. The Dutch Baptist Martyrology describes him as "a servant of Jesus Christ." The Moravian Chronicle says "he was condemned for the sake of divine truth." His papers included an unpublished treatise against the essential deity of Christ, which was suppressed by Zwingli; the only extant evidence of his anti-trinitarian views being contained in eight quaint lines of German verse preserved in Sebastian Frank's *Chronica*. The discovery of his heterodox Christology (which has led modern Unitarians to regard him as their proto-martyr) was followed by charges of loose living, never heard of in his lifetime, and destitute of evidence or probability.

See Breitingen, "Anecdota quaedam de L. H." in *Museum Helveticum* (1746), parts 21 and 23; Wallace, *Antitrinitarian Biography* (1850); *Dutch Martyrology* (Hanserd Knollys Society) (1856); Th. Keim, in *Hauck's Realencyclopädie* (1899). (A. G. O.)

HĀFĪZ. Shams-ud-din Mahommed, better known by his *takhallus* or *nom de plume* of Hāfīz, was one of the most celebrated writers of Persian lyrical poetry. He was born at Shiraz, the capital of Fars, in the early part of the 8th century of the Mahommedan era, (that is to say, in the 14th of our own). The exact date of his birth is uncertain, but he attained a ripe old age and died in 791 A.H. (A.D. 1388). This is the date given in the chronogram which is engraved on his tomb, although several Persian biographers give a different year. Very little is actually known about his life, which appears to have been passed in retirement in Shiraz, of which he always speaks in terms of affectionate admiration. He was a subject of the Muzaffar princes, who ruled in Shiraz, Yazd, Kirman and Ispahan, until the dynasty was overthrown by Timur (Tamerlane). Of these princes his especial patrons were Shah Shujā' and Shah Mansūr. He early devoted himself to the study of poetry and theology, and also became learned in mystic philosophy, which he studied under Shaik Mahmūd 'Aṭṭār, chief of an order of dervishes. Hāfīz afterwards enrolled himself in the same order and became a professor of Koranic exegesis in a college which his friend and patron Haji Kiwam-ud-din, the vizier, specially founded for him. This was probably the reason of his adopting the sobriquet of Hāfīz ("one who remembers"), which is technically applied to any person who has learned the Koran by heart. The restraints of an ascetic life seem to have been very little to Hāfīz's taste, and his loose conduct and wine-bibbing propensities drew upon him the severe censure of his monastic colleagues. In revenge he satirizes them unmercifully in his verses, and seldom loses an opportunity of alluding to their hypocrisy. Hāfīz's fame as a poet was soon rapidly spread throughout the Mahommedan world, and several powerful monarchs sent him presents and pressing invitations to visit them. Amongst others he was invited by Mahmūd Shah Bahmani, who reigned in the south

of India. After crossing the Indus and passing through Lahore he reached Hurmuz, and embarked on board a vessel sent for him by the Indian prince. He seems, however, to have been a bad sailor, and, having invented an excuse for being put ashore, made the best of his way back to Shiraz. Some biographies narrate a story of an interview between Hāfīz and the invader Timur. The latter sent for him and asked angrily, "Art thou he who was so bold as to offer my two great cities Samarkand and Bokhara for the black mole on thy mistress's cheek?" alluding to a well-known verse in one of his odes. "Yes, sire," replied Hāfīz, "and it is by such acts of generosity that I have brought myself to such a state of destitution that I have now to solicit your bounty." Timur was so pleased at his ready wit that he dismissed the poet with a handsome present. Unfortunately for the truth of this story Timur did not capture Shiraz till A.D. 1393, while the latest date that can be assigned to Hāfīz's death is 1391. Of his private life little or nothing is known. One of his poems is said to record the death of his wife, another that of a favourite unmarried son, and several others speak of his love for a girl called *Shāhī i Nabat*, "Sugar-cane branch," and this is almost all of his personal history that can be gathered from his writings. He was, like most Persians, a Shi'ite by religion, believing in the transmission of the office of Imām (head of the Moslem Church) in the family of Ali, cousin of the prophet, and rejecting the *Hadīth* (traditional sayings) of Mahomet, which form the Sunna or supplementary code of Mahommedan ceremonial law. One of his odes which contains a verse in praise of Ali is engraved on the poet's tomb, but is omitted by Sudi, the Turkish editor and commentator, who was himself a rigid Sunnite. Hāfīz's heretical opinions and dissipated life caused difficulties to be raised by the ecclesiastical authorities on his death as to his interment in consecrated ground. The question was at length settled by Hāfīz's own works, which had then already begun to be used, as they are now throughout the East, for the purposes of divination, in the same manner as Virgil was employed in the middle ages for the divination called *Sortes Virgilianae*. Opening the book at random after pronouncing the customary formula asking for inspiration, the objectors hit upon the following verse—"Turn not away thy foot from the bier of Hāfīz, for though immersed in sin, he will be admitted into Paradise." He was accordingly buried in the centre of a small cemetery at Shiraz, now included in an enclosure called the *Hāfīziyeh*.

His principal work is the *Diwān*, that is, a collection of short odes or sonnets called *ghazals*, and consisting of from five to sixteen *baits* or couplets each, all the couplets in each ode having the same rhyme in the last hemistich, and the last couplet always introducing the poet's own *nom de plume*. The whole of these are arranged in alphabetical order, an arrangement which certainly facilitates reference but makes it absolutely impossible to ascertain their chronological order, and therefore detracts from their value as a means of throwing light upon the growth and development of his genius or the incidents of his career. They are often held together by a very slender thread of continuous thought, and few editions agree exactly in the order of the couplets. Still, a careful study of them, especially from the point of view indicated by the Sufistic system of philosophy, will always show that a single idea does run throughout the whole. The nature of these poems has been the subject of much discussion in the West, some scholars seeing in their anacreontic utterances nothing but sensuality and materialism, while others, following the Oriental school, maintain that they are wholly and entirely mystic and philosophic. Something between the two would probably be nearer the truth. It must be remembered that Hāfīz was a professed dervish and Sūfi, and that his *ghazals* were in all probability published from a *tākhia*, and arranged with at least a view to Sufistic interpretation. At the same time it is ridiculous to suppose that the glowing imagery, the gorgeous and often tender descriptions of natural beauties, the fervent love passages, and the roistering drinking songs were composed in cool blood or with deliberate ascetic purpose. The beauty of Hāfīz's poetry is that it is natural. It is the outcome

of a fervent soul and a lofty genius delighting in nature and enjoying life; and it is the poet's misfortune that he lived in an age and amongst a people where rigid conventionality demanded that his free and spontaneous thoughts should be recast in an artificial mould.

Besides the *Divān*, Hāfiz wrote a number of other poems; the Leipzig edition of his works contains 573 *ghazals* (forming the *Divān*), 42 *hi'as* or fragments, 69 *rubā'iyyāt* or tetrastrics, 6 *masnaviyyāt* or poems in rhyming couplets, 2 *hasid*, idylls or panegyrics, and 1 *mukhammas* or poem in five-line strophes. Other editions contain several *tarji'-band* or poems with a refrain. The whole *Divān* was translated into English prose by H. Wilberforce Clarke in 1891, with introduction and exhaustive commentary and bibliography; a few rhyming versions of single poems by Sir William Jones, J. Nott, J. Hindley, Falconer, &c., are to be found scattered through the pages of the *Oriental Miscellany* and other periodicals, and a fine edition containing a verse rendering of the principal poems by H. Ricknell appeared in 1875. Other selections by S. Robinson (1875), A. Rogers (1882), J. H. McCarthy (1893), and Gertrude L. Bell (1897). The principal German versions are by von Hammer Purgstall (1812), which gave the first impulse to Goethe's *Westfälischer Diwan*; a rhyming and rhythmical translation of a large portion of Hāfiz's works by Vincenz von Rosenzweig of Vienna (Vienna, 1858), which contains also the Persian text and notes; *Der Diwan des Scheins-eddin Muhammed Hāfiz*, by G. H. F. Nesselmann (Berlin, 1865), in which the rhyming system of the original is imitated. Besides these, the reader may consult d'Herbelot, *Bibliothèque orientale*, article "Hāfiz"; Sir William Ouseley's *Oriental Collections* (1797-1798); *A Specimen of Persian Poetry, or Odes of Hafiz*, by John Richardson (London, 1802); *Biographical Notices of Persian Poets*, by Sir Gore Ouseley (*Oriental Translation Fund*, 1846); and an excellent article by Professor E. B. Cowell in *Macmillan's Magazine* (No. 177, July 1874); J. A. Vullers, *Vitae poetarum Persicorum* (1839, translated from Daulatshah); S. Robinson, *Persian Poetry for English Readers* (1883). The best edition of the text is perhaps that edited by Hermann Brockhaus of Leipzig (1854-1856), which is based on the recension of the Turkish editor Sudi, and contains his commentary in Turkish on the first eighty *ghazals*. See also H. Ethé in *Geschichte der iranischen Philologie*, II. (Strassburg, 1896); P. Horn, *Geschichte der persischen Literatur* (Leipzig, 1901). (E. H. P.)

HAG. (1) (Probably a shortened form of the O. Eng. *hæglesse*, *hægles*, cognate with Ger. *Hexe*, witch, Dutch *hecce*), a word common during the 16th and 17th centuries for a female demon or evil spirit, and so particularly applied to such supernatural beings as the harpies and fairies of classical mythology, and also to witches. In modern usage the word is generally used of a hideous old woman whose repulsive exterior is accompanied by malice or wickedness. The name is also used of an eel-like parasitic fish, *Myxine glutinosa*, allied to the lamprey.

(2) A word common in Scottish and northern English dialects for an enclosed piece of wood, a copse. This is the same word as "hedge" (see HEDGES) and "haw." "Hag" also means "to cut," and is used in Scotland of an extent of woodland marked out for felling, and of a quantity of felled wood. This word is also used of a cutting in the peat of a "moss" or "bog," and hence applied to the small plots of firm ground or heather in a bog; it is common in the form "moss-hags."

HAGEDORN, FRIEDRICH VON (1708-1754), German poet, was born on the 23rd of April 1708 at Hamburg, where his father, a man of scientific and literary taste, was Danish minister. He was educated at the gymnasium of Hamburg, and later (1726) became a student of law at Jena. Returning to Hamburg in 1729, he obtained the appointment of unpaid private secretary to the Danish ambassador in London, where he lived till 1731. Hagedorn's return to Hamburg was followed by a period of great poverty and hardship, but in 1733 he was appointed secretary to the so-called "English Court" (*Englischer Hof*) in Hamburg, a trading company founded in the 13th century. He shortly afterwards married, and from this time had sufficient leisure to pursue his literary occupations till his death on the 28th of October 1754. Hagedorn is the first German poet who bears unmistakable testimony to the nation's recovery from the devastation wrought by the Thirty Years' War. He is eminently a social poet. His light and graceful love-songs and anacronics, with their undisguised *joie de vivre*, introduced a new note into the German lyric; his fables and tales in verse are hardly inferior in form and in delicate persiflage to those of his master La Fontaine, and his moralizing poetry re-echoes the philosophy

of Horace. He exerted a dominant influence on the German lyric until late in the 18th century.

The first collection of Hagedorn's poems was published at Hamburg shortly after his return from Jena in 1729, under the title *Versuch einiger Gedichte* (reprinted by A. Sauer, Heilbronn, 1883). In 1738 appeared *Versuch in poetischen Fabeln und Erzählungen*; in 1742 a collection of his lyric poems, under the title *Sammlung neuer Oden und Lieder*; and his *Moralische Gedichte* in 1750. A collection of his entire works was published at Hamburg after his death in 1757. The best is J. J. Eschenburg's edition (5 vols., Hamburg, 1800). Selections of his poetry with an excellent introduction in F. Muncker's *Anakreoniker und preussisch-patriotische Lyriker* (Stuttgart, 1894). See also H. Schuster, *F. von Hagedorn und seine Bedeutung für die deutsche Literatur* (Leipzig, 1882); W. Eigenbrodt, *Hagedorn und die Erzählung in Keimern* (Berlin, 1884).

HAGEN, FRIEDRICH HEINRICH VON DER (1780-1856), German philologist, chiefly distinguished for his researches in Old German literature, was born at Schmiedeberg in Brandenburg on the 19th of February 1780. After studying law at the university of Halle, he obtained a legal appointment in the state service at Berlin, but in 1806 resigned this office in order to devote himself exclusively to letters. In 1810 he was appointed *professor extraordinarius* of German literature in the university of Berlin; in the following year he was transferred in a similar capacity to Breslau, and in 1821 returned to Berlin as *professor ordinarius*. He died at Berlin on the 11th of June 1856. Although von der Hagen's critical work is now entirely out of date, the chief merit of awakening an interest in old German poetry belongs to him.

His principal publications are the *Nibelungenlied*, of which he issued four editions, the first in 1810 and the last in 1842; the *Minnesinger* (Leipzig, 1836-1856, 4 vols. in 3 parts); *Lieder der ältern Edda* (Berlin, 1812); *Gottfried von Strassburg* (Berlin, 1823); a collection of Old German tales under the title *Gesamtschöpfung* (Stuttgart, 1850, 3 vols.) and *Das Heldenbuch* (Leipzig, 1855). He also published *Über die ältesten Darstellungen der Faustsage* (Berlin, 1844); and from 1835 he edited *Das neue Jahrbuch der Berlinischen Gesellschaft für deutsche Sprache und Alterthumskunde*. His correspondence with C. G. Heyne and G. F. Benecke was published by K. Dziatzko (Leipzig, 1893).

HAGEN, a town of Germany, in the Prussian province of Westphalia. Pop. (1905), 77,498. It lies amid well-wooded hills at the confluence of the Ennepe with the Volme, 15 m. N.E. of Elberfeld, on the main line to Brunswick and Berlin, and at the junction of important lines of railway, connecting it with the principal towns of the Westphalian iron district. It has five Evangelical churches, a Roman Catholic church, an Old Catholic church, a synagogue, a gymnasium, realgymnasium, and a technical school with special classes for machine-building. There are also a museum, a theatre, and a prettily arranged municipal park. Hagen is one of the most flourishing commercial towns in Westphalia, and possesses extensive iron and steel works, large cotton print works, woollen and cotton factories, manufactures of leather, paper, tobacco, and iron and steel wares, breweries and distilleries. There are large limestone quarries in the vicinity and also an alabaster quarry.

HAGENAU, a town of Germany, in the imperial province of Alsace-Lorraine, situated in the middle of the Hagenau Forest, on the Moder, and on the railway from Strassburg to Weissenburg, 10 m. N.N.E. of the former city. Pop. (1905), 18,500. It has two Evangelical and two ancient Catholic churches (one dating from the 12th, the other from the 13th century), a gymnasium, a public library, a hospital, and a theatre. The principal industries are wool and cotton spinning, and the manufacture of porcelain, earthenware, boots, soap, oil, sparkling wines and beer. There is also considerable trade in hops and vegetables. Hagenau is an important military centre and has a large garrison, including three artillery battalions.

Hagenau dates from the beginning of the 12th century, and owes its origin to the erection of a hunting lodge by the dukes of Swabia. The emperor Frederick I. surrounded it with walls and gave it town rights in 1154. On the site of the hunting lodge he founded an imperial palace, in which were preserved the jewelled imperial crown, sceptre, imperial globe, and sword of Charlemagne. Subsequently it became the seat of the *Landvogt*

of Cornau, the imperial *advocatus* in Lower Alsace. Richard of Hagenau, king of the Romans, made it an imperial city in 1257. In 1648 it came into the possession of France, and in 1673 Louis XIV. caused the fortifications to be razed. In 1675 it was captured by imperial troops, but in 1677 it was retaken by the French and nearly all destroyed by fire. In 1871 it fell, with the rest of Alsace-Lorraine, into the possession of Germany.

HAGENBACH, KARL RUDOLF (1801-1874), German church historian, was born on the 4th of March 1801 at Basel, where his father was a practising physician. His preliminary education was received at a Pestalozzian school, and afterwards at the gymnasium, whence in due course he passed to the newly reorganized local university. He early devoted himself to theological studies and the service of the church, while at the same time cherishing and developing broad "humanistic" tendencies which found expression in many ways and especially in an enthusiastic admiration for the writings of Herder. The years 1820-1823 were spent first at Bonn, where G. C. F. Lücke (1791-1855) exerted a powerful influence on his thought, and afterwards at Berlin, where Schleiermacher and Neander became his masters. Returning in 1823 to Basel, where W. M. L. de Wette had recently been appointed to a theological chair, he distinguished himself greatly by his trial-dissertation, *Observationes historico-hermeneuticæ circa Origenis methodum interpretandæ sacræ Scripturæ*; in 1824 he became professor extraordinarius, and in 1829 professor ordinarius of theology. Apart from his academic labours in connexion with the history of dogma and of the church, he lived a life of great and varied usefulness as a theologian, a preacher and a citizen; and at his "jubilee" in 1873, not only the university and town of Basel but also the various churches of Switzerland united to do him honour. He died at Basel on the 7th of June 1874.

Hagenbach was a voluminous author in many departments, but he is specially distinguished as a writer on church history. Though neither so learned and condensed as the contributions of Gieseler, nor so original and profound as those of Neander, his lectures are clear, attractive and free from narrow sectarian prejudice. In dogmatics, while avowedly a champion of the "mediation theology" (*Vermittlungstheologie*), based upon the fundamental conceptions of Herder and Schleiermacher, he was much less revolutionary than were many others of his school. He sought to maintain the old confessional documents, and to make the objective prevail over the purely subjective manner of viewing theological questions. But he himself was aware that in the endeavour to do so he was not always successful, and that his delineations of Christian dogma often betrayed a vacillating and uncertain hand.

His works include *Tabellarische Übersicht der Dogmengeschichte* (1828); *Encyclopædie u. Methodologie der theol. Wissenschaften* (1833); *Vorlesungen über Wesen u. Geschichte der Reformation u. des Protestantismus* (1834-1843); *Lehrbuch der Dogmengeschichte* (1840-1841, 5th ed., 1867; English transl., 1850); *Vorlesungen über die Geschichte der alten Kirche* (1853-1855); *Vorlesungen über die Kirchengeschichte des Mittelalters* (1860-1861); *Grundlinien der Homiletik u. Liturgik* (1863); biographies of Johannes Oecolampadius (1482-1564) and Oswald Myconius (1488-1552) and a *Geschichte der theol. Schule Basels* (1860); his *Predigten* (1858-1875), two volumes of poems entitled *Luther u. seine Zeit* (1838), and *Gedichte* (1846). The lectures on church history under the general title *Vorlesungen über die Kirchengeschichte von der ältesten Zeit bis zum 19ten Jahrhundert* were reissued in seven volumes (1868-1872).

See especially the article in Herzog-Hauck, *Realencyclopædie*.

HAGENBECK, CARL (1844-), wild-animal collector and dealer, was born at Hamburg in 1844. In 1848 his father purchased some seals and a Polar bear brought to Hamburg by a whaler, and subsequently acquired many other wild animals. At the age of twenty-one Carl Hagenbeck was given the whole collection, and before long had greatly extended the business, so that in 1873 he had to erect large buildings in Hamburg to house his animals. In 1875 he began to exhibit a collection of the representative animals of many countries, accompanied by troupes of the natives of the respective countries, throughout all the large cities of Europe. The educational value of these exhibitions was officially recognized by the French government,

which in 1891 awarded Hagenbeck the diploma of the Academy. Most of the wild animals exhibited in music-halls and other popular places of entertainment throughout the world have come from Hagenbeck's collection at Stellingen, near Hamburg.

HAGERSTOWN, a city and the county-seat of Washington county, Maryland, U.S.A., near Antietam Creek, about 86 m. by rail W.N.W. from Baltimore. Pop. (1890), 10,118; (1900), 13,591, of whom 1277 were negroes; (1920, census), 16,597. Hagerstown is served by the Baltimore & Ohio, the Western Maryland, the Norfolk & Western, and the Cumberland Valley railways, and by an interurban electric line. It lies in a fertile valley overlooked by South Mountain to the E. and North Mountain, more distant, to the W. The city is the seat of Ke Mar College (1852; non-sectarian) for women. Hagerstown is a business centre for the surrounding agricultural district, has good water power, and as a manufacturing centre ranked third in the state in 1905, its factory products being valued in that year at \$3,026,001, an increase of 66.3% over their value in 1900. Among the manufactures are flour, shirts, hosiery, gloves, bicycles, automobiles, agricultural implements, print paper, fertilizers, sash, doors and blinds, furniture, carriages, spokes and wheels. The municipality owns and operates its electric lighting plant. Hagerstown was laid out as a town in 1762 by Captain Jonathan Hager (who had received a patent to 200 acres here from Lord Baltimore in 1739), and was incorporated in 1791. It was an important station on the old National (or Cumberland) Road. General R. E. Lee concentrated his forces at Hagerstown before the battle of Gettysburg.

HAG-FISH, GLUTINOUS HAG, or BORER (*Myxine*), a marine fish which forms with the lampreys one of the lowest orders of vertebrates (*Cyclostomata*). Similar in form to a lamprey, it is usually found within the body of dead cod or haddock, on the flesh of which it feeds after having buried itself in the abdomen. When caught, it secretes a thick glutinous slime in such quantity that it is commonly believed to have the power of converting water into glue. It is found in the North Atlantic and other temperate seas of the globe, being taken in some localities in large numbers, e.g. off the east coast of Scotland and the west coast of California (see *CYCLOSTOMATA*).

HAGGADA, or 'AGADA (literally "narrative"), includes the more homiletic elements of rabbinic teaching. It is not logically distinguishable from the halakha (*q.v.*), for the latter or forensic element makes up with the haggada the Midrash (*q.v.*), but, being more popular than the halakha, is often itself styled the Midrash. It may be described as the poetical and ethical element as contrasted with the legal element in the Talmud (*q.v.*), but the two elements are always closely connected. From one point of view the haggada, amplifying and developing the contents of Hebrew scripture in response to a popular religious need, may be termed a rabbinical commentary on the Old Testament, containing traditional stories and legends, sometimes amusing, sometimes trivial, and often beautiful. The haggada abounds in parables. The haggadic passages of the Talmud were collected in the *Eye of Jacob*, a very popular compilation completed by Jakob ibn Habib in the 16th century.

HAGGAI, in the Bible, the tenth in order of the "minor prophets," whose writings are preserved in the Old Testament. The name Haggai (*חגי*, Gr. Ἁγγῆος, whence Aggeus in the English version of the Apocrypha) perhaps means "born on the feast day," "festive." But Wellhausen¹ is probably right in taking the word as a contraction for Hagariah ("Yahweh hath girded"), just as Zaccal (Zacchæus) is known to be a contraction of Zechariah.

The book of Haggai contains four short prophecies delivered between the first day of the sixth month and the twenty-fourth day of the ninth month—that is, between September and December—of the second year of Darius the king. The king in question must be Darius Hystaspis (521-485 B.C.). The language of the prophet in ii. 3 suggests the probability that he was himself one of those whose memories reached across the seventy years of the captivity, and that his prophetic work began in exile.

¹ In Bleek's *Einleitung*, 4th ed., p. 434.

old age. This supposition agrees well with the shortness of the period covered by his book, and with the fact that Zechariah, who began to prophesy in the same autumn and was associated with Haggai's labours (Ezra v. 1), afterwards appears as the leading prophet in Jerusalem (Zech. vii. 1-4). We know nothing further of the personal history of Haggai from the Bible. Later traditions may be read in Carpov's *Introductio*, pars 3, cap. xvi. Epiphanius (*Vitae prophetarum*) says that he came up from Babylon while still young, prophesied the return, witnessed the building of the temple and received an honoured burial near the priests. Haggai's name is mentioned in the titles of several psalms in the Septuagint (Psalms cxxvii., cxlv.-cxlviii.) and other versions, but these titles are without value, and moreover vary in MSS. Eusebius did not find them in the Hexaplar Septuagint.¹

In his first prophecy (i. 1-11) Haggai addresses Zerubbabel and Joshua, rebuking the people for leaving the temple unbuilt while they are busy in providing panelled houses for themselves. The prevalent famine and distress are due to Yahweh's indignation at such remissness. Let them build the house, and Yahweh will take pleasure in it and acknowledge the honour paid to Him. The rebuke took effect, and the people began to work at the temple, strengthened by the prophet's assurance that the Lord was with them (i. 12-15). In a second prophecy (ii. 1-9) delivered in the following month, Haggai forbids the people to be disheartened by the apparent meanness of the new temple. The silver and gold are the Lord's. He will soon shake all nations and their choicest gifts will be brought to adorn His house. Its glory shall be greater than that of the former temple, and in this place He will give peace. A third prophecy (ii. 10-19) contains a promise, enforced by a figure drawn from the priestly ritual, that God will remove famine and bless the land from the day of the foundation of the temple onwards. Finally, in ii. 20-23, Zerubbabel is assured of God's special love and protection in the impending catastrophe of kingdoms and nations to which the prophet had formerly pointed as preceding the glorification of God's house on Zion. In thus looking forward to a shaking of all nations Haggai agrees with earlier prophecies, especially Isa. xxiv.-xxvii., while his picture of the glory and peace of the new Zion and its temple is drawn from the great anonymous prophet who penned Isa. lx and lxxv. The characteristic features of the book are the importance assigned to the personality of Zerubbabel, who, though a living contemporary, is marked out as the Messiah; and the almost sacramental significance attached to the temple. The hopes fixed on Zerubbabel, the chosen of the Lord, dear to Him as His signet ring (cf. Jer. xxii. 24), are a last echo in Old Testament prophecy of the theocratic importance of the house of David. In the book of Zechariah Zerubbabel has already fallen into the background and the high priest is the leading figure of the Judean community.² The stem of David is superseded by the house of Zadok, the kingship has yielded to the priesthood, and the extinction of national hopes gives new importance to that strict organization of the hierarchy for which Ezekiel had prepared the way by his sentence of disfranchisement against the non-Zadokite priests.

The indifference of the Jews to the desolate conditions of their sanctuary opens up a problem of some difficulty. It is strange that neither Haggai nor his contemporary Zechariah mentions or implies any return of exiles from Babylon, and the suggestion has accordingly been made that the return under Cyrus described in Ezra i.-iv. is unhistorical, and that the community addressed by Haggai consisted of the remnant that had been left in Jerusalem and its neighbourhood after the majority had gone into exile or fled to Egypt (Jer. xliii.). Such a remnant, amongst whom might be members of the priestly and royal families, would gather strength and boldness as the troubles of Babylon

¹ See the note on Ps. cxlv. 1 in Field's *Hexapla*; Köhler, *Weisungen Haggai's*, 32; Wright, *Zechariah and his Prophecies*, xix.

² After the foundation of the temple Zerubbabel disappears from history and lives only in legend, which continued to busy itself with his story, as we see from the apocryphal book of Esdras (cf. Derenburg, *Hist. de la Palestine*, chap. 1).

increased and her vigilance was relaxed, and might receive from Babylon and other lands both refugees and some account at least of the writings of Ezekiel and the Second Isaiah. Stimulated by such causes and obtaining formal permission from the Persian government, they would arise as a new Israel and enter on a new phase of national life and divine revelation.

In spite, however, of the plausibility of this theory, it seems preferable to adhere to the story of Ezra i.-iv. Apart from the weighty objections that the Edomites would have frustrated such a recrudescence of the remnant Jews as has been described, it must be remembered that the main stream of Jewish life and thought had been diverted to Babylon. Thence, when the opportunity came under Cyrus, some 50,000 Jews, the spiritual heirs of the best elements of the old Israel, returned to found the new community. With them were all the resources, and the only people they found at Jerusalem were hostile gentiles and Samaritans. Full of enthusiasm, they set about rebuilding the temple and realizing the glowing promises about the prosperity and dominance of Zion that had fallen from the lips of the Second Isaiah (xlix. 14-26, xlv. 14). Bitter disappointment, however, soon overcame them, the Samaritans were strong enough to thwart and hinder their temple-building, and it seemed as though the divine favour was withdrawn. Apathy took the place of enthusiasm, and sordid worries succeeded to high hopes. "The like collapse has often been experienced in history when bands of religious men, going forth, as they thought, to freedom and the immediate erection of a holy commonwealth, have found their unity wrecked and their enthusiasm dissipated by a few inclement seasons on a barren and hostile shore."³

From this torpor they were roused by tidings which might well be interpreted as the restoration of divine favour. Away in the East Cyrus had been succeeded in 529 B.C. by Cambyses, who had annexed Egypt and on whose death in 522 a Magian impostor, Gaumata, had seized the throne. The fraud was short-lived, and Darius I. became king and the founder of a new dynasty. These events shook the whole Persian empire; Babylon and other subject states rose in revolt, and to the Jews it seemed that Persia was tottering and that the Messianic era was nigh. It was therefore natural that Haggai and Zechariah should urge the speedy building of the temple, in order that the great king might be fittingly received.

It is sometimes levied as a reproach against Haggai that he makes no direct reference to moral duties. But it is hardly fair to contrast his practical counsel with the more ethical and spiritual teaching of the earlier Hebrew prophets. One thing was needful—the temple. "Without a sanctuary Yahweh would have seemed a foreigner to Israel. The Jews would have thought that He had returned to Sinai, the holy mountain; and that they were deprived of the temporal blessings which were the gifts of a God who literally dwelt in the midst of his people." Haggai argued that material prosperity was conditioned by zeal in worship; the prevailing distress was an indication of divine anger due to the people's religious apathy. Haggai's reproofs touched the conscience of the Jews, and the book of Zechariah enables us in some measure to follow the course of a religious revival which, starting with the restoration of the temple, did not confine itself to matters of ceremony and ritual worship. On the other hand, Haggai's treatment of his theme, practical and effective as it was for the purpose in hand, moves on a far lower level than the aspirations of the prophet who wrote the closing chapters of Isaiah. To the latter the material temple is no more than a detail in the picture of a work of restoration eminently ideal and spiritual, and he expressly warns his hearers against attaching intrinsic importance to it (Isa. lxvi. 1). To Haggai the temple appears so essential that he teaches that while it lay waste, the people and all their works and offerings were unclean (Hag. ii. 14). In this he betrays his affinity with Ezekiel, who taught that it is by the possession of the sanctuary that Israel is sanctified (Ezek. xxxvii. 28). In truth the new movement of religious thought and feeling which started from the fall of the Hebrew state took two distinct lines, of which Ezekiel and the anonymous

³ G. A. Smith, *Minor Prophets*, ii. 235.

authors of Isa. xl-lxvi. are the respective representatives. While the latter developed their great picture of Israel the mediatorial nation, the systematic and priestly mind of Ezekiel had shaped a more material conception of the religious vocation of Israel in that picture of the new theocracy where the temple and its ritual occupy the largest place, with a sanctity which is set in express contrast to the older conception of the holiness of the city of Jerusalem (cf. Ezek. xliii. 7 seq. with Jer. xxxii. 40, Isa. iv. 5), and with a supreme significance for the religious life of the people which is expressed in the figure of the living waters issuing from under the threshold of the house (Ezek. xlvii.). It was the conception of Ezekiel which permanently influenced the citizens of the new Jerusalem, and took final shape in the institutions of Ezra. To this consummation, with its necessary accompaniment in the extinction of prophecy, the book of Haggai already points.

AUTHORITIES.—The elaborate and valuable German commentary of A. Köhler (Erlangen, 1860) forms the first part of his work on the *Nachexilische Propheten*. Reinke's *Commentary* (Münster, 1868) is the work of a scholarly Roman Catholic. Haggai has generally been treated in works on all the prophets, as by Ewald (2nd ed., 1868; Eng. trans., vol. iii., 1878); or along with the other minor prophets, as by Hitzig (3rd ed., by H. Steiner, Leipzig, 1881), Keil (1866, 3rd ed., 1888, Eng. trans., Edinburgh, 1868), and Pusey (1875), S. R. Driver (1906), W. Nowack (2nd ed., 1905), K. Marti (1904), J. Wellhausen (3rd ed., 1898); or with the other post-exile prophets, as by Köhler, Pressel (Gotha, 1870), Dods (1879) and others. The older literature will be found in books of introduction or in Rosenmüller's *Scholien*. The learned commentary of Marckius may be specially mentioned. On the place of Haggai in the history of Old Testament prophecy, see Duhm, *Theologie der Propheten* (Bonn, 1875); A. B. Davidson, *The Theology of the Old Testament* (1904); A. F. Kirkpatrick, *The Doctrine of the Prophets*; G. A. Smith, *The Book of the Twelve Prophets*, vol. 2 (1903); Tony Andrée, *Le Prophète Aggée*; Ed. Meyer, *Entstehung des Judentums* (1896).

(W. R. S.; A. J. G.)

HAGGARD, HENRY RIDER (1856—), English novelist, was born at Bradenham Hall, Norfolk, on the 22nd of June 1856. When he was nineteen he went to South Africa as secretary to Sir Henry Bulwer, governor of Natal. At the time of the first annexation of the Transvaal (1877), he was on the staff of the special commissioner, Sir Theophilus Shepstone; and he subsequently became a master of the high court of the Transvaal. He married in 1879 a Norfolk heiress, Miss Margitson, but returned to the Transvaal in time to witness its surrender to the Boers and the overthrow of the policy of his former chief. He returned to England and read for the bar, but soon took to literary work; he published *Cetywayo and his White Neighbours* (1882), written in defence of Sir T. Shepstone's policy. This was followed by the novels *Dawn* (1884), *The Witch's Head* (1885), which contains an account of the British defeat at Isandhlwana; and in 1886 *King Solomon's Mines*, suggested by the Zimbabwe ruins, which first made him popular. *She* (1887), another fantastic African story, was also very successful, a sequel, *Ayesha, or the Return of She*, being published in 1905. The scene of *Jess* (1887) and of *Allan Quatermain* (1888) was also laid in Africa. In 1895 he unsuccessfully contested the East Norfolk parliamentary division in the Unionist interest; he showed great interest in rural and agricultural questions, being a practical gardener and farmer on his estate in Norfolk. In his *Rural England* (2 vols., 1902) he exposed the evils of depopulation in country districts. In 1905 he was commissioned by the colonial office to inquire into the Salvation Army settlements at Fort Romie, S. California, and Fort Amity, Colorado, with a view to the establishment of similar colonies in South Africa. His report on the subject was first published as a blue book, and afterwards, in an enlarged form, as *The Poor and the Land* (1905), with suggestions for a scheme of national land settlement in Great Britain itself.

His other books include *Maiwo's Revenge* (1888), *Mr Meeson's Will* (1888), *Colonel Quaritch, V.C.* (1888), *Cleopatra* (1889), *Eric Brighteyes* (1891), *The World's Desire* (1890), a romance of Helen of Troy, written with Mr Andrew Lang; *Nada the Lily* (1892), *Montezuma's Daughter* (1894), *The People of the Mist* (1894), *Joan Haste* (1895), *Heart of the World* (1896), *Dr Thorne* (1898), *A Farmer's Year* (1899), *The New South Africa* (1900), *Lybth*, *A Tale of the Dutch* (1901), *Stella Fregeius* (1903), *A Gardener's Year* (1905), *A Farmer's Year* (1899, revised ed., 1906), *The Way of the Spirit* (1906).

HAGGIS, a dish consisting of a calf's, sheep's or other animal's heart, liver and lungs, and also sometimes of the smaller intestines, boiled in the stomach of the animal with seasoning of pepper, salt, onions, &c., chopped fine with suet and oatmeal. It is considered peculiarly a Scottish dish, but was common in England till the 18th century. The derivation of the word is obscure. The Fr. *hachis*, English "hash," is of later appearance than "haggis." It may be connected with a verb "to hag," meaning to cut in small pieces, and would then be cognate ultimately with "hash."

HAGIOLOGY (from Gr. *ἅγιος*, saint, *λόγος*, discourse), that branch of the historical sciences which is concerned with the lives of the saints. If hagiology be considered merely in the sense in which the term has come to be understood in the later stages of its development, i.e. the critical study of hagiographic remains, there would be no such science before the 17th century. But the bases of hagiology may fairly be said to have been laid at the time when hagiographic documents, hitherto dispersed, were first brought together into collections. The oldest collection of this kind, the *συναγωγή τῶν ἀρχαίων μαρτυρίων* of Eusebius, to which the author refers in several passages in his writings (*Hist. Eccl.*, v. proem 2; v. 20, 5), and which has left more than one trace in Christian literature, is unfortunately lost in its entirety. The *Martyrs of Palestine*, as also the writings of Theodoret, Palladius and others, on the origins of the monastic life, and, similarly, the *Dialogues* of St Gregory (Pope Gregory I.), belong to the category of sources rather than to that of hagiologic collections. The *In gloria martyrum* and *In gloria confessorum* of Gregory of Tours are valuable for the sources used in their compilation. The most important collections are those which comprise the Acts of the Martyrs and the lives of saints, arranged in the order of the calendar. In the Greek Church these are called menologies (from Gr. *μήν*, month, *λόγος*, discourse), and their existence can be traced back with certainty to the 9th century (Theodore of Studium, *Epist.* i. 2). One of them, the menology of Metaphrastes, compiled in the second half of the 10th century, enjoyed a universal vogue (see *ΣΥΝΑΧΩΝ ΜΕΤΑΦΡΑΣΤΕΣ*). The corresponding works in the Western Church are the *passionaries* or *legendaries*, varieties of which are dispersed in libraries and have not been studied collectively. They generally draw from a common source, the Roman legendary, and the lives of the local saints, i.e. those specially honoured in a church, a province or a country. One of the best known is the Austrian legendary (*De magno legendario Austriaco in the Analecta Bollandiana*, xvii. 24-264). From the menologies and legendaries various compilations were made: in the Greek Church, the *Synaxaria* (see *SYNAXARIUM*); in the Western Church, abridgments and extracts such as the *Speculum historiale* of Vincent de Beauvais; the *Legenda aurea* of Jacobus de Voragine; the *Sanctorale* of Bernard Guy [d. 1331] (see L. Delisle, *Notice sur les manuscrits de Bernard Guy*, Paris, 1879); the *Sanctilogium* of John of Tynemouth (c. 1360), utilized by John Capgrave, and published in 1516 under the name of *Novus legenda Angliæ* (new edition by C. Horstman, Oxford, 1901); and the *Catalogus sanctorum* of Petrus de Natalibus (c. 1375), published at Vicenza in 1493, and many times reprinted. The *Sanctuarium* of B. Mombritius, published at Milan about 1480, is particularly valuable because it gives a faithful reproduction of the ancient texts according to the manuscripts. One of the most zealous collectors of lives of saints was John Gielemans of Brabant (d. 1487), whose work is of great value (Bollandist, *De codicibus hagiographicis Johannis Gielemans*, Brussels, 1895), and with him must be associated Anton Geens, or Gentius, of Groenendael, who died in 1543 (*Analecta Bollandiana*, vi. 31-34).

Hagiology entered on a new development with the publication of the *Sanctorum priscorum patrum vitæ* (Venice and Rome, 1551-1560) of Aloysius Lippomanus (Lippomano), bishop of Verona. As a result of the co-operation of humanist scholars a great number of Greek hagiographic texts became for the first time accessible to the West in a Latin translation. The Carthusian, Laurentius Surius, carried on the work of Lippomano, completed it, and arranged the materials strictly in the order

of the calendar (*De probatis sanctorum historiis*, Cologne, 1570-1575). What prevents the work of Surius from being regarded as an improvement upon Lippomano's is that Surius thought it necessary to retouch the style of those documents which appeared to him badly written, without troubling himself about the consequent loss of their documentary value.

The actual founder of hagiologic criticism was the Flemish Jesuit, Heribert Rosweyde (d. 1699), who, besides his important works on the martyrologies (see MARTYROLOGY), published the celebrated collection of the *Vitae patrum* (Antwerp, 1615), a veritable masterpiece for the time at which it appeared. It was he, too, who conceived the plan of a great collection of lives of saints, compiled from the manuscripts and augmented with notes, from which resulted the collection of the *Acta sanctorum* (see BOLLANDISTS). This last enterprise gave rise to others of a similar character but less extensive in scope.

Dom T. Ruinat collected the best *Acta* of the martyrs in his *Acta martyrum sincera* (Paris, 1689). The various religious orders collected the *Acta* of their saints, often increasing the lists beyond measure. The best publications of this kind, the *Acta sanctorum ordinis S. Benedicti* (Paris, 1666-1701) of d'Achery and Mabillon, does not entirely escape this reproach. Countries, provinces and dioceses also had their special hagiographic collections, conceived according to various plans and executed with more or less historical sense. Of these, the most important collections are those of O. Caietanus, *Vitae sanctorum Siculorum* (Palermo, 1657); G. A. Lobineau, *Vitae des saints de Bretagne* (Rennes, 1725); and J. H. Ghesquiere, *Acta sanctorum Belgii* (Brussels and Tongerlo, 1783-1794). The principal lives of the German saints are published in the *Monumenta Germaniae*, and a special section of the *Scriptores rerum Merovingicarum* is devoted to the lives of the saints. For Scotland and Ireland mention must be made of T. Messingham's *Florilegium insulae sanctorum* (Paris, 1624); J. Colgan's *Acta sanctorum veteris et maioris Scotiae seu Hiberniae* (Louvain, 1645-1647); John Pinkerton's *Vitae antiquae sanctorum* . . . (London, 1789), of which a revised and enlarged edition was published by W. M. Meikleath at Paisley in 1889, under the title of *Lives of the Scottish Saints*; W. J. Reed's *Lives of the Anglo-British Saints* (Llandover, 1853); *Acta sanctorum Hiberniae* (Edinburgh, 1888); Whitley Stokes's *Lives of Saints from the Book of Lismore* (Oxford, 1890); and J. O'Hanlon's *Lives of the Irish Saints* (Dublin, 1875-1905). Towards the 13th century vernacular collections of lives of saints began to increase. This literature is more interesting from the linguistic than from the hagiologic point of view, and comes rather within the domain of the philologist.

The hagiography of the Eastern and the Greek church also has been the subject of important publications. The Greek texts are very much scattered. Of them, however, may be mentioned J. B. Malou's "Symeonis Metaphrastae opera omnia" (*Patrologia Graeca*, 114, 115, 116) and Theophilus Ioannu, *Μηναια ἀγιολογικὰ* (Venice, 1884). For Syriac, there are S. E. Assemani's *Acta sanctorum martyrum orientalisium* (Rome, 1748) and P. Bedjan's *Acta martyrum et sanctorum* (Paris, 1890-1897); for Armenian, the acts of martyrs and lives of saints, published in two volumes by the Mechitarist community of Venice in 1874; for Coptic, Hyvernat's *Les Actes des martyrs de l'Égypte* (Paris, 1886); for Ethiopian, K. Conti Rossini's *Scriptores Aethiopes, vitae sanctorum* (Paris, 1904 seq.); and for Georgian, Sabina's *Paradisus of the Georgian Church* (St Petersburg, 1882).

In addition to the principal collections must be mentioned the innumerable works in which the hagiographic texts have been subjected to detailed critical study.

To realize the present state of hagiology, the *Bibliotheca hagiographica*, both Latin and Greek, published by the Bollandists, and the *Bulletin hagiographique*, which appears in each number of the *Analecta Bollandiana* (see BOLLANDISTS), must be consulted. Thanks to the combined efforts of a great number of scholars, the classification of the hagiographic texts has in recent years made notable progress. The criticism of the sources, the study of literary styles, and the knowledge of local history now render it easier to discriminate in this literature between what is really historical and what is merely the invention of the genius of the people or of the imagination of pious writers (see H. Delchaye, *Les Légendes hagiographiques*, 2nd ed., pp. 121-141, Brussels, 1906). "Though the lives of saints," says a recent historian, "are filled with miracles and incredible stories, they form a rich mine of information concerning the life and customs of the people. Some of them are memorials of the best time of the time written by the best scholars of the time." (C. Gross, *The Sources and Literature of English History*, p. 34, London, 1900.) (H. DE.)

HAGIOSCOPE (from Gr. ἅγιος, holy, and σκοπεῖν, to see), in architecture, an opening through the wall of a church in an oblique direction, to enable the worshippers in the transepts or other parts of the church, from which the altar was not visible,

to see the elevation of the Host. As a rule these hagioscopes, or "squints" as they are sometimes called, are found on one or both sides of the chancel arch. In some cases a series of openings has been cut in the walls in an oblique line to enable a person standing in the porch (as in Bridgewater church, Somerset) to see the altar; in this case and in other instances such openings were sometimes provided for an attendant, who had to ring the Sanctus bell when the Host was elevated. Though rarely met with on the continent of Europe, there are occasions where they are found, so as to enable a monk in one of the vestries to follow the service and communicate with the bell-ringers.

HAGONOY, a town of the province of Bulacan, Luzon, Philippine Islands, on Manila Bay and on the W. branch and the delta of the Pampanga Grande river, about 25 m. N.W. of Manila. Pop. (1903), 21,304. Hagonoy is situated in a rich agricultural region, producing rice, Indian corn, sugar and a little coffee. Alcohol is made in considerable quantities from the fermented juice of the nipa palm, which grows in the neighbouring swamps, and from the leaves of which the nipa thatch is manufactured. There is good fishing. The women of the town are very skillful in weaving the native fabrics. The language is Tagalog. Hagonoy was founded in 1581.

HAGUE, THE (in Dutch, 's Gravenhage, or, abbreviated, den Haag; in Fr. La Haye; and in Late Lat. Haga Comitibus), the chief town of the province of South Holland, about 2½ m. from the sea, with a junction station 9½ m. by rail S.W. by S. of Leiden. Steam tramways connect it with the seaside villages of Scheveningen, Kykdaun and 's Gravenzande, as well as with Delft, Wassenaar and Leiden, and it is situated on a branch of the main canal from Rotterdam to Amsterdam. Pop. (1900), 212,213. The Hague is the chief town of the province, the usual residence of the court and diplomatic bodies, and the seat of the government, the states-general, the high council of the Netherlands, the council of state, the chamber of accounts and various other administrative bodies. The characteristics of the town are quite in keeping with its political position; it is as handsome as it is fashionable, and was rightly described by de Amicis in his *Olanda* as half Dutch, half French. The Hague has grown very largely in modern times, especially on its western side, which is situated on the higher and more sandy soil, the south-eastern half of the town comprising the poorer and the business quarters. The main features in a plan of the town are its fine streets and houses and extensive avenues and well-planted squares; while, as a city, the neighbourhood of an attractive seaside resort, combined with the advantages and importance of a large town, and the possession of beautiful and wooded surroundings, give it a distinction all its own.

The mediæval-looking group of government buildings situated in the Binnenhof (or "inner court"), their backs reflected in the pretty sheet of water called the Vyver, represent both historically and topographically the centre of the Hague. On the opposite side of the Vyver lies the parallelogram formed by the fine houses and magnificent avenue of trees of the Lange Voorhout, the Kneuterdyk and the Vyverburg, representing the fashionable kernel of the city. Close by lies the entrance to the Haagsche Bosch, or the wood, on one side of which is situated the deer-park, and a little beyond on the other the zoological gardens (1862). Away from the Lange Voorhout the fine Park Straat stretches to the "1813 Plein" or square, in the centre of which rises the large monument (1869) by Jaquet commemorating the jubilee of the restoration of Dutch independence in 1813. Beyond this is the Alexander Veld, used as a military drill ground, and close by is the entrance to the beautiful road called the Scheveningsche Weg, which leads through the "little woods" to Scheveningen. Parallel to the Park Straat is the busy Noordcinde, in which is situated the royal palace. The palace was purchased by the States in 1595, rebuilt by the stadtholder William III., and extended by King William I. in the beginning of the 19th century. In front of the building is an equestrian statue of William I. of Orange by Count Nieuerkerke (1845), and behind are the gardens and extensive stables. The Binnenhof, which has been already mentioned, was once surrounded by

a moat, and is still entered through ancient gateways. The oldest portion was founded in 1249 by William II., count of Holland, whose son, Florens V., enlarged it and made it his residence. Several centuries later the stadtholders also lived here. The fine old hall of the knights, built by Florens, and now containing the archives of the home office, is the historic chamber in which the states of the Netherlands abjured their allegiance to Philip II. of Spain, and in front of which the grey-headed statesman Johan van Oldenbarnevelt was executed in 1610. Close by on the one side are the courts of justice, and on the other the first and second chambers of the states-general, containing some richly painted ceilings and the portraits of various stadtholders. Government offices occupy the remainder of the buildings, and in the middle of the court is a fountain surmounted by a statuette of William II., count of Holland (1227-1256). In the adjoining Buitenhof, or "outer court," is a statue of King William II. (d. 1849), and the old Gevangen Poort, or prison gate (restored 1875), consisting of a tower and gateway. It was here that the brothers Cornelis and Jan de Witt were killed by the mob in 1672. On the opposite side of the Binnenhof is the busy square called the Plein, where all the tram-lines meet. Round about it are the buildings of the ministry of justice and other government buildings, including one to contain the state archives, the large club-house of the Witte Societeit, and the Mauritshuis. The Mauritshuis was built in 1633-1644 by Count John Maurice of Nassau, governor of Brazil, and contains the famous picture gallery of the Hague. The nucleus of this collection was formed by the princes of Orange, notably by the stadtholder William V. (1749-1806). King William I. did much to restore the losses caused by the removal of many of the pictures during the French occupation. Other artistic collections in the Hague are the municipal museum (*Gemeente* Museum), containing paintings by both ancient and modern Dutch artists, and some antiquities; the fine collection of pictures in the Steengracht gallery, belonging to Jonkheer Steengracht; the museum Meermann-Westreenianum, named after Count Meermann and Baron Westreenen (d. 1850), containing some interesting MSS. and specimens of early typography and other curiosities; and the Mesdag Museum, containing the collection of the painter H. W. Mesdag (b. 1831) presented by him to the state. The royal library (1798) contains upwards of 500,000 volumes, including some early illuminated MSS., a valuable collection of coins and medals and some fine antique gems. In addition to the royal palace already mentioned, there are the palaces of the queen-dowager, of the prince of Orange (founded about 1730 by Count Unico of Wassenaar Twickel) and of the prince von Wied, dating from 1825, and containing some good early Dutch and Flemish masters. There are numerous churches of various denominations in the Hague as well as an English church, a Russian chapel and two synagogues, one of which is Portuguese. The Grootte Kerk of St. James (15th and 16th centuries) has a fine vaulted interior, and contains some old stained glass, a carved wooden pulpit (1550), a large organ and interesting sepulchral monuments, and some escutcheons of the knights of the Golden Fleece, placed here after the chapter of 1456. The Nieuwe Kerk, or new church (first half 17th century), contains the tombs of the brothers De Witt and of the philosopher Spinoza. Spinoza is further commemorated by a monument in front of the house in which he died in 1677. The picturesque town hall (built in 1565 and restored and enlarged in 1882) contains a historical picture gallery. The principal other buildings are the provincial government offices, the royal school of music, the college of art, the large building (1874) of the society for arts and sciences, the ethnographical institute of the Netherlands Indies with fine library, the theatres, civil and military hospitals, orphanage, lunatic asylum and other charitable institutions; the fine modern railway station (1892), the cavalry and artillery and the infantry barracks, and the cannon foundry. The chief industries of the town are iron casting, copper and lead smelting, cannon founding, the manufacture of furniture and carriages, liqueur distilling, lithographing and printing.

The Hague wood has been described as the city's finest

ornament. It is composed chiefly of oaks and alders and magnificent avenues of gigantic beech-trees. Together with the Haarlem wood it is thought to be a remnant of the immense forest which once extended along the coast. At the end of one of the avenues which penetrates into it from the town is the large summer club-house of the Witte Societeit, under whose auspices concerts are given here in summer. Farther into the wood are some pretty little lakes, and the famous royal villa called the Huis ten Bosch, or "house in the wood." This villa was built by Pieter Post for the Princess Amelia of Solms, in memory of her husband the stadtholder, Frederick Henry of Orange (d. 1647), and wings were added to it by Prince William IV. in 1748. The chief room is the Orange Saloon, an octagonal hall 50 ft. high, covered with paintings by Dutch and Flemish artists, chiefly of incidents in the life of Prince Frederick. In this room the International Peace Conference had its sittings in the summer of 1899. The collections in the Chinese and Japanese rooms, and the grisailles in the dining-room painted by Jacobus de Wit (1695-1754), are also noteworthy.

The history of the Hague is in some respects singular. In the 13th century it was no more than a hunting-lodge of the counts of Holland, and though Count Floris V. (b. 1254-1296) made it his residence and it thus became the seat of the supreme court of justice of Holland and the centre of the administration, and from the time of William of Orange onward the meeting-place of the states-general, it only received the status of a town, from King Louis Bonaparte, early in the 19th century.

In the latter part of the 17th and the first half of the 18th century the Hague was the centre of European diplomacy. Among the many treaties and conventions signed here may be mentioned the treaty of the Triple Alliance (January 23, 1688) between England, Sweden and the Netherlands; the concert of the Hague (March 31, 1710) between the Emperor, England and Holland, for the maintenance of the neutrality of the Swedish provinces in Germany during the war of the northern power against Sweden; the Triple Alliance (January 4, 1717) between France, England and Holland for the guarantee of the treaty of Utrecht; the treaty of peace (Feb. 17, 1717) between Spain, Savoy and Austria, by which the first-named acceded to the principles of the Triple Alliance; the treaty of peace between Holland and France (May 16, 1795); the first "Hague Convention," the outcome of the "peace conference" assembled on the initiative of the emperor Nicholas II. of Russia (July 27, 1899), and the series of conventions, the results of the second peace conference (June 15-October 18, 1907). The international court of arbitration or Hague Tribunal was established in 1899 (see *EUROPE: HISTORY; ARBITRATION, INTERNATIONAL*). The Palace of Peace designed to be completed in 1913 as the seat of the tribunal, on the Scheveningen avenue, is by a French architect, L. M. Cordonnier, and A. Carnegie contributed £300,000 towards its cost.

HAHN, AUGUST (1792-1863), German Protestant theologian, was born on the 27th of March 1792 at Grossosterhausen near Eisleben, and studied theology at the university of Leipzig. In 1819 he was nominated *professor extraordinarius* of theology and pastor of Altstadt in Königsberg, and in 1820 received a superintendency in that city. In 1822 he became *professor ordinarius*. In 1826 he removed as professor of theology to Leipzig, where, hitherto distinguished only as editor of *Bardeanes, Marcion's Evangelium in seiner ursprünglichen Gestalt*, 1823), and Ephraem Syrus, and the joint editor of a *Syrische Chrestomathie* (1824), he came into great prominence as the author of a treatise, *De rationalismi qui dicitur vera inde a qua cum naturalismo continetur ratiōne* (1827), and also of an *Offene Erklärung an die Evangelische Kirche zunächst in Sachsen u. Preussen* (1827), in which, as a member of the school of E. W. Hengstenberg, he endeavoured to convince the rationalists that it was their duty voluntarily and at once to withdraw from the national church. In 1833 Hahn's pamphlet against K. G. Bretschneider (*Über die Lage des Christenthums in unserer Zeit*, 1832) having attracted the notice of Friedrich Wilhelm III., he was called to Breslau as theological professor and consistorial councillor, and in 1843 became "general superintendent" of

the province of Silesia. He died at Breslau on the 13th of May 1863. Though uncompromising in his "supra-naturalism," he did not altogether satisfy the men of his own school by his own doctrinal system. The first edition of his *Lehrbuch der christlichen Glaubens* (1828) was freely characterized as lacking in consistency and as detracting from the strength of the old positions in many important points. Many of these defects, however, he is considered to have remedied in his second edition (1837). Among his other works are his edition of the Hebrew Bible (1833), his *Bibliothek der Symbole und Glaubenswege der apostolisch-katholischen Kirche* (1842; 2nd ed. 1877) and *Predigten* (1852).

His eldest son, HEINRICH AUGUST HAHN (1821-1861), after studying theology at Breslau and Berlin, became successively *Privatdocent* at Breslau (1845), professor *ad interim* (1846) at Königsberg on the death of Heinrich Hävernick, professor extraordinarius (1851) and professor ordinarius (1860) at Greifswald. Amongst his published works were a commentary on the Book of Job (1850), a translation of the Song of Songs (1852), an exposition of Isaiah xl.-lxvi. (1857) and a commentary on the Book of Ecclesiastes (1860).

See the articles in Herzog-Hauck, *Realencyclopädie*, and the *Allgemeine deutsche Biographie*.

HAHNEMANN, SAMUEL CHRISTIAN FRIEDRICH (1755-1843), German physician and founder of "homoeopathy," was born at Meissen in Saxony on the 10th of April 1755. He was educated at the "elector's school" of Meissen, and studied medicine at Leipzig and Vienna, taking the degree of M.D. at Erlangen in 1779. After practising in various places, he settled in Dresden in 1784, and thence removed to Leipzig in 1789. In the following year, while translating W. Cullen's *Materia medica* into German, he was struck by the fact that the symptoms produced by quinine on the healthy body were similar to those of the disordered states it was used to cure. He had previously felt dissatisfied with the state of the science of medicine, and this observation led him to assert the truth of the "law of similars," *similia similibus curantur* or *curantur*—i.e. diseases are cured (or should be treated) by those drugs which produce symptoms similar to them in the healthy. He promulgated his new principle in a paper published in 1796 in C. W. Hufeland's *Journal*, and four years later, convinced that drugs in much smaller doses than were generally employed effectually exerted their curative powers, he advanced his doctrine of their potentiation or dynamisation. In 1810 he published his chief work, *Organon der rationellen Heilkunde*, containing an exposition of his system, which he called homoeopathy (*q. n.*), and in the following years appeared the six volumes of his *Reins Arzneimittellehre*, which detailed the symptoms produced by "proving" a large number of drugs, i.e. by systematically administering them to healthy subjects. In 1821 the hostility of established interests, and especially of the apothecaries, whose services were not required under his system, forced him to leave Leipzig, and at the invitation of the grand-duke of Anhalt-Cöthen he went to live at Cöthen. Fourteen years later he removed to Paris, where he practised with great success until his death on the 2nd of July 1843. Statues were erected to his memory at Leipzig in 1851 and at Cöthen in 1855. He also wrote, in addition to the works already mentioned, *Fragmente de viribus medicamentorum positivis* (1805) and *Die chronischen Krankheiten* (1828-1830).

See the article HOMOEOPATHY; also Albrecht, *Hahnemann's Leben und Werke* (Leipzig, 1875); Bradford, *Hahnemann's Life and Letters* (Philadelphia, 1895).

HAHN-HAHN, IDA, COUNTESS VON (1805-1880), German author, was born at Treasow, in Mecklenburg-Schwerin, on the 22nd of June 1805, daughter of Graf (Count) Karl Friedrich von Hahn (1782-1857), well known for his enthusiasm for the stage, upon which he squandered a large portion of his fortune. She married in 1826 her wealthy cousin Count Adolf von Hahn-Hahn. With him she had an extremely unhappy life, and in 1830 her husband's irregularities led to a divorce. The countess travelled, produced some volumes of poetry indicating true

lyrical feeling, and in 1838 appeared as a novelist with *Als der Gesellschaft*, a title which, proving equally applicable to her subsequent novels, was retained as that of a series, the book originally so entitled being renamed *Ida Schönhaun*. For several years the countess continued to produce novels bearing a certain subjective resemblance to those of George Sand, but less hostile to social institutions, and dealing almost exclusively with aristocratic society. The author's patrician affectations at length drew upon her the merciless ridicule of Fanny Lewald in a parody of her style entitled *Diogena* (1847), and this and the revolution of 1848 together seem to have co-operated in inducing her to embrace the Roman Catholic religion in 1850. She justified her step in a polemical work entitled *Von Babylon nach Jerusalem* (1851), which elicited a vigorous reply from H. Abeken. In 1852 she retired into a convent at Angers, which she, however, soon left, taking up her residence at Mainz where she founded a nunnery, in which she lived without joining the order, and continued her literary labours. For many years her novels were the most popular works of fiction in aristocratic circles; many of her later publications, however, passed unnoticed as mere party manifestoes. Her earlier works do not deserve the neglect into which they have fallen. If their sentimentalism is sometimes wearisome, it is grounded on genuine feeling and expressed with passionate eloquence. *Ulrich* and *Gräfin Faustine*, both published in 1841, mark the culmination of her power; but *Sigismund Forster* (1843), *Cecil* (1844), *Sibylle* (1846) and *Maria Regina* (1860) also obtained considerable popularity. She died at Mainz on the 12th of January 1880.

Her collected works, *Gesammelte Werke*, with an introduction by O. von Schöching, were published in two series, 45 volumes in all (Regensburg, 1903-1904). See H. Keiter, *Gräfin Hahn-Hahn* (Würzburg, undated); F. Haffner, *Gräfin Ida Hahn-Hahn, eine psychologische Studie* (Frankfurt, 1880); A. Jacoby, *Ida Gräfin Hahn-Hahn* (Mainz, 1894).

HAI (939-1038), Jewish Talmudical scholar, was born in 939. He was educated by his father Sherira, gaon of Pumbeditha (Pumbedita), whom he afterwards assisted in his work. They were cast into prison for a short time by the caliph Qadir, and subsequently on Sherira's death Hai was appointed gaon in his place (998). This office he held till his death on the 28th of March 1038. He is famous chiefly for his answers to problems of ritual and civil law. He composed important treatises on Talmudic law and the *Mishnah*; many poems are also attributed to him on doubtful authority. In his *responsa* he laid stress on custom and tradition provided no infringement of the law were involved, and was essentially conservative in theology. He had considerable knowledge not only of religious movements within the Jewish body, but also of Mahomedan theology and controversial method, and frequently consulted theologians of other beliefs.

See Steinschneider, *Hebr. Übersetz.* p. 910, and article in *Jewish Encyclopedia*, vi. 153.

HAIKAK, a town and khanate of Afghan Turkestan. The valley of Haibak, which is 3100 ft. above sea level, is fertile and richly cultivated. The town, which is famed in Persian legend, consists now of only a couple of streets, containing many Hindu shops and a small garrison. The inhabitants call themselves Jagatais, a Turki race, though now generally mixed with Tajiks and speaking Persian. In the neighbourhood of Haibak are some very typical Buddhist ruins. Haibak derives its importance from its position on the main line of communication between Kabul and Afghan Turkestan.

HAIDA, a tribe of North American Indians of Skittagetan stock. They still occupy their original home, the Queen Charlotte islands, British Columbia. They are skillful seamen, making long fishing expeditions in cedarwood canoes. They are noted for their carving and basket-work. They formerly made raids on the coast tribes. Slavery was hereditary, the slaves being prisoners of war. The population, some 7000 in the middle of the 19th century, is now reduced to a few hundreds.

See *Handbook of American Indians* (Washington, 1907). For "Haïda Texts and Myths," see *Bull. 29 Smithsonian Institution Bureau Amer. Ethnol.* (1905).

HAIDINGER, WILHELM KARL, RITTER VON (1795-1872), Austrian mineralogist, geologist and physicist, was born at Vienna on the 5th of February 1795. His father, Karl Haidinger, contributed largely to the development of mineralogical science in the latter half of the 18th century. Having studied at the normal school of St Anne, and attended classes at the university, Wilhelm, at the age of seventeen, joined Professor F. Mohs at Gratz, and five years later accompanied the professor to Freiberg on the transfer of his labours to the mining academy of that town.

In 1822 Haidinger visited France and England with Count Breunner, and, journeying northward, took up his abode in Edinburgh. He translated into English, with additions of his own, Mohs's *Grundriss der Mineralogie*, published at Edinburgh in three volumes under the title *Treatise on Mineralogy* (1825). After a tour in northern Europe, including the Scandinavian mining districts, he undertook the scientific direction of the porcelain works at Elbogen, belonging to his brothers. In 1840 he was appointed counsellor of mines (Bergrat) at Vienna in the place of Professor Mohs, a post which included the charge of the imperial cabinet of minerals. He devoted himself to the re-arrangement and enrichment of the collections, and the museum became the first in Europe. Shortly after (1843) Haidinger commenced a series of lectures on mineralogy, which was given to the world under the title *Handbuch der bestimmenden Mineralogie* (Vienna, 1845; tables, 1846). On the establishment of the imperial geological institute, he was chosen director (1849); and this important position he occupied for seventeen years. He was elected a member of the imperial board of agriculture and mines, and a member of the imperial academy of sciences of Vienna. He organized the society of the Freunde der Naturwissenschaften. As a physicist Haidinger ranked high, and he was one of the most active promoters of scientific progress in Austria. He was the discoverer of the interesting optical appearances which have been called after him "Haidinger's brushes." Knighted in 1865, the following year he retired to his estate at Dornbach near Vienna, where he died on the 19th of March 1872.

In addition to the works already named, Haidinger published *Anfangsgründe der Mineralogie* (Leipzig, 1829); *Geognostische Übersichtskarte der österreich. Monarchie* (Vienna, 1847); *Bemerkungen über die Anordnung der kleinsten Theilchen in Kristallen* (Vienna, 1853); *Interferenzlinien am Glimmer* (Vienna, 1855); *Vergleichungen von Augit und Amphibol* (Vienna, 1855). He also edited the *Naturwissenschaftliche Abhandlungen* (Vienna, 1847); the *Berichte über die Mittheilungen von Freunden der Naturwissenschaften in Wien* (Vienna, 1847-1851); and the *Jahrbuch der Vienna K. K. Geologische Reichsanstalt* (1850), &c. Some of his papers will be found in the *Transactions of the Royal Society of Edinburgh* (vol. x.) and of the *Wernerian Society* (1822-1823). *Edinburgh Phil. Journal*, *Brewster's Journal of Science*, and *Poggendorff's Annalen*. (H. B. Wo.)

HAIDUK (also written *Hayduk*, *Heiduc*, *Heyduks* and *Heyduque*), a term which appears originally to have meant "robber" or "brigand," a sense it retains in Serbia and some other parts of the Balkan Peninsula. It is probably derived from the Turkish *haidüd*, "marauder," but its origin is not absolutely certain. Most of the European races with which the Turks came into close contact during the 15th and 16th centuries seem to have adopted it as a loan-word, and it appears in Magyar as *hajdú* (plural *hajduks*), in Serbo-Croatian, Rumanian, Polish and Czech as *hajduk*, in Bulgarian as *hajdukin* and in Greek as $\chi\alpha\upsilon\rho\upsilon\beta\eta\rho\varsigma$. By the beginning of the 17th century its use had spread north and west as far as Sweden and Great Britain. In Hungary it was applied to a class of mercenary foot-soldiers of Magyar stock. In 1605 these haiduks were rewarded for their fidelity to the Protestant party (see HUNGARY: *History*) with titles of nobility and territorial rights over a district situated on the left bank of the river Theiss, known thenceforward as the Haiduk region. This was enlarged in 1876 and converted into the county of Hajdú (Ger. *Hajduken*). *Hajdú* is also a common prefix in Hungarian place-names, e.g. Hajdú-Szoboszló, Hajdú-Námás. In Austria-Hungary, Germany, Poland, Sweden and some other countries, *haiduk* came to mean an attendant in a court of law,

or a male servant, dressed in Hungarian semi-military costume. It is also occasionally used as a synonym for "footman" or "lackey."

HAIFA, a town of Palestine at the foot of Mt. Carmel, on the south of the Bay of Acre. It represents the classical Sycaminum, but the present town is entirely modern. It has developed since about 1890 into an important port, and is connected by railway with Damascus. The population is estimated at 12,000 (Mo- lems 6000, Christians 4000, Jews 1300, Germans 500; the last belong for the greater part to the Unitarian sect of the "Templars," who have colonies also at Jaffa and Jerusalem). The exports (grain and oil) were valued at £178,738 in 1900. Much of the trade that formerly went to Acre has been attracted to Haifa. This port is the best natural harbour on the Palestine coast.

HAIK (an Arabic word, from *hak*, to weave), a piece of cloth, usually of coarse hand-woven wool, worn by Arabs, Moors and other Mahomedan peoples. It is generally 6 to 6½ yds. long, and about 2 broad. It is either striped or plain, and is worn equally by both sexes, usually as an outer covering; but it is often the only garment of the poorer classes. By women the "haik" is arranged to cover the head and, in the presence of men, is held so as to conceal the face. A thin "haik" of silk, like a veil, is used by brides at their marriage.

HAIL (O. Eng. *hagl* and *hagel*, ¹cf. the cognate Teutonic *hagl*, as in German, Dutch, Swedish, &c.; the Gr. $\acute{\alpha}\lambda\lambda\alpha\gamma\acute{\alpha}\xi$, pebble, is probably allied), the name for rounded masses or single pellets of ice falling from the clouds in a shower. True hail has a concentric structure caused by the frozen particles of moisture first descending into a warm cloud, whence they are carried upwards on an ascending current of heated air into a cold stratum where the fresh coating of water vapour deposited in the cloud is frozen. The hailstone descends again, receives a fresh coating, is carried up once more, refrozen, and again descends. Thus the hailstone grows until the current is no longer strong enough to support it when it falls to the ground. At times masses of hail are frozen together, and a very sudden cooling will sometimes result in the formation of ragged masses of ice that fall with disastrous results. Hail must be distinguished from the frozen snow, "soft-hail" or "graupel," that often falls at the rear of a spring cyclone, since true hail is almost entirely a summer phenomenon, and falls most frequently in thunderstorms which are produced under the conditions that are favourable to the formation of hail, i.e. great heat; a still atmosphere; the production of strong local convection currents in consequence, and the passage of a cold upper drift.

HAILES, DAVID DALRYMPLE, LORD (1726-1792), Scottish lawyer and historian, was born at Edinburgh on the 28th of October 1726. His father, Sir James Dalrymple, Bart., of Hailes, in the county of Haddington, auditor-general of the exchequer of Scotland, was a grandson of James, first Viscount Stair; and his mother, Lady Christian Hamilton, was a daughter of Thomas, 6th earl of Haddington. David was the eldest of sixteen children. He was educated at Eton, and studied law at Utrecht, being intended for the Scottish bar, to which he was admitted shortly after his return to Scotland in 1748. As a pleader he attained neither high distinction nor very extensive practice, but he rapidly established a well-deserved reputation for sound knowledge, unwearied application and strict probity; and in 1766 he was elevated to the bench, when he assumed the title of Lord Hailes. Ten years later he was appointed a lord of justiciary. He died on the 29th of November 1792. He was twice married, and had a daughter by each wife. The baronetcy to which he had succeeded passed to the son of his brother John, provost of Edinburgh. Another brother was Alexander Dalrymple (1737-1808), the first admiralty hydrographer, who distinguished himself in the East India Company's service and as a geographer. Lord Hailes's younger daughter married Sir

¹"Hail," a call of greeting or salutation, a shout to attract attention, must, of course, be distinguished. This word represents the Old Norwegian *heil*, prosperity, cognate with O. Eng. *hæl*, whence "hale," "whole," and *hæl*, whence "health," "heal."

James Fergusson; and their grandson, Sir Charles Dalrymple, 1st Bart. (cr. 1837), M.P. for Bute from 1868 to 1885, afterwards came into Lord Hailes's estate and took his family name.

Lord Hailes's most important contribution to literature was the *Annals of Scotland*, of which the first volume, "From the accession of Malcolm III., surnamed Canmore, to the accession of Robert I.," appeared in 1776, and the second, "From the accession of Robert I., surnamed Bruce, to the accession of the house of Stewart," in 1779. It is, as Dr Johnson justly described this work at the time of its appearance, a "Dictionary" of carefully sifted facts, which tells all that is wanted and all that is known, but without any laboured splendour of language or affected subtlety of conjecture. The other works of Lord Hailes include *Historical Memoirs concerning the Provincial Councils of the Scottish Clergy* (1769); *An Examination of some of the Arguments for the High Antiquity of Regiam Majestatem* (1769); three volumes entitled *Remains of Christian Antiquity* ("Account of the Martyrs of Smyrna and Lyons in the Second Century," 1776; "The Trials of Justin Martyr, Cyprian, &c.," 1778; "The History of the Martyrs of Palestine, translated from Eusebius," 1780); *Disquisitions concerning the Antiquities of the Christian Church* (1783); and editions or translations of portions of Lactantius, Tertullian and Minucius Felix. In 1786 he published *An Inquiry into the Secondary Causes which Mr Gibbon has assigned for the Rapid Growth of Christianity* (Dutch translation, Utrecht, 1793), one of the most respectable of the very many replies which were made to the famous 15th and 16th chapters of the *Decline and Fall of the Roman Empire*.

A "Memoir" of Lord Hailes is prefixed to the 1808 reprint of his *Inquiry into the Secondary Causes*.

HAILSHAM, a market-town in the Eastbourne parliamentary division of Sussex, England, 54 m. S.S.E. from London by the London, Brighton & South Coast railway. Pop. (1901), 4197. The church of St Mary is Perpendicular. The picturesque Augustinian priory of Michelham lies 2 m. W. by the Cuckmere river; it is altered into a dwelling house, but retains a gatehouse, crypt and other portions of Early English date. There was also a Premonstratensian house at Otham, 3 m. S., but the remains are scanty. Hailsham has a considerable agricultural trade, and manufactures of rope and matting are carried on.

HAINAN, or, as it is usually called in Chinese, *K'iang-chow-fu*, a large island belonging to the Chinese province of Kwang-tung, and situated between the Chinese Sea and the Gulf of Tong-king from 20° 8' to 17° 52' N., and from 106° 32' to 111° 15' E. It measures 160 m. from N.E. to S.W., and the average breadth is about 90 m. The area is estimated at from 1200 to 1400 sq. m., or two-thirds the size of Sicily. From the peninsula of Leichow on the north it is separated by the straits of Hainan, which have a breadth of 15 or 20 m.

With the exception of a considerable area in the north, and broad tracts on the north-east and north-west sides, the whole island is occupied by jungle-covered mountains, with rich valleys between. The central range bears the name of Li-mou shan or Wu-tchi shan (the Five-Finger Mountain), and attains a height of 6000 or 7000 ft. Its praises are celebrated in a glowing ode by Ch'iu, a native poet. The island appears to be well watered, and some of its rivers are not without importance as possible highways of commerce; but the details of its hydrography are very partially ascertained. A navigable channel extends in an irregular curve from the bay of Hoi-how (Hai-K'ow) in the north to Tan-chow on the west coast. Being exposed to the winter monsoon, the northern parts of the island enjoy much the same sort of temperate climate as the neighbouring provinces of the mainland, but in the southern parts, protected from the monsoon by the mountain ranges, the climate is almost or entirely tropical. Snow falls so rarely that its appearance in 1684 is reported in the native chronicles as a remarkable event. Earthquakes are a much more familiar phenomenon, having occurred, according to the same authority, in 1523, 1526, 1605, 1652, 1677, 1681, 1684, 1702, 1704, 1725, 1742, 1816, 1817 and 1822. Excellent timber of various kinds—eagle-wood, rose-wood, liquidambar, &c.—is one of the principal products of the island, and has even

been specially transported to Peking for imperial purposes. The coco palm flourishes freely even in the north, and is to be found growing in clumps with the *Pinus sinensis*. Rice, cotton, sugar, indigo, cinnamon, betel-nuts, sweet potatoes, ground-nuts and tobacco are all cultivated in varying quantities. The aboriginal inhabitants collect a kind of tea called t'ien ch'a, or celestial tea, which looks like the leaves of a wild camellia, and has an earthy taste when infused. Lead, silver, copper and iron occur in the Shi-Ju shan or "stone-green-hill"; the silver at least was worked till 1850. Gold and lapis lazuli are found in other parts of the island.

The ordinary cattle of Hainan are apparently a cross between the little yellow cow of south China and the zebu of India. Buffaloes are common, and in the neighbourhood of Nanlu at least they are frequently albinos. Horses are numerous but small. Hogs and deer are both common wild animals, and of the latter there are three species, *Cervus Eldi*, *Cervus hippelaphus* and *Cervus vaginalis*. Among the birds, of which 172 species are described by Mr Swinhoe in his paper in *The Ibis* (1870), there are eagles, notably a new species *Spilornis Rutherfordi*, buzzards, harriers, kites, owls, goatsuckers and woodpeckers. The *Upupa ceylonensis* is familiar to the natives as the "bird of the Li matrons," and the *Palaeornis javanica* as the "sugar-cane bird."

Hainan forms a fu or department of the province of Kwang-tung, though strictly it is only a portion of the island that is under Chinese administration, the remainder being still occupied by unsubjugated aborigines. The department contains three chow and ten hien districts. K'iang-chow-hien, in which the capital is situated; Ting-an-hien, the only inland district; Wen-ch'ang-hien, in the north-east of the island; Hui-t'ung-hien, Lo-hui-hien, Ling-shu-hien, Wan-chow, Yai-chow (the southmost of all), Kan-en-hien Ch'ang-hwa-hien, Tan-chow, Lin-kao-hien and Ch'eng-mai-hien. The capital K'iang-chow-fu is situated in the north about 10 li (or 3 m.) from the coast on the river. It is a well-built compact city, and its temples and examination halls are in good preservation. Carved articles in coco-nuts and scented woods are its principal industrial product. In 1630 it was made the seat of a Roman Catholic mission by Benoit de Mathos, a Portuguese Jesuit, and the old cemetery still contains about 113 Christian graves. The port of K'iang-chow-fu at the mouth of the river, which is nearly dry at low water, is called simply Hoi-how, or in the court dialect Hai-K'ow, i.e. seaport. The two towns are united by a good road, along which a large traffic is maintained partly by coolie porters but more frequently by means of wheel-barrow, which serve the purpose of cabs and carts. The value of the trade of the port has risen from £670,600 in 1899 to £719,333 in 1904. In the same year 424 vessels, representing a tonnage of 312,554, visited the port. This trade is almost entirely with the British colony of Hong-Kong, with which the port is connected by small coasting steamers, but since 1893 it has had regular steamboat communication with Haiphong in Tongking. The population of K'iang-chow, including its shipping port of Hoi-how, is estimated at 52,000. The number of foreign residents in 1900 was about 30, most of them officials or missionaries.

The inhabitants of Hainan may be divided into three classes, the Chinese immigrants, the civilized aborigines or Shu-li and the wild aborigines or Sheng-li. The Chinese were for the most part originally from Kwang-si and the neighbouring provinces, and they speak a peculiar dialect, of which a detailed account by Mr Swinhoe was given in *The Phoenix, a Monthly Magazine for China, &c.* (1870). The Shu-li as described by Mr Taintor are almost of the same stature as the Chinese, but have a more decided copper colour, higher cheek-bones and more angular features, while their eyes are not oblique. Their hair is long, straight and black, and their beards, if they have any, are very scanty. They till the soil and bring rice, fuel, timber, grass-cloth, &c., to the Chinese markets. The Sheng-li or Li proper, called also La, Le or Lauy, are probably connected with the Laos of Siam and the Lolo of China. Though not gratuitously aggressive, they are highly intractable, and have given great trouble to the Chinese authorities. Among themselves they carry on

deadly feuds, and revenge is a duty and an inheritance. Though they are mainly dependent on the chase for food, their weapons are still the spear and the bow, the latter being made of wood and strung with bamboo. In marriage no avoidance of similarity of name is required. The bride's face is tattooed according to a pattern furnished by the bridegroom. Their funeral mourning consists of abstaining from drink and eating raw beef, and they use a wooden log for a coffin. When sick they sacrifice oxen. In the spring-time there is a festival in which the men and women from neighbouring settlements move about in gay clothing hand in hand and singing songs. The whole population of the island is estimated at about 2½ millions. At its first conquest 23,000 families were introduced from the mainland. In 1300 the Chinese authorities assign 166,257 inhabitants; in 1370, 201,000; in 1617, 250,524; and in 1835, 1,350,000.

It was in 111 B.C. that Lu-Po-Teh, general of the emperor Wu-ti, first made the island of Hainan subject to the Chinese, who divided it into the two prefectures, Tan-urh or Drooping Ear in the south, so-called from the long ears of the native "king," and Chu-yai or Pearl Shore in the north. During the decadence of the elder branch of the Han dynasty the Chinese supremacy was weakened, but in A.D. 43 the natives were led by the success of Ma-yuan in Tong-king to make a new tender of their allegiance. About this time the whole island took the name of Chu-yai. In A.D. 627 the name of K'ung-chow came into use. On its conquest by the generals of Kublai Khan in 1278 the island was incorporated with the western part of the province of Kwang-tung in a new satrapy, Hai-pek Hai-nan Tao, i.e. the circuit north of the sea and south of the sea. It was thus that Hai-nan-Tao, or district south of the sea or strait, came into use as the name of the island, which, however, has borne the official title of K'ung-chow-fu, probably derived from the Kiung shan or Jade Mountains, ever since 1370, the date of its erection into a department of Kwang-tung. For a long time Hainan was the refuge of the turbulent classes of China and the place of deportation for delinquent officials. It was there, for example, that Su-She or Su-Tung-po was banished in 1097. From the 15th to the 19th century pirates made the intercourse with the mainland dangerous, and in the 17th they were considered so formidable that merchants were allowed to convey their goods only across the narrow Hainan Strait. Since 1863 the presence of English men-of-war has put an end to this evil. According to the treaty of Tientsin, the capital K'ung-chow and the harbour Hoi-how (Hai-Kow) were opened to European commerce; but it was not till 1876 that advantage was taken of the permission.

HAINAU (officially **HAINAU**), a town of Germany, in the Prussian province of Silesia, on the Schnelle Deichsa and the railway from Breslau to Dresden, 12 m. N.W. of Liegnitz. Pop. 10,500. It has an Evangelical and a Roman Catholic church, manufactories of gloves, patent leather, paper, metal ware and artificial manures, and a considerable trade in cereals. Near Hainau the Prussian cavalry under Blücher inflicted a defeat on the French rearguard on the 26th of May 1813.

HAINAUT (Flem. *Hennegouws*, Ger. *Hennegou*), a province of Belgium formed out of the ancient county of Hainaut. Modern Hainaut is famous as containing the chief coal and iron mines of Belgium. There are about 150,000 men and women employed in the mines, and about as many more in the iron and steel works of the province. About 1880 these numbers were not more than half their present totals. The principal towns of Hainaut are Mons, the capital, Charleroi, Tournai, Jumet and La Louvière. The province is watered by both the Scheldt and the Sambre, and is connected with Flanders by the Charleroi-Ghent canal. The area of the province is computed at 930,405 acres or 1453 sq. m. In 1904 the population was 1,192,967, showing an average of 821 per square mile.

Under the successors of Clovis Hainaut formed part, first of the kingdom of Metz, and then of that of Lotharingia. It afterwards became part of the duchy of Lorraine. The first to bear the title of count of Hainaut was Reginar "Long-Neck" (c. 875), who, later on, made himself master of the duchy of Lorraine and died in 916. His eldest son inherited Lower

Lorraine, the younger, Reginar II., the countship of Hainaut, which remained in the male line of his descendants, all named Reginar, until the death of Reginar V. in 1036. His heiress, Richildis, married *en secondes nocces* Baldwin VI. of Flanders, and, by him, became the ancestress of the Baldwin (VI. of Hainaut) who in 1204 was raised by the Crusaders to the empire of Constantinople. The emperor Baldwin's elder daughter Jeanne brought the countship of Hainaut to her husbands Ferdinand of Portugal (d. 1233) and Thomas of Savoy (d. 1259). On her death in 1244, however, it passed to her sister Margaret, on whose death in 1279 it was inherited by her grandson, John of Avesnes, count of Holland (d. 1304). The countship of Hainaut remained united with that of Holland during the 14th and 15th centuries. It was under the counts William I. "the Good" (1304-1337), whose daughter Philippa married Edward III. of England, and William II. (1337-1345) that the communes of Hainaut attained great political importance. Margaret, who succeeded her brother William II. in 1345, by her marriage with the emperor Louis IV. brought Hainaut with the rest of her dominions to the house of Wittelsbach. Finally, early in the 15th century, the countess Jacqueline was dispossessed by Philip the Good of Burgundy, and Hainaut henceforward shared the fate of the rest of the Netherlands.

AUTHORITIES.—The *Chronicon Hanoniense* or *Chronica Hanoniensis* of Giselbert of Mons (d. 1223-1225), chancellor of Count Baldwin V., covering the period between 1040 and 1195, is published in Pertz, *Monum. Germ.* (Hanover, 1840, &c.). The *Chronicon Hanoniense*, ascribed to Baldwin, count of Avesnes (d. 1289), and written between 1278 and 1281, was published under the title *Hist. genealogica comitum Hanoniensium*, &c., at Antwerp (1691 and 1693) and Brussels (1722). The *Annales de Jacques de Guise* (b. 1334; d. 1399) were published by de Fortia d'Urban under the title, *Histoire de Hainaut par Jacques de Guise*, in 19 vols. (Paris, 1826-1838); G. Delacourt, "Bibliographie de l'hist. du Hainaut," in the *Annales du cercle archéologique de Mons*, vol. v. (Mons, 1864); T. Bernier, *Dict. géograph. historique, &c., de Hainaut* (Mons, 1891). See also Ulysse Chevalier, *Répertoire des sources s.v.*

HAINBURG, or **HAMBURG**, a town of Austria, in Lower Austria, 38 m. E.S.E. of Vienna by rail. Pop. (1900), 5134. It is situated on the Danube, only 2½ m. from the Hungarian frontier, and since the fire of 1827 Hainburg has been much improved, being now a handsomely built town. It has one of the largest tobacco manufactories in Austria, employing about 2000 hands, and a large needle factory. It occupies part of the site of the old Celtic town Carnuntum (q.v.). It is still surrounded by ancient walls, and has a gate guarded by two old towers. There are numerous Roman remains, among which may be mentioned the altar and tower at the town-house, on the latter of which is a statue, said to be of Attila. A Roman aqueduct is still used to bring water to the town. On the neighbouring Hainberg is an old castle, built of Roman remains, which appears in German tradition under the name of Heimburg; it was wrested from the Hungarians in 1042 by the emperor Henry III. At the foot of the same hill is a castle of the 13th century, where Ottakar of Bohemia was married to Margaret of Austria in 1252; earlier it was the residence of the dukes of Babenberg. Outside the town, on an island in the Danube, is the ruined castle of Röthelstein or Rothenstein, held by the Knights Templars. Hainburg was besieged by the Hungarians in 1277, was captured by Matthias Corvinus in 1482, and was sacked and its inhabitants massacred by the Turks in 1683.

HAINICHEN, a town of Germany, in the kingdom of Saxony, on the Kleine Striegis, 15 m. N.E. of Chemnitz, on the railway to Rottawein. Pop. (1905), 7752. It has two Evangelical churches, a park, and commercial and technical schools. Hainichen is a place of considerable industry. Its chief manufacture is that of flannels, baize, and similar fabrics; indeed it may be called the centre of this industry in Germany. The special whiteness and excellence of the flannel made in Hainichen are due to the peculiar nature of the water used in the manufacture. There are also large dye-works and bleaching establishments. Hainichen is the birthplace of Gellert, to whose memory a bronze statue was erected in the market-place in 1865. The Gellert institution for the poor was erected in 1815.

HAI-PHONG, a seaport of Tongking, French Indo-China, on the Cua-Cam, a branch of the Song-koi (Red river) delta. The population numbers between 21,000 and 22,000, of whom 12,500 are Annamese, 7500 Chinese (attracted by the rice trade of the port) and 1200 Europeans. It is situated about 30 m. from the Gulf of Tongking and 58 m. E. by S. of Hanoi, with which it communicates by river and canal and by railway. It is the second commercial port of French Indo-China, is a naval station, and has government and private ship-building yards. The harbour is accessible at all times to vessels drawing 19 to 30 ft., but is obstructed by a bar. Hai-phong is the seat of a resident who performs the functions of mayor, and the residency is the chief building of the town. A civil tribunal, a tribunal of commerce and a branch of the Bank of Indo-China are also among its institutions. It is the headquarters of the river steamboat service (*Messageries fluviales*) of Tongking, which plies as far as Lao-kay on the Song-koi, to the other chief towns of Tongking and northern Annam, and also to Hong-kong. Cotton-spinning and the manufacture of cement are carried on.

HAIR (a word common to Teutonic languages), the general term for the characteristic outgrowth of the epidermis forming the coat of mammals. The word is also applied by analogy to the filamentous outgrowths from the body of insects, &c., plants, and metaphorically to anything of like appearance.

For anatomy, &c. of animal hair see **SKIN AND EXOSKELETON**; **FIBRES** and allied articles; **FUR**, and **LEATHER**.

Anthropology.—The human hair has an important place among the physical criteria of race. While its general structure and quantity vary comparatively little, its length in individuals and relatively in the two sexes, its form, its colour, its general consistency and the appearance under the microscope of its transverse section show persistent differences in the various races. It is the persistence of these differences and specially in regard to its colour and texture, which has given to hair its ethnological importance. So obvious a racial differentiation had naturally long ago attracted the attention of anthropologists. But it was not until the 19th century that microscopic examination showed the profound difference in structure between the hair characteristic of the great divisions of mankind. It was in 1863 that Dr Pruner-Bey read a paper before the Paris Anthropological Society entitled "On the Human Hair as a Race Character, examined by aid of the Microscope." This address established the importance of hair as a racial criterion. He demonstrated that the structure of the hair is threefold:—

(1) Short and crisp, generally termed "woolly," elliptical or kidney-shaped in section, with no distinguishable medulla or pith. Its colour is almost always jet black, and it is characteristic of all the black races except the Australians and aborigines of India. This type of hair has two varieties. When the hairs are relatively long and the spiral of the curls large, the head has the appearance of being completely covered, as with some of the Melanesian races and most of the negroes. Haeckel has called this "*eriacomous*" or "woolly" proper. In some negroid peoples, however, such as the Hottentots and Bushmen, the hair grows in very short curls with narrow spirals and forms little tufts separated by spaces which appear bare. The head looks as if it were dotted over with pepper-seed, and thus this hair has gained the name of "peppercorn-growth." Haeckel has called it "*lophocomous*" or "crested." Most negroes have this type of hair in childhood and, even when fully grown, signs of it around the temples. The space between each tuft is not bald, as was at one time generally assumed. The hair grows uniformly over the head, as in all races.

2. Straight, lank, long and coarse, round or nearly so in section, with the medulla or pith easily distinguishable, and almost without exception black. This is the hair of the yellow races, the Chinese, Mongols and Indians of the Americas.

3. Wavy and curly, or smooth and silky, oval in section, with medullary tube but no pith. This is the hair of Europeans, and is mainly fair, though black, brown, red or towy varieties are found.

There is a fourth type of hair describable as "frizzy." It is

easily distinguishable from the Asiatic and European types, but not from the negroid wool. It is always thick and black, and is characteristic of the Australians, Nubians, and certain of the Mulattos. Generally hair curls in proportion to its flatness. The rounder it is the stiffer and lankier. These extremes are respectively represented by the Papuans and the Japanese. Of all hair the woolly type is found to be the most persistent, as in the case of the Brazilian Cafusos, negro and native hybrids. Quatrefages quotes the case of a triple hybrid, "half negro, quarter Cherokee, quarter English," who had short crisp frizzy-looking hair.

Wavy types of hair vary most in colour: almost the deepest hue of black being found side by side with the most flaxen and towy. Colour varies less in the lank type, and scarcely at all in the woolly. The only important exception to the uniform blackness of the negroid wool is to be found among the Wochuas, a tribe of African pygmies whose hair is described by Wilhelm Junker (*Travels in Africa*, iii. p. 82) as "of a dark, rusty brown hue." Fair hair in all its shades is frequent among the populations of northern Europe, but much rarer in the south. According to Dr John Beddoe there are sixteen blonds out of every hundred Scotch, thirteen out of every hundred English, and two only out of a hundred Italians. The percentage of brown hair is 75% among Spaniards, 39 among French and 16 only in Scandinavia. Among the straight-haired races fair hair is far rarer; it is, however, found among the western Finns. Among those races with frizzy hair, red is almost as common as among those with wavy hair. Red hair, however, is an individual anomaly associated ordinarily with freckles. There are no red-haired races.

A certain correlation appears to exist between the nature of hair and its absolute or relative length in the two sexes. Thus straight hair is the longest (Chinese, Red Indians), while woolly is shortest. Wavy hair holds an intermediate position. In the two extremes the difference of length in man and woman is scarcely noticeable. In some lank-haired races, men's tresses are as long as women's, e.g. the Chinese pigtail, and the hair of Redskins which grows to the length sometimes of upwards of 9 ft. In the frizzy-haired peoples, men and women have equally short growths. Bushwomen, the female Hottentot and negroes have hair no longer than men's. It is only in the wavy, and now and again in the frizzy types, that the difference in the sexes is marked. Among European men the length rarely exceeds 12 to 16 in., while with women the mean length is between 25 and 30 in. and in some cases has been known to reach 6 ft. or more.

The growth of hair on the body corresponds in general with that on the head. The hairiest races are the Australians and Tasmanians, whose heads are veritable mops in the thickness and unkempt luxuriance of the locks. Next to them are the Todas, and other hill-tribesmen of India, and the Hairy Ainu of Japan. Traces, too, of the markedly hairy race, now extinct, supposed to be the ancestor of Toda and Ainu alike, are to be found here and there in Europe, especially among the Russian peasantry. The least hairy peoples are the yellow races, the men often scarcely having rudimentary beards, e.g. Indians of America and the Mongols. Negroid peoples may be said to be intermediate, but usually incline to hairlessness. The wavy-haired populations hold also an intermediate position, but somewhat incline to hairiness. Among negroes especially no rule can be formulated. Bare types such as the Bushmen and western negroes are found contiguous to hairy types such as the inhabitants of Ashantee. Neither is there any rule as to baldness. From statistics taken in America it would seem that it is ten times less frequent among negroes than among whites between the ages of thirty-three and forty-five years, and thirty times less between twenty-one and thirty-two years. Among Mulattos it is more frequent than among negroes but less than among whites. It is rarer among Redskins than among negroes. The *lanugo* or downy hairs, with which the human foetus is covered for some time before birth and which is mostly shed in the womb, and the minute hairs which cover nearly every part of the adult human body, may be regarded as rudimentary remains of a complete hairy covering in the ancestors of mankind. The *Pileose*, or

at all events Miocene precursor of man, was a furred creature. The discovery of Egyptian mummies six thousand years old or more has proved that this physical criterion remains unchanged, and that it is to-day what it was so many scores of centuries back. Perhaps, then, the primary divisions of mankind were distinguished by hair the same in texture and colour as that which characterizes to-day the great ethnical groups. The wavy type bridges the gulf between the lank and woolly types, all in turn derived from a common hair-covered being. In this connexion it is worth mention, as pointed out by P. Topinard, that though the regions occupied by the negroid races are the habitat of the anthropoid apes, the hair of the latter is real hair, not wool. Further in the eastern section of the dark domain, while the Papuan is still black and dolichocephalic, his presumed progenitor, the orang-utan, is brachycephalic with decidedly red hair. Thus the white races are seen to come nearest the higher apes in this respect, yellow next, and black farthest removed.

No test has proved, on repeated examination, to be a safer one of racial purity than the quality of hair, and Pruner-Bey goes so far as to suggest that "a single hair presenting the average form characteristic of the race might serve to define it." At any rate a hair of an individual bears the stamp of his origin.

See Dr Pruner-Bey in *Mémoires de la société d'anthropologie*, ii. P. A. Brown, *Classification of Man kind by the Hair*; P. Topinard, *L'Homme dans la nature* (1891), chap. vi.

Commerce.—Hair enters into a considerable variety of manufactures. Bristles are the stout elastic hairs obtained from the backs of certain breeds of pigs. The finest qualities, and the greatest quantities as well, are obtained from Russia, where a variety of pig is reared principally on account of its bristles. The best and most costly bristles are used by shoemakers, secondary qualities being employed for toilet and clothes-brushes, while inferior qualities are worked up into the commoner kinds of brushes used by painters and for many mechanical purposes. For artists' use and for decorative painting, brushes or pencils of hair from the sable, camel, badger, polecat, &c., are prepared. The hair of various animals which is too short for spinning into yarn is utilized for the manufacture of felt. For this use the hair of rabbits, hares, beavers and of several other rodents is largely employed, especially in France, in making the finer qualities of felt hats. Cow hair, obtained from tanneries, is used in the preparation of roofing felts, and felt for covering boilers or steam-pipes, and for other similar purposes. It is also largely used by plasterers for binding the mortar of the walls and roofs of houses; and it is to some extent being woven up into coarse friezes, horse-cloths, railway rugs and inferior blankets. The tail hair of oxen is also of value for stuffing cushions and other upholstery work, for which purpose, as well as for making the official wigs of law officers, barristers, &c, the tail and body hair of the yak or Tibet ox is also sometimes imported into Europe. The tail and mane hair of horses is in great demand for various purposes. The long tail hair is especially valuable for weaving into hair-cloth, mane hair and the short tail hair being, on the other hand, principally prepared and curled for stuffing the chairs, sofas and couches which are covered with the cloth manufactured from the long hair. The horse hair used in Great Britain is principally obtained from South America, Germany and Russia, and its sorting, cleaning and working up into the various manufactures dependent on the material are industries of some importance. In addition to the purposes already alluded to, horse hair is woven into crinoline for ladies' bonnets, plaited into fishing lines, woven into bags for oil and cider presses, and into straining cloths for brewers, &c., and for numerous other minor uses. The manufactures which arise in connexion with human hair are more peculiar than important, although occasionally fashions arise which cause a large demand for human hair. The fluctuations of such fashions determine the value of hair; but at all times long tresses are of considerable value. Grey, light, pale and auburn hair are distinguished as extra colours, and command much higher prices than the common shades. The light-coloured hair is chiefly obtained in Germany and Austria, and the south of France is the principal source of the darker shades. In the south of France the cultivation and sale of heads of hair by peasant girls is a common practice; and hawkers attend fairs for the special purpose of engaging in this traffic. Hair 5 and even 6 ft. long is sometimes obtained. Scarcely any of the "raw material" is obtained in the United Kingdom except in the form of ladies' "combing." Bleaching of hair by means of peroxide of hydrogen is extensively practised, with the view of obtaining a supply of golden locks, or of preparing white hair for mixing to match grey shades; but in neither case is the result very successful. Human hair is worked up into a great variety of wigs, scalps, artificial fronts, frizzets and curls, all for supplementing the scanty or falling resources of nature. The plaiting of human hair into articles of jewellery, watch-guards, &c., forms a distinct branch of trade.

HAIR-TAIL (*Trichurus*), a marine fish belonging to the *Acanthopterygii scombriformes*, with a long band-like body terminating in a thread-like tail, and with strong prominent teeth in both jaws. Several species are known, of which one, common in the tropical Atlantic, not rarely reaches the British Islands.

HAITI [HAÏTI, HAYTI, SAN DOMINGO, or HISPANIOLA], an island in the West Indies. It lies almost in the centre of the chain and, with the exception of Cuba, is the largest of the group. Its greatest length between Cape Engano on the east and Cape des Irois on the west is 407 m., and its greatest breadth between Cape Beata on the south and Cape Isabella on the north 160 m. The area is 28,000 sq. m., being rather less than that of Ireland. From Cuba, 70 m. W.N.W., and from Jamaica, 130 m. W.S.W., it is separated by the Windward Passage; and from Porto Rico, 60 m. E., by the Mona Passage. It lies between 17° 31' and 20° 0' N. and 68° 20' and 74° 28' W. From the west coast project two peninsulas. The south-western, of which Cape Tiburon forms the extremity, is the larger. It is 150 m. long and its width varies from 20 to 40 m. Columbus landed at Môle St Nicholas at the point of the north-western peninsula, which is 50 m. long, with an average breadth of 40 m. Between these lies the Gulf of Gonave, a triangular bay, at the apex of which stands the city of Port-au-Prince. The island of Gonave, opposite the city at a distance of 27 m., divides the entrance to



Port-au-Prince into two fine channels, and forms an excellent harbour, 200 sq. m. in extent, the coral reefs along the coast being its only defect. On the north-east coast is the magnificent Bay of Samana, formed by the peninsula of that name, a mountain range projecting into the sea; its mouth is protected by a coral reef stretching 8½ m. from the south coast. There is however, a good passage for ships, and within lies a safe and beautiful expanse of water 300 sq. m. in extent. Beyond Samana, with the exception of the poor harbour of Santo Domingo, there are no inlets on the east and south coasts until the Bays of Ocoa and Neyba are reached. The south coast of the Tiburon peninsula has good harbours at Jacmel, Baint, Aquin and Les Cayes or Aux Cayes. The only inlets of any importance between Aux Cayes and Port-au-Prince are Jeremie and the Bay of Baraderes. The coast line is estimated at 1250 m.

Haiti is essentially a mountainous island. Steep escarpments leading to the rugged uplands of the interior, reach almost everywhere down to the shores, leaving only here and there a few strips of beach. There are three fairly distinct mountain ranges, the northern, central and southern, with parallel axes from E. to W.: while extensive and fertile plains lie between them. The northern range usually called the Sierra de Monti Cristi, extends from Cape Samana on the east to Cape Fragate on the west. It has a mean elevation of 3000 ft., culminating in the Loma Diego Campo (3855 ft.), near the centre of the range. The central range runs from Cape Engano to Cape St Nicholas, some 400 m. in an oblique direction from E. to W. Towards the centre of the island it broadens and forms two distinct chains; the northern, the Sierra del Cibao, constituting the backbone of Haiti; the southern curving first S.W., then N.W., and reaching the sea near St Marc. In addition to these there are a number of secondary crests, difficult to trace to the backbone of the system, since the loftiest peaks are usually on some lateral ridge. Such for instance is Loma Tina (10,300 ft.) the highest

elevation on the island, which rises as a spur N.W. of the city of Santo Domingo. In the Sierra del Cibao, the highest summit is the Pico del Yaqui (9700 ft.). The southern range runs from the Bay of Neyba due W. to Cape Tiburon. Its highest points are La Selle (8900 ft.) and La Hotte (7400 ft.). The plain of Seybo or Los Llanos is the largest of the Haitian plains. It stretches eastwards from the river Ozama for 95 m. and has an average width of 16 m. It is perfectly level, abundantly watered, and admirably adapted for the rearing of cattle. But perhaps the grandest is the Vega Real, or Royal Plain, as it was called by Columbus, which lies between the Cibao and Monti Cristi ranges. It stretches from Samana Bay to Manzanillo Bay, a distance of 140 m., but is interrupted in the centre by a range of hills in which rise the rivers which drain it. The northern part of this plain, however, is usually known as the Valley of Santiago. Most of the large valleys are in a state of nature, in part savanna, in part wooded, and all very fertile.

There are four large rivers. The Yaqui, rising in the Pico del Yaqui falls, after a tortuous north-westerly course through the valley of Santiago, into Manzanillo Bay; its mouth is obstructed by shoals, and it is navigable only for canoes. The Neyba, or South Yaqui, also rises in the Pico del Yaqui and flows S. into the Bay of Neyba. In the mountains within a few miles from the sources of these rivers, rise the Yuna and the Artibonite. The Yuna drains the Vega Real, flows into Samana Bay, and is navigable by light-draught vessels for some distance from its mouth. The Artibonite flows through the valley of its name into the Gulf of Gonave. Of the smaller rivers the Ozama, on which the city of Santo Domingo stands, is the most important. The greatest lake is that of Enriquillo or Xaragua, at a height of 300 ft. above sea-level. It is 27 m. long by 8 m. broad and very deep. Though 25 m. from the sea its waters are salt, and the Haitian negroes call it Etang Salé. After heavy rains it occasionally forms a continuous sheet of water with another lake called Azuey, or Etang Saumatre, which is 16 m. long by 4 m. broad; on these occasions the united lake has a total length of 60 m. and is larger than the Lake of Geneva. Farther S. is the Icten de Limon, 5 m. long by 2 m. broad, a fresh-water lake with no visible outlet. Smaller lakes are Rincon and Miragoane. There are no active volcanoes, but earthquakes are not infrequent.

Geology.—The geology of Haiti is not very imperfectly known, and large tracts of the island have never been examined by a geologist. It is possible that the schists that have been observed in some parts of the island may be of Pre-cretaceous age, but the oldest rocks in which fossils have yet been found belong to the Cretaceous System, and the geological sequence is very similar to that of Jamaica. Excluding the schists of doubtful age, the series begins with sandstones and conglomerates, containing pebbles of syenite, granite, diorite, &c.; and these are overlaid by marls, clays and limestones containing *Hippurites*. Then follows a series of sandstones, clays and limestones with occasional seams of lignite, evidently of shallow-water origin. These are referred by R. T. Hill to the Eocene, and they are succeeded by chalky beds which were laid down in a deeper sea and which probably correspond with the Montpelier beds of Jamaica (Oligocene). Finally, there are limestones and marls composed largely of corals and molluscs, which are probably of very late Tertiary or Post-tertiary age. Until, however, the island has been more thoroughly examined, the correlation of the various Tertiary and Post-tertiary deposits must remain doubtful. Some of the beds which Hill has placed in the Eocene have been referred by earlier writers to the Miocene. Tuppenhauer describes extensive eruptions of basalt of Post-pliocene age.

Fauna and Flora.—The fauna is not extensive. The agouti is the largest wild mammal. Birds are few, excepting water-fowl and pigeons. Snakes abound, though few are venomous. Lizards are numerous, and insects swarm in the low parts, with tarantulas, scorpions and centipedes. Caymans are found in the lakes and rivers, and the waters teem with fish and other sea food. Wild cattle, hogs and dogs, descendants of those brought from Europe, roam at large on the plains and in the forests. The wild hogs furnish much sport to the natives, who hunt them with dogs trained for the purpose.

In richness and variety of vegetable products Haiti is not excelled by any other country in the world. All tropical plants and trees grow in perfection, and nearly all the vegetables and fruits of temperate climates may be successfully cultivated in the highlands. Among indigenous products are cotton, rice, maize, tobacco, cocoa, ginger, native indigo (*Indigo marson* or *sansouge*), arrowroot, manioc or cassava, pimento, banana, plantain, pine-apple, artichoke, yam and sweet potato. Among the imported plants and fruits are sugarcane, coffee, indigo (called *indigo franc*, to distinguish it from the native), melons, cabbage, lucerne, guinea grass and the breadfruit, mango, caimite, orange, almond, apple, grape, mulberry and fig. Most of the imported fruits have degenerated from want of care, but the mango, now spread over nearly the whole island, has become almost a necessary article of food; the bread-fruit has likewise become common, but is not so much esteemed. Haiti is also rich in woods, especially in cabinet and dye woods; among the former are mahogany, manchinee, satinwood, rosewood, cinnamon wood (*Canella alba*), yellow acacia (*Sideroxylon mastichodendron*) and gri-gri; and among the latter are Brazil wood, logwood, fustic and sassafras. On the mountains are extensive forests of pine and a

species of oak; and in various parts occur the locust, ironwood, cypress or Bermuda cedar, palmetto and many kinds of palms.

Climate.—Owing to the great diversity of its relief Haiti presents a wider range of climate than any other part of the Antilles. The yearly rainfall is abundant, averaging about 120 in., but the wet and dry seasons are clearly divided. At Port-au-Prince the rainy season lasts from April to October, but varies in other parts of the island, so that there is never a season when rain is general. The mountain districts are constantly bathed in dense mists and heavy dews, while other districts are almost rainless. Owing to its sheltered position the heat at Port-au-Prince is greater than elsewhere. In summer the temperature there ranges between 80° and 95° F. and in winter between 70° and 80° F. Even in the highlands the mercury never falls below 45° F. Hurricanes are not so frequent as in the Windward Isles, but violent gales often occur. The prevailing winds are from the east.

The Republic of Haiti.—Haiti is divided into two parts, the negro republic of Haiti owning the western third of the island, while the remainder belongs to Santo Domingo (*q.v.*) or the Dominican Republic. Between these two governments there exists the strongest political antipathy.

Although but a small state, with an area of only 10,204 sq. m., the republic of Haiti is, in many respects, one of the most interesting communities in the world, as it is the earliest and most successful example of a state peopled, and governed on a constitutional model, by negroes. At its head is a president assisted by two chambers, the members of which are elected and hold office under a constitution of 1859. This constitution, thoroughly republican in form, is French in origin, as are also the laws, language, traditions and customs of Haiti. In practice, however, the government resolves itself into a military despotism, the power being concentrated in the hands of the president. The Haitians seem to possess everything that a progressive and civilized nation can desire, but corruption is spread through every portion and branch of the government. Justice is venal, and the police are brutal and inefficient. Since 1869 the Roman Catholic has been the state religion, but all classes of society seem to be permeated with a thinly disguised adherence to the horrid rites of *Voodoo* (*q.v.*), although this has been strenuously denied. The country is divided into 5 *départements*, 23 *arrondissements* and 67 *communes*. Each *département* and *arrondissement* is governed by a general in the army. The army numbers about 7000 men, and the navy consists of a few small vessels. Elementary education is free, and there are some 400 primary schools; secondary education is mainly in the hands of the church. The Sisters of Charity and the Christian Brothers have schools at Port-au-Prince, where there is also a lyceum, a medical and a law school. The children of the wealthier classes are usually sent to France for their education. The unit of money is the *gourde*, the nominal value of which is the same as the American dollar, but it is subject to great fluctuations. The revenue is almost entirely derived from customs, paid both on imports and exports. There being a lack of capital and enterprise, the excessive customs dues produce a very depressed condition of trade. Imports are consequently confined to bare necessities, the cheapest sorts of dry and fancy goods, matches, flour, salt beef and pork, codfish, lard, butter and similar provisions. The exports are coffee, cocoa, logwood, cotton, gum, honey, tobacco and sugar. The island is one of the most fertile in the world, and if it had an enlightened and stable government, an energetic people, and a little capital, its agricultural possibilities would seem to be endless. Communications are bad; the roads constructed during the French occupation have degenerated into mere bridle tracks. There is a coast service of steamers, maintained since 1863, and 26 ports are regularly visited every ten days. Foreign communication is excellent, more foreign steamships visiting this island than any other in the West Indies. A railway from Port-au-Prince runs through the Plain of Cul de Sac for 28 m. to Manneville on the Etang Saumatre, another runs from Cap Haitien to La Grande Rivière, 15 m. distant.

The people are almost entirely pure-blooded negroes, the mulattoes, who form about 10% of the population, being a rapidly diminishing and much-hated class. The negroes are a kindly, hospitable people, but ignorant and lazy. They have

a passion for dancing weird African dances to the accompaniment of the tom-tom. Marriage is neither frequent nor legally prescribed, since children of looser unions are regarded by the state as legitimate. In the interior polygamy is frequent. The people generally speak a curious but not unattractive *patois* of French origin, known as Creole. French is the official language, and by a few of the educated natives it is written and spoken in its purity. On the whole it must be owned that, after a century of independence and self-government, the Haitian people have made no progress, if they have not actually shown signs of retrogression. The chief towns are Port-au-Prince (pop. 75,000), Cap-Haïtien (20,000), Les Cayes (25,000), Gonaïve (18,000), and Port de Paix (10,000). Jeremie was the birthplace of the elder Dumas. The ruins of the wonderful palace of Sans-Souci and of the fortress of La Ferrière, built by King Henri Christophe (1807-1825), can be seen near Millot, a town 9 m. inland from Cap-Haïtien. Plaisance (25,000), Gros Morne (22,000) and La Croix des Bouquets (20,000) are the largest towns in the interior. The entire population of the republic is about 1,500,000.

History.—The history of Haiti begins with its discovery by Columbus, who landed from Cuba at Mole St Nicholas on the 6th of December 1492. The natives called the country Haiti (mountainous country), and Quisquica (vast country). Columbus named it *Espagnola* (Little Spain), which was latinized into *Hispaniola*. At the time of its discovery, the island was inhabited by about 2,000,000 Indians, who are described by the Spaniards as feeble in intellect and physically defective. They were, however, soon exterminated, and their place was supplied (as early as 1512) by slaves imported from Africa, the descendants of whom now possess the land. Six years after its discovery Columbus had explored the interior of the island, founded the present capital, and had established flourishing settlements at Isabella, Santiago, La Vega, Porto Plata and Bonao. Mines had been opened up, and advances made in agriculture. Sugar was introduced in 1506, and in a few years became the staple product. About 1630, a mixed company of French and English, driven by the Spaniards from St Kitts, settled on the island of Tortuga, where they became formidable under the name of Buccaneers. They soon obtained a footing on the mainland of Haiti, and by the treaty of Ryswick, 1697, the part they occupied was ceded to France. This new colony, named Saint Dominique, subsequently attained a high degree of prosperity, and was in a flourishing state when the French Revolution broke out in 1789. The population was then composed of whites, free coloured people (mostly mulattoes) and negro slaves. The mulattoes demanded civil rights, up to that time enjoyed only by the whites; and in 1791 the National Convention conferred on them all the privileges of French citizens. The whites at once adopted the most violent measures, and petitioned the home government to reverse the decree, which was accordingly revoked. In August 1791, the plantation slaves broke out into insurrection, and the mulattoes threw in their lot with them. A period of turmoil followed, lasting for several years, during which both parties were responsible for acts of the most revolting cruelty. Commissioners were sent out from France with full powers to settle the dispute, but although in 1793 they proclaimed the abolition of slavery, they could effect nothing. To add further to the troubles of the colony, it was invaded by a British force, which, in spite of the climate and the opposition of the colonists, succeeded in maintaining itself until driven out in 1798 by Toussaint l'Ouverture. By treaty with Spain, in 1795, France had acquired the title to the entire island.

By 1801, Toussaint l'Ouverture, an accomplished negro of remarkable military genius, had succeeded in restoring order. He then published, subject to the approval of France, a form of constitutional government, under which he was to be governor for life. This step, however, roused the suspicions of Bonaparte, then first consul, who determined to reduce the colony and restore slavery. He sent out his brother-in-law, General Leclerc, with 25,000 troops; but the colonists offered a determined, and often ferocious, resistance. At length, wearied of the struggle, Leclerc

proposed terms, and Toussaint, induced by the most solemn guarantees on the part of the French, laid down his arms. He was seized and sent to France, where he died in prison in 1803. The blacks, infuriated by this act of treachery, renewed the struggle, under Jean Jacques Dessalines (1758-1806), with a barbarity unequalled in previous contests. The French, further embarrassed by the appearance of a British fleet, were only too glad to evacuate the island in November 1803.

The opening of the following year saw the declaration of independence, and the restoration of the aboriginal name of Haiti. Dessalines, made governor for life, inaugurated his rule with a bloodthirsty massacre of all the whites. In October 1804, he proclaimed himself emperor and was crowned with great pomp; but in 1806 his subjects, growing tired of his tyranny, assassinated him. His position was now contended for by several chiefs, one of whom, Henri Christophe (1767-1820), established himself in the north, while Alexandre Sabes Pétion (1770-1818) took possession of the southern part. The Spaniards re-established themselves in the eastern part of the island, retaining the French name, modified to Santo Domingo. Civil war now raged between the adherents of Christophe and Pétion, but in 1810 hostilities were suspended. Christophe declared himself king of Haiti under the title of Henry I.; but his cruelty caused an insurrection, and in 1820 he committed suicide. Pétion was succeeded in 1818 by General Jean Pierre Boyer (1776-1850), who, after Christophe's death, made himself master of all the French part of the island. In 1821 the eastern end of the island proclaimed its independence of Spain, and Boyer, taking advantage of dissensions there, invaded it, and in 1822 the dominion of the whole island fell into his hands. Boyer held the presidency of the new government, which was called the republic of Haiti, until 1843, when he was driven from the island by a revolution. In 1844 the people at the eastern end of the island again asserted their independence. The republic of Santo Domingo was established, and from that time the two political divisions have been maintained. Meanwhile in Haiti revolution followed revolution, and president succeeded president, in rapid succession. Order, however, was established in 1849, when Soulouque, who had previously obtained the presidency, proclaimed himself emperor, under the title of Faustin I. After a reign of nine years he was deposed and exiled, the republic being restored under the mulatto president Fabre Geffrard. His firm and enlightened rule rendered him so unpopular that in 1867 he was forced to flee to Jamaica. He was succeeded by Sylvestre Salnave, who, after a presidency of two years, was shot. Nissage Saget (1870), Dominique (1874), and Boisrond-Camal (1876) followed, each to be driven into exile by revolution. The next president, Salomon, maintained himself in office for ten years, but he too was driven from the country and died in exile. Civil war raged in 1888-1889 between Generals Légitime and Hippolyte, and the latter succeeded in obtaining the vacant presidency. He ruled with the most absolute authority till his death in 1896. General Tiresias Simon Sam followed and ruled till his flight to Paris in 1902. The usual civil war ensued, and after nine months of turmoil, order was restored by the election of Nord Alexis in December 1902.

Alexis' administration was unsuccessful, and was marked by many disturbances, culminating in his expulsion. In 1904 there was an attack by native soldiery on the French and German representatives, and punishment was exacted by these powers. In December 1904 ex-president Sam, his wife and members of his ministry were sentenced to long terms of imprisonment for fraudulently issuing bonds. In December 1907 a conspiracy against the government was reported and the ringleaders were sentenced to death. But in January 1908 the revolution spread, and Gonaïve and St Marc and other places were reported to be in the hands of the insurgents. Prompt measures were taken, the rising was checked, and Alexis announced the pardon of the revolutionaries. In March, however, this pacific policy was reversed by a new ministry; some suspects were summarily executed, and the attitude of the government was only modified when the powers sent war-ships to Port-au-Prince. In September

the criminal court at the capital sentenced to death, by default, a large number of persons implicated in the risings earlier in the year, and in November revolution broke out again. General Antoine Simon raised his standard at Aux Cayes. Disaffection was rife among the government troops, who deserted to him in great numbers. On the 2nd of December Port-au-Prince was occupied without bloodshed by the revolutionaries, and Alexis took to flight, escaping violence with some difficulty, and finding refuge on a French ship. General Simon then assumed the presidency. At the end of April 1800 Alexis died in Jamaica, in circumstances of some obscurity; it had just been discovered that a plot was on foot to depose Simon, and further trouble was threatened.

AUTHORITIES.—B. Edwards, *Hist. Survey of the Island of S. Domingo* (London, 1804); Jordan, *Geschichte der Insel Haiti* (Leipzig, 1846); Linstant Pradin, *Kacueil général des lois et actes du gouvernement d'Haiti* (Paris, 1851-1865); Monte y Tejada, *Historia de Santo Domingo* (Havana, 1853); Saint Amand, *Hist. des révolutions d'Haiti* (Paris, 1859); Sam. Hazard, *Santo Domingo, Past and Present* (London, 1873), with bibliography; Sir Spencer St John, *Haiti, or the Black Republic* (London, 1889); L. Gentil Tippenhauer, *Die Insel Haiti* (Leipzig, 1893); Marcellin, *Haiti, études économiques, sociales, et politiques*; and *Haiti, ses guerres civiles, leurs causes* (Paris, 1895); Hesketh Pritchard, *Where Black Rules White* (London, 1900). For geology, see W. M. Gabb, "On the Topography and Geology of Santo Domingo," *Trans. Amer. Phil. Soc.*, Philadelphia, new series, vol. xv. (1881), pp. 49-259, with map; L. G. Tippenhauer, *Die Insel Haiti* (Leipzig, 1893); see also several articles by L. G. Tippenhauer in *Peterm. Mitt.* 1899 and 1901. A comparison with the Jamaican succession will be found in R. T. Hill, "The Geology and Physical Geography of Jamaica," *Bull. Mus. Comp. Zool.*, Harvard, vol. xxiv. (1899).

HAJIPUR, a town of British India, in the Musaffarpur district of Bengal, on the Gandak, just above its confluence with the Ganges opposite Patna. Pop. (1901), 21,398. Hajipur figures conspicuously in the history of the struggles between Akbar and his rebellious Afghan governors of Bengal, being twice besieged and captured by the imperial troops, in 1579 and 1574. Within the limits of the old fort is a small stone mosque, very plain, but of peculiar architecture, and attributed to Hâjî Ilyâs, its traditional founder (c. 1350). Its command of water traffic in three directions makes the town a place of considerable commercial importance. Hajipur has a station on the main line of the Bengal and North-western railway.

HAJJ or **HADJ**, the Arabic word, meaning literally a "setting out," for the greater pilgrimage of Mahommedans to Mecca, which takes place from the 8th to the 10th of the twelfth month of the Mahommedan year; the lesser pilgrimage, called *umrah* or *omro*, may be made to the mosque at Mecca at any time other than that of the hajj proper, and is also a meritorious act. The term *hajji* or *hadji* is given to those who have performed the greater pilgrimage. The word *hajji* is sometimes loosely used of any Mahommedan pilgrim to a sacred place or shrine, and is also applied to the pilgrimages of Christians of the East to the Holy Sepulchre at Jerusalem (see **MECCA**; **MAHOMMEDAN RELIGION**).

HÂJÎ KHALÎFA [in full *Mustafâ ibn 'Abdallâh Katib Chelebi Hâjî Khalifa*] (ca. 1599-1658), Arabic and Turkish author, was born at Constantinople. He became secretary to the commissariat department of the Turkish army in Anatolia, was with the army in Bagdad in 1625, was present at the siege of Erzerum, and returned to Constantinople in 1628. In the following year he was again in Bagdad and Hamadân, and in 1633 at Aleppo, whence he made the pilgrimage to Mecca (hence his title Hâjî). The following year he was in Erivân and then returned to Constantinople. Here he obtained a post in the head-office of the commissariat department, which afforded him time for study. He seems to have attended the lectures of great teachers up to the time of his death, and made a practice of visiting bookshops and noting the titles and contents of all books he found there. His largest work is the *Bibliographical Encyclopædia* written in Arabic. In this work, after five chapters dealing with the sciences generally, the titles of Arabian, Persian and Turkish books written up to his own time are arranged in alphabetical order. With the titles are given, where possible, short notes on the author, his date, and sometimes the intro-

ductory words of his work. It was edited by G. Fingel with Latin translation and a useful appendix (7 vols. Leipzig, 1835-1836). The text alone of this edition has been reproduced at Constantinople (1893).

Hâjî Khalifa also wrote in Turkish: a chronological conspectus of general history (translated into Italian by G. R. Carli, Venice, 1697); a history of the Turkish empire from 1594 to 1655 (Constantinople, 1670); a history of the naval wars of the Turks (Constantinople, 1729; chapters 1-4 translated by J. Mitchell, London, 1831); a general geography published at Constantinople, 1732 (Latin trans. by M. Norberg, London and Götting, 1818; German trans. of part by J. von Hammer, Vienna, 1812; French trans. of part by V. de St Martin in his *Geography of Asia Minor*, vol. 1).

For his life see the preface to Fingel's edition; list of his works in C. Brockelmann's *Gesch. d. arabischen Literatur* (Berlin, 1902), vol. ii., pp. 428-429. (G. W. T.)

HAKE, EDWARD (fl. 1579), English satirist, was educated under John Hopkins, the part-author of the metrical version of the Psalms. He resided in Gray's Inn and Barnard's Inn, London. In the address "To the Gentle Reader" prefixed to his *News out of Pauls Churchyard* . . . *Otherwise entitled Syr Nummus* (2nd ed., 1579) he mentions the "first three yeeres which I spent in the Innes of Channery, being now about a dosen of yeeres passed." In 1585 and 1586 he was mayor of New Windsor, and in 1588 he represented the borough in parliament. His last work was published in 1604. He was protected by the earl of Leicester, whose policy it was to support the Puritan party, and who no doubt found a valuable ally in so vigorous a satirist of error in clerical places as was Hake. *News out of Pauls Churchyard, A Trappe for Syr Monye*, first appeared in 1567, but no copy of this impression is known, and it was re-issued in 1579 with the title quoted above. The book takes the form of a dialogue between Bertulph and Paul, who meet in the aisles of the cathedral, and is divided into eight "satyrs," dealing with the corruption of the higher clergy and of judges, the greed of attorneys, the tricks of physicians and apothecaries, the sumptuary laws, extravagant living, Sunday sports, the abuse of St Paul's cathedral as a meeting-place for business and conversation, usury, &c. It is written in rhymed fourteen-syllable metre, which is often more comic than the author intended. It contains, amid much preface matter, a note to the "carping and scornfull Sicophant," in which he attacks his enemies with small courtesy and much alliteration. One is described as a "carping careless cankerd churle."

He also wrote a translation from Thomas à Kempis, *The Imitation, or Following of Christ* (1567, 1568); *A Touchstone for this Time Present* (1574), a scurrilous attack on the Roman Catholic Church, followed by a treatise on education; *A Commemoration of the . . . Reigns of . . . Elizabeth* (1575), enlarged in 1578 to *A Joyfull Continuance of the Commemoration, &c.*; and of *Gold's Kingdom, and this Unhelping Age* (1604), a collection of pieces in prose and verse, in which the author inveighs against the power of gold. A bibliography of these and of Hake's other works was compiled by Mr Charles Edmonds for his edition in 1872 of the *News* (Ashm Reprints, No. 2, 1872).

HAKE, THOMAS GORDON (1809-1895), English poet, was born at Leeds, of an old Devonshire family, on the 26th of March 1809. His mother was a Gordon of the Huntly branch. He studied medicine at St George's hospital and at Edinburgh and Glasgow, but had given up practice for many years before his death, and had devoted himself to a literary life. In 1830 he published a prose epic *Vates*, republished in *Ainsworth's magazine* as *Valdarna*, which attracted the attention of D. G. Rossetti. In after years he became an intimate member of the circle of friends and followers gathered round Rossetti, who at last departed from his usual custom as to review Hake's poems in the *Academy* and in the *Fortnightly Review*. In 1871 he published *Madeline*; 1872, *Parables and Tales*; 1883, *The Serpent Play*; 1890, *New Day Sonnets*; and in 1892 his *Memoirs of Eighty Years*. Dr Hake's works had much subtlety and felicity of expression, and were warmly appreciated in a somewhat restricted literary circle. In his last published verse, the sonnets, he shows an advance in facility on the occasional harshness of his earlier work. He was given a Civil List literary pension in 1893, and died on the 11th of January 1895.

HAKE (*Merluccius vulgaris*), a fish which differs from the cod in having only two dorsal fins and one anal. It is very common on the coasts of Europe and eastern North America, but its flesh is much less esteemed than that of the true *Gadus*. Specimens 4 ft. in length are not scarce. There are local variations in the use of "hake" as a name; in America the "silver hake" (*Merluccius bilinearis*), sometimes called "whiting," and "Pacific hake" (*Merluccius productus*) are also food-fishes of inferior quality.

HAKKAS ("Guests," or "Strangers"), a people of S.W. China, chiefly found in Kwang-Tung, Fu-Kien and Formosa. Their origin is doubtful, but there is some ground for believing that they may be a cross between the aboriginal Mongolic element of northern China and the Chinese proper. According to their tradition, they were in Shantung and northern China as early as the 3rd century B.C. In disposition, appearance and customs they differ from the true Chinese. They speak a distinct dialect. Their women, who are prettier than the pure Chinese, do not compress their feet, and move freely about in public. The Hakkas are a most industrious people and furnish at Canton nearly all the coolie labour employed by Europeans. Their intelligence is great, and many noted scholars have been of Hakka birth. Hung Sin-tuan, the leader in the Taiping rebellion, was a Hakka. In Formosa they serve as intermediaries between the Chinese and European traders and the natives. From time immemorial they seem to have been persecuted by the Chinese, whom they regard as "foreigners," and with whom their means of communication is usually "pidgin English." The earliest persecution occurred under the "first universal emperor" of China, Shi-Hwang-ti (246-210 B.C.). From this time the Hakkas appear to have become wanderers. Sometimes for generations they were permitted to live unmolested, as under the Han dynasty, when some of them held high official posts. During the Tang dynasty (7th, 8th, and 9th centuries) they settled in the mountains of Fu-kien and on the frontiers of Kwang-Tung. On the invasion of Kublai Khan, the Hakkas distinguished themselves by their bravery on the Chinese side. In the 14th century further persecutions drove them into Kwang-Tung.

See "An Outline History of the Hakkas," *China Review* (London, 1873-1874), vol. ii.; Pitou, "On the Origin and History of the Hakkas," ed. Dyer Ball, *Easy Lessons in the Hakka Dialect* (1884), *Things Chinese* (London, 1893); Schaub, "Proverbs in Daily Use among the Hakkas," in *China Review* (London, 1894-1895), vol. xxi.; Rev. J. Edkins, *China's Place in Philology*; Girard de Rialle, *Rev. d'extrême*, (Jan. and April, 1885); G. Taylor, "The Aborigines of Formosa," *China Review*, xiv. p. 198 seq., also xvi. No. 3. "A Ramble through Southern Formosa."

HAKLUYT, RICHARD (c. 1553-1616), British geographer, was born of good family in or near London about 1553. The Hakluys were of Welsh extraction, not Dutch as has been supposed. They appear to have settled in Herefordshire as early as the 13th century. The family seat was Eaton, 2 m. S.E. of Leominster. Hugo Hakluys was returned M.P. for that borough in 1304/5. Richard went to school at Westminster, where he was a queen's scholar; while there his future bent was determined by a visit to his cousin and namesake, Richard Hakluys of the Middle Temple. His cousin's discourse, illustrated by "certain bookes of cosmographie, an universall mappe, and the Bible," made young Hakluys resolve to "prosecute that knowledge and kind of literature." Entering Christ Church, Oxford, in 1570, "his exercises of duty first performed," he fell to his intended course of reading, and by degrees perused all the printed or written voyages and discoveries that he could find. He took his B.A. in 1573/4. It is probable that, shortly after taking his M.A. (1577), he began at Oxford the first public lectures in geography that "shewed both the old imperfectly composed and the new lately reformed mappes, globes, spheres, and other instruments of this art." That this was not in London is certain, as we know that the first lecture of the kind was delivered in the metropolis on the 4th of November 1588 by Thomas Hood.

Hakluys's first published work was his *Divers Voyages touching*

the Discoverie of America (London, 1582, 4to.). This brought him to the notice of Lord Howard of Effingham, and so to that of Sir Edward Stafford, Lord Howard's brother-in-law; accordingly at the age of thirty, being acquainted with "the chiefest captaines at sea, the greatest merchants, and the best mariners of our nation," he was selected as chaplain to accompany Stafford, now English ambassador at the French court, to Paris (1583). In accordance with the instructions of Secretary Walsingham, he occupied himself chiefly in collecting information of the Spanish and French movements, and "making diligent inquirie of such things as might yield any light unto our westerne discoverie in America." The first-fruits of Hakluys's labours in Paris are embodied in his important work entitled *A particular discourse concerning Westerne discoveries written in the yere 1584, by Richard Hakluys of Oxforde, at the requeste and direction of the righte worshipfull Mr Walter Rughly before the comynage home of his twoo barkes*. This long-lost MS. was at last printed in 1877. Its object was to recommend the enterprise of planting the English race in the unsettled parts of North America. Hakluys's other works consist mainly of translations and compilations, relieved by his dedications and prefaces, which last, with a few letters, are the only material we possess out of which a biography of him can be framed. Hakluys revisited England in 1584, laid before Queen Elizabeth a copy of the *Discourse* "along with one in Latin upon Aristotle's *Politicks*," and obtained, two days before his return to Paris, the grant of the next vacant prebend at Bristol, to which he was admitted in 1586 and held with his other preferments till his death.

While in Paris Hakluys interested himself in the publication of the MS. journal of Laudonnière, the *Histoire notable de la Floride*, edited by Bassanier (Paris, 1586, 8vo.). This was translated by Hakluys and published in London under the title of *A notable historie containing lowe voyages made by certayn French captaynes into Florida* (London, 1587, 4to.). The same year *De orbe novo Petri Martyris Anglerii decades octo illustratae labore et industria Richardi Hakluysii* saw the light at Paris. This work contains the exceedingly rare copperplate map dedicated to Hakluys and signed F. G. (supposed to be Francis Gualle); it is the first on which the name of "Virginia" appears.

In 1588 Hakluys finally returned to England with Lady Stafford, after a residence in France of nearly five years. In 1589 he published the first edition of his chief work, *The Principall Navigations, Voyages and Discoveries of the English Nation* (fol., London, 1 vol.). In the preface to this we have the announcement of the intended publication of the first terrestrial globe made in England by Molyneux. In 1598-1600 appeared the final, reconstructed and greatly enlarged edition of *The Principall Navigations, Voyages, Traffiques and Discoveries of the English Nation* (fol., 3 vols.). Some few copies contain an exceedingly rare map, the first on the Mercator projection made in England according to the true principles laid down by Edward Wright. Hakluys's great collection, though but little read, has been truly called the "prose epic of the modern English nation." It is an invaluable treasure of material for the history of geographical discovery and colonization, which has secured for its editor a lasting reputation. In 1601 Hakluys edited a translation from the Portuguese of Antonio Galvano, *The Discoverie of the World* (4to., London). In the same year his name occurs as an adviser to the East India Company, supplying them with maps, and informing them as to markets. Meantime in 1599 (April 30th) he had been instituted to the rectory of Witheringsett-cum-Brockford, Suffolk. In 1602, on the 4th of May, he was installed prebendary of Westminster, and in the following year he was elected archdeacon of Westminster. In the licence of his second marriage (30th of March 1604) he is also described as one of the chaplains of the Savoy, and his will contains a reference to chambers occupied by him there up to the time of his death; in another official document he is styled D.D. In 1605 he secured the prospective living of James Town, the intended capital of the intended colony of Virginia. This benefice he supplied, when the colony was at last established in 1607, by a curate, one Robert Hunt. In 1606 he appears as one

of the chief promoters of the petition to the king for patents to colonize Virginia. He was also a leading adventurer in the London or South Virginia Company. His last publication was a translation of Fernando de Soto's discoveries in Florida, entitled *Virginia richly valued by the description of Florida her next neighbor* (London, 1609, 4to). This work was intended to encourage the young colony of Virginia; to Hakluyt, it has been said, "England is more indebted for its American possession than to any man of that age." We may notice that it was at Hakluyt's suggestion that Robert Parke translated Mendoza's *History of China* (London, 1588-589) and John Pory made his version of *Leo Africanus* (*A Geographical History of Africa*, London, 1600). Hakluyt died in 1616 (November 23rd) and was buried in Westminster Abbey (November 26th); by an error in the abbey register his burial is recorded under the year 1626. Out of his various emoluments and preferments (of which the last was Godney rectory, Lincolnshire, in 1612) he amassed a small fortune, which was squandered by a son. A number of his MSS., sufficient to form a fourth volume of his collections of 1598-1600, fell into the hands of Samuel Purchas, who inserted them in an abridged form in his *Pilgrimes* (1625-1626, fol.). Others are preserved at Oxford (Bib. Bod. MS. Seld. B. 8), which consist chiefly of notes gathered from contemporary authors.

Besides the MSS. or editions noticed in the text (*Divers Voyages* (1582); *Particular Discourse* (1584); Laudonniere's *Florida* (1587); Peter Martyr, *Decades* (1587); *Principal Navigations* (1589 and 1598-1600); Galvano's *Discoveries* (1601); De Soto's Florida record, the *Virginia richly valued* (1609, &c.), we may notice the Hakluyt Society's London edition of the *Divers Voyages* in 1850, the edition of the *Particular Discourse*, by Charles Deane in the *Collections of the Maine Historical Society* (Cambridge, Mass., 1870, with an introduction by Leonard Woods); also, among modern issues of the *Principal Navigations*, those of 1809 (5 vols., with much additional matter), and of 1903-1905 (Glasgow, 12 vols.). The new title-pages issued for the first volume of the final edition of the *Principal Navigations*, in 1599, merely cancelled the former 1598 title with its reference to the Cadiz expedition of 1596; but from this has arisen the mistaken supposition that a new edition was then (1599) published. Hakluyt's Galvano was edited for the Hakluyt Society by Admiral C. R. D. Bethune in 1862. This Society, which was founded in 1846 for printing rare and unpublished voyages and travels, includes the Glasgow edition of the *Principal Navigations* in its extra series, as well as C. R. Beazley's edition of *Carpini, Rubruquis*, and other medieval texts from Hakluyt (Cambridge, 1903, 1 vol.). Reckoning in these and an issue of Purchas's *Pilgrimes* by the Glasgow publisher of the Hakluyt of 1903-1905, the society has now published or "fathered" 150 vols. See also *Voyages of the Elizabethan Seamen to America, being Select Narratives from the Principal Navigations*, by E. J. Payne (Oxford, 1880; 1893; new edition by C. R. Beazley, 1907).

For Hakluyt's life the dedications of the 1599 and 1598 editions of the *Principal Navigations* should be especially consulted; also Winter Jones's introduction to the Hakluyt Society edition of the *Divers Voyages*; Fuller's *Worthies of England*, "Herefordshire"; *Oxford Univ. Reg.* (Oxford Hist. Soc.) II, iii, 39; *Historical MSS. Commission, 4th report, appendix*, p. 614, the last giving us the Towneley MSS. referring to payments (prizes?) awarded to Hakluyt when at Oxford, May 12th and June 4th, 1575. (C. H. C.; C. R. B.)

HAKODATE, a town on the south of the island of Yezo, Japan, for many years regarded as the capital of the island until Sapporo was officially raised to that rank. Pop. (1903) 84,746. Its position, as has been frequently remarked, is not unlike that of Gibraltar, as the town is built along the north-western base of a rocky promontory (1157 ft. in height) which forms the eastern boundary of a spacious bay, and is united to the mainland by a narrow sandy isthmus. The summit of the rock, called the Peak, is crowned by a fort. Hakodate is one of the ports originally opened to foreign trade. The Bay of Hakodate, an inlet of Tsugaru Strait, is completely land-locked, easy of access and spacious, with deep water almost up to the shore, and good holding-ground. The Russians formerly used Hakodate as a winter port. The staple exports are beans, pulse and peas, marine products, sulphur, furs and timber; the staple imports, comestibles (especially salted fish), kerosene and oil-cake. The town is not situated so as to profit largely by the development of the resources of Yezo, and as a port of foreign trade its outlook is indifferent. Frequent steamers connect Hakodate and Yokohama and other ports, and there is daily communication with Aomori, 56 m. distant, whence there is rail-connection with

Tokyo. Hakodate was opened to American commerce in 1854. In the civil war of 1868 the town was taken by the rebel fleet, but it was recovered by the mikado in 1869.

HALL, a town of Brabant, Belgium, about 9 m. S.W. of Brussels, situated on the river Senne and the Charleroi canal. Pop. (1904) 13,541. The place is interesting chiefly on account of its fine church of Notre Dame, formerly dedicated to St. Martin. This church, a good example of pure Gothic, was begun in 1341 and finished in 1409. Its principal ornament is the alabaster altar, by J. Mose, completed in 1533. The bronze font dates from 1446. Among the monuments is one in black marble to the dauphin Joachim, son of Louis XL, who died in 1460. In the treasury of the church are many costly objects presented by illustrious personages, among others by the emperor Charles V., King Henry VIII. of England, Charles the Bold of Burgundy, and several popes. The church is chiefly celebrated, however, for its miraculous image of the Virgin. Legend says that during a siege the bullets fired into the town were caught by her in the folds of her dress. Some of these are still shown in a chest that stands in a side chapel. In consequence of this belief a great pilgrimage, attended by many thousands from all parts of Belgium, is paid annually to this church. The hôtel de ville dates from 1616 and has been restored with more than ordinary good taste.

HALLA, or **HALLA** (formerly known as Murtazabad), a town of British India in Hyderabad district, Sind. Pop. (1901) 4985. It has long been famous for its glazed pottery and tiles, made from a fine clay obtained from the Indus, mixed with powdered flints. The town has also a manufacture of *susis* or striped trouser-cloths.

HALAESA, an ancient town on the north coast of Sicily, about 14 m. E. of Cephaloedium (Cefalu), to the east of the modern Castel di Tusa, founded in 403 B.C. by Archonides, tyrant of Herbita, whose name it sometimes bore: we find, e.g. *Halaesa Archonida* on a coin of the time of Augustus (*Corp. inscrip. Lat. x.*, Berlin, 1883, p. 768). It was the first town to surrender to the Romans in the First Punic War, and was granted freedom and immunity from tithe. It became a place of some importance in Roman days, especially as a port, and entirely outstripped its mother city. Halaesa is the only place in Sicily where an inscription dedicated to a Roman governor of the republican period (perhaps in 93 B.C.) has come to light. (T. A. S.)

HALAKHA, or **HALACHA** (literally "rule of conduct"), the rabbinical development of the Mosaic law; with the haggada it makes up the Talmud and Midrash (*q.v.*). As the haggada is the poetic, so the halakha is the legal element of the Talmud (*q.v.*), and arose out of the faction between the Sadducees, who disputed the traditions, and the Pharisees, who strove to prove their derivation from scripture. Among the chief attempts to codify the halakha were the *Great Rules* (*Halakhoth Gedoloth*) of Simon Kayyara (5th century), based on the letters written by the Gaonim, the heads of the Babylonian schools, to Jewish inquirers in many lands, the work of Jacob Alfassi (1013-1103), the *Strong Hand* of Maimonides (1180), and the *Table Prepared* (*Shulhan Aruch*) of Joseph Caro (1565), which from its practical scope and its clarity as a work of general reference became the universal handbook of Jewish life in many of its phases. (I. A.)

HALBERSTADT, a town of Germany, in the Prussian province of Saxony, 56 m. by rail N.W. of Halle, and 29 S.W. of Magdeburg. It lies in a fertile country to the north of the Harz Mountains, on the Holzemme, at the junction of railways to Halle, Goslar and Thale. Pop. (1905) 43,534. The town has a mediæval appearance, many old houses decorated with beautiful wood-carving still surviving. The Gothic cathedral (now Protestant), dating from the 13th and 14th centuries, is remarkable for the majestic impression made by the great height of the interior, with its slender columns and lofty, narrow aisles. The treasure, preserved in the former chapter-house, is rich in reliquaries, vestments and other objects of mediæval church art. The beautiful spires, which had become unsafe, were rebuilt in 1890-1895. Among the other churches the only one of special interest is the Liebfrauenkirche (Church of Our Lady).

a basilica, with four towers, in the later Romanesque style, dating from the 12th and 13th centuries and restored in 1848, containing old mural frescoes and carved figures. Remarkable among the other old buildings are the town-hall, of the 14th century and restored in the 17th century, with a crypt, and the Petershof, formerly the episcopal palace, but now utilized as law courts and a prison. The principal educational establishment is the gymnasium, with a library of 40,000 volumes. Close to the cathedral lies the house of the poet Gleim (q.v.), since 1809 the property of the municipality and converted into a museum. It contains a collection of the portraits of the friends of the poet-scholar and some valuable manuscripts. The principal manufactures of the town are sugar, cigars, paper, gloves, chemical products, beer and machinery. About a mile and a half distant are the Spiegelsberge, from which a fine view of the surrounding country is obtained, and the Klusberge, with prehistoric cave-dwellings cut out in the sandstone rocks.

The history of Halberstadt begins with the transfer to it, by Bishop Hildegrim I., in 820 of the see founded by Charlemagne at Seligenstadt. At the end of the 10th century the bishops were granted by the emperors the right to exercise temporal jurisdiction over their see, which became one of the most considerable of the ecclesiastical principalities of the Empire. As such it survived the introduction of the Reformation in 1542; but in 1566, on the death of Sigismund of Brandenburg (also archbishop of Magdeburg from 1552 to 1566), the last Catholic bishop, the chapter from motives of economy elected the infant Henry Julius of Brunswick-Lüneburg. In 1580 he became duke of Brunswick, and two years later he abolished the Catholic rites in Halberstadt. The see was governed by lay bishops until 1648, when it was formally converted by the treaty of Westphalia into a secular principality for the elector of Brandenburg. By the treaty of Tilist in 1807 it was annexed to the kingdom of Westphalia, but came again to Prussia on the downfall of Napoleon.

The town received a charter from Bishop Arnulf in 998. In 1113 it was burnt by the emperor Henry V., and in 1179 by Henry the Lion. During the Thirty Years' War it was occupied alternately by the Imperialists and the Swedes, the latter of whom handed it over to Brandenburg.

See Lucanus, *Der Dom zu Halberstadt* (1837); *Wegweiser durch Halberstadt* (2nd ed., 1866) and *Die Liebfrauenkirche zu Halberstadt* (1872); Scheffer, *Inskriften und Legenden halberstädtischer Bauten* (1864); Schmidt, *Urkundenbuch der Stadt Halberstadt* (Halle, 1878); and *Zechische, Halberstadt, sonst und jetzt* (1882).

HALBERT, HALBERD or HALBARD, a weapon consisting of an axe-blade balanced by a pick and having an elongated pike-head at the end of the staff, which was usually about 5 or 6 ft. in length. The utility of such a weapon in the wars of the later middle ages lay in this, that it gave the foot soldier the means of dealing with an armoured man on horseback. The pike could do no more than keep the horseman at a distance. This ensured security for the foot soldier but did not enable him to strike a mortal blow, for which firstly a long-handled and secondly a powerful weapon, capable of striking a heavy cleaving blow, was required. Several different forms of weapon responding to these requirements are described and illustrated below; it will be noticed that the thrusting pike is almost always combined with the cutting-bill hook or axe-head, so that the individual billman or halberdier should not be at a disadvantage if caught alone by a mounted opponent, or if his first descending blow missed its object. It will be noticed further that, concurrently with the disease of complete armour and the development of firearms, the pike or thrusting element gradually displaces the axe or cleaving element in these weapons, till at last we arrive at the court halberds and partizans of the late 16th and early 17th centuries and the so-called "halbert" of the infantry officer and sergeant in the 18th, which can scarcely be classed even as partizans.

Figs. 1-6 represent types of these long cutting, cut and thrust weapons of the middle ages, details being omitted for the sake of clearness. The most primitive is the *swaige* (fig. 1), which is simply a heavy cleaver on a pole, with a point added. The next form, the *gisarme* or *guisarme* (fig. 2), appears in infinite variety but is always distinguished from vouleges, &c. by the hook, which was used to pull down mounted men, and generally resembles the agricultural bill-hook of to-day. The *glaise* (fig. 3 is late German) is a broad, heavy, slightly curved sword-

blade on a staff; it is often combined with the hooked gisarme as a *glaise-gisarme* (fig. 4, Burgundian, about 1480). A *gisarme-soude* is shown in fig. 5 (Swiss, 14th century).

The weapon best known to Englishmen is the *bill*, which was originally a sort of scythe-blade, sharp on the concave side (whereas the glaive has the cutting edge on the convex side), but in its best-known form it should be called a bill-gisarme (fig. 6). The *partizans*, *ranseurs* and *halberts* proper developed naturally from the earlier types. The feature common to all, as has been said, is the combination of spear and axe. In the halberts the axe predominates, as the examples (fig. 10, Swiss, early 15th century; fig. 11, Swiss, middle 16th century; and fig. 12, German court halbert of the same period as fig. 11) show. In the *partizan* the pike is the more important, the axe-heads being reduced to little more than an ornamental feature. A south German specimen (fig. 9, 1625) shows how this was compensated by the broadening of the spear-head, the edges of which in such weapons were sharpened. Fig. 8, a service weapon of simple form, merely has projections on either side, and from this developed the *ranseur* (fig. 7), a partizan with a very long and narrow point, like the blade of a rapier, and with fork-like projections intended to act as "sword-breakers," instead of the atrophied axe-heads of the partizan proper.

The halbert played almost as conspicuous a part in the military history of Middle Europe during the 15th and early 16th centuries as the pike. But, even in a form distinguishable from the voulege and the glaive, it dates from the early part of the 13th century, and for many generations thereafter it was the special weapon of the Swiss. Fauchet, in his *Origines des dignitez*, printed in 1600, states that Louis XI. of France ordered certain new weapons of war called *hallebardes* to be made at Angers and other places in 1475. The Swiss had a mixed armament of pikes and halberds at the battle of Morat in 1476. In the 15th and 16th centuries the halberds became larger, and the blades were formed in many varieties of shape, often engraved, inlaid, or pierced in open work, and exquisitely finished as works of art. This weapon was in use in England from the reign of Henry VII. to the reign of George III., when it was still carried (though in shape it had certainly lost its original characteristics, and had become half partizan and half pike) by sergeants in the guards and other infantry regiments. It is still retained as the symbol of authority borne before the magistrates on public occasions in some of the burghs of Scotland. The Lochaber axe may be called a species of halbert furnished with a hook on the end of the staff at the back of the blade. The *godendag* (Fr. *godendard*) is the Flemish name of the halbert in its original form.

The derivation of the word is as follows. The O. Fr. *hallebarde*, of which the English "halberd," "halbert," is an adaptation, was itself adapted from the M.H.G. *helmbarde*, mod. *Hallebarde*; the second part is the O.H.G. *baris* or *paris*, broad-axe, probably the same word as *Baris*, beard, and so called from its shape; the first part is either *helm*, handle, cf. "helm," tiller of a ship, the word meaning "hafted axe," or else *helm*, helmet, an axe for smiting the helmet. A common derivation was to take the word as representing a Ger. *halb-barde*, half-axe; the early German form shows this to be an erroneous guess.

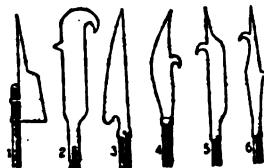

FIGS. 1-6.

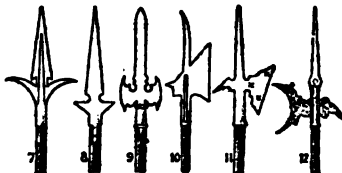

FIGS. 7-12.

HALDANE, JAMES ALEXANDER (1768-1851), Scottish divine, the younger son of Captain James Haldane of Airthrey House, Stirlingshire, was born at Dundee on the 14th of July 1768. Educated first at Dundee and afterwards at the high school and university of Edinburgh, at the age of seventeen he joined the "Duke of Montrose" East Indiaman as a midshipman. After four voyages to India he was nominated to the command of the "Melville Castle" in the summer of 1793; but having during a long and unexpected detention of his ship begun a careful study of the Bible, and also come under the evangelical influence of David Bogue of Gosport, one of the founders of the London Missionary Society, he abruptly resolved to quit the naval profession for a religious life, and returned to Scotland before his ship had sailed. About the year 1796 he became acquainted with the celebrated evangelical divine, Charles Simeon of Cambridge, in whose society he made several tours through Scotland, endeavouring by tract-distribution and other means to awaken others to some of that interest in religious subjects which he himself so strongly felt. In May 1797 he preached his first sermon, at Gilmerton near Edinburgh, with encouraging success. In the same year he established a non-sectarian organization for tract distribution and lay preaching called the "Society for the Propagation of the Gospel at Home." During the next few years he made repeated missionary journeys, preaching wherever he could obtain hearers, and generally in the open air. Not originally disloyal to the Church of Scotland, he was gradually driven by the hostility of the Assembly and the exigencies of his position into separation. In 1799 he was ordained as pastor of a large Independent congregation in Edinburgh. This was the first congregational church known by that name in Scotland. In 1801 a permanent building replaced the circus in which the congregation had at first met. To this church he continued to minister gratuitously for more than fifty years. In 1808 he made public avowal of his conversion to Baptist views. As advancing years compelled him to withdraw from the more exhausting labours of itineracy and open-air preaching, he sought more and more to influence the discussion of current religious and theological questions by means of the press. He died on the 8th of February 1851.

His son, **DANIEL RUTHERFORD HALDANE** (1824-1887), by his second wife, a daughter of Professor Daniel Rutherford, was a prominent Scottish physician, who became president of the Edinburgh College of Physicians.

Among J. A. Haldane's numerous contributions to current theological discussions were: *The Duty of Christian Forbearance in Regard to Points of Church Order* (1811); *Strictures on a Publication upon Primitive Christianity by Mr John Walker* (1819); *Refutation of Edward Irving's Heretical Doctrines respecting the Person and Atonement of Jesus Christ*. His *Observations on Universal Pardon, &c.*, was a contribution to the controversy regarding the views of Thomas Erskine of Linlathen and Campbell of Row; *Man's Responsibility* (1842) is a reply to Howard Hinton on the nature and extent of the Atonement. He also published: *Journal of a Tour in the North; Early Instruction Commended* (1801); *Views of the Social Worship of the First Churches* (1805); *The Doctrine and Duty of Self-Examination* (1806); *The Doctrine of the Atonement* (1845); *Exposition of the Epistle to the Galatians* (1848).

HALDANE, RICHARD BURDON (1856-), British statesman and philosopher, was the third son of Robert Haldane of Cloanden, Perthshire, a writer to the signet, and nephew of J. S. Burdon-Sanderson. He was a grand-nephew of the Scottish divines J. A. and Robert Haldane. He was educated at Edinburgh Academy and the universities of Edinburgh and Göttingen, where he studied philosophy under Lotze. He took first-class honours in philosophy at Edinburgh, and was Gray scholar and Ferguson scholar in philosophy of the four Scottish Universities (1876). He was called to the bar in 1879, and so early as 1890 became a queen's counsel. In 1885 he entered parliament as liberal member for Haddingtonshire, for which he was re-elected continuously up to and including 1910. He was included in 1905 in Sir H. Campbell-Bannerman's cabinet as secretary for war, and was the author of the important scheme for the re-organization of the British army, by which the militia and the volunteer forces were replaced by a single territorial force.

Though always known as one of the ablest men of the Liberal party and conspicuous during the Boer War of 1899-1902 as a Liberal Imperialist, the choice of Mr Haldane for the task of thinking out a new army organization on business lines had struck many people as curious. Besides being a chancery lawyer, he was more particularly a philosopher, conspicuous for his knowledge of Hegelian metaphysics. But with German philosophy he had also the German sense of thoroughness and system, and his scheme, while it was much criticized, was recognized as the best that could be done with a voluntary army. Mr Haldane's chief literary publications were: *Life of Adam Smith* (1887); *Education and Empire* (1902); *The Pathway to Reality* (1903). He also translated, jointly with J. Kemp, Schopenhauer's *Die Welt als Wille und Vorstellung* (*The World as Will and Idea*, 3 vols., 1883-1886).

HALDANE, ROBERT (1764-1842), Scottish divine, elder brother of J. A. Haldane (q.v.), was born in London on the 28th of February 1764. After attending classes in the Dundee grammar school and in the high school and university of Edinburgh in 1780, he joined H.M.S. "Monarch," of which his uncle Lord Duncan was at that time in command, and in the following year was transferred to the "Foudroyant," on board of which, during the night engagement with the "Pégase," he greatly distinguished himself. Haldane was afterwards present at the relief of Gibraltar, but at the peace of 1783 he finally left the navy, and soon afterwards settled on his estate of Airthrey, near Stirling. He put himself under the tuition of David Bogue of Gosport and carried away deep impressions from his academy. The earlier phases of the French Revolution excited his deepest sympathy, a sympathy which induced him to avow his strong disapproval of the war with France. As his over-sanguine visions of a new order of things to be ushered in by political change disappeared, he began to direct his thoughts to religious subjects. Resolving to devote himself and his means wholly to the advancement of Christianity, his first proposal for that end, made in 1796, was to organize a vast mission to Bengal, of which he was to provide the entire expense; with this view the greater part of his estate was sold, but the East India Company refused to sanction the scheme, which therefore had to be abandoned. In December 1797 he joined his brother and some others in the formation of the "Society for the Propagation of the Gospel at Home," in building chapels or "tabernacles" for congregations, in supporting missionaries, and in maintaining institutions for the education of young men to carry on the work of evangelization. He is said to have spent more than £70,000 in the course of the following twelve years (1798-1810). He also initiated a plan for evangelizing Africa by bringing over native children to be trained as Christian teachers to their own countrymen. In 1816 he visited the continent, and first at Geneva and afterwards in Montauban (1817) he lectured and interviewed large numbers of theological students with remarkable effect; among them were Malan, Monod and Merle d'Aubigné. Returning to Scotland in 1819, he lived partly on his estate of Auchengray and partly in Edinburgh, and like his brother took an active part, chiefly through the press, in many of the religious controversies of the time. He died on the 12th of December 1842.

In 1816 he published a work on the *Evidences and Authority of Divine Revelation*, and in 1819 the substance of his theological prelections in a *Commentaire sur l'Épître aux Romains*. Among his later writings, besides numerous pamphlets on what was known as "the Apocrypha controversy," are a treatise *On the Inspiration of Scripture* (1828), which has passed through many editions, and a later *Exposition of the Epistle to the Romans* (1835), which has been frequently reprinted, and has been translated into French and German.

See *Memoirs of R. and J. A. Haldane*, by Alexander Haldane (1852).

HALDEMAN, SAMUEL STEHMAN (1812-1880), American naturalist and philologist, was born on the 12th of August 1812 at Locust Grove, Pa. He was educated at Dickinson College, and in 1831 was appointed professor of the natural sciences in the university of Pennsylvania. In 1855 he went to Delaware College, where he filled the same position, but in 1869 he returned to the university of Pennsylvania as professor of

comparative philology and remained there till his death, which occurred at Chickies, Pa., on the 10th of September 1880. His writings include *Freshwater Univalve Mollusca of the United States* (1840); *Zoological Contributions* (1842-1843); *Analytic Orthography* (1860); *Tours of a Chess Knight* (1864); *Pennsylvania Dutch, a Dialect of South German with an Infusion of English* (1872); *Outlines of Etymology* (1877); and *Word-Building* (1881).

HALDIMAND, SIR FREDERICK (1718-1791), British general and administrator, was born at Yverdon, Neuchâtel, Switzerland, on the 11th of August 1718, of Huguenot descent. After serving in the armies of Sardinia, Russia and Holland, he entered British service in 1754, and subsequently naturalized as an English citizen. During the Seven Years' War he served in America, was wounded at Ticonderoga (1758) and was present at the taking of Montreal (1760). After filling with credit several administrative positions in Canada, Florida and New York, in 1778 he succeeded Sir Guy Carleton (afterwards Lord Dorchester) as governor-general of Canada. His measures against French sympathizers with the Americans have incurred extravagant strictures from French-Canadian historians, but he really showed moderation as well as energy. In 1785 he returned to London. He died at his birthplace on the 5th of June 1791.

His life has been well written by Jean McIlwraith in the "Makers of Canada" series (Toronto, 1904). His Correspondence and Diary fill 262 volumes in the Canadian Archives, and are catalogued in the Annual Reports (1884-1889).

HALE, EDWARD EVERETT (1822-1909), American author, was born in Boston on the 3rd of April 1822, son of Nathan Hale (1784-1863), proprietor and editor of the Boston *Daily Advertiser*, nephew of Edward Everett, the orator and statesman, and grand-nephew of Nathan Hale, the martyr spy. He graduated from Harvard in 1839; was pastor of the church of the Unity, Worcester, Massachusetts, in 1846-1856, and of the South Congregational (Unitarian) church, Boston, in 1856-1899; and in 1903 became chaplain of the United States Senate. He died at Roxbury (Boston), Massachusetts, on the 10th of June 1909. His forceful personality, organizing genius, and liberal practical theology, together with his deep interest in the anti-slavery movement (especially in Kansas), popular education (especially Chautauqua work), and the working-man's home, were active in raising the tone of American life for half a century. He was a constant and voluminous contributor to the newspapers and magazines. He was an assistant editor of the Boston *Daily Advertiser*, and edited the *Christian Examiner, Old and New* (which he assisted in founding in 1869; in 1875 it was merged in *Scribner's Magazine*), *Lend a Hand* (founded by him in 1886 and merged in the *Charities Review* in 1897), and the *Lend a Hand Record*; and he was the author or editor of more than sixty books—fiction, travel, sermons, biography and history.

He first came into notice as a writer in 1859, when he contributed the short story "My Double and How He Undid Me" to the *Atlantic Monthly*. He soon published in the same periodical other stories, the best known of which was "The Man Without a Country" (1863), which did much to strengthen the Union cause in the North, and in which, as in some of his other non-romantic tales, he employed a minute realism which has led his readers to suppose the narrative a record of fact. The two stories mentioned, and such others as "The Rag-Man and the Rag-Woman" and "The Skeleton in the Closet," gave him a prominent position among the short-story writers of America. The story *Ten Times One is Ten* (1870), with its hero Harry Wadsworth, and its motto, first enunciated in 1869 in his Lowell Institute lectures, "Look up and not down, look forward and not back, look out and not in, and lend a hand," led to the formation among young people of "Lend-a-Hand Clubs," "Look-up Legions" and "Harry Wadsworth Clubs." Out of the romantic Waldensian story *In His Name* (1873) there similarly grew several other organizations for religious work, such as "King's Daughters," and "King's Sons."

Among his other books are *Kansas and Nebraska* (1854); *The Ingham Papers* (1869); *His Last Best, and Other Stories* (1870);

Sybaris and Other Homes (1871); *Philip Nolan's Friends* (1876), his best-known novel, and a sequel to *The Man Without a Country: The Kingdom of God* (1880); *Christmas at Narragansett* (1885); *East and West*, a novel (1892); *For Fifty Years* (poems, 1893); *Ralph Waldo Emerson* (1899); *We, the People* (1902); *Prayers Offered in the Senate of the United States* (1904), and *Tarry-at-Home Travels* (1906). He edited Lingard's *History of England* (1853), and contributed to Winsor's *Memorial History of Boston* (1880-1881), and to his *Narrative and Critical History of America* (1886-1890). With his son, Edward Everett Hale, Jr., he published *Franklin in France* (2 vols., 1887-1888), based largely on original research. The most charming books of his later years were *A New England Boyhood* (1893), *James Russell Lowell and His Friends* (1899), and *Memories of a Hundred Years* (1902).

A uniform and revised edition of his principal writings, in ten volumes, appeared in 1899-1901.

HALE, HORATIO (1817-1896), American ethnologist, was born in Newport, New Hampshire, on the 3rd of May 1817. He was the son of David Hale, a lawyer, and of Sarah Josepha Hale (1790-1879), a popular poet, who, besides editing *Godey's Lady's Magazine* for many years and publishing some ephemeral books, is supposed to have written the verses "Mary had a little lamb," and to have been the first to suggest the national observance of Thanksgiving Day. The son graduated in 1837 at Harvard, and during 1838-1842 was philologist to the United States Exploring Expedition, which under Captain Charles Wilkes sailed around the world. Of the reports of that expedition Hale prepared the sixth volume, *Ethnography and Philology* (1846), which is said to have "laid the foundations of the ethnography of Polynesia." He was admitted to the Chicago bar in 1855, and in the following year removed to Clinton, Ontario, Canada, where he practised his profession, and where on the 28th of December 1896 he died. He made many valuable contributions to the science of ethnology, attracting attention particularly by his theory of the origin of the diversities of human languages and dialects—a theory suggested by his study of "child-languages," or the languages invented by little children. He also emphasized the importance of languages as tests of mental capacity and as "criteria for the classification of human groups." He was, moreover, the first to discover that the Tutelos of Virginia belonged to the Siouan family, and to identify the Cherokee as a member of the Iroquoian family of speech. Besides writing numerous magazine articles, he read a number of valuable papers before learned societies. These include: *Indian Migrations as Evidenced by Language* (1882); *The Origin of Languages and the Antiquity of Speaking Man* (1886); *The Development of Language* (1888); and *Language as a Test of Mental Capacity: Being an Attempt to Demonstrate the True Basis of Anthropology* (1891). He also edited for Brinton's "Library of Aboriginal Literature," the *Iroquois Book of Rites* (1883).

HALE, JOHN PARKER (1806-1873), American statesman, was born at Rochester, New Hampshire, on the 31st of March 1806. He graduated at Bowdoin College in 1827, was admitted to the New Hampshire bar in 1830, was a member of the state House of Representatives in 1832, and from 1834 to 1841 was United States district attorney for New Hampshire. In 1843-1845 he was a Democratic member of the national House of Representatives, and, though his earnest co-operation with John Quincy Adams in securing the repeal of the "gag rule" directed against the presentation to Congress of anti-slavery petitions estranged him from the leaders of his party, he was renominated without opposition. In January 1845, however, he refused in a public statement to obey a resolution (28th of December 1844) of the state legislature directing him and his New Hampshire associates in Congress to support the cause of the annexation of Texas, a Democratic measure which Hale regarded as being distinctively in the interest of slavery. The Democratic State convention was at once reassembled, Hale was denounced, and his nomination withdrawn. In the election which followed Hale ran independently, and, although the Democratic candidates were elected in the other three congressional districts of the state, his vote was large enough to prevent any choice (for which a majority was necessary) in his own. Hale then set out in the face of apparently hopeless odds to win over his state to the anti-slavery cause. The remarkable canvass which he conducted

is known in the history of New Hampshire as the "Hale Storm of 1845." The election resulted in the choice of a legislature controlled by the Whigs and the independent Democrats, he himself being chosen as a member of the state House of Representatives, of which in 1846 he was speaker. He is remembered, however, chiefly for his long service in the United States Senate, of which he was a member from 1847 to 1853 and again from 1855 to 1865. At first he was the only out-and-out anti-slavery senator,—he alone prevented the vote of thanks to General Taylor and General Scott for their Mexican war victories from being made unanimous in the Senate (February 1848)—but in 1849 Salmon P. Chase and William H. Seward, and in 1851 Charles Sumner joined him, and the anti-slavery cause became for the first time a force to be reckoned with in that body. In October 1847 he had been nominated for president by the Liberty party, but he withdrew in favour of Martin Van Buren, the Free Soil candidate, in 1848. In 1851 he was senior counsel for the rescuers of the slave Shadrach in Boston. In 1852 he was the Free Soil candidate for the presidency, but received only 156,149 votes. In 1850 he secured the abolition of flogging in the U.S. navy, and through his efforts in 1862 the spirit ration in the navy was abolished. He was one of the organizers of the Republican party, and during the Civil War was an eloquent supporter of the Union and chairman of the Senate naval committee. From 1865 to 1869 he was United States minister to Spain. He died at Dover, New Hampshire, on the 19th of December 1873. A statue of Hale, presented by his son-in-law William Eaton Chandler (b. 1835), U.S. senator from New Hampshire in 1887-1901, was erected in front of the Capitol in Concord, New Hampshire, in 1892.

HALE, SIR MATTHEW (1609-1676), lord chief justice of England, was born on the 1st of November 1609 at Alderley in Gloucestershire, where his father, a retired barrister, had a small estate. His paternal grandfather was a rich clothier of Wotton-under-Edge; on his mother's side he was connected with the noble family of the Poyntzes of Acton. Left an orphan when five years old, he was placed by his guardian under the care of the Puritan vicar of Wotton-under-Edge, with whom he remained till he attained his sixteenth year, when he entered Magdalen Hall, Oxford. At Oxford, Hale studied for several terms with a view to holy orders, but suddenly there came a change. The diligent student, at first attracted by a company of strolling players, threw aside his studies, and plunged carelessly into gay society. He soon decided to change his profession; and resolved to trail a pike as a soldier under the prince of Orange in the Low Countries. Before going abroad, however, Hale found himself obliged to proceed to London in order to give instructions for his defence in a legal action which threatened to deprive him of his patrimony. His leading counsel was the celebrated Serjeant Glanville (1586-1661), who, perceiving in the acuteness and sagacity of his youthful client a peculiar fitness for the legal profession, succeeded, with much difficulty, in inducing him to renounce his military for a legal career, and on the 8th of November 1629 Hale became a member of the honourable society of Lincoln's Inn.

He immediately resumed his habits of intense application. The rules which he laid down for himself, and which are still extant in his handwriting, prescribe sixteen hours a day of close application, and prove, not only the great mental power, but also the extraordinary physical strength he must have possessed, and for which indeed, during his residence at the university, he had been remarkable. During the period allotted to his preliminary studies, he read over and over again all the year-books, reports, and law treatises in print, and at the Tower of London and other antiquarian repositories examined and carefully studied the records from the foundation of the English monarchy down to his own time. But Hale did not confine himself to law. He dedicated no small portion of his time to the study of pure mathematics, to investigations in physics and chemistry, and even to anatomy and architecture; and there can be no doubt that this varied learning enhanced considerably the value of many of his judicial decisions.

Hale was called to the bar in 1637, and almost at once found himself in full practice. Though neither a fluent speaker nor bold pleader, in a very few years he was at the head of his profession. He entered public life at perhaps the most critical period of English history. Two parties were contending in the state, and their obstinacy could not fail to produce a most direful collision. But amidst the confusion Hale steered a middle course, rising in reputation, and an object of solicitation from both parties. Taking Pomponius Atticus as his political model, he was persuaded that a man, a lawyer and a judge could best serve his country and benefit his countrymen by holding aloof from partisanship and its violent prejudices, which are so apt to distort and confuse the judgment. But he is best vindicated from the charges of selfishness and cowardice by the thoughts and meditations contained in his private diaries and papers, where the purity and honour of his motives are clearly seen. It has been said, but without certainty, that Hale was engaged as counsel for the earl of Straford; he certainly acted for Archbishop Laud, Lord Maguire, Christopher Love, the duke of Hamilton and others. It is also said that he was ready to plead on the side of Charles I. had that monarch submitted to the court. The parliament having gained the ascendancy, Hale signed the Solemn League and Covenant, and was a member of the famous assembly of divines at Westminster in 1644; but although he would undoubtedly have preferred a Presbyterian form of church government, he had no serious objection to the system of modified Episcopacy proposed by Usher. Consistently with his desire to remain neutral, Hale took the engagement to the Commonwealth as he had done to the king, and in 1653, already serjeant, he became a judge in the court of common pleas. Two years afterwards he sat in Cromwell's parliament as one of the members for Gloucestershire. After the death of the protector, however, he declined to act as a judge under Richard Cromwell, although he represented Oxford in Richard's parliament. At the Restoration in 1660 Hale was very graciously received by Charles II., and in the same year was appointed chief baron of the exchequer, and accepted, with extreme reluctance, the honour of knighthood. After holding the office of chief baron for eleven years he was raised to the higher dignity of lord chief justice, which he held till February 1676, when his failing health compelled him to resign. He retired to his native Alderley, where he died on the 25th of December of the same year. He was twice married and survived all his ten children save two.

As a judge Sir Matthew Hale discharged his duties with resolute independence and careful diligence. His sincere piety made him the intimate friend of Isaac Barrow, Archbishop Tillotson, Bishop Wilkins and Bishop Stillingfleet, as well as of the Nonconformist leader, Richard Baxter. He is chargeable, however, with the condemnation and execution of two poor women tried before him for witchcraft in 1664, a kind of judicial murder then falling under disuse. He is also reproached with having hastened the execution of a soldier for whom he had reason to believe a pardon was preparing.

Of Hale's legal works the only two of importance are his *Historia placitorum coronarum*, or *History of the Pleas of the Crown* (1736); and the *History of the Common Law of England, with an Analysis of the Law*, &c. (1713). Among his numerous religious writings the *Contemplations, Moral and Divine*, occupy the first place. Others are *The Primitive Origin of Man* (1677); *Of the Nature of True Religion*, &c. (1684); *A Brief Abstract of the Christian Religion* (1688). One of his most popular works is the collection of *Letters of Advice to his Children and Grandchildren*. He also wrote an *Essay touching the Gravitation or Nongravitation of Fluid Bodies* (1673); *Difficiles Naves*, or *Observations touching the Torricellian Experiment*, &c. (1675); and a translation of the *Life of Pomponius Atticus*, by Cornelius Nepos (1677). His efforts in poetry were inauspicious. He left his valuable collection of MSS. and records to the library of Lincoln's Inn. His life has been written by G. Burnet (1682); by J. B. Williams (1835); by H. Roscoe, in his *Lives of Eminent Lawyers*, in 1838; by Lord Campbell, in his *Lives of the Chief Justices*, in 1849; and by E. Foss in his *Lives of the Judges* (1848-1870).

HALE, NATHAN (1756-1776), American hero of the War of Independence, was born at Coventry, Conn., and educated

at Yale, then becoming a school teacher. He joined a Connecticut regiment after the breaking out of the war, and served in the siege of Boston, being commissioned a captain at the opening of 1776. When Heath's brigade departed for New York he went with them, and the tradition is that he was one of a small and daring band who captured an English provision sloop from under the very guns of a man-of-war. But on the 21st of September, having volunteered to enter the British lines to obtain information concerning the enemy, he was captured in his disguise of a Dutch school-teacher and on the 22nd was hanged. The penalty was in accordance with military law, but young Hale's act was a brave one, and he has always been glorified as a martyr. Tradition attributes to him the saying that he only regretted that he had but one life to lose for his country; and it is said that his request for a Bible and the services of a minister was refused by his captors. There is a fine statue of Hale by Macmonnies in New York.

See H. P. Johnston, *Nathan Hale* (1901).

HALE, WILLIAM GARDNER (1849—), American classical scholar, was born on the 9th of February 1849 in Savannah, Georgia. He graduated at Harvard University in 1870, and took a post-graduate course in philosophy there in 1874-1876; studied classical philology at Leipzig and Göttingen in 1876-1877; was tutor in Latin at Harvard from 1877 to 1880, and professor of Latin in Cornell University from 1880 to 1892, when he became professor of Latin and head of the Latin department of the University of Chicago. From 1894 to 1899 he was chairman and in 1895-1896 first director of the American School of Classical Studies at Rome. He is best known as an original teacher on questions of syntax. In *The Cum-Constructions: Their History and Functions*, which appeared in *Cornell University Studies in Classical Philology* (1888-1889); and in German version by Neizert in 1891, he attacked Hoffmann's distinction between absolute and relative temporal clauses as published in *Latinische Zeitpartikeln* (1874); Hoffmann replied in 1891, and the best summary of the controversy is in Wetzel's *Der Streit zwischen Hoffmann und Hale* (1892). Hale wrote also *The Sequence of Tenses in Latin* (1887-1888), *The Anticipatory Subjunctive in Greek and Latin* (1894), and a *Latin Grammar* (1903), to which the parts on sounds, inflection and word-formation were contributed by Carl Darling Buck.

HALEBID, a village in Mysore state, southern India; pop. (1901), 1524. The name means "old capital," being the site of Dorasamudra, the capital of the Hoysala dynasty founded early in the 11th century. In 1310 and again in 1326 it was taken and plundered by the first Mahomedan invader of southern India. Two temples, still standing, though never completed and greatly ruined, are regarded as the finest examples of the elaborately carved Chalukyan style of architecture.

HALES, or HAYLES, JOHN (d. 1571), English writer and politician, was a son of Thomas Hales of Hales Place, Halden, Kent. He wrote his *Highway to Nobility* about 1543, and was the founder of a free school at Coventry for which he wrote *Introductiones ad grammaticam*. In political life Hales, who was member of parliament for Preston, was specially concerned with opposing the enclosure of land, being the most active of the commissioners appointed in 1548 to redress this evil; but he failed to carry several remedial measures through parliament. When the protector the duke of Somerset, was deprived of his authority in 1550, Hales left England and lived for some time at Strassburg and Frankfurt, returning to his own country on the accession of Elizabeth. However he soon lost the royal favour by writing a pamphlet, *A Declaration of the Succession of the Crowne Imperiall of Englande*, which declared that the recent marriage between Lady Catherine Grey and Edward Seymour, earl of Hertford, was legitimate, and asserted that, failing direct heirs to Elizabeth, the English crown should come to Lady Catherine as the descendant of Mary, daughter of Henry VII. The author was imprisoned, but was quickly released, and died on the 28th of December 1571. The *Discourse of the Common Weal*, described as "one of the most informing documents of the age," and written about 1549, has been attributed

to Hales. This has been edited by E. Lamond (Cambridge, 1893).

Hales is often confused with another John Hales, who was clerk of the hanaper under Henry VIII. and his three immediate successors.

HALES, JOHN (1584-1656), English scholar, frequently referred to as "the ever memorable," was born at Bath on the 19th of April 1584, and was educated at Corpus Christi College, Oxford. He was elected a fellow of Merton in 1605, and in 1612 he was appointed public lecturer on Greek. In 1613 he was made a fellow of Eton. Five years later he went to Holland, as chaplain to the English ambassador, Sir Dudley Carleton, who despatched him to Dort to report upon the proceedings of the synod then sitting. In 1619 he returned to Eton and spent his time among his books and in the company of literary men, among whom he was highly reputed for his common sense, his erudition and his genial charity. Andrew Marvell called him "one of the clearest heads and best-prepared breasts in Christendom." His eirenical tract entitled *Schism and Schismatics* (1636) fell into the hands of Archbishop Laud, and Hales, hearing that he had disapproved of it, is said to have written to the prelate a vindication of his position. This led to a meeting, and in 1639 Hales was made one of Laud's chaplains and also a canon of Windsor. In 1642 he was deprived of his canonry by the parliamentary committee, and two years later was obliged to hide in Eton with the college documents and keys. In 1649 he refused to take the "Engagement" and was ejected from his fellowship. He then retired to Buckinghamshire, where he found a home with Mrs Salter, the sister of the bishop of Salisbury (Brian Duppa), and acted as tutor to her son. The issue of the order against harbouring malignants led him to return to Eton. Here, having sold his valuable library at great sacrifice, he lived in poverty until his death on the 19th of May 1656.

His collected works (3 vols.) were edited by Lord Hailes, and published in 1765.

HALES, STEPHEN (1677-1761), English physiologist, chemist and inventor, was born at Bekebourne in Kent on the 7th or 17th of September 1677, the fifth (or sixth) son of Thomas Hales, whose father, Sir Robert Hales, was created a baronet by Charles II. in 1670. In June 1696 he was entered as a pensioner of Benet (now Corpus Christi) College, Cambridge, with the view of taking holy orders, and in February 1703 was admitted to a fellowship. He received the degree of master of arts in 1703 and of bachelor of divinity in 1711. One of his most intimate friends was William Stukeley (1687-1765) with whom he studied anatomy, chemistry, &c. In 1708-1709 Hales was presented to the perpetual curacy of Teddington in Middlesex, where he remained all his life, notwithstanding that he was subsequently appointed rector of Porlock in Somerset, and later of Faringdon in Hampshire. In 1717 he was elected fellow of the Royal Society, which awarded him the Copley medal in 1739. In 1732 he was named one of a committee for establishing a colony in Georgia, and the next year he received the degree of doctor of divinity from Oxford. He was appointed almoner to the princess-dowager of Wales in 1750. On the death of Sir Hans Sloane in 1753, Hales was chosen foreign associate of the French Academy of Sciences. He died at Teddington on the 4th of January 1761.

Hales is best known for his *Statistical Essays*. The first volume, *Vegetable Statics* (1727), contains an account of numerous experiments in plant-physiology—the loss of water in plants by evaporation, the rate of growth of shoots and leaves, variations in root-force at different times of the day, &c. Considering it very probable that plants draw "through their leaves some part of their nourishment from the air," he undertook experiments to show in "how great a proportion air is wrought into the composition of animal, vegetable and mineral substances"; though this "analysis of the air" did not lead him to any very clear ideas about the composition of the atmosphere, in the course of his inquiries he collected gases over water in vessels separate from those in which they were generated, and thus used what was to all intents and purposes a "pneumatic trough." The second volume (1733) on *Haemostatics*, containing experiments

on the "force of the blood" in various animals, its rate of flow, the capacity of the different vessels, &c., entitles him to be regarded as one of the originators of experimental physiology. But he did not confine his attention to abstract inquiries. The quest of a solvent for calculus in the bladder and kidneys was pursued by him as by others at the period, and he devised a form of forceps which, on the testimony of John Ranby (1703-1773), sergeant-surgeon to George II., extracted stones with "great ease and readiness." His observations of the evil effect of vitiated air caused him to devise a "ventilator" (a modified organ-bellows) by which fresh air could be conveyed into gaols, hospitals, ships' holds, &c.; this apparatus was successful in reducing the mortality in the Savoy prison, and it was introduced into France by the aid of H. L. Duhamel du Monceau. Among other things Hales invented a "sea-gauge" for sounding, and processes for distilling fresh from sea water, for preserving corn from weevils by fumigation with brimstone, and for salting animals whole by passing brine into their arteries. His *Admonition to the Drinkers of Gin, Brandy, &c.*, published anonymously in 1734, has been several times reprinted.

HALSOWEN, a market town in the Oldbury parliamentary division of Worcestershire, England, on a branch line of the Great Western and Midland railways, 6½ m. W.S.W. of Birmingham. Pop. (1901), 4057. It lies in a pleasant country among the eastern foothills of the Lickey Hills. There are extensive iron and steel manufactures. The church of SS Mary and John the Baptist has rude Norman portions; and the poet William Shenstone, buried in 1763 in the churchyard, has a memorial in the church. His delight in landscape gardening is exemplified in the neighbouring estate of the Leasowes, which was his property. There is a grammar school founded in 1652, and in the neighbourhood is the Methodist foundation of Bourne College (1883). Close to the town, on the river Stour, which rises in the vicinity, are slight ruins of a Premonstratensian abbey of Early English date. Within the parish and 2 m. N.W. of Halsowen is Cradley, with iron and steel works, fire-clay works and a large nail and chain industry.

HALÉVI, JUDAH BEN SAMUEL (c. 1085-c. 1140), the greatest Hebrew poet of the middle ages, was born in Toledo c. 1085, and died in Palestine after 1140. In his youth he wrote Hebrew love poems of exquisite fancy, and several of his Wedding Odes are included in the liturgy of the Synagogue. The mystical connexion between marital affection and the love of God had, in the view of older exegesis, already expressed itself in the scriptural *Song of Songs* and Judah Halevi used this book as his model. In this aspect of his work he found inspiration also in Arabic predecessors. The second period of his literary career was devoted to more serious pursuits. He wrote a philosophical dialogue in five books, called the *Cuzari*, which has been translated into English by Hirschfeld. This book bases itself on the historical fact that the Crimean Kingdom of the Khazars adopted Judaism, and the Hebrew poet-philosopher describes what he conceives to be the steps by which the Khazar king satisfied himself as to the claims of Judaism. Like many other medieval Jewish authors, Judah Halevi was a physician. His real fame depends on his liturgical hymns, which are the finest written in Hebrew since the Psalter, and are extensively used in the Septardic rite. A striking feature of his thought was his devotion to Jerusalem. To the love of the Holy City he devoted his noblest genius, and he wrote some memorable Odes to Zion, which have been commemorated by Heine, and doubly appreciated recently under the impulse of Zionism (q.v.). He started for Jerusalem, was in Damascus in 1140, and soon afterwards died. Legend has it that he was slain by an Arab horseman just as he arrived within sight of what Heine called his "Woebegone poor darling, Desolation's very image,—Jerusalem."

Excellent English renderings of some of Judah Halevi's poems may be read in Mrs H. Lucas's *The Jewish Year*, and Mrs R. N. Solomon's *Songs of Exile*. (I. A.)

HALÉVY, JACQUES FRANÇOIS FROMENTAL ÉLIE (1799-1862), French composer, was born on the 27th of May 1799, at Paris, of a Jewish family. He studied at the Paris Conservatoire

under Berton and Cherubini, and in 1819 gained the grand prix de Rome with his cantata *Herminie*. In accordance with the conditions of his scholarship he started for Rome, where he devoted himself to the study of Italian music, and wrote an opera and various minor works. In 1827 his opera *L'Arlesien* was performed at the Théâtre Feydeau in Paris, apparently without much success. Other works of minor importance, and now forgotten, followed, amongst which *Manon Lescaut*, a ballet, produced in 1830, deserves mention. In 1834 the Opéra-Comique produced *Ludovic*, the score of which had been begun by Hérold and had been completed by Halévy. In 1835 Halévy composed the tragic opera *La Juive* and the comic opera *L'Éclair*, and on these works his fame is mainly founded. The famous air of Eléazar and the anathema of the cardinal in *La Juive* soon became popular all over France. *L'Éclair* is a curiosity of musical literature. It is written for two tenors and two soprani, without a chorus, and displays the composer's mastery over the most refined effects of instrumentation and vocalization in a favourable light. After these two works he wrote numerous operas of various genres, amongst which only *La Reine de Chypre*, a spectacular piece analyzed by Wagner in one of his Paris letters (1841), and *La Tempête*, in three acts, written for Her Majesty's theatre, London (1850), need be mentioned. In addition to his productive work Halévy also rendered valuable services as a teacher. He was professor at the Conservatoire from 1827 till his death—some of the most successful amongst the younger composers in France, such as Gounod, Victor Massé and Georges Bizet, the author of *Carmen*, being amongst his pupils. He was *maestro al cembalo* at the Théâtre Italien from 1827 to 1829; then director of singing at the Opera House in Paris until 1845, and in 1836 he succeeded Reicha at the Institut de France. Halévy also tried his hand at literature. In 1857 he became permanent secretary to the Académie des Beaux Arts, and there exists an agreeable volume of *Sonnetts et portraits* from his pen. He died at Nice, on the 17th of March 1862.

HALÉVY, LUDOVIC (1834-1908), French author, was born in Paris on the 1st of January 1834. His father, Léon Halévy (1802-1883), was a clever and versatile writer, who tried almost every branch of literature—prose and verse, vaudeville, drama, history—without, however, achieving decisive success in any. His uncle, J. F. Fromental E. Halévy (q.v.), was for many years associated with the opéra; hence the double and early connexion of Ludovic Halévy with the Parisian stage. At the age of six he might have been seen playing in that *Foyer de la danse* with which he was to make his readers so familiar, and, when a boy of twelve, he would often, of a Sunday night, on his way back to the Collège Louis le Grand, look in at the Odéon, where he had free admittance, and see the first act of the new play. At eighteen he joined the ranks of the French administration and occupied various posts, the last being that of secrétaire-rédacteur to the Corps Législatif. In that capacity he enjoyed the special favour and friendship of the famous duke of Morny, then president of that assembly. In 1865 Ludovic Halévy's increasing popularity as an author enabled him to retire from the public service. Ten years earlier he had become acquainted with the musician Offenbach, who was about to start a small theatre of his own in the Champs Élysées, and he wrote a sort of prologue, *Entre, messieurs, mesdames*, for the opening night. Other little productions followed, *Ba-la-clan* being the most noticeable among them. They were produced under the pseudonym of Jules Servières. The name of Ludovic Halévy appeared for the first time on the bills on the 1st of January 1856. Soon afterwards the unprecedented run of *Orphée aux enfers*, a musical parody, written in collaboration with Hector Crémieux, made his name famous. In the spring of 1860 he was commissioned to write a play for the manager of the Variétés in conjunction with another vaudevillist, Lambert Thiboust. The latter having abruptly retired from the collaboration, Halévy was at a loss how to carry out the contract, when on the steps of the theatre he met Henri Meilhac (1831-1897), then comparatively a stranger to him. He proposed to Meilhac the task rejected by Lambert Thiboust, and the proposal was immediately accepted. Thus

began a connexion which was to last over twenty years, and which proved most fruitful both for the reputation of the two authors and the prosperity of the minor Paris theatres. Their joint works may be divided into three classes: the *opérettes*, the farces, the comedies. The *opérettes* afforded excellent opportunities to a gifted musician for the display of his peculiar humour. They were broad and lively libels against the society of the time, but savoured strongly of the vices and follies they were supposed to satirize. Amongst the most celebrated works of the joint authors were *La Belle Héloïse* (1864), *Barbe Bleue* (1866), *La Grande Duchesse de Gerolstein* (1867), and *La Périchole* (1868). After 1870 the vogue of Farody rapidly declined. The decadence became still more apparent when Offenbach was no longer at hand to assist the two authors with his quaint musical irony, and when they had to deal with interpreters almost destitute of singing powers. They wrote farces of the old type, consisting of complicated intrigues, with which they cleverly interwove the representation of contemporary whims and social oddities. They generally failed when they attempted comedies of a more serious character and tried to introduce a higher sort of emotion. A solitary exception must be made in the case of *Frou-frou* (1869), which, owing perhaps to the admirable talent of Aimée Desclée, remains their unique *succès de larmes*.

Meilhac and Halévy will be found at their best in light sketches of Parisian life, *Les Sonnettes*, *Le Roi Candale*, *Madame attend Monsieur*, *Toto chez Tata*. In that intimate association between the two men who had met so opportunely on the *parquet des variétés*, it was often asked who was the leading partner. The question was not answered until the connexion was finally severed and they stood before the public, each to answer for his own work. It was then apparent that they had many gifts in common. Both had wit, humour, observation of character. Meilhac had a ready imagination, a rich and whimsical fancy; Halévy had taste, refinement and pathos of a certain kind. Not less clever than his brilliant comrade, he was more human. Of this he gave evidence in two delightful books, *Monsieur et Madame Cardinal* (1873) and *Les Petites Classes Cardinal*, in which the lowest orders of the Parisian middle class are faithfully described. The pompous, pedantic, venomous Monsieur Cardinal will long survive as the true image of sententious and self-glorifying immorality. M. Halévy's peculiar qualities are even more visible in the simple and striking scenes of the *Insoumission*, published soon after the conclusion of the Franco-German War, in *Criquette* (1883) and *L'Abbé Constantin* (1882), two novels, the latter of which went through innumerable editions. Zola had presented to the public an almost exclusive combination of bad men and women; in *L'Abbé Constantin* all are kind and good, and the change was eagerly welcomed by the public. Some enthusiasts still maintain that the *Abbé* will rank permanently in literature by the side of the equally chimerical *Vicar of Wakefield*. At any rate, it opened for M. Ludovic Halévy the doors of the French Academy, to which he was elected in 1884.

Halévy remained an assiduous frequenter of the Academy, the Conservatoire, the Comédie Française, and the Society of Dramatic Authors, but, when he died in Paris on the 8th of May 1908, he had produced practically nothing new for many years. His last romance, *Kari Kari*, appeared in 1892.

The *Théâtre* of MM. Meilhac and Halévy was published in 8 vols. (1900-1902).

HALFPENNY, WILLIAM, English 18th-century architectural designer—he described himself as “architect and carpenter.” He was also known as Michael Hoare; but whether his real name was William Halfpenny or Michael Hoare is uncertain. His books, of which he published a score, deal almost entirely with domestic architecture, and especially with country houses in those Gothic and Chinese fashions which were so greatly in vogue in the middle of the 18th century. His most important publications, from the point of view of their effect upon taste, were *New Designs for Chinese Temples*, in four parts (1750-1752); *Rural Architecture in the Gothic Taste* (1752); *Chinese and Gothic Architecture Properly Ornamented* (1752); and *Rural Architecture in the Chinese Taste* (1750-1752). These four books were produced in

collaboration with John Halfpenny, who is said to have been his son. *New Designs for Chinese Temples* is a volume of some significance in the history of furniture, since, having been published some years before the books of Thomas Chippendale and Sir Thomas Chambers, it disproves the statement so often made that those designers introduced the Chinese taste into this country. Halfpenny states distinctly that “the Chinese manner” had been “already introduced here with success.” The work of the Halfpennys was by no means all contemptible. It is sometimes distinctly graceful, but is marked by little originality.

HALF-TIMBER WORK, an architectural term given to those buildings in which the framework is of timber with vertical studs and cross pieces filled in between with brick work, rubble masonry or plaster work on oak laths; in the first two, brick nogging or nogging are the terms occasionally employed (see CARPENTRY). Sometimes the timber structure is raised on a stone or brick foundation, as at Ledbury town hall in Herefordshire, where the lower storey is open on all sides; but more often it is raised on a ground storey, either in brick or stone, and in order to give additional size to the upper rooms projects forward, being carried on the floor joists. Sometimes the masonry or brickwork rises through two or three storeys and the half-brick work is confined to the gables. There seems to be some difference of opinion as to whether the term applies to the mixture of solid walling with the timber structure or to the alternation of wood posts and the filling in, but the latter definition is that which is generally understood. The half-timber throughout England is of the most picturesque description, and the earliest examples date from towards the close of the 15th century. In the earliest example, Newgate House, York (c. 1450), the timber framing is raised over the ground floor. The finest specimen is perhaps that of Mereton Old Hall, Cheshire (1570), where there is only a stone foundation about 12 in. high, and the same applies to Bramall Hall, near Manchester, portions of which are very early. Among other examples are Speke Hall, Lancashire; Park Hall, Shropshire (1553-1558); Hall i' th' Wood, Lancashire (1591); St Peter's Hospital, Bristol (1607); the Ludlow Feather's Inn (1610); many of the streets at Chester and Shrewsbury; the Sparrow's Home, Ipswich; and Staple Inn, Holborn, from which in recent years the plaster coat which was put on many years ago has been removed, displaying the ancient woodwork. A similar fate has overtaken a very large number of half-timber buildings to keep out the driving winds; thus in Lewes nearly all the half-timbered houses have had slates hung on the timbers, others tiles, the greater number having been covered with plaster or stucco. Although there are probably many more half-timber houses in England than on the continent of Europe, in the north of France and in Germany are examples in many of the principal towns, and in some cases in better preservation than in England. They are also enriched with carving of a purer and better type, especially in France; thus at Chartres, Angers, Rouen, Caen, Lisieux, Bayeux, St Lô and Beauvais, are many extremely fine examples of late Flamboyant and early Transitional examples. Again on the borders of the Rhine in all the small towns most of the houses are in half-timber work, the best examples being at Bacharach, Rhense and Boppard. Far more elaborate examples, however, are found in the vicinity of the Harz Mountains; the supply of timber from the forests there being very abundant; thus at Goslar, Wernigerode and Quedlingburg there is an endless variety, as also farther on at Gelnhausen and Hameln, the finest series of all being at Hildesheim. In Bavaria at Nuremberg, Rothenburg and Dinkelsbühl, half-timber houses dating from the 16th century are still well preserved; and throughout Switzerland the houses constructed in timber and plaster are the most characteristic features of the country.

HALFWAY COVENANT, an expedient adopted in the Congregational churches of New England between 1657 and 1662. Under its terms baptized persons of moral life and orthodox belief might receive the privilege of baptism for their children and other church benefits, without the full enrolment in membership which admitted them to the communion of the Lord's Supper.

See CONGREGATIONALISM: *Americas*.

HALHED, NATHANIEL BRASSEY (1751-1830), English Orientalist and philologist, was born at Westminster on the 25th of May 1751. He was educated at Harrow, where he began his intimacy with Richard Brinsley Sheridan (see **SHERIDAN FAMILY**) continued after he entered Christ Church, Oxford, where, also, he made the acquaintance of Sir William Jones, the famous Orientalist, who induced him to study Arabic. Accepting a writership in the service of the East India Company, Halhed went out to India, and here, at the suggestion of Warren Hastings, by whose orders it had been compiled, translated the *Gentoo code* from a Persian version of the original Sanskrit. This translation was published in 1776 under the title *A Code of Gentoo Laws*. In 1778 he published a Bengali grammar, to print which he set up, at Hugli, the first press in India. It is claimed for him that he was the first writer to call attention to the philological connexion of Sanskrit with Persian, Arabic, Greek and Latin. In 1785 he returned to England, and from 1790-1795 was M.P. for Lynton, Hants. For some time he was a disciple of Richard Brothers (*q.v.*), and his unwise speech in parliament in defence of Brothers made it impossible for him to remain in the House, from which he resigned in 1795. He subsequently obtained a home appointment under the East India Company. He died in London on the 18th of February 1830.

His collection of Oriental manuscripts was purchased by the British Museum, and there is an unfinished translation by him of the *Mahabharata* in the library of the Asiatic Society of Bengal.

HALIBURTON, THOMAS CHANDLER (1796-1865), British writer, long a judge of Nova Scotia, was born at Windsor, Nova Scotia, in 1796, and received his education there, at King's College. He was called to the bar in 1820, and became a member of the House of Assembly. He distinguished himself as a barrister, and in 1828 was promoted to the bench as a chief-justice of the common pleas. In 1829 he published *An Historical and Statistical Account of Nova Scotia*. But it is as a brilliant humourist and satirist that he is remembered, in connexion with his fictitious character "Sam Slick." In 1835 he contributed anonymously to a local paper a series of letters professedly depicting the peculiarities of the genuine Yankee. These sketches, which abounded in clever picturings of national and individual character, drawn with great satirical humour, were collected in 1837, and published under the title of *The Clockmaker, or Sayings and Doings of Samuel Slick of Slickville*. A second series followed in 1838, and a third in 1840. *The Attaché, or Sam Slick in England* (1843-1844), was the result of a visit there in 1841. His other works include: *The Old Judge, or Life in a Colony* (1843); *The Letter Bag of the Great Western* (1839); *Rule and Misrule of the English in America* (1851); *Traits of American Humour* (1852); and *Nature and Human Nature* (1855).

Meanwhile he continued to secure popular esteem in his judicial capacity. In 1840 he was promoted to be a judge of the supreme court; but within two years he resigned his seat on the bench, removed to England, and in 1859 entered parliament as the representative of Launceston, in the Conservative interest. But the tenure of his seat for Launceston was brought to an end by the dissolution of the parliament in 1865, and he did not again offer himself to the constituency. He died on the 27th of August of the same year, at Gordon House, Isleworth, Middlesex.

A memoir of Haliburton, by F. Blake Crofton, appeared in 1889.

HALIBUT, or HOLLIBUT (*Hippoglossus vulgatus*), the largest of all flat-fishes, growing to a length of 10 ft. or more, specimens of 5 ft. in length and of 100 lb. in weight being frequently exposed for sale in the markets. Indeed, specimens under 2 ft. in length are very rarely caught, and singularly enough, no instance is known of a very young specimen having been obtained. Small ones are commonly called "chicken halibut." The halibut is much more frequent in the higher latitudes of the temperate zone than in its southern portion; it is a circumpolar species, being found on the northern coasts of America, Europe and Asia, extending in the Pacific southwards to California. On the British coasts it keeps at some distance from the shore, and is

generally caught in from 50 to 150 fathoms. Its flesh is generally considered coarse, but it is white and firm, and when properly served is excellent for the table. The name is derived from "holy" (M.E. *halý*), and recalls its use for food on holy days.

HALICARNASSUS (mod. *Budrum*), an ancient Greek city on the S.W. coast of Caria, Asia Minor, on a picturesque and advantageous site on the Ceramic Gulf or Gulf of Cos. It originally occupied only the small island of Zephyria close to the shore, now occupied by the great castle of St Peter, built by the Knights of Rhodes in 1404; but in course of time this island was united to the mainland and the city extended so as to incorporate Salmacis, an older town of the Leleges and Carians.

About the foundation of Halicarnassus various traditions were current; but they agree in the main point as to its being a Dorian colony, and the figures on its coins, such as the head of Medusa, Athena and Poseidon, or the trident, support the statement that the mother cities were Troezen and Argos. The inhabitants appear to have accepted as their legendary founder Anthes, mentioned by Strabo, and were proud of the title of Anthesidae. At an early period Halicarnassus was a member of the Doric Hexapolis, which included Cos, Cnidus, Lindus, Camirus and Ialysus; but one of the citizens, Agasicles, having taken home the prize tripod which he had won in the Triopian games instead of dedicating it according to custom to the Triopian Apollo, the city was cut off from the league. In the early 5th century Halicarnassus was under the sway of Artemisia, who made herself famous at the battle of Salamis. Of Pisindalis, her son and successor, little is known; but Lygdamis, who next attained to power, is notorious for having put to death the poet Panyasis and caused Herodotus, the greatest of Halicarnassians, to leave his native city (c. 457 B.C.). In the 5th century B.C. Halicarnassus and other Dorian cities of Asia were to some extent absorbed by the Delian League, but the peace of Antalcidas in 387 made them subservient to Persia; and it was under Mausolus, a Persian satrap who assumed independent authority, that Halicarnassus attained its highest prosperity. Struck by the natural strength and beauty of its position, Mausolus removed to Halicarnassus from Mylasa, increasing the population of the city by the inhabitants of six towns of the Leleges. He was succeeded by Artemisia, whose military ability was shown in the stratagem by which she captured the Rhodian vessels attacking her city, and whose magnificence and taste have been perpetuated by the "Mausoleum," the monument she erected to her husband's memory (see **MAUSOLUS**). One of her successors, Pixodarus, tried to ally himself with the rising power of Macedonia, and is said to have gained the momentary consent of the young Alexander to wed his daughter. The marriage, however, was forbidden by Philip. Alexander, as soon as he had reduced Ionia, summoned Halicarnassus, where Memnon, the paramount satrap of Asia Minor, had taken refuge with the Persian fleet, to surrender; and on its refusal took the city after hard fighting and devastated it, but not being able to reduce the citadel, was forced to leave it blockaded. He handed the government of the city back to the family of Mausolus, as represented by Ada, sister of the latter. Not long afterwards we find the citizens receiving the present of a gymnasium from Ptolemy, and building in his honour a stoa or portico; but the city never recovered altogether from the disasters of the siege, and Cicero describes it as almost deserted. The site is now occupied in part by the town of Budrum; but the ancient walls can still be traced round nearly all their circuit, and the position of several of the temples, the theatre, and other public buildings can be fixed with certainty.

From the ruins of the Mausoleum sufficient has been recovered by the excavations carried out in 1857 by C. T. Newton to enable a fairly complete restoration of its design to be made. The building consisted of five parts—a basement or podium, a pteron or enclosure of columns, a pyramid, a pedestal and a chariot group. The basement, covering an area of 114 ft. by 92, was built of blocks of greenstone and cased with marble. Round the base of it were probably disposed groups of statuary. The

pteron consisted (according to Pliny) of thirty-six columns of the Ionic order, enclosing a square *cella*. Between the columns probably stood single statues. From the portions that have been recovered, it appears that the principal frieze of the pteron represented combats of Greeks and Amazons. In addition to these, there are also many life-size fragments of animals, horse-men, &c., belonging probably to pedimental sculptures, but formerly supposed to be parts of minor friezes. Above the pteron rose the pyramid, mounting by 24 steps to an apex or pedestal. On this apex stood the chariot with the figure of Mausolus himself and an attendant. The height of the statue of Mausolus in the British Museum is 9 ft. 9½ in. without the plinth. The hair rising from the forehead falls in thick waves on each side of the face and descends nearly to the shoulder; the beard is short and close, the face square and massive, the eyes deep set under overhanging brows, the mouth well formed with settled calm about the lips. The drapery is grandly composed. All sorts of restorations of this famous monument have been proposed. The original one, made by Newton and Pullan, is obviously in error in many respects; and that of Oldfield, though to be preferred for its lightness (the Mausoleum was said anciently to be "suspended in mid-air"), does not satisfy the conditions postulated by the remains. The best on the whole is that of the veteran German architect, F. Adler, published in 1900; but fresh studies have since been made (see below).

See C. T. Newton and R. P. Pullan, *History of Discoveries at Halikarnassus* (1862-1863); J. Ferguson, *The Mausoleum at Halikarnassus restored* (1862); E. Oldfield, "The Mausoleum," in *Archæologia* (1895); F. Adler, *Mausoleum zu Halikarnass* (1900); J. P. Six in *Journ. Hell. Studies* (1905); W. B. Dinsmoor, in *Amer. Journ.* (1908); J. J. Stevenson, *A Restoration of the Mausoleum of Halikarnassus* (1909); J. B. K. Preedy, "The Chariot Group of the Mausoleum," in *Journ. Hell. Stud.*, 1910. (D. G. H.)

HALICZ, a town of Austria, in Galicia, 70 m. by rail S.S.E. of Lemberg. Pop. (1900), 4809. It is situated at the confluence of the Luckow with the Dniester and its principal resources are the recovery of salt from the neighbouring brine wells, soap-making and the trade in timber. In the neighbourhood are the ruins of the old castle, the seat of the ruler of the former kingdom from which Galicia derived its Polish name. Halicz, which is mentioned in annals as early as 1113, was from 1141 to 1255 the residence of the princes of that name, one of the principalities into which western Russia was then divided. The town was then much larger, as is shown by excavations in the neighbourhood made during the 19th century, and probably met its doom during the Mongol invasion of 1240. In 1349 it was incorporated in the kingdom of Poland.

HALIFAX, CHARLES MONTAGUE, EARL OF (1661-1715), English statesman and poet, fourth son of the Hon. George Montague, fifth son of the first earl of Manchester, was born at Horton, Northamptonshire, on the 16th of April 1661. In his fourteenth year he was sent to Westminster school, where he was chosen king's scholar in 1677, and distinguished himself in the composition of extempore epigrams made according to custom upon these appointed for king's scholars at the time of election. In 1679 he entered Trinity College, Cambridge, where he acquired a solid knowledge of the classics and surpassed all his contemporaries at the university in logic and ethics. Latterly, however, he preferred to the abstractions of Descartes the practical philosophy of Sir Isaac Newton; and he was one of the small band of students who assisted Newton in forming the Philosophical Society of Cambridge. But it was his facility in verse-writing, and neither his scholarship nor his practical ability, that first opened up to him the way to fortune. His clever but absurdly panegyric poem on the death of Charles II. secured for him the notice of the earl of Dorset, who invited him to town and introduced him to the principal wits of the time; and in 1687 his joint authorship with Prior of the *Hind and Panther transversed to the Story of the Country Mouse and the City Mouse*, a parody of Dryden's political poem, not only increased his literary reputation but directly helped him to political influence.

In 1689, through the patronage of the earl of Dorset, he entered

parliament as member for Maldon, and sat in the convention which resolved that William and Mary should be declared king and queen of England. About this time he married the countess-dowager of Manchester, and it would appear, according to Johnson, that it was still his intention to take orders; but after the coronation he purchased a clerkship to the council. On being introduced by Earl Dorset to King William, after the publication of his poetical *Epistle occasioned by his Majesty's Victory in Ireland*, he was ordered to receive an immediate pension of £500 per annum, until an opportunity should present itself of "making a man of him." In 1691 he was chosen chairman of the committee of the House of Commons appointed to confer with a committee of the Lords in regard to the bill for regulating trials in cases of high treason; and he displayed in these conferences such tact and debating power that he was made one of the commissioners of the treasury and called to the privy council. But his success as a politician was less due to his oratorical gifts than to his skill in finance, and in this respect he soon began to manifest such brilliant talents as completely eclipsed the painstaking abilities of Godolphin. Indeed it may be affirmed that no other statesman has initiated schemes which have left a more permanent mark on the financial history of England. Although perhaps it was inevitable that England should sooner or later adopt the continental custom of lightening the annual taxation in times of war by contracting a national debt, the actual introduction of the expedient was due to Montague, who on the 15th of December 1692 proposed to raise a million of money by way of loan. Previous to this the Scotsman William Paterson (q.v.) had submitted to the government his plan of a national bank, and when in the spring of 1694 the prolonged contest with France had rendered another large loan absolutely necessary, Montague introduced a bill for the incorporation of the Bank of England. The bill after some opposition passed the House of Lords in May, and immediately after the prorogation of parliament Montague was rewarded by the chancellorship of the exchequer. In 1695 he was triumphantly returned for the borough of Westminster to the new parliament, and succeeded in passing his celebrated measure to remedy the depreciation which had taken place in the currency on account of dishonest manipulations. To provide for the expense of recoinage, Montague, instead of reviving the old tax of hearth money, introduced the window tax, and the difficulties caused by the temporary absence of a metallic currency were avoided by the issue for the first time of exchequer bills. His other expedients for meeting the emergencies of the financial crisis were equally successful, and the rapid restoration of public credit secured him a commanding influence both in the House of Commons and at the board of the treasury; but although Godolphin resigned office in October 1696, the king hesitated for some time between Montague and Sir Stephen Fox as his successor, and it was not till 1697 that the former was appointed first lord. In 1697 he was accused by Charles Duncombe, and in 1698 by a Col. Granville, of fraud, but both charges broke down, and Duncombe was shown to have been guilty of extreme dishonesty himself. In 1698 and 1699 he acted as one of the council of regency during the king's absence from England. With the accumulation of his political successes his vanity and arrogance became, however, so offensive that latterly they utterly lost him the influence he had acquired by his administrative ability and his masterly eloquence; and when his power began to be on the wane he set the seal to his political overthrow by conferring the lucrative sinecure office of auditor of the exchequer on his brother-in-law in trust for himself should he be compelled to retire from power. This action earned him the offensive nickname of "Filcher," and for some time afterwards, in attempting to lead the House of Commons, he had to submit to constant mortifications, often verging on personal insults. After the return of the king in 1699 he resigned his offices in the government and succeeded his brother in the auditorship.

On the accession of the Tories to power he was removed in 1701 to the House of Lords by the title of Lord Halifax. In the same year he was impeached for malpractices along with Lord

Somers and the earls of Portland and Oxford, but all the charges were dismissed by the Lords; and in 1703 a second attempt to impeach him was still more unsuccessful. He continued out of office during the reign of Queen Anne, but in 1706 he was named one of the commissioners to negotiate the union with Scotland; and after the passing of the Act of Settlement in favour of the house of Hanover, he was appointed ambassador to the elector's court to convey the insignia of order of the garter to George I. On the death of Anne (1714) he was appointed one of the council of regency until the arrival of the king from Hanover; and after the coronation he received the office of first lord of the treasury in the new ministry, being at the same time created earl of Halifax and Viscount Sunbury. He died on the 10th of May 1715 and left no issue. He was buried in the vault of the Albemarle family in Westminster Abbey. His nephew George (d. 1739) succeeded to the barony, and was created Viscount Sunbury and earl of Halifax in 1715.

Montague's association with Prior in the travesty of Dryden's *Hind and Panther* has no doubt largely aided in preserving his literary reputation; but he is perhaps indebted for it chiefly to his subsequent influential position and to the fulsome flattery of the men of letters who enjoyed his friendship, and who, in return for his liberal donations and the splendid banqueting which they occasionally enjoyed at his villa on the Thames, "fed him," as Pope says, "all day long with dedications." Swift says he gave them nothing but "good words, and good dinners." That, however, his beneficence to needy talent, if sometimes attributable to an itching ear for adulation, was at others prompted by a sincere appreciation of intellectual merit, is sufficiently attested by the manner in which he procured from Godolphin a commissionership for Addison, and also by his life-long intimacy with Newton, for whom he obtained the mastership of the mint. The small fragments of poetry which he left behind him, and which were almost solely the composition of his early years, display a certain facility and vigour of diction, but their thought and fancy are never more than commonplace, and not unfrequently in striving to be eloquent and impressive he is only grotesquely and extravagantly absurd. In administrative talent he was the superior of all his contemporaries, and his only rival in parliamentary eloquence was Somers; but the skill with which he managed measures was superior to his tact in dealing with men, and the effect of his brilliant financial successes on his reputation was gradually almost nullified by the affected arrogance of his manner and by the eccentricities of his sensitive vanity. So eager latterly was his thirst for fame and power that perhaps Marlborough did not exaggerate when he said that "he had no other principle but his ambition, so that he would put all in distraction rather than not gain his point."

Among the numerous notices of Halifax by contemporaries may be mentioned the eulogistic reference which concludes Addison's account of the "greatest of English poets"; the dedications by Steel to the second volume of the *Spectator* and to the fourth of the *Tatler*; Pope's laudatory mention of him in the epilogue to his *Satires* and in the preface to the *Iliad*, and his portrait of him as "Full-blown Bufo" in the *Epistle to Arbuthnot*. Various allusions to him are to be found in Swift's works and in Marlborough's *Letters*. See also Burnet's *History of his Own Times*; *The Parliamentary History*; Howell's *State Trials*; Johnson's *Lives of the Poets*; and Macaulay's *History of England*. His *Miscellaneous Works* were published at London in 1704; his *Life and Miscellaneous Works* in 1715; and his *Poetical Works*, to which also his "Life" is attached, in 1716. His poems were reprinted in the 9th volume of Johnson's *English Poets*.

HALIFAX, GEORGE MONTAGU DUNK, 2ND EARL OF (1716-1771), son of George Montagu, 1st earl of Halifax (of the second creation), was born on the 5th or 6th of October 1716, becoming earl of Halifax on his father's death in 1739. Educated at Eton and at Trinity College, Cambridge, he was married in 1741 to Anne Richards (d. 1753), a lady who had inherited a great fortune from Sir Thomas Dunk, whose name was taken by Halifax. After having been an official in the household of Frederick, prince of Wales, the earl was made master of the buck-hounds, and in 1748 he became president of the Board of Trade.

While filling this position he helped to found Halifax, the capital of Nova Scotia, which was named after him, and in several ways he rendered good service to trade, especially with North America. About this time he sought to become a secretary of state, but in vain, although he was allowed to enter the cabinet in 1757. In March 1761 Halifax was appointed lord-lieutenant of Ireland, and during part of the time which he held this office he was also first lord of the admiralty. He became secretary of state for the northern department under the earl of Bute in October 1762, retaining this post under George Grenville and being one of the three ministers to whom George III. entrusted the direction of affairs. He signed the general warrant under which Wilkes was arrested in 1763, for which action he was mulcted in damages by the courts of law in 1769, and he was mainly responsible for the exclusion of the name of the king's mother, Augusta, princess of Wales, from the Regency Bill of 1765. With his colleagues the earl left office in July 1765, returning to the cabinet as lord privy seal under his nephew, Lord North, in January 1770. He had just been transferred to his former position of secretary of state when he died on the 8th of June 1771. Halifax, who was lord-lieutenant of Northamptonshire and a lieutenant-general in the army, showed some disinterestedness in money matters, but was very extravagant. He left no children, and his titles became extinct on his death. Horace Walpole speaks slightly of the earl, and says he and his mistress, Mary Anne Faulkner, "had sold every employment in his gift."

See the *Memoirs* of his secretary, Richard Cumberland (1807).

HALIFAX, GEORGE SAVILE, 1ST MARQUESS OF (1633-1695), English statesman and writer, great-grandson of Sir George Savile of Lupset and Thornhill in Yorkshire (created baronet in 1611), was the eldest son of Sir William Savile, 3rd baronet, who distinguished himself in the civil war in the royalist cause and who died in 1644, and of Anne, eldest daughter of Lord Keeper Coventry. He was thus nephew of Sir William Coventry, who is said to have influenced his political opinions, and of Lord Shaftesbury, afterwards his most bitter opponent, and great-nephew of the earl of Strafford; by his marriage with the Lady Dorothy Spencer, he was brother-in-law to Lord Sunderland. He entered public life with all the advantages of lineage, political connexions, great wealth and estates, and uncommon abilities. He was elected member of the Convention parliament for Pontefract in 1660, and this was his only appearance in the Lower House. A peerage was sought for him by the duke of York in 1665, but was successfully opposed by Clarendon, on the ground of his "ill-reputation amongst men of piety and religion," the real motives of the chancellor's hostile attitude being probably Savile's connexion with Buckingham and Coventry. The honours were, however, only deferred for a short time and were obtained after the fall of Clarendon on the 31st of December 1667,¹ when Savile was created Baron Savile of Eland and Viscount Halifax.

He supported zealously the anti-French policy formulated in the Triple Alliance of January 1668. He was at this time in favour at court, was created a privy councillor in 1672, and, while ignorant of the disgraceful secret clauses in the treaty of Dover, was chosen envoy to negotiate terms of peace with Louis XIV. and the Dutch at Utrecht. His mission was still further deprived of importance by Arlington and Buckingham, who were in the king's counsels, and who anticipated his arrival and took the negotiations out of his hands; and though he signed the compact, he had no share in the harsh terms imposed upon the Dutch, and henceforth became a bitter opponent of the policy of subservience to French interests and of the Roman Catholic claims.

He took an active part in passing through parliament the great Test Act of 1673² and forfeited in consequence his friendship with James. In 1674 he brought forward a motion for

¹ *Cal. State Papers, Dom.* (Nov. 1667—Sep. 1668), p. 196.

² *Lords' Journals*, 12, p. 567; *Savile Correspondence*, ed. by W. D. Cooper, p. 136; "Character of a Trimmer," in *Life of Sir G. Savile*, by H. C. Foxcroft, ii. 316.

disarming "popish recusants," and supported one by Lord Carlisle for restricting the marriages in the royal family to Protestants; but he opposed the bill introduced by Lord Danby (see LEEDS, 1ST DUKE OR) in 1675, which imposed a test oath on officials and members of parliament, speaking "with that quickness, learning and elegance that are inseparable from all his discourses," and ridiculing the multiplication of oaths, since "no man would ever sleep with open doors... should all the town be sworn not to rob." He was now on bad terms with Danby, and a witty sally at that minister's expense caused his dismissal from the council in January 1676. In 1678 he took an active part in the investigation of the "Popish Plot," to which he appears to have given excessive credence, but opposed the bill which was passed on the 30th of October 1678, to exclude Roman Catholics from the House of Lords.

In 1679, as a consequence of the fall of Danby, he became a member of the newly constituted privy council. With Charles, who had at first "kicked at his appointment," he quickly became a favourite, his lively and "libertine" (i.e. free or sceptical) conversation being named by Bishop Burnet as his chief attraction for the king. His dislike of the duke of York and of the Romanist tendencies of the court did not induce him to support the rash attempt of Lord Shaftesbury to substitute the illegitimate duke of Monmouth for James in the succession. He feared Shaftesbury's ascendancy in the national councils and foresaw nothing but civil war and confusion as a result of his scheme. He declared against the exclusion of James, was made an earl in 1679, and was one of the "Triumvirate" which now directed public affairs. He assisted in passing into law the Habeas Corpus Bill. According to Sir W. Temple he showed great severity in putting into force the laws against the Roman Catholics, but this statement is considered a misrepresentation.¹ In 1680 he voted against the execution of Lord Stafford.

Meanwhile (1679) his whole policy had been successfully directed towards uniting all parties with the object of frustrating Shaftesbury's plans. Communications were opened with the prince of Orange, and the illness of the king was made the occasion for summoning James from Brussels. Monmouth was compelled to retire to Holland, and Shaftesbury was dismissed. On the other hand, while Halifax was so far successful, James was given an opportunity of establishing a new influence at the court. It was with great difficulty that his retirement to Scotland was at last effected; the ministers lost the confidence and support of the "country party," and Halifax, fatigued and ill, at the close of this year, retired to Rufford Abbey, the country home of the Saviles since the destruction of Thornhill Hall in 1648, and for some time took little part in affairs. He returned in September 1680 on the occasion of the introduction of the Exclusion Bill in the Lords. The debate which followed, one of the most famous in the whole annals of parliament, became a duel of oratory between Halifax and his uncle Shaftesbury, the finest two speakers of the day, watched by the Lords, the Commons at the bar, and the king, who was present. It lasted seven hours. Halifax spoke sixteen times, and at last, regardless of the menaces of the more violent supporters of the bill, who closed round him, vanquished his opponent. The rejection of the bill by a majority of 33 was attributed by all parties entirely to the eloquence of Halifax. His conduct transformed the allegiance to him of the Whigs into bitter hostility, the Commons immediately petitioning the king to remove him from his councils for ever, while any favour which he might have regained with James was forfeited by his subsequent approval of the regency scheme.

He retired to Rufford again in January 1681, but was present at the Oxford parliament, and in May returned suddenly to public life and held for a year the chief control of affairs. The arrest of Shaftesbury on the 2nd of July was attributed to his influence, but in general, during the period of Tory reaction, he seems to have urged a policy of conciliation and moderation upon the king. He opposed James's return from Scotland and, about this time (Sept.), made a characteristic but futile attempt

¹ Foxcroft i. 160, where Hallam is quoted to this effect.

to persuade the duke to attend the services of the Church of England and thus to end all difficulties. He renewed relations with the prince of Orange, who in July paid a visit to England to seek support against the French designs upon Luxemburg. The influence of Halifax procured for the Dutch a formal assurance from Charles of his support; but the king informed the French ambassador that he had no intention of fulfilling his engagements, and made another secret treaty with Louis. Halifax opposed in 1682 James's vindictive prosecution of the earl of Argyll, arousing further hostility in the duke, while the same year he was challenged to a duel by Monmouth, who attributed to him his disgrace.

His short tenure of power ended with the return of James in May. Outwardly he still retained the king's favour and was advanced to a marquissate (Aug. 17) and to the office of lord privy seal (Oct. 25). Being still a member of the administration he must share responsibility for the attack now made upon the municipal franchises, a violation of the whole system of representative government, especially as the new charters passed his office. In January 1684 he was one of the commissioners "who supervise all things concerning the city and have turned out those persons who are whiggishly inclined" (N. Luttrell's *Diary*, i. 295). He made honourable but vain endeavours to save Algernon Sidney and Lord Russell. "My Lord Halifax," declared Tillotson in his evidence before the later inquiry, "showed a very compassionate concern for my Lord Russell and all the readiness to serve them that could be wished."² The Rye-House Plot, in which it was sought to implicate them, was a disastrous blow to his policy, and in order to counteract its consequences he entered into somewhat perilous negotiations with Monmouth, and endeavoured to effect his reconciliation with the king. On the 12th of February 1684, he procured the release of his old antagonist, Lord Danby. Shortly afterwards his influence at the court revived. Charles was no longer in receipt of his French pension and was beginning to tire of James and Rochester. The latter, instead of becoming lord treasurer, was, according to the epigram of Halifax which has become proverbial, "kicked upstairs," to the office of lord president of the council. Halifax now worked to establish intimate relations between Charles and the prince of Orange and opposed the abrogation of the recusancy laws. In a debate in the cabinet of November 1684, on the question of the grant of a fresh constitution to the New England colonies, he urged with great warmth "that there could be no doubt whatever but that the same laws which are in force in England should also be established in a country inhabited by Englishmen and that an absolute government is neither so happy nor so safe as that which is tempered by laws and which sets bounds to the authority of the prince," and declared that he could not "live under a king who should have it in his power to take, whenever he thought proper, the money he has in his pocket." The opinions thus expressed were opposed by all the other ministers and highly censured by Louis XIV., James and Judge Jeffreys.

At the accession of James he was immediately deprived of all power and relegated to the presidency of the council. He showed no compliance, like other Lords, with James's Roman Catholic preferences. He was opposed to the parliamentary grant to the king of a revenue for life; he promoted the treaty of alliance with the Dutch in August 1685; he expostulated with the king on the subject of the illegal commissions in the army given to Roman Catholics; and finally, on his firm refusal to support the repeal of the Test and Habeas Corpus Acts, he was dismissed, and his name was struck out of the list of the privy council (Oct. 1685). He corresponded with the prince of Orange, conferred with Dykvelt, the latter's envoy, but held aloof from plans which aimed at the prince's personal interference in English affairs. In 1687 he published the famous *Letter to a Dissenter*, in which he warns the Nonconformists against being beguiled by the "Indulgence" into joining the court party, sets in a clear light the fatal results of such a step, and reminds them that under their next sovereign their grievances would in

² *Hist. MSS. Comm. House of Lords MSS. 1689-1690. p. 287.*

all probability be satisfied by the law. The tract, which has received general and unqualified admiration, must be classed amongst the few known writings which have actually and immediately altered the course of history. Copies to the number of 20,000 were circulated through the kingdom, and a great party was convinced of the wisdom of remaining faithful to the national traditions and liberties. He took the popular side on the occasion of the trial of the bishops in June 1688, visited them in the Tower, and led the cheers with which the verdict of "not guilty" was received in court; but the same month he refrained from signing the invitation to William, and publicly repudiated any share in the prince's plans. On the contrary he attended the court and refused any credence to the report that the prince born to James was supposititious. After the landing of William he was present at the council called by James on the 27th of November. He urged the king to grant large concessions, but his speech, in contrast to the harsh and overbearing attitude of the Hydes, was "the most tender and obliging . . . that ever was heard." He accepted the mission with Nottingham and Godolphin to treat with William at Hungerford, and succeeded in obtaining moderate terms from the prince. The negotiations, however, were abortive, for James had from the first resolved on flight. In the crisis which ensued, when the country was left without a government, Halifax took the lead. He presided over the council of Lords which assembled and took immediate measures to maintain public order. On the return of James to London on the 16th of November, after his capture at Faversham, Halifax repaired to William's camp and henceforth attached himself unreluctantly to his cause. On the 17th he carried with Lords Delamere and Shrewsbury a message from William to the king advising his departure from London, and, after the king's second flight, directed the proceedings of the executive. On the meeting of the convention on the 22nd of January 1689, he was formally elected speaker of the House of Lords. He voted against the motion for a regency (Jan. 20), which was only defeated by two votes. The moderate and comprehensive character of the settlement at the revolution plainly shows his guiding hand, and it was finally through his persuasion that the Lords yielded to the Commons and agreed to the compromise whereby William and Mary were declared joint sovereigns. On the 13th of February in the Banqueting House at Whitehall, he tendered the crown to them in the name of the nation, and conducted the proclamation of their accession in the city.

At the opening of the new reign he had considerable influence, was made lord privy seal, while Danby his rival was obliged to content himself with the presidency of the council, and controlled the appointments to the new cabinet which were made on a "trimming" or comprehensive basis. His views on religious toleration were as wide as those of the new king. He championed the claims of the Nonconformists as against the high or rigid Church party, and he was bitterly disappointed at the miscarriage of the Comprehension Bill. He thoroughly approved also at first of William's foreign policy; but, having excited the hostility of both the Whig and Tory parties, he now became exposed to a series of attacks in parliament which finally drove him from power. He was severely censured, as it seems quite unjustly, for the disorder in Ireland, and an attempt was made to impeach him for his conduct with regard to the sentences on the Whig leaders. The inquiry resulted in his favour; but notwithstanding, and in spite of the king's continued support, he determined to retire. He had already resigned the speakership of the House of Lords, and he now (Feb. 8, 1690) quitted his place in the cabinet. He still nominally retained his seat in the privy council, but in parliament he became a bitter critic of the administration; and the rivalry of Halifax (the Black Marquess) with Danby, now marquess of Carmarthen (the White Marquess) threw the former at this time into determined opposition. He disapproved of William's total absorption in European politics, and his open partiality for his countrymen. In January 1691 Halifax had an interview with Henry Bulkeley, the Jacobite agent, and is said to have promised "to do everything that lay

in his power to serve the king." This was probably merely a measure of precaution, for he had no serious Jacobite leanings. He entered bail for Lord Marlborough, accused wrongfully of complicity in a Jacobite plot in May 1692, and in June, during the absence of the king from England, his name was struck off the privy council.

He spoke in favour of the Triennial Bill (Jan. 12, 1693) which passed the legislature but was vetoed by William, suggested a proviso in the Licensing Act, which restricted its operation to anonymous works, approved the Place Bill (1694), but opposed, probably on account of the large sums he had engaged in the traffic of annuities, the establishment of the bank of England in 1694. Early in 1695 he delivered a strong attack on the administration in the House of Lords, and, after a short illness arising from a neglected complaint, he died on the 5th of April at the age of sixty-one. He was buried in Henry VII.'s chapel in Westminster Abbey.

The influence of Halifax, both as orator and as writer, on the public opinion of his day was probably unrivalled. His intellectual powers, his high character, his urbanity, vivacity and satirical humour made a great impression on his contemporaries, and many of his witty sayings have been recorded. But the superiority of his statesmanship could not be appreciated till later times. Maintaining throughout his career a complete detachment from party, he never acted permanently or continuously with either of the two great factions, and exasperated both in turn by deserting their cause at the moment when their hopes seemed on the point of realization. To them he appeared weak, inconstant, untrustworthy. They could not see what to us now is plain and clear, that Halifax was as consistent in his principles as the most rabid Whig or Tory. But the principle which chiefly influenced his political action, that of compromise, differed essentially from those of both parties, and his attitude with regard to the Whigs or Tories was thus by necessity continually changing. Measures, too, which in certain circumstances appeared to him advisable, when the political scene had changed became unwise or dangerous. Thus the regency scheme, which Halifax had supported while Charles still reigned, was opposed by him with perfect consistency at the revolution. He readily accepted for himself the character of a "trimmer," desiring, he said, to keep the boat steady, while others attempted to weigh it down perilously on one side or the other; and he concluded his tract with these assertions: "that our climate is a Trimmer between that part of the world where men are roasted and the other where they are frozen; that our Church is a Trimmer between the frenzy of fanatic visions and the lethargic ignorance of Popish dreams, that our laws are Trimmers between the excesses of unbounded power and the extravagance of liberty not enough restrained; that true virtue hath ever been thought a Trimmer, and to have its dwelling in the middle between two extremes; that even God Almighty Himself is divided between His two great attributes, His Mercy and His Justice. In such company, our Trimmer is not ashamed of his name. . . ."¹

His powerful mind enabled him to regard the various political problems of his time from a height and from a point of view similar to that from which distance from the events enables us to consider them at the present day; and the superiority of his vision appears sufficiently from the fact that his opinions and judgments on the political questions of his time are those which for the most part have ultimately triumphed and found general acceptance. His attitude of mind was curiously modern.² Reading, writing and arithmetic, he thinks, should be taught to all and at the expense of the state. His opinions again on the constitutional relations of the colonies to the mother country, already cited, were completely opposed to those of his own period. For that view of his character which while allowing him the merit of a brilliant political theorist denies him the qualities of a man of action and of a practical politician, there is no solid basis. The truth is that while his political ideas are founded upon great moral or philosophical generalizations, often vividly

¹ *Character of a Trimmer*, conclusion.

² Savilianna quoted by Foxcroft i. 115.

recalling and sometimes anticipating the broad conceptions of Burke, they are at the same time imbued with precisely those practical qualities which have ever been characteristic of English statesmanship, and were always capable of application to actual conditions. He was no star-gazing philosopher, with thoughts superior to the contemplation of mundane affairs. He had no taste for abstract political dogma. He seems to venture no further than to think that "men should live in some competent state of freedom," and that the limited monarchical and aristocratic government was the best adapted for his country. "Circumstances," he writes in the *Rough Draft of a New Model of Sea*, "must come in and are to be made a part of the matter of which we are to judge; positive decisions are always dangerous, more especially in politics." Nor was he the mere literary student buried in books and in contemplative ease. He had none of the "indecisiveness which commonly renders literary men of no use in the world" (Sir John Dalrymple). The incidents of his career show that there was no backwardness or hesitation in acting when occasion required. The constant tendency of his mind towards antithesis and the balancing of opinions did not lead to paralysis in time of action. He did not shrink from responsibility, nor show on any occasion lack of courage. At various times of crisis he proved himself a great leader. He returned to public life to defeat the Exclusion Bill. At the revolution it was Halifax who seized the reins of government, flung away by James, and maintained public security. His subsequent failure in collaborating with William is, it is true, disappointing. But the cause was one that has not perhaps received sufficient attention. Party government had come to the birth during the struggles over the Exclusion Bill, and there had been unconsciously introduced into politics a novel element of which the nature and importance were not understood or suspected. Halifax had consistently ignored and neglected party; and it now had its revenge. Detested by the Whigs and by the Tories alike, and defended by neither, the favour alone of the king and his own transcendent abilities proved insufficient to withstand the constant and violent attacks made upon him in parliament, and he yielded to the superior force. He seems indeed himself to have been at last convinced of the necessity in English political life of party government, for though in his *Cautions* to electors he warns them against men "tied to a party," yet in his last words he declares "If there are two parties a man ought to adhere to that which he disliked least though in the whole he doth not approve it; for whilst he doth not list himself in one or the other party, he is looked upon as such a straggler that he is fallen upon by both. . . . Happy those that are convinced so as to be of the general opinions" (*Political Thoughts and Reflections of Parties*).

The private character of Lord Halifax was in harmony with the greatness of his public career. He was by no means the "voluptuary" described by Macaulay. He was on the contrary free from self-indulgence; his manner of life was decent and frugal, and his dress proverbially simple. He was an affectionate father and husband. "His heart," says Burnet (i. 492-493, ed. 1833), "was much set on raising his family"—his last concern even while on his deathbed was the remarriage of his son Lord Eland to perpetuate his name; and this is probably the cause of his acceptance of so many titles for which he himself affected a philosophical indifference. He was estimable in his social relations and habits. He showed throughout his career an honourable independence, and was never seen to worship the rising sun. In a period when even great men stooped to accept bribes, Halifax was known to be incorruptible; at a time when animosities were especially bitter, he was too great a man to harbour resentments. "Not only from policy," says Reresby (*Mem.* p. 231), "which teaches that we ought to let no man be our enemy when we can help it), but from his disposition I never saw any man more ready to forgive than himself." Few were insensible to his personal charm and gaiety. He excelled especially in quick repartee, in "exquisite nonsense," and in spontaneous humour. When quite a young man, just entering upon political life he is described by Evelyn as "a witty gentle-

man, if not a little too prompt and daring." The latter characteristic was not moderated by time but remained through life. He was incapable of controlling his spirit of raillery, from jests on Siamese missionaries to sarcasms at the expense of the heir to the throne and ridicule of hereditary monarchy, and his brilliant paradoxes, his pungent and often profane epigrams were received by graver persons as his real opinions and as evidences of atheism. This latter charge he repudiated, assuring Burnet that he was "a Christian in submission," but that he could not digest iron like an ostrich nor swallow all that the divines sought to impose upon the world.

The speeches of Halifax have not been preserved, and his political writings on this account have all the greater value. *The Character of a Trimmer* (1684 or 1685), the authorship of which, long doubtful, is now established,¹ was his most ambitious production, written seemingly as advice to the king and as a manifesto of his own opinions. In it he discusses the political problems of the time and their solution on broad principles. He supports the Test Act and, while opposing the Indulgence, is not hostile to the repeal of the penal laws against the Roman Catholics by parliament. Turning to foreign affairs he contemplates with consternation the growing power of France and the humiliation of England, exclaiming indignantly at the sight of the "Roses blasted and discoloured while lilies triumph and grow insolent upon the comparison." The whole is a masterly and comprehensive summary of the actual political situation and its exigencies; while, when he treats such themes as liberty, or discusses the balance to be maintained between freedom and government in the constitution, he rises to the political idealism of Bolingbroke and Burke. *The Character of King Charles II.* (printed 1750), to be compared with his earlier sketch of the king in the *Character of a Trimmer*, is perhaps from the literary point of view the most admirable of his writings. The famous *Letter to a Dissenter* (1687) was thought by Sir James Mackintosh to be unrivalled as a political pamphlet. *The Lady's New Year's Gift: or Advice to a Daughter*, refers to his daughter Elizabeth, afterwards wife of the 3rd and mother of the celebrated 4th earl of Chesterfield (1688). In *The Anatomy of an Equivalent* (1688) he treats with keen wit and power of analysis the proposal to grant a "perpetual edict" in favour of the Established Church in return for the repeal of the test and penal laws. *Maxims of State* appeared about 1692. *The Rough Draft of a New Model of Sea* (c. 1694), though apparently only a fragment, is one of the most interesting and characteristic of his writings. It opens with the question: "What shall we do to be saved in this world?" There is no other answer but this, "Look to your moat." The first article of an Englishman's political creed must be that he believeth in the sea." He discusses the naval establishment, not from the naval point of view alone, but from the general aspect of the constitution of which it is a detail, and is thus led on to consider the nature of the constitution itself, and to show that it is not an artificial structure but a growth and product of the natural character. We may also mention *Some Cautions* to the electors of the parliament (1694), and *Political, Moral and Miscellaneous Thoughts and Reflections* (n.d.), a collection of aphorisms in the style of the maxims of La Rochefoucauld, inferior in style—but greatly excelling the French author in breadth of view and in moderation. (For other writings attributed to Halifax, see Foxcroft, *Life of Sir G. Savile*, ii. 529 sqq.).

Halifax was twice married, first in 1656 to the Lady Dorothy Spencer—daughter of the 1st earl of Sunderland and of Dorothy Sidney, "Sacharissa"—who died in 1670, leaving a family; and secondly, in 1672, to Gertrude, daughter of William Pierrepont of Thoresby, who survived him, and by whom he had one daughter, Elizabeth, Lady Chesterfield, who seems to have inherited a considerable portion of her father's intellectual abilities. On the death of his son William, 2nd marquess of Halifax, in August 1700 without male issue, the peerage became extinct, and the baronetcy passed to the Saviles of Lupset, the whole

¹ Foxcroft, ii. 273 et seq., and *Hist. MSS. Comm. MSS. of F. W. Leyborne-Popham*, p. 264.

male line of the Savile family ending in the person of Sir George Savile, 8th baronet, in 1784. Henry Savile, British envoy at Versailles, who died unmarried in 1687, was a younger brother of the first marquis. Halifax has been generally supposed to have been the father of the illegitimate Henry Carey, the poet, but this is doubtful.

See *Life and Letters of Sir George Savile, 1st Marquis of Halifax* (2 vols., 1898), by Miss H. C. Foxcroft, who has collected and made excellent use of all the material available at that date, including hitherto unexplored Savile MSS., at Devonshire House, in the Spencer Archives, in the Longleat and other collections, and who has edited the works of Halifax and printed a memorandum of conversations with King William of 1688-1690, left in MS. by Halifax. Macaulay, in his *History of England*, misjudged Halifax on some points, but nevertheless understood and did justice to the greatness of his statesmanship, and pronounced on him a well-merited and eloquent eulogy (iv. 545). Contemporary characters of Halifax which must be accepted with caution are Burnet's in the *History of His Own Times* (ed. 1833, vol. i. pp. 491-493, and iv. 268), that by the author of "Savilliana," identified as William Mompesson, and "Sacellum Apollinare," a panegyric in verse by Elkanah Settle (1695). (P. C. Y.)

HALIFAX, a city and port of entry, capital of the province of Nova Scotia, Canada. It is situated in 44° 50' N. and 63° 35' W., on the south-east coast of the province, on a fortified hill, 225 ft. in height, which slopes down to the waters of Chebucto Bay, now known as Halifax Harbour. The harbour, which is open all the year, is about 6 m. long by 1 m. in width, and has excellent anchorage in all parts; to the north a narrow passage connects it with Bedford Basin, 6 m. in length by 4 m., and deep enough for the largest men-of-war. At the harbour mouth lies McNab's Island, thus forming two entrances; the eastern passage is only employed by small vessels, though in 1862 the Confederate cruiser, "Tallahassee," slipped through by night, and escaped the northern vessels which were watching off the western entrance. The population in 1901 was 40,832.

The town was originally built of wood, plastered or stuccoed, but though the wooden houses largely remain, the public buildings are of stone. Inferior in natural strength to Quebec alone, the city and its approaches have been fortified till it has become the strongest position in Canada, and one of the strongest in the British Empire. Till 1906 it was garrisoned by British troops, but in that year, with Esquimaux, on the Pacific coast, it was taken over by the Canadian government, an operation necessitating a large increase in the Canadian permanent military force. At the same time, the royal dockyard, containing a dry-dock 610 ft. in length, and the residences in connexion, were also taken over for the use of the department of marine and fisheries. Till 1905 Halifax was the summer station of the British North American squadron. In that year, in consequence of a redistribution of the fleet, the permanent North American squadron was withdrawn; but Halifax is still visited periodically by powerful squadrons of cruisers.

Though, owing to the growth of Sydney and other outports, it no longer monopolizes the foreign trade of the province, Halifax is still a thriving town, and has the largest export trade of the Dominion in fish and fish products, the export of fish alone, in 1904, amounting to over three-fifths that of the entire Dominion. Lumber (chiefly spruce deals) and agricultural products (especially apples) are also exported in large quantities. The chief imports are manufactures from Great Britain and the United States, and sugar, molasses, rum and fruit from the West Indies. Its industrial establishments include foundries, sugar refineries, manufacturers of furniture and other articles of wood, a skate factory and rope and cordage works, the produce of which are all exported. It is the Atlantic terminus of the Intercolonial, Canadian Pacific and several provincial railways, and the chief winter port of Canada, numerous steamship lines connecting it with Great Britain, Europe, the West Indies and the United States. The public gardens, covering 14 acres, and Point Pleasant Park, left to a great extent in its natural state, are extremely beautiful. Behind the city is an arm of the sea (known as the North-West Arm), 5 m. in length and 1 m. in breadth, with high, well-wooded shores, and covered in summer with canoes and sailing craft. The educational institutions include

a ladies' college, several convents, a Presbyterian theological college and Dalhousie University, with faculties of arts, law, medicine and science. Established by charter in 1818 by the earl of Dalhousie, then lieutenant governor, and reorganized in 1863, it has since become much the most important seat of learning in the maritime provinces. Other prominent buildings are Government House, the provincial parliament and library, and the Roman Catholic cathedral. St Paul's church (Anglican) dates from 1750, and though not striking architecturally, is interesting from the memorial tablets and the graves of celebrated Nova Scotians which it contains. The city is the seat of the Anglican bishop of Nova Scotia and Prince Edward Island, and of the Roman Catholic bishop of Halifax.

Founded in 1749 by the Hon. Edward Cornwallis as a rival to the French town of Louisbourg in Cape Breton, it was named after the 2nd earl of Halifax, president of the board of trade and plantations. In the following year it superseded Annapolis as capital of the province. Its privateers played a prominent part in the war of 1812-15 with the United States, and during the American Civil War it was a favourite base of operations for Confederate blockade-runners. The federation of the North American provinces in 1867 lessened its relative importance, but its merchants have gradually adapted themselves to the altered conditions.

HALIFAX, a municipal, county and parliamentary borough in the West Riding of Yorkshire, England, 104 m. N.N.W. from London and 7 m. S.W. from Bradford, on the Great Northern and the Lancashire & Yorkshire railways. Pop. (1891), 97,714; (1901) 104,936. It lies in a bare hilly district on and above the small river Hebble near its junction with the Calder. Its appearance is in the main modern, though a few picturesque old houses remain. The North Bridge, a fine iron structure, spans the valley, giving connexion between the opposite higher parts of the town. The principal public building is the town hall, completed in 1863 after the designs of Sir Charles Barry; it is a handsome Palladian building with a tower. Of churches the most noteworthy is that of St John the Baptist, the parish church, a Perpendicular building with lofty western tower. Two earlier churches are traceable on this side, the first perhaps pre-Norman, the second of the Early English period. The old woodwork is fine, part being Perpendicular, but the greater portion dates from 1621. All Souls' church was built in 1859 from the designs of Sir Gilbert Scott, of whose work it is a good example, at the expense of Mr Edward Akroyd. The style is early Decorated, and a rich ornamentation is carried out in Italian marble, serpentine and alabaster. A graceful tower and spire 236 ft. high rise at the north-west angle. The Square chapel, erected by the Congregationalists in 1857, is a striking cruciform building with a tower and elaborate crocketed spire. Both the central library and museum and the Akroyd museum and art gallery occupy buildings which were formerly residences, the one of Sir Francis Crossley (1817-1872) and the other of Mr Edward Akroyd. Among charitable institutions the principal is the handsome royal infirmary, a Renaissance building. The Heath grammar school was founded in 1585 under royal charter for instruction in classical languages. It possesses close scholarships at Oxford and Cambridge universities. The Waterhouse charity school occupies a handsome set of buildings forming three sides of a quadrangle, erected in 1855. The Crossley almshouses were erected and endowed by Sir Francis and Mr Joseph Crossley, who also endowed the Crossley orphan home and school. Technical schools are maintained by the corporation. Among other public buildings may be noted the Piece-Hall, erected in 1799 for the lodgment and sale of piece goods, now used as a market, a great quadrangular structure occupying more than two acres; the bonding warehouse, court-house, and mechanics' institute. There are six parks, of which the People's Park of 12½ acres, presented by Sir Francis Crossley in 1858, is laid out in ornate style from designs by Sir Joseph Paxton.

Halifax ranks with Leeds, Bradford and Huddersfield as a seat of the woollen and worsted manufacture. The manufacture of carpets is a large industry, one establishment employing some

5000 hands. The worsted, woollen and cotton industries, and the iron, steel and machinery manufactures are very extensive. There are collieries and freestone quarries in the neighbourhood.

The parliamentary borough returns two members. The county borough was created in 1888. The municipal borough is under a mayor, 15 aldermen and 45 councillors. Area, 13,067 acres.

At the time of the Conquest Halifax formed part of the extensive manor of Wakefield, which belonged to the king, but in the 13th century was in the hands of John, earl Warrenne (c. 1245-1305). The prosperity of the town began with the introduction of the cloth trade in the 15th century, when there are said to have been only thirteen houses, which before the end of the 16th century had increased to 520. Camden, about the end of the 17th century, wrote that "the people are very industrious, so that though the soil about it be barren and unprofitable, not fit to live on, they have so flourished . . . by the clothing trade that they are very rich and have gained a reputation for it above their neighbours." The trade is said to have been increased by the arrival of certain merchants driven from the Netherlands by the persecution of the duke of Alva. Among the curious customs of Halifax was the Gibbet Law, which was probably established by a prescriptive right to protect the wool trade, and gave the inhabitants the power of executing any one taken within their liberty, who, when tried by a jury of sixteen of the frith-burgesses, was found guilty of the theft of any goods of the value of more than 13d. The executions took place on market days on a hill outside the town, the gibbet somewhat resembling a guillotine. The first execution recorded under this law took place in 1541, and the right was exercised in Halifax longer than in any other town, the last execution taking place in 1650. In 1635 the king granted the inhabitants of Halifax licence to found a workhouse in a large house given to them for that purpose by Nathaniel Waterhouse, and incorporated them under the name of the master and governors. Nathaniel Waterhouse was appointed the first master, his successors being elected every year by the twelve governors from among themselves. Halifax was a borough by prescription, its privileges growing up with the increased prosperity brought by the cloth trade, but it was not incorporated until 1848. Since the Reform Act of 1832 the burgesses have returned two members to parliament. In 1607 David Waterhouse, lord of the manor of Halifax, obtained a grant of two markets there every week on Friday and Saturday and two fairs every year, each lasting three days, one beginning on the 24th of June, the other on the 11th of November. Later these fairs and markets were confirmed with the addition of an extra market on Thursday to Sir William Ayloff, baronet, who had succeeded David Waterhouse as lord of the manor. The market rights were sold to the Markets Company in 1810 and purchased from them by the corporation in 1853.

During the Civil War Halifax was garrisoned by parliament, and a field near it is still called the Bloody Field on account of an engagement which took place there between the forces of parliament and the Royalists.

See *Victoria County History*, "Yorkshire"; T. Wright, *The Antiquities of the Town of Halifax* (Leeds, 1738); John Watson, *The History and Antiquities of the Parish of Halifax* (London, 1775); John Crabtree, *A Concise History of the Parish and Vicarage of Halifax* (Halifax and London, 1839).

HALIṢAH (Hebrew, חַלִּיטָה "untying"), the ceremony by which a Jewish widow releases her brother-in-law from the obligation to marry her in accordance with Deuteronomy xxv. 5-10, and obtains her own freedom to remarry. By the law of Moses it became obligatory upon the brother of a man dying childless to take his widow as wife. If he refused, "then shall his brother's wife come unto him in the presence of the elders and loose his shoe from off his foot, and spit in his face, and shall answer and say, So shall it be done unto that man that will not build up his brother's house." By Rabbinical law the ceremony was later made more complex. The parties appear

before a court of three elders with two assessors. The place is usually the synagogue house, or that of the Rabbi, sometimes that of the widow. After inquiry as to the relationship of the parties and their status (for if either be a minor or deformed, ḥaliṣah cannot take place), the shoe is produced. It is usually the property of the community and made entirely of leather from the skin of a "clean" animal. It is of two pieces, the upper part and the sole, sewn together with leathern threads. It has three small straps in front, and two white straps to bind it on the leg. After it is strapped on, the man must walk four cubits in the presence of the court. The widow then loosens and removes the shoe, throwing it some distance, and spits on the ground, repeating thrice the Biblical formula "So shall it be done," &c. Ḥaliṣah, which is still common among orthodox Jews, must not take place on the Sabbath, a holiday, or the eve of either, or in the evening. To prevent brothers-in-law from extorting money from a widow as a price for releasing her from perpetual widowhood, Jewish law obliges all brothers at the time of a marriage to sign a document pledging themselves to submit to ḥaliṣah without payment. (Compare *LEVIRATE*).

HALKETT, HUGH, FREIHERR VON (1783-1863), British soldier and general of infantry in the Hanoverian service, was the second son of Major-General F. G. Halkett, who had served many years in the army, and whose ancestors had for several generations distinguished themselves in foreign services. With the "Scotch Brigade" which his father had been largely instrumental in raising, Hugh Halkett served in India from 1798 to 1801. In 1803 his elder brother Colin was appointed to command a battalion of the newly formed King's German Legion, and in this he became senior captain and then major. Under his brother's command he served with Cathcart's expeditions to Hanover, Rügen and Copenhagen, where his bold initiative on outpost duty won commendation. He was in the Peninsula in 1808-1809, and at Walcheren. At Albuera, Salamanca, &c., he commanded the 2nd Light Infantry Battalion, K.G.L., in succession to his brother, and at Venta del Pozo in the Burgos retreat he greatly distinguished himself. In 1813 he left the Peninsula and was subsequently employed in the organization of the new Hanoverian army. He led a brigade of these troops in Count Wallmoden's army, and bore a marked part in the battle of Göhrde and the action of Schestedt, where he took with his own hand a Danish standard. In the Waterloo campaign he commanded two brigades of Hanoverian militia which were sent to the front with the regulars, and during the fight with the Old Guard captured General Cambronne. After the fall of Napoleon he elected to stay in the Hanoverian service, though he retained his half-pay lieutenant-colonelcy in the English army. He rose to be general and inspector-general of infantry. In his old age he led the Xth Federal Army Corps in the Danish War of 1848, and defeated the Danes at Oversee. He had the G.C.H., the C.B. and many foreign orders, including the Prussian order of the Black Eagle and *pour le Mérite* and the Russian St Anne.

See Knesebeck, *Leben des Freiherrn Hugh von Halkett* (Stuttgart, 1865).

His brother, **SIR COLIN HALKETT** (1774-1856), British soldier, began his military career in the Dutch Guards and served in various "companies" for three years, leaving as a captain in 1795. From 1800 to the peace of Amiens he served with the Dutch troops in English pay in Guernsey. In August 1803 Halkett was one of the first officers assigned to the service of raising the King's German Legion, and he became major, and later lieutenant-colonel, commanding the 2nd Light Infantry Battalion. His battalion was employed in the various expeditions mentioned above, from Hanover to Walcheren, and in 1811 Colin Halkett succeeded Charles Alten in the command of the Light Brigade, K.G.L., which he held throughout the Peninsula War from Albuera to Toulouse. In 1815 Major-General Sir Colin Halkett commanded the 5th British Brigade of Alten's division, and at Waterloo he received four wounds. Unlike his brother, he remained in the British service, in which he rose to general. At the time of his death he was governor of Chelsea

hospital. He had honorary general's rank in the Hanoverian service, the G.C.B. and G.C.H., as well as numerous foreign orders.

For information about both the Halketts, see Beamish, *History of the King's German Legion* (1832).

HALL, BASIL (1788-1844), British naval officer, traveller and miscellaneous writer, was born at Edinburgh on the 31st of December 1788. His father was Sir James Hall of Dunglass, the geologist. Basil Hall was educated at the High School, Edinburgh, and in 1802 entered the navy, where he rose to the rank of post-captain in 1817, after seeing active service in several fields. By observing the ethnological as well as the physical peculiarities of the countries he visited, he collected the materials for a very large number of scientific papers. In 1816 he commanded the sloop "Lyra," which accompanied Lord Amherst's embassy to China; and he described his cruise in *An Account of a Voyage of Discovery to the West Coast of Corea and the Great Loo-choo Island in the Japan Sea* (London, 1818). In 1820 he held a command on the Pacific coast of America, and in 1824 published two volumes of *Extracts from a Journal written on the Coasts of Chili, Peru and Mexico in the Years 1820-21-22*. Retiring on half-pay in 1824, Hall in 1825 married Margaret, daughter of Sir John Hunter, and in her company travelled (1827-1828) through the United States. In 1829 he published his *Travels in North America in the Years 1827 and 1828*, which was assailed by the American press for its views of American society. *Schloss Hainfeld, or a Winter in Lower Styria* (1836), is partly a romance, partly a description of a visit paid by the author to the castle of the countess Purgstall. *Spain and the Seat of War in Spain* appeared in 1837. The *Fragments of Voyages and Travels* (9 vols.) were issued in three detachments between 1831 and 1840. Captain Hall was a fellow of the Royal Societies of London and Edinburgh, and of the Royal Astronomical, Royal Geographical and Geological Societies. His last work, a collection of sketches and tales under the name of *Patchwork* (1841), had not been long published before its author became insane, and he died in Haslar hospital, Portsmouth, on the 11th of September 1844.

HALL, CARL CHRISTIAN (1812-1888), Danish statesman, son of the highly respected artisan and train-band colonel Mads Hall, was born at Christianshavn on the 25th of February 1812. After a distinguished career at school and college, he adopted the law as his profession, and in 1837 married the highly gifted but eccentric Augusta Marie, daughter of the philologist Peter Oluf Brøndsted. A natural conservatism indisposed Hall at first to take any part in the popular movement of 1848, to which almost all his friends had already adhered; but the moment he was convinced of the inevitability of popular government, he resolutely and sympathetically followed in the new paths. Sent to the *Rigsforsamling* of 1848 as member for the first district of Copenhagen, a constituency he continued to represent in the *Folketing* till 1881, he immediately took his place in the front rank of Danish politicians. From the first he displayed rare ability as a debater, his inspiring and yet amiable personality attracted hosts of admirers, while his extraordinary tact and temper disarmed opposition and enabled him to mediate between extremes without ever sacrificing principles.

Hall was not altogether satisfied with the fundamental law of June; but he considered it expedient to make the best use possible of the existing constitution and to unite the best conservative elements of the nation in its defence. The aloofness and sulkiness of the aristocrats and landed proprietors he deeply deplored. Failing to rally them to the good cause he determined anyhow to organize the great cultivated middle class into a political party. Hence the "June Union," whose programme was progress and reform in the spirit of the constitution, and at the same time opposition to the one-sided democratism and party-tyranny of the *Bondevenner* or peasant party. The "Union" exercised an essential influence on the elections of 1852, and was, in fact, the beginning of the national Liberal party, which found its natural leader in Hall. During the years 1852-1854 the burning question of the day was the connexion between the various parts of the monarchy. Hall was "eider-

danak" by conviction. He saw in the closest possible union between the kingdom and a Schleswig freed from all risk of German interference the essential condition for Denmark's independence; but he did not think that Denmark was strong enough to carry such a policy through unsupported, and he was therefore inclined to promote it by diplomatic means and international combinations, and strongly opposed to the Conventions of 1851-1852 (See DENMARK: *History*), though he was among the first, subsequently, to accept them as an established fact and the future basis for Denmark's policy.

Hall first took office in the Bang administration (12th of December 1854) as minister of public worship. In May 1857 he became president of the council after Andrae, Bang's successor, had retired, and in July 1858 he exchanged the ministry of public worship for the ministry of foreign affairs, while still retaining the premiership.

Hall's programme, "den Konstitutionelle Helstat," i.e. a single state with a common constitution, was difficult enough in a monarchy which included two nationalities, one of which, to a great extent, belonged to a foreign and hostile jurisdiction. But as this political monstrosity had already been guaranteed by the Conventions of 1851-1852, Hall could not rid himself of it, and the attempt to establish this "Helstat" was made accordingly by the Constitution of the 13th of November 1863. The failure of the attempt and its disastrous consequences for Denmark are described elsewhere. Here it need only be said that Hall himself soon became aware of the impossibility of the "Helstat," and his whole policy aimed at making its absurdity patent to Europe, and substituting for it a constitutional Denmark to the Eider which would be in a position to come to terms with an independent Holstein. That this was the best thing possible for Denmark is absolutely indisputable, and "the diplomatic Seven Years' War" which Hall in the meantime conducted with all the powers interested in the question is the most striking proof of his superior statesmanship. Hall knew that in the last resort the question must be decided not by the pen but by the sword. But he relied, ultimately, on the protection of the powers which had guaranteed the integrity of Denmark by the treaty of London, and if words have any meaning at all he had the right to expect at the very least the armed support of Great Britain.¹ But the great German powers and the force of circumstances proved too strong for him. On the accession of the new king, Christian IX., Hall resigned rather than repeal the November Constitution, which gave Denmark something to negotiate upon in case of need. But he made matters as easy as he could for his successors in the Monrad administration, and the ultimate catastrophe need not have been as serious as it was had his advice, frankly given, been intelligently followed.

After 1864 Hall bore more than his fair share of the odium and condemnation which weighed so heavily upon the national Liberal party, making no attempt to repudiate responsibility and refraining altogether from attacking patently unscrupulous opponents. But his personal popularity suffered not the slightest diminution, while his clear, almost intuitive, outlook and his unconquerable faith in the future of his country made him, during those difficult years, a factor of incalculable importance in the public life of Denmark. In 1870 he joined the Holstein-Holsteinborg ministry as minister of public worship, and in that capacity passed many useful educational reforms, but on the fall of the administration, in 1873, he retired altogether from public life. In the summer of 1879 Hall was struck down by apoplexy, and for the remaining nine years of his life he was practically bedridden. He died on the 14th of August 1888. In politics Hall was a practical, sagacious "opportunist," in the best sense of that much abused word, with an eye rather for things than for persons. Moreover, he had no very pronounced political ambition, and was an utter stranger to that longing for power, which drives so many men of talent to adopt extreme expedients. His urbanity and perfect

¹ On this head see the 3rd marquess of Salisbury's *Political Essays*, reprinted from the *Quarterly Review*.

equilibrium at the very outset incited sympathy, while his wit and humour made him the centre of every circle within which he moved.

See Vilhelm Christian Sigurd Topsøe, *Polit. Portrætsstudier* (Copenhagen, 1878); Schøller Parelius Vilhelm Birkeedal, *Personlige Optælselser* (Copenhagen, 1890-1891). (R. N. B.)

HALL, CHARLES FRANCIS (1821-1871), American Arctic explorer, was born at Rochester, New Hampshire. After following the trade of blacksmith he became a journalist in Cincinnati; but his enthusiasm for Arctic exploration led him in 1859 to volunteer to the American Geographical Society to "go in search for the bones of Franklin." With the proceeds of a public subscription he was equipped for his expedition and sailed in May 1860 on board a whaling vessel. The whaler being ice-bound, Hall took up his abode in the regions to the north of Hudson Bay, where he found relics of Frobenius's 16th-century voyages, and living with the Eskimo for two years he acquired a considerable knowledge of their habits and language. He published an account of these experiences under the title of *Arctic Researches, and Life among the Esquimaux* (1864). Determined, however, to learn more about the fate of the Franklin expedition he returned to the same regions in 1864, and passing five years among the Eskimo was successful in obtaining a number of Franklin relics, as well as information pointing to the exact fate of 76 of the crew, whilst also performing some geographical work of interest. In 1871 he was given command of the North Polar expedition fitted out by the United States Government in the "Polaris." Making a remarkably rapid passage up Smith Sound at the head of Baffin Bay, which was found to be ice-free, the "Polaris" reached on the 30th of August the lat. of 82° 11', at that time, and until the English expedition of 1876 the highest northern latitude attained by vessel. The expedition went into winter quarters in a sheltered cove on the Greenland coast. On the 24th of October, Hall on his return from a successful sledge expedition to the north was suddenly seized by an illness of which he died on the 8th of November. Capt. S. O. Buddington (1823-1888) assumed command, and although the "Polaris" was subsequently lost after breaking out of the ice, with only part of the crew aboard, the whole were ultimately rescued, and the scientific results of the expedition proved to be of considerable importance.

HALL, CHRISTOPHER NEWMAN (1816-1902), English Nonconformist divine, was born at Maidstone on the 22nd of May 1816. His father was John Vine Hall, proprietor and printer of the *Maidstone Journal*, and the author of a popular evangelical work called *The Sinner's Friend*. Christopher was educated at University College, London, and took the London B.A. degree. His theological training was gained at Highbury College, whence he was called in 1842 to his first pastorate at the Albion Congregational Church, Hull. During the twelve years of his ministry there the membership was greatly increased, and a branch chapel and school were opened. At Hull Newman Hall first began his active work in temperance reform, and in defence of his position wrote *The Scriptural Claims of Teetotalism*. In 1854 he accepted a call to Surrey chapel, London, founded in 1783 by the Rev. Rowland Hill. A considerable sum had been bequeathed by Hill for the perpetuation of his work on the expiration of the lease; but, owing to some legal flaw in the will, the money was not available, and Newman Hall undertook to raise the necessary funds for a new church. By weekly offertories and donations the money for the beautiful building called Christ Church at the junction of the Kennington and Westminster Bridge Roads was collected, and within four years of opening (1876) the total cost (£63,000) was cleared. In 1892 Newman Hall resigned his charge and devoted himself to general evangelical work. Most of his writings are small booklets or tracts of a distinctly evangelical character. The best known of these is *Come to Jesus*, of which over four million copies have been circulated in forty different languages. Newman Hall visited the United States during the Civil War, and did much to promote a friendly understanding between England and America. A Liberal in politics, and a keen admirer of John

Bright, few preachers of any denomination have exercised so far-reaching an influence as the "Dissenters' Bishop," as he came to be termed. He died on the 18th of February 1902.

See his *Autobiography* (1898); obituary notice in *The Congressional Year Book* for 1903.

HALL, EDWARD (c. 1498-1547), English chronicler and lawyer, was born about the end of the 15th century, being a son of John Hall of Northall, Shropshire. Educated at Eton and King's College, Cambridge, he became a barrister and afterwards filled the offices of common sergeant of the city of London and judge of the sheriff's court. He was also member of parliament for Bridgnorth. Hall's great work, *The Union of the Noble and Illustre Families of Lancaster and York*, commonly called *Hall's Chronicle*, was first published in 1542. Another edition was issued by Richard Grafton in 1548, the year after Hall's death, and another in 1550; these include a continuation from 1532 compiled by Grafton from the author's notes. In 1809 an edition was published under the supervision of Sir Henry Ellis, and in 1904 the part dealing with the reign of Henry VIII. was edited by C. Whibley. The *Chronicle* begins with the accession of Henry IV. to the English throne in 1399; it follows the strife between the houses of Lancaster and York, and with Grafton's continuation carries the story down to the death of Henry VIII. in 1547. Hall presents the policy of this king in a very favourable light and shows his own sympathy with the Protestants. For all kinds of ceremonial he has all a lawyer's respect, and his pages are often adorned and encumbered with the pageantry and material garniture of the story. The value of the *Chronicle* in its early stages is not great, but this increases when dealing with the reign of Henry VII. and is very considerable for the reign of Henry VIII. Moreover, the work is not only valuable, it is attractive. To the historian it furnishes what is evidently the testimony of an eye-witness on several matters of importance which are neglected by other narrators; and to the student of literature it has the exceptional interest of being one of the prime sources of Shakespeare's historical plays.

See J. Gairdner, *Early Chroniclers of Europe; England* (1879).

HALL, FITZEDWARD (1825-1901), American Orientalist, was born in Troy, New York, on the 21st of March 1825. He graduated with the degree of civil engineer from the Rensselaer Polytechnic Institute at Troy in 1842, and entered Harvard in the class of 1846; just before his class graduated he left college and went to India in search of a runaway brother. In January 1850 he was appointed tutor, and in 1853 professor of Sanskrit and English, in the government college at Benares; and in 1855 was made inspector of public instruction in Ajmere-Merwara and in 1856 in the Central Provinces. He settled in England in 1862 and received the appointment to the chair of Sanskrit, Hindustani and Indian jurisprudence in King's College, London, and to the librarianship of the India Office. He died at Marlesford, Suffolk, on the 1st of February 1901. Hall was the first American to edit a Sanskrit text, the *Vismayapūrāna*; his library of a thousand Oriental MSS. he gave to Harvard University.

His works include: in Sanskrit, *Atmabodha* (1852), *Sāṅkhyapraśāhana* (1856), *Sāryasiddhānta* (1859), *Vāsavadattā* (1859), *Sāṅkhyasāra* (1862) and *Dasarūpa* (1865); in Hindi, *Baillanthes' Hindi Grammar* (1868) and a *Reader* (1870); on English philology, *Recent Exemplifications of False Philology* (1872), attacking Richard Grant White, *Modern English* (1873). "On English Adjectives in -able, with Special Reference to Reliable" (*Am. Jour. Philology*, 1877), *Doctor Indoctus* (1880).

HALL, ISAAC HOLLISTER (1837-1896), American Orientalist, was born in Norwalk, Connecticut, on the 12th of December 1837. He graduated at Hamilton College in 1859, was a tutor there in 1859-1863, graduated at the Columbia Law School in 1865, practised law in New York City until 1875, and in 1875-1877 taught in the Syrian Protestant College at Beirut, where he discovered a valuable Syriac manuscript of the Philoxenian version of a large part of the New Testament, which he published in part in facsimile in 1884. He worked with General di Cesnola in classifying the famous Cypriote collection in the Metropolitan Museum of New York City, and was a curator of that museum from 1885 until his death in Mount Vernon, New York, on the

and of July 1896. He was an eminent authority on Oriental inscriptions. Following the scanty clues given by George Smith and Samuel Birch, and working on the data furnished by the di Cesnola collection, he succeeded about 1874 in deciphering an entire Cypriote inscription, and in establishing the Hellenic character of the dialect and the syllabic nature of the script.

His work in Cypriote epigraphy is described in his articles in *Scribner's Magazine*, vol. 20 (June, 1880), pp. 205-211 and in the *Journal of the American Oriental Society*, vol. 10, No. 2 (1880), pp. 201-218. He published in facsimile the *Antilegomena epistyles* (1886), which he deciphered from the W. F. Williams manuscript, and edited *A Critical Bibliography of the Greek New Testament as Published in America* (1884).

HALL, SIR JAMES (1761-1832), Scottish geologist and physicist, eldest son of Sir John Hall, Bart., was born at Dun-glass on the 17th of January 1761; and became distinguished as the first to establish experimental research as an aid to geological investigation. He was intimately acquainted with James Hutton and John Playfair, and having studied rocks in various parts of Europe he was eventually led to accept and to demonstrate the truth of Hutton's views with regard to intrusive rocks. He commenced a series of experiments to illustrate the fusion of rocks, their vitreous and crystalline characters, and the influence of molten rocks in altering adjacent strata. He thus assisted in proving that granitic veins had been injected into overlying deposits after their consolidation. He studied the volcanic rocks in Italy and recognized that the old lava flows and the numerous dikes in Scotland must have had a similar origin. He made further experiments to illustrate the contortions of rocks. The results were brought before the Royal Society of Edinburgh. He died at Edinburgh on the 23rd of June 1832. He represented in parliament (1807-1812) the old borough of Michael in Cornwall; he also wrote an *Essay on the Origin, History and Principles of Gothic Architecture* (1813).

His eldest son, John Hall (1787-1860), who succeeded him, was a Fellow of the Royal Society; the second son, Captain Basil Hall (q.v.), was the distinguished traveller; the third son, James Hall (1800-1854), was a painter, art-patron, and a friend of Sir David Wilkie.

HALL, JAMES (1793-1868), American judge and man of letters, was born at Philadelphia on the 19th of August 1793. After for some time prosecuting the study of law, he in 1812 joined the army, and in the war with Great Britain distinguished himself in engagements at Lundy's Lane, Niagara and Fort Erie. On the conclusion of the war he accompanied an expedition against Algiers, but in 1818 he resigned his commission, and continued the study of law at Pittsburg. In 1820 he removed to Shawneetown, Illinois, where he commenced practice at the bar and also edited the *Illinois Gazette*. Soon after he was appointed public prosecutor of the circuit, and in 1824 state circuit judge. In 1827 he became state treasurer, and held that office till 1831, but he continued at the same time his legal practice and also edited the *Illinois Intelligencer*. Subsequently he became editor of the *Western Souvenir*, an annual publication, and of the *Illinois Monthly Magazine*, afterwards the *Western Monthly Magazine*. He died near Cincinnati on the 5th of July 1868.

The following are his principal works:—*Letters from the West*, originally contributed to the *Portfolio*, and collected and published in London in 1828; *Legends of the West* (1832); *The Soldier's Bride and other Tales* (1832); *The Harpe's Head, a Legend of Kentucky* (1833); *Sketches of the West* (2 vols., 1835); *Tales of the Border* (1835); *Notes on the Western States* (1838); *History of the Indian Tribes*, in conjunction with T. L. McKeeney (3 vols., 1838-1844); *The Wilderness and the War-Path* (1845); *Romance of Western History* (1857).

HALL, JAMES (1811-1898), American geologist and palaeontologist, was born at Hingham, Massachusetts, on the 12th of September 1811. In early life he became attached to the study of natural history, and he completed his education at the polytechnic institute at Troy in New York, where he graduated in 1832, and afterwards became professor of chemistry and natural science, and subsequently of geology. In 1836 he was appointed one of the geologists on the Geological Survey of the state of

New York, and he was before long charged with the palaeontological work. Eventually he became state geologist and director of the museum of natural history at Albany. His published papers date from 1836, and include numerous reports on the geology and palaeontology of various portions of the United States and Canada. He dealt likewise with physical geology, and in 1859 discussed the connexion between the accumulation of sedimentary deposits and the elevation of mountain-chains. His chief work was the description of the invertebrate fossils of New York—in which he dealt with the graptolites, brachiopods, mollusca, trilobites, echini and crinoids of the Palaeozoic formations. The results were published in a series of quarto volumes entitled *Palaeontology of New York* (1847-1894), in which he was assisted in course of time by R. P. Whitfield and J. M. Clarke. He published also reports on the geology of Oregon and California (1845), Utah (1852), Iowa (1859) and Wisconsin (1862). He received the Wollaston medal from the Geological Society of London in 1858. He was a man of great energy and untiring industry, and in 1897, when in his eighty-sixth year, he journeyed to St Petersburg to take part in the International Geological Congress, and then joined the excursion to the Ural mountains. He died at Albany on the 7th of August 1898.

See *Life and Work of James Hall*, by H. C. Hovey, *Amer. Geol.* xiii., 1899, p. 137 (portraits).

HALL, JOSEPH (1574-1656), English bishop and satirist, was born at Bristow park, near Ashby de la Zouch, Leicestershire, on the 1st of July 1574. His father, John Hall, was agent in the town for Henry, earl of Huntingdon, and his mother, Winifred Bambridge, was a pious lady, whom her son compared to St Monica. Joseph Hall received his early education at the local school, and was sent (1589) to Emmanuel College, Cambridge. Hall was chosen for two years in succession to read the public lecture on rhetoric in the schools, and in 1595 became fellow of his college. During his residence at Cambridge he wrote his *Virgideiarius* (1597), satires written after Latin models. The claim he put forward in the prologue to be the earliest English satirist:—

"I first adventure, follow me who list
And be the second English satirist"—

gave bitter offence to John Marston, who attacks him in the satires published in 1598. The archbishop of Canterbury gave an order (1599) that Hall's satires should be burnt with works of John Marston, Marlowe, Sir John Davies and others on the ground of licentiousness, but shortly afterwards Hall's book, certainly unjustly condemned, was ordered to be "staid at the press," which may be interpreted as reprieved (see *Notes and Queries*, 3rd series, xii. 436). Having taken holy orders, Hall was offered the mastership of Blundell's school, Tiverton, but he refused it in favour of the living of Halsted, Essex, to which he was presented (1601) by Sir Robert Drury. In his parish he had an opponent in a Mr Lilly, whom he describes as "a witty and bold atheist." In 1603 he married; and in 1605 he accompanied Sir Edmund Bacon to Spa, with the special aim, he says, of acquainting himself with the state and practice of the Romish Church. At Brussels he disputed at the Jesuit College on the authentic character of modern miracles, and his inquiring and argumentative disposition more than once threatened to produce serious results, so that his patron at length requested him to abstain from further discussion. His devotional writings had attracted the notice of Henry, prince of Wales, who made him one of his chaplains (1608). In 1612 Lord Denny, afterwards earl of Norwich, gave him the curacy of Waltham-Holy-Cross, Essex, and in the same year he received the degree of D.D. Later he received the prebend of Willenhall in the collegiate church of Wolverhampton, and in 1616 he accompanied James Hay, Lord Doncaster, afterwards earl of Carlisle, to France, where he was sent to congratulate Louis XIII. on his marriage, but Hall was compelled by illness to return. In his absence the king nominated him dean of Worcester, and in 1617 he accompanied James to Scotland, where he defended the five points of ceremonial which the king desired to impose upon the Scots. In the next year he was one of the English

deputies at the synod of Dort. In 1624 he refused the see of Gloucester, but in 1627 became bishop of Exeter.

He took an active part in the Arminian and Calvinist controversy in the English church. He did his best in his *Via media, The Way of Peace*, to persuade the two parties to accept a compromise. In spite of his Calvinistic opinions he maintained that to acknowledge the errors which had arisen in the Catholic Church did not necessarily imply disbelief in her catholicity, and that the Church of England having repudiated these errors should not deny the claims of the Roman Catholic Church on that account. This view commended itself to Charles I. and his episcopal advisers, but at the same time Archbishop Laud sent spies into Hall's diocese to report on the Calvinistic tendencies of the bishop and his lenience to the Puritan and low-church clergy. Hall says he was thrice down on his knees to the King to answer Laud's accusations and at length threatened to "cast up his rochet" rather than submit to them. He was, however, amenable to criticism, and his defence of the English Church, entitled *Episcopacy by Divine Right* (1640), was twice revised at Laud's dictation. This was followed by *An Humble Remonstrance to the High Court of Parliament* (1640 and 1641), an eloquent and forceful defence of his order, which produced a retort from the syndicate of Puritan divines, who wrote under the name of "Smectymnus," and was followed by a long controversy to which Milton contributed five pamphlets, virulently attacking Hall and his early satires.

In 1641 Hall was translated to the see of Norwich, and in the same year sat on the Lords' Committee on religion. On the 30th of December he was, with other bishops, brought before the bar of the House of Lords to answer a charge of high treason of which the Commons had voted them guilty. They were finally convicted of an offence against the Statute of Praemunire, and condemned to forfeit their estates, receiving a small maintenance from the parliament. They were immured in the Tower from New Year to Whitsuntide, when they were released on finding bail for £5000 each. On his release Hall proceeded to his new diocese at Norwich, the revenues of which he seems for a time to have received, but in 1643, when the property of the "malignants" was sequestrated, Hall was mentioned by name. Mrs Hall had difficulty in securing a fifth of the maintenance (£400) assigned to the bishop by the parliament; they were eventually ejected from the palace, and the cathedral was dismantled. Hall retired to the village of Higham, near Norwich, where he spent the time preaching and writing until "he was first forbidden by man, and at last disabled by God." He bore his many troubles and the additional burden of much bodily suffering with sweetness and patience, dying on the 8th of September 1656. Thomas Fuller says: "He was commonly called our English Seneca, for the pureness, plainness, and fulness of his style. Not unhappy at *Controversies*, more happy at *Comments*, very good in his *Characters*, better in his *Sermons*, best of all in his *Meditations*."

Bishop Hall's polemical writings, although vigorous and effective, were chiefly of ephemeral interest, but many of his devotional writings have been often reprinted. It is by his early work as the censor of morals and the unsparring critic of contemporary literary extravagance and affectations that he is best known. *Virgidearum. Sixe Bookes. First three Bookes. Of Toothlesse Satyrs. (1) Poeticall, (2) Academicall, (3) Morall* (1597) was followed by an amended edition in 1598, and in the same year by *Virgidearum. The three last bookes. Of biting Satyres* (reprinted 1599). His claim to be reckoned the earliest English satirist, even in the formal sense, cannot be justified. Thomas Lodge, in his *Fig for Momus* (1593), had written four satires in the manner of Horace, and John Marston and John Donne both wrote satires about the same time, although the publication was in both cases later than that of *Virgidearum*. But if he was not the earliest, Hall was certainly one of the best. He writes in the heroic couplet, which he manoeuvres with great ease and smoothness. In the first book of his satires (*Poeticall*) he attacks the writers whose verses were devoted to licentious subjects, the bombast of *Tamburlaine* and tragedies built on similar lines, the laments of the ghosts of the *Mirror for Magistrates*, the metrical eccentricities of Gabriel Harvey and Richard Stanyhurst, the extravagances of the sonneteers, and the sacred poets (Southwell is aimed at in "Now good St Peter weepe pure Helicon, And both the Mary's make a music moan"). In Book II. Satire 6 occurs the well-

known description of the trencher-chaplain, who is tutor and hanger-on in a country manor. Among his other satirical portraits is that of the furnished gallant, the guest of "Duke Humphrey." Book VI. consists of one long satire on the various vices and follies denoted by in the earlier books. If his prose is sometimes antithetical and obscure, his verse is remarkably free from the quips and conceits which mar so much contemporary poetry.

He also wrote *The King's Prophecie; or Weeping Jery* (1603), a gratulatory poem on the accession of James I.; *Epistles*, both the first and second volumes of which appeared in 1608 and a third in 1611; *Characters of Virtues and Vices* (1608), versified by Nahum Tate (1691); *Solomons Divine Arts* . . . (1609); and, probably *Mundus alter et idem sive Terra Australis antehac semper incognita* . . . *lustrata* (1605? and 1607), by "Mercurius Britannicus," translated into English by John Healy (1608) as *The Discovery of a New World or A Description of the South Indies* . . . by an *English Mercury*. *Mundus alter* is an excuse for a satirical description of London, with some criticism of the Romish church, its manners and customs, and is said to have furnished Swift with hints for *Gulliver's Travels*. It was not ascribed to him by name until 1674, when Thomas Hyde, the librarian of the Bodleian, identified "Mercurius Britannicus" with Joseph Hall. For the question of the authorship of this pamphlet, and the arguments which may be advanced in favour of the suggestion that it was written by Alberico Gentili, see E. A. Petherick, *Mundus alter et idem*, reprinted from the *Gentleman's Magazine* (July 1896). His controversial writings, not already mentioned, include:—*A Common Apology* . . . against the Brownists (1610), in answer to John Robinson's *Censorious Epistle; The Olde Religion: A treatise, wherein is laid downe the true state of the difference betwixt the Reformed and the Romane Church; and the blame of this schisme is cast upon the true Authors* . . . (1628); *Columba Noas olivam adferens* . . . a sermon preached at St Paul's in 1623; *Episcopacie by Divine Right* (1640); *A Short Answer to the Vindication of Smectymnus* (1641); *A Modest Consultation of . . . (Milton's) Animadversions* (1642).

His devotional works include:—*Holy Observations Lib. I. Some few of David's Psalmes Metaphrased* (1607 and 1609); three centuries of *Meditations and Vowes, Divine and Morall* (1606, 1607, 1609), edited by Charles Sayle (1901); *The Arte of Divine Meditation* (1607); *Heaven upon Earth, or of True Peace and Tranquillitie of Mind* (1600), reprinted with some of his letters in John Wesley's *Christian Library*, vol. iv. (1810); *Occasional Meditations* . . . (1639), edited by his son Robert Hall; *Henochisme; or, Treatise shewing how to walk with God* (1639), translated from Bishop Hall's Latin by Moses Wall; *The Devout Soul; or Rules of Heavenly Devotion* (1644), often since reprinted; *The Balm of Gilead* . . . (1646, 1752); *Christ Mystical; or the blessed union of Christ and his Members* (1647), of which General Gordon was a student (reprinted from Gordon's copy, 1893); *Susurrum sum Deo* (1659); *The Great Mysterie of Godliness* (1659); *Resolutions and Decisions of Divers Practicall cases of Conscience* (1649, 1650, 1654).

AUTHORITIES.—The chief authority for Hall's biography is to be found in his autobiographical tracts: *Observations of some Specialities of Divine Providence in the Life of Joseph Hall, Bishop of Norwich, Written with his own hand; and his Hard Measure*, a reprint of which may be consulted in Dr Christopher Wordsworth's *Ecclesiastical Biography*. The best criticism of his satires is to be found in Thomas Warton's *History of English Poetry*, vol. iv. pp. 363-409 (ed. Hazitt, 1871), where a comparison is instituted between Marston and Hall. In 1615 Hall published *A Recollection of such treatises as have been . . . published* . . . (1615, 1617, 1621); in 1625 appeared his *Works* (reprinted 1627, 1628, 1634, 1682). The first complete *Works* appeared in 1808, edited by the Rev. Josiah Pratt. Other editions are by Peter Hall (1837) and by Philip Wynter (1863). See also *Bishop Hall, his Life and Times* (1826), by Rev. John Jones; *Life of Joseph Hall*, by Rev. George Lewis (1886); A. B. Grosart, *The Complete Poems of Joseph Hall . . . with introductions, &c.* (1879); *Satires, &c. (Early English Poets, ed. S. W. Singer, 1824)*. Many of Hall's works were translated into French, and some into Dutch, and there have been numerous selections from his devotional works.

HALL, MARSHALL (1790-1857), English physiologist, was born on the 18th of February 1790; at Basford, near Nottingham, where his father, Robert Hall, was a cotton manufacturer. Having attended the Rev. J. Blanchard's academy at Nottingham, he entered a chemist's shop at Newark, and in 1809 began to study medicine at Edinburgh University. In 1811 he was elected senior president of the Royal Medical Society; the following year he took the M.D. degree, and was immediately appointed resident house physician to the Royal Infirmary, Edinburgh. This appointment he resigned after two years when he visited Paris and its medical schools, and, on a walking

¹The tomb of Sir John Beauchamp (d. 1338) in old St Paul's was commonly known, in error, as that of Duke Humphrey of Gloucester. "To dine with Duke Humphrey" was to go hungry among the debtors and beggars who frequented "Duke Humphrey's Walk" in the cathedral.

tour, those also of Berlin and Göttingen. In 1817, when he settled at Nottingham, he published his *Diagnosis*, and in 1818 he wrote the *Mimosa*, a work on the affections denominated bilious, nervous, &c. The next year he was elected a fellow of the Royal Society of Edinburgh, and in 1825 he became physician to the Nottingham general hospital. In 1826 he removed to London, and in the following year he published his *Commentaries* on the more important diseases of females. In 1830 he issued his *Observations on Blood-letting, founded on researches on the morbid and curative effects of loss of blood*, which were acknowledged by the medical profession to be of vast practical value, and in 1831 his *Experimental Essay on the Circulation of the Blood in the Capillary Vessels*, in which he showed that the blood-channels intermediate between arteries and veins serve the office of bringing the fluid blood into contact with the material tissues of the system. In the following year he read before the Royal Society a paper "On the inverse ratio which subsists between Respiration and Irritability in the Animal Kingdom." His most important work in physiology was concerned with the theory of reflex action, embodied in a paper "On the reflex Function of the Medulla Oblongata and the Medulla Spinalis" (1832), which was supplemented in 1837 by another "On the True Spinal Marrow, and the Excito-motor System of Nerves." The "reflex function" excited great attention on the continent of Europe, though in England some of his papers were refused publication by the Royal Society. Hall thus became the authority on the multiform deranged states of health referable to an abnormal condition of the nervous system, and he gained a large practice. His "ready method" for resuscitation in drowning and other forms of suspended respiration has been the means of saving innumerable lives. He died at Brighton of a throat affection, aggravated by lecturing, on the 11th of August 1857.

A list of his works and details of his "ready method," &c., are given in his *Memoirs* by his widow (London, 1861).

HALL, ROBERT (1764-1831), English Baptist divine, was born on the 2nd of May 1764, at Arnesby near Leicester, where his father, Robert Hall (1728-1791), a man whose cast of mind in some respects resembled closely that of the son, was pastor of a Baptist congregation. Robert was the youngest of a family of fourteen. While still at the dame's school his passion for books absorbed the greater part of his time, and in the summer it was his custom after school hours to retire to the churchyard with a volume, which he continued to peruse there till nightfall, making out the meaning of the more difficult words with the help of a pocket dictionary. From his sixth to his eleventh year he attended the school of Mr Simmons at Wigston, a village four miles from Arnesby. There his precocity assumed the exceptional form of an intense interest in metaphysics, partly perhaps on account of the restricted character of his father's library; and before he was nine years of age he had read and re-read Jonathan Edwards's *Treatise on the Will* and Butler's *Analogy*. This incessant study at such an early period of life seems, however, to have had an injurious influence on his health. After he left Mr Simmons's school his appearance was so sickly as to awaken fears of the presence of phthisis. In order, therefore, to obtain the benefit of a change of air, he stayed for some time in the house of a gentleman near Kettering, who with an impropriety which Hall himself afterwards referred to as "egregious," prevailed upon the boy of eleven to give occasional addresses at prayer meetings. As his health seemed rapidly to recover, he was sent to a school at Northampton conducted by the Rev. John Ryland, where he remained a year and a half, and "made great progress in Latin and Greek." On leaving school he for some time studied divinity under the direction of his father, and in October 1778 he entered the Bristol academy for the preparation of students for the Baptist ministry. Here the self-possession which had enabled him in his twelfth year to address unfalteringly various audiences of grown-up people seems to have strangely forsaken him; for when, in accordance with the arrangements of the academy, his turn came to deliver an address in the vestry of Broadmead chapel, he broke down on

two separate occasions and was unable to finish his discourse. On the 13th of August 1780 he was set apart to the ministry, but he still continued his studies at the academy; and in 1781, in accordance with the provisions of an exhibition which he held, he entered King's College, Aberdeen, where he took the degree of master of arts in March 1785. At the university he was without a rival of his own standing in any of the classes, distinguishing himself alike in classics, philosophy and mathematics. He there formed the acquaintance of Mackintosh (afterwards Sir James), who, though a year his junior in age, was a year his senior as a student. While they remained at Aberdeen the two were inseparable, reading together the best Greek authors, especially Plato, and discussing, either during their walks by the sea-shore and the banks of the Don or in their rooms until early morning, the most perplexed questions in philosophy and religion.

During the vacation between his last two sessions at Aberdeen, Hall acted as assistant pastor to Dr Evans at Broadmead chapel, Bristol, and three months after leaving the university he was appointed classical tutor in the Bristol academy, an office which he held for more than five years. Even at this period his extraordinary eloquence had excited an interest beyond the bounds of the denomination to which he belonged, and when he preached the chapel was generally crowded to excess, the audience including many persons of intellectual tastes. Suspensions in regard to his orthodoxy having in 1789 led to a misunderstanding with his colleague and a part of the congregation, he in July 1790 accepted an invitation to make trial of a congregation at Cambridge, of which he became pastor in July of the following year. From a statement of his opinions contained in a letter to the congregation which he left, it would appear that, while a firm believer in the proper divinity of Christ, he had at this time disowned the cardinal principles of Calvinism—the federal headship of Adam, and the doctrine of absolute election and reprobation; and that he was so far a materialist as to "hold that man's thinking powers and faculties are the result of a certain organization of matter, and that after death he ceases to be conscious till the resurrection." It was during his Cambridge ministry; which extended over a period of fifteen years, that his oratory was most brilliant and most immediately powerful. At Cambridge the intellectual character of a large part of the audience supplied a stimulus which was wanting at Leicester and Bristol.

His first published compositions had a political origin. In 1791 appeared *Christianity consistent with the Love of Freedom*, in which he defended the political conduct of dissenters against the attacks of the Rev. John Clayton, minister of Weighhouse, and gave eloquent expression to his hopes of great political and social ameliorations as destined to result nearly or remotely from the subversion of old ideas and institutions in the maelstrom of the French Revolution. In 1793 he expounded his political sentiments in a powerful and more extended pamphlet entitled an *Apology for the Freedom of the Press*. On account, however, of certain asperities into which the warmth of his feelings had betrayed him, and his conviction that he had treated his subject in too superficial a manner, he refused to permit the publication of the pamphlet beyond the third edition, until the references of political opponents and the circulation of copies without his sanction induced him in 1821 to prepare a new edition, from which he omitted the attack on Bishop Horsley, and to which he prefixed an advertisement stating that his political opinions had undergone no substantial change. His other publications while at Cambridge were three sermons—*On Modern Infidelity* (1801), *Reflections on War* (1802), and *Sentiments proper to the present Crisis* (1803). He began, however, to suffer from mental derangement in November 1804. He recovered so speedily that he was able to resume his duties in April 1805, but a recurrence of the malady rendered it advisable for him on his second recovery to resign his pastoral office in March 1806.

On leaving Cambridge he paid a visit to his relatives in Leicestershire, and then for some time resided at Enderby, preaching occasionally in some of the neighbouring villages.

Latterly he ministered to a small congregation in Harvey Lane, Leicester, from whom at the close of 1806 he accepted a call to be their stated pastor. In the autumn of 1807 he changed his residence from Enderby to Leicester, and in 1808 he married the servant of a brother minister. His proposal of marriage had been made after an almost momentary acquaintance, and, according to the traditionary account, in very abrupt and peculiar terms; but, judging from his subsequent domestic life, his choice did sufficient credit to his penetration and sagacity. His writings at Leicester embraced various tracts printed for private circulation; a number of contributions to the *Eclectic Review*, among which may be mentioned his articles on "Foster's Essays" and on "Zeal without Innovation"; several sermons, including those *On the Advantages of Knowledge to the Lower Classes* (1810), *On the Death of the Princess Charlotte* (1817), and *On the Death of Dr Ryland* (1825); and his pamphlet on *Terms of Communion*, in which he advocated intercommunion with all those who acknowledged the "essentials" of Christianity. In 1819 he published an edition in one volume of his sermons formerly printed. On the death of Dr Ryland, Hall was invited to return to the pastorate of Broadmead chapel, Bristol, and as the peace of the congregation at Leicester had been to some degree disturbed by a controversy regarding several cases of discipline, he resolved to accept the invitation, and removed there in April 1826. The malady of renal calculus had for many years rendered his life an almost continual martyrdom, and henceforth increasing infirmities and sufferings afflicted him. Gradually the inability to take proper exercise, by inducing a plethoric habit of body and impeding the circulation, led to a diseased condition of the heart, which resulted in his death on the 21st of February 1831. He is remembered as a great pulpit orator, of a somewhat laboured, rhetorical style in his written works, but of undeniable vigour in his spoken sermons.

See *Works of Robert Hall, A.M., with a Brief Memoir of his Life, by Olinthus Gregory, LL.D., and Observations on his Character as Preacher by John Foster*, originally published in 6 vols. (London, 1832); *Reminiscences of the Rev. Robert Hall, A.M.*, by John Greene (London, 1832); *Biographical Recollections of the Rev. Robert Hall*, by J. W. Morris (1848); *Fifty Sermons of Robert Hall from Notes taken at the time of their Delivery*, by the Rev. Thomas Grinfield, M.A. (1843); *Reminiscences of College Life in Bristol during the Ministry of the Rev. Robert Hall, A.M.*, by Frederick Treasail (1879).

HALL, SAMUEL CARTER (1800-1889), English journalist, was born at Waterford on the 9th of May 1800, the son of an army officer. In 1821 he went to London, and in 1823 became a parliamentary reporter. From 1826 to 1837 he was editor of a great number and variety of public prints, and in 1839 he founded and edited *The Art Journal*. His exposure of the trade in bogus "Old Masters" earned for this publication a considerable reputation. Hall resigned the editorship in 1880, and was granted a Civil List pension "for his long and valuable services to literature and art." He died in London on the 16th of March 1889. His wife, Anna Maria Fielding (1800-1881), became well known as Mrs S. C. Hall, for her numerous novels, sketches of Irish life, and plays. Two of the last, *The Groves of Blarney* and *The French Refugees*, were produced in London with success. She also wrote a number of children's books, and was practically interested in various London charities, several of which she helped to found.

HALL, WILLIAM EDWARD (1835-1894), English writer on international law, was the only child of William Hall, M.D., a descendant of a junior branch of the Halls of Dunglass, and of Charlotte, daughter of William Cotton, F.S.A. He was born on the 22nd of August 1835, at Leatherhead, Surrey, but passed his childhood abroad, Dr Hall having acted as physician to the king of Hanover, and subsequently to the British legation at Naples. Hence, perhaps, the son's taste in after life for art and modern languages. He was educated privately till, at the early age of seventeen, he matriculated at Oxford, where in 1856 he took his degree with a first class in the then recently instituted school of law and history, gaining, three years afterwards, the chancellor's prize for an essay upon "the effect upon Spain of the discovery of the precious metals in America." In 1861 he was

called to the bar at Lincoln's Inn, but devoted his time less to any serious attempt to obtain practice than to the study of Italian art, and to travelling over a great part of Europe, always bringing home admirable water-colour drawings of buildings and scenery. He was an early and enthusiastic member of the Alpine Club, making several first ascents, notably that of the Lysekamm. He was always much interested in military matters, and was under fire, on the Danish side, in the war of 1864. In 1867 he published a pamphlet entitled "A Plan for the Reorganization of the Army," and, many years afterwards, he saw as much as he was permitted to see of the expedition sent for the rescue of Gordon. He would undoubtedly have made his mark in the army, but in later life his ideal, which he realized, with much success, first at Llanfihangel in Monmouthshire, and then at Coker Court in Somersetshire, was, as has been said, "the English country gentleman, with cosmopolitan experiences, encyclopaedic knowledge, and artistic feeling." His travels took him to Lapland, Egypt, South America and India. He had done good work for several government offices, in 1871 as inspector of returns under the Elementary Education Act, in 1877 by reports to the Board of Trade upon Oyster Fisheries, in France as well as in England; and all the time was amassing materials for ambitious undertakings upon the history of civilisation, and of the colonies. His title to lasting remembrance rests, however, upon his labours in the realm of international law, recognized by his election as *associé* in 1875, and as *membre* in 1882, of the *Institut de Droit International*. In 1874 he published a thin 8vo upon the *Rights and Duties of Neutrals*, and followed it up in 1880 by his *magnum opus*, the *Treatise on International Law*, unquestionably the best book upon the subject in the English language. It is well planned, free from the rhetorical vagueness which has been the besetting vice of older books of a similar character, full of information, and everywhere bearing traces of the sound judgment and statesmanlike views of its author. In 1894 Hall published a useful monograph upon a little-explored topic, "the Foreign Jurisdictions of the British Crown," but on the 30th of November of the same year, while apparently in the fullest enjoyment of bodily as well as mental vigour, he suddenly died. He married, in 1866, Imogen, daughter of Mr (afterwards Mr Justice) Grove, who died in 1886; and in 1891, Alice, daughter of Colonel Hill of Court Hill, Shropshire, but left no issue.

See T. E. Holland in *Law Quarterly Review*, vol. xi. p. 113; and in *Studies in International Law*, p. 302. (T. E. H.)

HALL, or **BAD-HALL**, a market-place and spa of Austria, in Upper Austria, 25 m. S. of Linz by rail. Pop. (1900) 984. It is renowned for its saline springs, strongly impregnated with iodine and bromine, which are considered very efficacious in scrofulous affections and venereal skin diseases. Although the springs are known since the 8th century, Hall attained its actual importance only since 1855, when the springs became the property of the government. The number of visitors in 1901 was 4300.

HALL (generally known as **SCRWBÄRSCH-HALL**, to distinguish it from the small town of Hall in Tirol and Bad-Hall, a health resort in Upper Austria), a town of Germany, in the kingdom of Württemberg, situated in a deep valley on both sides of the Kocher, and on the railway from Heilbronn to Krailsheim, 35 m. N.E. of Stuttgart. Pop. (1905) 9400. It possesses four Evangelical churches (of which the Michaeliskirche dates from the 15th century and has fine medieval carving), a Roman Catholic church, a handsome town hall and classical and modern schools. A short distance south from the town is the royal castle of Korb, formerly a Benedictine abbey and now used as a garrison for invalid soldiers, with a church dating from the 12th century. The town is chiefly known for its production of salt, which is converted into brine and piped from Wilhelmsglück mine, 5 m. distant. Connected with the salt-works there is a salt-bath and whey-diet establishment. The industries of the town also include cotton-spinning, iron founding, tanning, and the manufacture of soap, starch, brushes, machines, carriages and metal ware.

Hall was early of importance on account of its salt-mines, which were held as a fief of the Empire by the so-called *Salsgrafen* (Salt-graves), of whom the earliest known, the counts of Westheim, had their seat in the castle of Hall. Later the town belonged to the Knights Templars. It was made a free imperial city in 1276 by Rudolph of Habsburg. In 1802 it came into the possession of Württemberg.

HALL (O.E. *heall*, a common Teutonic word, cf. Ger. *Halle*), a term which has two significations in England and is applied sometimes to the manor house, the residence of the lord of the manor, which implied a territorial possession, but more often to the entrance hall of a mansion. In the latter case it was the one large room in the feudal castle up to the middle of the 15th century, when it served as audience chamber, dining-room, and dormitory. The hall was generally a parallelogram on plan, with a raised dais at the farther end, a large bow window on one side, and in one or two cases on both sides. At the entrance end was a passage, which was separated from the hall by a partition screen often elaborately decorated, and over which was provided a minstrel's gallery; on the opposite side of the passage were the hatches communicating with the servery. This arrangement is still found in some of the colleges at Oxford and Cambridge, such as those of New College, Christchurch, Wadham and Magdalen, Oxford, and in Trinity College, Cambridge. In private mansions, however, the kitchen and offices have been removed to a greater distance, and the great hall is only used for banquets. Among the more remarkable examples are the halls of Audley End; Hatfield; Brougham Castle; Hardwick; Knole Stanway in Gloucestershire; Wollaton, where it is situated in the centre of the mansion and lighted by clerestory windows; Burton Agnes in Yorkshire; Canons Ashley, Northamptonshire; Westwood Park, Worcestershire; Fountains, Yorkshire; Sydenham House, Devonshire; Cobham, Kent; Montacute, Somersetshire; Bolsover Castle, Derbyshire (vaulted and with two columns in the centre of the hall to carry the vault); Longford Castle, Wiltshire; Barlborough, Derbyshire; Rushton Hall, Northamptonshire, with a bow window at each end of the dais and a third bow window at the other end; Knole, Kent; and at Mayfield, Sussex (with stone arches across to carry the roof), now converted into a Roman Catholic chapel. Many of these halls have hammer-beam roofs, the most remarkable of which is found in the Middle Temple Hall, London, where both the tie and collar beams have hammer-beams. Of other halls, Westminster is the largest, being 238 ft. long; followed by the Banqueting Hall, Whitehall, 110 ft; Wolsley's Hall, Hampton Court, 106 ft; the Egyptian Hall at the Mansion House; the hall at Lambeth, now the library; Crosby Hall; Gray's Inn Hall; the Guildhall; Charterhouse; and the following halls of the London City Companies—Clothworkers, Brewers, Goldsmiths, Fishmongers. The term hall is also given to the following English mansions:—Haddon, Hardwick, Apethorpe, Aston, Blickling, Brereton, Burton Agnes, Cobham, Dingley, Rushton, Kirby, Littford and Wollaton; and it was the name of some of the earlier colleges at Oxford and Cambridge, most of which have now been absorbed in other colleges, so that there remain only St Edmund's Hall, Oxford, and Trinity Hall, Cambridge.

HALLAM, HENRY (1777–1850), English historian, was the only son of John Hallam, canon of Windsor and dean of Bristol, and was born on the 9th of July 1777. He was educated at Eton and Christ Church, Oxford, where he graduated in 1799. Called to the bar, he practised for some years on the Oxford circuit; but his tastes were literary, and when, on the death of his father in 1812, he inherited a small estate in Lincolnshire, he gave himself up wholly to the studies of his life. He had early become connected with the brilliant band of authors and politicians who then led the Whig party, a connexion to which he owed his appointment to the well-paid and easy post of commissioner of stamps; but in practical politics, for which he was by nature unsuited, he took no active share. But he was an active supporter of many popular movements—particularly of that which ended in the abolition of the slave trade; and he was throughout

his entire life sincerely and profoundly attached to the political principles of the Whigs, both in their popular and in their aristocratic aspect.

Hallam's earliest literary work was undertaken in connexion with the great organ of the Whig party, the *Edinburgh Review*, where his review of Scott's *Dryden* attracted much notice. His first great work, *The View of the State of Europe during the Middle Ages*, was produced in 1818, and was followed nine years later by the *Constitutional History of England*. In 1838–1839 appeared the *Introduction to the Literature of Europe in the 15th, 16th and 17th Centuries*. These are the three works on which the fame of Hallam rests. They at once took a place in English literature which has never been seriously challenged. A volume of supplemental notes to his *Middle Ages* was published in 1848. These facts and dates represent nearly all the events of Hallam's career. The strongest personal interest in his life was the affliction which befell him in the loss of his children, one after another. His eldest son, Arthur Henry Hallam,—the "A.H.H." of Tennyson's *In Memoriam*, and by the testimony of his contemporaries a man of the most brilliant promise,—died in 1833 at the age of twenty-two. Seventeen years later, his second son, Henry Fitzmaurice Hallam, was cut off like his brother at the very threshold of what might have been a great career. The premature death and high talents of these young men, and the association of one of them with the most popular poem of the age, have made Hallam's family afflictions better known than any other incidents of his life. He survived wife, daughter and sons by many years. In 1834 Hallam published *The Remains in Prose and Verse of Arthur Henry Hallam, with a Sketch of his Life*. In 1852 a selection of *Literary Essays and Characters from the Literature of Europe* was published. Hallam was a fellow of the Royal Society, and a trustee of the British Museum, and enjoyed many other appropriate distinctions. In 1830 he received the gold medal for history, founded by George IV. He died on the 21st of January 1850.

The *Middle Ages* is described by Hallam himself as a series of historical dissertations, a comprehensive survey of the chief circumstances that can interest a philosophical inquirer during the period from the 5th to the 15th century. The work consists of nine long chapters, each of which is a complete treatise in itself. The history of France, of Italy, of Spain, of Germany, and of the Greek and Saracenic empires, sketched in rapid and general terms, is the subject of five separate chapters. Others deal with the great institutional features of medieval society—the development of the feudal system, of the ecclesiastical system, and of the free political system of England. The last chapter sketches the general state of society, the growth of commerce, manners, and literature in the middle ages. The book may be regarded as a general view of early modern history, preparatory to the more detailed treatment of special lines of inquiry carried out in his subsequent works, although Hallam's original intention was to continue the work on the scale on which it had been begun.

The *Constitutional History of England* takes up the subject at the point at which it had been dropped in the *View of the Middle Ages*, viz. the accession of Henry VII.,¹ and carries it down to the accession of George III. Hallam stopped here for a characteristic reason, which it is impossible not to respect and to regret. He was unwilling to excite the prejudices of modern politics which seemed to him to run back through the whole period of the reign of George III. As a matter of fact they ran back much farther, as Hallam soon found. The sensitive impartiality which withheld him from touching perhaps the most interesting period in the history of the constitution did not save him from the charge of partisanship. The *Quarterly Review* for 1828 contains an article on the *Constitutional History*, written by Southey, full of railing and reproach. The work, he says, is the "production of a decided partisan," who "rakes in the ashes of long-forgotten and a thousand times buried slanders,

¹ Lord Brougham, overlooking the constitutional chapter in the *Middle Ages*, censured Hallam for making an arbitrary beginning at this point, and proposed to write a more complete history himself.

for the means of heaping obloquy on all who supported the established institutions of the country." No accusation made by a critic ever fell so wide of the mark. Absolute justice is the standard which Hallam set himself and maintained. His view of constitutional history was that it should contain only so much of the political and general history of the time as bears directly on specific changes in the organization of the state, including therein judicial as well as ecclesiastical institutions. But while abstaining from irrelevant historical discussions, Hallam dealt with statesmen and policies with the calm and fearless impartiality of a judge. It was his cool treatment of such sanctified names as Charles, Cranmer and Laud that provoked the indignation of Southey and the *Quarterly*, who forgot that the same impartial measure was extended to statesmen on the other side. If Hallam can ever be said to have deviated from perfect fairness, it was in the tacit assumption that the 19th-century theory of the constitution was the right theory in previous centuries, and that those who departed from it on one side or the other were in the wrong. He did unconsciously antedate the constitution, and it is clear from incidental allusions in his last work that he did not regard with favour the democratic changes which he thought to be impending. Hallam, like Macaulay, ultimately referred all political questions to the standard of Whig constitutionalism. But though his work is thus, like that of many historians, coloured by his opinions, this was not the outcome of a conscious purpose, and he was scrupulously conscientious in collecting and weighing his materials. In this he was helped by his legal training, and it was doubtless this fact which made the *Constitutional History* one of the text-books of English politics, to which men of all parties appealed, and which, in spite of all the work of later writers, still leaves it a standard authority.

Like the *Constitutional History*, the *Introduction to the Literature of Europe* continues one of the branches of inquiry which had been opened in the *View of the Middle Ages*. In the first chapter of the *Literature*, which is to a great extent supplementary to the last chapter of the *Middle Ages*, Hallam sketches the state of literature in Europe down to the end of the 14th century: the extinction of ancient learning which followed the fall of the Roman empire and the rise of Christianity; the preservation of the Latin language in the services of the church; and the slow revival of letters, which began to show itself soon after the 7th century—"the *œdific* of the human mind"—had been passed. For the first century and a half of his special period he is mainly occupied with a review of classical learning, and he adopts the plan of taking short decennial periods and noticing the most remarkable works which they produced. The rapid growth of literature in the 16th century compels him to resort to a classification of subjects. Thus in the period 1520-1550 we have separate chapters on ancient literature, theology, speculative philosophy and jurisprudence, the literature of taste, and scientific and miscellaneous literature; and the subdivisions of subjects is carried further of course in the later periods. Thus poetry, the drama and polite literature form the subjects of separate chapters. One inconvenient result of this arrangement is that the same author is scattered over many chapters, according as his works fall within this category or that period of time. Names like Shakespeare, Grotius, Bacon, Hobbes appear in half a dozen different places. The individuality of great authors is thus dissipated except when it has been preserved by an occasional sacrifice of the arrangement—and this defect, if it is to be esteemed a defect, is increased by the very sparing references to personal history and character with which Hallam was obliged to content himself. His plan excluded biographical history, nor is the work, he tells us, to be regarded as one of reference. It is rigidly an account of the books which would make a complete library of the period,¹ arranged according to the date of their publication and the nature of their subjects. The history of institutions like universities and academies, and that of great popular movements like the Reformation, are of course

¹ Technical subjects like painting or English law have been excluded by Hallam, and history and theology only partially treated.

noticed in their immediate connexion with literary results; but Hallam had little taste for the spacious generalization which such subjects suggest. The great qualities displayed in this work have been universally acknowledged—conscientiousness, accuracy, judgment and enormous reading. Not the least striking testimony to Hallam's powers is his mastery over so many diverse forms of intellectual activity. In science and theology, mathematics and poetry, metaphysics and law, he is a competent and always a fair if not a profound critic. The bent of his own mind is manifest in his treatment of pure literature and of political speculation—which seems to be inspired with stronger personal interest and a higher sense of power than other parts of his work display. Not less worthy of notice in a literary history is the good sense by which both his learning and his tastes have been held in control. Probably no writer ever possessed a juster view of the relative importance of men and things. The labour devoted to an investigation is with Hallam no excuse for dwelling on the result, unless that is in itself important. He turns away contemptuously from the mere curiosities of literature, and is never tempted to make a display of trivial erudition. Nor do we find that his interest in special studies leads him to assign them a disproportionate place in his general view of the literature of a period.

Hallam is generally described as a "philosophical historian." The description is justified not so much by any philosophical quality in his method as by the nature of his subject and his own temper. Hallam is a philosopher to this extent that both in political and in literary history he fixed his attention on results rather than on persons. His conception of history embraced the whole movement of society. Beside that conception the issue of battles and the fate of kings fall into comparative insignificance. "We can trace the pedigree of princes," he reflects, "fill up the catalogue of towns besieged and provinces desolated, describe even the whole pageantry of coronations and festivals, but we cannot recover the genuine history of mankind." But, on the other hand, there is no trace in Hallam of anything like a philosophy of history or society. Wise and generally melancholy reflections on human nature and political society are not infrequent in his writings, and they arise naturally and incidentally out of the subject he is discussing. His object is the attainment of truth in matters of fact. Sweeping theories of the movement of society, and broad characterizations of particular periods of history seem to have no attraction for him. The view of mankind on which such generalizations are usually based, taking little account of individual character, was highly distasteful to him. Thus he objects to the use of statistics because they favour that tendency to regard all men as mentally and morally equal which is so unhappily strong in modern times. At the same time Hallam by no means assumes the tone of the mere scholar. He is even solicitous to show that his point of view is that of the cultivated gentleman and not of the specialist of any order. Thus he tells us that Montaigne is the first French author whom an English gentleman is ashamed not to have read. In fact, allusions to the necessary studies of a gentleman meet us constantly, reminding us of the unlikely erudition of the schoolboy in Macaulay. Hallam's prejudices, so far as he had any, belong to the same character. His criticism is apt to assume a tone of moral censure when he has to deal with certain extremes of human thought—scepticism in philosophy, atheism in religion and democracy in politics.

Hallam's style is singularly uniform throughout all his writings. It is sincere and straightforward, and obviously innocent of any motive beyond that of clearly expressing the writer's meaning. In the *Literature of Europe* there are many passages of great imaginative beauty. (E. R.)

HALLAM, ROBERT (d. 1417), bishop of Salisbury and English representative at the council of Constance, was educated at Oxford, and was chancellor of the university from 1403 to 1405. In the latter year the pope nominated him to be archbishop of York, but the king objected. However, in 1407 he was consecrated by Gregory XII. at Siena as bishop of Salisbury. At the council of Pisa in 1409 he was one of the English

representatives. On the 6th of June 1412 Pope John XXIII. made Hallam a cardinal, but there was some irregularity, and his title was not recognized. At the council of Constance (q.v.), which met in November 1414, Hallam was the chief English envoy. There he at once took a prominent position, as an advocate of the cause of Church reform, and of the superiority of the council to the pope. In the discussions which led up to the deposition of John XXIII. on the 29th of May 1415 he had a leading share. With the trials of John Hus and Jerome of Prague he had less concern. The emperor Sigismund, through whose influence the council had been assembled, was absent during the whole of 1416 on a diplomatic mission in France and England; but when he returned to Constance in January 1417, as the open ally of the English king, Hallam as Henry's trusted representative obtained increased importance. Hallam contrived skillfully to emphasize English prestige by delivering the address of welcome to Sigismund on his formal reception. Afterwards, under his master's direction, he gave the emperor vigorous support in the endeavour to secure a reform of the Church, before the council proceeded to the election of a new pope. This matter was still undecided when Hallam died suddenly, on the 4th of September 1417. After his death the direction of the English nation fell into less skilful hands, with the result that the cardinals were able to secure the immediate election of a new pope (Martin V., elected on the 11th of November). It has been supposed that the abandonment of the reformers by the English was due entirely to Hallam's death; but it is more likely that Henry V., foreseeing the possible need for a change of front, had given Hallam discretionary powers which the bishop's successors used with too little judgment. Hallam himself, who had the confidence of Sigismund and was generally respected for his straightforward independence, might have achieved a better result. Hallam was buried in the cathedral at Constance, where his tomb near the high altar is marked by a brass of English workmanship.

For the acts of the council of Constance see H. von der Harte's *Concilium Constantiense*, and H. Finke's *Acta concilii Constantiensis*. For a modern account see Mandell Creighton's *History of the Papacy* (6 vols., London, 1897).

HALLÉ, SIR CHARLES (originally KARL HALLE) (1819-1895), English pianist and conductor, German by nationality, was born at Hagen, in Westphalia, on the 11th of April 1819. He studied under Rink at Darmstadt in 1835, and as early as 1836 went to Paris, where for twelve years he lived in constant intercourse with Cherubini, Chopin, Liszt and other musicians, and enjoyed the friendship of such great literary figures as Alfred de Musset and George Sand. He had started a set of chamber concerts with Alard and Francomme with great success, and had completed one series of them when the revolution of 1848 drove him from Paris, and he settled, with his wife and two children, in London. His pianoforte recitals, given at first from 1850 in his own house, and from 1861 in St James's Hall, were an important feature of London musical life, and it was due in great measure to them that a knowledge of Beethoven's pianoforte sonatas became general in English society. At the Musical Union founded by John Ella, and at the Popular Concerts from their beginning, Hallé was a frequent performer, and from 1853 was director of the Gentlemen's Concerts in Manchester, where, in 1857, he started a series of concerts of his own, raising the orchestra to a pitch of perfection quite unknown at that time in England. In 1888 he married Madame Norman Neruda (b. 1830), the violinist, widow of Ludwig Norman, and daughter of Josef Neruda, members of whose family had long been famous for musical talent. In the same year he was knighted; and in 1890 and 1891 he toured with his wife in Australia and elsewhere. He died at Manchester on the 25th of October 1895. Hallé exercised an important influence in the musical education of England; if his pianoforte-playing, by which he was mainly known to the public in London, seemed remarkable rather for precision than for depth, for crystal clearness rather than for warmth, and for perfect realization of the written text rather than for strong individuality, it was at least of immense value

as giving the composer's idea with the utmost fidelity. Those who were privileged to hear him play in private, like those who could appreciate the power, beauty and imaginative warmth of his conducting, would have given a very different verdict; and they were not wrong in judging Hallé to be a man of the widest and keenest artistic sympathies, with an extraordinary gift of insight into music of every school, as well as a strong sense of humour. He fought a long and arduous battle for the best music, and never forgot the dignity of his art. In spite of the fact that his technique was that of his youth, of the period before Liszt, the ease and certainty he attained in the most modern music was not the less wonderful because he concealed the mechanical means so completely.

Lady Hallé, who from 1864 onwards had been one of the leading solo violinists of the time, was constantly associated with her husband on the concert stage till his death; and in 1896 a public subscription was organized in her behalf, under royal patronage. She continued to appear occasionally in public, notably as late as 1907, when she played at the Joachim memorial concert. In 1901 she was given by Queen Alexandra the title of "violinist to the queen." A fine classical player and artist, frequently associated with Joachim, Lady Hallé was the first of the women violinists who could stand comparison with men.

HALLE (known as HALLE-AN-DEE-SAALE, to distinguish it from the small town of Halle in Westphalia), a town of Germany, in the Prussian province of Saxony, situated in a sandy plain on the right bank of the Saale, which here divides into several arms, 21 m. N.W. from Leipzig by the railway to Magdeburg. Pop. (1875), 60,503; (1885) 81,982; (1895) 116,304; (1905) 160,031. Owing to its situation at the junction of six important lines of railway, bringing it into direct communication with Berlin, Breslau, Leipzig, Frankfurt-on-Main, the Harz country and Hanover, it has greatly developed in size and in commercial and industrial importance. It consists of the old, or inner, town surrounded by promenades, which occupy the site of the former fortifications, and beyond these of two small towns, Glaucha in the south and Neumarkt in the north, and five rapidly increasing suburbs. The inner town is irregularly built and presents a somewhat unattractive appearance, but it has been much improved and modernized by the laying out of new streets.

The centre of the town proper is occupied by the imposing market square, on which stand the fine mediæval town hall (restored in 1883) and the handsome Gothic Marienkirche, dating mainly from the 16th century, with two towers connected by a bridge. In the middle of the square are a clock-tower (*Der rote Turm*) 276 ft. in height, and a bronze statue of Handel, the composer, a native of Halle. West of the market-square lies the Halle, or the Tal, where the brine springs (see below) issue. Among the eleven churches, nine Protestant and two Roman Catholic, may also be mentioned the St Moritzkirche, dating from the 12th century, with fine wood carvings and sculptures, and the cathedral (belonging since 1689 to the Reformed or Calvinistic church), built in the 16th century and containing an altar-piece representing Duke Augustus of Saxony and his family. Of secular buildings the most noticeable are the ruins of the castle of Moritzburg, formerly a citadel and the residence of the archbishops of Magdeburg, destroyed by fire in the Thirty Years' War, with the exception of the left wing now used for military purposes, the university buildings, the theatre and the new railway station. The famous university was founded by the elector Frederick III. of Brandenburg (afterwards king of Prussia), in 1694, on behalf of the jurist, Christian Thomasius (1655-1728), whom many students followed to Halle, when he was expelled from Leipzig through the enmity of his fellow professors. It was closed by Napoleon in 1806 and again in 1813, but in 1815 was re-established and augmented by the removal to it of the university of Wittenberg, with which it thus became united. It has faculties of theology, law, medicine and philosophy. From the first it has been recognized as one of the principal seats of Protestant theology, originally of the pietistic and latterly of the rationalistic and critical school. In connexion with the university there are a botanical garden, a theological seminary,

anatomical, pathological and physical institutes, hospitals, an agricultural institute—one of the foremost institutions of the kind in Germany—a meteorological institute, an observatory and a library of 180,000 printed volumes and 800 manuscripts. Among other educational establishments must be mentioned the Francke'sche Stiftungen, founded in 1691 by August Hermann Francke (1663-1727), a bronze statue of whom by Rauch was erected in 1829 in the inner court of the building. They embrace an orphanage, a laboratory where medicines are prepared and distributed, a Bible press from which Bibles are issued at a cheap rate, and eight schools of various grades, attended in all by over 3000 pupils. The other principal institutions are the city gymnasium, the provincial lunatic asylum, the prison, the town hospital and infirmary, and the deaf and dumb institute. The salt-springs of Halle have been known from a very early period. Some rise within the town and others on an island in the Saale; and together their annual yield of salt is about 8500 tons.

The workmen employed at the salt-works are of a peculiar race and are known as the *Halloren*. They have been usually regarded as descendants of the original Wendish inhabitants, or as Celtic immigrants, with an admixture of Frankish elements. They wear a distinct dress, the ordinary costume of about 1700, observe several ancient customs, and enjoy certain exemptions and privileges derived from those of the ancient *Pfannerschaft* (community of the salt-panners).

Among the other industries of Halle are sugar refining, machine building, the manufacture of spirits, malt, chocolate, cocoa, confectionery, cement, paper, chicory, lubricating and illuminating oil, wagon grease, carriages and playing cards, printing, dyeing and coal mining (soft brown coal). The trade, which is supervised by a chamber of commerce, is very considerable, the principal exports being machinery, raw sugar and petroleum. Halle is also noted as the seat of several important publishing firms. The Bibelanstalt (Bible institution) of von Castein is the central authority for the revision of Luther's Bible, of which it sells annually from 60,000 to 70,000 copies.

Halle is first mentioned as a fortress erected on the Saale in 806 by Charles, son of Charlemagne, during his expedition against the Sorbs. The place was, however, known long before, and owes its origin as well as its name to the salt springs (*Halis*). In 968 Halle, with the valuable salt works, was given by the emperor Otto I. to the newly founded archdiocese of Magdeburg, and in 981 Otto II. gave it a charter as a town. The interests of the archbishop were watched over by a *Vogt* (*advocatus*) and a burgrave, and from the first there were separate jurisdictions for the *Halloren* and the German settlers in the town, the former being under that of the *Salzgraf* (*comes salis*), the latter of a *Schultheiss* or bailiff, both subordinate to the burgrave. The conflict of interests and jurisdictions led to the usual internecine strife during the middle ages. The panners (*Pfanner*) of the Tal, feudatories or officials, became a close hereditary aristocracy in perpetual rivalry with the gilds in the town; and both resisted the pretensions of the archbishops. At the beginning of the 12th century Halle had attained considerable importance, and in the 13th and 14th centuries as a member of the Hanseatic League it carried on successful wars with the archbishops of Magdeburg; and in 1435 it resisted an army of 30,000 men under the elector of Saxony. Its liberty perished, however, as a result of the internal feud between the democratic gilds and the patrician panners. On the 20th of September 1478 a demagogue and cobbler named Jakob Weisak, a member of the town council, with his confederates opened the gates to the soldiers of the archbishop. The townsmen were subdued, and to hold them in check the archbishop, Ernest of Saxony, built the castle of Moritzburg. Notwithstanding the efforts of the archbishops of Mainz and Magdeburg, the Reformation found an entrance into the city in 1522; and in 1541 a Lutheran superintendent was appointed. After the peace of Westphalia in 1648 the city came into the possession of the house of Brandenburg. In 1806 it was stormed and taken by the French, after which, at the peace of Tilsit, it was united to the new kingdom of Westphalia. After the battle between the Prussians and French, in May 1813, it was taken by the Prussians. The rise of Leipzig was for a long time hurtful to the prosperity of Halle, and its present rapid increase in population and trade is principally due to its position as the centre of a network of railways.

See Dreyhaupt, *Ausführliche Beschreibung des Saalkreises* (Halle, 2 vols., 1755; 3rd edition, 1842-1844); Hoffbauer, *Geschichte der Universität zu Halle* (1806); Halle in *Vorseit und Gegenwart* (1851); Knauth, *Kurse Geschichte und Beschreibung der Stadt Halle* (3rd ed., 1861); vom Hagen, *Die Stadt Halle* (1866-1867); Hertzberg,

Geschichte der Vereinigung der Universitäten von Wittenberg und Halle (1867); Voss, *Zur Geschichte der Autonomie der Stadt Halle* (1874); Schrader, *Geschichte der Friedrichs-Universität zu Halle* (Berlin, 1894); Karl Hegel, *Städte und Gilden der germanischen Völker* (Leipzig, 1891), ii. 444-449.

HALLECK, FITZ-GREENE (1790-1867), American poet, was born at Guilford, Connecticut, on the 8th of July 1790. By his mother he was descended from John Eliot, the "Apostle to the Indians." At an early age he became clerk in a store at Guilford, and in 1811 he entered a banking-house in New York. Having made the acquaintance of Joseph Rodman Drake, in 1819 he assisted him under the signature of "Croaker junior" in contributing to the *New York Evening Post* the humorous series of "Croaker Papers." In 1821 he published his longest poem, *Fanny*, a satire on local politics and fashions in the measure of Byron's *Don Juan*. He visited Europe in 1822-1823, and after his return published anonymously in 1827 *Alnwick Castle, with other Poems*. From 1832 to 1841 he was confidential agent of John Jacob Astor, who named him one of the trustees of the Astor library. In 1864 he published in the *New York Ledger* a poem of 300 lines entitled "Young America." He died at Guilford, on the 19th of November 1867. The poems of Halleck are written with great care and finish, and manifest the possession of a fine sense of harmony and of genial and elevated sentiments.

His *Life and Letters*, by James Grant Wilson, appeared in 1860. His *Poetical Writings*, together with extracts from those of Joseph Rodman Drake, were edited by Wilson in the same year.

HALLECK, HENRY WAGER (1815-1872), American general and jurist, was born at Westerville, Onondaga county, N.Y., in 1815, entered the West Point military academy at the age of twenty, and on graduating in 1839 was appointed to the engineers, becoming at the same time assistant professor of engineering at the academy. In the following year he was made an assistant to the Board of Engineers at Washington, from 1841 to 1846 he was employed on the defence works at New York, and in 1845 he was sent by the government to visit the principal military establishments of Europe. After his return, Halleck delivered a course of lectures on the science of war, published in 1846 under the title *Elements of Military Art and Science*. A later edition of this work was widely used as a text-book by volunteer officers during the Civil War. On the outbreak of the Mexican War in 1846, he served with the expedition to California and the Pacific coast, in which he distinguished himself not only as an engineer, but by his skill in civil-administration and by his good conduct before the enemy. He served for several years in California as a staff officer, and as secretary of state under the military government, and in 1849 he helped to frame the state constitution of California, on its being admitted into the Union. In 1852 he was appointed inspector and engineer of lighthouses, and in 1853 was employed in the fortification of the Pacific coast. In 1854 Captain Halleck resigned his commission and took up the practice of law with great success. He was also director of a quicksilver mine, and in 1855 he became president of the Pacific & Atlantic railway. On the outbreak of the Civil War he returned to the army as a major-general, and in November 1861 he was charged with the supreme command in the western theatre of war. There can be no question that his administrative skill was mainly instrumental in bringing order out of chaos in the hurried formation of large volunteer armies in 1861, but the strategical and tactical successes of the following spring were due rather to the skill and activity of his subordinate generals Grant, Buell and Pope, than to the plans of the supreme commander, and when he assumed command of the united forces of these three generals before Corinth, the methodical slowness of his advance aroused much criticism. In July, however, he was called to Washington as general-in-chief of the armies. At headquarters his administrative powers were conspicuous, but he proved to be utterly wanting in any large grasp of the military problem; the successive reverses of Generals McClellan, Pope, Burnside and Hooker in Virginia were not infrequently traceable to the defects of the general-in-chief. No co-ordination of the military efforts of the Union was seriously undertaken by Halleck, and eventually in March 1864 Grant was appointed to

replace him, Major-General Halleck becoming chief of staff at Washington. This post he occupied with credit until the end of the war. In April 1865 he held the command of the military division of the James and in August of the same year of the military division of the Pacific, which he retained till June 1866, when he was transferred to that of the South, a position he held till his death at Louisville, Ky., on the 9th of January 1872. Halleck's position as a soldier is easily defined by his uniform success as an administrative official, his equally uniform want of success as an officer at the head of large armies in the field, and the popularity of his theoretical writings on war. His influence, for good or evil, on the course of the greatest war of modern times was greater than that of any soldier on either side save Grant and Lee, and whilst his interference with the dispositions of the commanders in the field was often disastrous, his services in organizing and instructing the Union forces were always of the highest value, and in this respect he was indispensable.

Besides *Military Art and Science*, Halleck wrote *Bitumen, its Varieties, Properties and Uses* (1841); *The Mining Laws of Spain and Mexico* (1859); *International Law* (1861; new edition, 1908); and *Treatise on International Law and the Laws of War, prepared for the use of Schools and Colleges*, abridged from the larger work. He translated Jomini's *Vie politique et militaire de Napoléon* (1864) and de Foe's *On the Law of Mines* (1866). The works on international law mentioned above entitle General Halleck to be considered as one of the great jurists of the 19th century.

HÄLLEFLINTA (a Swedish word meaning rock-flint), a white, grey, yellow, greenish or pink, fine-grained rock consisting of an intimate mixture of quartz and felspar. Many examples are banded or striated; others contain porphyritic crystals of quartz which resemble those of the felsites and porphyries. Mica, iron oxides, apatite, zircon, epidote and hornblende may also be present in small amount. The more micaceous varieties form transitions to granulite and gneiss. Hälleflinta under the microscope is very finely crystalline, or even cryptocrystalline, resembling the felsitic matrix of many acid rocks. It is essentially metamorphic and occurs with gneisses, schists and granulites, especially in the Scandinavian peninsula, where it is regarded as being very characteristic of certain horizons. Of its original nature there is some doubt, but its chemical composition and the occasional presence of porphyritic crystals indicate that it has affinities to the fine-grained acid intrusive rocks. In this group there may also have been placed metamorphosed acid tufts and a certain number of adolones (shales, contact altered by intrusions of diabase). The assemblage is not a perfectly homogeneous one but includes both igneous and sedimentary rocks, but the former preponderate. Rocks very similar to the typical Swedish hälleflintas occur in Tirol, in Galicia and eastern Bohemia.

HALLEL (Heb. הלל a Mishnic derivative from הלל *hillel*, "to praise"), a term in synagogal liturgy for (a) Psalms cxiii.-cxviii., often called "the Egyptian Hallel" because of its recitation during the paschal meal on the night of the Passover, (b) Psalm cxxxvi. "the Great Hallel." C. A. Briggs¹ points out that the term "Hallelujah" (Praise ye Yah) is found at the close of Pas. civ., cv., cxv., cxvi., cxvii., at the beginning of Pas. cxi., cxii. and at both ends of Pas. cvii., cxiii., cxxxv., cxlvi. to cl. The Septuagint also gives it at the beginning of Pas. cv., cvii., cxiv., cxvi. to cxix., cxxxvi. There are thus four groups of Hallel psalms—civ.-cvii. (a tetralogy on creation, the patriarchal age, the Exodus, and the Restoration); cxi.-cxvii. which includes most of the "Egyptian Hallel"; cxxxv.-cxxxvi.; cxlvi.-cl. All of these Hallel's (except cxlvii. and cxlix. which are Maccabean) belong to the Greek period, forming a collection of sixteen psalms composed for public use by the choirs, especially at the great feasts. Their distribution into four groups was the work of the final editor of the psalter. Later liturgical use regarded Pss. cxviii. and even cxix. as Hallel's, as well as Pas. cxx. to cxxxiv.

It will be observed that the extent of the official Hallel varied from time to time. It would appear that in the time of Gamaliel

¹ *International Critical Commentary*, "Psalms," Intro. lxxviii.

(*Pesachim* x. 5) the custom of its recitation at the paschal meal was still of recent innovation. While the school of Shammai advised only Pas. cxiii., the school of Hillel favoured Pss. cxiii. and cxiv.² The further extension so as to include Pas. cxv. to cxviii. probably dates from the first half of the 2nd century A.D., and these four psalms were recited after the pouring out of the fourth cup, the two earlier ones being taken at the beginning of the meal. From the 3rd century the use of the Hallel was extended to other occasions, and was gradually incorporated into the liturgy of eighteen festal days.

The "Great Hallel" (Ps. cxxxvi. and its later extension to cxx.-cxxxvi.) always served the wider purpose of a more general thanksgiving. According to Rabbi Johanan it derived its name from the allusion in v. 25 to the Holy One who sits in heaven and thence distributes food to all his creatures.

HALLER, ALBRECHT VON (1708-1777), Swiss anatomist and physiologist, was born of an old Swiss family at Bern, on the 16th of October 1708. Prevented by long-continued ill-health from taking part in boyish sports, he had the more opportunity for the development of his precocious mind. At the age of four, it is said, he used to read and expound the Bible to his father's servants; before he was ten he had sketched a Chaldee grammar, prepared a Greek and a Hebrew vocabulary, compiled a collection of two thousand biographies of famous men and women on the model of the great works of Bayle and Moreni, and written in Latin verse a satire on his tutor, who had warned him against a too great excursive-ness. When still hardly fifteen he was already the author of numerous metrical translations from Ovid, Horace and Virgil, as well as of original lyrics, dramas, and an epic of four thousand lines on the origin of the Swiss confederations, writings which he is said on one occasion to have rescued from a fire at the risk of his life, only, however, to burn them a little later (1729) with his own hand. Haller's attention had been directed to the profession of medicine while he was residing in the house of a physician at Biel after his father's death in 1721; and, following the choice then made, he while still a sickly and excessively shy youth went in his sixteenth year to the university of Tübingen (December 1723), where he studied under Camerarius and Duvernoy. Dissatisfied with his progress, he in 1725 exchanged Tübingen for Leiden, where Boerhaave was in the zenith of his fame, and where Albinus had already begun to lecture in anatomy. At that university he graduated in May 1727, undertaking successfully in his thesis to prove that the so-called salivary duct, claimed as a recent discovery by Coschwitz, was nothing more than a blood-vessel. Haller then visited London, making the acquaintance of Sir Hans Sloane, Cheselden, Pringle, Douglas and other scientific men; next, after a short stay in Oxford, he visited Paris, where he studied under Ledran and Winslow; and in 1728 he proceeded to Basel, where he devoted himself to the study of the higher mathematics under John Bernoulli. It was during his stay there also that his first great interest in botany was awakened; and, in the course of a tour (July-August, 1828), through Savoy, Baden and several of the Swiss cantons, he began a collection of plants which was afterwards the basis of his great work on the flora of Switzerland. From a literary point of view the main result of this, the first of his many journeys through the Alps, was his poem entitled *Die Alpen*, which was finished in March 1729, and appeared in the first edition (1732) of his *Gedichte*. This poem of 490 hexameters is historically important as one of the earliest signs of the awakening appreciation of the mountains (hitherto generally regarded as horrible monstrosities), though it is chiefly designed to contrast the simple and idyllic life of the inhabitants of the Alps with the corrupt and decadent existence of the dwellers in the plains.

In 1729 he returned to Bern and began to practise as a physician; his best energies, however, were devoted to the botanical and anatomical researches which rapidly gave him a European reputation, and procured for him from George II.

² The reference to a hymn at the institution of the Eucharist (Matt. xxvi. 30, Mark xiv. 26) must be interpreted in the light of this incipient stage of the Hallel.

in 1736 a call to the chair of medicine, anatomy, botany and surgery in the newly founded university of Göttingen. He became F.R.S. in 1743, and was ennobled in 1749. The quantity of work achieved by Haller in the seventeen years during which he occupied his Göttingen professorship was immense. Apart from the ordinary work of his classes, which entailed upon him the task of newly organizing a botanical garden, an anatomical theatre and museum, an obstetrical school, and similar institutions, he carried on without interruption those original investigations in botany and physiology, the results of which are preserved in the numerous works associated with his name; he continued also to persevere in his youthful habit of poetical composition, while at the same time he conducted a monthly journal (the *Göttingische gelehrte Anzeigen*), to which he is said to have contributed twelve thousand articles relating to almost every branch of human knowledge. He also warmly interested himself in most of the religious questions, both ephemeral and permanent, of his day; and the erection of the Reformed church in Göttingen was mainly due to his unwearied energy. Notwithstanding all this variety of absorbing interests he never felt at home in Göttingen; his untravelled heart kept ever turning towards his native Bern (where he had been elected a member of the great council in 1745), and in 1753 he resolved to resign his chair and return to Switzerland.

The twenty-one years of his life which followed were largely occupied in the discharge of his duties in the minor political post of a *Rathhausmann* which he had obtained by lot, and in the preparation of his *Bibliotheca medica*, the botanical, surgical and anatomical parts of which he lived to complete; but he also found time to write the three philosophical romances—*Ursong* (1771), *Alfred* (1773) and *Fabius and Cato* (1774)—in which his views as to the respective merits of despotism, of limited monarchy and of aristocratic republican government are fully set forth. About 1773 the state of his health rendered necessary his entire withdrawal from public business; for some time he supported his failing strength by means of opium, on the use of which he communicated a paper to the *Proceedings* of the Göttingen Royal Society in 1776; the excessive use of the drug is believed, however, to have hastened his death, which occurred on the 17th of December 1777. Haller, who had been three times married, left eight children, the eldest of whom, Gottlieb Emanuel, attained to some distinction as a botanist and as a writer on Swiss historical bibliography (1785-1788, 7 vols.).

Subjoined is a classified but by no means an exhaustive list of his very numerous works in various branches of science and literature (a complete list, up to 1775, numbering 576 items, including various editions, was published by Haller himself, in 1775, at the end of vol. 6 of the correspondence addressed to him by various learned friends):—(1) Anatomical:—*Icones anatomicae* (1743-1754); *Disputationes anatomicae selectiores* (1746-1752); and *Opera acad. minoris anatomici argumenti* (1762-1768). (2) Physiological:—*De respiratione experimenta anatomica* (1747); *Primas lineae physiologiae* (1747); and *Elementa physiologiae corporis humani* (1757-1760). (3) Pathological and surgical:—*Opuscula pathologica* (1754); *Disputationum chirurg. collectio* (1777); also careful editions of Boerhaave's *Praelectiones academicae in suas institutiones rei medicae* (1739), and of the *Artis medicae principia* of the same author (1769-1774). (4) Botanical:—*Enumeratio methodica stirpium Helvetiarum* (1742); *Opuscula botanica* (1749); *Bibliotheca botanica* (1771). (5) Theological:—*Briefe über die wichtigsten Wahrheiten der Offenbarung* (1772); and *Briefe zur Vertheidigung der Offenbarung* (1775-1777). (6) Poetical:—*Gedichte* (1732, 12th ed., 1777). His three romances have been already mentioned. Several volumes of lectures and "Tagebücher" or journals were published posthumously.

See J. G. Zimmermann, *Das Leben des Haller* (1755), and the articles by Förster and Seiler in Ersch and Gruber's *Encyclopädie*, and particularly the detailed biography (over 500 pages) by L. Hirtzel, printed at the head of his elaborate edition (Frauenfeld, 1882) of Haller's *Gedichte*.

HALLER, BERTHOLD (1492-1536), Swiss reformer, was born at Aldingen in Württemberg, and after studying at Pforzheim, where he met Melancthon, and at Cologne, taught in the gymnasium at Bern. He was appointed assistant preacher at the church of St Vincent in 1515 and people's priest in 1520. Even before his acquaintance with Zwingli in 1521 he had begun preach the Reformation, his sympathetic character and his

eloquence making him a great force. In 1526 he was at the abortive conference of Baden, and in January 1528 drafted and defended the ten theses for the conference of Bern which established the new religion in that city. He left no writings except a few letters which are preserved in Zwingli's works. He died on the 25th of February 1536.

Life by Pestalozzi (Elberfeld, 1861).

HALLEY, EDMUND (1656-1742), English astronomer, was born at Haggerston, London, on the 29th of October 1656. His father, a wealthy soapboiler, placed him at St Paul's school, where he was equally distinguished for classical and mathematical ability. Before leaving it for Queen's College, Oxford, in 1673, he had observed the change in the variation of the compass, and at the age of nineteen, he supplied a new and improved method of determining the elements of the planetary orbits (*Phil. Trans.* xi. 683). His detection of considerable errors in the tables then in use led him to the conclusion that a more accurate ascertainment of the places of the fixed stars was indispensable to the progress of astronomy; and, finding that Flamsteed and Hevelius had already undertaken to catalogue those visible in northern latitudes, he assumed to himself the task of making observations in the southern hemisphere. A recommendation from Charles II. to the East India Company procured for him an apparently suitable, though, as it proved, ill-chosen station, and in November 1676 he embarked for St Helena. On the voyage he noticed the retardation of the pendulum in approaching the equator; and during his stay on the island he observed, on the 7th of November 1677, a transit of Mercury, which suggested to him the important idea of employing similar phenomena for determining the sun's distance. He returned to England in November 1678, having by the registration of 341 stars won the title of the "Southern Tycho," and by the translation to the heavens of the "Royal Oak," earned a degree of master of arts, conferred at Oxford by the king's command on the 3rd of December 1678, almost simultaneously with his election as fellow of the Royal Society. Six months later, the indefatigable astronomer started for Danzig to set at rest a dispute of long standing between Hooke and Hevelius as to the respective merits of plain or telescopic sights; and towards the end of 1680 he proceeded on a continental tour. In Paris he observed, with G. D. Cassini, the great comet of 1680 after its perihelion passage; and having returned to England, he married in 1682 Mary, daughter of Mr Tooke, auditor of the exchequer, with whom he lived harmoniously for fifty-five years. He now fixed his residence at Islington, engaged chiefly upon lunar observations, with a view to the great desideratum of a method of finding the longitude at sea. His mind, however, was also busy with the momentous problem of gravity. Having reached so far as to perceive that the central force of the solar system must decrease inversely as the square of the distance, and applied vainly to Wren and Hooke for further elucidation, he made in August 1684 that journey to Cambridge for the purpose of consulting Newton, which resulted in the publication of the *Principia*. The labour and expense of passing this great work through the press devolved upon Halley, who also wrote the prefixed hexameters ending with the well-known line—

Nec fas est propius mortali attingere divos.

In 1696 he was, although a zealous Tory, appointed deputy comptroller of the mint at Chester, and (August 19, 1698) he received a commission as captain of the "Paramour Pink" for the purpose of making extensive observations on the conditions of terrestrial magnetism. This task he accomplished in a voyage which lasted two years, and extended to the 52nd degree of S. latitude. The results were published in a *General Chart of the Variation of the Compass* in 1701; and immediately afterwards he executed by royal command a careful survey of the tides and coasts of the British Channel, an elaborate map of which he produced in 1702. On his return from a journey to Dalmatia, for the purpose of selecting and fortifying the port of Trieste, he was nominated, November 1703, Savilian professor of geometry at Oxford, and received an honorary degree of

doctor of laws in 1710. Between 1713 and 1721 he acted as secretary to the Royal Society, and early in 1720 he succeeded Flamsteed as astronomer-royal. Although in his sixty-fourth year, he undertook to observe the moon through an entire revolution of her nodes (eighteen years), and actually carried out his purpose. He died on the 14th of January 1742. His tomb is in the old graveyard of St Margaret's church, Lee, Kent.

Halley's most notable scientific achievements were—his detection of the "long inequality" of Jupiter and Saturn, and of the acceleration of the moon's mean motion (1693), his discovery of the proper motions of the fixed stars (1718), his theory of variation (1683), including the hypothesis of four magnetic poles, revived by C. Hansteen in 1819, and his suggestion of the magnetic origin of the aurora borealis; his calculation of the orbit of the 1682 comet (the first ever attempted), coupled with a prediction of its return, strikingly verified in 1759; and his indication (first in 1679, and again in 1716, *Phil. Trans.*, No. 348) of a method extensively used in the 18th and 19th centuries for determining the solar parallax by means of the transits of Venus.

His principal works are *Catalogus stellarum austrarium* (London, 1679), the substance of which was embodied in vol. iii. of Flamsteed's *Historia coelestis* (1725); *Synopsis astronomiæ cometicae* (Oxford, 1705); *Astronomical Tables* (London, 1752); also eighty-one miscellaneous papers of considerable interest, scattered through the *Philosophical Transactions*. To these should be added his version from the Arabic (which language he acquired for the purpose) of the treatise of Apollonius *De sectione rationis*, with a restoration of his two lost books *De sectione spatii*, both published at Oxford in 1706; also his fine edition of the *Conics* of Apollonius, with the treatise by Serenus *De sectione cylindri et conæ* (Oxford, 1710, folio). His edition of the *Sphaerics* of Menelaus was published by his friend Dr Costard in 1758. See also *Biographia Britannica*, vol. iv. (1757); *Genl. Mag.* xvii. 455, 503; A. Wood, *Athenae Oxon.* (Bliss), iv. 536; J. Aubrey, *Lives*, ii. 365; F. Baily, *Account of Flamsteed*; Sir D. Brewster, *Life of Newton*; R. Grant, *History of Astronomy*, p. 477 and *passim*; A. J. Rudolph, *Bulletin of Bibliography*, No. 14 (Boston, 1904); E. F. McPike, "Bibliography of Halley's Comet," *Smithsonian Misc. Collections*, vol. xlviii. pt. i. (1905); *Notes and Queries*, 9th series, vols. x. xi. xii., 10th series, vol. ii. (E. F. McPike). A collection of manuscripts regarding Halley is preserved among the Rigaud papers in the Bodleian library, Oxford; and many of his unpublished letters exist at the Record Office and in the library of the Royal Society. (A. M. C.)

HALLGRÍMSSON, JÓNAS (1807-1844), the chief lyrical poet of Iceland, was born in 1807 at Steinsstaðir in Eyjafjarðarsýsla in the north of that island, and educated at the famous school of Bessastaðr. In 1832 he went to the university of Copenhagen, and shortly afterwards turned his attention to the natural sciences, especially geology. Having obtained pecuniary assistance from the Danish government, he travelled through all Iceland for scientific purposes in the years 1837-1842, and made many interesting geological observations. Most of his writings on geology are in Danish. His renown was, however, not acquired by his writings in that language, but by his Icelandic poems and short stories. He was well read in German literature, Heine and Schiller being his favourites, and the study of the German masters and the old classical writers of Iceland opened his eyes to the corrupt state of Icelandic poetry and showed him the way to make it better. The misuse of the Eddic metaphors made the lyrical and epic poetry of the day hardly intelligible, and, to make matters worse, the language of the poets was mixed up with words of German and Danish origin. The great Danish philologist and friend of Iceland, Rasmus Rask, and the poet Bjarni Thórarensen had done much to purify the language, but Jónas Hallgrímsson completed their work by his poems and tales, in a purer language than ever had been written in Iceland since the days of Snorri Sturluson. The excesses of Icelandic poetry were specially seen in the so-called *rímur*, ballads of heroes, &c., which were fiercely attacked by Jónas Hallgrímsson, who at last succeeded in converting the educated to his view. Most of the principal poems, tales and essays of Jónas Hallgrímsson appeared in the periodical *Fjólínir*, which he began publishing at Copenhagen in 1835, together with Konráð Gíslason, a well-known philologist, and the patriotic Thómas Saemundsson. *Fjólínir* had in the beginning a hard struggle against old prejudices, but as the years went by its influence became

enormous; and when it at last ceased, its programme and spirit still lived in *Ný Félagsrit* and other patriotic periodicals which took its place. Jónas Hallgrímsson, who died in 1844, is the father of a separate school in Icelandic lyric poetry. He introduced foreign thoughts and metres, but at the same time revived the metres of the Icelandic classical poets. Although his poetical works are all comprised in one small volume, he strikes every string of the old harp of Iceland. (S. B.L.)

HALLIDAY, ANDREW [ANDREW HALLIDAY DUFF] (1830-1877), British journalist and dramatist, was born at Marnoch, Banffshire, in 1830. He was educated at Marischal College, Aberdeen, and in 1849 he came to London, and discarding the name of Duff, devoted himself to literature. His first engagement was with the daily papers, and his work having attracted the notice of Thackeray, he was invited to write for the *Cornhill Magazine*. From 1861 he contributed largely to *All the Year Round*, and many of his articles were republished in collected form. He was also the author, alone and with others, of a great number of farces, burlesques and melodramas and a peculiarly successful adapter of popular novels for the stage. Of these *Little Em'ly* (1860), his adaptation of *David Copperfield*, was warmly approved by Dickens himself, and enjoyed a long run at Drury Lane. Halliday died in London on the 10th of April 1877.

HALLIWELL-PHILLIPPS, JAMES ORCHARD (1820-1880), English Shakespearian scholar, son of Thomas Halliwell, was born in London, on the 21st of June 1820. He was educated privately and at Jesus College, Cambridge. He devoted himself to antiquarian research, particularly in early English literature. In 1839 he edited Sir John Mandeville's *Travels*; in 1842 published an *Account of the European MSS. in the Chetham Library*, besides a newly discovered metrical romance of the 15th century (*Torrent of Portugal*). He became best known, however, as a Shakespearean editor and collector. In 1848 he brought out his *Life of Shakespeare*, which passed through several editions; in 1853-1865 a sumptuous edition, limited to 150 copies, of Shakespeare in folio, with full critical notes; in 1863 a *Calendar of the Records at Stratford-on-Avon*; in 1864 a *History of New Place*. After 1870 he entirely gave up textual criticism, and devoted his attention to elucidating the particulars of Shakespeare's life. He collated all the available facts and documents in relation to it, and exhausted the information to be found in local records in his *Outlines of the Life of Shakespeare*. He was mainly instrumental in the purchase of New Place for the corporation of Stratford-on-Avon, and in the formation there of the Shakespeare museum. His publications in all numbered more than sixty volumes. He assumed the name of Phillipps in 1872, under the will of the grandfather of his first wife, a daughter of Sir Thomas Phillipps the antiquary. He took an active interest in the Camden Society, the Percy Society and the Shakespeare Society, for which he edited many early English and Elizabethan works. From 1845 Halliwell was excluded from the library of the British Museum on account of the suspicion attaching to his possession of some manuscripts which had been removed from the library of Trinity College, Cambridge. He published privately an explanation of the matter in 1845. His house, Hollingbury Copse, near Brighton, was full of rare and curious works, and he generously gave many of them to the Chetham library, Manchester, to the town library of Penzance, to the Smithsonian Institute, Washington, and to the library of Edinburgh university. He died on the 3rd of January 1880.

HALLOWE'EN, or ALL HALLOWS EVE, the name given to the 31st of October as the vigil of Hallowmas or All Saints' Day. Though now known as little else but the eve of the Christian festival, Hallowe'en and its formerly attendant ceremonies long antedate Christianity. The two chief characteristics of ancient Hallowe'en were the lighting of bonfires and the belief that of all nights in the year this is the one during which ghosts and witches are most likely to wander abroad. Now on or about the 1st of November the Druids held their great autumn festival and lighted fires in honour of the Sun-god in thanksgiving for the harvest. Further, it was a Druidic belief that on the eve of

this festival Saman, lord of death, called together the wicked souls that within the past twelve months had been condemned to inhabit the bodies of animals. Thus it is clear that the main celebrations of Hallow'e'en were purely Druidical, and this is further proved by the fact that in parts of Ireland the 31st of October was, and even still is, known as *Oidhche Shamhna*, "Vigil of Saman." On the Druidic ceremonies were grafted some of the characteristics of the Roman festival in honour of Pomona held about the 1st of November, in which nuts and apples, as representing the winter store of fruits, played an important part. Thus the roasting of nuts and the sport known as "apple-ducking"—attempting to seize with the teeth an apple floating in a tub of water,—were once the universal occupation of the young folk in medieval England on the 31st of October. The custom of lighting Hallow'e'en fires survived until recent years in the highlands of Scotland and Wales. In the dying embers it was usual to place as many small stones as there were persons around, and next morning a search was made. If any of the pebbles were displaced it was regarded as certain that the person represented would die within the twelve months.

For details of the Hallow'e'en games and bonfires see Brand's *Antiquities of Great Britain*; Chambers's *Book of Days*; Grimm's *Deutsche Mythologie*, ch. xx. (Elemente) and ch. xxxiv. (Aberglaube); and J. C. Frazer's *Golden Bough*, vol. iii. Compare also BELTANE and BONFIRE.

HALLSTATT, a market-place of Austria, in Upper Austria, 67 m. S.S.W. of Linz by rail. Pop. (1900) 737. It is situated on the shore of the Hallstatter-see and at the foot of the Hallstatter Salzberg, and is built in amphitheatre with its houses clinging to the mountain side. The salt mine of Hallstatt, which is one of the oldest in existence, was rediscovered in the 14th century. In the neighbourhood is the celebrated Celtic burial ground, where a great number of very interesting antiquities have been found. Most of these have been removed to the museums at Vienna and Linz, but some are kept in the local museum.

The excavations (1847-1864) revealed a form of culture hitherto unknown, and accordingly the name Hallstatt has been applied to objects of like form and decoration since found in Styria, Carniola, Bosnia (at Glasinatz and Jezerin), Epirus, north Italy, France, Spain and Britain (see CELT). Everywhere else the change from iron weapons to bronze is immediate, but at Hallstatt iron is seen gradually superseding bronze, first for ornament, then for edging cutting instruments, then replacing fully the old bronze types, and finally taking new forms of its own. There can be no doubt that the use of iron first developed in the Hallstatt area, and that thence it spread southwards into Italy, Greece, the Aegean, Egypt and Asia, and northwards and westwards in Europe. At Norcia, which gave its name to Noricum (*q.v.*) less than 40 m. from Hallstatt, were the most famous iron mines of antiquity, which produced the Noric iron and Noric swords so prized and dreaded by the Romans (Pliny, *Hist. Nat.* xxxiv. 145; Horace, *Epod.* 17. 71). This iron needed no tempering, and the Celts had probably found it ready smelted by nature, just as the Eskimo had learned of themselves to use telluric iron embedded in basalt. The graves at Hallstatt were partly inhumation partly cremation; they contained swords, daggers, spears, javelins, axes, helmets, bosses and plates of shields and hauberks, brooches, various forms of jewelry, amber and glass beads, many of the objects being decorated with animals and geometrical designs. Silver was practically unknown. The weapons and axes are mostly iron, a few being bronze. The swords are leaf-shaped, with blunt points intended for cutting, not for thrusting; the hilts differ essentially from those of the Bronze Age, being shaped like a crescent to grasp the blade, with large pommels, or sometimes with antennae (the latter found also in Bavaria, Württemberg, Baden, Switzerland, the Pyrenees, Spain, north Italy): only six arrowheads (bronze) were found. Both flanged and socketed celts occurred, the iron being much more numerous than the bronze. The flat axes are distinguished by the side stops and in some cases the transition from palstave to socketed axe can be seen. The shields were

round as in the early Iron Age of north Italy (see VILLANOVA). Greaves were found at Glasinatz and Jezerin, though not at Hallstatt; two helmets were found at Hallstatt and others in Bosnia; broad bronze belts were numerous, adorned in *repoussé* with beast and geometric ornament. Brooches are found in great numbers, both those derived from the primitive safety-pin ("Peschiera" type) and the "spectacle" or "Hallstatt" type found all down the Balkans and in Greece. The latter are formed of two spirals of wire, sometimes four such spirals being used, whilst there were also brooches in animal forms, one of the latter being found with a bronze sword. The Hallstatt culture is that of the Homeric Achaeans (see ACHAEANS), but as the brooch (along with iron, cremation of the dead, the round shield and the geometric ornament) passed down into Greece from central Europe, and as brooches are found in the lower town at Mycenae, 1350 B.C., they must have been invented long before that date in central Europe. But as they are found in the late Bronze Age and early Iron Age, the early iron culture of Hallstatt must have originated long before 1350 B.C., a conclusion in accord with the absence of silver at Hallstatt itself.

See Baron von Sacken, *Das Grabfeld von Hallstatt*; Bertrand and S. Reinach, *Les Celtes dans les vallées du Pô et du Danube*; W. Ridgeway, *Early Age of Greece*; ARCHAEOLOGY (plate). (W. R.)

HALLUCINATION (from Lat. *alucinari* or *alucinari*, to wander in mind, Gr. *ἀλυσσιν* or *ἀλυσιν*, from *ἀλσιν*, wandering), a psychological term which has been the subject of much controversy, and to which, although there is now fair agreement as to its denotation, it is still impossible to give a precise and entirely satisfactory definition. Hallucinations constitute one of the two great classes of all false sense-perceptions, the other class consisting of the "illusions," and the difficulty of definition is clearly to mark the boundary between the two classes. *Illusions* may be defined as the misinterpretation of sense-impression; while *hallucination*, in its typical instances, is the experiencing of a sensory presentation, *i.e.* a presentation having the sensory vividness that distinguishes perceptions from representative imagery, at a time when no stimulus is acting on the corresponding sense-organ. There is, however, good reason to think that in many cases, possibly in all cases, some stimulation of the sense-organ, coming either from without or from within the body, plays a part in the genesis of the hallucination. This being so, we must be content to leave the boundary between illusions and hallucinations ill-defined, and to regard as illusions those false perceptions in which impressions made on the sense-organ play a leading part in determining the character of the percept, and as hallucinations those in which any such impression is lacking, or plays but a subsidiary part and bears no obvious relation to the character of the false percept.

As in the case of illusion, hallucination may or may not involve delusion, or belief in the reality of the object falsely perceived. Among the same the hallucinatory object is frequently recognized at once as unreal or at least as but quasi-real; and it is only the insane, or persons in abnormal states, such as hypnosis, who, when an hallucination persists or recurs, fail to recognize that it corresponds to no physical impression from, or object in, the outer world. Hallucinations of all the senses occur, but the most commonly reported are the auditory and the visual, while those of the other senses seem to be comparatively rare. This apparent difference of frequency is no doubt largely due to the more striking character of visual and auditory hallucinations, and to the relative difficulty of ascertaining, in the case of perceptions of the lower senses, *e.g.* of taste and smell, that no impression adequate to the genesis of the percept has been made upon the sense-organ; but, in so far as it is real, it is probably due in part to the more constant use of the higher senses and the greater strain consequently thrown upon them, in part also to their more intimate connexion with the life of ideas.

The hallucinatory perception may involve two or more senses, *e.g.* the subject may seem to see a human being, to hear his voice and to feel the touch of his hand. This is rarely the case in spontaneous hallucination, but in hypnotic hallucination the

subject is apt to develop the object suggested to him, as present to one of his senses, and to perceive it also through other senses.

Among visual hallucinations the human figure, and among auditory hallucinations human voices, are the objects most commonly perceived. The figure seen always appears localized more or less definitely in the outer world. In many cases it appears related to the objects truly seen in just the same way as a real object; e.g. it is no longer seen if the eyes are closed or turned away; it does not move with the movements of the eyes, and it may hide objects lying behind it, or be hidden by objects coming between the place that it appears to occupy and the eye of the percipient. Visual hallucinations are most often experienced when the eyes are open and the surrounding space is well or even brightly illuminated. Less frequently the visual hallucination takes the form of a self-luminous figure in a dark place or appears in a luminous globe or mist which shuts out from view the real objects of the part of the field of view in which it appears.

Auditory hallucinations, especially voices, seem to fall into two distinct classes—(1) those which are heard as coming from without, and are more or less definitely localized in outer space, (2) those which seem to be within the head or, in some cases, within the chest, and to have less definite auditory quality. It seems probable that the latter are hallucinations involving principally kinaesthetic sensations, sensations of movement of the organs of speech.

Hallucinations occur under a great variety of bodily and mental conditions, which may conveniently be classified as follows.

I. Conditions which imply normal waking Consciousness and no distinct Departure from bodily and mental Sanity.

a. It would seem that a considerable number of perfectly healthy persons occasionally experience, while in a fully waking state, hallucinations for which no cause can be assigned. The census of hallucinations conducted by the Society for Psychological Research showed that about 10% of all sane persons can remember having experienced at least one hallucination while they believed themselves to be fully awake and in normal health. These sporadic hallucinations of waking healthy persons are far more frequently visual than auditory, and they usually take the form of some familiar person in ordinary attire. The figure in many cases is seen, on turning the gaze in some new direction, fully developed and lifelike, and its hallucinatory character may be revealed only by its noiseless movements, or by its fading away *in situ*. A special interest attaches to hallucinations of this type, owing to the occasional coincidence of the death of the person with his hallucinatory appearance. The question raised by these coincidences will be discussed in a separate paragraph below.

b. A few persons, otherwise normal in mind and body, seem to experience repeatedly some particular kind of hallucination. The voice (*δαίμωνιον*) so frequently heard by Socrates, warning or advising him, is the most celebrated example of this type.

II. Conditions more or less unusual or abnormal but not implying distinct Departure from Health.

a. A kind of hallucination to which perhaps every normal person is liable is that known technically as "recurrent sensation." This kind is experienced only when some sense-organ has been continuously or repeatedly subjected to some one kind of impression or stimulation for a considerable period; e.g. the microscopist, after examining for some hours one particular kind of object or structure, may suddenly perceive the object faithfully reproduced in form and colour, and lying, as it were, upon any surface to which his gaze is directed. Perhaps the commonest experience of this type is the recurrence of the sensations of movement at intervals in the period following a sea voyage or long railway journey.

b. A considerable proportion of healthy sane persons can induce hallucinations of vision by gazing fixedly at a polished

surface or into some dark translucent mass; or of hearing, by applying a large shell or similar object to the ear. These methods of inducing hallucinations, especially the former, have long been practised in many countries as modes of divination, various objects being used, e.g. a drop of ink in the palm of the hand, or a polished finger-nail. The object now most commonly used is a polished sphere of clear glass or crystal (see *CRYSTAL-GAZING*). Hence such hallucinations go by the name of *crystal visions*. The crystal vision often appears as a picture of some distant or unknown scene lying, as it were, in the crystal; and in the picture figures may come and go, and move to and fro, in a perfectly natural manner. In other cases, written or printed words or sentences appear. The percipient, seer or scryer, commonly seems to be in a fully waking state as he observes the objects thus presented. He is usually able to describe and discuss the appearances, successively discriminating details by attentive observation, just as when observing an objective scene; and he usually has no power of controlling them, and no sense of having produced them by his own activity. In some cases these visions have brought back to the mind of the scryer facts or incidents which he could not voluntarily recollect. In other cases they are asserted by credible witnesses to have given to the scryer information, about events distant in time or place, that had not come to his knowledge by normal means. These cases have been claimed as evidence of telepathic communication or even of clairvoyance. But at present the number of well-attested cases of this sort is too small to justify acceptance of this conclusion by those who have only secondhand knowledge of them.

c. Prolonged deprivation of food predisposes to hallucinations, and it would seem that, under this condition, a large proportion of otherwise healthy persons become liable to them, especially to auditory hallucinations.

d. Certain drugs, notably opium, Indian hemp, and mesal predispose to hallucinations, each tending to produce a peculiar type. Thus Indian hemp and mesal, especially the latter, produce in many cases visual hallucinations in the form of a brilliant play of colours, sometimes a mere succession of patches of brilliant colour, sometimes in architectural or other definite spatial arrangement.

e. The states of transition from sleep to waking, and from waking to sleep, seem to be peculiarly favourable to the appearance of hallucinations. The recurrent sensations mentioned above are especially prone to appear at such times, and a considerable proportion of the sporadic hallucinations of persons in good health are reported to have been experienced under these conditions. The name "hypnagogic" hallucinations, first applied by Alfred Maury, is commonly given to those experienced in these transition states.

f. The presentations, predominantly visual, that constitute the principal content of most dreams, are generally described as hallucinatory, but the propriety of so classing them is very questionable. The present writer is confident that his own dream-presentations lack the sensory vividness which is the essential mark of the percept, whether normal or hallucinatory, and which is the principal, though not the only, character in which it differs from the representation or memory-image. It is true that the dream-presentation, like the percept, differs from the representative imagery of waking life in that it is relatively independent of volition; but that seems to be merely because the will is in abeyance or very ineffective during sleep. The wide currency of the doctrine that classes dream-images with hallucinations seems to be due to this independence of volitional control, and to the fact that during sleep the representative imagery appears without that rich setting of undiscriminated or marginal sensation which always accompanies waking imagery, and which by contrast accentuates for introspective reflection the lack of sensory vividness of such imagery.

g. Many of the subjects who pass into the deeper stages of hypnosis (see *HYPNOTISM*) show themselves, while in that condition, extremely liable to hallucination, perceiving whatever object is suggested to them as present, and failing to perceive

any object of which it is asserted by the operator that it is no longer present. The reality of these positive and negative hallucinations of the hypnotized subject has been recently questioned, it being maintained that the subject merely gives verbal assent to the suggestions of the operator. But that the hypnotized subject does really experience hallucinations seems to be proved by the cases in which it is possible to make the hallucination, positive or negative, persist for some time after the termination of hypnosis, and by the fact that in some of these cases the subject, who in the post-hypnotic state seems in every other respect normal and wide awake, may find it difficult to distinguish between the hallucinatory and real objects. Further proof is afforded by experiments such as those by which Alfred Binet showed that a visual hallucination may behave for its percipient in many respects like a real object, e.g. that it may appear reflected in a mirror, displaced by a prism and coloured when a coloured glass is placed before the patient's eyes. It was by means of experiments of this kind that Binet showed that hypnotic hallucinations may approximate to the type of the illusion, i.e. that some real object affecting the sense-organ (in the case of a visual hallucination some detail of the surface upon which it is projected) may provide a nucleus of peripherally excited sensation around which the false percept is built up. An object playing a part of this sort in the genesis of an hallucination is known as a "*point de repère*." It has been maintained that all hallucinations involve some such *point de repère* or objective nucleus; but there are good reasons for rejecting this view.

k. In states of ecstasy, or intense emotional concentration of attention upon some one ideal object, the object contemplated seems at times to take on sensory vividness, and so to acquire the character of an hallucination. In these cases the state of mind of the subject is probably similar in many respects to that of the deeply hypnotized subject, and these two classes of hallucination may be regarded as very closely allied.

III. Hallucinations which occur as symptoms of both bodily and mental diseases.

a. Dr H. Head has the credit of having shown for the first time, in the year 1901, that many patients, suffering from more or less painful visceral diseases, disorders of heart, lungs, abdominal viscera, &c., are liable to experience hallucinations of a peculiar kind. These "visceral" hallucinations, which are constantly accompanied by headache of the reflected visceral type, are most commonly visual, more rarely auditory. In all Dr Head's cases the visual hallucination took the form of a shrouded human figure, colourless and vague, often incomplete, generally seen by the patient standing by his bed when he wakes in a dimly lit room. The auditory "visceral" hallucination was in no instance vocal, but took such forms as sounds of tapping, scratching or rumbling, and were heard only in the absence of objective noises. In a few cases the "visceral" hallucination was bisensory, i.e. both auditory and visual.

In all these respects the "visceral" hallucination differs markedly from the commoner types of the sporadic hallucination of healthy persons.

b. Hallucinations are constant symptoms of certain general disorders in which the nervous system is involved, notably of the *delirium tremens*, which results from chronic alcohol poisoning, and of the delirium of the acute specific fevers. The hallucinations of these states are generally of a distressing or even terrifying character. Especially is this the rule with those of *delirium tremens*, and in the hallucinations of this disease certain kinds of objects, e.g. rats and snakes, occur with curious frequency.

c. Hallucinations occasionally occur as symptoms of certain nervous diseases that are not usually classed with the insanities, notably in cases of epilepsy and severe forms of hysteria. In the former disorder, the sensory aura that so often precedes the epileptic convulsion may take the form of an hallucinatory object, which in some cases is very constant in character. Unilateral hallucinations, an especially interesting class, occur

in severe cases of hysteria, and are usually accompanied by hemi-anaesthesia of the body on the side on which the hallucinatory object is perceived.

d. Hallucinations occur in a large, but not accurately definable, proportion of all cases of mental disease proper. Two classes are recognized: (1) those that are intimately connected with the dominant emotional state or with some dominant delusion; (2) those that occur sporadically and have no such obvious relation to the other symptoms of disease. Hallucinations of the former class tend to accentuate, and in turn to be confirmed by, the congruent emotional or delusional state; but whether these are to be regarded as primary symptoms and as the cause of the hallucinations, or *vice versa*, it is generally impossible to say. Patients who suffer delusions of persecution are very apt to develop later in the course of their disease hallucinations of the voices of their persecutors; while in other cases hallucinatory voices, which are at first recognized as such, come to be regarded as real and in these cases seem to be factors of primary importance in the genesis of further delusions. Hallucinations occur in almost every variety of mental disease, but are commonest in the forms characterized by a cloudy dream-like condition of consciousness, and in extreme cases of this sort the patient (as in the delirium of chronic alcohol-poisoning) seems to move waking through a world consisting largely of the images of his own creation, set upon a background of real objects.

In some cases hallucinations are frequently experienced for long periods in the absence of any other symptom of mental disorder, but these no doubt usually imply some morbid condition of the brain.

Physiology of Hallucination.—There has been much discussion as to the nature of the neural process in hallucination. It is generally and rightly assumed that the hallucinatory perception of any object has for its immediate neural correlate a state of excitement which, as regards its characters and its distribution in the elements of the brain, is entirely similar to the neural correlate of the normal perception of the same object. The hallucination is a perception, though a false perception: in the perception of an object and in the representation of it, introspective analysis discovers a number of presentative elements. In the case of the representation these elements are memory images only (except perhaps in so far as actual kinesthetic sensations enter into its composition); whereas, in the case of the percept, some of these elements are sensations, sensations which differ from images in having the attribute of sensory vividness; and the sensory vividness of these elements lends to the whole complex the sensory vividness or reality, the possession of which character by the percept constitutes its principal difference from the representation. Normally, sensory vividness attaches only to those presentative elements which are excited through stimulations of the sense-organs. The normal percept, then, owes its character of sensory reality to the fact that a certain number of its presentative elements are sensations peripherally excited by impressions made upon a sense-organ. The problem is, then, to account for the fact that the hallucination contains presentative elements that have sensory vividness, that are sensations, although they are not excited by impressions from the external world falling upon a sense-organ. Most of the discussions of this subject suffer from the neglect of this preliminary definition of the problem. Many authors, notably W. Wundt and his disciples, have been content to assume that the sensation differs from the memory-image only in having a higher degree of intensity; from which they infer that its neural correlate in the brain cortex also differs from that of the image only in having a higher degree of intensity. For them an hallucination is therefore merely a representation whose neural correlate involves an intensity of excitement of certain brain-elements such as is normally produced only by peripheral stimulation of sensory nerves in the sense-organs. But this view, so attractively simple, ignores an insuperable objection. Sensory vividness is not to be identified with superior intensity; for while the least intense sensation has it, the memory image of the most intense sensation lacks it completely.

And, since intensity of sensation is a function of the intensity of the underlying neural excitement, we may not assume that sensory vividness is also the expression in consciousness of that intensity of excitement. If Wundt's view were true a progressive diminution of the intensity of a sensory stimulus should bring the sensation to a point in the scale of diminishing intensity at which it ceases to be sensation, ceases to have sensory vividness and becomes an image merely. But this is not the case; with diminishing intensity of stimulation, the sensation declines to a minimal intensity and then disappears from consciousness. This objection applies not only to Wundt's view of hallucinations, but also to H. Taine's explanation of them by the aid of his doctrine of "reductives," for this too identifies sensory vividness with intensity. (H. Taine, *De l'intelligence*, tome i. p. 108.)

Another widely current explanation is based on the view that the representation and the percept have their anatomical bases in different element-groups or "centres" of the brain, the "centre" of the representation being assigned to a higher level of the brain than that of the percept (the latter being sometimes assigned to the basal ganglia of the brain, the former to the cortex). It is then assumed that while the lower perceptual centre is normally excited only through the sense-organ, it may occasionally be excited by impulses playing down upon it from the corresponding centre of representation, when hallucination results.

This view also is far from satisfactory, because the great additions recently made to our knowledge of the brain tend very strongly to show that both sensations and memory-images have their anatomical bases in the same sensory areas of the cerebral cortex; and many considerations converge to show that their anatomical bases must be, in part at least, identical.

The views based on the assumptions of complete identity, and of complete separateness, of the anatomical bases of the percept and of the representation are then alike untenable; and the alternative—that their anatomical bases are in part identical, in part different, which is indicated by this conclusion—renders possible a far more satisfactory doctrine. We have good reason to believe that the neural correlate of sensation is the transmission of the nervous impulse through a sensori-motor arc of the cortex, made up of a chain of neurones; and the view suggests itself that the neural correlate of the corresponding memory-image is the transmission of the impulse through a part only of this chain of cortical elements, either the efferent motor part of this chain or the afferent sensory part of it. Professor W. James's theory of hallucinations is based on the latter assumption. He suggests that the sensory vividness of sensation and of the percept is due to the discharge of the excitement of the chain of elements in the forward or motor direction; and that, in the case of the image and of the representation, the discharge takes place, not in this direction through the efferent channel of the centre, but laterally into other centres of the cortex. Hallucination may then be conceived as caused by obstruction, or abnormally increased resistance, of the paths connecting such a cortical centre with others, so that, when it becomes excited in any way, the tension or potential of its charge rises, until discharge takes place in the motor direction through the efferent limbs of the sensori-motor arcs which constitute the centre.

It is a serious objection to this view that, as James himself, in common with most modern authors, maintains, every idea has its motor tendency which commonly, perhaps always, finds expression in some change of tension of muscles, and in many cases issues in actual movements. Now if we accept James's theory of hallucination, we should expect to find that whenever a representation issues in bodily action it should assume the sensory vividness of an hallucination; and this, of course, is not the case.

The alternative form of the view that assumes partial identity of the anatomical bases of the percept and the representation of an object, would regard the neural correlate of the sensation as the transmission of the nervous impulse throughout the length

of the sensori-motor arc of the cortex, from sensory inlet to motor outlet; and that of the image as its transmission through the efferent part of this arc only; that is to say, in the case of the image, it would regard the excitement of the arc as being initiated at some point between its afferent inlet and its motor outlet, and as spreading, in accordance with the law of forward conduction, towards the motor outlet only, so that only the part of the arc distal or efferent to this point becomes excited.

This view of the neural basis of sensory vividness, which correlates the difference between the sensation and the image with the only known difference between their physiological conditions, namely the peripheral initiation of the one and the central initiation of the other, enables us to formulate a satisfactory theory of the physiology of hallucinations.

The anatomical basis of the perception and of the representation of any object is a functional system of nervous elements, comprising a number of sensori-motor arcs, whose excitement by impulses descending to them by the sensory paths from the sense-organs determines sensations, and whose excitement in their efferent parts only determines the corresponding images. In the case of perception, some of these arcs are excited by impulses ascending from the sense-organs, others only by the spread of the excitement through the system from these peripherally excited arcs; while, in the case of the representation, all alike are excited by impulses that reach the system from other parts of the cortex and spread throughout its efferent parts only to its motor outlets.

If then impulses enter this system by any of the afferent limbs of its sensori-motor arcs, the presentation that accompanies its excitement will have sensory vividness and will be a true perception, an illusion, or an hallucination, according as these impulses have followed the normal course from the sense-organ, or have been diverted, to a lesser or greater degree, from their normal paths. If any such neural system becomes abnormally excitable, or becomes excited in any way with abnormal intensity, it is thereby rendered a path of exceptionally low-resistance capable of diverting to itself, from their normal path, any streams of impulses ascending from the sense-organ; which ascending impulses, entering the system by its afferent inlets, excite sensations that impart to the presentation the character of sensory vividness; the presentation thus acquires the character of a percept in spite of the absence of the appropriate impression on the sense-organ, and we call it an hallucination.

This view renders intelligible the *modus operandi* of many of the predisposing causes of hallucination; e.g. the pre-occupation with certain representations of the ecstatic, or of the sufferer from delusions of persecution; the intense expectation of a particular sense impression, the generally increased excitability of the cortex in states of delirium; in all these conditions the abnormally intense excitement of the cortical systems may be supposed to give them an undue directive and attractive influence upon the streams of impulses ascending from the sense-organs, so that sensory impulses may be diverted from their normal paths. Again, it renders intelligible the part played by chronic irritation of a sense-organ, as when chronic irritation of the internal ear leads on to hallucinations of hearing; perhaps also the chronic irritation of sensory nerves that must accompany the states of visceral disease, shown by Head to be so frequently accompanied by a liability to hallucinations; for any such chronic irritation supplies a stream of disorderly impulses rising constantly from the sense-organ, for the reception of which the brain has no appropriate system, and which, therefore, readily enters any organized cortical system that at any moment constitutes a path of low-resistance. A similar explanation applies to the influence of fixed gazing upon a crystal, or the placing of a shell over the ear, in inducing visual and auditory hallucinations. The "recurrent sensations" experienced after prolonged occupation with some one kind of sensory object may be regarded as due to an abnormal excitability of the cortical system concerned, resulting from its unduly prolonged exercise. The hypothesis renders intelligible also the liability to hallucination of persons in the hysterical and hypnotic states, in whose brains

the cortical neural systems are in a state of partial dissociation, which renders possible an unduly intense and prolonged excitement of some one system at the expense of all other systems (cf. HYPNOTISM).

Coincidental Hallucinations.—It would seem that, in well-nigh all countries and in all ages, apparitions of persons known to be in distant places have been occasionally observed. Such appearances have usually been regarded as due to the presence, before the bodily eye of the seer, of the ghost, wraith, double or soul of the person who thus appears; and, since the soul has been very commonly supposed to leave the body, permanently at death and temporarily during sleep, trance or any period of unconsciousness, however induced, it was natural to regard such an appearance as evidence that the person whose wraith was thus seen was in some such condition. Such apparitions have probably played a part, second only to that of dreams, in generating the almost universal belief in the separability of soul and body.

In many parts of the world traditional belief has connected such apparitions more especially with the death of the person so appearing, the apparition being regarded as an indication that the person so appearing has recently died, is dying or is about to die. Since death is so much less common an event than sleep, trance, or other form of temporary unconsciousness, the wide extension of this belief suggests that such apparitions may coincide in time with death, with disproportionate frequency. The belief in the significance of such apparitions still survives in civilized communities, and stories of apparitions coinciding with the death of the person appearing are occasionally reported in the newspapers, or related as having recently occurred. The Society for Psychical Research has sought to find grounds for an answer to the question "Is there any sufficient justification for the belief in a causal relation between the apparition of a person at a place distant from his body and his death or other exceptional and momentous event in his experience?" The problem was attacked in a thoroughly scientific spirit, an extensive inquiry was made, and the results were presented and fully discussed in two large volumes, *Phantasms of the Living*, published in the year 1886, bearing on the title-page the names of Edmund Gurney, F. W. H. Myers and F. Podmore. Of the three collaborators Gurney took the largest share in the planning of the work, in the collection of evidence, and in the elaboration and discussion of it.

Gurney set out with the presumption that apparitions, whether coincidental or not, are hallucinations in the sense defined above; that they are false perceptions and are not excited by any object or process of the external world acting upon the sense-organs of the percipient in normal fashion; that they do not imply the presence, in the place apparently occupied by them, of any wraith or any form of existence emanating from, or specially connected with, the person whose phantasm appears. This initial assumption was abundantly justified by an examination of a large number of cases for it, which showed that, in all important respects, most of these apparitions of persons at a distance, whether coincidental or not, were similar to other forms of hallucination.

The acceptance of this conclusion does not, however, imply a negative answer to the question formulated above. The Society for Psychical Research had accumulated an impressive and, to almost all those who had first-hand acquaintance with it, a convincing mass of experimental evidence of the reality of telepathy (*q.v.*), the influence of mind on mind otherwise than through the recognized channels of sense. The successful experiments had for the most part been made between persons in close proximity, in the same room or in adjoining rooms; but they seemed to show that the state of consciousness of one person may induce directly (*i.e.* without the mediation of the organs of expression and sense-perception) a similar state of consciousness in another person, especially if the former, usually called the "agent," strongly desired or "willed" that this effect should be produced on the other person, the "percipient."

The question formulated above thus resolved itself for Gurney into the more definite form, "Can we find any good reason for believing that coincidental hallucinations are sometimes veridical, that the state of mind of a person at some great crisis of his experience may telepathically induce in the mind of some distant relative or friend an hallucinatory perception of himself?" It was at once obvious that, if coincidental apparitions can be proved to occur, this question can only be answered by a statistical inquiry; for each such coincidental hallucination, considered alone, may always be regarded as most educated persons of the present time have regarded them, namely, as merely accidental coincidences. That the coincidences are not merely accidental can only be proved by showing that they occur more frequently than the doctrine of chances would justify us in expecting. Now, the death of any person is a unique event, and the probability of its occurrence upon any particular day may be very simply calculated from the mortality statistics, if we assume that nothing is known of the individual's vitality. On the other hand, hallucinatory perceptions of persons, occurring to sane and healthy individuals in the fully waking state, are comparatively rare occurrences, whose frequency we may hope to determine by a statistical inquiry. If, then, we can obtain figures expressing the frequency of such hallucinations, we can deduce, by the help of the laws of chance, the proportion of such hallucinations that may be expected to coincide with (or, for the purposes of the inquiry, to fall within twelve hours of) the death of the person whose apparition appears, if no causal relation obtains between the coinciding events. If, then, it appears that the proportion of such coincidental hallucinations is greater than the laws of probability will account for, a certain presumption of a causal relation between the coinciding events is thereby established; and the greater the excess of such coincidences, the stronger does this presumption become. Gurney attempted a census of hallucinations in order to obtain data for this statistical treatment, and the results of it, embodied in *Phantasms of the Living*, were considered by the authors of that work to justify the belief that some coincidental hallucinations are veridical. In the year 1886 the Society for Psychical Research appointed a committee, under the chairmanship of the late Henry Sidgwick, to make a second census of hallucinations on a more extensive and systematic plan than the first, in order that the important conclusion reached by the authors of *Phantasms of the Living* might be put to the severest test rendered possible by a larger and more carefully collected mass of data. Seventeen thousand adults returned answers to the question, "Have you ever, when believing yourself to be completely awake, had a vivid impression of seeing or being touched by a living being or inanimate object, or of hearing a voice; which impression, so far as you could discover, was not due to any external physical cause?" Rather more than two thousand persons answered affirmatively, and to each of these were addressed careful inquiries concerning their hallucinatory experiences. In this way it was found that of the total number, 381 apparitions of persons living at the moment (or not more than twelve hours dead) had been recognized by the percipients, and that, of these, 80 were alleged to have been experienced within twelve hours of the death of the person whose apparition had appeared. A careful review of all the facts, conditions and probabilities, led the committee to estimate that the former number should be enlarged to 1300 in order to make ample allowance for forgetfulness and for all other causes that might have tended to prevent the registration of apparitions of this class. On the other hand, a severe criticism of the alleged death-coincidences led them to reduce the number, admitted by them for the purposes of their calculation, to 30. The making of these adjustments gives us about 1 in 43 as the proportion of coincidental death-apparitions to the total number of recognized apparitions among the 17,000 persons reached by the census. Now the death-rate being just over 10 per thousand, the probability that any person taken at random will die on a given day is about 1 in 10,000; or, more strictly speaking, the average probability that any person will die within any given period of twenty-four hours duration

is about 1 in 19,000. Hence the probability that any other particular event, having no causal relation to his death, but occurring during his lifetime (or not later than twelve hours after his death) will fall within the same twenty-four hours as his death is 1 in 19,000; i.e. if an apparition of any individual is seen and recognized by any other person, the probability of its being experienced within twelve hours of that individual's death is 1 in 19,000, if no causal relation obtains between the two events. Therefore, of all recognized apparitions of living persons, 1 only in 19,000 may be expected to be a death-coincidence of this sort. But the census shows that of 1300 recognized apparitions of living persons 30 are death-coincidences and that is equivalent to 440 in 19,000. Hence, of recognized hallucinations, those coinciding with death are 440 times more numerous than we should expect, if no causal relation obtained; therefore, if neither the data nor the reasoning can be destructively criticized, we are compelled to believe that some causal relation obtains; and, since good evidence of telepathic communication has been experimentally obtained, the least improbable explanation of these death-apparitions is that the dying person exerts upon his distant friend some telepathic influence which generates an hallucinatory perception of himself.

These death-coincidences constitute the main feature of the argument in favour of telepathic communication between distant persons, but the census of hallucinations afforded other data from which a variety of arguments, tending to support this conclusion, were drawn by the committee; of these the most important are the cases in which the hallucinatory percept embodied details that were connected with the person perceived and which could not have become known to the percipient by any normal means. The committee could not find in the results of the census any evidence sufficient to justify a belief that hallucinations may be due to telepathic influence exerted by personalities surviving the death of the body.

The critical handling of the cases by the committee seems to be above reproach. Those who do not accept their conclusion based on the death-coincidences must direct their criticism to the question of the reliability of the reports of these cases. It is to be noted that, although only those cases are reckoned in which the percipient had no cause to expect the death of the person whose apparition he experienced, and although, in nearly all the accepted cases, some record or communication of the hallucination was made before hearing of the death, yet in very few cases was any contemporary written record of the event forthcoming for the inspection of the committee. (W. McD.)

HALLUIN, a frontier town of northern France, in the department of Nord, near the right bank of the Lys, 14 m. N. by E. of Lille by rail. Pop. (1906) town, 11,670; commune, 16,158. Its church is of Gothic architecture. The manufactures comprise linen and cotton goods, chairs and rubber goods, and brewing and tanning are carried on; there is a board of trade arbitration. The family of Halluin is mentioned as early as the 13th century. In 1587 the title of duke and peer of the realm was granted to it, but in the succeeding century it became extinct.

HALM, CARL FELIX (1809-1882), German classical scholar and critic, was born at Munich on the 5th of April 1809. In 1849, after having held appointments at Spire and Hadamar, he became rector of the newly founded Maximiliansgymnasium at Munich, and in 1856 director of the royal library and professor in the university. These posts he held till his death on the 5th of October 1882. It is chiefly as the editor of Cicero and other Latin prose authors that Halm is known, although in early years he also devoted considerable attention to Greek. After the death of J. C. Orelli, he joined J. G. Baiter in the preparation of a revised critical edition of the rhetorical and philosophical writings of Cicero (1854-1862). His school editions of some of the speeches of Cicero in the Haupt and Sauppe series, with notes and introductions, were very successful. He also edited a number of classical texts for the Teubner series, the most important of which are Tacitus (4th ed., 1883); *Rhetores Latini minores* (1863); Quintilian (1868); Sulpicius Severus (1866); Minucius Felix together with Firmicus Maternus *De errore*

(1867); Salvianus (1877) and Victor Vitensis's *Historia persecutionis Africanae provinciae* (1878). He was also an enthusiastic collector of autographs.

See articles by W. Christ and G. Laubmann in *Allgemeine deutsche Biographie* and by C. Bursian in *Biographisches Jahrbuch*; and J. E. Sandys, *Hist. of Classical Scholarship*, iii. 195 (1908).

HALMA (Greek for "jump"), a table game, a form of which was known to the ancient Greeks, played on a board divided into 256 squares with wooden *men*, resembling chess pawns. In the two-handed game 19 men are employed on each side, coloured respectively black and white; in the four-handed each player has 13, the men being coloured white, black, red and green. At the beginning of the game the men are drawn up in triangular formation in the enclosures, or *yards*, diagonally opposite each other in the corners of the board. The object of each player is to get all his men into his enemy's yard, the player winning who first accomplishes this. The moves are made alternately, the mode of progression being by a *step*, from one square to another immediately adjacent, or by a jump (whence the name), which is the jumping of a man from a square in front of it into an empty square on the other side of it. This corresponds to jumping in draughts, except that, in halma, the hop may be in any direction, over friendly as well as hostile men, and the men jumped over are not taken but remain on the board.

In the four-handed game either each player plays for himself, or two adjacent players play against the other two.

See *Card and Table Games*, by Professor Hoffmann (London, 1903).

HALMAHERA ["great land"; also Jilolo or Gilolo], an island of the Dutch East Indies, belonging to the residency of Ternate, lying under the equator and about 128° E. Its shape is extremely irregular, resembling that of the island of Celebes. It consists of four peninsulas so arranged as to enclose three great bays (Kayu, Bicholi, Weda), all opening towards the east, the northern peninsula being connected with the others by an isthmus only 5 m. wide. On the western side of the isthmus lies another bay, that of Dodinga, in the mouth of which are situated the two islands Ternate and Tidore, whose political importance exceeds that of the larger island (see these articles). Of the four peninsulas of Halmahera the northern and the southern are reckoned to the sultanate of Ternate, the north-eastern and south-eastern to that of Tidore; the former having eleven, the latter three districts. The distance between the extremities of the northern and southern peninsulas, measured along the curve of the west coast, is about 240 m.; and the total area of the island is 6700 sq. m. Knowledge of the island is very incomplete. It appears that the four peninsulas are traversed in the direction of their longitudinal axis by mountain chains 3000 to 4000 ft. high, covered with forest, without a central chain at the nucleus of the island whence the peninsulas diverge. The mountain chains are frequently interrupted by plains, such as those of Weda and Kobi. The northern part of the mountain chain of the northern peninsula is volcanic, its volcanoes continuing the line of those of Makian, Ternate and Tidore. Coral formations on heights in the interior would indicate oscillations of the land in several periods, but a detailed geology of the island is wanting. To the north-east of the northern peninsula is the considerable island of Morotai (635 sq. m.), and to the west of the southern peninsula the more important island of Bachian (*q.v.*) among others. Galela is a considerable settlement, situated on a bay of the same name on the north-east coast, in a well cultivated plain which extends southward and inland. Vegetation is prolific. Rice is grown by the natives, but the sago tree is of far greater importance to them. Dammar and coco-nuts are also grown. The sea yields trepang and pearl shells. A little trade is carried on by the Chinese and Macassars of Ternate, who, crossing the narrow isthmus of Dodinga, enter the bay of Kayu on the east coast. The total population is estimated at 100,000.

The inhabitants are mostly of immigrant Malayan stock. In the northern peninsula are found people of Papuan type, probably representing the aborigines, and a tribe around Galela,

who are Polynesian in physique, possibly remnants, much mixed by subsequent crossings with the Papuan indigenes, of the Caucasian hordes emigrating in prehistoric times across the Pacific. M. Achille Raffray gives a description of them in *Tour du monde* (1879) where photographs will be found. "They are as unlike the Malays as we are, excelling them in tallness of stature and elegance of shape, and being perfectly distinguished by their oval face, with a fairly high and open brow, their aquiline nose and their horizontally placed eyes. Their beards are sometimes thick; their limbs are muscular; the colour of their skins is cinnamon brown. Spears of iron-wood, abundantly barbed, and small bows and bamboo arrows free from poison are their principal weapons." They are further described as having temples (*sabuas*) in which they suspend images of serpents and other monsters as well as the trophies procured by war. They believe in a better life hereafter, but have no idea of a hell or a devil, their evil spirits only tormenting them in the present state.

The Portuguese and Spaniards were better acquainted with Halmahera than with many other parts of the archipelago; they called it sometimes Batu China and sometimes Moro. It was circumnavigated by one of their vessels in 1525, and the general outline of the coasts is correctly given in their maps at a time when separate portions of Celebes, such as Macassar and Menado, are represented as distinct islands. The name (Jilolo) was really that of a native state, the sultan of which had the chief rank among the princes of the Moluccas before he was supplanted by the sultan of Ternate about 1380. His capital, Jilolo, lay on the west coast on the first bay to the north of that of Dodinga. In 1876 Danu Hassan, a descendant of the sultans of Jilolo, raised an insurrection in the island for the purpose of throwing off the authority of the sultans of Tidore and Ternate; and his efforts would probably have been successful but for the intervention of the Dutch. In 1878 a Dutch expedition was directed against the pirates of Tobalal, and they were virtually extirpated. Slavery remains in the interior. Missionary work, carried on in the northern peninsula of Halmahera since 1866, has been fairly successful among the heathen natives, but less so among the Mahomedans, who have often incited the others against the missionaries and their converts.

HALMSTAD, a seaport of Sweden, chief town of the district (*län*) of Halland, on the E. shore of the Cattegat, 76 m. S.S.E. of Gothenburg by the railway to Helsingborg. Pop. (1900), 15,362. It lies at the mouth of the river Nissa, having an inner harbour (15 ft. depth), an outer harbour, and roads giving anchorage (24 to 36 ft.) exposed to S. and N.W. winds. In the neighbourhood there are quarries of granite, which is exported chiefly to Germany. Other industries are engineering, ship-building and brewing, and there are cloth, jute, hat, wood-pulp and paper factories. The principal exports are granite, timber and hats; and butter through Helsingborg and Gothenburg. The imports are coal, machinery and grain. Potatoes are largely grown in the district, and the salmon fisheries are valuable. The castle is the residence of the governor of the province. There are both mineral and sea-water baths in the neighbourhood.

Mention of the church of Halmstad occurs as early as 1462, and the fortifications are mentioned first in 1225. The latter were demolished in 1734. There were formerly Dominican and Franciscan monasteries in the town. The oldest town-privileges date from 1307. During the revolt of the miner Engelbrekt, it twice fell into the hands of the rebels—in 1434 and 1436. The town appears to have been frequently chosen as the meeting-place of the rulers and delegates of the three northern kingdoms; and under the union of Kalmar it was appointed to be the place for the election of a new Scandinavian monarch whenever necessary. The *län* of Halland formed part of the territory of Denmark in Sweden, and accordingly, in 1534, during his war with the Danes, Gustavus Vasa assaulted and took its chief town. In 1660, by the treaty of Copenhagen, the whole district was ceded to Sweden. In 1676 Charles XII. defeated near Halmstad a Danish army which was attempting to retake the district, and since that time Halland has formed part of Sweden.

HALO, a word derived from the Gr. *ἅλος*, a threshing-floor, and afterwards applied to denote the disk of the sun or moon, probably on account of the circular path traced out by the oxen threshing the corn. It was thence applied to denote any luminous ring, such as that viewed around the sun or moon, or portrayed about the beads of saints.

In physical science, a halo is a luminous circle, surrounding the sun or moon, with various auxiliary phenomena, and formed by the reflection and refraction of light by ice-crystals suspended in the atmosphere. The optical phenomena produced by atmospheric water and ice may be divided into two classes, according to the relative position of the luminous ring and the source of light. In the first class we have *halos*, and *coronae*, or "glories," which encircle the luminary; the second class includes *rainbows*, *fog-bows*, *mist-halos*, *anethia* and *mountain-spectres*, whose centres are at the anti-solar point. Here it is only necessary to distinguish halos from coronae. Halos are at definite distances (22° and 46°) from the sun, and are coloured red on the *inside*, being due to refraction; coronae closely surround the sun at variable distances, and are coloured red on the *outside*, being due to diffraction.

The phenomenon of a solar (or lunar) halo as seen from the earth is represented in fig. 1; fig. 2 is a diagrammatic sketch showing the appearance as viewed from the zenith; but it is only in exceptional circumstances that all the parts are seen. Encircling the sun or moon (S), there are two circles, known as

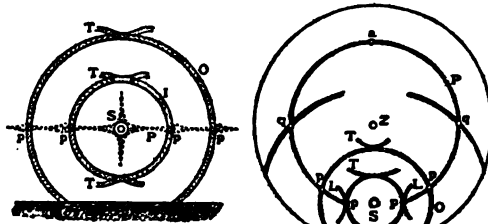

FIG. 1.

FIG. 2.

the inner halo I, and the outer halo O, having radii of about 22° and 46° , and exhibiting the colours of the spectrum in a confused manner, the only decided tint being the red on the inside. Passing through the luminary and parallel to the horizon, there is a white luminous circle, the *parhelic circle* (P), on which a number of images of the luminary appear. The most brilliant are situated at the intersections of the inner halo and the parhelic circle; these are known as *parhelia* (denoted by the letter *p* in the figures) (from the Gr. *παρά*, beside, and *ἥλιος*, the sun) or "mock-suns," in the case of the sun, and as *paraselenae* (from *παρά* and *σελήνη*, the moon) or "mock-moons," in the case of the moon. Less brilliant are the parhelia of the outer halo. The parhelia are most brilliant when the sun is near the horizon. As the sun rises, they pass a little beyond the halo and exhibit flaming tails. The other images on the parhelic circle are the *paranethia* (q) and the *anethion* (a) (from the Greek *ἀντί*, opposite, and *ἥλιος*, the sun). The former are situated at from 90° to 140° from the sun; the latter is a white patch of light situated at the anti-solar point and often exceeding in size the apparent diameter of the luminary. A vertical circle passing through the sun may also be seen. From the parhelia of the inner halo two oblique curves (L) proceed. These are known as the "arcs of Lowitz," having been first described in 1794 by Johann Tobias Lowitz (1757-1804). Luminous arcs (T), tangential to the upper and lower parts of each halo, also occur, and in the case of the inner halo, the arcs may be prolonged to form a quasi-elliptical halo.

The physical explanation of halos originated with René Descartes, who ascribed their formation to the presence of ice-crystals in the atmosphere. This theory was adopted by Edmé Mariotte, Sir Isaac Newton and Thomas Young; and, although

certain of their assumptions were somewhat arbitrary, yet the general validity of the theory has been demonstrated by the researches of J. G. Galle and A. Bravais. The memoir of the last-named, published in the *Journal de l'École royale polytechnique* for 1847 (xviii., 1-270), ranks as a classic on the subject; it is replete with examples and illustrations, and discusses the various phenomena in minute detail.

The usual form of ice-crystals in clouds is a right hexagonal prism, which may be elongated as a needle or foreshortened like a thin plate. There are three refracting angles possible, one of 120° between two adjacent prism faces, one of 60° between two alternate prism faces, and one of 90° between a prism face and the base. If innumerable numbers of such crystals fall in any manner between the observer and the sun, light falling upon these crystals will be refracted, and the refracted rays will be crowded together in the position of minimum deviation (see REFRACTION OF LIGHT). Mariotte explained the inner halo as being due to refraction through a pair of alternate faces, since the minimum deviation of an ice-prism whose refracting angle is 60° is about 22° . Since the minimum deviation is least for the least refrangible rays, it follows that the red rays will be the least refracted, and the violet the more refracted, and therefore the halo will be coloured red on the inside. Similarly, as explained by Henry Cavendish, the halo of 46° is due to refraction by faces inclined at 90° . The impurity of the colours (due partly to the sun's diameter, but still more to oblique refraction) is more marked in halos than in rainbows; in fact, only the red is at all pure, and as a rule, only a mere trace of green or blue is seen, the external portion of each halo being nearly white.

The two halos are the only phenomena which admit of explanation without assigning any particular distribution to the ice-crystals. But it is obvious that certain distributions will predominate, for the crystals will tend to fall so as to offer the least resistance to their motion; a needle-shaped crystal tending to keep its axis vertical, a plate-shaped crystal to keep its axis horizontal. Thomas Young explained the parhelic circle (P) as due to reflection from the vertical faces of the long prisms and the bases of the short ones. If these vertical faces become very numerous, the eye will perceive a colourless horizontal circle. Reflection from an excess of horizontal prisms gives rise to a vertical circle passing through the sun.

The parhelia (p) were explained by Mariotte as due to refraction through a pair of alternate faces of a vertical prism. When the sun is near the horizon the rays fall upon the principal section of the prisms; the minimum deviation for such rays is 22° , and consequently the parhelia are not only on the inner halo, but also on the parhelic circle. As the sun rises, the rays enter the prisms more and more obliquely, and the angle of minimum deviation increases; but since the emergent ray makes the same angle with the refracting edge as the incident ray, it follows that the parhelia will remain on the parhelic circle, while receding from the inner halo. The different values of the angle of minimum deviation for rays of different refrangibilities give rise to spectral colours, the red being nearest the sun, while farther away the overlapping of the spectra forms a flaming colourless tail sometimes extending over as much as 10° to 20° . The "arcs of Lowitz" (L) are probably due to small oscillations of the vertical prisms.

The "tangential arcs" (T) were explained by Young as being caused by the thin plates with their axes horizontal, refraction taking place through alternate faces. The axes will take up any position, and consequently give rise to a continuous series of parhelia which touch externally the inner halo, both above and below, and under certain conditions (such as the requisite altitude of the sun) form two closed elliptical curves; generally, however, only the upper and lower portions are seen. Similarly, the tangential arcs to the halo of 46° are due to refraction through faces inclined at 90° .

The paranthelia (q) may be due to two internal or two external reflections. A pair of triangular prisms having a common face, or a stellate crystal formed by the symmetrical interpenetration of two triangular prisms admits of two internal reflections by

faces inclined at 120° , and so give rise to two colourless images each at an angular distance of 120° from the sun. Double internal reflection by a triangular prism would form a single coloured image on the parhelic circle at about 98° from the sun. These angular distances are attained only when the sun is on the horizon, and they increase as it rises.

The anthelion (a) may be explained as caused by two internal reflections of the solar rays by a hexagonal lamellar crystal, having its axis horizontal and one of the diagonals of its base vertical. The emerging rays are parallel to their original direction and form a colourless image on the parhelic circle opposite the sun.

REFERENCES.—Auguste Bravais's celebrated memoir, "Sur les halos et les phénomènes optiques qui les accompagnent" (*Journ. École poly.* vol. xviii., 1847), contains a full account of the geometrical theory. See also E. Mascart, *Traité d'optique*; J. Ferster, *Meteorologische Optik* (1902-1905); and R. S. Heath, *Geometrical Optics*.

HALOGENS. The word halogen is derived from the Greek $\alpha\lambda\omicron\varsigma$ (sea-salt) and $\gamma\epsilon\nu\omega$ (to produce), and consequently means the sea-salt producer. The term is applied to the four elements fluorine, chlorine, bromine and iodine, on account of the great similarity of their sodium salts to ordinary sea-salt. These four elements show a great resemblance to one another in their general chemical behaviour, and in that of their compounds, whilst their physical properties show a gradual transition. Thus, as the atomic weight increases, the state of aggregation changes from that of a gas in the case of fluorine and chlorine, to that of a liquid (bromine) and finally to that of the solid (iodine); at the same time the melting and boiling points rise with increasing atomic weights. The halogen of lower atomic weight can displace one of higher atomic weight from its hydrogen compound, or from the salt derived from such hydrogen compound, while, on the other hand, the halogen of higher atomic weight can displace that of lower atomic weight, from the halogen oxy-acids and their salts; thus iodine will liberate chlorine from potassium chlorate and also from perchloric acid. All four of the halogens unite with hydrogen, but the affinity for hydrogen decreases as the atomic weight increases, hydrogen and fluorine uniting explosively at very low temperatures and in the dark, whilst hydrogen and iodine unite only at high temperatures, and even then the resulting compound is very readily decomposed by heat. The hydrides of the halogens are all colourless, strongly fuming gases, readily soluble in water and possessing a strong acid reaction; they react readily with basic oxides, forming in most cases well defined crystalline salts which resemble one another very strongly. On the other hand the stability of the known oxygen compounds increases with the atomic weight, thus iodine pentoxide is, at ordinary temperatures, a well-defined crystalline solid, which is only decomposed on heating strongly, whilst chlorine monoxide, chlorine peroxide, and chlorine heptoxide are very unstable, even at ordinary temperatures, decomposing at the slightest shock. Compounds of fluorine and oxygen, and of bromine and oxygen, have not yet been isolated. In some respects there is a very marked difference between fluorine and the other members of the group, for, whilst sodium chloride, bromide and iodide are readily soluble in water, sodium fluoride is much less soluble; again, silver chloride, bromide and iodide are practically insoluble in water, whilst, on the other hand, silver fluoride is appreciably soluble in water. Again, fluorine shows a great tendency to form double salts, which have no counterpart among the compounds formed by the other members of the family.

HALS, FRANS (1580?-1666), Dutch painter, was born at Antwerp according to the most recent authorities in 1580 or 1581, and died at Haarlem in 1666. As a portrait painter second only to Rembrandt in Holland, he displayed extraordinary talent and quickness in the exercise of his art coupled with improvidence in the use of the means which that art secured to him. At a time when the Dutch nation fought for independence and won it, Hals appears in the ranks of its military gilds. He was also a member of the Chamber of Rhetoric, and (1644) chairman of the Painters' Corporation at Haarlem. But as a man he had failings. He so ill-treated his first wife, Anneke Hermansz,

that she died prematurely in 1616; and he barely saved the character of his second, Lysbeth Reyniers, by marrying her in 1617. Another defect was partiality to drink, which led him into low company. Still he brought up and supported a family of ten children with success till 1652, when the forced sale of his pictures and furniture, at the suit of a baker to whom he was indebted for bread and money, brought him to absolute penury. The inventory of the property seized on this occasion only mentions three mattresses and bolsters, an armoire, a table and five pictures. This humble list represents all his worldly possessions at the time of his bankruptcy. Subsequently to this he was reduced to still greater straits, and his rent and firing were paid by the municipality, which afterwards gave him (1664) an annuity of 200 florins. We may admire the spirit which enabled him to produce some of his most striking works in his unhappy circumstances: we find his widow seeking outdoor relief from the guardians of the poor, and dying obscurely in a hospital.

Hals's pictures illustrate the various strata of society into which his misfortunes led him. His banquets or meetings of officers, of sharpshooters, and goldsmen are the most interesting of his works. But they are not more characteristic than his low-life pictures of itinerant players and singers. His portraits of gentlefolk are true and noble, but hardly so expressive as those of fishwives and tavern heroes.

His first master at Antwerp was probably van Noort, as has been suggested by M. G. S. Davies, but on his removal to Haarlem Frans Hals entered the atelier of van Mander, the painter and historian, of whom he possessed some pictures which went to pay the debt of the baker already alluded to. But he soon improved upon the practice of the time, illustrated by J. van Schoreel and Antonio Moro, and, emancipating himself gradually from tradition, produced pictures remarkable for truth and dexterity of hand. We prize in Rembrandt the golden glow of effects based upon artificial contrasts of low light in immeasurable gloom. Hals was fond of daylight of silvery sheen. Both men were painters of touch, but of touch on different keys—Rembrandt was the bass, Hals the treble. The latter is perhaps more expressive than the former. He seizes with rare intuition a moment in the life of his sitters. What nature displays in that moment he reproduces thoroughly in a very delicate scale of colour, and with a perfect mastery over every form of expression. He becomes so clever at last that exact tone, light and shade, and modelling are all obtained with a few marked and fluid strokes of the brush.

In every form of his art we can distinguish his earlier style from that of later years. It is curious that we have no record of any work produced by him in the first decade of his independent activity, save an engraving by Jan van de Velde after a lost portrait of "The Minister Johannes Bogardus," who died in 1614. The earliest works by Frans Hals that have come down to us, "Two Boys Playing and Singing" in the gallery of Cassel, and a "Banquet of the officers of the 'St Joris Doele'" or Arquebusiers of St George (1616) in the museum of Haarlem, exhibit him as a careful draughtsman capable of great finish, yet spirited withal. His flesh, less clear than it afterwards becomes, is pastose and burnished. Later he becomes more effective, displays more freedom of hand, and a greater command of effect. At this period we note the beautiful full-length of "Madame van Berestejn" at the Louvre in Paris, and a splendid full-length portrait of "Willem van Heythuysen" leaning on a sword in the Liechtenstein collection at Vienna. Both these pictures are equalled by the other "Banquet of the officers of the Arquebusiers of St George" (with different portraits) and the "Banquet of the officers of the 'Cloveniers Doelen'" or Arquebusiers of St Andrew of 1627 and an "Assembly of the officers of the Arquebusiers of St Andrew" of 1633 in the Haarlem Museum. A picture of the same kind in the town hall of Amsterdam, with the date of 1637, suggests some study of the masterpieces of Rembrandt, and a similar influence is apparent in a picture of 1641 at Haarlem, representing the "Regents of the Company of St Elizabeth" and in the

portrait of "Maria Voogt" at Amsterdam. But Rembrandt's example did not create a lasting impression on Hals. He gradually dropped more and more into grey and silvery harmonies of tone; and two of his canvases, executed in 1664, "The Regents and Regentesses of the Oudemanshuis" at Haarlem, are masterpieces of colour, though in substance all but monochromes. In fact, ever since 1641 Hals had shown a tendency to restrict the gamut of his palette, and to suggest colour rather than express it. This is particularly noticeable in his flesh tints which from year to year became more grey, until finally the shadows were painted in almost absolute black, as in the "Tymane Oosdorp," of the Berlin Gallery. As this tendency coincides with the period of his poverty, it has been suggested that one of the reasons, if not the only reason, of his predilection for black and white pigment was the cheapness of these colours as compared with the costly lakes and carmines.

As a portrait painter Frans Hals had scarcely the psychological insight of a Rembrandt or Velazquez, though in a few works, like the "Admiral de Ruyter," in Earl Spencer's collection, the "Jacob Olycan" at the Hague Gallery, and the "Albert van der Meer" at Haarlem town hall, he reveals a searching analysis of character which has little in common with the instantaneous expression of his so-called "character" portraits. In these he generally sets upon the canvas the fleeting aspect of the various stages of merriment, from the subtle, half ironic smile that quivers round the lips of the curiously misnamed "Laughing Cavalier" in the Wallace Collection to the imbecile grin of the "Hille Bobbe" in the Berlin Museum. To this group of pictures belong Baron Gustav Rothschild's "Jester," the "*Bohémienne*" at the Louvre, and the "Fisher Boy" at Antwerp, whilst the "Portrait of the Artist with his second Wife" at the Ryks Museum in Amsterdam, and the somewhat confused group of the "Berestejn Family" at the Louvre show a similar tendency. Far less scattered in arrangement than this Berestejn group, and in every respect one of the most masterly of Frans Hals's achievements is the group called "The Painter and his Family" in the possession of Colonel Warde, which was almost unknown until it appeared at the winter exhibition at the Royal Academy in 1906.

Though a visit to Haarlem town hall, which contains the five enormous Doelen groups and the two Regenten pictures, is as necessary for the student of Hals's art as a visit to the Prado in Madrid is for the student of Velazquez, good examples of the Dutch master have found their way into most of the leading public and private collections. In the British Isles, besides the works already mentioned, portraits from his brush are to be found at the National Gallery, the Edinburgh Gallery, the Glasgow Corporation Gallery, Hampton Court, Buckingham Palace, Devonshire House, and the collections of Lord Northbrooke, Lord Ellesmere, Lord Iveagh and Lord Spencer.

At Amsterdam is the celebrated "Flute Player," once in the Dupper collection at Dort; at Brussels, the patrician "Heythuysen"; at the Louvre, "Descartes"; at Dresden, the painter "Van der Vinne." Hals's sitters were taken from every class of society—admirals, generals and burgoasters pairing with merchants, lawyers, clerks. To register all that we find in public galleries would involve much space. There are eight portraits at Berlin, six at Cassel, five at St Petersburg, six at the Louvre, two at Brussels, five at Dresden, two at Gotha. In private collections, chiefly in Paris, Haarlem and Vienna, we find an equally important number. Amongst the painter's most successful representations of fishwives and termagants we should distinguish the "Hille Bobbe" of the Berlin Museum, and the "Hille Bobbe with her Son" in the Dresden Gallery. Itinerant players are best illustrated in the Neville-Goldsmith collection at the Hague, and the Six collection at Amsterdam. Boys and girls singing, playing or laughing, or men drinking, are to be found in the gallery of Schwerin, in the Arenberg collection, and in the royal palace at Brussels.

For two centuries after his death Frans Hals was held in such poor esteem that some of his paintings, which are now among the proudest possessions of public galleries, were sold at auction

for a few pounds or even shillings. The portrait of "Johannes Acronius," now at the Berlin Museum, realized five shillings at the Enschede sale in 1786. The splendid portrait of the man with the sword at the Liechtenstein gallery was sold in 1800 for £4, 5s. With his rehabilitation in public esteem came the enormous rise in values, and, at the Secretan sale in 1880, the portrait of "Pieter van de Broecke d'Anvers" was bid up to £4470, while in 1908 the National Gallery paid £25,000 for the large group from the collection of Lord Talbot de Malahide.

Of the master's numerous family none has left a name except FRANS HALS THE YOUNGER, born about 1622, who died in 1669. His pictures represent cottages and poultry; and the "Vanitas" at Berlin, a table laden with gold and silver dishes, cups, glasses and books, is one of his finest works and deserving of a passing glance.

Quite in another form, and with much of the freedom of the elder Hals, DIRK HALS, his brother (born at Haarlem, died 1656), is a painter of festivals and ball-rooms. But Dirk had too much of the freedom and too little of the skill in drawing which characterized his brother. He remains second on his own ground to Palamedes. A fair specimen of his art is a "Lady playing a Harpsichord to a Young Girl and her Lover" in the van der Hoop collection at Amsterdam, now in the Ryks Museum. More characteristic, but not better, is a large company of gentle-folk rising from dinner, in the Academy at Vienna.

LITERATURE.—See W. Bode, *Frans Hals und seine Schule* (Leipzig, 1871); W. Unger and W. Voormer, *Etchings after Frans Hals* (Leyden, 1873); Percy Rendell Head, *Sir Anthony Van Dyck and Frans Hals* (London, 1879); D. Knackfuss, *Frans Hals* (Leipzig, 1896); G. S. Davies, *Frans Hals* (London, 1902). (P. G. K.)

HALSBURY, HARDINGE STANLEY GIFFARD, 1ST EARL OF (1825-), English lord chancellor, son of Stanley Lees Giffard, LL.D., was born in London on the 3rd of September 1825. He was educated at Merton College, Oxford, and was called to the bar at the Inner Temple in 1850, joining the North Wales and Chester circuit. Afterwards he had a large practice at the central criminal court and the Middlesex sessions, and he was for several years junior prosecuting counsel to the treasury. He was engaged in most of the celebrated trials of his time, including the Overend and Gurney and the Tichborne cases. He became queen's counsel in 1865, and a bencher of the Inner Temple. Mr Giffard twice contested Cardiff in the Conservative interest, in 1868 and 1874, but he was still without a seat in the House of Commons when he was appointed solicitor-general by Disraeli in 1875 and received the honour of knighthood. In 1877 he succeeded in obtaining a seat, when he was returned for Launceston, which borough he continued to represent until his elevation to the peerage in 1885. He was then created Baron Halsbury and appointed lord chancellor, thus forming a remarkable exception to the rule that no criminal lawyer ever reaches the woolsack. Lord Halsbury resumed the position in 1886 and held it until 1892 and again from 1895 to 1905, his tenure of the office, broken only by the brief Liberal ministries of 1886 and 1892-1895, being longer than that of any lord chancellor since Lord Eldon. In 1898 he was created earl of Halsbury and Viscount Tiverton. Among Conservative lord chancellors Lord Halsbury must always hold a high place, his grasp of legal principles and mastery in applying them being pre-eminent among the judges of his day.

HALSTEAD, a market-town in the Maldon parliamentary division of Essex, England, on the Colne, 17 m. N.N.E. from Chelmsford; served by the Colne Valley railway from Chappel Junction on the Great Eastern railway. Pop. of urban district (1901), 6073. It lies on a hill in a pleasant wooded district. The church of St Andrew is mainly Perpendicular. It contains a monument supposed to commemorate Sir Robert Bourchier (d. 1349), lord chancellor to Edward III. The Lady Mary Ramsay grammar school dates from 1594. There are large silk and crape works. Two miles N. of Halstead is Little Maplestead, where the church is the latest in date of the four churches with round naves extant in England, being perhaps of 12th-century foundation, but showing early Decorated work in the main. The chancel, which is without aisles, terminates in an apse.

Three miles N.W. from Halstead are the large villages of Sible Hedingham (pop. 1701) and Castle Hedingham (pop. 1007). At the second is the Norman keep of the de Veres, of whom Aubrey de Vere held the lordship from William I. The keep dates from the end of the 11th century, and exhibits much fine Norman work. The church of St Nicholas, Castle Hedingham, has fine Norman, Transitional and Early English details, and there is a black marble tomb of John de Vere, 15th earl of Oxford (d. 1540), with his countess.

There are signs of settlement at Halstead (Halsteda, Halgusted, Halsted) in the Bronze Age; but there is no evidence of the causes of its growth in historic times. Probably its situation on the river Colne made it to some extent a local centre. Throughout the middle ages Halstead was unimportant, and never rose to the rank of a borough.

HALT. (1) An adjective common to Teutonic languages and still appearing in Swedish and Danish, meaning lame, crippled. It is also used as a verb, meaning to limp, and as a substantive, especially in the term "string-halt" or "spring-halt," a nervous disorder affecting the muscles of the hind legs of horses. (2) A pause or stoppage made on a march or a journey. The word came into English in the form "to make alto" or "alt," and was taken from the French *faire alto* or Italian *far alto*. The origin is a German military term, *Halt machen*, *Halt* meaning "hold."

HALONTIUM (Gr. Ἀλόντιον, mod. S. Marco d'Alunzio), an ancient city of Sicily, 6 m. from the north coast and 25 m. E.N.E. of Halæsa. It was probably of Sicel origin, though its foundation was ascribed to some of the companions of Aeneas. It appears first in Roman times as a place of some importance, and suffered considerably at the hands of Verres. The abandoned church of S. Mark, just outside the modern town, is built into the *cella* of an ancient Greek temple, which measures 62 ft. by 18. A number of ancient inscriptions have been found there.

HALYBURTON, JAMES (1518-1589), Scottish reformer, was born in 1518, and was educated at St Andrews, where he graduated M.A. in 1538. From 1553 to 1586 he was provost of St Andrews and a prominent figure in the national life. He was chosen as one of the lords of the congregation in 1557, and commanded the contingents sent by Forfar and Fife against the queen regent in 1559. He took part in the defence of Edinburgh, and in the battles of Langside (1568) and Restalrig (1571). He had stoutly opposed the marriage of Mary with Darnley, and when, after Restalrig, he was captured by the queen's troops, he narrowly escaped execution. He represented Morton at the conference of 1578, and was one of the royal commissioners to the General Assembly in 1582 and again in 1588. He died in February 1589.

HALYBURTON, THOMAS (1674-1712), Scottish divine, was born at Dupplin, near Perth, on the 25th of December 1674. His father, one of the ejected ministers, having died in 1682, he was taken by his mother in 1685 to Rotterdam to escape persecution, where he for some time attended the school founded by Erasmus. On his return to his native country in 1687 he completed his elementary education at Perth and Edinburgh, and in 1696 graduated at the university of St Andrews. In 1700 he was ordained minister of the parish of Ceres, and in 1710 he was recommended by the synod of Fife for the chair of theology in St Leonard's College, St Andrews, to which accordingly he was appointed by Queen Anne. After a brief term of active professional life he died from the effects of overwork in 1712.

The works by which he continues to be known were all of them published after his death. Wesley and Whitefield were accustomed to commend them to their followers. They were published as follows: *Natural Religion Insufficient, and Revealed Religion Necessary, to Man's Happiness in his Present State* (1714), an able statement of the orthodox Calvinistic criticism of the deism of Lord Herbert of Cherbury and Charles Blount; *Memoirs of the Life of Mr Thomas Halyburton* (1715), three parts by his own hand, the fourth from his diary by another hand; *The Great Concern of Salvation* (1721), with a word of commendation by I. Watts; *Ten Sermons Preached Before and After the Lord's Supper* (1722); *The Unpardonable Sin Against the Holy Ghost* (1784). See Halyburton's *Memoirs* (1714).

HAM, in the Bible. (1) *ḥām*, in Gen. v. 32, vi. 20, vii. 13, ix. 18, x. 5, 1 Chron. i. 4, the *second* son of Noah; in Gen. ix. 24, the *youngest* son (but cf. below); and in Gen. x. 6, 1 Chron. i. 8, the father of Cush (Ethiopia), Mizraim (Egypt), Phut and Canaan. Genesis x. exhibits in the form of genealogies the political, racial and geographical relations of the peoples known to Israel; as it was compiled from various sources and has been more than once edited, it does not exactly represent the situation at any given date,¹ but Ham seems to stand roughly for the south-western division of the world as known to Israel, which division was regarded as the natural sphere of influence of Egypt. Ham is held to be the Egyptian word *Kham* (black) which was the native name of Egypt; thus in Pss. lxxviii. 51, cv. 23, 27, cvi. 22, Ham = Egypt. In Gen. ix. 20-26 Canaan was originally the third son of Noah and the villain of the story. Ham is a later addition to harmonize with other passages.

(2) *ḥām*, 1 Chron. iv. 40, apparently the name of a place or tribe. It can hardly be identical with (1); nothing else is known of this second Ham, which may be a scribe's error; the Syriac version rejects the name.

(3) *ḥām*, Gen. xiv. 5; the place where Chedorlaomer defeated the Zuzim, apparently in eastern Palestine. The place is unknown, and the name may be a scribe's error, perhaps for Ammon. (W. H. Bz.)

HAM, a small town of northern France, in the department of Somme, 36 m. E.S.E. of Amiens on the Northern railway between that city and Laon. Pop. (1906), 2957. It stands on the Somme in a marshy district where market-gardening is carried on. From the 9th century onwards it appears as the seat of a lordship which, after the extinction of its hereditary line, passed in succession to the houses of Coucy, Enghien, Luxembourg, Rohan, Vendôme and Navarre, and was finally united to the French crown on the accession of Henry IV. Notre-Dame, the church of an abbey of canons regular of St. Augustin, dates from the 12th and 13th centuries, but in 1760 all the inflammable portions of the building were destroyed by a conflagration caused by lightning, and a process of restoration was subsequently carried out. Of special note are the bas-reliefs of the nave and choir, executed in the 17th and 18th centuries, and the crypt of the 12th century, which contains the sepulchral effigies of Odo IV. of Ham and his wife Isabella of Béthencourt. The castle, founded before the 10th century, was rebuilt early in the 13th, and extended in the 14th; its present appearance is mainly due to the constable Louis of Luxembourg, count of St. Pol, who between 1436 and 1470 not only furnished it with outworks, but gave such a thickness to the towers and curtains, and more especially to the great tower or donjon which still bears his motto *Mon Myens*, that the great engineer and architect Viollet-le-Duc considered them, even in the 19th century, capable of resisting artillery. It forms a rectangle 395 ft. long by 263 ft. broad, with a round tower at each angle and two square towers protecting the curtains. The eastern and western sides are each defended by a demi-lune. The Constable's Tower, for so the great tower is usually called in memory of St. Pol, has a height of about 100 ft., and the thickness of the walls is 36 ft.; the interior is occupied by three large hexagonal chambers in as many stories. The castle of Ham, which now serves as barracks, has frequently been used as a state prison both in ancient and modern times, and the list of those who have sojourned there is an interesting one, including as it does Joan of Arc, Louis of Bourbon, the ministers of Charles X., Louis Napoleon, and Generals Cavaignac and Lamoricière. Louis Napoleon was there for six years, and at last effected his escape in the disguise of a workman. During 1870-1871 Ham was several times captured and recaptured by the belligerents. A statue commemorates the birth in the town of General Foy (1775-1825).

See J. G. Cappelot, *Le Château de Ham* (Paris, 1842); and Ch. Gomart, *Ham, son château et ses prisonniers* (Ham, 1864).

¹ A. Jeremias, *Das A.T. im Lichte des alten Orients*, p. 145, holds that it represents the situation in the 8th century B.C.

HAMADĀN, a province and town of Persia. The province is bounded N. by Gerrūs and Khamseh, W. by Kermanshah, S. by Malāyir and Irāk, E. by Savah and Karvin. It has many well-watered, fertile plains and more than four hundred flourishing villages producing much grain, and its population, estimated at 350,000—more than half being Turks of the Karaguzū (black-eyed) and Shāmli (Syrian) tribes—supplies several battalions of infantry to the army, and pays, besides, a yearly revenue of about £18,000.

Hamadān, the capital of the province, is situated 188 m. W.S.W. of Teheran, at an elevation of 5930 ft., near the foot of Mount Elvend (old Persian *Arvand*, Gr. *Orontes*), whose granite peak rises W. of it to an altitude of 11,900 ft. It is a busy trade centre with about 40,000 inhabitants (comprising 4000 Jews and 300 Armenians), has extensive and well-stocked bazars and fourteen large and many small caravanserais. The principal industries are tanning leather and the manufacture of saddles, harnesses, trunks, and other leather goods, felts and copper utensils. The leather of Hamadān is much esteemed throughout the country and exported to other provinces in great quantities. The streets are narrow, and by a system called *Kūcheh-bandī* (street-closing) established long ago for impeding the circulation of crowds and increasing general security, every quarter of the town, or block of buildings, is shut off from its neighbours by gates which are closed during local disorders and regularly at night. Hamadān has post and telegraph offices and two churches, one Armenian, the other Protestant (of the American Presbyterian Mission).

Among objects of interest are the alleged tombs of Esther and Mordecai in an insignificant domed building in the centre of the town. There are two wooden sarcophagi carved all over with Hebrew inscriptions. That ascribed to Mordecai has the verses Isaiah lix. 8; Esther ii. 5; Pa. xvi. 9, 10, 11, and the date of its erection A.M. 4318 (A.D. 557). The inscriptions on the other sarcophagus consist of the verses Esther ix. 29, 32, x. 1; and the statement that it was placed there A.M. 4601 (A.D. 841) by "the pious and righteous woman Gemal Setan." A tablet let into the wall states that the building was repaired A.M. 4474 (A.D. 713). Hamadān also has the grave of the celebrated physician and philosopher Abu Ali ibn Sina, better known as Avicenna (d. 1036). It is now generally admitted that Hamadān is the Hagmatana (of the inscriptions), Agbatana or Ecbatana (*q.v.*, of the Greek writers), the "treasure city" of the Achaemenian kings which was taken and plundered by Alexander the Great, but very few ancient remains have been discovered. A rudely carved stone lion, which lies on the roadside close to the southern extremity of the city, and by some is supposed to have formed part of a building of the ancient city, is locally regarded as a talisman against famine, plague, cold, &c., placed there by Pliny, who is popularly known as the sorcerer Balinā (a corruption of Plinius).

Five miles S.W. from the city in a mountain gorge of Mount Elvend is the so-called Ganjāma (treasure-deed), which consists of two tablets with trilingual cuneiform inscriptions cut into the rock and relating the names and titles of Darius I. (521-485 B.C.) and his son Xerxes I. (485-405 B.C.). (A. H.-S.)

HAMADHĀNĪ, in full **ABU-L FAḌL AHMAD IBN UL-HUSAYN UL-HAMADHĀNĪ** (967-1007), Arabian writer, known as *Bād' uz-Zamān* (the wonder of the age), was born and educated at Hamadhān. In 990 he went to Jorjān, where he remained two years; then passing to Nishapur, where he rivalled and surpassed the learned Khwārizmī. After journeying through Khorāsān and Sijistān, he finally settled in Herāt under the protection of the vizir of Mahmūd, the Ghaznevid sultan. There he died at the age of forty. He was renowned for a remarkable memory and for fluency of speech, as well as for the purity of his language. He was one of the first to renew the use of rhymed prose both in letters and *maqāmas* (see ARABIA: *Literature*, section "Bele's Lettres").

His letters were published at Constantinople (1881), and with commentary at Beirut (1890); his *maqāmas* at Constantinople (1881), and with commentary at Beirut (1889). A good idea of the

letter may be obtained from S. de Sacy's edition of six of the *magistres* with French translation and notes in his *Chrestomathie arabe*, vol. iii. (2nd ed., Paris, 1827). A specimen of the letters is translated into German in A. von Kremer's *Culturgeschichte des Orients*, ii. 470 sqq. (Vienna, 1877). (G. W. T.)

HAMAH, the Hamath of the Bible, a Hittite royal city, situated in the narrow valley of the Orontes, 110 English miles N. (by E.) of Damascus. It finds a place in the northern boundaries of Israel under David, Solomon and Jeroboam II. (2 Sam. viii. 9; 1 Kings viii. 65; 2 Kings xiv. 25). The Orontes flows winding past the city and is spanned by four bridges. On the south-east the houses rise 150 ft. above the river, and there are four other hills, that of the *Kalah* or castle being to the north 100 ft. high. Twenty-four minarets rise from the various mosques. The houses are principally of mud, and the town stands amid poplar gardens with a fertile plain to the west. The castle is ruined, the streets are narrow and dirty, but the bazaars are good, and the trade with the Bedouins considerable. The numerous water-wheels (*sa'rah*), of enormous dimension, raising water from the Orontes are the most remarkable features of the view. Silk, woolen and cotton goods are manufactured. The population is about 40,000.

In the year 854 B.C. Hamath was taken by Shalmaneser II., king of Assyria, who defeated a large army of allied Hamathites, Syrians and Israelites at Karkor and slew 14,000 of them. In 738 B.C. Tiglath Pileser III. reduced the city to tribute, and another rebellion was crushed by Sargon in 720 B.C. The downfall of so ancient a state made a great impression at Jerusalem (Isa. x. 9). According to 2 Kings xvii. 24, 30, some of its people were transported to the land of N. Israel, where they made images of Ashima or Eshmun (probably Ishtar). After the Macedonian conquest of Syria Hamath was called Epiphania by the Greeks in honour of Antiochus IV., Epiphanes, and in the early Byzantine period it was known by both its Hebrew and its Greek name. In A.D. 639 the town surrendered to Abu 'Obaida, one of Omar's generals, and the church was turned into a mosque. In A.D. 1108 Tancred captured the city and massacred the Ism'ailite defenders. In 1115 it was retaken by the Moslems, and in 1178 was occupied by Saladin. Abulfeda, prince of Hamah in the early part of the 14th century, is well known as an authority on Arab geography.

HAMANN, JOHANN GEORG (1730-1788), German writer on philosophical and theological subjects, was born at Königsberg in Prussia on the 27th of August 1730. His parents were of humble rank and small means. The education he received was comprehensive but unsystematic, and the want of definiteness in this early training doubtless tended to aggravate the peculiar instability of character which troubled Hamann's after life. In 1746 he began theological studies, but speedily deserted them and turned his attention to law. That too was taken up in a desultory fashion and quickly relinquished. Hamann seems at this time to have thought that any strenuous devotion to "bread-and-butter" studies was lowering, and accordingly gave himself entirely to reading, criticism and philological inquiries. Such studies, however, were pursued without any definite aim or systematic arrangement, and consequently were productive of nothing. In 1752, constrained to secure some position in the world, he accepted a tutorship in a family resident in Livonia, but only retained it a few months. A similar situation in Courland he also resigned after about a year. In both cases apparently the rupture might be traced to the curious and unsatisfactory character of Hamann himself. After leaving his second post he was received into the house of a merchant at Riga named Johann Christoph Behrens, who contracted a great friendship for him and selected him as his companion for a tour through Danzig, Berlin, Hamburg, Amsterdam and London. Hamann, however, was quite unfitted for business, and when left in London, gave himself up entirely to his fancies, and was quickly reduced to a state of extreme poverty and want. It was at this period of his life, when his inner troubles of spirit harmonized with the unhappy external conditions of his lot, that he began an earnest and prolonged study of the Bible; and from this time dates the tone of extreme pietism which is characteristic

of his writings, and which undoubtedly alienated many of his friends. He returned to Riga, and was well received by the Behrens family, in whose house he resided for some time. A quarrel, the precise nature of which is not very clear though the occasion is evident, led to an entire separation from these friends. In 1759 Hamann returned to Königsberg, and lived for several years with his father, filling occasional posts in Königsberg and Mitau. In 1767 he obtained a situation as translator in the excise office, and ten years later a post as storekeeper in a mercantile house. During this period of comparative rest Hamann was able to indulge in the long correspondence with learned friends which seems to have been his greatest pleasure. In 1784 the failure of some commercial speculations greatly reduced his means, and about the same time he was dismissed with a small pension from his situation. The kindness of friends, however, supplied provision for his children, and enabled him to carry out the long-cherished wish of visiting some of his philosophical allies. He spent some time with Jacobi at Pempelfort and with Buchholz at Walbergen. At the latter place he was seized with illness, and died on the 21st of June 1788.

Hamann's works resemble his life and character. They are entirely unsystematic so far as matter is concerned, chaotic and disjointed in style. To a reader not acquainted with the peculiar nature of the man, which led him to regard what commended itself to him as therefore objectively true, they must be, moreover, entirely unintelligible and, from their peculiar, pietistic tone and scriptural jargon, probably offensive. A place in the history of philosophy can be yielded to Hamann only because he expresses in uncouth, barbarous fashion an idea to which other writers have given more effective shape. The fundamental thought is with him the unsatisfactoriness of abstraction or one-sidedness. The *Aufklärung*, with its rational theology, was to him the type of abstraction. Even Epicureanism, which might appear concrete, was by him rightly designated abstract. Quite naturally, then, Hamann is led to object strongly to much of the Kantian philosophy. The separation of sense and understanding is for him unjustifiable, and only paralleled by the extraordinary blunder of severing matter and form. Concreteness, therefore, is the one demand which Hamann expresses, and as representing his own thought he used to refer to Giordano Bruno's conception (previously held by Nicolaus Curanus) of the identity of contraries. The demand, however, remains but a demand. Nothing that Hamann has given can be regarded as in the slightest degree a response to it. His hatred of system, incapacity for abstract thinking, and intense personality rendered it impossible for him to do more than utter the disjointed, oracular, obscure dicta which gained for him among his friends the name of "Magus of the North." Two results only appear throughout his writings—first, the accentuation of belief; and secondly, the transference of many philosophical difficulties to language. Belief is, according to Hamann, the groundwork of knowledge, and he accepts in all sincerity Hume's analysis of experience as being most helpful in constructing a theological view. In language, which he appears to regard as somehow acquired, he finds a solution for the problems of reason which Kant had discussed in the *Kritik der reinen Vernunft*. On the application of these thoughts to the Christian theology one need not enter.

None of Hamann's writings is of great bulk; most are mere pamphlets of some thirty or forty pages. A complete collection has been published by F. Roth (*Schriften*, 8vo, 1821-1842), and by C. H. Gildemeister (*Leben und Schriften*, 6 vols., 1851-1873). See also M. Petri, *Hamanns Schriften u. Briefe*, 4 vols., 1872-1873; J. Poel, *Hamann, der Magus im Norden, sein Leben u. Mitteilungen aus seinen Schriften* (2 vols., 1874-1876); J. Claassen, *Hamanns Leben und Werke* (1885). Also H. Weber, *Neue Hamanniana* (1905). A very comprehensive essay on Hamann is to be found in Hegel's *Vermischte Schriften*, ii. (*Werke*, Bd. xvii.). On Hamann's influence on German literature, see J. Minor, *J. G. Hamann in seiner Bedeutung für die Sturm- und Drang-Periode* (1881).

HAMAR, or STOREHAMMER (GREAT HAMAR), a town of Norway in Hedemarken amt (county), 78 m. by rail N. of Christiania. Pop. (1900), 6003. It is pleasantly situated between two bays of the great Lake Mjøsen, and is the junction of the railways to Trondhjem (N.) and to Otta in Gudbrandsdal (N.W.). The existing town was laid out in 1849, and made a bishop's see in 1864. Near the same site there stood an older town, which, together with a bishop's see, was founded in 1152 by the Englishman Nicholas Breakspere (afterwards Pope Adrian IV.); but both town and cathedral were destroyed by the Swedes in 1567. Remains of the latter include a nave-arcade with rounded arches. The town is a centre for the local agricultural and timber trade.

HAMĀSA (هَامَاة), the name of a famous Arabian anthology compiled by Ḥabīb ibn Aus at-Tibrī, surnamed Abū Tammām (see Abū TAMMĀM). The collection is so called from the title of its first book, containing poems descriptive of constancy and valour in battle, patient endurance of calamity, steadfastness in seeking vengeance, manfulness under reproach and temptation, all which qualities make up the attribute called by the Arabs *ḥamāsah* (briefly paraphrased by at-Tibrī as *ash-shiddah fi-l-amr*). It consists of ten books or parts, containing in all 884 poems or fragments of poems, and named respectively—(1) *al-Hamāsa*, 261 pieces; (2) *al-Marāthi*, "Dirges," 169 pieces; (3) *al-Adab*, "Manners," 54 pieces; (4) *an-Nasīb*, "The Beauty and Love of Women," 139 pieces; (5) *al-Hijā*, "Satires," 80 pieces; (6) *al-Adyāf wa-l-Madāih*, "Hospitality and Panegyric," 143 pieces; (7) *as-Ṣijāt*, "Miscellaneous Descriptions," 3 pieces; (8) *as-Sayr wa-n-Nu'ās*, "Journeying and Drowsiness," 9 pieces; (9) *al-Mulab*, "Pleasantries," 38 pieces; and (10) *Madhammat-an-nisā*, "Dispraise of Women," 18 pieces. Of these books the first is by far the longest, both in the number and extent of its poems, and the first two together make up more than half the bulk of the work. The poems are for the most part fragments selected from longer compositions, though a considerable number are probably entire. They are taken from the works of Arab poets of all periods down to that of Abū Tammām himself (the latest ascertainable date being A.D. 832), but chiefly of the poets of the Ante-Islamic time (*Jāhiliyyān*), those of the early days of Al-Islām (*Mukhadrimān*), and those who flourished during the reigns of the Omayyad caliphs, A.D. 660-749 (*Islāmiyyān*). Perhaps the oldest in the collection are those relating to the war of Basūs, a famous legendary strife which arose out of the murder of Kulaib, chief of the combined clans of Bakr and Taghlib, and lasted for forty years, ending with the peace of Dhu-l-Majāz, about A.D. 534. Of the period of the Abbasid caliphs, under whom Abū Tammām himself lived, there are probably not more than sixteen fragments.

Most of the poems belong to the class of extempore or occasional utterances, as distinguished from *qaṣīdas*, or elaborately finished odes. While the latter abound with comparisons and long descriptions, in which the skill of the poet is exhibited with much art and ingenuity, the poems of the *Hamāsa* are short, direct and for the most part free from comparisons; the transitions are easy, the metaphors simple, and the purpose of the poem clearly indicated. It is due probably to the fact that this style of composition was chiefly sought by Abū Tammām in compiling his collection that he has chosen hardly anything from the works of the most famous poets of antiquity. Not a single piece from Imra 'al-Qais (Amru-ul-Qais) occurs in the *Hamāsa*, nor are there any from 'Alqama, Zuhair or A'shā; Nābigha is represented only by two pieces (pp. 408 and 743 of Freytag's edition) of four and three verses respectively; 'Antara by two pieces of four verses each (*id.* pp. 206, 209); Tarafa by one piece of five verses (*id.* p. 632); Labid by one piece of three verses (*id.* p. 468); and 'Amr ibn Kulthūm by one piece of four verses (*id.* p. 236). The compilation is thus essentially an anthology of minor poets, and exhibits (so far at least as the more ancient poems are concerned) the general average of poetic utterance at a time when to speak in verse was the daily habit of every warrior of the desert.

To this description, however, there is an important exception in the book entitled *an-Nasīb*, containing verses relating to women and love. In the classical age of Arab poetry it was the established rule that all *qaṣīdas*, or finished odes, whatever their purpose, must begin with the mention of women and their charms (*ashshibb*), in order, as the old critics said, that the hearts of the hearers might be softened and inclined to regard kindly the theme which the poet proposed to unfold. The fragments included in this part of the work are therefore generally taken from the opening verses of *qaṣīdas*; where this is not the case, they are chiefly compositions of the early Islamic period, when the school of exclusively erotic poetry (of which the greatest representative was 'Omar ibn Abī Rabi'a) arose.

The compiler was himself a distinguished poet in the style of his day, and wandered through many provinces of the Moslem empire earning money and fame by his skill in panegyric. About 220 A.H. he took himself to Khorasan, then ruled by 'Abdallah ibn Tāhir, whom he praised and by whom he was rewarded; on his journey home to 'Irāk he passed through Hamadhān, and was there detained for many months a guest of Abu-l-Wafā, son of Salama, the road onward being blocked by heavy falls of snow. During his residence at Hamadhān, Abū Tammām is said to have compiled or composed, from the materials which he found in Abu-l-Wafā's library, five poetical works, of which one was the *Hamāsa*. This collection remained as a precious heirloom in the family of Abu-l-Wafā until their fortunes decayed, when it fell into the hands of a man of Dinawar named Abu-l-'Awādhil, who carried it to Isfahān and made it known to the learned of that city.

The worth of the *Hamāsa* as a store-house of ancient legend, of faithful detail regarding the usages of the pagan time and early simplicity of the Arab race, can hardly be exaggerated. The high level of excellence which is found in its selections, both as to form and matter, is remarkable, and caused it to be said that Abū Tammām displayed higher qualities as a poet in his choice of extracts from the ancients than in his own compositions. What strikes us chiefly in the class of poetry of which the *Hamāsa* is a specimen, is its exceeding truth and reality, its freedom from artificiality and hearsay, the evident first-hand experience which the singers possessed of all of which they sang. For historical purposes the value of the collection is not small; but most of all there shines forth from it a complete portrait of the hardy and manful nature, the strenuous life of passion and battle, the lofty contempt of cowardice, niggardliness and servility, which marked the valiant stock who bore Islam abroad in a flood of new life over the outworn civilizations of Persia, Egypt and Byzantium. It has the true stamp of the heroic time, of its cruelty and wantonness as of its strength and beauty.

No fewer than twenty commentaries are enumerated by Hājī Khalīfā. Of these the earliest was by Abū Riyāsh (otherwise ar-Riyāshī), who died in 257 A.H.; excerpts from it, chiefly in elucidation of the circumstances in which the poems were composed, are frequently given by at-Tibrī (Tabrizi). He was followed by the famous grammarian Abu-l-Fath ibn al-Jinnī (d. 392 A.H.), and later by Shihāb ad-Din Ahmad al-Marzūqī of Isfahān (d. 421 A.H.). Upon al-Marzūqī's commentary is chiefly founded that of Abu Zakariyā Yahyā at-Tibrī (b. 421 A.H., d. 502), which has been published by the late Professor G. W. Freytag of Bonn, together with a Latin translation and notes (1828-1851). This monumental work, the labour of a life, is a treasure of information regarding the classical age of Arab literature which has not perhaps its equal for extent, accuracy, and minuteness of detail in Europe. No other complete edition of the *Hamāsa* has been printed in the West; but in 1856 one appeared at Calcutta under the names of Maulavi Ghulam Rabbāni and Kabir-u-d-din Ahmad. Though no acknowledgment of the fact is contained in this edition, it is a simple reprint of Professor Freytag's text (without at-Tibrī's commentary), and follows its original even in the misprints (corrected by Freytag at the end of the second volume, which being in Latin the Calcutta editors do not seem to have consulted). It contains in an appendix of 12 pages a collection of verses (and some entire fragments) not found in at-Tibrī's recension, but stated to exist in some copies consulted by the editors; these are, however, very carelessly edited and printed, and in many places unintelligible. Freytag's text, with at-Tibrī's commentary, has been reprinted at Būlāq (1870). In 1882 an edition of the text, with a marginal commentary by Munsif 'Abdul-Qādir ibn Shaikh Luqmān, was published at Bombay.

The *Hamāsa* has been rendered with remarkable skill and spirit into German verse by the illustrious Friedrich Rückert (Stuttgart, 1846), who has not only given translations of almost all the poems proper to the work, but has added numerous fragments drawn from other sources, especially those occurring in the *scholia* of at-Tibrī, as well as the *Mu'allaqas* of Zuhair and 'Antara, the *Lāmiyya* of Ash-Shanfarā, and the *Bānat Su'ād* of Ka'b, son of Zuhair. A small collection of translations, chiefly in metres imitating those of the original, was published in London by Sir Charles Lyall in 1885.

When the *Hamāsa* is spoken of, that of Abū Tammām, as the first and most famous of the name, is meant; but several collections of a similar kind, also called *Hamāsa*, exist. The best-known and earliest of these is the *Hamāsa* of Buhturī (d. 284 A.H.), of which the unique MS. now in the Leiden University Library, has been reproduced by photo-lithography (1909); a critical edition has been

prepared by Professor Chikho at Beyreuth. Four other works of the same name, formed on the model of Abū Tammām's compilation, are mentioned by Hājīj Khalifa. Besides these, a work entitled *Hamāsāt ar-Rāk* ("the Hamāsā of wise") was composed of Abū-l-'Alā al-Ma'arri (d. 429 A.H.). (C. J. L.)

HAMBURG, a state of the German empire, on the lower Elbe, bounded by the Prussian provinces of Schleswig-Holstein and Hanover. The whole territory has an area of 160 sq. m., and consists of the city of Hamburg with its incorporated suburbs and the surrounding district, including several islands in the Elbe, five small enclaves in Holstein; the communes of Moorburg in the Lüneburg district of the Prussian province of Hanover and Cuxhaven-Ritzbüttel at the mouth of the Elbe, the island of Neuwerk about 5 m. from the coast, and the bailiwick (*amt*) of Bergedorf, which down to 1867 was held in common by Lübeck and Hamburg. Administratively the state is divided into the city, or metropolitan district, and four rural domains (or *Landherrenschaften*), each under a senator as *praeses*, viz. the domain of the Geestlande, of the Marschlande, of Bergedorf and of Ritzbüttel with Cuxhaven. Cuxhaven-Ritzbüttel and Bergedorf are the only towns besides the capital. The Geestlande comprise the suburban districts encircling the city on the north and west; the Marschlande includes various islands in the Elbe and the fertile tract of land lying between the northern and southern arms of the Elbe, and with its pastures and market gardens supplying Hamburg with large quantities of country produce. In the Bergedorf district lies the Vierlande, or Four Districts (Neuengamme, Kirchwärdar, Altengamme and Curslack), celebrated for its fruit gardens and the picturesque dress of the inhabitants. Ritzbüttel with Cuxhaven, also a watering-place, have mostly a seafaring population. Two rivers, the Alster and the Bille, flow through the city of Hamburg into the Elbe, the mouth of which, at Cuxhaven, is 75 m. below the city.

Government.—As a state of the empire, Hamburg is represented in the federal council (*Bundsrat*) by one plenipotentiary, and in the imperial diet (*Reichstag*) by three deputies. Its present constitution came into force on the 1st of January 1861, and was revised in 1879 and again in 1906. According to this Hamburg is a republic, the government (*Staatsgewalt*) residing in two chambers, the Senate and the House of Burgesses. The Senate, which exercises the greater part of the executive power, is composed of eighteen members, one half of whom must have studied law or finance, while at least seven of the remainder must belong to the class of merchants. The members of the Senate are elected for life by the House of Burgesses; but a senator is free to retire from office at the expiry of six years. A chief (*ober-*) and second (*weiter-*) burgomaster, the first of whom bears the title of "Magnificence," chosen annually in secret ballot, preside over the meetings of the Senate, and are usually jurists. No burgomaster can be in office for longer than two years consecutively, and no member of the Senate may hold any other public office. The House of Burgesses consists of 160 members, of whom 80 are elected in secret ballot by the direct suffrages of all tax-paying citizens, 40 by the owners of house-property within the city (also by ballot), and the remaining 40, by ballot also, by the so-called "notables," i. e. active and former members of the law courts and administrative boards. They are elected for a period of six years, but as half of each class retire at the end of three years, new elections for one half the number take place at the end of that time. The House of Burgesses is represented by a *Bürgerausschuss* (committee of the house) of twenty deputies whose duty it is to watch over the proceedings of the Senate and the constitution generally. The Senate can interpose a veto in all matters of legislation, saving taxation, and where there is a collision between the two bodies, provision is made for reference to a court of arbitration, consisting of members of both houses in equal numbers, and also to the supreme court of the empire (*Reichsgericht*) sitting at Leipzig. The law administered is that of the civil and penal codes of the German empire, and the court of appeal for all three Hanse towns is the common *Oberlandesgericht*, which has its seat in Hamburg.

There is also a special court of arbitration in commercial disputes and another for such as arise under accident insurance.

Religion.—The church in Hamburg is completely separated from the state and manages its affairs independently. The ecclesiastical arrangements of Hamburg have undergone great modifications since the general constitution of 1860. From the Reformation to the French occupation in the beginning of the 19th century, Hamburg was a purely Lutheran state; according to the "Recess" of 1529, re-enacted in 1603, non-Lutherans were subject to legal punishment and expulsion from the country. Exceptions were gradually made in favour of foreign residents; but it was not till 1785 that regular inhabitants were allowed to exercise the religious rites of other denominations, and it was not till after the war of freedom that they were allowed to have buildings in the style of churches. In 1860 full religious liberty was guaranteed, and the identification of church and state abolished. By the new constitution of the Lutheran Church, published at first in 1870 for the city only, but in 1876 extended to the rest of the Hamburg territory, the parishes or communes are divided into three church-districts, and the general affairs of the whole community are entrusted to a synod of 53 members and to an ecclesiastical council of 9 members which acts as an executive. Since 1887 a church rate has been levied on the Evangelical-Lutheran communities, and since 1904 upon the Roman Catholics also. The German Reformed Church, the French Reformed, the English Episcopal, the English Reformed, the Roman Catholic, and the Baptist are all recognized by the state. Civil marriages have been permissible in Hamburg since 1866, and since the introduction of the imperial law in January 1876 the number of such marriages has greatly increased.

Finance.—The jurisdiction of the Free Port was on the 1st of January 1882 restricted to the city and port by the extension of the Zollverein to the lower Elbe, and in 1888 the whole of the state of Hamburg, with the exception of the so-called "Free Harbour" (which comprises the port proper and some large warehouses, set apart for goods in bond), was taken into the Zollverein.

Population.—The population increased from 453,000 in 1880 to 622,530 in 1890, and in 1905 amounted to 874,878. The population of the country districts (exclusive of the city of Hamburg) was 72,085 in 1905. The crops raised in the country districts are principally vegetables and fruit, potatoes, hay, oats, rye and wheat. For manufactures and trade statistics see HAMBURG (city).

The military organization of Hamburg was arranged by convention with Prussia. The state furnishes three battalions of the 2nd Hanseatic regiment, under Prussian officers. The soldiers swear the oath of allegiance to the senate.

HAMBURG, a seaport of Germany, capital of the free state of Hamburg, on the right bank of the northern arm of the Elbe, 75 m. from its mouth at Cuxhaven and 178 m. N.W. from Berlin by rail. It is the largest and most important seaport on the continent of Europe and (after London and New York) the third largest in the world. Were it not for political and municipal boundaries Hamburg might be considered as forming with Altona and Ottensen (which lie within Prussian territory) one town. The view of the three from the south, presenting a continuous river frontage of six miles, the river crowded with shipping and the densely packed houses surmounted by church towers—of which three are higher than the dome of St Paul's in London—is one of great magnificence.

The city proper lies on both sides of the little river Alster, which, dammed up a short distance from its mouth, forms a lake, of which the southern portion within the line of the former fortifications bears the name of the Inner Alster (*Binnen Alster*), and the other and larger portion (2500 yards long and 1300 yards at the widest) that of the Outer Alster (*Aussen Alster*). The fortifications as such were removed in 1815, but they have left their trace in a fine girdle of green round the city, though too many inroads on its completeness have been made by railways and roadways. The oldest portion of the city is that which lies

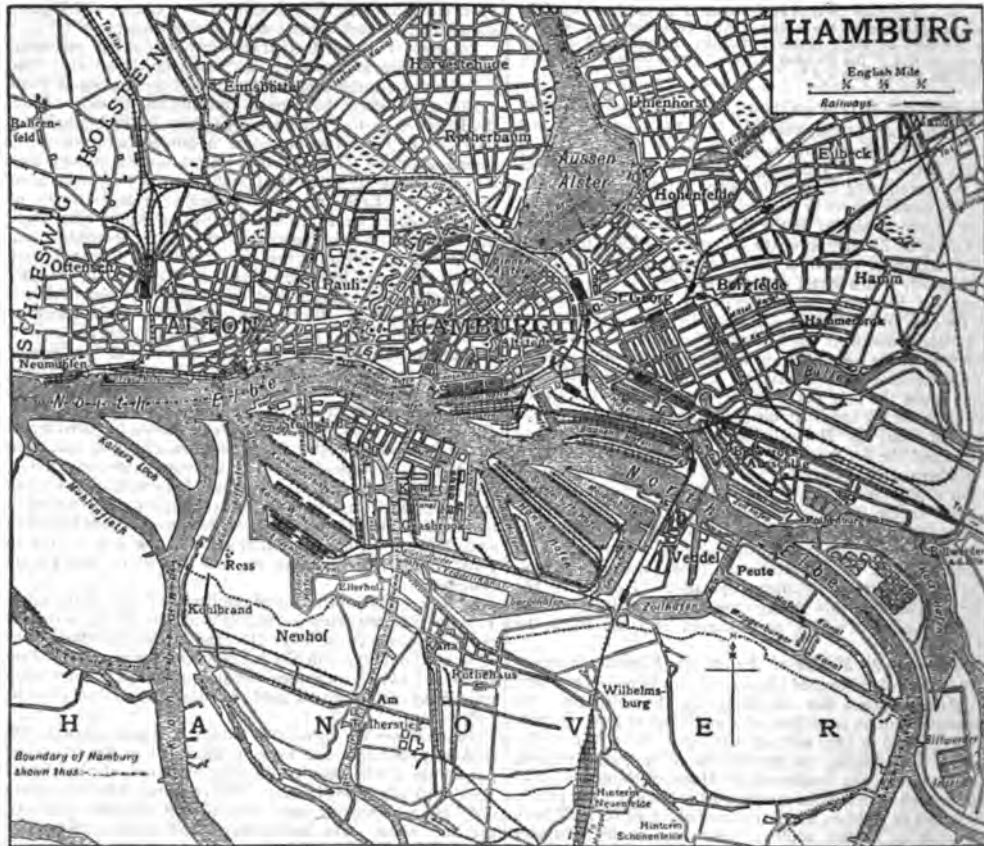

to the east of the Alster; but, though it still retains the name of Altstadt, nearly all trace of its antiquity has disappeared, as it was rebuilt after the great fire of 1842. To the west lies the new town (Neustadt), incorporated in 1678; beyond this and contiguous to Altona is the former suburb of St Pauli, incorporated in 1876, and towards the north-east that of St Georg, which arose in the 13th century but was not incorporated till 1868.

The old town lies low, and it is traversed by a great number of narrow canals or "fleets" (*Fleeten*)—for the same word which has left its trace in London nomenclature is used in the Low German city—which add considerably to the picturesqueness of the meaner quarters, and serve as convenient channels for the transport of goods. They generally form what may be called the back streets, and they are bordered by warehouses, cellars and the lower class of dwelling-houses. As they are subject to the ebb and flow of the Elbe, at certain times they run almost dry. As soon as the telegram at Cuxhaven announces high tide three shots are fired from the harbour to warn the inhabitants of the "fleets"; and if the progress of the tide up the river gives indication of danger, other three shots follow. The "fleets" with their quaint medieval warehouses, which come sheer down to the water, and are navigated by barges, have gained for Hamburg the name of "Northern Venice." They are, however, though antique and interesting, somewhat dismal and unsavoury. In fine contrast to them is the bright appearance of the Binnen

Alster, which is enclosed on three sides by handsome rows of buildings, the Alsterdamm in the east, the Alter Jungfernstieg in the south, and the Neuer Jungfernstieg in the west, while it is separated from the Aussen Alster by part of the rampart gardens traversed by the railway uniting Hamburg with Altona and crossing the lakes by a beautiful bridge—the Lombards-Brücke. Around the outer lake are grouped the suburbs Harvestehude and Pöselldorf on the western shore, and Uhlenhorst on the eastern, with park-like promenades and villas surrounded by well-kept gardens. Along the southern end of the Binnen Alster runs the Jungfernstieg with fine shops, hotels and restaurants facing the water. A fleet of shallow-draught screw steamers provides a favourite means of communication between the business centre of the city and the outlying colonies of villas.

The streets enclosing the Binnen Alster are fashionable promenades, and leading directly from this quarter are the main business thoroughfares, the Neuer-Wall, the Grosse Bleichen and the Hermannstrasse. The largest of the public squares in Hamburg is the Hopfenmarkt, which contains the church of St Nicholas (Nikolaikirche) and is the principal market for vegetables and fruit. Others of importance are the Gänsemarkt, the Zeughausmarkt and the Grossneumarkt. Of the thirty-five churches existing in Hamburg (the old cathedral had to be taken down in 1805), the St Petrikerche, Nikolaikirche, St Katharinerkerche, St Jakobikerche and St Michaelikerche are those that

give their names to the five old city parishes. The Nikolikirche is especially remarkable for its spire, which is 473 ft. high and ranks, after those of Ulm and Cologne, as the third highest ecclesiastical edifice in the world. The old church was destroyed in the great fire of 1842, and the new building, designed by Sir George Gilbert Scott in 13th century Gothic, was erected 1845-1874. The exterior and interior are elaborately adorned with sculptures. Sandstone from Osterwald near Hildesheim was used for the outside, and for the inner work a softer variety from Postelwitz near Dresden. The Michaeliskirche, which is built on the highest point in the city and has a tower 428 ft. high, was erected (1750-1762) by Ernst G. Sönnin on the site of the older building of the 17th century destroyed by lightning; the interior, which can contain 3000 people, is remarkable for its bold construction, there being no pillars. The St Petrikerche, originally consecrated in the 12th century and rebuilt in the 14th, was the oldest church in Hamburg; it was burnt in 1842 and rebuilt in its old form in 1844-1849. It has a graceful tapering spire 407 ft. in height (completed 1878); the granite columns from the old cathedral, the stained glass windows by Kellner of Nuremberg, and H. Schubert's fine relief of the entombment of Christ are worthy of notice. The St Katharinenkirche and the St Jakobikirche are the only surviving mediæval churches, but neither is of special interest. Of the numerous other churches, Evangelical, Roman Catholic and Anglican, none are of special interest. The new synagogue was built by Rosengarten between 1857 and 1859, and to the same architect is due the sepulchral chapel built for the Hamburg merchant prince Johann Heinrich, Freiherr von Schröder (1784-1883), in the churchyard of the Petrikerche. The beautiful chapel of St Gertrude was unfortunately destroyed in 1842.

Hamburg has comparatively few secular buildings of great architectural interest, but first among them is the new Rathaus, a huge German Renaissance building, constructed of sandstone in 1886-1897, richly adorned with sculptures and with a spire 330 ft. in height. It is the place of meeting of the municipal council and of the senate and contains the city archives. Immediately adjoining it and connected with it by two wings is the exchange. It was erected in 1836-1841 on the site of the convent of St Mary Magdalen and escaped the conflagration of 1842. It was restored and enlarged in 1904, and shelters the commercial library of nearly 100,000 vols. During the business hours (1-3 p.m.) the exchange is crowded by some 5000 merchants and brokers. In the same neighbourhood is the Johanneum, erected in 1834 and in which are preserved the town library of about 600,000 printed books and 5000 MSS. and the collection of Hamburg antiquities. In the courtyard is a statue (1885) of the reformer Johann Bugenhagen. In the Fischmarkt, immediately south of the Johanneum, a handsome fountain was erected in 1890. Directly west of the town hall is the new Stadthaus, the chief police station of the town, in front of which is a bronze statue of the burgomaster Karl Friedrich Petersen (1809-1892), erected in 1897. A little farther away are the headquarters of the Patriotic Society (*Patriotische Gesellschaft*), founded in 1765, with fine rooms for the meetings of artistic and learned societies. Several new public buildings have been erected along the circuit of the former walls. Near the west extremity, abutting upon the Elbe, the moat was filled in in 1894-1897, and some good streets were built along the site, while the Kersten Miles-Brücke, adorned with statues of four Hamburg heroes, was thrown across the Helgoländer Allee. Farther north, along the line of the former town wall, are the criminal law courts (1879-1882, enlarged 1893) and the civil law courts (finished in 1901). Close to the latter stand the new supreme court, the old age and accident state insurance offices, the chief custom house, and the concert hall, founded by Karl Laeisz, a former Hamburg wharfinger. Farther on are the chemical and the physical laboratories and the Hygienic Institute. Facing the botanical gardens a new central post-office, in the Renaissance style, was built in 1887. At the west end of the Lombards-Brücke there is a monument by Schilling, commemorating the war of 1870-71. A few streets south of that is

a monument to Lessing (1887); while occupying a commanding site on the promenades towards Altona is the gigantic statue of Bismarck which was unveiled in June 1906. The Kunst-Halle (the picture gallery), containing some good works by modern masters, faces the east end of Lombards-Brücke. The new Natural History Museum, completed in 1891, stands a little distance farther south. To the east of it comes the Museum for Art and Industry, founded in 1878, now one of the most important institutions of the kind in Germany, with which is connected a trades school. Close by is the Hansa-fountain (65 ft. high), erected in 1878. On the north-east side of the suburb of St Georg a botanical museum and laboratory have been established. There is a new general hospital at Eppendorf, outside the town on the north, built on the pavilion principle, and one of the finest structures of the kind in Europe; and at Ohlsdorf, in the same direction, a crematorium was built in 1891 in conjunction with the town cemeteries (370 acres). There must also be mentioned the fine public zoological gardens, Hagenbeck's private zoological gardens in the vicinity, the schools of music and navigation, and the school of commerce. In 1900 a high school for shipbuilding was founded, and in 1901 an institute for seamen's and tropical diseases, with a laboratory for their physiological study, was opened, and also the first public free library in the city. The river is spanned just above the Frei Hafen by a triple-arched railway bridge, 1330 ft. long, erected in 1868-1873 and doubled in width in 1894. Some 270 yds. higher up is a magnificent iron bridge (1888) for vehicles and foot passengers. The southern arm of the Elbe, on the south side of the island of Wilhelmsburg, is crossed by another railway bridge of four arches and 2050 ft. in length.

Railways.—The through railway traffic of Hamburg is practically confined to that proceeding northwards—to Kiel and Jutland—and for the accommodation of such trains the central (terminus) station at Altona is the chief gathering point. The Hamburg stations, connected with the other by the Verbindungs-Bahn (or metropolitan railway) crossing the Lombards-Brücke, are those of the Venloer (or Hanoverian, as it is often called) Bahnhof on the south-east, in close proximity to the harbour, into which converge the lines from Cologne and Bremen, Hanover and Frankfurt-on-Main, and from Berlin, via Nelsen; the Klosterter-Bahnhof (on the metropolitan line) which temporarily superseded the old Berlin station, and the Lübeck station a little to the north-east, during the erection of the new central station, which occupies a site between the Klosterter-Bahnhof and the Lombards-Brücke. Between this central station and Altona terminus runs the metropolitan railway, which has been raised several feet so as to bridge over the streets, and on which lie the important stations Dammtor and Sternschanze. An excellent service of electric trams interconnect the towns of Hamburg, Altona and the adjacent suburbs, and steamboats provide communication on the Elbe with the riparian towns and villages; and so with Blankenese and Harburg, with Stade, Glückstadt and Cuxhaven.

Trade and Shipping.—Probably there is no place which during the last thirty years of the 19th century grew faster commercially than Hamburg. Its commerce is, however, almost entirely of the nature of transit trade, for it is not only the chief distributing centre for the middle of Europe of the products of all other parts of the world, but is also the chief outlet for German, Austrian, and even to some extent Russian (Polish) raw products and manufactures. Its principal imports are coffee (of which it is the greatest continental market), tea, sugar, spices, rice, wine (especially from Bordeaux), lard (from Chicago), cereals, sago, dried fruits, herrings, wax (from Morocco and Mozambique), tobacco, hemp, cotton (which of late years shows a large increase), wool, skins, leather, oils, dyewoods, indigo, nitrates, phosphates and coal. Of the total importations of all kinds of coal to Hamburg, that of British coal, particularly from Northumberland and Durham, occupies the first place, and despite some falling off in late years, owing to the competition made by Westphalian coal, amounts to more than half the total import. The increase of the trade of Hamburg is most strikingly shown by that of

the shipping belonging to the port. Between 1876 and 1880 there were 475 sailing vessels with a tonnage of 230,601, and 110 steamships with a tonnage of 87,050. In 1907 there were (exclusive of fishing vessels) 470 sailing ships with a tonnage of 271,661, and 610 steamers with a tonnage of 1,256,449. In 1870 the crews numbered 6900 men, in 1907 they numbered 20,536.

Industries.—The development of manufacturing industries at Hamburg and its immediate vicinity since 1880, though not so rapid as that of its trade and shipping, has been very remarkable, and more especially has this been the case since the year 1888, when Hamburg joined the German customs union, and the barriers which prevented goods manufactured at Hamburg from entering into other parts of Germany were removed. Among the chief industries are those for the production of articles of food and drink. The import trade of various cereals by sea to Hamburg is very large, and a considerable portion of this corn is converted into flour at Hamburg itself. There are also, in this connexion, numerous bakeries for biscuit, rice-peeling mills and spice mills. Besides the foregoing there are cocoa, chocolate, confectionery and baking-powder factories, coffee-roasting and ham-curing and smoking establishments, lard refineries, margarine manufactories and fish-curing, preserving and packing factories. There are numerous breweries, producing annually about 24,000,000 gallons of beer, spirit distilleries and factories of artificial waters. Yarns, textile goods and weaving industries generally have not attained any great dimensions, but there are large jute-spinning mills and factories for cotton-wool and cotton driving-belts. Among other important articles of domestic industry are tobacco and cigars (manufactured mainly in bond, within the free harbour precincts), hydraulic machinery, electro-technical machinery, chemical products (including artificial manures), oils, soaps, india-rubber, ivory and celluloid articles and the manufacture of leather.

Shipbuilding has made very important progress, and there are at present in Hamburg eleven large shipbuilding yards, employing nearly 10,000 hands. Of these, however, only three are of any great extent, and one, where the largest class of ocean-going steamers and of war vessels for the German navy are built, employs about 5000 persons. There are also two yards for the building of pleasure yachts and rowing-boats (in both which branches of sport Hamburg takes a leading place in Germany). Art industries, particularly those which appeal to the luxurious taste of the inhabitants in fitting their houses, such as wall-papers and furniture, and those which are included in the equipment of ocean-going steamers, have of late years made rapid strides and are among the best productions of this character of any German city.

Harbour.—It was the accession of Hamburg to the customs union in 1888 which gave such a vigorous impulse to her more recent commercial development. At the same time a portion of the port was set apart as a free harbour, altogether an area of 750 acres of water and 1750 acres of dry land. In anticipation of this event a gigantic system of docks, basins and quays was constructed, at a total cost of some £7,000,000 (of which the imperial treasury contributed £2,000,000), between the confluence of the Alster and the railway bridge (1868-1873), an entire quarter of the town inhabited by some 24,000 people being cleared away to make room for these accessories of a great port. On the north side of the Elbe there are the Sandtor basin (3380 ft. long, 295 to 427 ft. wide), in which British and Dutch steamboats and steamboats of the Soman (Mediterranean) line anchor. South of this lies the Grabbrook basin (quayside of 2100 ft. and 1693 ft. alongside), which is used by French, Swedish and transatlantic steamers. At the quay point between these two basins there are vast state granaries. On the outer (i.e. river) side of the Grabbrook dock is the quay at which the emigrants for South America embark, and from which the mail boats for East Africa, the boats of the Woermann (West Africa) line, and the Norwegian tourist boats depart. To the east of these two is the small Magdeburg basin, penetrating north, and the Baaken basin, penetrating east, i.e. parallel to the river. The latter affords accommodation to the transatlantic steamers, including the emigrant ships of the Hamburg-America line, though their "ocean mail boats" generally load and unload at Cuxhaven. On the south bank of the stream there follow in succession, going from east to west, the Moldau dock for river craft, the sailing vessel dock (Segelschiff Hafen, 3937 ft. long, 459 to 886 ft. wide, 26½ ft. deep), the Hansa dock, India dock, petroleum dock,

several swimming and dry docks; and in the west of the free port area three other large docks, one of 77 acres for river craft, the others each 56 acres in extent, and one 23½ ft. deep, the other 26½ ft. deep, at low water, constructed in 1900-1901. In 1897 Hamburg was provided with a huge floating dock, 558 ft. long and 84 ft. in maximum breadth, capable of holding a vessel of 17,500 tons and draught not exceeding 20 ft., so constructed and equipped that in time of need (war) it could be floated down to Cuxhaven. During the last 25 years of the 19th century the channel of the Elbe was greatly improved and deepened, and during the last two years of the 19th century some £160,000 was spent by Hamburg alone in regulating and correcting this lower course of the river. The new Kuhwärder-basin, on the left bank of the river, as well as two other large dock basins (now leased to the Hamburg-American Company), raise the number of basins to twelve in all.

Emigration.—Hamburg is one of the principal continental ports for the embarkation of emigrants. In 1881-1890, on an average they numbered 90,000 a year (of whom 60,000 proceeded to the United States). In 1900 the number was 87,153 (and to the United States 64,137). The number of emigrant Germans has enormously decreased of late years, Russia and Austria-Hungary now being most largely represented. For the accommodation of such passengers large and convenient emigrant shelters have been recently erected close to the wharf of embarkation.

Health and Population.—The health of the city of Hamburg and the adjoining district may be described as generally good, no epidemic diseases having recently appeared to any serious degree. The malady causing the greatest number of deaths is that of pulmonary consumption; but better housing accommodation has of late years reduced the mortality from this disease very considerably. The results of the census of 1905 showed the population of the city (not including the rural districts belonging to the state of Hamburg) to be 802,793.

Hamburg is well supplied with places of amusement, especially of the more popular kind. Its Stadt-Theater, rebuilt in 1874, has room for 1750 spectators and is particularly devoted to operatic performances; the Thalia-Theater dates from 1841, and holds 1700 to 1800 people, and the Schauspielhaus (for drama) from 1900 people, and there are some seven or eight minor establishments. Theatrical performances were introduced into the city in the 17th century, and 1678 is the date of the first opera, which was played in a house in the Gänsenmarkt. Under Schröder and Lessing the Hamburg stage rose into importance. Though contributing few names of the highest rank to German literature, the city has been intimately associated with the literary movement. The historians Lappenberg and Friedrich von Hagedorn were born in Hamburg; and not only Lessing, but Heine and Klopstock lived there for some time.

History.—Hamburg probably had its origin in a fortress erected in 808 by Charlemagne, on an elevation between the Elbe and Alster, as a defence against the Slavs, and called Hammaburg because of the surrounding forest (*Hamm*). In 811 Charlemagne founded a church here, perhaps on the site of a Saxon place of sacrifice, and this became a great centre for the evangelization of the north of Europe, missionaries from Hamburg introducing Christianity into Jutland and the Danish islands and even into Sweden and Norway. In 834 Hamburg became an archbishopric, St Ansgar, a monk of Corbie and known as the apostle of the North, being the first metropolitan. In 845 church, monastery and town were burnt down by the Norsemen, and two years later the see of Hamburg was united with that of Bremen and its seat transferred to the latter city. The town, rebuilt after this disaster, was again more than once devastated by invading Danes and Slavs. Archbishop Unwan of Hamburg-Bremen (1013-1020) substituted a chapter of canons for the monastery, and in 1037 Archbishop Bezelin (or Alebrand) built a stone cathedral and a palace on the Elbe. In 1110 Hamburg, with Holstein, passed into the hands of Adolph I., count of Schauenburg, and it is with the building of the Neustadt (the present parish of St Nicholas) by his grandson, Adolph III. of Holstein, that the history of the commercial city actually begins. In return for a contribution to the costs of a crusade, he obtained from the emperor Frederick I. in 1134 a charter granting Hamburg considerable franchises, including exemption from tolls, a separate court and jurisdiction, and the rights of fishery on the Elbe from the city to the sea. The city council (*Rath*), first mentioned in 1190, had jurisdiction over both the episcopal and the new town. Craft guilds were already in existence, but these had no share in the government; for, though the Lübeck rule excluding craftsmen from the *Rath* did not obtain, they were excluded in practice. The counts, of

course, as over-lords, had their *Vogt (advocatus)* in the town, but this official, as the city grew in power, became subordinate to the *Rath*, as at Lübeck.

The wealth of the town was increased in 1189 by the destruction of the flourishing trading centre of Bardowick by Henry the Lion; from this time it began to be much frequented by Flemish merchants. In 1201 the city submitted to Valdemar of Schleswig, after his victory over the count of Holstein, but in 1225, owing to the capture of King Valdemar II. of Denmark by Henry of Schwerin, it once more exchanged the Danish over-lordship for that of the counts of Schauenburg, who established themselves here and in 1231 built a strong castle to hold it in check. The defensive alliance of the city with Lübeck in 1241, extended for other purpose by the treaty of 1255, practically laid the foundations of the Hanseatic League (*q.v.*), of which Hamburg continued to be one of the principal members. The internal organization of the city, too, was rendered more stable by the new constitution of 1270, and the recognition in 1292 of the complete internal autonomy of the city by the count of Schauenburg. The exclusion of the handicraftsmen from the *Rath* led, early in the 15th century, to a rising of the craft guilds against the patrician merchants, and in 1410 they forced the latter to recognize the authority of a committee of 48 burghers, which concluded with the senate the so-called First Recess; there were, however, fresh outbursts in 1458 and 1483, which were settled by further compromises. In 1461 Hamburg did homage to Christian I. of Denmark, as heir of the Schauenburg counts; but the suzerainty of Denmark was merely nominal and soon repudiated altogether; in 1510 Hamburg was made a free imperial city by the emperor Maximilian I.

In 1529 the Reformation was definitively established in Hamburg by the Great Recess of the 10th of February, which at the same time vested the government of the city in the *Rath*, together with the three colleges of the *Oberalten*, the Forty-eight (increased to 60 in 1685) and the Hundred and Forty-four (increased to 180). The ordinary burghers consisted of the freeholders and the master-workmen of the guilds. In 1536 Hamburg joined the league of Schmalkalden, for which error it had to pay a heavy fine in 1547 when the league had been defeated. During the same period the Lutheran zeal of the citizens led to the expulsion of the Mennonites and other Protestant sects, who founded Altona. The loss this brought to the city was, however, compensated for by the immigration of Protestant refugees from the Low Countries and Jews from Spain and Portugal. In 1549, too, the English merchant adventurers removed their staple from Antwerp to Hamburg.

The 17th century saw notable developments. Hamburg had established, so early as the 16th century, a regular postal service with certain cities in the interior of Germany, e.g. Leipzig and Breslau; in 1615 it was included in the postal system of Turn and Taxis. In 1603 Hamburg received a code of laws regulating exchange, and in 1619 the bank was established. In 1615 the Neustadt was included within the city walls. During the Thirty Years' War the city received no direct harm; but the ruin of Germany reacted upon its prosperity, and the misery of the lower orders led to an agitation against the *Rath*. In 1685, at the invitation of the popular leaders, the Danes appeared before Hamburg demanding the traditional homage; they were repulsed, but the internal troubles continued, culminating in 1708 in the victory of the democratic factions. The imperial government, however, intervened, and in 1712 the "Great Recess" established durable good relations between the *Rath* and the commonalty. Frederick IV. of Denmark, who had seized the opportunity to threaten the city (1712), was bought off with a ransom of 246,000 *Reichsthaler*. Denmark, however, only finally renounced her claims by the treaty of Gottorp in 1768, and in 1770 Hamburg was admitted for the first time to a representation in the diet of the empire.

The trade of Hamburg received its first great impulse in 1783, when the United States, by the treaty of Paris, became an independent power. From this time dates its first direct maritime communication with America. Its commerce was further

extended and developed by the French occupation of Holland in 1795, when the Dutch trade was largely directed to its port. The French Revolution and the insecurity of the political situation, however, exercised a depressing and retarding effect. The wars which ensued, the closing of continental ports against English trade, the occupation of the city after the disastrous battle of Jena, and pestilence within its walls brought about a severe commercial crisis and caused a serious decline in its prosperity. Moreover, the great contributions levied by Napoleon on the city, the plundering of its bank by Davoust, and the burning of its prosperous suburbs inflicted wounds from which the city but slowly recovered. Under the long peace which followed the close of the Napoleonic wars, its trade gradually revived, fostered by the declaration of independence of South and Central America, with both of which it energetically opened close commercial relations, and by the introduction of steam navigation. The first steamboat was seen on the Elbe on the 17th of June 1816; in 1826 a regular steam communication was opened with London; and in 1856 the first direct steamship line linked the port with the United States. The great fire of 1842 (5th-8th of May) laid in waste the greatest part of the business quarter of the city and caused a temporary interruption of its commerce. The city, however, soon rose from its ashes, the churches were rebuilt and new streets laid out on a scale of considerable magnificence. In 1866 Hamburg joined the North German Confederation, and in 1871, while remaining outside the Zollverein, became a constituent state of the German empire. In 1883-1888 the works for the Free Harbour were completed, and on the 18th of October 1888 Hamburg joined the Customs Union (Zollverein). In 1892 the cholera raged within its walls, carried off 8500 of its inhabitants, and caused considerable losses to its commerce and industry; but the visitation was not without its salutary fruits, for an improved drainage system, better hospital accommodation, and a purer water-supply have since combined to make it one of the healthiest commercial cities of Europe.

Further details about Hamburg will be found in the following works: O. C. Gaedechens, *Historische Topographie der Freien und Hansestadt Hamburg* (1880); E. H. Wichmann, *Heimatkunde von Hamburg* (1865); W. Melhop, *Historische Topographie der Freien und Hansestadt Hamburg von 1880-1895* (1896); Wullf, *Hamburgische Gesetze und Verordnungen* (1889-1896); and W. von Melle, *Das hamburgische Staatsrecht* (1891). There are many valuable official publications which may be consulted, among these being: *Statistik des hamburgischen Staates* (1867-1904); *Hamburgs Handel und Schifffahrt* (1847-1903); the yearly *Hamburgischer Staatskalender*; and *Jahrbuch der Hamburger wissenschaftlichen Anstalten*. See also *Hamburg und seine Bauten* (1890); H. Benrath, *Lokalführer durch Hamburg und Umgebungen* (1904); and the consular reports by Sir William Ward, H.B.M.'s consul-general at Hamburg, to whom the author is indebted for great assistance in compiling this article.

For the history of Hamburg see the *Zeitschrift des Vereins für hamburgische Geschichte* (1841, fol.); G. Dehio, *Geschichte des Erzbistums Hamburg-Bremen* (Berlin, 1877); the *Hamburgisches Urkundenbuch* (1842), the *Hamburgische Chroniken* (1852-1861), and the *Chronica der Stadt Hamburg bis 1557* of Adam Tratziger (1865), all three edited by J. M. Lappenberg; the *Briefsammlung der hamburgischen Superintendenten Joachim Westphal 1530-1575*, edited by C. H. W. Sillem (1903); Gallois, *Geschichte der Stadt Hamburg* (1853-1856); K. Koppmann, *Aus Hamburgs Vergangenheit* (1885), and *Kammerrechnungen der Stadt Hamburg* (1869-1894); H. W. C. Hubbe, *Beiträge zur Geschichte der Stadt Hamburg* (1897); C. Mönckeberg, *Geschichte der Freien und Hansestadt Hamburg* (1885); E. H. Wichmann, *Hamburgische Geschichte in Darstellungen aus alter und neuer Zeit* (1889); and R. Bolheimer, *Zeitfests der hamburgischen Geschichte* (1895).

HAMDĀNĪ, in full **ABŪ MAḤMŪD UL-ḤABAN IBN AḤMAD IBN YA'QŪB UL-HAMDĀNĪ** (d. 945), Arabian geographer, also known as Ibn ul-Ḥā'ik. Little is known of him except that he belonged to a family of Yemen, was held in repute as a grammarian in his own country, wrote much poetry, compiled astronomical tables, devoted most of his life to the study of the ancient history and geography of Arabia, and died in prison at San'a in 945. His *Geography of the Arabian Peninsula (Kitāb Jazīrat ul-'Arab)* is by far the most important work on the subject. After being used in manuscript by A. Sprenger in his *Post- und Reiserouten des Orients* (Leipzig, 1864) and further

in his *Alle Geographie Arabiens* (Bern, 1875), it was edited by D. H. Müller (Leiden, 1884; cf. A. Sprenger's criticism in *Zeitschrift der deutschen morgenländischen Gesellschaft*, vol. 45, pp. 361-394). Much has also been written on this work by E. Glaser in his various publications on ancient Arabia. The other great work of Hamdānī is the *Ikhl* (Crown) concerning the genealogies of the Himyarites and the wars of their kings in ten volumes. Of this, part 8, on the citadels and castles of south Arabia, has been edited and annotated by D. H. Müller in *Die Burgen und Schlösser Südarabiens* (Vienna, 1879-1881).

For other works said to have been written by Hamdānī cf. C. Flügel's *Die grammatischen Schulen der Araber* (Leipzig, 1862), pp. 220-221. (G. W. T.)

HAMELIN, FRANÇOIS ALPHONSE (1796-1864), French admiral, was born at Pont l'Évêque on the 2nd of September 1796. He went to sea with his uncle, J. F. E. Hamelin, in the "Vénus" frigate in 1806 as cabin boy. The "Vénus" was part of the French squadron in the Indian Ocean, and young Hamelin had an opportunity of seeing much active service. She, in company with another and a smaller vessel, captured the English frigate "Ceylon" in 1810, but was immediately afterwards captured herself by the "Boadicea," under Commodore Rowley (1765-1842). Young Hamelin was a prisoner of war for a short time. He returned to France in 1811. On the fall of the Empire he had better fortune than most of the Napoleonic officers who were turned ashore. In 1821 he became lieutenant, and in 1823 took part in the French expedition under the duke of Angoulême into Spain. In 1828 he was appointed captain of the "Actéon," and was engaged till 1831 on the coast of Algiers and in the conquest of the town and country. His first command as flag officer was in the Pacific, where he showed much tact during the dispute over the Marquesas Islands with England in 1844. He was promoted vice-admiral in 1848. During the Crimean War he commanded in the Black Sea, and co-operated with Admiral Dundas in the bombardment of Sevastopol 17th of October 1854. His relations with his English colleague were not very cordial. On the 7th of December 1854 he was promoted admiral. Shortly afterwards he was recalled to France, and was named minister of marine. His administration lasted till 1860, and was remarkable for the expeditions to Italy and China organized under his directions; but it was even more notable for the energy shown in adopting and developing the use of armour. The launch of the "Gloire" in 1859 set the example of constructing sea-going ironclads. The first English ironclad, the "Warrior," was designed as an answer to the "Gloire." When Napoleon III. made his first concession to Liberal opposition, Admiral Hamelin was one of the ministers sacrificed. He held no further command, and died on the 10th of January 1864.

HAMELIN, a town of Germany, in the Prussian province of Hanover, at the confluence of the Weser and Hamel, 33 m. S.W. of Hanover, on the line to Altenbeken, which here effects a junction with railways to Löhne and Brunswick. Pop. (1905) 20,736. It has a venerable appearance and has many interesting and picturesque houses. The chief public buildings of interest are the minster, dedicated to St Boniface and restored in 1870-1875; the town hall; the so-called Rattenfängerhaus (rat-catcher's house) with mural frescoes illustrating the legend (see below); and the Hochzeitshaus (wedding house) with beautiful gables. There are classical, modern and commercial schools. The principal industries are the manufacture of paper, leather, chemicals and tobacco, sugar refining, shipbuilding and salmon fishing. By the steamboats on the Weser there is communication with Karlsruhen and Minden. In order to avoid the dangerous part of the river near the town a channel was cut in 1734, the repairing and deepening of which, begun in 1868, was completed in 1873. The Weser is here crossed by an iron suspension bridge 830 ft. in length, supported by a pier erected on an island in the middle of the river.

The older name of Hamelin was Hameloa or Hamelowe, and the town owes its origin to an abbey. It existed as a town as early as the 11th century, and in 1259 it was sold by the abbot

of Fulda to the bishop of Minden, afterwards passing under the protection of the dukes of Brunswick. About 1540 the Reformation gained an entrance into the town, which was taken by both parties during the Thirty Years' War. In 1757 it capitulated to the French, who, however, vacated it in the following year. Its fortifications were strengthened in 1766 by the erection of Fort George, on an eminence to the west of the town, across the river. On the capitulation of the Hanoverian army in 1803 Hamelin fell into the hands of the French; it was retaken by the Prussians in 1806, but, after the battle of Jena, again passed to the French, who dismantled the fortifications and incorporated the town in the kingdom of Westphalia. In 1814 it again became Hanoverian, but in 1866 fell with that kingdom to Prussia.

Legend of the Pied Piper.—Hamelin is famed as the scene of the myth of the piper of Hamelin. According to the legend, the town in the year 1284 was infested by a terrible plague of rats. One day there appeared upon the scene a piper clad in a fantastic suit, who offered for a certain sum of money to charm all the vermin into the Weser. His conditions were agreed to, but after he had fulfilled his promise the inhabitants, on the ground that he was a sorcerer, declined to fulfil their part of the bargain, whereupon on the 26th of June he reappeared in the streets of the town, and putting his pipe to his lips began a soft and curious strain. This drew all the children after him and he led them out of the town to the Koppelberg hill, in the side of which a door suddenly opened, by which he entered and the children after him, all but one who was lame and could not follow fast enough to reach the door before it shut again. Some trace the origin of the legend to the Children's Crusade of 1212; others to an abduction of children; and others to a dancing mania which seized upon some of the young people of Hameln who left the town on a mad pilgrimage from which they never returned. For a considerable time the town dated its public documents from the event. The story is the subject of a poem by Robert Browning, and also of one by Julius Wolf. Curious evidence that the story rests on a basis of truth is given by the fact that the Koppelberg is not one of the imposing hills by which Hamelin is surrounded, but no more than a slight elevation of the ground, barely high enough to hide the children from view as they left the town.

See C. Langlotz, *Geschichte der Stadt Hameln* (Hameln, 1888 fol.); Sprenger, *Geschichte der Stadt Hameln* (1861); O. Meinardus, *Der historische Kern der Rattenfängerage* (Hameln, 1882); Jostes, *Der Rattenfänger von Hameln* (Bonn, 1885); and S. Baring-Gould, *Curious Myths of the Middle Ages* (1868).

HAMERLING, ROBERT (1830-1880), Austrian poet, was born at Kirchenberg-am-Walde in Lower Austria, on the 24th of March 1830, of humble parentage. He early displayed a genius for poetry and his youthful attempts at drama excited the interest and admiration of some influential persons. Owing to their assistance young Hamerling was enabled to attend the gymnasium in Vienna and subsequently the university. In 1848 he joined the student's legion, which played so conspicuous a part in the revolutions of the capital, and in 1849 shared in the defence of Vienna against the imperialist troops of Prince Windischgrätz, and after the collapse of the revolutionary movement he was obliged to hide for a long time to escape arrest. For the next few years he diligently pursued his studies in natural science and philosophy, and in 1855 was appointed master at the gymnasium at Trieste. For many years he battled with ill-health, and in 1866 retired on a pension, which in acknowledgment of his literary labours was increased by the government to a sum sufficient to enable him to live without care until his death at his villa in Stiftingstal near Graz, on the 13th of July 1880. Hamerling was one of the most remarkable of the poets of the modern Austrian school; his imagination was rich and his poems are full of life and colour. His most popular poem, *Ahasver in Rom* (1866), of which the emperor Nero is the central figure, shows at its best the author's brilliant talent for description. Among his other works may be mentioned *Venus im Exil* (1858); *Der König von Sion* (1869), which is generally regarded as his masterpiece; *Die sieben Todsünden* (1872); *Blätter im Winde* (1887); *Homunculus* (1888); *Amor und*

Psyche (1882). His novel, *Aspasia* (1876) gives a finely-drawn description of the Periclean age, but like his tragedy *Danton und Robespierre* (1870), is somewhat stilted, showing that Hamerling's genius, though rich in imagination, was ill-suited for the realistic presentation of character.

A popular edition of Hamerling's works in four volumes was published by M. M. Rabenlechner (Hamburg, 1900). For the poet's life, see his autobiographical writings, *Stationen meiner Lebenspilgerschaft* (1889) and *Lehrjahre der Liebe* (1890); also M. M. Rabenlechner, *Hamerling, sein Leben und seine Werke*, i. (Hamburg, 1896); a short biography by the same (Dresden, 1901); R. H. Kleinert, *R. Hamerling, ein Dichter der Schönheit* (Hamburg, 1889); A. Polzer, *Hamerling, sein Wesen und Wirken* (Hamburg, 1890).

HAMERTON, PHILIP GILBERT (1834-1894), English artist and author, was born at Laneside, near Shaw, close to Oldham, on the 10th of September 1834. His mother died at his birth, and having lost his father ten years afterwards, he was educated privately under the direction of his guardians. His first literary attempt, a volume of poems, proving unsuccessful, he devoted himself for a time entirely to landscape painting, encamping out of doors in the Highlands, where he eventually rented the island of Innistray, upon which he settled with his wife, a French lady, in 1858. Discovering after a time that his qualifications were rather those of an art critic than of a painter he removed to the neighbourhood of his wife's relatives in France, where he produced his *Painter's Camp in the Highlands* (1863), which obtained a great success and prepared the way for his standard work on *Etching and Etchers* (1866). In the following year he published a book, entitled *Contemporary French Painters*, and in 1868 a continuation, *Painting in France after the Decline of Classicism*. He had meanwhile become art critic to the *Saturday Review*, a position which, from the burden it laid upon him of frequent visits to England, he did not long retain. He proceeded (1870) to establish an art journal of his own, *The Portfolio*, a monthly periodical, each number of which consisted of a monograph upon some artist or group of artists, frequently written and always edited by him. The discontinuance of his active work as a painter gave him time for more general literary composition, and he successively produced *The Intellectual Life* (1873), perhaps the best known and most valuable of his writings; *Round my House* (1876), notes on French society by a resident; and *Modern Frenchmen* (1879), admirable short biographies. He also wrote two novels, *Wendholm* (1870) and *Marmore* (1878). In 1884 *Human Intercourse*, another valuable volume of essays, was published, and shortly afterwards Hamerton began to write his autobiography, which he brought down to 1858. In 1882 he issued a finely illustrated work on the technique of the great masters of various arts, under the title of *The Graphic Arts*, and three years later another splendidly illustrated volume, *Landscape*, which traces the influence of landscape upon the mind of man. His last books were: *Portfolio Papers* (1889) and *French and English* (1889). In 1891 he removed to the neighbourhood of Paris, and died suddenly on the 4th of November 1894, occupied to the last with his labours on *The Portfolio* and other writings on art.

In 1896 was published *Philip Gilbert Hamerton: an Autobiography, 1834-1858*; and a *Memoir by his Wife, 1858-1894*.

HAMI, a town in Chinese Turkestan, otherwise called **KAMIL**, **KOMUL** or **KAMUL**, situated on the southern slopes of the Tian-Shan mountains, and on the northern verge of the Great Gobi desert, in 42° 48' N., 93° 28' E., at a height above sea-level of 3150 ft. The town is first mentioned in Chinese history in the 1st century, under the name I-wu-lu, and said to be situated 1000 li north of the fortress Yu-men-kuan, and to be the key to the western countries. This evidently referred to its advantageous position, lying as it did in a fertile tract, at the point of convergence of two main routes running north and south of the Tian-Shan and connecting China with the west. It was taken by the Chinese in A.D. 73 from the Hiungnu (the ancient inhabitants of Mongolia), and made a military station. It next fell into the hands of the Uighurs or Eastern Turks, who made it one of their chief towns and held it for several centuries, and whose descendants are said to live there now. From the 7th

to the 11th century I-wu-lu is said to have borne the name of Igu or I-chu, under the former of which names it is spoken of by the Chinese pilgrim, Hsuan tsang, who passed through it in the 7th century. The name Hami is first met in the Chinese *Yüan-shih* or "History of the Mongol Dynasty," but the name more generally used there is Momi-li or Komi-li. Marco Polo, describing it apparently from hearsay, calls it Camul, and speaks of it as a fruitful place inhabited by a Buddhist people of idolatrous and wanton habits. It was visited in 1341 by Giovanni de Marignoli, who baptized a number of both sexes there, and by the envoys of Shah Rukh (1420), who found a magnificent mosque and a convent of dervishes, in juxtaposition with a fine Buddhist temple. Hadji Mahommed (Ramusio's friend) speaks of Kamul as being in his time (c. 1550) the first Mahomedan city met with in travelling from China. When Benedict Goes travelled through the country at the beginning of the 17th century, the power of the king Mahommed Khan of Kashgar extended over nearly the whole country at the base of the Tian-Shan to the Chinese frontier, including Kamil. It fell under the sway of the Chinese in 1720, was lost to them in 1865 during the great Mahomedan rebellion, and the trade route through it was consequently closed, but was regained in 1873. Owing to its commanding position on the principal route to the west, and its exceptional fertility, it has very frequently changed hands in the wars between China and her western neighbours. Hami is now a small town of about 6000 inhabitants, and is a busy trading centre. The Mahomedan population consists of immigrants from Kashgaria, Bokhara and Samarkand, and of descendants of the Uighurs.

HAMILCAR BARCA, or **BARCAS** (Heb. *barak* "lightning"), Carthaginian general and statesman, father of Hannibal, was born soon after 270 B.C. He distinguished himself during the First Punic War in 247, when he took over the chief command in Sicily, which at this time was almost entirely in the hands of the Romans. Landing suddenly on the north-west of the island with a small mercenary force he seized a strong position on Mt. Ercte (Monte Pellegrino, near Palermo), and not only maintained himself against all attacks, but carried his raids as far as the coast of south Italy. In 244 he transferred his army to a similar position on the slopes of Mt. Eryx (Monte San Giuliano), from which he was able to lend support to the besieged garrison in the neighbouring town of Drepanum (Trapani). By a provision of the peace of 241 Hamilcar's unbeaten force was allowed to depart from Sicily without any token of submission. On returning to Africa his troops, which had been kept together only by his personal authority and by the promise of good pay, broke out into open mutiny when their rewards were withheld by Hamilcar's opponents among the governing aristocracy. The serious danger into which Carthage was brought by the failure of the aristocratic generals was averted by Hamilcar, whom the government in this crisis could not but reinstate. By the power of his personal influence among the mercenaries and the surrounding African peoples, and by superior strategy, he speedily crushed the revolt (237). After this success Hamilcar enjoyed such influence among the popular and patriotic party that his opponents could not prevent him being raised to a virtual dictatorship. After recruiting and training a new army in some Numidian forays he led on his own responsibility an expedition into Spain, where he hoped to gain a new empire to compensate Carthage for the loss of Sicily and Sardinia, and to serve as a basis for a campaign of vengeance against the Romans (236). In eight years by force of arms and diplomacy he secured an extensive territory in Spain, but his premature death in battle (228) prevented him from completing the conquest. Hamilcar stood out far above the Carthaginians of his age in military and diplomatic skill and in strength of patriotism; in these qualities he was surpassed only by his son Hannibal, whom he had imbued with his own deep hatred of Rome and trained to be his successor in the conflict.

This Hamilcar has been confused with another general who succeeded to the command of the Carthaginians in the First Punic War, and after successes at Therma and Drepanum was defeated at

Enomus (256 B. C.). Subsequently, apart from unskilful operations against Regulus, nothing is certainly known of him. For others of the name see CARTHAGE, SICILY, Smith's *Classical Dictionary*. So far as the name itself is concerned, *Mikar* is perhaps the same as *Melkarth*, the Tyrian god.

See Polybius i.-iii.; Cornelius Nepos, *Vita Hamilcaris*; Appian, *Res Hispanicas*, chs. 4, 5; Diodorus, *Excerpta*, xxiv., xxv.; O. Meizer, *Geschichte der Karthager* (Berlin, 1877), ii. also PUNIC WARS. (M. O. B. C.)

HAMILTON, the name of a famous Scottish family. Chief among the legends still clinging to this important family is that which gives a descent from the house of Beaumont, a branch of which is stated to have held the manor of Hamilton in Leicestershire; and it is argued that the three cinquefoils of the Hamilton shield bear some resemblance to the single cinquefoil of the Beaumonts. In face of this it has been recently shown that the single cinquefoil was also borne by the Umfravilles of Northumberland, who appear to have owned a place called Hamilton in that county. It may be pointed out that Simon de Montfort, the great earl of Leicester, in whose veins flowed the blood of the Beaumonts, obtained about 1245 the wardship of Gilbert de Umfraville, second earl of Angus, and it is conceivable that this name Gilbert may somehow be responsible for the legend of the Beaumont descent, seeing that the first authentic ancestor of the Hamiltons is one Walter FitzGilbert. He first appears in 1204-1205 as one of the witnesses to a charter by James, the high steward of Scotland, to the monks of Paisley; and in 1206 his name appears in the Homage Roll as Walter FitzGilbert of "Hameldone." Who this Gilbert of "Hameldone" may have been is uncertain, "but the fact must be faced," Mr John Anderson points out (*Scots Peerage*, iv. 340) "that in a charter of the 12th of December 1272 by Thomas of Craigny or Craigie to the monks of Paisley of his church of Craigie in Kyle, there appears as witness a certain 'Gilbert de Hameldun clericus,' whose name occurs along with the local clergy of Inverkip, Blackhall, Paisley and Dunoon. He was therefore probably also a cleric of the same neighbourhood, and it is significant that 'Walter FitzGilbert' appears first in that district in 1204 and in 1206 is described as son of Gilbert de Hameldone. . . ." Walter FitzGilbert took some part in the affairs of his time. At first he joined the English party but after Bannockburn went over to Bruce, was knighted and subsequently received the barony of Cadzow. His younger son John was father of Alexander Hamilton who acquired the lands of Innerwick by marriage, and from him descended a certain Thomas Hamilton, who acquired the lands of Priestfield early in the 16th century. Another Thomas, grandson of this last, who had with others of his house followed Queen Mary and with them had been restored to royal favour, became a lord of session as Lord Priestfield. Two of his younger sons enjoyed also this legal distinction, while the eldest, Thomas, was made an ordinary lord of session as early as 1592 and was eventually created earl of Haddington (q.v.). It is interesting to note that the 5th earl of Haddington by his marriage with Lady Margaret Leslie brought for a time the earldom of Rothes to the Hamiltons to be added to their already numerous titles.

Sir "David FitzWalter FitzGilbert," who carried on the main line of the Hamiltons, was taken prisoner at the battle of Neville's Cross (1346) and treated as of great importance, being ransomed, it is stated, for a large sum of money; in 1371 and 1373 he was one of the barons in the parliament. Of the four sons attributed to him David succeeded in the representation of the family, Sir John Hamilton of Fingaltoun was ancestor of the Hamiltons of Preston, and Walter is stated to have been progenitor of the Hamiltons of Cambuskeith and Sanquhar in Ayrshire.

David Hamilton, the first apparently to describe himself as lord of Cadzow, died before 1392, leaving four or five sons, from whom descended the Hamiltons of Bathgate and of Bardowie, and perhaps also of Udstown, to which last belong the lords Belhaven.

Sir John Hamilton of Cadzow, the eldest son, was twice a prisoner in England, but beyond this little is known of him;

even the date of his death is uncertain. His two younger sons are stated to have been founders of the houses of Dalserf and Raploch. His eldest son, James Hamilton of Cadzow, like his father and great-grandfather, visited England as a prisoner, being one of the hostages for the king's ransom. From him the Hamiltons of Silvertonhill and the lords Hamilton of Dalzell claim descent, among the more distinguished members of the former branch being General Sir Ian Hamilton, K.C.B. James Hamilton was succeeded by his eldest son Sir James Hamilton of Cadzow, who was created in 1445 an hereditary lord of parliament, and was thereafter known as Lord Hamilton. He had allied himself some years before with the great house of Douglas by marriage with Euphemia, widow of the 5th earl of Douglas, and was at first one of its most powerful supporters in the struggle with James II. Later, however, he obtained the royal favour and married about 1474 Mary, sister of James III. and widow of Thomas Boyd, earl of Arran. Of this marriage was born James, second Lord Hamilton, who as a near relative took an active part in the arrangements at the marriage of James IV. with Margaret Tudor; being rewarded on the same day (the 8th of August 1503) with the earldom of Arran. A champion in the lists he was scarcely so successful as a leader of men, his struggle with the Douglases being destitute of any great martial achievement. Of his many illegitimate children Sir James Hamilton of Finnart, beheaded in 1540, was ancestor of the Hamiltons of Gilkiescleugh; and John, archbishop of St Andrews, hanged by his Protestant enemies, was ancestor of the Hamiltons of Blair, and is said also to have been ancestor of Hamilton of London, baronet. James, second earl of Arran, son of the first earl by his second wife Janet Beaton, was chosen governor to the little Queen Mary, being nearest of kin to the throne through his grandmother, though the question of the validity of his mother's marriage was by no means settled. He held the governorship till 1554, having in 1549 been granted the duchy of Châtellerault in France. In his policy he was vacillating and eventually he retired to France, being absent during the three momentous years prior to the deposition of Mary. On his return he headed the queen's party, his property suffering in consequence. He was succeeded in the title in 1570 by his eldest son James, whose qualities were such that he was even proposed as a husband for Queen Elizabeth, but unfortunately he soon after became insane, his brother John, afterwards first marquess of Hamilton, administering the estates. From the third son, Claud, descends the duke of Abercorn, heir male of the house of Hamilton.

The first marquess of Hamilton had a natural son, Sir John Hamilton of Lettrick, who was legitimated in 1600 and was ancestor of the lords Bargany. His two legitimate sons were James, 3rd marquess and first duke of Hamilton, and William, who succeeded his brother as 2nd duke and was in turn succeeded under the special remainder contained in the patent of dukedom, by his niece Anne, duchess of Hamilton, who was married in 1656 to William Douglas, earl of Selkirk. The history of the descendants of this marriage belongs to the great house of Douglas, the 7th duke of Hamilton becoming the male representative and chief of the house of Douglas, earls of Angus.

The above mentioned Claud Hamilton, who with his brother, the first marquess, had taken so large a part in the cause of Queen Mary, was created a lord of parliament as Lord Paisley in 1587. He had five sons, of whom three settled in Ireland, Sir Claud being ancestor of the Hamiltons of Beltrim and Sir Frederick, distinguished in early life in the Swedish wars, being ancestor of the viscounts Boyne.

James, the eldest son of Lord Paisley, found favour with James VI. and was created in 1603 Lord of Abercorn, and three years later was advanced in the peerage as earl of Abercorn and lord of Paisley, Hamilton, Mountcastle and Kilpatrick. His eldest son James, 2nd earl of Abercorn, eventually heir male of the house of Hamilton and successor to the dukedom of Châtellerault, was created in his father's lifetime lord of Strabane in Ireland, but he resigned this title in 1633 in favour of his brother Claud, whose grandson, Claud, 5th Lord Strabane, succeeded

eventually as 4th earl of Abercorn. This earl, taking the side of James II., was with him in Ireland, his estate and title being afterwards forfeited, while his kinsman Gustavus Hamilton, afterwards first Lord Boyne, raised several regiments for William III., and greatly distinguished himself in the service of that monarch. His brother Charles, 5th earl of Abercorn, who obtained a reversal of the attainder, died without issue surviving in 1701 when the titles passed to his kinsmen James Hamilton, grandson of Sir George Hamilton of Donalong in Ireland and great-grandson of the first earl. This branch, most faithful to the house of Stuart, counted among its many members distinguished in military annals Count Anthony Hamilton, author of the *Mémoires du comte de Gramont* and brother of "la belle Hamilton." James, 6th earl of Abercorn (whose brother William was ancestor of Hamilton of the Mount, baronet), was a partizan of William III., and obtained in 1701 the additional Irish titles of lord of Mountcastle and viscount of Strabane.

The 8th earl of Abercorn, who was summoned to the Irish house of peers in his father's lifetime as Lord Mountcastle, was created a peer of Great Britain in 1786 as Viscount Hamilton of Hamilton in Leicestershire, and renewed the family's connexion with Scotland by repurchasing the barony of Duddingston and later the lordship of Paisley. His nephew and successor was created marquess of Abercorn in 1790, and was father of James, 1st duke of Abercorn.

See the article Hamilton and other articles on the different branches of the family (e.g. Haddington and Belhaven) in Sir J. B. Paul's edition of Sir R. Douglas's *Peerage of Scotland*; and also G. Marshall, *Guide to Heraldry and Genealogy*.

HAMILTON, MARQUESS AND DUKES OF. The holders of these titles descended from Sir James Hamilton of Cadzow, who was made an hereditary lord of parliament in 1445, his lands and baronies at the same time being erected into the "lordship" of Hamilton. His first wife Euphemia, widow of the 5th earl of Douglas, died in 1468, and probably early in 1474 he married Mary, daughter of King James II. and widow of Thomas Boyd, earl of Arran; the consequent nearness of the Hamiltons to the Scottish crown gave them very great weight in Scottish affairs. The first Lord Hamilton has been frequently confused with his father, James Hamilton of Cadzow, who was one of the hostages in England for the payment of James I.'s ransom, and is sometimes represented as surviving until 1451 or even 1479, whereas he certainly died, according to evidence brought forward by J. Anderson in *The Scots Peerage*, before May 1441. James, 2nd Lord Hamilton, son of the 1st lord and Princess Mary, was created earl of Arran in 1503; and his son James, who was regent of Scotland from 1542 to 1554, received in February 1549 a grant of the duchy of Châtellerault in Poitou.

JOHN, 1st marquess of Hamilton (c. 1542-1604), third son of James Hamilton, 2nd earl of Arran (q.v.) and duke of Châtellerault, was given the abbey of Arbroath in 1551. In politics he was largely under the influence of his energetic and unscrupulous younger brother Claud, afterwards Baron Paisley (c. 1543-1622), ancestor of the dukes of Abercorn. The brothers were the real heads of the house of Hamilton, their elder brother Arran being insane. At first hostile to Mary, they later became her devoted partisans. Their uncle, John Hamilton, archbishop of St Andrews, natural son of the 1st earl of Arran, was restored to his consistorial jurisdiction by Mary in 1566, and in May of the next year he divorced Bothwell from his wife. Lord Claud met Mary on her escape from Lochleven and escorted her to Hamilton palace. John appears to have been in France in 1568 when the battle of Langside was fought, and it was probably Claud who commanded Mary's vanguard in the battle. With others of the queen's party they were forfeited by the parliament and sought their revenge on the regent Murray. Although the Hamiltons disavowed all connexion with Murray's murderer, James Hamilton of Bothwellhaugh, he had been provided with horse and weapons by the abbot of Arbroath, and it was at Hamilton that he sought refuge after the deed. Archbishop Hamilton was hanged at Stirling in 1571 for alleged complicity in the

murder of Darnley, and is said to have admitted that he was a party to the murder of Murray. At the pacification of Perth in 1573 the Hamiltons abandoned Mary's cause, and a reconciliation with the Douglasses was sealed by Lord John's marriage with Margaret, daughter of the 7th Lord Glamis, a cousin of the regent Morton. Sir William Douglas of Lochleven, however, persistently sought his life in revenge for the murder of Murray until, on his refusal to keep the peace, he was imprisoned. On the uncertain evidence extracted from the assassin by torture, the Hamiltons had been credited with a share in the murder of the regent Lennox in 1571. In 1579 proceedings against them for these two crimes were resumed, and when they escaped to England their lands and titles were seized by their political enemies, James Stewart becoming earl of Arran. John Hamilton presently dissociated himself from the policy of his brother Claud, who continued to plot for Spanish intervention on behalf of Mary; and Catholic plotters are even said to have suggested his murder to procure the succession of his brother. Hamilton had at one time been credited with the hope of marrying Mary; his desires now centred on the peaceful enjoyment of his estates. With other Scottish exiles he crossed the border in 1585 and marched on Stirling; he was admitted on the 4th of November and formally reconciled with James VI., with whom he was thenceforward on the friendliest terms. Claud returned to Scotland in 1586, and the abbey of Paisley was erected into a temporal barony in his favour in 1587. Much of his later years was spent in strict retirement, his son being authorized to act for him in 1598. John was created marquess of Hamilton and Lord Evan in 1599, and died on the 6th of April 1604.

His eldest surviving son JAMES, 2nd marquess of Hamilton (c. 1589-1625), was created baron of Innerdale and earl of Cambridge in the peerage of England in 1619, and these honours descended to his son James, who in 1643 was created duke of Hamilton (q.v.). William, 2nd duke of Hamilton (1616-1651), succeeded to the dukedom on his brother's execution in 1649. He was created earl of Lanark in 1639, and in the next year became secretary of state in Scotland. Arrested at Oxford by the king's orders in 1643 for "concurrence" with Hamilton, he effected his escape and was temporarily reconciled with the Presbyterian party. He was sent by the Scottish committee of estates to treat with Charles I. at Newcastle in 1646, when he sought in vain to persuade the king to consent to the establishment of Presbyterianism in England. On the 26th of September 1647 he signed on behalf of the Scots the treaty with Charles known as the "Engagement" at Carisbrooke Castle, and helped to organize the second Civil War. In 1648 he fled to Holland, his succession in the next year to his brother's dukedom making him an important personage among the Royalist exiles. He returned to Scotland with Prince Charles in 1650, but, finding a reconciliation with Argyll impossible, he refused to prejudice Charles's cause by pushing his claims, and lived in retirement chiefly until the Scottish invasion of England, when he acted as colonel of a body of his dependants. He died on the 12th of September 1651 from the effects of wounds received at Worcester. He left no male heirs, and the title devolved on the 1st duke's eldest surviving daughter Anne, duchess of Hamilton in her own right.

Anne married in 1656 William Douglas, earl of Selkirk (1635-1694), who was created duke of Hamilton in 1660 on his wife's petition, receiving also several of the other Hamilton peerages, but for his life only. The Hamilton estates had been declared forfeit by Cromwell, and he himself had been fined £1000. He supported Lauderdale in the early stages of his Scottish policy, in which he adopted a moderate attitude towards the Presbyterians, but the two were soon alienated, through the influence of the countess of Dysart, according to Gilbert Burnet, who spent much time at Hamilton Palace in arranging the Hamilton papers. With other Scottish noblemen who resisted Lauderdale's measures Hamilton was twice summoned to London to present his case at court, but without obtaining any result. He was dismissed from the privy council in 1676, and on a subsequent visit to London Charles refused to receive him. On the accession

of James II. he received numerous honours, but he was one of the first to enter into communication with the prince of Orange. He presided over the convention of Edinburgh, summoned at his request, which offered the Scottish crown to William and Mary in March 1689. His death took place at Holyrood on the 18th of April 1694. His wife survived until 1716.

JAMES DOUGLAS, 4th duke of Hamilton (1658-1712), eldest son of the preceding and of Duchess Anne, succeeded his mother, who resigned the dukedom to him in 1698, and at the accession of Queen Anne he was regarded as leader of the Scottish national party. He was an opponent of the union with England, but his lack of decision rendered his political conduct ineffective. He was created duke of Brandon in the peerage of Great Britain in 1711; and on the 15th of November in the following year he fought the celebrated duel with Charles Lord Mohun, narrated in Thackeray's *Esmond*, in which both the principals were killed. His son, James (1703-1743), became 5th duke, and his grandson James, 6th duke of Hamilton and Brandon (1724-1758), married the famous beauty, Elizabeth Gunning, afterwards duchess of Argyll. James George, 7th duke (1755-1769), became head of the house of Douglas on the death in 1761 of Archibald, duke of Douglas, whose titles but not his estates then devolved on the duke of Hamilton as heir-male. Archibald's brother Douglas (1756-1799) was the 8th duke, and when he died childless the titles passed to his uncle Archibald (1740-1819). His son Alexander, 10th duke (1767-1852), who as marquis of Douglas was a great collector and connoisseur of books and pictures (his collections realized £397,562 in 1882), was ambassador at St Petersburg in 1806-1807. His sister, Lady Anne Hamilton, was lady-in-waiting and a faithful friend to Queen Caroline, wife of George IV.; she did not write the *Secret History of the Court of England* . . . (1832) to which her name was attached. William Alexander, 11th duke of Hamilton (1811-1863), married Princess Marie Amélie, daughter of Charles, grand-duke of Baden, and, on her mother's side, a cousin of Napoleon III. The title of duke of Châtellerault, granted to his remote ancestor in 1548, and claimed at different times by various branches of the Hamilton family, was conferred on the 11th duke's son, William Alexander, 12th duke of Hamilton (1845-1895), by the emperor of the French in 1864. His sister, Lady Mary Douglas-Hamilton, married in 1869 Albert, prince of Monaco, but their marriage was declared invalid in 1880. She subsequently married Count Tassilo Festetics, a Hungarian noble. The 12th duke left no male issue and was succeeded in 1895 by his kinsman, Alfred Douglas, a descendant of the 4th duke. Claud Hamilton, 1st Baron Paisley, brother of the 1st marquis of Hamilton, was, as mentioned above, ancestor of the Abercorn branch of the Hamiltons. His son, who became earl of Abercorn in 1606, received among a number of other titles that of Lord Hamilton. This title, and also that of Viscount Hamilton, in the peerage of Great Britain, conferred on the 8th earl of Abercorn in 1786, are borne by the dukes of Abercorn, whose eldest son is usually styled by courtesy marquis of Hamilton, a title which was added to the other family honours when the 2nd marquis of Abercorn was raised to the dukedom in 1868.

See John Anderson, *The House of Hamilton* (1825); *Hamilton Papers*, ed. J. Bain (2 vols., Edinburgh, 1890-1892); Gilbert Burnet, *Lives of James and William, Dukes of Hamilton* (1677); *The Hamilton Papers relative to 1638-1650*, ed. S. R. Gardiner for the Camden Society (1880); G. E. Clokayne, *Complete Peerage* (1887-1898); an article by the Rev. J. Anderson in Sir J. B. Paul's edition of the *Scotts Peerage*, vol. iv. (1907).

HAMILTON, ALEXANDER (1757-1804), American statesman and economist, was born, as a British subject, on the island of Nevis in the West Indies on the 11th of January 1757. He came of good family on both sides. His father, James Hamilton, a Scottish merchant of St Christopher, was a younger son of Alexander Hamilton of Grange, Lanarkshire, by Elizabeth, daughter of Sir R. Pollock. His mother, Rachael Fawcett (Faucette), of French Huguenot descent, married when very young a Danish proprietor of St Croix, John Michael Levine, with whom she lived unhappily and whom she soon left, subsequently living with James Hamilton; her husband procured

a divorce in 1759, but the court forbade her remarriage.¹ Such unions as hers with James Hamilton were long not uncommon in the West Indies. By her James Hamilton had two sons, Alexander and James. Business misfortunes having caused his father's bankruptcy, and his mother dying in 1768, young Hamilton was thrown upon the care of maternal relatives at St Croix, where, in his twelfth year, he entered the counting-house of Nicholas Cruger. Shortly afterward Mr Cruger, going abroad, left the boy in charge of the business. The extraordinary specimens we possess of his mercantile correspondence and friendly letters, written at this time, attest an astonishing poise and maturity of mind, and self-conscious ambition. His opportunities for regular schooling must have been very scant; but he had cultivated friends who discerned his talents and encouraged their development, and he early formed the habits of wide reading and industrious study that were to persist through his life. An accomplishment later of great service to Hamilton, common enough in the Antilles, but very rare in the English continental colonies, was a familiar command of French. In 1772 some friends, impressed by a description by him of the terrible West Indian hurricane in that year, made it possible for him to go to New York to complete his education. Arriving in the autumn of 1772, he prepared for college at Elizabethtown, N.J., and in 1774 entered King's College (now Columbia University) in New York City. His studies, however, were interrupted by the War of American Independence.

A visit to Boston seems to have thoroughly confirmed the conclusion, to which reason had already led him, that he should cast in his fortunes with the colonists. Into their cause he threw himself with ardour. In 1774-1775 he wrote two influential anonymous pamphlets, which were attributed to John Jay; they show remarkable maturity and controversial ability, and rank high among the political arguments of the time.² He organized an artillery company, was awarded its captaincy on examination, won the interest of Nathaniel Greene and Washington by the proficiency and bravery he displayed in the campaign of 1776 around New York City, joined Washington's staff in March 1777 with the rank of lieutenant-colonel, and during four years served as his private secretary and confidential aide. The important duties with which he was entrusted attest Washington's entire confidence in his abilities and character; then and afterwards, indeed, reciprocal confidence and respect took the place, in their relations, of personal attachment.³ But Hamilton was ambitious for military glory—it was an ambition he never lost; he became impatient of detention in what he regarded as a position of unpleasant dependence, and (Feb. 1781) he seized a slight reprimand administered by Washington as an excuse for abandoning his staff position.⁴ Later he secured a field command, through Washington, and won laurels at Yorktown, where he led the American column in the

¹ These facts were first definitely determined by Mrs Gertrude Atherton from the Danish Archives in Denmark and the West Indies; see article in *North American Review*, Aug. 1902, vol. 175, p. 229; and preface to her *A Few of Hamilton's Letters* (New York, 1903).

² These were written in answer to the widely read pamphlet published over the *nom de plume* of "A Westchester Farmer," and now known to have been written by Samuel Seabury (q.v.). Hamilton's pamphlets were entitled "A Full Vindication of the Measures of the Congress from the Calumnies of their Enemies," and "The Farmer Refuted." Concerning these George Ticknor Curtis (*Constitutional History of the United States*, i. 274) has said, "There are displayed in these papers a power of reasoning and sarcasm, a knowledge of the principles of government and of the English constitution, and a grasp of the merits of the whole controversy, that would have done honour to any man at any age. To say that they evince precocity of intellect gives no idea of their main characteristics. They show great maturity—a more remarkable maturity than has ever been exhibited by any other person, at so early an age, in the same department of thought."

³ George Bancroft was the first to point out that there is small evidence that Hamilton ever really appreciated Washington's great qualities; but on the score of personal and Federalist indebtedness he left explicit recognition.

⁴ For Hamilton's letter to General Schuyler on this episode—one of the most important letters, in some ways, that he ever wrote—see the *Works*, ix. 232 (8: 35).

final assault on the British works. In 1780 he married Elizabeth, daughter of General Philip Schuyler, and thus became allied with one of the most distinguished families in New York.

Meanwhile, he had begun the political efforts upon which his fame principally rests. In letters of 1779-1780¹ he correctly diagnoses the ills of the Confederation, and suggests with admirable prescience the necessity of centralization in its governmental powers; he was, indeed, one of the first, if not to conceive, at least to suggest adequate checks on the anarchic tendencies of the time. After a year's service in Congress in 1782-1783, in which he experienced the futility of endeavouring to attain through that decrepit body the ends he sought, he settled down to legal practice in New York.² The call for the Annapolis Convention (1786) was Hamilton's opportunity. A delegate from New York, he supported Madison in inducing the Convention to exceed its delegated powers and summon the Federal Convention of 1787 at Philadelphia (himself drafting the call); he secured a place on the New York delegation; and, when his anti-Federal colleagues withdrew from the Convention, he signed the Constitution for his state. So long as his colleagues were present his own vote was useless, and he absented himself for some time from the debates after making one remarkable speech (June 18th, 1787). In this he held up the British government as the best model in the world.³ Though fully conscious that monarchy in America was impossible, he wished to obtain the next best solution in an aristocratic, strongly centralized, coercive, but representative union, with devices to give weight to the influence of class and property.⁴ His plan had no chance of success; but though unable to obtain what he wished, he used his great talents to secure the adoption of the Constitution.

To this struggle was due the greatest of his writings, and the greatest individual contribution to the adoption of the new government, *The Federalist*, which remains a classic commentary on American constitutional law and the principles of government, and of which Guizot said that "in the application of elementary principles of government to practical administration" it was the greatest work known to him. Its inception, and much more than half its contents were Hamilton's (the rest Madison's and Jay's).⁵ Sheer will and reasoning could hardly be more bril-

liantly and effectively exhibited than they were by Hamilton in the New York convention of 1788, whose vote he won, against the greatest odds, for the ratification of the Constitution. It was the judgment of Chancellor James Kent, the justice of which can hardly be disputed, that "all the documentary proof and the current observation of the time lead us to the conclusion that he surpassed all his contemporaries in his exertions to create, recommend, adopt and defend the Constitution of the United States."

When the new government was inaugurated, Hamilton became secretary of the treasury in Washington's cabinet.⁶ Congress immediately referred to him a press of queries and problems, and there came from his pen a succession of papers that have left the strongest imprint on the administrative organization of the national government—two reports on public credit, upholding an ideal of national honour higher than the prevalent popular principles; a report on manufactures, advocating their encouragement (e.g. by bounties paid from surplus revenues amassed by tariff duties)—a famous report that has served ever since as a storehouse of arguments for a national protective policy;⁷ a report favouring the establishment of a national bank, the argument being based on the doctrine of "implied powers" in the Constitution, and on the application that Congress may do anything that can be made, through the medium of money, to subserve the "general welfare" of the United States—doctrines that, through judicial interpretation, have revolutionized the Constitution; and, finally, a vast mass of detailed work by which order and efficiency were given to the national finances. In 1793 he put to confusion his opponents who had brought about a congressional investigation of his official accounts. The success of his financial measures was immediate and remarkable. They did not, as is often but loosely said, create economic prosperity; but they did prop it, in an all-important field, with order, hope and confidence. His ultimate purpose was always the strengthening of the union; but before particularizing his political theories, and the political import of his financial measures, the remaining events of his life may be traced.

His activity in the cabinet was by no means confined to the finances. He regarded himself, apparently, as premier, and sometimes overstepped the limits of his office in interfering with other departments. The heterogeneous character of the duties placed upon his department by Congress seemed in fact to reflect the English idea of its primacy. Hamilton's influence was in fact predominant with Washington (so far as any man could have predominant influence). Thus it happens that in foreign affairs, whatever credit properly belongs to the Federalists as a party (see also the article FEDERALIST PARTY) for the adoption of that principle of neutrality which became the traditional policy of the United States must be regarded as largely due to Hamilton. But allowance must be made for the mere advantage of initiative which belonged to any party that organized the government—the differences between Hamilton and Jefferson, in this question of neutrality, being almost purely factitious.⁸ On domestic policy their differences were vital,

candour, simplicity, and elegance, with which its truths are uttered and recommended.⁹

¹ The position was offered first to Robert Morris, who declined it, expressing the opinion that Hamilton was the man best fitted to meet its problems.

² Hamilton's *Report on Manufactures* (1791) by itself entitles him to the place of an epoch-maker in economics. It was the first great revolt from Adam Smith, on whose *Wealth of Nations* (1776) he is said to have already written a commentary which is lost. In his criticism on Adam Smith, and his arguments for a system of moderate protective duties associated with the deliberate policy of promoting national interests, his work was the inspiration of Friedrich List, and so the foundation of the economic system of Germany in a later day, and again, still later, of the policy of Tariff Reform and Colonial Preference in England, as advocated by Mr Chamberlain and his supporters. See the detailed account given in the article PROTECTION.

³ That is, while Jefferson hated British aristocracy and sympathized with French democracy, Hamilton hated French democracy and sympathized with British aristocracy and order; but

¹ Especially the letter of September 1780 to James Duane, *Works*, i. 213 (1: 203); also the "Continentalist" papers of 1781.

² His most famous case at this time (*Rutgers v. Waddington*) was one that well illustrated his moral courage. Under a "Trespass Law" of New York, Elizabeth Rutgers, a widow, brought suit against one Joshua Waddington, a Loyalist, who during the war of American Independence, while New York was occupied by the British, had made use of some of her property. In face of popular clamour, Hamilton, who advocated a conciliatory treatment of the Loyalists, represented Waddington, who won the case, decided in 1784.

³ As Mr Oliver points out (*Alexander Hamilton*, p. 156), Hamilton's idea of the British constitution was not a correct picture of the British constitution in 1787, and still less of that of the 20th century. "What he had in mind was the British constitution as George III. had tried to make it." Hamilton's ideal was an elective monarchy, and his guiding principle a proper balance of authority.

⁴ Briefly, he proposed a governor and two chambers—an Assembly elected by the people for three years, and a Senate—the governor and senate holding office for life or during good behaviour, and chosen, through electors, by voters qualified by property; the governor to have an unqualified veto on federal legislation; state governors to have a similar veto on state legislation, and to be appointed by the federal government; the federal government to control all militia. See *Works*, i. 347 (1: 331); and cf. his correspondence, which is scanty, *passim* in later years, notably x. 446, 431, 329 (8: 606, 596, 517), and references below.

⁵ Nearly all the papers in *The Federalist* first appeared (between October 1787 and April 1788) in New York journals, over the signature "Publius." Jay wrote only five. The authorship of twelve of them is uncertain, and has been the subject of much controversy between partisans of Hamilton and Madison. Concerning *The Federalist* Chancellor James Kent (*Commentaries*, i. 241) said: "There is no work on the subject of the Constitution, and on republican and federal government generally, that deserves to be more thoroughly studied. I know not indeed of any work on the principles of free government that is to be compared, in instruction and intrinsic value, to this small and unpretending volume. . . . It is equally admirable in the depth of its wisdom, the comprehensiveness of its views, the sagacity of its reflections, and the fearlessness, patriotism,

and in their conflicts over Hamilton's financial measures they organized, on the basis of varying tenets and ideals which have never ceased to conflict in American politics, the two great parties of Federalists and Democrats (or Democratic-Republicans). On the 31st of January 1795 Hamilton resigned his position as secretary of the treasury and returned to the practice of law in New York, leaving it for public service only in 1798-1800, when he was the active head, under Washington (who insisted that Hamilton should be second only to himself), of the army organized for war against France. But though in private life he remained the continual and chief adviser of Washington—notably in the serious crisis of the Jay Treaty, of which Hamilton approved. Washington's *Farewell Address* (1796) was written for him by Hamilton.

After Washington's death the Federalist leadership was divided (and disputed) between John Adams, who had the prestige of a varied and great career, and greater strength than any other Federalist with the people, and Hamilton, who controlled practically all the leaders of lesser rank, including much the greater part of the most distinguished men of the country, so that it has been very justly said that "the roll of his followers is enough of itself to establish his position in American history" (Lodge). But Hamilton was not essentially a popular leader. When his passions were not involved, or when they were repressed by a crisis, he was far-sighted, and his judgment of men was excellent.¹ But as Hamilton himself once said, his heart was ever the master of his judgment. He was, indeed, not above intrigue,² but he was unsuccessful in it. He was a fighter through and through, and his courage was superb; but he was indiscreet in utterance, impolitic in management, opinionated, self-confident, and uncompromising in nature and methods. His faults are nowhere better shown than in his quarrel with John Adams. Three times, in order to accomplish ends deemed by him, personally, to be desirable, Hamilton used the political fortunes of John Adams, in presidential elections, as a mere hazard in his manoeuvres; moreover, after Adams became president, and so the official head of the party, Hamilton constantly advised the members of the president's cabinet, and through them endeavoured to control Adams's policy; and finally, on the eve of the crucial election of 1800, he wrote a bitter personal attack on the president (containing much confidential cabinet information), which was intended for private circulation, but which was secured and published by Aaron Burr, his legal and political rival.

The mention of Burr leads us to the fatal end of another great political antipathy of Hamilton's life. He read Burr's character correctly from the beginning; deemed it a patriotic duty to thwart him in his ambitions; defeated his hopes successively of a foreign mission, the presidency, and the governorship of New York; and in his conversations and letters repeatedly and unsparingly denounced him. If these denunciations were known to Burr they were ignored by him until his last defeat. After that he forced a quarrel on a trivial bit of hearsay (that Hamilton had said he had a "despicable" opinion of Burr); and Hamilton, believing as he explained in a letter he left before going to his death—that a compliance with the duelling prejudices of the time was inseparable from the ability to be in future

neither wanted war; and indeed Jefferson, throughout life, was the more peaceful of the two. Neutrality was in the line of commonplace American thinking of that time, as may be seen in the writings of all the leading men of the day. The cry of "British Hamilton" had no good excuse whatever.

¹ e.g. his prediction in 1789 of the course of the French Revolution; his judgments of Burr from 1792 onward, and of Burr and Jefferson in 1800.

² After the Democrats won New York in 1799, Hamilton proposed to Governor John Jay to call together the out-going Federalist legislature, in order to choose Federalist presidential electors, a suggestion which Jay simply endorsed: "Proposing a measure for party purposes which it would not become me to adopt."—*Works*, x. 371 (8 : 549). Compare also with later developments of ward politics in New York City, Hamilton's curious suggestions as to Federalist charities, &c., in connexion with the Christian Constitutional Society proposed by him in 1802 to combat irreligion and democracy (*Works*, x. 432 (8 : 596)).

useful in public affairs, accepted a challenge from him. The duel was fought at Weehawken on the Jersey shore of the Hudson opposite the City of New York. At the first fire Hamilton fell, mortally wounded, and he died on the following day, the 12th of July 1804. Hamilton himself did not intend to fire, but his pistol went off as he fell. The tragic close of his career appealed for the moment the fierce hatred of politics, and his death was very generally deplored as a national calamity.³

No emphasis, however strong, upon the mere consecutive personal successes of Hamilton's life is sufficient to show the measure of his importance in American history. That importance lies, to a large extent, in the political ideas for which he stood. His mind was eminently "legal." He was the unrivalled controversialist of the time. His writings, which are distinguished by clarity, vigour and rigid reasoning, rather than by any show of scholarship—in the extent of which, however solid in character Hamilton's might have been, he was surpassed by several of his contemporaries—are in general strikingly empirical in basis. He drew his theories from his experiences of the Revolutionary period, and he modified them hardly at all through life. In his earliest pamphlets (1774-1775) he started out with the ordinary pre-Revolutionary Whig doctrines of natural rights and liberty; but the first experience of semi-anarchic states'-rights and individualism ended his fervour for ideas so essentially alien to his practical, logical mind, and they have no place in his later writings. The feeble inadequacy of conception, infirmity of power, factional jealousy, disintegrating particularism, and vicious finance of the Confederation were realized by many others; but none other saw so clearly the concrete nationalistic remedies for these concrete ills, or pursued remedial ends so constantly, so ably, and so consistently. An immigrant, Hamilton had no particularistic ties; he was by instinct a "continentalist" or federalist. He wanted a strong union and energetic government that should "rest as much as possible on the shoulders of the people and as little as possible on those of the state legislatures"; that should have the support of wealth and class; and that should curb the states to such an "entire subordination" as nowise to be hindered by those bodies. At these ends he aimed with extraordinary skill in all his financial measures. As early as 1776 he urged the direct collection of federal taxes by federal agents. From 1779 onward we trace the idea of supporting government by the interest of the propertied classes; from 1781 onward the idea that a not-excessive public debt would be a blessing⁴ in giving cohesiveness to the union; hence his device by which the federal government, assuming the war debts of the states, secured greater resources, based itself on a high ideal of nationalism, strengthened its hold on the individual citizen, and gained the support of property. In his report on manufactures his chief avowed motive was to strengthen the union. To the same end he conceived the constitutional doctrines of liberal construction, "implied powers," and the "general welfare," which were later embodied in the decisions of John Marshall. The idea of nationalism pervaded and quickened all his life and works. With one great exception, the dictum of Guizot is hardly an exaggeration, that "there is not in the Constitution of the United States an element of order, of force, of duration, which he did not powerfully contribute to introduce into it and to cause to predominate."

³ Hamilton's widow, who survived him for half a century, dying at the age of ninety-seven, was left with four sons and four daughters. He had been an affectionate husband and father, though his devotion to his wife had been consistent with occasional lapses from strict marital fidelity. One intrigue into which he drifted in 1791, with a Mrs Reynolds, led to the blackmailing of Hamilton by her husband; and when this rascal, shortly afterwards, got into trouble for fraud, his relations with Hamilton were unscrupulously misrepresented for political purposes by some of Hamilton's opponents. But Hamilton faced the necessity of revealing the true state of things with conspicuous courage, and the scandal only reacted on his accusers. One of them was Monroe, whose reputation comes very badly out of this unsavoury affair.

⁴ In later years he said no debt should be incurred without providing simultaneously for its payment.

The exception, as American history showed, was American democracy. The loose and barren rule of the Confederation seemed to conservative minds such as Hamilton's to presage, in its strengthening of individualism, a fatal looseness of social restraints, and led him on to a dread of democracy that he never overcame. Liberty, he reminded his fellows, in the New York Convention of 1788, seemed to be alone considered in government, but there was another thing equally important: "a principle of strength and stability in the organization . . . and of vigour in its operation." But Hamilton's governmental system was in fact repressive.¹ He wanted a system strong enough, he would have said, to overcome the anarchic tendencies loosed by war, and represented by those notions of natural rights which he had himself once championed; strong enough to overbear all local, state and sectional prejudices, powers or influence, and to control—not, as Jefferson would have it, to be controlled by—the people. Confidence in the integrity, the self-control, and the good judgment of the people, which was the content of Jefferson's political faith, had almost no place in Hamilton's theories. "Men," said he, "are reasoning rather than reasonable animals." The charge that he laboured to introduce monarchy by intrigue is an under-estimate of his good sense.² Hamilton's thinking, however, did carry him foul of current democratic philosophy; as he said, he presented his plan in 1787 "not as attainable, but as a model to which we ought to approach as far as possible"; moreover, he held through life his belief in its principles, and in its superiority over the government actually created; and though its inconsistency with American tendencies was yearly more apparent, he never ceased to avow on all occasions his aristocratic-monarchical partialities. Moreover, his preferences for at least an aristocratic republic were shared by many other men of talent. When it is added that Jefferson's assertions, alike as regards Hamilton's talk³ and the intent and tendency of his political measures, were, to the extent of the underlying basic fact—but discounting Jefferson's somewhat intemperate interpretations—unquestionably true,⁴ it cannot be accounted strange that Hamilton's Democratic opponents mistook his theoretic predilections for positive designs. Nor would it be a strained inference from much that he said, to believe that he hoped and expected that in the "crisis" he foresaw, when democracy should have caused the ruin of the country, a new government might be formed that should approximate to his own ideals.⁵ From the beginning of the excesses of the French Revolution he was possessed by the persuasion that American democracy, likewise, might at any moment crush the restraints of the Constitution to enter on a career of licence and anarchy. To this obsession he sacri-

¹ He warmly supported the Alien and Sedition Laws of 1798 (in their final form).

² The idea, he wrote to Washington, was "one of those visionary things none but madmen could undertake, and that no wise man will believe" (1792). And see his comments on Burr's ambitions, *Works*, x. 417, 450 (8:585, 610). We may accept as just, and applicable to his entire career, the statement made by himself in 1803 of his principles in 1787: "(1) That the political powers of the people of this continent would endure nothing but a representative form of government. (2) That, in the actual situation of the country, it was itself right and proper that the representative system should have a full and fair trial. (3) That to such a trial it was essential that the government should be so constructed as to give it all the energy and the stability reconcilable with the principles of that theory."

³ Cf. Gouverneur Morris, *Diary and Letters*, ii. 455, 526, 531.

⁴ Cf. even Mr Lodge's judgments, pp. 90-92, 115-116, 122, 130, 140. When he says (p. 140) that "In Hamilton's successful policy there were certainly germs of an aristocratic republic, there were certainly limitations and possibly dangers to pure democracy," this is practically Jefferson's assertion (1792) that "His system flowed from principles adverse to liberty"; but Jefferson goes on to add: "and was calculated to undermine and demolish the republic." As to the intent of Hamilton to secure through his financial measures the political support of property, his own words are honest and clear; and in fact he succeeded. Jefferson merely had exaggerated fears of a moneyed political engine, and seeing that Hamilton's measures of funding and assumption did make the national debt politically useful to the Federalists in the beginning he concluded that they would seek to fasten the debt on the country for ever.

⁵ Cf. *Gouv. Morris*, *op. cit.* ii. 474.

ficed his life.⁶ After the Democratic victory of 1800, his letters, full of retrospective judgments and interesting outlooks, are but rarely relieved in their sombre pessimism by flashes of hope and courage. His last letter on politics, written two days before his death, illustrates the two sides of his thinking already emphasized: in this letter he warns his New England friends against dismemberment of the union as "a clear sacrifice of great positive advantages, without any counterbalancing good; administering no relief to our real disease, which is democracy, the poison of which, by a subdivision, will only be more concentrated in each part, and consequently the more virulent." To the end he never lost his fear of the states, nor gained faith in the future of the country. He laboured still, in mingled hope and apprehension, "to prop the frail and worthless fabric,"⁷ but for its spiritual content of democracy he had no understanding, and even in its nationalism he had little hope. Yet probably to no one man, except perhaps to Washington, does American nationalism owe so much as to Hamilton.

In the development of the United States the influence of Hamiltonian nationalism and Jeffersonian democracy has been a reactive union; but changed conditions since Hamilton's time, and particularly since the Civil War, are likely to create misconceptions as to Hamilton's position in his own day. Great constructive statesman as he was, he was also, from the American point of view, essentially a reactionary. He was the leader of reactionary forces—constructive forces, as it happened—in the critical period after the War of American Independence, and in the period of Federalist supremacy. He was in sympathy with the dominant forces of public life only while they took, during the war, the predominant impress of an imperfect nationalism.⁸ Jeffersonian democracy came into power in 1800 in direct line with colonial development; Hamiltonian Federalism was a break in that development; and this alone can explain how Jefferson could organize the Democratic Party in face of the brilliant success of the Federalists in constructing the government. Hamilton stigmatized his great opponent as a political fanatic; but actualist as he claimed to be,⁹ Hamilton could not see, or would not concede, the predominating forces in American life, and would uncompromisingly have minimized the two great political conquests of the colonial period—local self-government and democracy.

Few Americans have received higher tributes from foreign authorities. Talleyrand, personally impressed when in America with Hamilton's brilliant qualities, declared that he had the power of divining without reasoning, and compared him to Fox and Napoleon because he had "deviné l'Europe." Of the judgments rendered by his countrymen, Washington's confidence in his ability and integrity is perhaps the most significant. Chancellor James Kent, and others only less competent, paid remarkable testimony to his legal abilities. Chief-justice Marshall ranked him second to Washington alone. No judgment

⁶ He dreamed of saving the country with an army in this crisis of blood and iron, and wished to preserve unweakened the public confidence in his personal bravery.

⁷ His own words in 1802. In justification of the above statements see the correspondence of 1800-1804 *passim*—*Works*, vol. ix. x. (or 7-8); especially x. 363, 425, 434, 440, 445 (or 8:543, 591, 596, 602, 605).

⁸ Cf. Anson D. Morse, article cited below, pp. 4, 18-21.

⁹ Chancellor Kent tells us (*Memoirs and Letters*, p. 32) that in 1804 Hamilton was planning a co-operative Federalist work on the history and science of government on an inductive basis. Kent always speaks of Hamilton's legal thinking as deductive, however (*ibid.*, p. 290, 329), and such seems to have been in fact all his political reasoning: *i.e.* underlying them were such maxims as that of Hume, that in erecting a stable government every citizen must be assumed a knave, and be bound by self-interest to co-operation for the public good. Hamilton always seems to be reasoning deductively from such principles. He went too far and fast for even such a Federalist disbeliever in democracy as Gouverneur Morris; who, to Hamilton's assertion that democracy must be cast out to save the country, replied that "such necessity cannot be shown by a political ratiocination. Luckily, or, to speak with a reverence proper to the occasion, providentially, mankind are not disposed to embark the blessings they enjoy on a voyage of syllogistic adventure to obtain something more beautiful in exchange. They must feel before they will act" (*op. cit.* ii. 531).

is more justly measured than Madison's (in 1831): "That he possessed intellectual powers of the first order, and the moral qualities of integrity and honour in a captivating degree, has been awarded him by a suffrage now universal. If his theory of government deviated from the republican standard he had the candour to avow it, and the greater merit of co-operating faithfully in maturing and supporting a system which was not his choice."

In person Hamilton was rather short and slender; in carriage, erect, dignified and graceful. Deep-set, changeable, dark eyes vivified his mobile features, and set off his light hair and fair, ruddy complexion. His head in the famous Trumbull portrait is boldly poised and very striking. The captivating charm of his manners and conversation is attested by all who knew him, and in familiar life he was artlessly simple. Friends he won readily, and he held them in devoted attachment by the solid worth of a frank, ardent, generous, warm-hearted and high-minded character. Versatile as were his intellectual powers, his nature seems comparatively simple. A firm will, tireless energy, aggressive courage and bold self-confidence were its leading qualities; the word "intensity" perhaps best sums up his character. His Scotch and Gallic strains of ancestry are evident; his countenance was decidedly Scotch; his nervous speech and bearing and vehement temperament rather French; in his mind, agility, clarity and penetration were matched with logical solidity. The remarkable quality of his mind lay in the rare combination of acute analysis and grasp of detail with great comprehensiveness of thought. So far as his writings show, he was almost wholly lacking in humour, and in imagination little less so. He certainly had wit, but it is hard to believe he could have had any touch of fancy. In public speaking he often combined a rhetorical effectiveness and emotional intensity that might take the place of imagination, and enabled him, on the coldest theme, to move deeply the feelings of his auditors.

BIBLIOGRAPHY.—Hamilton's Works have been edited by H. C. Lodge (New York, 9 vols., 1885-1886, and 12 vols., 1904); all references above are first to the latter edition, secondly (in brackets) to the former. There are various additional editions of *The Federalist*, notably those of H. B. Dawson (1863), H. C. Lodge (1888), and—the most scholarly—P. L. Ford (1898); cf. *American Historical Review*, ii. 413, 675. See also James Bryce, "Predictions of Hamilton and de Tocqueville," in *Johns Hopkins University Studies*, vol. 5 (Baltimore, 1887); and the capital essay of Anson D. Morse in the *Political Science Quarterly*, v. (1890), pp. 1-23. For a bibliography of the period see the *Cambridge Modern History*, vol. vii, pp. 780-810. The unfinished *Life of Alexander Hamilton, by his Son*, J. C. Hamilton, going only to 1787 (New York, 2 vols., 1834-1840), was superseded by the same author's valuable, but partisan and uncritical *History of the Republic . . . as traced in the Writings of Alexander Hamilton* (New York, 7 vols., 1857-1864; 4th ed., Boston, 1879). Professor W. G. Sumner's *Alexander Hamilton* (Makers of America series, New York, 1890) is appreciative, and important for its criticism from the point of view of an American free-trader; see also, on Hamilton's finance and economic views, Prof. C. F. Dunbar, *Quarterly Journal of Economics*, iii. (1889), p. 32; E. G. Bourne in *ibid.* x. (1894), p. 328; E. C. Lunt in *Journal of Political Economy*, iii. (1895), p. 289. Among modern studies most also be mentioned J. T. Morse's able *Life* (1876); H. C. Lodge's two books, his *Historical Study* (1877) and *Life and Epoch* (1879). C. J. Riethmüller's *Hamilton and his Contemporaries* (1864), written during the Civil War, is sympathetic, but rather speculative. The most vivid account of Hamilton is in Mrs Gertrude Atherton's historical romance, *The Conqueror* (New York, 1902), for the writing of which the author made new investigations into the biographical details, and elucidated some points previously obscure; see also her *A Few of Hamilton's Letters* (1903). F. S. Oliver's brilliant *Alexander Hamilton: An Essay on American Union* (London, 1906), which uses its subject to illustrate the necessity of British imperial federation, is strongly anti-Jeffersonian, but no other work by a non-American author brings out so well the wider issues involved in Hamilton's economic policy. (F. S. P.; H. Cu.)

HAMILTON, ANTHONY, or ANTOINE (1646-1720), French classical author, was born about 1646. He is especially noteworthy from the fact that, though by birth he was a foreigner, his literary characteristics are more decidedly French than those of many of the most indubitable Frenchmen. His father was George Hamilton, younger brother of James, and earl of

Abercorn, and head of the family of Hamilton in the peerage of Scotland, and 6th duke of Châtellerauld in the peerage of France; and his mother was Mary Butler, sister of the 1st duke of Ormonde. According to some authorities he was born at Drogheda, but according to the London edition of his works in 1811 his birthplace was Roscrea, Tipperary. From the age of four till he was fourteen the boy was brought up in France, whither his family had removed after the execution of Charles I. The fact that, like his father, he was a Roman Catholic, prevented his receiving the political promotion he might otherwise have expected on the Restoration, but he became a distinguished member of that brilliant band of courtiers whose chronicler he was to become. He took service in the French army, and the marriage of his sister Elizabeth, "la belle Hamilton," to Philibert, comte de Gramont (q.v.) rendered his connexion with France more intimate, if possible, than before. On the accession of James II. he obtained an infantry regiment in Ireland, and was appointed governor of Limerick and a member of the privy council. But the battle of the Boyne, at which he was present, brought disaster on all who were attached to the cause of the Stuarts, and before long he was again in France—an exile, but at home. The rest of his life was spent for the most part at the court of St Germain and in the *châteaux* of his friends. With Ludovise, duchesse du Maine, he became an especial favourite, and it was at her seat at Sceaux that he wrote the *Mémoires* that made him famous. He died at St Germain-en-Laye on the 21st of April 1720.

It is mainly by the *Mémoires du comte de Gramont* that Hamilton takes rank with the most classical writers of France. It was said to have been written at Gramont's dictation, but it is very evident that Hamilton's share is the most considerable. The work was first published anonymously in 1713 under the rubric of Cologne, but it was really printed in Holland, at that time the great patroness of all questionable authors. An English translation by Boyer appeared in 1714. Upwards of thirty editions have since appeared, the best of the French being Renouard's (1812), forming part of a collected edition of Hamilton's works, and Gustave Brunet's (1859), and the best of the English, Edwards's (1793), with 78 engravings from portraits in the royal collections at Windsor and elsewhere, A. F. Bertrand de Moleville's (2 vols., 1811), with 64 portraits by E. Scriven and others, and Gordon Goodwin's (2 vols., 1903). The original edition was reprinted by Benjamin Pifteau in 1876. In imitation and satiric parody of the romantic tales which Antoine Galland's translation of *The Thousand and One Nights* had brought into favour in France, Hamilton wrote, partly for the amusement of Henrietta Bulkeley, sister of the duchess of Berwick, to whom he was much attached, four ironical and extravagant *contes*: *Le Béliér*, *Fleur d'épine*, *Zénéyde* and *Les Quatre Facardins*. The saying in *Le Béliér* "Béliér, mon ami, tu me ferais plaisir si tu voulais commencer par le commencement," has passed into a proverb. These tales were circulated privately during Hamilton's lifetime, and the first three appeared in Paris in 1730, ten years after the death of the author; a collection of his *Œuvres diverses* in 1731 contained the unfinished *Zénéyde*. Hamilton was also the author of some songs as exquisite in their way as his prose, and interchanged amusing verses with the duke of Berwick. In the name of his niece, the countess of Stafford, Hamilton maintained a witty correspondence with Lady Mary Wortley Montagu.

See notices of Hamilton in Lescaur's edition (1873) of the *Contes*. Sainte-Beuve's *Causeries du lundi*, tome i., *Sayous Histoire de la littérature française à l'étranger* (1853), and by L. S. Auger in the *Œuvres complètes* (1804).

HAMILTON, ELIZABETH (1758-1816), British author, was born at Belfast, of Scottish extraction, on the 21st of July 1758. Her father's death in 1759 left his wife so embarrassed that Elizabeth was adopted in 1762 by her paternal aunt, Mrs Marshall, who lived in Scotland, near Stirling. In 1788 Mrs Hamilton went to live with her brother Captain Charles Hamilton (1753-1792), who was engaged on his translation of the *Helléne*. Prompted by her brother's associations, she produced her

Letters of a Hindoo Rajah in 1796. Soon after, with her sister Mrs Blake, she settled at Bath, where she published in 1800 the *Memoirs of Modern Philosophers*, a satire on the admirers of the French Revolution. In 1801-1802 appeared her *Letters on Education*. After travelling through Wales and Scotland for nearly two years, the sisters took up their abode in 1803 at Edinburgh. In 1804 Mrs Hamilton, as she then preferred to be called, published her *Life of Agrippina, wife of Germanicus*; and in the same year she received a pension from government. *The Collagers of Glenburnie* (1808), which is her best-known work, was described by Sir Walter Scott as "a picture of the rural habits of Scotland, of striking and impressive fidelity." She also published *Popular Essays on the Elementary Principles of the Human Mind* (1812), and *Hints addressed to the Patrons and Directors of Public Schools* (1815). She died at Harrogate on the 23rd of July 1816.

Memoirs of Mrs Elizabeth Hamilton, by Miss Benger, were published in 1818.

HAMILTON, EMMA, LADY (c. 1765-1815), wife of Sir William Hamilton (q.v.), the British envoy at Naples, and famous as the mistress of Nelson, was the daughter of Henry Lyon, a blacksmith of Great Neston in Cheshire. The date of her birth cannot be fixed with certainty, but she was baptized at Great Neston on the 12th of May 1765, and it is not improbable that she was born in that year. Her baptismal name was Emily. As her father died soon after her birth, the mother, who was dependent on parish relief, had to remove to her native village, Hawarden in Flintshire. Emma's early life is very obscure. She was certainly illiterate, and it appears that she had a child in 1780, a fact which has led some of her biographers to place her birth before 1765. It has been said that she was first the mistress of Captain Willet Payne, an officer in the navy, and that she was employed in some doubtful capacity by a notorious quack of the time, Dr Graham. In 1781 she was the mistress of a country gentleman, Sir Harry Featherstonhaugh, who turned her out in December of that year. She was then pregnant, and in her distress she applied to the Hon. Charles Greville, to whom she was already known. At this time she called herself Emily Hart. Greville, a gentleman of artistic tastes and well known in society, entertained her as his mistress, her mother, known as Mrs Cadogan, acting as housekeeper and partly as servant. Under the protection of Greville, whose means were narrowed by debt, she acquired some education, and was taught to sing, dance and act with professional skill. In 1782 he introduced her to his friend Romney the portrait painter, who had been established for several years in London, and who admired her beauty with enthusiasm. The numerous famous portraits of her from his brush may have somewhat idealised her apparently robust and brilliantly coloured beauty, but her vivacity and powers of fascination cannot be doubted. She had the temperament of an artist, and seems to have been sincerely attached to Greville. In 1784 she was seen by his uncle, Sir William Hamilton, who admired her greatly. Two years later she was sent on a visit to him at Naples, as the result of an understanding between Hamilton and Greville—the uncle paying his nephew's debts and the nephew ceding his mistress. Emma at first resented, but then submitted to the arrangement. Her beauty, her artistic capacity, and her high spirits soon made her a great favourite in the easy-going society of Naples, and Queen Maria Carolina became closely attached to her. She became famous for her "attitudes," a series of *poses plastiques* in which she represented classical and other figures. On the 6th of September 1791, during a visit to England, she was married to Sir W. Hamilton. The ceremony was required in order to justify her public reception at the court of Naples, where Lady Hamilton played an important part as the agent through whom the queen communicated with the British minister—sometimes in opposition to the will and the policy of the king. The revolutionary wars and disturbances which began after 1792 made the services of Lady Hamilton always useful and sometimes necessary to the British government. It was claimed by her, and on her behalf, that she secured valuable information in 1796, and was

of essential service to the British fleet in 1798 during the Nile campaign, by enabling it to obtain stores and water in Sicily. These claims have been denied on the rather irrelevant ground that they are wanting in official confirmation, which was only to be expected since they were *ex hypothesi* unofficial and secret, but it is not improbable that they were considerably exaggerated, and it is certain that her stories cannot always be reconciled with one another or with the accepted facts. When Nelson returned from the Nile in September 1798 Lady Hamilton made him her hero, and he became entirely devoted to her. Her influence over him indeed became notorious, and brought him much official displeasure. Lady Hamilton undoubtedly used her influence to draw Nelson into a most unhappy participation in the domestic troubles of Naples, and when Sir W. Hamilton was recalled in 1800 she travelled with him and Nelson ostentatiously across Europe. In England Lady Hamilton insisted on making a parade of her hold over Nelson. Their child, Horatia Nelson Thompson, was born on the 30th of January 1801. The profuse habits which Emma Hamilton had contracted in Naples, together with a passion for gambling which grew on her, led her into debt, and also into extravagant ways of living, against which her husband feebly protested. On his death in 1803 she received by his will a life-rent of £800, and the furniture of his house in Piccadilly. She then lived openly with Nelson at his house at Merton. Nelson tried repeatedly to secure her a pension for the services rendered at Naples, but did not succeed. On his death she received Merton, and an annuity of £500, as well as the control of the interest of the £4000 he left to his daughter. But gambling and extravagance kept her poor. In 1808 her friends endeavoured to arrange her affairs, but in 1813 she was put in prison for debt and remained there for a year. A certain Alderman Smith having aided her to get out, she went over to Calais for refuge from her creditors, and she died there in distress if not in want on the 15th of January 1815.

AUTHORITIES.—*The Memoirs of Lady Hamilton* (London, 1815) were the work of an ill-disposed but well-informed and shrewd observer whose name is not given. *Lady Hamilton and Lord Nelson*, by J. C. Jefferson (London, 1888) is based on authentic papers. It is corrected in some particulars by the detailed recent life written by Walter Sichel, *Emma, Lady Hamilton* (London, 1905). See also the authorities given in the article NELSON. (D. H.)

HAMILTON, JAMES (1769-1831), English educationist, and author of the Hamiltonian system of teaching languages, was born in 1769. The first part of his life was spent in mercantile pursuits. Having settled in Hamburg and become free of the city, he was anxious to become acquainted with German and accepted the tuition of a French emigré, General d'Angelis. In twelve lessons he found himself able to read an easy German book, his master having discarded the use of a grammar and translated to him short stories word for word into French. As a citizen of Hamburg Hamilton started a business in Paris, and during the peace of Amiens maintained a lucrative trade with England; but at the rupture of the treaty he was made a prisoner of war, and though the protection of Hamburg was enough to get the words *effacé de la liste des prisonniers de guerre* inscribed upon his passport, he was detained in custody till the close of hostilities. His business being thus ruined, he went in 1814 to America, intending to become a farmer and manufacturer of potash; but, changing his plan before he reached his "location," he started as a teacher in New York. Adopting his old tutor's method, he attained remarkable success in New York, Baltimore, Washington, Boston, Montreal and Quebec. Returning to England in July 1823, he was equally fortunate in Manchester and elsewhere. The two master principles of his method were that the language should be presented to the scholar as a living organism, and that its laws should be learned from observation and not by rules. His system attracted general attention, and was vigorously attacked and defended. In 1826 Sydney Smith devoted an article to its elucidation in the *Edinburgh Review*. As textbooks for his pupils Hamilton printed interlinear translations of the Gospel of John, of an *Epitome historiae sacrae*, of Aesop's *Fables*, Eutropius, Aurelius Victor, Phaedrus, &c., and many books were issued as Hamiltonian with which he

had nothing personally to do. He died on the 31st of October 1831.

See Hamilton's own account, *The History, Principles, Practice and Results of the Hamiltonian System* (Manchester, 1829; new ed., 1831); Alberte, *Über die Hamilton'sche Methode*; C. F. Wurm, *Hamilton und Jacobi* (1831).

HAMILTON, JAMES HAMILTON, 1ST DUKE OF (1606-1649), Scottish nobleman, son of James, 2nd marquis of Hamilton, and of the Lady Anne Cunningham, daughter of the earl of Glencairn, was born on the 19th of June 1606. As the descendant and representative of James Hamilton, 1st earl of Arran, he was the heir to the throne of Scotland after the descendants of James VI. He married in his fourteenth year May Feilding, aged seven, daughter of Lord Feilding, afterwards 1st earl of Denbigh, and was educated at Exeter College, Oxford, where he matriculated on the 14th of December 1621. He succeeded to his father's titles on the latter's death in 1625. In 1628 he was made master of the horse and was also appointed gentleman of the bedchamber and a privy councillor. In 1631 Hamilton took over a force of 6000 men to assist Gustavus Adolphus in Germany. He guarded the fortresses on the Oder while Gustavus fought Tilly at Breitenfeld, and afterwards occupied Magdeburg, but his army was destroyed by disease and starvation, and after the complete failure of the expedition Hamilton returned to England in September 1634. He now became Charles I.'s chief adviser in Scottish affairs. In May 1638, after the outbreak of the revolt against the English Prayer-Book, he was appointed commissioner for Scotland to appease the discontents. He described the Scots as being "possessed by the devil," and instead of doing his utmost to support the king's interests was easily intimidated by the covenanting leaders and persuaded of the impossibility of resisting their demands, finally returning to Charles to urge him to give way. It is said that he so far forgot his trust as to encourage the Scottish leaders in their resistance in order to gain their favour.² On the 27th of July Charles sent him back with new proposals for the election of an assembly and a parliament, episcopacy being safeguarded but bishops being made responsible to future assemblies. After a wrangle concerning the mode of election he again returned to Charles. Having been sent back to Edinburgh on the 17th of September, he brought with him a revocation of the prayer-book and canons and another covenant to be substituted for the national covenant. On the 21st of November Hamilton presided over the first meeting of the assembly in Glasgow cathedral, but dissolved it on the 28th on its declaring the bishops responsible to its authority. The assembly, however, continued to sit notwithstanding, and Hamilton returned to England to give an account of his failure, leaving the enemy triumphant and in possession. War was now decided upon, and Hamilton was chosen to command an expedition to the Forth to menace the rear of the Scots. On arrival on the 1st of May 1639 he found the plan impossible, despaired of success, and was recalled in June. On the 8th of July, after a hostile reception at Edinburgh, he resigned his commissionership. He supported Strafford's proposal to call the Short Parliament, but otherwise opposed him as strongly as he could, as the chief adversary of the Scots; and he aided the elder Vane, it was

¹ James, Lord Hamilton = Princess Mary Stuart,
(d. 1479). | daughter of James II.

James, Lord Hamilton and 1st earl of Arran
(d. c. 1529).

James, duke of Chateaufort, and 2nd earl of Arran
(d. 1575).

James, 3rd earl of Arran
(d. 1609).

John, 1st marquis of Hamilton
(d. 1604).

James, 2nd marquis of Hamilton
(d. 1625).

James, 3rd marquis and 1st duke of Hamilton.

² See S. R. Gardiner in the *Dict. of Nat. Biography*.

believed, in accomplishing Strafford's destruction by sending for him to the Long Parliament. Hamilton now supported the parliamentary party, desired an alliance with his nation, and persuaded Charles in February 1641 to admit some of their leaders into the council. On the death of Strafford Hamilton was confronted by a new antagonist in Montrose, who detested both his character and policy and repudiated his supremacy in Scotland. On the 20th of August 1641 he accompanied Charles on his last visit to Scotland. His aim now was to effect an alliance between the king and Argyll, the former accepting Presbyterianism and receiving the help of the Scots against the English parliament, and when this failed he abandoned Charles and adhered to Argyll. In consequence he received a challenge from Lord Ker, of which he gave the king information, and obtained from Ker an apology. Montrose wrote to Charles declaring he could prove Hamilton to be a traitor. The king himself spoke of him as being "very active in his own preservation." Shortly afterwards the plot—known as the "Incident"—to seize Argyll, Hamilton and the latter's brother, the earl of Lanark, was discovered, and on the 12th of October they fled from Edinburgh. Hamilton returned not long afterwards, and notwithstanding all that had occurred still retained Charles's favour and confidence. He returned with him to London and accompanied him on the 5th of January 1642 when he went to the city after the failure to secure the five members. In July Hamilton went to Scotland on a hopeless mission to prevent the intervention of the Scots in the war, and a breach then took place between him and Argyll. When in February 1643 proposals of mediation between Charles and the parliament came from Scotland, Hamilton instigated the "cross petition" which demanded from Charles the surrender of the annuities of tithes in order to embarrass Loudoun, the chief promoter of the project, to whom they had already been granted. This failing, he promoted a scheme for overwhelming the influence and votes of Argyll and his party by sending to Scotland all the Scottish peers then with the king, thereby preventing any assistance to the parliament coming from that quarter, while Charles was to guarantee the establishment of Presbyterianism in Scotland only. This foolish intrigue was strongly opposed by Montrose, who was eager to strike a sudden blow and anticipate and annihilate the plans of the Covenanters. Hamilton, however, gained over the queen for his project, and in September was made a duke, while Montrose was condemned to inaction. Hamilton's scheme, however, completely failed. He had no control over the parliament. He was unable to hinder the meeting of the convention of the estates which assembled without the king's authority, and his supporters found themselves in a minority. Finally, on refusing to take the Covenant, Hamilton and Lanark were obliged to leave Scotland. They arrived at Oxford on the 16th of December. Hamilton's conduct had at last incurred Charles's resentment and he was sent, in January 1644, a prisoner to Pendennis Castle, in 1645 being removed to St Michael's Mount, where he was liberated by Fairfax's troops on the 23rd of April 1646. Subsequently he showed great activity in the futile negotiations between the Scots and Charles at Newcastle. In 1648, in consequence of the seizure of Charles by the army in 1647, Hamilton obtained a temporary influence and authority in the Scottish parliament over Argyll, and led a large force into England in support of the king on the 8th of July. He showed complete incapacity in military command; was kept in check for some time by Lambert; and though outnumbering the enemy by 24,000 to about 9000 men, allowed his troops to disperse over the country and to be defeated in detail by Cromwell during the three days August 17th-19th at the so-called battle of Preston, being himself taken prisoner on the 25th. He was tried on the 6th of February 1649, condemned to death on the 6th of March and executed on the 9th.

Hamilton, during his unfortunate career, had often been suspected of betraying the king's cause, and, as an heir to the Scottish throne, of intentionally playing into the hands of the Covenanters with a view of procuring the crown for himself. The charge was brought against him as early as 1631 when he was

levying men in Scotland for the German expedition, but Charles gave no credence to it and showed his trust in Hamilton by causing him to share his own room. The charge, however, always clung to him, and his intriguing character and hopeless management of the king's affairs in Scotland gave colour to the accusation. There seems, however, to be no real foundation for it. His career is sufficiently explained by his thoroughly weak and egotistical character. He took no interest whatever in the great questions at issue, was neither loyal nor patriotic, and only desired peace and compromise to avoid personal losses. "He was devoid of intellectual or moral strength, and was therefore easily brought to fancy all future tasks easy and all present obstacles insuperable."¹ A worse choice than Hamilton could not possibly have been made in such a crisis, and his want of principle, of firmness and resolution, brought irretrievable ruin upon the royal cause.

Hamilton's three sons died young, and the dukedom passed by special remainder to his brother William, earl of Lanark. On the latter's death in 1651 the Scottish titles reverted to the 1st duke's daughter, Anne, whose husband, William Douglas, was created (third) duke of Hamilton.

BIBLIOGRAPHY.—Article in the *Dict. of Nat. Biog.* by S. R. Gardiner; *History of England and of the Civil War*, by the same author; *Memoirs of the Dukes of Hamilton*, by G. Burnet; *Lauderdale Papers* (Camden Society, 1884-1885); *The Hamilton Papers*, ed. by S. R. Gardiner (Camden Society, 1880) and *addenda* (Camden Miscellany, vol. ix., 1895); *Thomson Tracts* in the British Museum, 550 (6), 1948 (30) (account of his supposed treachery), and 546 (21) (speech on the scaffold). (P. C. Y.)

HAMILTON, JOHN (c. 1511-1571), Scottish prelate and politician, was a natural son of James Hamilton, 1st earl of Arran. At a very early age he became a monk and abbot of Paisley, and after studying in Paris he returned to Scotland, where he soon rose to a position of power and influence under his half-brother, the regent Arran. He was made keeper of the privy seal in 1543 and bishop of Dunkeld two years later; in 1546 he followed David Beaton as archbishop of St Andrews, and about the same time he became treasurer of the kingdom. He made vigorous efforts to stay the growth of Protestantism, but with one or two exceptions "persecution was not the policy of Archbishop Hamilton," and in the interests of the Roman Catholic religion a catechism called *Hamilton's Catechism* (published with an introduction by T. G. Law in 1884) was drawn up and printed, possibly at his instigation. Having incurred the displeasure of the Protestants, now the dominant party in Scotland, the archbishop was imprisoned in 1563. After his release he was an active partisan of Mary queen of Scots; he baptized the infant James, afterwards King James VI., and pronounced the divorce of the queen from Bothwell. He was present at the battle of Langside, and some time later took refuge in Dumbarton Castle. Here he was seized, and on the charge of being concerned in the murders of Lord Darnley and the regent Murray he was tried, and hanged on the 6th of April 1571. The archbishop had three children by his mistress, Grizzel Sempill.

HAMILTON, PATRICK (1504-1528), Scottish divine, second son of Sir Patrick Hamilton, well known in Scottish chivalry, and of Catherine Stewart, daughter of Alexander, duke of Albany, second son of James II. of Scotland, was born in the diocese of Glasgow, probably at his father's estate of Stanehouse in Lanarkshire. He was educated probably at Limplithgow. In 1517 he was appointed titular abbot of Ferne, Ross-shire; and it was probably about the same year that he went to study at Paris, for his name is found in an ancient list of those who graduated there in 1520. It was doubtless in Paris, where Luther's writings were already exciting much discussion, that he received the germs of the doctrines he was afterwards to uphold. From Alexander Ales we learn that Hamilton subsequently went to Louvain, attracted probably by the fame of Erasmus, who in 1521 had his headquarters there. Returning to Scotland, the young scholar naturally selected St Andrews, the capital of the church and of learning, as his residence. On

¹ See S. R. Gardiner in the *Dict. of Nat. Biography*.

the 9th of June 1523 he became a member of the university of St Andrews, and on the 3rd of October 1524 he was admitted to its faculty of arts. There Hamilton attained such influence that he was permitted to conduct as precentor a musical mass of his own composition in the cathedral. But the reformed doctrines had now obtained a firm hold on the young abbot, and he was eager to communicate them to his fellow-countrymen. Early in 1527 the attention of James Beaton, archbishop of St Andrews, was directed to the heretical preaching of the young priest, whereupon he ordered that Hamilton should be formally summoned and accused. Hamilton fled to Germany, first visiting Luther at Wittenberg, and afterwards enrolling himself as a student, under Franz Lambert of Avignon, in the new university of Marburg, opened on the 30th of May 1527 by Philip, landgrave of Hesse. Hermann von dem Busche, one of the contributors to the *Epistolae obscurorum virorum*, John Frith and Tyndale were among those whom he met there. Late in the autumn of 1527 Hamilton returned to Scotland, bold in the conviction of the truth of his principles. He went first to his brother's house at Kincavel, near Limplithgow, in which town he preached frequently, and soon afterwards he married a young lady of noble rank, whose name has not come down to us. Beaton, avoiding open violence through fear of Hamilton's high connexions, invited him to a conference at St Andrews. The reformer, predicting that he was going to confirm the pious in the true doctrine by his death, resolutely accepted the invitation, and for nearly a month was permitted to preach and dispute, perhaps in order to provide material for accusation. At length, however, he was summoned before a council of bishops and clergy presided over by the archbishop; there were thirteen charges, seven of which were based on the doctrines affirmed in the *Loci communes*. On examination Hamilton maintained that these were undoubtedly true. The council condemned him as a heretic on the whole thirteen charges. Hamilton was seized, and, it is said, surrendered to the soldiery on an assurance that he would be restored to his friends without injury. The council convicted him, after a sham disputation with Friar Campbell, and handed him over to the secular power. The sentence was carried out on the same day (February 29, 1528) lest he should be rescued by his friends, and he was burned at the stake as a heretic. His courageous bearing attracted more attention than ever to the doctrines for which he suffered, and greatly helped to spread the Reformation in Scotland. The "reek of Patrick Hamilton infected all it blew on." His martyrdom is singular in this respect, that he represented in Scotland almost alone the Lutheran stage of the Reformation. His only book was entitled *Loci communes*, known as "Patrick's Places." It set forth the doctrine of justification by faith and the contrast between the gospel and the law in a series of clear-cut propositions. It is to be found in Fox's *Acts and Monuments*.

HAMILTON, ROBERT (1743-1829), Scottish economist and mathematician, was born at Pilrig, Edinburgh, on the 11th of June 1743. His grandfather, William Hamilton, principal of Edinburgh University, had been a professor of divinity. Having completed his education at the university of Edinburgh, where he was distinguished in mathematics, Robert was induced to enter a banking-house in order to acquire a practical knowledge of business, but his ambition was really academic. In 1769 he gave up business pursuits and accepted the rectorship of Perth academy. In 1779 he was presented to the chair of natural philosophy at Aberdeen University. For many years, however, by private arrangement with his colleague Professor Copland, Hamilton taught the class of mathematics. In 1817 he was presented to the latter chair.

Hamilton's most important work is the *Essay on the National Debt*, which appeared in 1813 and was undoubtedly the first to expose the economic fallacies involved in Pitt's policy of a sinking fund. It is still of value. A posthumous volume published in 1830, *The Progress of Society*, is also of great ability, and is a very effective treatment of economical principles by tracing their natural origin and position in the development of social life. Some minor works of a practical character (*Introduction to Merchandize*, 1777; *Essay on War and Peace*, 1790) are now forgotten.

HAMILTON, THOMAS (1780-1842), Scottish writer, younger brother of the philosopher, Sir William Hamilton, Bart., was born in 1780. He was educated at Glasgow University, where he made a close friend of Michael Scott, the author of *Tom Cringle's Log*. He entered the army in 1810, and served throughout the Peninsular and American campaigns, but continued to cultivate his literary tastes. On the conclusion of peace he withdrew, with the rank of captain, from active service. He contributed both prose and verse to *Blackwood's Magazine*, in which appeared his vigorous and popular military novel, *Cyril Thornton* (1827). His *Annals of the Peninsular Campaign*, published originally in 1829, and republished in 1849 with additions by Frederick Hardman, is written with great clearness and impartiality. His only other work, *Men and Manners in America*, published originally in 1833, is somewhat coloured by British prejudice, and by the author's aristocratic dislike of a democracy. Hamilton died at Pisa on the 7th of December 1842.

HAMILTON, WILLIAM (1704-1754), Scottish poet, the author of "The Braes of Yarrow," was born in 1704 at Bangour in Linlithgowshire, the son of James Hamilton of Bangour, a member of the Scottish bar. As early as 1724 we find him contributing to Allan Ramsay's *Tea Table Miscellany*. In 1745 Hamilton joined the cause of Prince Charles, and though it is doubtful whether he actually bore arms, he celebrated the battle of Prestonpans in verse. After the disaster of Culloden he lurked for several months in the Highlands and escaped to France; but in 1749 the influence of his friends procured him permission to return to Scotland, and in the following year he obtained possession of the family estate of Bangour. The state of his health compelled him, however, to live abroad, and he died at Lyons on the 25th of March 1754. He was buried in the Abbey Church of Holyroodhouse, Edinburgh. He was twice married—"into families of distinction," says the preface of the authorized edition of his poems.

Hamilton left behind him a considerable number of poems, none of them except "The Braes of Yarrow" of striking originality. The collection is composed of odes, epitaphs, short pieces of translation, songs, and occasional verses. The longest is "Contemplation, or the Triumph of Love" (about 500 lines). The first edition was published without his permission by Foulis (Glasgow, 1748), and introduced by a preface from the pen of Adam Smith. Another edition with corrections by himself was brought out by his friends in 1760, and to this was prefixed a portrait engraved by Robert Strange.

In 1850 James Paterson edited *The Poems and Songs of William Hamilton*. This volume contains several poems till then unpublished, and gives a life of the author.

HAMILTON, SIR WILLIAM (1730-1803), British diplomatist and archaeologist, son of Lord Archibald Hamilton, governor of Greenwich hospital and of Jamaica, was born in Scotland on the 13th of December 1730, and served in the 3rd Regiment of Foot Guards from 1747 to 1758. He left the army after his marriage with Miss Barlow, a Welsh heiress from whom he inherited an estate near Swansea upon her death in 1782. Their only child, a daughter, died in 1775. From 1761 to 1764 he was member of parliament for Midhurst, but in the latter year he was appointed envoy to the court of Naples, a post which he held for thirty-six years—until his recall in 1800. During the greater part of this time the official duties of the minister were of small importance. It was enough that the representative of the British crown should be a man of the world whose means enabled him to entertain on a handsome scale. Hamilton was admirably qualified for these duties, being an amiable and accomplished man, who took an intelligent interest in science and art. In 1766 he became a member of the Royal Society, and between that year and 1780 he contributed to its Philosophical Transactions a series of observations on the action of volcanoes, which he had made, or caused to be made, at Vesuvius and Etna. He employed a draftsman named Fabris to make studies of the eruption of 1775 and 1776, and a Dominican, Resina, to make observations at a later period. He published

several treatises on earthquakes and volcanoes between 1776 and 1783. He was a fellow of the Society of Antiquaries and of the Dilettanti, and a notable collector. Many of his treasures went to enrich the British Museum. In 1772 he was made a knight of the Bath. The last ten years of his life presented a curious contrast to the elegant peace of those which had preceded them. In 1791 he married Emma Lyon (see the separate article on Lady Hamilton). The outbreak of the French Revolution and the rapid extension of the revolutionary movement in Western Europe soon overwhelmed Naples. It was a misfortune for Sir William that he was left to meet the very trying political and diplomatic conditions which arose after 1793. His health had begun to break down, and he suffered from bilious fever. Sir William was in fact in a state approaching dotage before his recall, a fact which, combined with his senile devotion to Lady Hamilton, has to be considered in accounting for his extraordinary complaisance in her relations with Nelson. He died on the 6th of April 1803.

See E. Edwards, *Lives of the Founders of the British Museum* (London, 1870); and the authorities given in the article on Emma, Lady Hamilton.

HAMILTON, SIR WILLIAM, Bart. (1788-1856), Scottish metaphysician, was born in Glasgow on the 8th of March 1788. His father, Dr William Hamilton, had in 1781, on the strong recommendation of the celebrated William Hunter, been appointed to succeed his father, Dr Thomas Hamilton, as professor of anatomy in the university of Glasgow; and when he died in 1790, in his thirty-second year, he had already gained a great reputation. William Hamilton and a younger brother (afterwards Captain Thomas Hamilton, *q.v.*) were thus brought up under the sole care of their mother. William received his early education in Scotland, except during two years which he spent in a private school near London, and went in 1807, as a Snell exhibitioner, to Balliol College, Oxford. He obtained a first-class in *literis humanioribus* and took the degree of B.A. in 1811, M.A. in 1814. He had been intended for the medical profession, but soon after leaving Oxford he gave up this idea, and in 1813 became a member of the Scottish bar. His life, however, was mainly that of a student; and the following years, marked by little of outward incident, were filled by researches of all kinds, through which he daily added to his stores of learning, while at the same time he was gradually forming his philosophic system. Investigation enabled him to make good his claim to represent the ancient family of Hamilton of Preston, and in 1816 he took up the baronetcy, which had been in abeyance since the death of Sir Robert Hamilton of Preston (1650-1701), well known in his day as a Covenanted leader.

Two visits to Germany in 1817 and 1820 led to his taking up the study of German and later on that of contemporary German philosophy, which was then almost entirely neglected in the British universities. In 1820 he was a candidate for the chair of moral philosophy in the university of Edinburgh, which had fallen vacant on the death of Thomas Brown, colleague of Dugald Stewart, and the latter's consequent resignation, but was defeated on political grounds by John Wilson (1785-1854), the "Christopher North" of *Blackwood's Magazine*. Soon afterwards (1821) he was appointed professor of civil history, and as such delivered several courses of lectures on the history of modern Europe and the history of literature. The salary was £100 a year, derived from a local beer tax, and was discontinued after a time. No pupils were compelled to attend, the class dwindled, and Hamilton gave it up when the salary ceased. In January 1827 he suffered a severe loss in the death of his mother, to whom he had been a devoted son. In March 1828 he married his cousin Janet Marshall.

In 1829 his career of authorship began with the appearance of the well-known essay on the "Philosophy of the Unconditioned" (a critique of Comte's *Cours de philosophie*)—the first of a series of articles contributed by him to the *Edinburgh Review*. He was elected in 1836 to the Edinburgh chair of logic and metaphysics, and from this time dates the influence which, during the best twenty years, he exerted over the thought of, the younger

generation in Scotland. Much about the same time he began the preparation of an annotated edition of Reid's works, intending to annex to it a number of dissertations. Before, however, this design had been carried out, he was struck (1844) with paralysis of the right side, which seriously crippled his bodily powers, though it left his mind wholly unimpaired. The edition of Reid appeared in 1846, but with only seven of the intended dissertations—the last, too, unfinished. It was his distinct purpose to complete the work, but this purpose remained at his death unfulfilled, and all that could be done afterwards was to print such materials for the remainder, or such notes on the subjects to be discussed, as were found among his MSS. Considerably before this time he had formed his theory of logic, the leading principles of which were indicated in the prospectus of "an essay on a new analytic of logical forms" prefixed to his edition of Reid. But the elaboration of the scheme in its details and applications continued during the next few years to occupy much of his leisure. Out of this arose a sharp controversy with Augustus de Morgan. The essay did not appear, but the results of the labour gone through are contained in the appendices to his *Lectures on Logic*. Another occupation of these years was the preparation of extensive materials for a publication which he designed on the personal history, influence and opinions of Luther. Here he advanced so far as to have planned and partly carried out the arrangement of the work; but it did not go further, and still remains in MS. In 1852-1853 appeared the first and second editions of his *Discussions in Philosophy, Literature and Education*, a reprint, with large additions, of his contributions to the *Edinburgh Review*. Soon after, his general health began to fail. Still, however, aided now as ever by his devoted wife, he persevered in literary labour; and during 1854-1855 he brought out nine volumes of a new edition of Stewart's works. The only remaining volume was to have contained a memoir of Stewart, but this he did not live to write. He taught his class for the last time in the winter of 1855-1856. Shortly after the close of the session he was taken ill, and on the 6th of May 1856 he died in Edinburgh.

Hamilton's positive contribution to the progress of thought is comparatively slight, and his writings, even where reinforced by the copious lecture notes taken by his pupils, cannot be said to present a comprehensive philosophic system. None the less he did considerable service by stimulating a spirit of criticism in his pupils, by insisting on the great importance of psychology as opposed to the older metaphysical method, and not least by his recognition of the importance of German philosophy, especially that of Kant. By far his most important work was his "Philosophy of the Unconditioned," the development of the principle that for the human finite mind there can be no knowledge of the Infinite. The basis of his whole argument is the thesis, "To think is to condition." Deeply impressed with Kant's antithesis between subject and object, the knowing and the known, Hamilton laid down the principle that every object is known only in virtue of its relations to other objects (see RELATIVITY OF KNOWLEDGE). From this it follows limitless time, space, power and so forth are humanly speaking inconceivable. The fact, however, that all thought seems to demand the idea of the infinite or absolute provides a sphere for faith, which is thus the specific faculty of theology. It is a weakness characteristic of the human mind that it cannot conceive any phenomenon without a beginning; hence the conception of the causal relation, according to which every phenomenon has its cause in preceding phenomena, and its effect in subsequent phenomena. The causal concept is, therefore, only one of the ordinary necessary forms of the cognitive consciousness limited, as we have seen, by being confined to that which is relative or conditioned. As regards the problem of the nature of objectivity, Hamilton simply accepts the evidence of consciousness as to the separate existence of the object: "the root of our nature cannot be a lie." In virtue of this assumption, Hamilton's philosophy becomes a "natural realism." In fact his whole position is a strange compound of Kant and Reid. Its chief practical corollary is the denial of philosophy as a method of attaining absolute knowledge and its relegation to the academic sphere of mental training. The transition from philosophy to theology, i.e. to the sphere of faith, is presented by Hamilton under the analogous relation between the mind and the body. As the mind is to the body, so is the unconditioned Absolute or God to the world of the conditioned. Consciousness, itself a conditioned phenomenon, must derive from or depend on some different thing prior to or behind material phenomena. Curiously enough, however, Hamilton does not explain how it comes about that God, who in the terms of the analogy bears to the conditioned mind the relation which the conditioned mind bears to its

objects, can Himself be unconditioned. He can be regarded only as related to consciousness, and in so far as, therefore, not absolute or unconditioned. Thus the very principles of Hamilton's philosophy are apparently violated in his theological argument.

Hamilton regarded logic as a purely formal science; it seemed to him an unscientific mixing together of heterogeneous elements to treat as parts of the same science the formal and the material conditions of knowledge. He was quite ready to allow that on this view logic cannot be used as a means of discovering or guaranteeing facts, even the most general, and expressly asserted that it has to do, not with the objective validity, but only with the mutual relations, of judgments. He further held that induction and deduction are correlative processes of formal logic, each resting on the necessities of thought and deriving thence its several laws. The only logical laws which he recognized were the three axioms of identity, non-contradiction, and excluded middle, which he regarded as severally phases of one general condition of the possibility of existence and, therefore, of thought. The law of reason and consequent he considered not as different, but merely as expressing metaphysically what these express logically. He added as a postulate—which in his theory was of importance—that logic be allowed to state explicitly what is thought implicitly.

In logic, Hamilton is known chiefly as the inventor of the doctrine of the "quantification of the predicate," i.e. that the judgment "All A is B" should really mean "All A is all B," whereas the ordinary universal proposition should be stated "All A is some B." This view, which was supported by Stanley Jevons, is fundamentally at fault since it implies that the predicate is thought of in its extension; in point of fact when a judgment is made, e.g. about men, that they are mortal ("All men are mortal"), the intention is to attribute a quality (i.e. the predicate is used in connotation). In other words, we are not considering the question "what kind are men among the various things which must die?" (as is implied in the form "all men are some mortals") but "what is the fact about men?" We are not stating a mere identity (see further, e.g., H. W. B. Joseph, *Introduction to Logic*, 1906, pp. 198 foll.).

The philosopher to whom above all others Hamilton professed allegiance was Aristotle. His works were the object of his profound and constant study, and supplied in fact the mould in which his whole philosophy was cast. With the commentators on the Aristotelian writings, ancient, medieval and modern, he was also familiar; and the scholastic philosophy he studied with care and appreciation at a time when it had hardly yet begun to attract attention in his country. His wide reading enabled him to trace many a doctrine to the writings of forgotten thinkers; and nothing gave him greater pleasure than to draw forth such from their obscurity, and to give due acknowledgment, even if it chanced to be of the prior possession of a view or argument that he had thought out for himself. Of modern German philosophy he was a diligent, if not always a sympathetic, student. How profoundly his thinking was modified by that of Kant is evident from the tenor of his speculations; nor was this less the case because, on fundamental points, he came to widely different conclusions.

Any account of Hamilton would be incomplete which regarded him only as a philosopher, for his knowledge and his interests embraced all subjects related to that of the human mind. Physical and mathematical science had, indeed, no attraction for him; but his study of anatomy and physiology was minute and experimental. In literature alike ancient and modern he was widely and deeply read; and, from his unusual powers of memory, the stores which he had acquired were always at command. If there was one period with the literature of which he was more particularly familiar, it was the 16th and 17th centuries. Here in every department he was at home. He had gathered a vast amount of his theological lore, had a critical knowledge especially of his Latin poetry, and was minutely acquainted with the history of the actors in its varied scenes, not only as narrated in professed records, but as revealed in the letters, table-talk, and casual effusions of themselves or their contemporaries (cf. his article on the *Epistolæ obscurorum virorum*, and his pamphlet on the *Disruption of the Church of Scotland* in 1843). Among his literary projects were editions of the works of George Buchanan and Julius Caesar Scaliger. His general scholarship found expression in his library, which, though mainly, was far from being exclusively, a philosophical collection. It now forms a distinct portion of the library of the university of Glasgow.

His chief practical interest was in education—an interest which he manifested alike as a teacher and as a writer, and which had led him long before he was either to a study of the subject both theoretical and historical. He thence adopted views as to the ends and methods of education that, when afterwards carried out or advocated by him, met with general recognition; but he also expressed in one of his articles an unfavourable view of the study of mathematics as a mental gymnastic, which excited much opposition, but which he never saw reason to alter. As a teacher, he was zealous and successful, and his writings on university organization and reform had, at the time of their appearance, a decisive practical effect, and contain much that is of permanent value.

His posthumous works are his *Lectures on Metaphysics and Logic*, 4 vols., edited by H. L. Mansel, Oxford, and John Veitch (*Metaphysics*,

1858; *Logic*, 1860); and *Additional Notes to Reid's Works*, from Sir W. Hamilton's MSS., under the editorship of H. L. Mansel, D.D. (1862). A *Memoir of Sir W. Hamilton*, by Veitch, appeared in 1869.

HAMILTON, WILLIAM GERARD (1729-1796), English statesman, popularly known as "Single Speech Hamilton," was born in London on the 28th of January 1729, the son of a Scottish bencher of Lincoln's Inn. He was educated at Winchester and at Oriel College, Oxford. Inheriting his father's fortune he entered political life and became M.P. for Petersfield, Hampshire. His maiden speech, delivered on the 13th of November 1755, during the debate on the address, which excited Walpole's admiration, is generally supposed to have been his only effort in the House of Commons. But the nickname "Single Speech" is undoubtedly misleading, and Hamilton is known to have spoken with success on other occasions, both in the House of Commons and in the Irish parliament. In 1756 he was appointed one of the commissioners for trade and plantations, and in 1761 he became chief secretary to Lord Halifax, the lord-lieutenant of Ireland, as well as Irish M. P. for Killebegs and English M. P. for Pontefract. He was chancellor of the exchequer in Ireland in 1763, and subsequently filled various other administrative offices. Hamilton was thought very highly of by Dr Johnson, and it is certain that he was strongly opposed to the British taxation of America. He died in London on the 16th of July 1796, and was buried in the chancel vault of St Martin's-in-the-fields.

Two of his speeches in the Irish House of Commons, and some other miscellaneous works, were published after his death under the title *Parliamentary Logic*.

HAMILTON, SIR WILLIAM ROWAN (1805-1865), Scottish mathematician, was born in Dublin on the 4th of August 1805. His father, Archibald Hamilton, who was a solicitor, and his uncle, James Hamilton (curate of Trim), migrated from Scotland in youth. A branch of the Scottish family to which they belonged had settled in the north of Ireland in the time of James I., and this fact seems to have given rise to the common impression that Hamilton was an Irishman.

His genius first displayed itself in the form of a wonderful power of acquiring languages. At the age of seven he had already made very considerable progress in Hebrew, and before he was thirteen he had acquired, under the care of his uncle, who was an extraordinary linguist, almost as many languages as he had years of age. Among these, besides the classical and the modern European languages, were included Persian, Arabic, Hindustani, Sanskrit and even Malay. But though to the very end of his life he retained much of the singular learning of his childhood and youth, often reading Persian and Arabic in the intervals of sterner pursuits, he had long abandoned them as a study, and employed them merely as a relaxation.

His mathematical studies seem to have been undertaken and carried to their full development without any assistance whatever, and the result is that his writings belong to no particular "school," unless indeed we consider them to form, as they are well entitled to do, a school by themselves. As an arithmetical calculator he was not only wonderfully expert, but he seems to have occasionally found a positive delight in working out to an enormous number of places of decimals the result of some irksome calculation. At the age of twelve he engaged Zerah Colburn, the American "calculating boy," who was then being exhibited as a curiosity in Dublin, and he had not always the worst of the encounter. But, two years before, he had accidentally fallen in with a Latin copy of *Euclid*, which he eagerly devoured; and at twelve he attacked Newton's *Arithmetica universalis*. This was his introduction to modern analysis. He soon commenced to read the *Principia*, and at sixteen he had mastered a great part of that work, besides some more modern works on analytical geometry and the differential calculus.

About this period he was also engaged in preparation for entrance at Trinity College, Dublin, and had therefore to devote a portion of his time to classics. In the summer of 1822, in his seventeenth year, he began a systematic study of Laplace's

Mécanique Céleste. Nothing could be better fitted to call forth such mathematical powers as those of Hamilton, for Laplace's great work, rich to profusion in analytical processes alike novel and powerful, demands from the most gifted student careful and often laborious study. It was in the successful effort to open this treasure-house that Hamilton's mind received its final temper, "Dés-lors il commença à marcher seul," to use the words of the biographer of another great mathematician. From that time he appears to have devoted himself almost wholly to original investigation (so far at least as regards mathematics), though he ever kept himself well acquainted with the progress of science both in Britain and abroad.

Having detected an important defect in one of Laplace's demonstrations, he was induced by a friend to write out his remarks, that they might be shown to Dr John Brinkley (1763-1835), afterwards bishop of Cloyne, but who was then the first royal astronomer for Ireland, and an accomplished mathematician. Brinkley seems at once to have perceived the vast talents of young Hamilton, and to have encouraged him in the kindest manner. He is said to have remarked in 1823 of this lad of eighteen: "This young man, I do not say *will be*, but *is*, the first mathematician of his age."

Hamilton's career at College was perhaps unexamined. Amongst a number of competitors of more than ordinary merit, he was first in every subject and at every examination. He achieved the rare distinction of obtaining an *optime* for both Greek and for physics. How many more such honours he might have attained it is impossible to say; but he was expected to win both the gold medals at the degree examination, had his career as a student not been cut short by an unprecedented event. This was his appointment to the Andrews professorship of astronomy in the university of Dublin, vacated by Dr Brinkley in 1827. The chair was not exactly offered to him, as has been sometimes asserted, but the electors, having met and talked over the subject, authorized one of their number, who was Hamilton's personal friend, to urge him to become a candidate, a step which his modesty had prevented him from taking. Thus, when barely twenty-two, he was established at the Observatory, Dunsink, near Dublin. He was not specially fitted for the post, for although he had a profound acquaintance with theoretical astronomy, he had paid but little attention to the regular work of the practical astronomer. And it must be said that his time was better employed in original investigations than it would have been had he spent it in observations made even with the best of instruments,—infinitely better than if he had spent it on those of the observatory, which, however good originally, were then totally unfit for the delicate requirements of modern astronomy. Indeed there can be little doubt that Hamilton was intended by the university authorities who elected him to the professorship of astronomy to spend his time as he best could for the advancement of science, without being tied down to any particular branch. Had he devoted himself to practical astronomy they would assuredly have furnished him with modern instruments and an adequate staff of assistants.

In 1835, being secretary to the meeting of the British Association which was held that year in Dublin, he was knighted by the lord-lieutenant. But far higher honours rapidly succeeded, among which we may merely mention his election in 1837 to the president's chair in the Royal Irish Academy, and the rare distinction of being made corresponding member of the academy of St Petersburg. These are the few salient points (other, of course, than the epochs of his more important discoveries and inventions presently to be considered) in the uneventful life of this great man. He retained his wonderful faculties unimpaired to the very last, and steadily continued till within a day or two of his death, which occurred on the 2nd of September 1865, the task (his *Elements of Quaternions*) which had occupied the last six years of his life.

The germ of his first great discovery was contained in one of those early papers which in 1823 he communicated to Dr Brinkley, by whom, under the title of "Caustics," it was presented in 1824 to the Royal Irish Academy. It was referred as usual to a committee. Their report, while acknowledging the novelty and value of its

contents, and the great mathematical skill of its author, recommended that, before being published, it should be still further developed and simplified. During the next three years the paper grew to an immense bulk, principally by the additional details which had been inserted at the desire of the committee. But it also assumed a much more intelligible form, and the grand features of the new method were now easily to be seen. Hamilton himself seems not till this period to have fully understood either the nature or the importance of his discovery, for it is only now that we find him announcing his intention of applying his method to dynamics. The paper was finally entitled "Theory of Systems of Rays," and the first part was printed in 1828 in the *Transactions of the Royal Irish Academy*. It is understood that the more important contents of the second and third parts appeared in the three voluminous supplements (to the first part) which were published in the same *Transactions*, and in the two papers "On a General Method in Dynamics," which appeared in the *Philosophical Transactions* in 1834-1835. The principle of "Varying Action" is the great feature of these papers; and it is strange, indeed, that the one particular result of this theory which, perhaps more than anything else that Hamilton has done, has rendered his name known beyond the little world of true philosophers, should have been easily within the reach of Augustin Fresnel and others for many years before, and in no way required Hamilton's new conceptions or methods, although it was by them that he was led to its discovery. This singular result is still known by the name "conical refraction," which he proposed for it when he first predicted its existence in the third supplement to his "Systems of Rays," read in 1824.

The step from optics to dynamics in the application of the method of "Varying Action" was made in 1827, and communicated to the Royal Society, in whose *Philosophical Transactions* for 1834 and 1835 there are two papers on the subject. These display, like the "Systems of Rays," a mastery over symbols and a flow of mathematical language almost unequalled. But they contain what is far more valuable still, the greatest addition which dynamical science had received since the grand strides made by Sir Isaac Newton and Joseph Louis Lagrange. C. G. J. Jacobi and other mathematicians have developed to a great extent, and as a question of pure mathematics only, Hamilton's processes, and have thus made extensive additions to our knowledge of differential equations. But there can be little doubt that we have as yet obtained only a mere glimpse of the vast physical results of which they contain the germ. And though this is of course by far the more valuable aspect in which any such contribution to science can be looked at, the other must not be despised. It is characteristic of most of Hamilton's, as of nearly all his great discoveries, that even their indirect consequences are of high value.

The other great contribution made by Hamilton to mathematical science, the invention of Quaternions, is treated under that heading. The following characteristic extract from a letter shows Hamilton's own opinion of his mathematical work, and also gives a hint of the devices which he employed to render written language as expressive as actual speech. His first great work, *Lectures on Quaternions* (Dublin, 1825), is almost painful to read in consequence of the frequent use of italics and capitals.

"I hope that it may not be considered as unpardonable vanity or presumption on my part, if, as my own taste has always led me to feel a greater interest in *methods* than in *results*, so it is by *METHODS*, rather than by any *THEOREMS*, which can be separately quoted, that I desire and hope to be remembered. Nevertheless it is only human nature, to derive some pleasure from being cited, now and then, even about a 'Theorem'; especially where . . . the *quoter* can enrich the subject, by combining it with researches of his own."

The discoveries, papers and treatises we have mentioned might well have formed the whole work of a long and laborious life. But not to speak of his enormous collection of MS. books, full to overflowing with new and original matter, which have been handed over to Trinity College, Dublin, the works we have already called attention to hardly form the greater portion of what he has published. His extraordinary investigations connected with the solution of algebraic equations of the fifth degree, and his examination of the results arrived at by N. H. Abel, G. B. Jerrard, and others in their researches on this subject, form another grand contribution to science. There is next his great paper on *Fluctuating Functions*, a subject which, since the time of J. Fourier, has been of immense and ever increasing value in physical applications of mathematics. There is also the extremely ingenious invention of the hodograph. Of his extensive investigations into the solution (especially by numerical approximation) of certain classes of differential equations which constantly occur in the treatment of physical questions, only a few items have been published, at intervals, in the *Philosophical Magazine*. Besides all this, Hamilton was a voluminous correspondent. Often a single letter of his occupied from fifty to a hundred or more closely written pages, all devoted to the minute consideration of every feature of some particular problem; for it was one of the peculiar characteristics of his mind never to be satisfied with a general understanding of a question; he pursued it until he knew it in all its details. He was ever courteous and kind in answering applications for assistance in the study of his works,

even when his compliance must have cost him much time. He was excessively precise and hard to please with reference to the final polish of his own works for publication; and it was probably for this reason that he published so little compared with the extent of his investigations.

Like most men of great originality, Hamilton generally matured his ideas before putting pen to paper. "He used to carry on," says his elder son, William Edwin Hamilton, "long trains of algebraical and arithmetical calculations in his mind, during which he was unconscious of the earthly necessity of eating; we used to bring in a 'snack' and leave it in his study, but a brief nod of recognition of the intrusion of the chop or cutlet was often the only result, and his thoughts went on soaring upwards."

For further details about Hamilton (his poetry and his association with poets, for instance) the reader is referred to the *Dublin University Magazine* (Jan. 1842), the *Gentleman's Magazine* (Jan. 1866), and the *Monthly Notices of the Royal Astronomical Society* (Feb. 1866); and also to an article by the present writer in the *North British Review* (Sept. 1866), from which much of the above sketch has been taken. His works have been collected and published by R. P. Graves, *Life of Sir W. R. Hamilton* (3 vols., 1882, 1885, 1889). (P. G. T.)

HAMILTON, a town of Dundas and Normanby counties, Victoria, Australia, on the Grange Burne Creek, 197½ m. by rail W. of Melbourne. Pop. (1901) 4026. Hamilton has a number of educational institutions, chief among which are the Hamilton and Western District College, one of the finest buildings of its kind in Victoria, the Hamilton Academy, and the Alexandra ladies' college, a state school, and a Catholic college. It has a fine racecourse, and pastoral and agricultural exhibitions are held annually, as the surrounding district is mainly devoted to sheep-farming. Mutton is frozen and exported. Hamilton became a borough in 1859.

HAMILTON (GRAND or ASHUANIP), the chief river of Labrador, Canada. It rises in the Labrador highlands at an elevation of 1700 ft., its chief sources being Lakes Attikonak and Ashuanipi, between 65° and 66° W. and 52° and 53° N. After a precipitous course of 600 m. it empties into Melville Lake (90 m. long and 18 wide), an extension of Hamilton inlet, on the Atlantic. About 220 m. from its mouth occur the Grand Falls of Labrador. Here in a distance of 12 m. the river drops 760 ft., culminating in a final vertical fall of 316 ft. Below the falls are violent rapids, and the river sweeps through a deep and narrow canyon. The country through which it passes is for the most part a wilderness of barren rock, full of lakes and lacustrine rivers, many of which are its tributaries. In certain portions of the valley spruce and poplars grow to a moderate size. From the head of Lake Attikonak a steep and rocky portage of less than a mile leads to Burnt Lake, which is drained into the St Lawrence by the Romaine river.

HAMILTON, one of the chief cities of Canada, capital of Wentworth county, Ontario. It occupies a highly picturesque situation upon the shore of a spacious land-locked bay at the western end of Lake Ontario. It covers the plain stretching between the water-front and the escarpment (called "The Mountain"), this latter being a continuation of that over which the Falls of Niagara plunge 40 m. to the west. Founded about 1778 by one Robert Land, the growth of Hamilton has been steady and substantial, and, owing to its remarkable industrial development, it has come to be called "the Birmingham of Canada." This development is largely due to the use of electrical energy generated by water-power, in regard to which Hamilton stands first among Canadian cities. The electricity has not, however, been obtained from Niagara Falls, but from De Cew Falls, 35 m. S.E. of the city. The entire electrical railway system, the lighting of the city, and the majority of the factories are operated by power obtained from this source. The manufacturing interests of Hamilton are varied, and some of the establishments are of vast size, employing many thousands of hands each, such as the International Harvester Co. and the Canadian Westinghouse Co. In addition Hamilton is the centre of one of the finest fruit-growing districts on the continent, and its open-air market is a remarkable sight. The municipal matters are managed by a mayor and board of aldermen. Six steam railroads and three electric radial roads afford Hamilton ample facilities for transport by land, while during the season of navigation

a number of steamboat lines supply daily services to Toronto and other lake ports. Entrance into the broad bay is obtained through a short canal intersecting Burlington Beach, which is crossed by two swing bridges, whereof one—that of the Grand Trunk railway—is among the largest of its kind in the world. Burlington Beach is lined with cottages occupied by the city residents during the hot summer months. Hamilton is rich in public institutions. The educational equipment comprises a normal college, collegiate institute, model school and more than a score of public schools, for the most part housed in handsome stone and brick buildings. There are four hospitals, and the asylum for the insane is the largest in Canada. There is an excellent public library, and in the same building with it a good art school. Hamilton boasts of a number of parks, Dundurn Castle Park, containing several interesting relics of the war of 1812, being the finest, and, as it is practically within the city limits, it is a great boon to the people. Gore Park, in the centre of the city, is used for concerts, given by various bands, one of which has gained an international reputation. Since its incorporation in 1833 the history of Hamilton has shown continuous growth. In 1836 the population was 2846; in 1851, 10,248; in 1861, 19,090; in 1871, 26,880; in 1881, 36,661; in 1891, 48,959; and in 1901, 52,634. The Anglican bishop of Niagara has his seat here, and also a Roman Catholic bishop. Hamilton returns two members to the Provincial parliament and two to the Dominion.

HAMILTON, a municipal and police burgh of Lanarkshire, Scotland. Pop. (1891), 24,859; (1901), 32,775. It is situated about 1 m. from the junction of the Avon with the Clyde, 10½ m. S.E. of Glasgow by road, and has stations on the Caledonian and North British railways. The town hall in the Scottish Baronial style has a clock-tower 130 ft. high, and the county buildings are in the Grecian style. Among the subjects of antiquarian interest are Queenzie Neuk, the spot where Queen Mary rested on her journey to Langside, the old steeple and pillory built in the reign of Charles I., the Mote Hill, the old Runic cross, and the carved gateway in the palace park. In the churchyard there is a monument to four covenanters who suffered at Edinburgh, on the 7th of December 1600, whose heads were buried here. Among the industries are manufactures of cotton, lace and embroidered muslins, and carriage-building, and there are also large market gardens, the district being famed especially for its apples, and some dairy-farming; but the prosperity of the town depends chiefly upon the coal and ironstone of the surrounding country, which is the richest mineral field in Scotland. Hamilton originated in the 15th century under the protecting influence of the lords of Hamilton, and became a burgh of barony in 1456 and a royal burgh in 1548. The latter rights were afterwards surrendered and it was made the chief burgh of the regality and dukedom of Hamilton in 1668, the third marquess having been created duke in 1643. It unites with Airdrie, Falkirk, Lanark and Linlithgow to form the Falkirk district of burghs, which returns one member to parliament.

Immediately east of the town is Hamilton palace, the seat of the duke of Hamilton and Brandon, premier peer of Scotland. It occupies most of the site of the original burgh of Netherton. The first mansion was erected at the end of the 16th century and rebuilt about 1770, to be succeeded in 1822-1829 by the present palace, a magnificent building in the classical style. Its front is a specimen of the enriched Corinthian architecture, with a projecting pillared portico after the style of the temple of Jupiter Stator at Rome, 264 ft. in length and 60 ft. in height. Each of the twelve pillars of the portico is a single block of stone, quarried at Dalserf, midway between Hamilton and Lanark, and required thirty horses to draw it to its site. The interior is richly decorated and once contained the finest collection of paintings in Scotland, but most of them, together with the Hamilton and Beckford libraries, were sold in 1882. Within the grounds, which comprise nearly 1500 acres, is the mausoleum erected by the 10th duke, a structure resembling in general design that of the emperor Hadrian at Rome, being a circular building springing from a square basement, and enclosing a decorated octagonal chapel, the door of which is a copy in bronze of Ghiberti's gates at Florence. At Barncloth, 1 m. S.E. of the town, may be seen the Dutch gardens which were laid down in terraces on the steep banks of the Avon. Their quaint shrubbery and old-fashioned setting render them attractive. They were planned in 1583 by

John Hamilton, an ancestor of Lord Belhaven, and now belong to Lord Ruthven. About 2 m. S.E. of Hamilton, within the western High Park, on the summit of a precipitous rock 200 ft. in height, the foot of which is washed by the Avon, stand the ruins of Cadzow Castle, the subject of a spirited ballad by Sir Walter Scott. The castle had been a royal residence for at least two centuries before Bannockburn (1314), but immediately after the battle Robert Bruce granted it to Sir Walter Fitz-Gilbert Hamilton, the son of the founder of the family, in return for the fealty. Near it is the noble chase with its ancient oaks, the remains of the Caledonian Forest, where are still preserved some of the aboriginal breed of wild cattle. Opposite Cadzow Castle, in the eastern High Park, on the right bank of the Avon, is Chateherault, consisting of stables and offices, and imitating in outline the palace of that name in France.

HAMILTON, a village of Madison county, New York, U.S.A., about 29 m. S.W. of Utica. Pop. (1890), 1744; (1900), 1677; (1905) 1522; (1910) 1689. It is served by the New York, Ontario & Western railway. Hamilton is situated in a productive agricultural region, and has a large trade in hops; among its manufactures are canned vegetables, lumber and knit goods. There are several valuable stone quarries in the vicinity. The village owns and operates its water-supply and electric-lighting system. Hamilton is the seat of Colgate University, which was founded in 1819, under the name of the Hamilton Literary and Theological Institution, as a training school for the Baptist ministry, was chartered as Madison University in 1846, and was renamed in 1890 in honour of the Colgate family, several of whom, especially William (1783-1857), the soap manufacturer, and his sons, James Boorman (1818-1904), and Samuel (1822-1897), were its liberal benefactors. In 1908-1909 it had a university faculty of 33 members, 307 students in the college, 60 in the theological department, and 134 in the preparatory department, and a library of 54,000 volumes, including the Baptist Historical collection (about 5000 vols.) given by Samuel Colgate. The township in which the village is situated and which bears the same name (pop. in 1910, 3825) was settled about 1790 and was separated from the township of Paris in 1795. The village was incorporated in 1812.

HAMILTON, a city and the county-seat of Butler county, Ohio, U.S.A., on both sides of the Great Miami river, 25 m. N. of Cincinnati. Pop. (1890), 17,565; (1900), 23,914, of whom 2949 were foreign-born; (1910 census), 35,279. It is served by the Cincinnati, Hamilton & Dayton, and the Pittsburg, Cincinnati, Chicago & St. Louis railways, and by interurban electric lines connecting with Cincinnati, Dayton and Toledo. The valley in which Hamilton is situated is noted for its fertility. The city has a fine public square and the Lane free library (1866); the court house is its most prominent public building. A hydraulic canal provides the city with good water power, and in 1905, in the value of its factory products (\$13,992,574, being 31.3% more than in 1900), Hamilton ranked tenth among the cities of the state. Its most distinctive manufactures are paper and wood pulp; more valuable are foundry and machine shop products; other manufactures are safes, malt liquors, flour, woollens, Corliss engines, carriages and wagons and agricultural implements. The municipality owns and operates the water-works, electric-lighting plant and gas plant. A stockade fort was built here in 1791 by General Arthur Saint Clair, but it was abandoned in 1796, two years after the place had been laid out as a town and named Fairfield. The town was renamed; in honour of Alexander Hamilton, about 1796. In 1803 Hamilton was made the county-seat; in 1810 it was incorporated as a village; in 1854 it annexed the town of Rossville on the opposite side of the river; and in 1857 it was made a city. In 1908, by the annexation of suburbs, the area and the population of Hamilton were considerably increased. Hamilton was the early home of William Dean Howells, whose recollections of it are to be found in his *A Boy's Town*; his father's anti-slavery sentiments made it necessary for him to sell his printing office, where the son had learned to set type in his teens, and to move to Dayton.

HAMIRPUR, a town and district of British India, in the Allahabad division of the United Provinces. The town stands on a tongue of land near the confluence of the Betwa and Juma,

110 m. N.W. of Allahabad. Pop. (1901), 6721. It was founded, according to tradition, in the 11th century by Hamir Deo, a Karchuli Rajput expelled from Alwar by the Mahomedans.

The district has an area of 2280 sq. m., and encloses the native states of Sarila, Jigni and Bihat, besides portions of Charkhari and Garrauli. Hamirpur forms part of the great plain of Bundelkhand, which stretches from the banks of the Jumna to the central Vindhyan plateau. The district is in shape an irregular parallelogram, with a general slope northward from the low hills on the southern boundary. The scenery is rendered picturesque by the artificial lakes of Mahoba. These magnificent reservoirs were constructed by the Chandel rajas before the Mahomedan conquest, for purposes of irrigation and as sheets of ornamental water. Many of them enclose craggy islets or peninsulas, crowned by the ruins of granite temples, exquisitely carved and decorated. From the base of this hill and lake country the general plain of the district spreads northward in an arid and treeless level towards the broken banks of the rivers. Of these the principal are the Betwa and its tributary the Dhasan, both of which are unnavigable. There is little waste land, except in the ravines by the river sides. The deep black soil of Bundelkhand, known as *madr*, retains the moisture under a dried and rifted surface, and renders the district fertile. The staple produce is grain of various sorts, the most important being gram. Cotton is also a valuable crop. Agriculture suffers much from the spread of the *kans* grass, a noxious weed which overruns the fields and is found to be almost ineradicable wherever it has once obtained a footing. Droughts and famine are unhappily common. The climate is dry and hot, owing to the absence of shade and the bareness of soil, except in the neighbourhood of the Mahoba lakes, which cool and moisten the atmosphere.

In 1901 the pop. was 458,542, showing a decrease of 11% in the decade, due to the famine of 1895-1897. Export trade is chiefly in agricultural produce and cotton cloth. Rath is the principal commercial centre. The Midland branch of the Great Indian Peninsula railway passes through the south of the district.

From the 9th to the 12th century this district was the centre of the Chandel kingdom, with its capital at Mahoba. The rajas adorned the town with many splendid edifices, remains of which still exist, besides constructing the noble artificial lakes already described. At the end of the 12th century Mahoba fell into the hands of the Mussulmans. In 1680 the district was conquered by Chhatar Sal, the hero of the Bundelas, who assigned at his death one-third of his dominions to his ally the peshwa of the Mahrattas. Until Bundelkhand became British territory in 1803 there was constant warfare between the Bundela princes and the Mahratta chieftains. On the outbreak of the Mutiny in 1857, Hamirpur was the scene of a fierce rebellion, and all the principal towns were plundered by the surrounding chiefs. After a short period of desultory guerrilla warfare the rebels were effectually quelled and the work of reorganization began. The district has since been subject to cycles of varying agricultural prosperity.

HAMITIC RACES AND LANGUAGES. The questions involved in a consideration of Hamitic races and Hamitic languages are independent of one another and call for separate treatment.

I. *Hamitic Races.*—The term Hamitic as applied to race is not only extremely vague but has been much abused by anthropological writers. Of the few who have attempted a precise definition the most prominent is Sergi,¹ and his classification may be taken as representing one point of view with regard to this difficult question.

Sergi considers the Hamites, using the term in the racial sense, as a branch of his "Mediterranean Race"; and divides them as follows:—

1. *Eastern Branch*—
 - (a) Ancient and Modern Egyptian (excluding the Arabs).
 - (b) Nubians, Beja.
 - (c) Abyssinians.
 - (d) Galla, Danakil, Somali.

¹ G. Sergi, *The Mediterranean Race. A Study of the Origin of European Peoples* (London, 1901); *idem, Africa, Antropologia della stirpe camitica* (Turin, 1897).

- (e) Masai.
- (f) Wahuma or Watusi.

2. *Northern Branch*—

- (a) Berbers of the Mediterranean, Atlantic and Sahara.
- (b) Tibbu.
- (c) Fula.
- (d) Guanches (extinct).

With regard to this classification the following conclusions may be regarded as comparatively certain: that the members of groups d, e and f of the first branch appear to be closely inter-connected by ties of blood, and also the members of the second branch. The Abyssinians in the south have absorbed a certain amount of Galla blood, but the majority are Semitic or Semito-Negroid. The question of the racial affinities of the Ancient Egyptians and the Beja are still a matter of doubt, and the relation of the two groups to each other is still controversial. Sergi, it is true, arguing from physical data believes that a close connexion exists; but the data are so extremely scanty that the finality of his conclusion may well be doubted. His "Northern Branch" corresponds with the more satisfactory term "Libyan Race," represented in fair purity by the Berbers, and, mixed with Negro elements, by the Fula and Tibbu. This Libyan race is distinctively a white race, with dark curly hair; the Eastern Hamites are equally distinctively a brown people with frizzy hair. If, as Sergi believes, these brown people are themselves a race, and not a cross between white and black in varying proportions, they are found in their greatest purity among the Somali and Galla, and mixed with Bantu blood among the Ba-Hima (Wahuma) and Watusi. The Masai seem to be as much Nilotic Negro as Hamite. This Galla type does not seem to appear farther north than the southern portion of Abyssinia, and it is not unlikely that the Beja are very early Semitic immigrants with an aboriginal Negroid admixture. It is also possible that they and the Ancient Egyptians may contain a common element. The Nubians appear akin to the Egyptians but with a strong Negroid element.

To return to Sergi's two branches, besides the differences in skin colour and hair-texture there is also a cultural difference of great importance. The Eastern Hamites are essentially a pastoral people and therefore nomadic or semi-nomadic; the Berbers, who, as said above, are the purest representatives of the Libyans, are agriculturists. The pastoral habits of the Eastern Hamites are of importance, since they show the utmost reluctance to abandon them. Even the Ba-Hima and Watusi, for long settled and partly intermixed with the agricultural Bantu, regard any pursuit but that of cattle-tending as absolutely beneath their dignity.

It would seem therefore that, while sufficient data have not been collected to decide whether, on the evidence of exact anthropological measurements, the Libyans are connected racially with the Eastern Hamites, the testimony derived from broad "descriptive characteristics" and general culture is against such a connexion. To regard the Libyans as Hamites solely on the ground that the languages spoken by the two groups show affinities would be as rash and might be as false as to aver that the present-day Hungarians are Mongolians because Magyar is an Asiatic tongue. Regarding the present state of knowledge it would be safer therefore to restrict the term "Hamites" to Sergi's first group; and call the second by the name "Libyans." The difficult question of the origin of the ancient Egyptians is discussed elsewhere.

As to the question whether the Hamites in this restricted sense are a definite race or a blend, no discussion can, in view of the paucity of evidence, as yet lead to a satisfactory conclusion, but it might be suggested very tentatively that further researches may possibly connect them with the Dravidian peoples of India. It is sufficient for present purposes that the term Hamite, using it as coextensive with Sergi's Eastern Hamite, has a definite connotation. By the term is meant a brown people with frizzy hair, of lean and sinewy physique, with slender but muscular arms and legs, a thin straight or even arched nose with delicate nostrils, thin lips and no trace of prognathism. (T. A. J.)

II. *Hamitic Languages.*—The whole north of Africa was once inhabited by tribes of the Caucasian race, speaking languages which are now generally called, after Genesis x., Hamitic, a term introduced principally by Friedrich Müller. The linguistic coherence of that race has been broken up especially by the intrusion of Arabs, whose language has exercised a powerful influence on all those nations. This splitting up, and the immense distances over which those tribes were spread, have made those languages diverge more widely than do the various tongues of the Indo-European stock, but still their affinity can easily be traced by the linguist, and is, perhaps, greater than the corresponding anthropologic similarity between the white Libyan, red Galla and swarthy Somali. The relationship of these languages to Semitic has long been noticed, but was at first taken for descent from Semitic (cf. the name "Syro-Arabian" proposed by Prichard). Now linguists are agreed that the

Proto-Semites and Proto-Hamites once formed a unity, probably in Arabia. That original unity has been demonstrated especially by Friedrich Müller (*Reise der österreichischen Fregatte Novara*, p. 51, more fully, *Grundriss der Sprachwissenschaft*, vol. iii, fasc. 2, p. 226), cf. also A. H. Sayce, *Science of Language*, ii, 178, R. N. Cust, *The Modern Languages of Africa*, i, 94, &c. The comparative grammars of Semitic (W. Wright, 1890, and especially H. Zimmern, 1898) demonstrate this now to everybody by comparative tables of the grammatical elements.

The classification of Hamitic languages is as follows:—
1. *The Libyan Dialects* (mostly misnamed "Berber languages," after an unfortunate, vague Arabic designation, *barābra*, "people of foreign language"). The representatives of this large group extend from the Senegal river (where they are called *Zenaga*; imperfect *Grammaire* by L. Faidherbe, 1877) and from Timbuktu (dialect of the Auclimiden, sketched by Heinrich Barth, *Travels*, vol. v., 1857) to the cases of Aujiila (Bengazi) and of Siwa on the western border of Egypt. Consequently, these "dialects" differ more strongly from each other than, e.g. the Semitic languages do between themselves. The purest representative seems to be the language of the Algerian mountaineers (Kabyles), especially that of the Zuawa (Zouaves) tribe, described by A. Hanoteau, *Essai de grammaire kabyle* (1858); Ben Sedira, *Cours de langue kab.* (1887); *Dictionnaire* by Olivier (1878). The learned little *Manuel de langue kabyle*, by R. Basset (1887) is an introduction to the study of the many dialects with full bibliography, cf. also Basset's *Notes de lexicographie berbère* (1883 foll.). (The dictionaries by Brosseletard and Venture de Paradis are imperfect.) The best now described is Shilh(a), a Moroccan dialect (H. Stumme, *Handbuch des Schilhschen*, 1899), but it is an inferior dialect. That of Ghat in Tripoli underlies the *Grammar* of F. W. Newman (1845) and the *Grammaire Tamashek* of Hanoteau (1860); cf. also the *Dictionnaire* of Cid Kaoui (1900). Neither medieval reports on the language spoken by the Guanches of the Canary Islands (fullest in A. Berthelot, *Antiquités canariennes*, 1879; akin to Shilha; by no means primitive Libyan untouched by Arabic), nor the modern dialect of Siwa (still little known; tentative grammar by Basset, 1890), have any hopes of finding a pure Libyan dialect. Of a few literary attempts in Arabic letters the religious *Poème de Gaba* (ed. Basset, *Journ. asiatique*, vii, 476) is the most remarkable. The imperfect native writing (named *tifnaghén*), a derivation from the Sabæan alphabet (not, as Halévy claimed, from the Punic), still in use among the Sahara tribes, can be traced to the 2nd century B.C. (bilingual inscription of Tucca, &c.; cf. J. Halévy, *Essai d'épigraphie libyque*, 1875), but hardly ever served for literary uses.

2. *The Cushitic or Ethiopian Family*.—The nearest relative of Libyan is not Ancient Egyptian but the language of the nomadic Bisharin or Beja of the Nubian Desert (cf. H. Almkvist, *Die Bishari Sprache*, 1881 [the northern dialect], and L. Reinisch, *Die Bedawye Sprache*, 1893, *Wörterbuch*, 1895). The speech of the peoples occupying the lowland east of Abyssinia, the Saho (Reinisch, *grammar in Zeitschrift d. deutschen morgenländ. Gesellschaft*, 32, 1878; *Texte*, 4889; *Wörterbuch*, 1890; cf. also Reinisch, *Die Sprache der Irob Saho*, 1878), and the Afar or Danakil (Reinisch, *Die Afar Sprache*, 1887; G. Colizza, *Lingua Afar*, 1887), merely dialects of one language, form the connecting link with the southern Hamitic group, i.e. Somali (Reinisch, *Somali Sprache*, 1900-1903, 3 vols.; Larajaase und de Sampont, *Practical Grammar of the Somali Language*, 1897; imperfect sketches by Hunter, 1880, and Schleicher, 1890), and Galla (L. Tutschek, *Grammar*, 1845, *Lexicon*, 1844; Massaja, *Lectures*, 1877; G. F. F. Praetorius, *Zur Grammatik der Gallasprache*, 1893, &c.). All these Cushitic languages, extending from Egypt to the equator, are separated by Reinisch as *Lower Cushitic* from the *High Cushitic* group, i.e. the many dialects spoken by tribes dwelling in the Abyssinian highlands or south of Abyssinia. Of the original inhabitants of Abyssinia, called collectively Agäu (or Agäu) by the Abyssinians, or Falashas (this name principally for Jewish tribes), Reinisch considers the Bilin or Bogos tribe as preserving the most archaic dialect (*Die Bilin Sprache*, *Texte*, 1883; *Grammatik*, 1882; *Wörterbuch*, 1887); the same scholar gave sketches of the Khamir (1884) and Quara (1885) dialects. On other dialects, struggling against the spreading Semitic tongues (Tigré, Amharic, &c.), see Conti Rossini, "Appunti sulla lingua Khamra," in *Giorn. sci. orient.* (1905); Waldmeyer, *Wörterammlung* (1868); J. Halévy, "Essai sur la langue Agaou" (*Actes soc. philologique*, 1873), &c. Similar dialects are those of the Sid(d)āna tribes, south of Abyssinia, of which only Kal(t)ā (Reinisch, *Die Kafa Sprache*, 1888) is known at all fully. Of the various other dialects (Kullo, Tambaro, &c.), vocabularies only are known; cf. Borelli, *Ethiopia meridionale* (1890). (On Hausa see below.)

There is no question that the northernmost Hamitic languages have preserved best the original wealth of inflections which reminds us so strongly of the formal riches of southern Semitic. Libyan

and Beja are the best-preserved types, and the latter especially may be called the Sanskrit of Hamitic. The other Cushitic tongues exhibit increasing agglutinative tendencies the farther we go south, although single archaisms are found even in Somali. The early isolated High Cushitic tongues (originally branched off from a stock common with Galla and Somali) diverge most strongly from the original type. Already the Agäu dialects are full of very peculiar developments; the Hamitic character of the Sid(d)āna languages can be traced only by lengthy comparisons.

The simple and pretty (Haus)(s)a language, the commercial language of the whole Niger region and beyond (Schoen, *Grammar*, 1862, *Dictionary*, 1876; Charles H. Robinson, 1897, in Robinson and Brookes's *Dictionary*) has fairly well preserved its Hamitic grammar, though its vocabulary was much influenced by the surrounding Negro languages. It is no relative of Libyan (though it has experienced some Libyan influences), but comes from the (High?) Cushitic family; its exact place in this family remains to be determined. Various languages of the Niger region were once Hamitic like Haus(s)a, or at least under some Hamitic influence, but have now lost that character too far to be classified as Hamitic, e.g. the Muzok or Mugu language (F. Müller, 1886). The often-raised question of some (very remote) relationship between Hamitic and the great Berber family is still undecided; more doubtful is that with the interesting Ful (a) language in the western Sudan, but a relationship with the Nilotic branch of negro languages is impossible (though a few of these, e.g. Nuba, have borrowed some words from neighbouring Hamitic peoples). The development of a grammatical gender, this principal characteristic of Semito-Hamitic, in Bari and Masai, may be rather accidental than borrowed; certainly, the same phenomenon in Hottentot does not justify the attempt often made to classify this with Hamitic.

3. *Ancient Egyptian*, as we have seen, does not form the connecting link between Libyan and Cushitic which its geographical position would lead us to expect. It represents a third independent branch, or rather a second one, Libyan and Cushitic forming one division of Hamitic. A few resemblances with Libyan (M. de Rochemonteix in *Mémoires du congrès international des orientalistes*, Paris, 1873; elementary) are less due to original relationship than to the general better preservation of the northern idioms (see above). Frequent attempts to detach Egyptian from Hamitic and to attribute it to a Semitic immigration later than that of the other Hamites cannot be proved. Egyptian is, in many respects, more remote from Semitic than the Libyan-Cushitic division, being more agglutinative than the latter types of its sister branch, having lost the most characteristic verbal flexion (the Hamito-Semitic imperfect), forming the nominal plural in its own peculiar fashion, &c. The advantage of Egyptian, that it is represented in texts of 3000 B.C., while the sister tongues exist only in forms 5000 years later, allows us, e.g. to trace the Semitic principle of triliteral roots more clearly in Egyptian; but still the latter tongue is hardly more characteristically archaic or nearer Semitic than Beja or Kabylic.

All this is said principally of the grammar. Of the vocabulary it must not be forgotten that none of the Hamitic tongues remained untouched by Semitic influences after the separation of the Hamites and Semites, say 4000 or 6000 B.C. Repeated Semitic immigrations and influences have brought so many layers of loan-words that it is questionable if any modern Hamitic language has now more than 10% of original Hamitic words. Which Semitic resemblances are due to original affinity, which come from pre-Christian immigrations, which from later influences, are difficult questions not yet faced by science; e.g. the half-Arabic numerals of Libyan have often been quoted as a proof of primitive Hamito-Semitic kinship, but they are probably only a gift of some Arab invasion, prehistoric for us. Arab tribes seem to have repeatedly swept over the whole area of the Hamites, long before the time of Mahomet, and to have left deep impressions on races and languages, but none of these migrations stands in the full light of history (not even that of the Geez tribes of Abyssinia). Egyptian exhibits constant influences from its Canaanitic neighbours; it is crammed with such loan-words already in 3000 B.C.; new affluxes can be traced, especially c. 1600. (The Punic influences on Libyan are, however, very slight, inferior to the Latin.) Hence the relations of Semitic and Hamitic still require many investigations in detail, for which the works of Reinisch and Basset have merely built up a basis. (W. M. M.)

HAMLET, the hero of Shakespeare's tragedy, a striking figure in Scandinavian romance.

The chief authority for the legend of Hamlet is Saxo Grammaticus, who devotes to it parts of the third and fourth books of his *Historia Danica*, written at the beginning of the 13th century. It is supposed that the story of Hamlet, Amlæth or AmloS,¹ was contained in the lost Skjöldunga saga, but we have no means of determining whether Saxo derived his information in this case from oral or written sources. The close parallels between the

¹Only works of higher linguistic standing are quoted here; many vocabularies and imperfect attempts of travellers cannot be enumerated.

²The word is used in modern Icelandic metaphorically of an imbecile or weak-minded person (see Cleasby and Vigfússon, *Icelandic-English Dictionary*, 1869).

tale of Hamlet and the English romances of Havelok, Horn and Bevis of Hampton make it not unlikely that Hamlet is of British rather than of Scandinavian origin. His name does in fact occur in the Irish *Annals of the Four Masters* (ed. O'Donovan, 1851) in a stanza attributed to the Irish Queen Gormflaith, who laments the death of her husband, Niall Glundubh, at the hands of Amhlaide in 919 at the battle of Ath-Cliath. The slayer of Niall Glundubh is by other authorities stated to have been Sihtric. Now Sihtric was the father of that Olaf or Anlaf Cuaran who was the prototype of the English Havelok, but nowhere else does he receive the nickname of Amhlaide. If Amhlaide may really be identified with Sihtric, who first went to Dublin in 888, the relations between the tales of Havelok and Hamlet are readily explicable, since nothing was more likely than that the exploits of father and son should be confounded (see HAVELOK). But, whoever the historic Hamlet may have been, it is quite certain that much was added that was extraneous to Scandinavian tradition. Later in the 10th century there is evidence of the existence of an Icelandic saga of Amleth or Amleth in a passage from the poet Snaebjorn in the second part of the prose *Edda*.¹ According to Saxo,² Hamlet's history is briefly as follows. In the days of Rorik, king of Denmark, Gervendill was governor of Jutland, and was succeeded by his sons Horvendill and Feng. Horvendill, on his return from a Viking expedition in which he had slain Koll, king of Norway, married Gerutha, Rorik's daughter, who bore him a son Amleth. But Feng, out of jealousy, murdered Horvendill, and persuaded Gerutha to become his wife, on the plea that he had committed the crime for no other reason than to avenge her of a husband by whom she had been hated. Amleth, afraid of sharing his father's fate, pretended to be imbecile, but the suspicion of Feng put him to various tests which are related in detail. Among other things they sought to entangle him with a young girl, his foster-sister, but his cunning saved him. When, however, Amleth slew the eavesdropper hidden, like Polonius, in his mother's room, and destroyed all trace of the deed, Feng was assured that the young man's madness was feigned. Accordingly he despatched him to England in company with two attendants, who bore a letter enjoining the king of the country to put him to death. Amleth surmised the purport of their instructions, and secretly altered the message on their wooden tablets to the effect that the king should put the attendants to death and give Amleth his daughter in marriage. After marrying the princess Amleth returned at the end of a year to Denmark. Of the wealth he had accumulated he took with him only certain hollow sticks filled with gold. He arrived in time for a funeral feast, held to celebrate his supposed death. During the feast he plied the courtiers with wine, and executed his vengeance during their drunken sleep by fastening down over them the woollen hangings of the hall with pegs he had sharpened during his feigned madness, and then setting fire to the palace. Feng he slew with his own sword. After a long harangue to the people he was proclaimed king. Returning to England for his wife he found that his father-in-law and Feng had been pledged each to avenge the other's death. The English king, unwilling personally to carry out his pledge, sent Amleth as proxy wooer for the hand of a terrible Scottish queen Hermuthruda, who had put all former wooers to death, but fell in love with Amleth. On his return to England his first wife, whose love proved stronger than her resentment, told him of her father's intended revenge. In the battle which followed Amleth won the day by setting up

¹ "Tis said that far out, off yonder ness, the Nine Maids of the Island Mill stir amain the host—cruel skerry-querri—they who in ages past ground Hamlet's meal. The good Chieftain furrows the hull's lair with his ship's beaked prow." This passage may be compared with some examples of Hamlet's cryptic sayings quoted by Saxo: "Again, as he passed along the beach, his companions found the rudder of a ship which had been wrecked, and said they had discovered a huge knife. 'This,' said he, 'was the right thing to carve such a huge ham . . .'. Also, as they passed the sand-hills, and bade him look at the meal, meaning the sand, he replied that it had been ground small by the hoary tempests of the ocean."

² Books iii. and iv., chaps. 86-106, Eng. trans. by O. Elton (London, 1894).

the dead men of the day before with stakes, and thus terrifying the enemy. He then returned with his two wives to Jutland, where he had to encounter the enmity of Wiglek, Rorik's successor. He was slain in a battle against Wiglek, and Hermuthruda, although she had engaged to die with him, married the victor.

The other Scandinavian versions of the tale are: the *Hrolfs saga Kraka*,³ where the brothers Helgi and Hroar take the place of the hero; the tale of Harald and Halfdan, as related in the 9th book of Saxo Grammaticus; the modern Icelandic *Ambales Saga*,⁴ a romantic tale the earliest MS. of which dates from the 17th century; and the folk-tale of Brjám⁵ which was put in writing in 1707. Helgi and Hroar, like Harald and Halfdan, avenge their father's death on their uncle by burning him in his palace. Harald and Halfdan escape after their father's death by being brought up, with dogs' names, in a hollow oak, and subsequently by feigned madness; and in the case of the other brothers there are traces of a similar motive, since the boys are called by dogs' names. The methods of Hamlet's madness, as related by Saxo, seem to point to cynanthropy. In the *Ambales Saga*, which perhaps is collateral to, rather than derived from, Saxo's version, there are, besides romantic additions, some traits which point to an earlier version of the tale.

Saxo Grammaticus was certainly familiar with the Latin historians, and it is most probable that, recognizing the similarity between the northern Hamlet legend and the classical tale of Lucius Junius Brutus as told by Livy, by Valerius Maximus, and by Dionysius of Halicarnassus (with which he was probably acquainted through a Latin epitome), he deliberately added circumstances from the classical story. The incident of the gold-filled sticks could hardly appear fortuitously in both, and a comparison of the harangues of Amleth (Saxo, Book iv.) and of Brutus (Dionysius iv. 77) shows marked similarities. In both tales the usurping uncle is ultimately succeeded by the nephew who has escaped notice during his youth by a feigned madness. But the parts played by the personages who in Shakespeare became Ophelia and Polonius, the method of revenge, and the whole narrative of Amleth's adventure in England, have no parallels in the Latin story.

Dr. O. L. Jiriczek⁶ first pointed out the striking similarities existing between the story of Amleth in Saxo and the other northern versions, and that of Kei Chosro in the *Shahnameh* (Book of the King) of the Persian poet Firdausi. The comparison was carried farther by R. Zenker (*Boeve Amlethus*, pp. 207-268, Berlin and Leipzig, 1904), who even concluded that the northern saga rested on an earlier version of Firdausi's story, in which indeed nearly all the individual elements of the various northern versions are to be found. Further resemblances exist in the *Ambales Saga* with the tales of Bellerophon, of Heracles, and of Servius Tullius. That Oriental tales through Byzantine and Arabian channels did find their way to the west is well known, and there is nothing very surprising in their being attached to a local hero.

The tale of Hamlet's adventures in Britain forms an episode so distinct that it was at one time referred to a separate hero. The traitorous letter, the purport of which is changed by Hermuthruda, occurs in the popular *Dit de l'empereur Constant*,⁷ and in Arabian and Indian tales. Hermuthruda's cruelty to her wooers is common in northern and German mythology, and close

³ Printed in *Fornaldar Sögur Norðrlanda* (vol. i. Copenhagen, 1829), analysed by F. Dettler in *Zeitschr. für deutsches Altertum* (vol. 36, Berlin, 1892).

⁴ Printed with English translation and with other texts germane to the subject by I. Gollancz (*Hamlet in Iceland*, London, 1898).

⁵ Professor I. Gollancz points out (p. lxx.) that Brjám is a variation of the Irish Brian, that the relations between Ireland and the Norsemen were very close, and that, curiously enough, Brian Boróimhe was the hero of that very battle of Clontarf (1014) where the device (which occurs in Havelok and Hamlet) of blinding the enemy by tying the wounded to stakes to represent active soldiers was used.

⁶ "Hamlet in Iran," in *Zeitschrift des Vereins für Volkskunde*, x. (Berlin, 1900).

⁷ See A. B. Gotgh, *The Constance Saga* (Berlin, 1902).

parallels are afforded by Thrytho, the terrible bride of Offa I., who figures in *Beowulf*, and by Brunhilda in the *Nibelungenlied*.

The story of Hamlet was known to the Elizabethans in François de Belleforest's *Histoires tragiques* (1559), and found its supreme expression in Shakespeare's tragedy. That as early as 1587 or 1589 Hamlet had appeared on the English stage is shown by Nash's preface to Greene's *Menaphon*: "He will afford you whole Hamlets, I should say, handfulls of tragical speeches." The Shakespearian Hamlet owes, however, little but the outline of his story to Saxo. In character he is diametrically opposed to his prototype. Amleth's madness was certainly altogether feigned; he prepared his vengeance a year beforehand, and carried it out deliberately and ruthlessly at every point. His riddling speech has little more than an outward similarity to the words of Hamlet, who resembles him, however, in his disconcerting penetration into his enemies' plans. For a discussion of Shakespeare's play and its immediate sources see SHAKESPEARE.

See an appendix to Elton's trans. of Saxo Grammaticus; I. Gollance, *Hamlet in Iceland* (London, 1898); H. L. Ward, *Catalogue of Romances*, under "Havelok," vol. I, pp. 423 seq.; *English Historical Review*, x. (1895); F. Dettler, "Die Hamletsaage," *Zeitschr. f. deut. Alter.* vol. 36 (Berlin, 1892); O. L. Jiriczek, "Die Amlethsaage auf Island," in *Germanistische Abhandlungen*, vol. xii. (Breslau), and "Hamlet in Iran," in *Zeitschr. des Vereins für Volkskunde*, x. (Berlin, 1900); A. Olrik, *Kilderne til Sakses Oldhistorie* (Copenhagen, 2 vols., 1892-1894).

HAMLEY, SIR EDWARD BRUCE (1824-1893), British general and military writer, youngest son of Vice-Admiral William Hamley, was born on the 27th of April 1824 at Bodmin, Cornwall, and entered the Royal Artillery in 1843. He was promoted captain in 1850, and in 1851 went to Gibraltar, where he commenced his literary career by contributing articles to magazines. He served throughout the Crimean campaign as aide-de-camp to Sir Richard Dacres, commanding the artillery, taking part in all the operations with distinction, and becoming successively major and lieutenant-colonel by brevet. He also received the C.B. and French and Turkish orders. During the war he contributed to *Blackwood's Magazine* an admirable account of the progress of the campaign, which was afterwards republished. The combination in Hamley of literary and military ability secured for him in 1859 the professorship of military history at the new Staff College at Sandhurst, from which in 1866 he went to the council of military education, returning in 1870 to the Staff College as commandant. From 1870 to 1881 he was British commissioner successively for the delimitation of the frontiers of Turkey and Bulgaria, Turkey in Asia and Russia, and Turkey and Greece, and was rewarded with the K.C.M.G. Promoted colonel in 1863, he became a lieutenant-general in 1882, when he commanded the 2nd division of the expedition to Egypt under Lord Wolsley, and led his troops in the battle of Tell-el-Kebir, for which he received the K.C.B., the thanks of parliament, and 2nd class of Osmanieh. Hamley considered that his services in Egypt had been insufficiently recognized in Lord Wolsley's despatches, and expressed his indignation freely, but he had no sufficient ground for supposing that there was any intention to belittle his services. From 1885 until his death on the 12th of August 1893 he represented Birkenhead in parliament in the Conservative interest.

Hamley was a clever and versatile writer. His principal work, *The Operations of War*, published in 1867, became a text-book of military instruction. He published some pamphlets on national defence, was a frequent contributor to magazines, and the author of several novels, of which perhaps the best known is *Lady Lee's Widowhood*.

HAMLIN, HANNIBAL (1809-1891), vice-president of the United States (1861-1865), was born at Paris, Maine, on the 27th of August 1809. After studying in Hebron Academy, he conducted his father's farm for a time, became schoolmaster, and later managed a weekly newspaper at Paris. He then studied law, was admitted to the bar in 1833, and rapidly acquired a reputation as an able lawyer and a good public speaker. Entering politics as an anti-slavery Democrat, he was a member

of the state House of Representatives in 1836-1840, serving as its presiding officer during the last four years. He was a representative in Congress from 1843 to 1847, and was a member of the United States Senate from 1848 to 1856. From the very beginning of his service in Congress he was prominent as an opponent of the extension of slavery; he was a conspicuous supporter of the Wilmot Proviso, spoke against the Compromise Measures of 1850, and in 1856, chiefly because of the passage in 1854 of the Kansas-Nebraska Bill, which repealed the Missouri Compromise, and his party's endorsement of that repeal at the Cincinnati Convention two years later, he withdrew from the Democrats and joined the newly organized Republican party. The Republicans of Maine nominated him for governor in the same year, and having carried the election by a large majority he was inaugurated in this office on the 8th of January 1857. In the latter part of February, however, he resigned the governorship, and was again a member of the Senate from 1857 to January 1861. From 1861 to 1865, during the Civil War, he was Vice-President of the United States. While in this office he was one of the chief advisers of President Lincoln, and urged both the Emancipation Proclamation and the arming of the negroes. After the war he again served in the Senate (1869-1881), was minister to Spain (1881-1883), and then retired from public life. He died at Bangor, Maine, on the 4th of July 1891.

See *Life and Times of Hannibal Hamlin* (Cambridge, Mass., 1899), by C. E. Hamlin, his grandson.

HAMM, a town of Germany, in the Prussian province of Westphalia, on the Lippe, 19 m. by rail N.E. from Dortmund on the main line Cologne-Hanover. Pop. (1905) 38,430. It is surrounded by pleasant promenades occupying the site of the former engirdling fortifications. The principal buildings are four Roman Catholic and three Evangelical churches, several schools and an infirmary. The town is flourishing and rapidly increasing, and possesses very extensive wire factories (in connexion with which there are puddling and rolling works), machine works, and manufactories of gloves, baskets, leather, starch, chemicals, varnish, oil and beer. Near the town are some thermal baths.

Hamm, which became a town about the end of the 12th century, was originally the capital of the countship of Mark, and was fortified in 1226. It became a member of the Hanseatic League. In 1614 it was besieged by the Dutch, and it was several times taken and retaken during the Thirty Years' War. In 1666 it came into the possession of Brandenburg. In 1761 and 1762 it was bombarded by the French, and in 1763 its fortifications were dismantled.

HAMMĀD AR-RĀWIYA [Abū-l-Qāsim Hammād ibn Abī Laila Sāpūr (or ibn Maisara)] (8th century A.D.), Arabic scholar, was of Dailamite descent, but was born in Kufa. The date of his birth is given by some as 694, by others as 714. He was reputed to be the most learned man of his time in regard to the "days of the Arabs" (i.e. their chief battles), their stories, poems, genealogies and dialects. He is said to have boasted that he could recite a hundred long *qasidas* for each letter of the alphabet (i.e. rhyming in each letter) and these all from pre-Islamic times, apart from shorter pieces and later verses. Hence his name *Hammad ar-Rawiya*, "the reciter of verses from memory." The Omayyad caliph Walid is said to have tested him, the result being that he recited 3000 *qasidas* of pre-Islamic date and Walid gave him 100,000 dirhems. He was favoured by Yazid II. and his successor Hishām, who brought him up from Irak to Damascus. Arabian critics, however, say that in spite of his learning he lacked a true insight into the genius of the Arabic language, and that he made more than thirty—some say three hundred—mistakes of pronunciation in reciting the Koran. To him is ascribed the collecting of the *Mo'allakat* (q.v.). No diwan of his is extant, though he composed verse of his own and probably a good deal of what he ascribed to earlier poets.

Biography in McG. de Siane's trans. of Ibn Khallikān, vol. I, pp. 470-474, and many stories are told of him in the *Kutub ul-Aghani*, vol. v. pp. 164-175. (C. W. J.)

HAMMER, FRIEDRICH JULIUS (1810-1862), German poet, was born on the 7th of June 1810 at Dresden. In 1831 he went to Leipzig to study law, but devoted himself mainly to philosophy and belles lettres. Returning to Dresden in 1834 a small comedy, *Das seltsame Frühstück*, introduced him to the literary society of the capital, notably to Ludwig Tieck, and from this time he devoted himself entirely to writing. In 1837 he returned to Leipzig, and, coming again to Dresden, from 1851 to 1859 edited the feuilleton of *Sächsische konstitutionelle Zeitung*, and took the lead in the foundation in 1855 of the Schiller Institute in Dresden. His marriage in 1851 had made him independent, and he bought a small property at Pillnitz, on which, soon after his return from a residence of several years at Nuremberg, he died, on the 23rd of August 1862.

Hammer wrote, besides several comedies, a drama *Die Brüder* (1856), a number of unimportant romances, and the novel *Einkehr und Umkehr* (Leipzig, 1856); but his reputation rests upon his epigrammatic and didactic poems. His *Schau' um dich, und schau' in dich* (1851), which made his name, has passed through more than thirty editions. It was followed by *Zu allen guten Stunden* (1854), *Fester Grund* (1857), *Auf stillen Wegen* (1859), and *Lerne, liebe, lebe* (1862). Besides these he wrote a book of Turkish songs, *Unter dem Halbmond* (Leipzig, 1860), and rhymed versions of the psalms (1861), and compiled the popular religious anthology *Leben und Heimat in Gott*, of which a 14th edition was published in 1900.

See C. G. E. Am Ende, *Julius Hammer* (Nuremberg, 1872).

HAMMER, an implement consisting of a shaft or handle with head fixed transversely to it. The head, usually of metal, has one flat face, the other may be shaped to serve various purposes, e.g. with a claw, a pick, &c. The implement is used for breaking, beating, driving nails, rivets, &c., and the word is applied to heavy masses of metal moved by machinery, and used for similar purposes. (See TOOL.) "Hammer" is a word common to Teutonic languages. It appears in the same form in German and Danish, and in Dutch as *hamer*, in Swedish as *hammare*. The ultimate origin is unknown. It has been connected with the root seen in the Greek *καμάρω*, to bend; the word would mean, therefore, something crooked or bent. A more illuminating suggestion connects the word with the Slavonic *hamy*, a stone, cf. Russian *hamen*, and ultimately with Sanskrit *acman*, a pointed stone, a thunderbolt. The legend of Thor's hammer, the thunderbolt, and the probability of the primitive hammer being a stone, adds plausibility to this derivation. The word is applied to many objects resembling a hammer in shape or function. Thus the "striker" in a clock, or in a bell, when it is sounded by an independent lever and not by the swinging of the "tongue," is called a "hammer"; similarly, in the "action" of a pianoforte the word is used of a wooden shank with felt-covered head attached to a key, the striking of which throws the "hammer" against the strings. In the mechanism of a fire-arm, the "hammer" is that part which by its impact on the cap or primer explodes the charge. (See GUN.) The hammer, more usually known by its French name of *martel de fer*, was a medieval hand-weapon. With a long shaft it was used by infantry, especially when acting against mounted troops. With a short handle and usually made altogether of metal, it was also used by horse-soldiers. The *martel* had one part of the head with a blunted face, the other pointed, but occasionally both sides were pointed. There are 16th century examples in which a hand-gun forms the handle. The name of "hammer," in Latin *malleus*, has been frequently applied to men, and also to books, with reference to destructive power. Thus on the tomb of Edward I. in Westminster Abbey is inscribed his name of *Scotorum Malleus*, the "Hammer of the Scots." The title of "Hammer of Heretics," *Malleus Hæreticorum*, has been given to St Augustine and to Johann Faber, whose tract against Luther is also known by the name. Thomas Cromwell was styled *Malleus Monachorum*. The famous text-book of procedure in cases of witchcraft, published by Sprenger and Krämer in 1489, was called *Hexenhammer* or *Malleus Maleficarum* (see WITCHCRAFT).

The origin of the word "hammer-cloth," an ornamental cloth covering the box-seat on a state-coach, has been often explained from the hammer and other tools carried in the box-seat by the coachman for repairs, &c. The *New English Dictionary* points out that while the word occurs as early as 1465, the use of a box-seat is not known before the 17th century. Other suggestions are that it is a corruption of "hamper-cloth," or of "hammock-cloth," which is used in this sense, probably owing to a mistake. Neither of these supposed corruptions helps very much. Skeat connects the word with a Dutch word *hemel*, meaning a canopy. In the name of the bird, the yellow-hammer, the latter part should be "ammer." This appears in the German name, *Emmerling*, and the word probably means the "chirper," cf. the Ger. *jammern*, to wail, lament.

HAMMERBEAM ROOF, in architecture, the name given to a Gothic open timber roof, of which the finest example is that over Westminster Hall (1395-1399). In order to give greater height in the centre, the ordinary tie beam is cut through, and the portions remaining, known as hammerbeams, are supported by curved braces from the wall; in Westminster Hall, in order to give greater strength to the framing, a large arched piece of timber is carried across the hall, rising from the bottom of the wall piece to the centre of the collar beam, the latter being also supported by curved braces rising from the end of the hammer-beam. The span of Westminster Hall is 68 ft. 4 in., and the opening between the ends of the hammerbeams 25 ft. 6 in. The height from the paving of the hall to the hammerbeam is 40 ft., and to the underside of the collar beam 63 ft. 6 in., so that an additional height in the centre of 23 ft. 6 in. has been gained. Other important examples of hammerbeam roofs exist over the halls of Hampton Court and Eltham palaces, and there are numerous examples of smaller dimensions in churches throughout England and particularly in the eastern counties. The ends of the hammerbeams are usually decorated with winged angels holding shields; the curved braces and beams are richly moulded, and the spandrels in the larger examples filled in with tracery, as in Westminster Hall. Sometimes, but rarely, the collar beam is similarly treated, or cut through and supported by additional curved braces, as in the hall of the Middle Temple, London.

HAMMERFEST, the most northern town in Europe. Pop. (1900) 2300. It is situated on an island (Kvalø) off the N.W. coast of Norway, in Finmarken amt (county), in 70° 40' 11" N., the latitude being that of the extreme north of Alaska. Its position affords the best illustration of the warm climatic influence of the north-eastward Atlantic drift, the mean annual temperature being 36° F. (January 31°, July 57°). Hammerfest is 674 m. by sea N.E. of Trondhjem, and 78 S.W. from the North Cape. The character of this coast differs from the southern, the islands being fewer and larger, and of table shape. The narrow strait Strømmen separates Kvalø from the larger Seiland, whose snow-covered hills with several glaciers rise above 3500 ft., while an insular rampart of mountains, Sorø, protects the strait and harbour from the open sea. The town is timber-built and modern; and the Protestant church, town-hall, and schools were all rebuilt after fire in 1890. There is also a Roman Catholic church. The sun does not set at Hammerfest from the 13th of May to the 29th of July. This is the busy season of the townsfolk. Vessels set out to the fisheries, as far as Spitsbergen and the Kara Sea; and trade is brisk, not only Norwegian and Danish but British, German and particularly Russian vessels engaging in it. Cod-liver oil and salted fish are exported with some reindeer-skins, fox-skins and eiderdown; and coal and salt for curing are imported. In the spring the great herds of tame reindeer are driven out to swim Strømmen and graze in the summer pastures of Seiland; towards winter they are called home again. From the 18th of November to the 23rd of January the sun is not seen, and the enforced quiet of winter prevails. Electric light was introduced in the town in 1891. On the Fuglænes or Birds' Cape, which protects the harbour on the north, there stands a column with an inscription in Norse and Latin, stating that Hammerfest was one of the stations of the

expedition for the measurement of the arc of the meridian in 1816-1852. Nor is this its only association with science; for it was one of the spots chosen by Sir Edward Sabine for his series of pendulum experiments in 1823. The ascent of the Sadien or the Tyven in the neighbourhood is usually undertaken by travellers for the view of the barren, snow-clad Arctic landscape, the bluff indented coast, and the vast expanse of the Arctic Ocean.

HAMMER-KOP, or **HAMMERHEAD**, an African bird, which has been regarded as a stork and as a heron, the *Scopus umbretta* of ornithologists, called the "Umbre" by T. Pennant, now placed in a separate family *Scopidae* between the herons and storks. It was discovered by M. Adanson, the French traveller, in Senegal about the middle of the 19th century, and was described by M. J. Brisson in 1760. It has since been found to inhabit nearly the whole of Africa and Madagascar, and is the "hammerkop" (hammerhead) of the Cape colonists. Though not larger than a raven, it builds an enormous nest, some six feet in diameter, with a flat-topped roof and a small hole for entrance and exit, and placed either on a tree or a rocky ledge. The bird, of an almost uniform brown colour, slightly glossed with purple and its tail barred with black, has a long occipital crest, generally borne horizontally, so as to give rise to its common name. It is somewhat sluggish by day, but displays much activity at dusk, when it will go through a series of strange performances. (A. N.)

HAMMER-PURGSTALL, **JOSEPH**, **FREIHERR VON** (1774-1856), Austrian orientalist, was born at Graz on the 9th of June 1774, the son of Joseph Johann von Hammer, and received his early education mainly in Vienna. Entering the diplomatic service in 1796, he was appointed in 1799 to a position in the Austrian embassy in Constantinople, and in this capacity he took part in the expedition under Admiral Sir William Sidney Smith and General Sir John Hely Hutchinson against the French. In 1807 he returned home from the East, after which he was made a privy councillor, and, on inheriting in 1835 the estates of the countess Purgstall in Styria, was given the title of "freiherr." In 1847 he was elected president of the newly-founded academy, and he died at Vienna on the 23rd of November 1856.

For fifty years Hammer-Purgstall wrote incessantly on the most diverse subjects and published numerous texts and translations of Arabic, Persian and Turkish authors. It was natural that a scholar who traversed so large a field should lay himself open to the criticism of specialists, and he was severely handled by Friedrich Christian Diez (1794-1876), who, in his *Unfug und Brflug* (1815), devoted to him nearly 600 pages of abuse. Von Hammer-Purgstall did for Germany the same work that Sir William Jones (q.v.) did for England and Silvestre de Sacy for France. He was, like his younger but greater English contemporary, Edward William Lane, with whom he came into friendly conflict on the subject of the origin of *The Thousand and One Nights*, an assiduous worker, and in spite of many faults did more for oriental studies than most of his critics put together.

Von Hammer's principal work is his *Geschichte des osmanischen Reiches* (10 vols., Pesth, 1827-1835). Another edition of this was published at Pesth in 1834-1835, and it has been translated into French by J. J. Hellert (1835-1843). Among his other works are *Constantinople und der Bosphoros* (1822); *Sur les origines russes* (St Petersburg, 1825); *Geschichte der osmanischen Dichtkunst* (1836); *Geschichte der Goldenen Horde in Kiptschak* (1840); *Geschichte der Chané der Krim* (1856); and an unfinished *Literaturgeschichte der Araber* (1850-1856). His *Geschichte der Assassinen* (1818) has been translated into English by O. C. Wood (1835). Texts and translations—*Eh-Thadabi*, Arab. and Ger. (1829); *Idn Wahshiyah, History of the Mongols*, Arab. and Eng. (1806); *El-Wassdyf*, Pers. and Ger. (1856); *Esch-Schebistami's Rosenkrohn des Geheimnisses*, Pers. and Ger. (1838); *Es-Zamakhsheri, Goldene Halsbänder*, Arab. and Germ. (1835); *El-Ghazzalt, Hujjel-el-Isldm*, Arab. and Ger. (1838); *El-Hamawi, Das arab. Hoho Lied der Liebe*, Arab. and Ger. (1854). Translations of—*El-Muwacbbi's Poems; Er-Rasmi's Account of his Embassy* (1809); *Comtes inditis des 1001 nuits* (1828). Besides these and smaller works, von Hammer contributed numerous essays and criticisms to the *Fundgruben der Orientis*, which he edited; to the *Journal asiatique*; and to many other learned journals; above all to the *Transactions* of the "Akademie der Wissenschaften" of Vienna, of which he was mainly the

founder; and he translated Evliya Effendi's *Travels in Europe*, for the English Oriental Translation Fund. For a fuller list of his works, which amount in all to nearly 100 volumes, see *Comptes rendus* of the Acad. des Inscr. et des Belles-Lettres (1857). See also Schlottman, *Joseph von Hammer-Purgstall* (Zurich, 1857).

HAMMERSMITH, a western metropolitan borough of London, England, bounded E. by Kensington and S. by Fulham and the river Thames, and extending N. and W. to the boundary of the county of London. Pop. (1901) 112,239. The name appears in the early forms of *Hermodewode* and *Hammersmith*; the derivation is probably from the Anglo-Saxon, signifying the place with a haven (*hythe*). Hammersmith is mentioned with Fulham as a winter camp of Danish invaders in 879, when they occupied the island of Hame, which may be identified with Chiswick Eyot. Hammersmith consists of residential streets of various classes. There are many good houses in the districts of Brook Green in the south-east, and Ravenscourt Park and Starch Green in the west. Shepherd's Bush in the east is a populous and poorer quarter. Boat-building yards, lead-mills, oil mills, distilleries, coach factories, motor works, and other industrial establishments are found along the river and elsewhere in the borough. The main thoroughfares are Uxbridge Road and Goldhawk Road, from Acton on the west, converging at Shepherd's Bush and continuing towards Notting Hill; King Street from Chiswick on the south-west, continued as Hammersmith Broadway and Road to Kensington Road; Bridge Road from Hammersmith Bridge over the Thames, and Fulham Palace Road from Fulham, converging at the Broadway. Old Hammersmith Bridge, designed by Tierney Clark (1824), was the earliest suspension bridge erected near London. This bridge was found insecure and replaced in 1884-1887. Until 1834 Hammersmith formed part of Fulham parish. Its church of St Paul was built as a chapel of ease to Fulham, and consecrated by Laud in 1631. The existing building dates from 1890. Among the old monuments preserved is that of Sir Nicholas Crispe (d. 1665), a prominent royalist during the civil wars and a benefactor of the parish. Schools and religious houses are numerous. St Paul's school is one of the principal public schools in England. It was founded in or about 1509 by John Colet, dean of St Paul's, under the shadow of the cathedral church. But it appears that Colet actually refounded and reorganized a school which had been attached to the cathedral of St Paul from very early times; the first mention of such a school dates from the early part of the 12th century (see an article in *The Times*, London, July 7, 1909, on the occasion of the celebration of the quatercentenary of Colet's foundation). The school was moved to its present site in Hammersmith Road in 1883. The number of foundation scholars, that is, the number for which Colet's endowment provided, is 153, according to the number of fishes taken in the miraculous draught. The total number of pupils is about 600. The school governors are appointed by the Mercers' Company (by which body the new site was acquired), and the universities of Oxford, Cambridge and London. Close to the school is St Paul's preparatory school, and at Brook Green is a girls' school in connexion with the main school. There are, besides, the Edward Latymer foundation school for boys (1624), part of the income of which is devoted to general charitable purposes; the Godolphin school, founded in the 16th century and remodelled as a grammar school in 1861; Nazareth House of Little Sisters of the Poor, the Convent of the Sacred Heart, and other convents. The town hall, the West London hospital with its post-graduate college, and Wormwood Scrubbs prison are noteworthy buildings. Other institutions are the Hammersmith school of art and a Roman Catholic training college. Besides the picturesque Ravenscourt Park (31 acres) there are extensive recreation grounds in the north of the borough at Wormwood Scrubbs (193 acres), and others of lesser extent. An important place of entertainment is Olympia, near Hammersmith Road and the Addison Road station on the West London railway, which includes a vast arena under a glass roof; while at Shepherd's Bush are the extensive grounds and buildings first occupied by the Franco-British Exhibition of 1908, including

a huge stadium for athletic displays. In the extreme north of the borough is the Kensal Green Roman Catholic cemetery, in which Cardinal Manning and many other prominent members of this faith are buried. In the neighbourhood of the Mall, bordering the river, are the house where Thomson wrote his poem "The Seasons," and Kelmiscott House, the residence of William Morris. The parliamentary borough of Hammersmith returns one member. The borough council consists of a mayor, 5 aldermen, and 30 councillors. Area, 2,286.3 acres.

HAMMER-THROWING, a branch of field athletics which consists of hurling to the greatest possible distance an instrument with a heavy head and slender handle called the hammer. Throwing the hammer is in all probability of Keltic origin, as it has been popular in Ireland and Scotland for many centuries. The missile was, however, not a hammer, but the wheel of a chariot attached to a fixed axle, by which it was whirled round the head and cast for distance. Such a sport was undoubtedly cultivated in the old Irish games, a large stone being substituted for the wheel at the beginning of the Christian era. In the Scottish highlands the missile took the form of a smith's sledge-hammer, and in this form the sport became popular in England in early days. Edward II. is said to have fostered it, and Henry VIII. is known to have been proficient. At the beginning of the 19th century two standard hammers were generally recognized in Scotland, the heavy hammer, weighing about 21 lb, and the light hammer, weighing about 16 lb. These were in general use until about 1885, although the light hammer gradually attained popularity at the expense of the heavy. Although originally an ordinary blacksmith's sledge with a handle about 3 ft. long, the form of the head was gradually modified until it acquired its present spherical shape, and the stiff wooden handle gave place to one of flexible whalebone about $\frac{3}{4}$ in. in diameter. The Scottish style of throwing, which also obtained in America, was to stand on a mark, swing the hammer round the head several times and hurl it backwards over the shoulder, the length being measured from the mark made by the falling hammer to the nearest foot of the thrower, no run or follow being allowed. Such men as Donald Dinnie, G. Davidson and Kenneth McRae threw the light hammer over 120 ft., and Dinnie's record was 132 ft. 8 in., made, however, from a raised mount. Meanwhile the English Amateur Athletic Association had early fixed the weight of the hammer at 16 lb, but the length of the handle and the run varied widely, the restrictions being few. Under these conditions S. S. Brown, of Oxford, made in 1873 a throw of 120 ft., which was considered extraordinary at the time. In 1875 the throw was made from a 7-ft. circle without run, head and handle of the missile weighing together exactly 16 lb. In 1887 the circle was enlarged to 9 ft., and in 1896 a handle of flexible metal was legalized. The throw was made after a few rapid revolutions of the body, which added an impetus that greatly added to the distance attained. It thus happened that the Scottish competitors at the English games, who clung to their standing style of throwing, were, although athletes of the very first class, repeatedly beaten; the result being that the Scottish association was forced to introduce the English rules. This was also the case in America, where the throw from the 7-ft. circle, any motions being allowed within it, was adopted in 1888, and still obtains. The Americans still further modified the handle, which now consists of steel wire with two skeleton loops for the hands, the wire being joined to the head by means of a ball-bearing swivel. Thus the greatest mechanical advantage, that of having the entire weight of the missile at the end, as well as the least friction, is obtained. In England the Amateur Athletic Association in 1908 enacted that "the head and handle may be of any size, shape and material, provided that the complete implement shall not be more than 4 ft. and its weight not less than 16 lb. The competitor may assume any position he chooses, and use either one or both hands. All throws shall be made from a circle 7 ft. in diameter." The modern hammer-thrower, if right-handed, begins by placing the head on the ground at his right side. He then lifts and swings it round his head with increasing rapidity, his whole

body finally revolving with outstretched arms twice, in some cases three times, as rapidly as possible, the hammer being released in the desired direction. During the "spinning," or revolving of the body, the athlete must be constantly, "ahead of the hammer," i.e. he must be drawing it after him with continually increased pressure up to the very moment of delivery. The muscles chiefly called into play are those of the shoulders, back and loins. The adoption of the hand-loops has given the thrower greater control over the hammer and has thus rendered the sport much less dangerous than it once was.

With a wooden handle the longest throw made in Great Britain from a 9-ft. circle was that of W. J. M. Barry in 1892, who won the championship in that year with 133 ft. 3 in. With the flexible handle, "unlimited run and follow" being permitted, the record was held in 1909 by M. J. McGrath with 175 ft. 8 in., made in 1907; a Scottish amateur, T. K. Nicholson, held the British record of 169 ft. 8 in. The world's record for throw from a 7-ft. circle was 172 ft. 11 in. by J. Flanagan in 1904 in America; the British record from 9-ft. circle being also held by Flanagan with a throw of 163 ft. 1 in. made in 1900. Flanagan's Olympic record (London, 1908) was 170 ft. 4 in. See *Athletics* in the Badminton library; *Athletes' Guide* in Spalding's Athletic library; "Hammer-Throwing" in vol. xx. of *Oxling*.

HAMMER-TOE, a painful condition in which a toe is rigidly bent and the salient angle on its upper aspect is constantly irritated by the boot. It is treated surgically, not as formerly by amputation of the toe, but the toe is made permanently to lie flat by the simple excision of the small digital joint. Even in extremely bad cases of hammer-toe the operation of resection of the head of the metatarsal phalanx is to be recommended rather than amputation.

HAMMOCK, a bed or couch slung from each end. The word is said to have been derived from the hammack tree, the bark of which was used by the aboriginal natives of Brazil to form the nets, suspended from trees, in which they slept. The hammock may be of matting, skin or textiles, lined with cushions or filled with bedding. It is much used in hot climates.

HAMMOND, HENRY (1605-1660), English divine, was born at Chertsey in Surrey on the 18th of August 1605. He was educated at Eton and at Magdalen College, Oxford, becoming demy or scholar in 1619, and fellow in 1625. He took orders in 1629, and in 1633 in preaching before the court so won the approval of the earl of Leicester that he presented him to the living of Penshurst in Kent. In 1643 he was made archdeacon of Chichester. He was a member of the convocation of 1640, and was nominated one of the Westminster Assembly of divines. Instead of sitting at Westminster he took part in the unsuccessful rising at Tunbridge in favour of King Charles I., and was obliged to flee in disguise to Oxford, then the royal headquarters. There he spent much of his time in writing, though he accompanied the king's commissioners to London, and afterwards to the ineffectual convention at Uxbridge in 1645, where he disputed with Richard Vines, one of the parliamentary envoys. In his absence he was appointed canon of Christ Church and public orator of the university. These dignities he relinquished for a time in order to attend the king as chaplain during his captivity in the hands of the parliament. When Charles was deprived of all his loyal attendants at Christmas 1647, Hammond returned to Oxford and was made subdean of Christ Church, only, however, to be removed from all his offices by the parliamentary visitors, who imprisoned him for ten weeks. Afterwards he was permitted, though still under quasi-confinement, to retire to the house of Philip Warwick at Clapham in Bedfordshire. In 1650, having regained his full liberty, Hammond betook himself to the friendly mansion of Sir John Pakington, at Westwood, in Worcestershire, where he died on the 25th of April 1660, just on the eve of his preferment to the see of Worcester. Hammond was held in high esteem even by his opponents. He was handsome in person and benevolent in disposition. He was an excellent preacher; Charles I. pronounced him the most natural orator he had ever heard. His range of reading was extensive, and he was a most diligent scholar and writer.

His writings, published in 4 vols. fol. (1674-1684), consist for the most part of controversial sermons and tracts. The *Anglo-Catholic*

Library contains four volumes of his *Miscellaneous Theological Works* (1847-1850). The best of them are his *Practical Catechism*, first published in 1644; his *Paraphrase and Annotations on the New Testament*; and an incomplete work of a similar nature on the Old Testament. His *Life*, a delightful piece of biography, written by Bishop Fell, and prefixed to the collected *Works*, has been reprinted in vol. iv. of Wordsworth's *Ecclesiastical Biography*. See also *Life of Henry Hammond*, by G. G. Perry.

HAMMOND, a city of Lake county, Indiana, U.S.A., about 18 m. S.E. of the business centre of Chicago, on the Grand Calumet river. Pop. (1890), 5428; (1900) 12,376, of whom 3156 were foreign-born; (1910, census) 20,925. It is served by no fewer than eight railways approaching Chicago from the east, and by several belt lines. As far as its industries are concerned, it is a part of Chicago, to which fact it owes its rapid growth and its extensive manufacturing establishments, which include slaughtering and packing houses, iron and steel works, chemical works, piano, wagon and carriage factories, printing establishments, flour and starch mills, glue works, breweries and distilleries. In 1900 Hammond was the principal slaughtering and meat-packing centre of the state, but subsequently a large establishment removed from the city, and Hammond's total factory product (all industries) decreased from \$25,070,551 in 1900 to \$7,671,203 in 1905; after 1905 there was renewed growth in the city's manufacturing interests. It has a good water-supply system which is owned by the city. Hammond was first settled about 1868, was named in honour of Abram A. Hammond (acting governor of the state in 1860-1861) and was chartered as a city in 1883.

HAMON, JEAN LOUIS (1821-1874), French painter, was born at Plouha on the 5th of May 1821. At an early age he was intended for the priesthood, and placed under the care of the brothers Lamennais, but his strong desire to become a painter finally triumphed over family opposition, and in 1840 he courageously left Plouha for Paris—his sole resources being a pension of five hundred francs, granted him for one year only by the municipality of his native town. At Paris Hamon received valuable counsels and encouragement from Delaroche and Gleyre, and in 1848 he made his appearance at the Salon with "Le Tombeau du Christ" (Musée de Marseille), and a decorative work, "Dessus de Porte." The works which he exhibited in 1849—"Une Affiche romaine," "L'Égalité au sérail," and "Perroquet jasant avec deux jeunes filles"—obtained no marked success. Hamon was therefore content to accept a place in the manufactory of Sévres, but an enamelled casket by his hand having attracted notice at the London International Exhibition of 1851, he received a medal, and, re-inspired by success, left his post to try his chances again at the Salon of 1852. "La Comédie humaine," which he then exhibited, turned the tide of his fortune, and "Ma sœur n'y est pas" (purchased by the emperor) obtained for its author a third-class medal in 1853. At the Paris International Exhibition of 1855, when Hamon re-exhibited the casket of 1851, together with several vases and pictures of which "L'Amour et son troupeau," "Ce n'est pas moi," and "Une Gardeuse d'enfants" were the chief, he received a medal of the second class, and the ribbon of the legion of honour. In the following year he was absent in the East, but in 1857 he reappeared with "Boutique à quatre sous," "Papillon enchaîné," "Cantharide esclave," "Dévideuses," &c., in all ten pictures; "L'Amour en visite" was contributed to the Salon of 1859, and "Vierge de Lesbos," "Tutelle," "La Volière," "L'Escamoteur" and "La Sœur aînée" were all seen in 1861. Hamon now spent some time in Italy, chiefly at Capri, whence in 1864 he sent to Paris "L'Aurore" and "Un Jour de fiançailles." The influence of Italy was also evident in "Les Muses à Pompéi," his sole contribution to the Salon of 1866, a work which enjoyed great popularity and was re-exhibited at the International Exhibition of 1867, together with "La Promenade" and six other pictures of previous years. His last work, "Le Triste Rivage," appeared at the Salon of 1873. It was painted at St Raphael, where Hamon had finally settled in a little house on the shores of the Mediterranean, close by Alphonse Karr's famous garden. In this house he died on the 29th of May 1874.

HAMPDEN, HENRY BOUVERIE WILLIAM BRAND, 1ST VISCOUNT¹ (1812-1892), speaker of the House of Commons, was the second son of the 21st Baron Dacre, and descended from John Hampden, the patriot, in the female line; the barony of Dacre devolved on him in 1890, after he had been created Viscount Hampden in 1884. He entered parliament as a Liberal in 1852, and for some time was chief whip of his party. In 1872 he was elected speaker, and retained this post till February 1884. It fell to him to deal with the systematic obstruction of the Irish Nationalist party, and his speakership is memorable for his action on the 2nd of February 1881 in refusing further debate on W. E. Forster's Coercion Bill—a step which led to the formal introduction of the closure into parliamentary procedure. He died on the 14th of March 1892, being succeeded as 2nd viscount by his son (b. 1841), who was governor of New South Wales, 1895-1899.

HAMPDEN, JOHN (c. 1595-1643), English statesman, the eldest son of William Hampden, of Great Hampden in Buckinghamshire, a descendant of a very ancient family of that place, said to have been established there before the Conquest, and of Elizabeth, second daughter of Sir Henry Cromwell, and aunt of Oliver, the future protector, was born about the year 1595. By his father's death, when he was but a child, he became the owner of a good estate and a ward of the crown. He was educated at the grammar school at Thame, and on the 30th of March 1610 became a commoner of Magdalen College at Oxford. In 1613 he was admitted a student of the Inner Temple. He first sat in parliament for the borough of Grampound in 1621, representing later Wendover in the first three parliaments of Charles I., Buckinghamshire in the Short Parliament of 1640, and Wendover again in the Long Parliament. In the early days of his parliamentary career he was content to be overshadowed by Eliot, as in its later days he was content to be overshadowed by Pym and to be commanded by Essex. Yet it is Hampden, and not Eliot or Pym, who lives in the popular imagination as the central figure of the English revolution in its earlier stages. It is Hampden whose statue rather than that of Eliot or Pym has been selected to take its place in St Stephen's Hall as the noblest type of the parliamentary opposition, as Falkland's has been selected as the noblest type of parliamentary royalism.

Something of Hampden's fame no doubt is owing to the position which he took up as the opponent of ship-money. But it is hardly possible that even resistance to ship-money would have so distinguished him but for the mingled massiveness and modesty of his character, his dislike of all pretences in himself or others, his brave contempt of danger, and his charitable readiness to shield others as far as possible from the evil consequences of their actions. Nor was he wanting in that skill which enabled him to influence men towards the ends at which he aimed, and which was spoken of as subtlety by those who disliked his ends.

During these first parliaments Hampden did not, so far as we know, open his lips in public debate, but he was increasingly employed in committee work, for which he seems to have had a special aptitude. In 1626 he took an active part in the preparation of the charges against Buckingham. In January 1627 he was bound over to answer at the council board for his refusal to pay the forced loan. Later in the year he was committed to the gatehouse, and then sent into confinement in Hampshire, from which he was liberated just before the meeting of the third parliament of the reign, in which he once more rendered useful but unobtrusive assistance to his leaders.

When the breach came in 1629 Hampden is found in epistolary correspondence with the imprisoned Eliot, discussing with him the prospects of the Massachusetts colony,² or rendering

¹ An earlier viscountcy was bestowed in 1776 on Robert Hampden-Trevor, 4th Baron Trevor (1706-1783), a great-grandson of the daughter of John Hampden, the patriot; it became extinct in 1824 by the death of the 3rd viscount.

² Hampden was one of the persons to whom the earl of Warwick granted land in Connecticut, but for the anecdote which relates his attempted emigration with Cromwell there is no foundation (v. under JOHN PYM).

hospitality and giving counsel to the patriot's sons now that they were deprived of a father's personal care. It was not till 1637, however, that his resistance to the payment of ship-money gained for his name the lustre which it has never since lost. (See SHIP-MONEY.) Seven out of the twelve judges sided against him, but the connexion between the rights of property and the parliamentary system was firmly established in the popular mind. The tax had been justified, says Clarendon, who expresses his admiration at Hampden's "rare temper and modesty" at this crisis, "upon such grounds and reasons as every stander-by was able to swear was not law" (*Hist. i.* 150, vii. 82).

In the Short Parliament of 1640 Hampden stood forth amongst the leaders. He guided the House in the debate on the 4th of May in its opposition to the grant of twelve subsidies in return for the surrender of ship-money. Parliament was dissolved the next day, and on the 6th an unsuccessful search was made among the papers of Hampden and of other chiefs of the party to discover incriminating correspondence with the Scots. During the eventful months which followed, when Strafford was striving in vain to force England, in spite of its visible reluctance, to support the king in his Scottish war, rumour has much to tell of Hampden's activity in rousing opposition. It is likely enough that the rumour is in the main true, but we are not possessed of any satisfactory evidence on the subject.

In the Long Parliament, though Hampden was by no means a frequent speaker, it is possible to trace his course with sufficient distinctness. His power consisted in his personal influence, and as a debater rather than as an orator. "He was not a man of many words," says Clarendon, "and rarely began the discourse or made the first entrance upon any business that was assumed, but a very weighty speaker, and after he had heard a full debate and observed how the House was likely to be inclined, took up the argument and shortly and clearly and craftily so stated it that he commonly conducted it to the conclusion he desired; and if he found he could not do that, he never was without the dexterity to divert the debate to another time, and to prevent the determining anything in the negative which might prove inconvenient in the future" (*Hist. liii.* 31). Unwearied in attendance upon committees, he was in all things ready to second Pym, whom he plainly regarded as his leader. Hampden was one of the eight managers of Strafford's prosecution. Like Pym, he was in favour of the more legal and regular procedure by impeachment rather than by attainder, which at the later stage was supported by the majority of the Commons; and through his influence a compromise was effected by which, while an attainder was subsequently adopted, Strafford's counsel were heard as in the case of an impeachment, and thus a serious breach between the two Houses, which threatened to cause the breakdown of the whole proceedings, was averted.

There was another point on which there was no agreement. A large minority wished to retain Episcopacy, and to keep the common Prayer Book unaltered, whilst the majority were at least willing to consider the question of abolishing the one and modifying the other. On this subject the parties which ultimately divided the House and the country itself were fully formed as early as the 8th of February 1641. It is enough to say that (s. under Pym) Hampden fully shared in the counsels of the opponents of Episcopacy. It is not that he was a theoretical Presbyterian, but the bishops had been in his days so fully engaged in the imposition of obnoxious ceremonies that it was difficult, if not impossible, to dissociate them from the cause in which they were embarked. Closely connected with Hampden's distrust of the bishops was his distrust of monarchy as it then existed. The dispute about the church therefore soon attained the form of an attack upon monarchy, and, when the majority of the House of Lords arrayed itself on the side of Episcopacy and the Prayer Book, of an attack upon the House of Lords as well.

No serious importance therefore can be attached to the offers of advancement made from time to time to Hampden and his friends. Charles would gladly have given them office if they had been ready to desert their principles. Every day Hampden's

conviction grew stronger that Charles would never abandon the position which he had taken up. In August 1640 Hampden was one of the four commissioners who attended Charles in Scotland, and the king's conduct there, connected with such events as the "Incident," must have proved to a man far less sagacious than Hampden that the time for compromise had gone by. He was therefore a warm supporter of the Grand Remonstrance, and was marked out as one of the five impeached members whose attempted arrest brought at last the opposing parties into open collision (see also Pym, Strode, Holles and Lenthall). In the angry scene which arose on the proposal to print the Grand Remonstrance, it was Hampden's personal intervention which prevented an actual conflict, and it was after the impeachment had been attempted that Hampden laid down the two conditions under which resistance to the king became the duty of a good subject. Those conditions were an attack upon religion and an attack upon the fundamental laws. There can be no doubt that Hampden fully believed that both those conditions were fulfilled at the opening of 1642.

When the Civil War began, Hampden was appointed a member of the committee for safety, levied a regiment of Buckinghamshire men for the parliamentary cause, and in his capacity of deputy-lieutenant carried out the parliamentary militia ordinance in the county. In the earlier operations of the war he bore himself gallantly and well. He took no actual part in the battle of Edgehill. His troops in the rear, however, arrested Rupert's charge at Kington, and he urged Essex to renew the attack here, and also after the disaster at Brentford. In 1643 he was present at the siege and capture of Reading. But it is not on his skill as a regimental officer that Hampden's fame rests. In war as in peace his distinction lay in his power of disentangling the essential part from the non-essential. In the previous constitutional struggle he had seen that the one thing necessary was to establish the supremacy of the House of Commons. In the military struggle which followed he saw, as Cromwell saw afterwards, that the one thing necessary was to beat the enemy. He protested at once against Essex's hesitations and compromises. In the formation of the confederacy of the six associated counties, which was to supply a basis for Cromwell's operations, he took an active part. His influence was felt alike in parliament and in the field. But he was not in supreme command, and he had none of that impatience which often leads able men to fail in the execution of orders of which they disapprove. His precious life was a sacrifice to his unselfish devotion to the call of discipline and duty. On the 18th of June 1643, when he was holding out on Chalgrove Field against the superior numbers of Rupert till reinforcements arrived, he received two carbine balls in the shoulder. Leaving the field he reached Thame, survived six days, and died on the 24th.

Hampden married (1) in 1619 Elizabeth, daughter of Edmund Symeon of Fyrton, Oxfordshire, and (2) Letitia, daughter of Sir Francis Knollys and widow of Sir Thomas Vachell. By his first wife he had nine children, one of whom, Richard (1631-1695) was chancellor of the exchequer in William III.'s reign; from two of his daughters are descended the families of Trevor-Hampden and Hobart-Hampden, the descent in the male line becoming apparently extinct in 1754 in the person of John Hampden.

JOHN HAMPDEN the younger (c. 1656-1696), the second son of Richard Hampden, returned to England after residing for about two years in France, and joined himself to Lord William Russell and Algernon Sidney and the party opposed to the arbitrary government of Charles II. With Russell and Sidney he was arrested in 1683 for alleged complicity in the Rye House Plot, but more fortunate than his colleagues his life was spared, although as he was unable to pay the fine of £40,000 which was imposed upon him he remained in prison. Then in 1685, after the failure of Monmouth's rising, Hampden was again brought to trial, and on a charge of high treason was condemned to death. But the sentence was not carried out, and having paid £6000 he was set at liberty. In the Convention parliament of 1689 he represented Wendover, but in the subsequent parliaments he

failed to secure a seat. He died by his own hand on the 12th of December 1696. Hampden wrote numerous pamphlets, and Bishop Burnet described him as "one of the learnedest gentlemen I ever knew."

See S. R. Gardiner's *Hist. of England and of the Great Civil War*; the article on Hampden in the *Dict. of Nat. Biography*, by C. H. Firth, with authorities there collected; Clarendon's *Hist. of the Rebellion*; Sir Philip Warwick's *Mems.* p. 239; Wood's *Ath. Oxon.* iii. 59; Lord Nugent's *Memoirs of John Hampden* (1831); Macaulay's *Essay on Hampden* (1831). The printed pamphlet announcing his capture of Reading in December 1642 is shown by Mr Firth to be spurious, and the account in *Mercurius Aulicus*, January 27 and 29, 1643, of Hampden commanding an attack at Brill, to be also false, while the published speech supposed to be spoken by Hampden on the 4th of January 1642, and reproduced by Forster in the *Arrest of the Five Members* (1660), has been proved by Gardiner to be a forgery (*Hist. of England*, x. 135). Mr Firth has also shown in *The Academy* for 1899, November 2 and 9, that "the belief that we possess the words of Hampden's last prayer must be abandoned."

HAMPDEN, RENN DICKSON (1793-1868), English divine, was born in Barbados, where his father was colonel of militia, in 1793, and was educated at Oriol College, Oxford. Having taken his B.A. degree with first-class honours in both classics and mathematics in 1813, he next year obtained the chancellor's prize for a Latin essay, and shortly afterwards was elected to a fellowship in his college, Keble, Newman and Arnold being among his contemporaries. Having left the university in 1816 he held successively a number of curacies, and in 1827 he published *Essays on the Philosophical Evidence of Christianity*, followed by a volume of *Parochial Sermons illustrative of the Importance of the Rendition of God in Jesus Christ* (1828). In 1829 he returned to Oxford and was Bampton lecturer in 1832. Notwithstanding a charge of Arianism now brought against him by the Tractarian party, he in 1833 passed from a tutorship at Oriol to the principalship of St Mary's Hall. In 1834 he was appointed professor of moral philosophy, and despite much university opposition, Regius professor of divinity in 1836. There resulted a widespread and violent though ephemeral controversy, after the subsidence of which he published a *Lecture on Tradition*, which passed through several editions, and a volume on *The Thirty-nine Articles of the Church of England*. His nomination by Lord John Russell to the vacant see of Hereford in December 1847 was again the signal for a violent and organized opposition; and his consecration in March 1848 took place in spite of a remonstrance by many of the bishops and the resistance of Dr John Merewether, the dean of Hereford, who went so far as to vote against the election when the *consilium d'élire* reached the chapter. As bishop of Hereford Dr Hampden made no change in his long-formed habits of studious seclusion, and though he showed no special ecclesiastical activity or zeal, the diocese certainly prospered in his charge. Among the more important of his later writings were the articles on Aristotle, Plato and Socrates, contributed to the eighth edition of the *Encyclopaedia Britannica*, and afterwards reprinted with additions under the title of *The Fathers of Greek Philosophy* (Edinburgh, 1862). In 1866 he had a paralytic seizure, and died in London on the 23rd of April 1868.

His daughter, Henrietta Hampden, published *Some Memoirs of R. D. Hampden* in 1871.

HAMPDEN-SIDNEY, a village of Prince Edward county, Virginia, U.S.A., about 70 m. S.W. of Richmond. Pop. about 350. Daily stages connect the village with Farmville (pop. in 1910, 2071), the county-seat, 6 m. N.E., which is served by the Norfolk & Western and the Tidewater & Western railways. Hampden-Sidney is the seat of Hampden-Sidney College, founded by the presbytery of Hanover county as Hampden-Sidney Academy in 1776, and named in honour of John Hampden and Algernon Sidney. It was incorporated as Hampden-Sidney College in 1783. The incorporators included James Madison, Patrick Henry (who is believed to have drafted the college charter), Paul Carrington, William Cabell, Sen., and Nathaniel Venable. The Union Theological School was established in connexion with the college in 1812, but in 1898 was removed to Richmond, Virginia. In 1907-1908 the college had 8 in-

structors, 125 students, and a library of 11,000 volumes. The college has maintained a high standard of instruction, and many of its former students have been prominent as public men, educationalists and preachers. Among them were President William Henry Harrison, William H. Cabell (1772-1853), president of the Virginia Court of Appeals; George M. Bibb (1777-1859), secretary of the treasury (1844-1845) in President Tyler's cabinet; William B. Preston (1805-1862), secretary of the navy in 1849-1850; William Cabell Rives and General Sterling Price (1809-1867).

HAMPSHIRE (or COUNTY OF SOUTHAMPTON, abbreviated HANTS), a southern county of England, bounded N. by Berkshire, E. by Surrey and Sussex, S. by the English Channel, and W. by Dorsetshire and Wiltshire. The area is 1623.5 sq. m. From the coast of the mainland, which is for the most part low and irregular, a strait, known in its western part as the Solent, and in its eastern as Spithead, separates the Isle of Wight. This island is included in the county. The inlet of Southampton Water opens from this strait, penetrating inland in a north-westerly direction for 12 m. The easterly part of the coast forms a large shallow bay containing Hayling and Portsea Islands, which divide it into Chichester Harbour, Langston Harbour and Portsmouth Harbour. The westerly part forms the more regular indentations of Christchurch Bay and part of Poole Bay. In its general aspect Hampshire presents a beautiful variety of gently rising hills and fruitful valleys, adorned with numerous mansions and pleasant villages, and interspersed with extensive tracts of woodland. Low ranges of hills, included in the system to which the general name of the Western Downs is given, reach their greatest elevation in the northern and eastern parts of the county, where there are many picturesque eminences, of which Beacon, Sidown and Pilot hills near Highclere in the north-west, each exceeding 850 ft., are the highest. The portion of the county west of Southampton Water is almost wholly included in the New Forest, a sequestered district, one of the few remaining examples of an ancient afforested tract. The river Avon in the south-west rises in Wiltshire, and passing Fordingbridge and Ringwood falls into Christchurch Bay below Christchurch, being joined close to its mouth by the Stour. The Lymington or Boldre river rises in the New Forest, and after collecting the waters of several brooks falls into the Solent through Lymington Creek. The Beaulieu in the eastern part of the forest also enters the Solent by way of a long and picturesque estuary. The Test rises near Overton in the north, and after its junction with the Anton at Fullerton passes Stockbridge and Romsey, and enters the head of Southampton Water. The Itchen rises near Alresford, and flowing by Winchester and Eastleigh falls into Southampton Water east of Southampton. The Hamble rises near Bishops Waltham, and soon forms a narrow estuary opening into Southampton Water. The Wey, the Loddon and the Blackwater, rising in the north-eastern part of the county, bring that part into the basin of the Thames. The streams from the chalk hills run clear and swift, and the trout-fishing in the county is famous. Salmon are taken in the Avon.

Geology.—Somewhat to the north of the centre of the county is a broad expanse of hilly chalk country about 21 m. wide; the whole of it has been bent up into a great fold so that the strata on the north dip northward steeply in places, while those on the south dip in the opposite direction more gently. In the north the chalk disappears beneath Tertiary strata of the "London Basin," and some little distance south of Winchester it runs in a similar manner beneath the Tertiaries of the "Hampshire Basin." Scattered here and there over the chalk are small outlying remnants which remain to show that the two Tertiary areas were once continuous, before the agencies of denudation had removed them from the chalk. These same agencies have exposed the strata beneath the chalk over a small area on the eastern border.

The oldest formation in Hampshire is the Lower Greensand in the neighbourhood of Woolmer Forest and Petersfield: it is represented by the Hythe beds, sandstones and limestones which form the high ridge which runs on towards Hind Head, then by the sands and clays of the Sandgate beds which lie in the low ground west of the ridge, and finally by the Folkestone beds; all these dip westward beneath the Gault. The last-named formation, a clay, worked here and there for bricks, crops out as a narrow band from Fareham through Wordham and Stroud common to Petersfield.

Between the Gault and the chalk is the Upper Greensand with a hard bed of calcareous sandstone, the Malm rock, which stands up in places as a prominent escarpment. The Upper Greensand is also exposed at Bursledon as an outlier; the rocks are best into a sharp anticline and the chalk, having been denuded from its crest, the older sandy strata are brought to light. A much more gentle anticline brings up the chalk through the Tertiary rocks in the neighbourhood of Fareham. Besides occupying the central region already mentioned, which includes Basingstoke, Whitechurch, Andover, Alresford and Winchester, the chalk appears also in a small patch round Rockbourne. The Tertiary rocks of the north (London basin) about Farnborough, Aldershot and Kingsclere, comprise the Reading beds, London clay and the more sandy Bagshot beds which cover the latter in many places, giving rise to heathy commons. The southern Tertiary rocks of the Hampshire basin include the Lower Eocene Reading beds—used for brick-making—and the London clay which extend from the boundary of the chalk by Romsey, Bishop's Waltham, to Havant. These are succeeded towards the south by the Upper Eocene beds, the Bracklesham beds and the Barton clay. The Barton clays are noted for their abundant fossils and the Bagshot beds at Bournemouth contain numerous remains of subropical plants. A series of clays and sands of Oligocene age (known as the London basin) are found in the vicinity of Lymington, Brockenhurst and Beaulieu; they include the Headon beds, with a fluviomarine fauna, well exposed at Hordwell cliffs, and the marine beds of Brockenhurst. Numerous small outliers of Tertiary rocks are scattered over the chalk area, and many of the chalk and Tertiary areas are obscured by patches of Pleistocene deposits of brick earth and gravel.

Agriculture and Industries.—Nearly seven-tenths of the total area is undercultivation (an amount below the average of English counties) and of this area about two-fifths is in permanent pasture. The acreage under oats is roughly equal to that under wheat and barley. Small quantities of rye and hops are cultivated. Barley is usually sown after turnips, and is more grown in the uplands than in the lower levels. Beans, peas and potatoes are only grown to a small extent. On account of the number of sheep pastured on the uplands a large acreage of turnips is grown. Rotation grasses are grown chiefly in the uplands, and their acreage is greater than in any other of the southern counties of England. *Sanfoin* is the grass most largely grown, as it is best adapted to land with a calcareous subsoil. In the lower levels no sanfoin and scarcely any clover is grown, the hay being supplied from the rich water meadows, which are managed with great skill and attention, and give the best money return of any land in the county. Where a rapid stream of water can be passed over them during the winter it seldom becomes frozen, and the grasses grow during the cold weather so as to be fit for pasture before any traces of vegetation appear in the surrounding fields. Hops are grown in the eastern part of the county bordering on Surrey. Farming is generally conducted on the best modern principles, but owing to the varieties of soil there is perhaps no county in England in which the rotation observed is more diversified, or the processes and methods more varied. Most of the farms are large, and there are a number of model farms. The waste land has been mostly brought under tillage, but a very large acreage of the ancient forests is still occupied by wood. In addition to the New Forest there are in the east Woolmer Forest and Alice Holt, in the south-east the Forest of Bere and Waltham Chase, and in the Isle of Wight Parkhurst Forest. The honey of the county is especially celebrated. Much attention is paid to the rearing of sheep and cattle. The original breed of sheep was white-faced with horns, but most of the flocks are now of a Southdown variety which have acquired certain distinct peculiarities, and are known as "short wools" or "Hampshire downs." Cattle are of no distinctive breed, and are kept largely for dairy purposes, especially for the supply of milk. The breeding and rearing of horses is widely practised, and the fattening of pigs has long been an important industry. The original breed of pigs is crossed with Berkshire, Essex and Chinese pigs. In the vicinity of the forest the pigs are fed on acorns and beechmast, and the flesh of those so reared is considered the best, though the reputation of Hampshire bacon depends chiefly on the skillful manner in which it is cured.

The manufactures are unimportant, except those carried on at Portsmouth and Gosport in connexion with the royal navy. Southampton is one of the principal ports in the kingdom. In many of the towns there are breweries and tanneries, and paper is manufactured at several places. Fancy pottery and terra-cotta are made at Fareham and Bishop's Waltham; and Ringwood is celebrated for its knitted gloves. At most of the coast towns fishing is carried on, and there are oyster beds at Hayling Island. Cows in the Isle of Wight is the station of the Royal Yacht Squadron, and has building yards for yachts and large vessels. The principal seaside resorts besides those in the Isle of Wight are Bournemouth, Milford, Lee-on-the-Solent, Southsea and South Hayling. Aldershot is the principal military training centre in the British Isles.

Communications.—Communications are provided mainly by the lines of the London & South-Western railway company, which also owns the docks at Southampton. The main line serves Farnborough, Basingstoke, Whitechurch and Andover, and a branch diverges southward from Basingstoke for Winchester, Southampton and the New Forest and Bournemouth. An alternative line from eastward

to Winchester serves Aldershot, Alton and Alresford. The main Portsmouth line skirts the south-eastern border by Petersfield to Havant, where it joins the Portsmouth line of the London, Brighton & South Coast railway. The South-Western system also connects Portsmouth and Gosport with Southampton, has numerous branches in the Southampton and south-western districts, and large work shops at Eastleigh near Southampton. The Great Western company serves Basingstoke from Reading and Whitechurch, Winchester and Southampton from Didcot (working the Didcot, Newbury & Southampton line); the Midland & South-Western Junction line connects Andover with Cheltenham; and the Somerset & Dorset (also a Midland & South-Western joint line) connects Bournemouth with Bath—all these affording through communications between Southampton, Bournemouth, and the midlands and north of England. None of the rivers, except in the estuarine parts, is navigable.

Population and Administration.—The area of the ancient county is 1,039,031 acres, including the Isle of Wight. The population was 690,097 in 1891 and 797,634 in 1901. The area of the administrative county of Southampton is 958,742 acres, and that of the administrative county of the Isle of Wight 94,068 acres. The county is divided for parliamentary purposes into the following divisions: Northern or Basingstoke, Western or Andover, Eastern or Petersfield, Southern or Farnham, New Forest, and Isle of Wight, each returning one member. It also includes the parliamentary boroughs of Portsmouth and Southampton, each returning two members, and of Christchurch and Winchester, each returning one. There are 11 municipal boroughs: Andover (pop. 6500), Basingstoke (9793), Bournemouth (59,762), Christchurch (4204), Lymington (4165), Portsmouth (188,133), Romsey (4365), Southampton (104,824), Winchester (20,929), and in the Isle of Wight, Newport (10,911) and Ryde (11,043). Bournemouth, Portsmouth and Southampton are county boroughs. The following are urban districts: Aldershot (30,974), Alton (5479), Eastleigh and Bishopstoke (9317), Fareham (8246), Farnborough (11,500), Gosport and Alverstoke (28,884), Havant (3837), Itchen (13,097), Petersfield (2265), Warblington (3639); and in the Isle of Wight, Cowes (8652), East Cowes (3196), St Helen's (4652), Sandown (5006), Shanklin (4533), Ventnor (5866). The county is in the western circuit, and assizes are held at Winchester. It has one court of quarter sessions, and is divided into 14 petty sessional divisions. The boroughs of Andover, Basingstoke, Bournemouth, Lymington, Newport, Portsmouth, Romsey, Ryde, Southampton (a county in itself) and Winchester have separate commissions of the peace, and the boroughs of Andover, Bournemouth, Portsmouth, Southampton and Winchester have in addition separate courts of quarter sessions. There are 394 civil parishes. Hampshire is in the diocese of Winchester, excepting small parts in those of Oxford and Salisbury, and contains 411 ecclesiastical parishes or districts wholly or in part.

History.—The earliest English settlers in the district which is now Hampshire were a Jutish tribe who occupied the northern parts of the Isle of Wight and the valleys of the Meon and the Hamble. Their settlements were, however, unimportant, and soon became absorbed in the territory of the West Saxons who in 495 landed at the mouth of the Itchen under the leadership of Cerdic and Cynric, and in 508 slew 5000 Britons and their king. But it was not until after another decisive victory at Charford in 519 that the district was definitely organized as West Saxon territory under the rule of Cerdic and Cynric, thus becoming the nucleus of the vast later kingdom of Wessex. The Isle of Wight was subjugated in 530 and bestowed on Stuf and Wiltgar, the nephews of Cerdic. The Northmen made their first attack on the Hampshire coast in 835, and for the two centuries following the district was the scene of perpetual devastations by the Danish pirates, who made their headquarters in the Isle of Wight, from which they plundered the opposite coast. Hampshire suffered less from the Conquest than almost any English county, and was a favourite resort of the Norman kings. The alleged destruction of property for the formation of the New Forest is refuted by the Domesday record, which shows that this district had never been under cultivation.

In the civil war of Stephen's reign Baldwin de Redvers, lord of the Isle of Wight, supported the empress Matilda, and Winchester Castle was secured in her behalf by Robert of Gloucester, while the neighbouring fortress of Wolvesey was held for Stephen by Bishop Henry de Blois. In 1216 Louis of France, having arrived in the county by invitation of the barons, occupied Winchester Castle, and only met with resistance at Odiham Castle, which made a brave stand against him for fifteen days. During the Wars of the Roses Anthony Woodville, and earl Rivers, defeated the duke of Clarence at Southampton, and in 1471, after the battle of Barnet, the countess of Warwick took

sanctuary at Beaulieu Abbey. The chief events connected with Hampshire in the Civil War of the 17th century were the gallant resistance of the cavalier garrisons at Winchester and Basing House; a skirmish near Cheriton in 1644 notable as the last battle fought on Hampshire soil; and the concealment of Charles at Titchfield in 1647 before his removal to Carisbrooke. The duke of Monmouth, whose rebellion met with considerable support in Hampshire, was captured in 1685 near Ringwood.

Hampshire was among the earliest shires to be created, and must have received its name before the revival of Winchester in the latter half of the 7th century. It is first mentioned in the Saxon chronicle in 755, at which date the boundaries were practically those of the present day. The Domesday Survey mentions 44 hundreds in Hampshire, but by the 14th century the number had been reduced to 37. The hundreds of East Medina and West Medina in the Isle of Wight are mentioned in 1316. Constables of the hundreds were first appointed by the Statute of Winchester in 1285, and the hundred court continued to elect a high constable for Fordingbridge until 1878. The chief court of the Isle of Wight was the Knighten court held at Newport every three weeks. The sheriff's court and the assizes and quarter sessions for the county were formerly held at Winchester, but in 1831 the county was divided into 14 petty sessional divisions; the quarter sessions for the county were held at Andover; and Portsmouth, Southampton and Winchester had separate jurisdiction. Southampton was made a county by itself with a separate sheriff in 1447.

In the middle of the 7th century Hampshire formed part of the West Saxon bishopric of Dorchester-on-Thames. On the transference of the episcopal seat to Winchester in 676 it was included in that diocese in which it has remained ever since. In 1291 the archdeaconry of Winchester was coextensive with the county and comprised the ten rural deaneries of Alresford, Alton, Andover, Basingstoke, Drokinsford, Fordingbridge, Isle of Wight, Sombourne, Southampton and Winchester. In 1850 the Isle of Wight was subdivided into the deaneries of East Medina and West Medina. In 1856 the deaneries were increased to 24. In 1871 the archdeaconry of the Isle of Wight was constituted, and about the same time the deaneries were reduced to 21. In 1892 the deaneries were reconstituted and made 18 in number, and the archdeaconry of the Isle of Wight was divided into the deaneries of East Wight and West Wight.

After the Conquest the most powerful Hampshire baron was William Fitz-Osbern, who in addition to the lordship of the Isle of Wight held considerable estates on the mainland. At the time of the Domesday Survey the chief landholders were Hugh de Port, ancestor of the Fitz-Johns; Ralf de Mortimer; William Mauduit whose name is preserved in Hartley Mauditt; and Waleran, called the Huntsman, ancestor of the Walerand family. Hursley near Winchester was the seat of Richard Cromwell; and Gilbert White, the naturalist, was curate of Farrington near Selborne.

Apart from the valuable foreign and shipbuilding trade which grew up with the development of its ports, Hampshire has always been mainly an agricultural county, the only important manufacture being that of wool and cloth, which prospered at Winchester in the 12th century and survived till within recent years. Salt-making and the manufacture of iron from native ironstone also flourished in Hampshire from pre-Norman times until within the 19th century. In the 14th century Southampton had a valuable trade with Venice, and from the 15th to the 18th century many famous warships were constructed in its docks. Silk-weaving was formerly carried on at Winchester, Andover, Odiham, Alton, Whitchurch and Overton, the first mills being set up in 1684 at Southampton by French refugees. The paper manufacture at Laverstoke was started by the Portals, a family of Huguenot refugees, in 1685, and a few years later Henri de Portal obtained the privilege of supplying the bank-note paper to the Bank of England.

Hampshire returned four members to parliament in 1295, when the boroughs of New Alresford, Alton, Andover, Basingstoke, Overton, Portsmouth, Southampton, Winchester, Yarmouth

and Newport were also represented. After this date the county was represented by two members, but most of the boroughs ceased to make returns. Odiham and the Isle of Wight were represented in 1300, Fareham in 1306, and Petersfield in 1307. From 1311 to 1547 Southampton, Portsmouth, and Winchester were the only boroughs represented. By the end of the 16th century Petersfield, Newport, Yarmouth, and Andover had regained representation, and Stockbridge, Christchurch, Lymington, Newtown and Whitchurch returned two members each, giving the county with its boroughs a total representation of 26 members. Under the Reform Act of 1832 the county returned four members in four divisions; Christchurch and Petersfield lost one member each; and Newtown, Yarmouth, Stockbridge and Whitchurch were disfranchised. By the act of 1868 Andover, Lymington and Newport were deprived of one member each.

Antiquities.—Hampshire is rich in monastic remains. Those considered under separate headings include the monastery of Hyde near Winchester, the magnificent churches at Christchurch and Romsey, the ruins of Netley Abbey, and of Beaulieu Abbey in the New Forest, the fragments of the priory of St Denys, Southampton, the church at Porchester and the slight ruins at Titchfield, near Fareham, and Quarr Abbey in the Isle of Wight. Other foundations, of which the remains are slight, were the Augustinian priory of Southwick near Fareham, founded by William of Wykeham; that of Breamore, founded by Baldwin de Redvers, and that of Mottisfont near Romsey, endowed soon after the Conquest. There are many churches of interest, apart from the cathedral-church of Winchester and those in some of the towns in the Isle of Wight, or already mentioned in connexion with monastic foundations. Pre-Conquest work is well shown in the churches of Corhampton and Breamore, and very early masonry is also found in Headbourne Worthy church, where is also a brass of the 15th century to a scholar of Winchester College in collegiate dress. The most noteworthy Norman churches are at Chilcombe and Kingsclere and (with Early English additions) at Brockenhurst, Upper Clatford, which has the unusual arrangement of a double chancel arch, Hambledon, Milford and East Meon. Principally Early English are the churches of Cheriton, Grately, which retains some excellent contemporary stained glass from Salisbury cathedral; Sopley, which is partly Perpendicular; and Thruxton, which contains a brass to Sir John Lisle (d. 1407), affording a very early example of complete plate armour. Specimens of the later styles are generally less remarkable. The frescoes in Bramley church, ranging in date from the 13th to the 15th century, include a representation of the murder of Thomas à Beckett. A fine series of Norman fonts in black marble should be mentioned; they occur in Winchester cathedral and the churches of St Michael, Southampton, East Meon and St Mary Bourne.

The most notable old castles are Carisbrooke in the Isle of Wight; Porchester, a fine Norman stronghold embodying Roman remains, on Portsmouth Harbour; and Hurst, guarding the mouth of the Solent, where for a short time Charles I. was imprisoned. Henry VIII. built several forts to guard the Solent, Spithead and Southampton Water; Hurst Castle was one, and others remaining, but adapted to various purposes, are at Cowes, Calshot and Netley. Fine mansions are unusually numerous. That of Stratfieldsaye or Strathfieldsaye, which belonged to the Pitt family, was purchased by parliament for presentation to the duke of Wellington in 1817, his descendants holding the estate from the Crown in consideration of the annual tribute of a flag to the guard-room at Windsor. A statue of the duke stands in the grounds, and his war-horse "Copenhagen" is buried here. The name of Tichborne Park, near Alresford, is well known in connexion with the famous claimant of the estates whose case was heard in 1871. Among ancient mansions the Jacobean Bramshill is conspicuous, lying near Stratfieldsaye in the north of the county. It is built of stone and is highly decorated, and though the complete original design was not carried out the house is among the finest of its type in England. At Bishops Walkham, a small town 20 m. S.S.E. of Winchester.

Henry de Blois, bishop of Winchester, erected a palace, which received additions from William of Wykeham, who died here in 1404, and from other bishops. The ruins are picturesque but not extensive.

See *Victoria County History*, "Hampshire," R. Warner, *Collections for the History of Hampshire*; &c. (London, 1789); H. Moody, *Hampshire in 1086* (1862), and the same author's *Antiquarian and Topographical Sketches* (1846), and *Notes and Essays relating to the Counties of Hants and Wilts* (1851); R. Mudie, *Hampshire, &c.* (3 vols., Winchester, 1838); B. B. Woodward, T. C. Wilks and C. Lockhart, *General History of Hampshire* (1861-1869); G. N. Godwin, *The Civil War in Hampshire, 1642-1645* (London, 1882); H. M. Gilbert and G. N. Godwin, *Bibliotheca Hantoniensis* (Southampton, 1891). See also various papers in *Hampshire Notes and Queries* (Winchester, 1883 et seq.).

HAMPSTEAD, a north-western metropolitan borough of London, England, bounded E. by St Pancras and S. by St Marylebone, and extending N. and W. to the boundary of the county of London. Pop. (1901), 81,942. The name, *Hamstede*, is synonymous with "homestead," and the manor is first named in a charter of Edgar (957-975), and was granted to the abbey of Westminster by Ethelred in 986. It reverted to the Crown in 1550, and had various owners until the close of the 18th century, when it came to Sir Thomas Spencer Wilson, whose descendants retain it. The borough includes the sub-manor of Belsize and part of the hamlet of Kilburn.

The surface of the ground is sharply undulating, an elevated spur extending south-west from the neighbourhood of Highgate, and turning south through Hampstead. It reaches a height of 443 ft. above the level of the Thames. The Edgware Road bounds Hampstead on the west; and the borough is intersected, parallel to this thoroughfare, by Finchley Road, and by Haverstock Hill, which, continued under the names of Rosslyn Hill, High Street, Heath Street, and North End, crosses the Heath for which Hampstead is chiefly celebrated. This is a fine open space of about 240 acres, including in its bounds the summit of Hampstead Hill. It is a sandy tract, in parts well wooded, diversified with several small sheets of water, and to a great extent preserves its natural characteristics unaltered. Beautiful views, both near and distant, are commanded from many points. Of all the public grounds within London this is the most valuable to the populace at large; the number of visitors on a Bank holiday in August is generally, under favourable conditions, about 100,000; and strenuous efforts are always forthcoming from either public or private bodies when the integrity of the Heath is in any way menaced. As early as 1829 attempts to save it from the builder are recorded. In 1871 its preservation as an open space was insured after several years' dispute, when the lord of the manor gave up his rights. An act of parliament transferred the ownership to the Metropolitan Board of Works, to which body the London County Council succeeded. The Heath is continued eastward in Parliament Hill (borough of St Pancras), acquired for the public in 1890; and westward outside the county boundary in Golders Hill, owned by Sir Spencer Wells, Bart., until 1898. A Protection Society guards the preservation of the natural beauty and interests of the Heath. It is not the interests of visitors alone that must be consulted, for Hampstead, adding to its other attractions a singularly healthy climate, has long been a favourite residential quarter, especially for lawyers, artists and men of letters. Among famous residents are found the first earl of Chatham, John Constable, George Romney, George du Maurier, Joseph Butler, author of the *Analogy*, Sir Richard Steele, John Keats, the sisters Joanna and Agnes Baillie, Leigh Hunt and many others. The parish church of St John (1747) has several monuments of eminent persons. Chatham's residence was at North End, a picturesque quarter yet preserving characteristics of a rural village; here also Wilkie Collins was born. Three old-established inns, the Bull and Bush, the Spaniards, and Jack Straw's Castle (the name of which has no historical significance), claim many great names among former visitors; while the Upper Flask Inn, now a private house, was the meeting-place of the Kit-Cat Club. Chalybeate springs were discovered at Hampstead in the 17th century, and early in the 18th rivalled those of

Tunbridge Wells and Epsom. The name of Well Walk recalls them, but their fame is lost. There are others at Kilburn.

In the south-east Hampstead includes the greater part of Primrose Hill, a public ground adjacent to the north side of Regent's Park. The borough has in all about 350 acres of open spaces. The name of the sub-manor of Belsize is preserved in several streets in the central part. Kilburn, which as a district extends outside the borough, takes name from a stream which, as the Westbourne, entered the Thames at Chelsea. Fleet Road similarly recalls the more famous stream which washed the walls of the City of London on the west. Hampstead has numerous charitable institutions, amongst which are the North London consumptive hospital, the Orphan Working School, Haverstock Hill (1758), the general hospital and the north-western fever hospital. In Finchley Road are the New and Hackney Colleges, both Congregational. The parliamentary borough of Hampstead returns one member. The borough council consists of a mayor, 7 aldermen and 42 councillors. Area, 2265 acres.

HAMPTON, WADE (1818-1902), American cavalry leader was born on the 28th of March 1818 at Columbia, South Carolina, the son of Wade Hampton (1791-1858), one of the wealthiest planters in the South, and the grandson of Wade Hampton (1754-1835), a captain in the War of Independence and a brigadier-general in the War of 1812. He graduated (1836) at South Carolina College, and was trained for the law. He devoted himself, however, to the management of his great plantations in South Carolina and in Mississippi, and took part in state politics and legislation. Though his own views were opposed to the prevailing state-rights tone of South Carolinian opinion, he threw himself heartily into the Southern cause in 1861, raising a mixed command known as "Hampton's Legion," which he led at the first battle of Bull Run. During the Civil War he served in the main with the Army of Northern Virginia in Stuart's cavalry corps. After Stuart's death Hampton distinguished himself greatly in opposing Sheridan in the Shenandoah Valley, and was made lieutenant-general to command Lee's whole force of cavalry. In 1865 he assisted Joseph Johnston in the attempt to prevent Sherman's advance through the Carolinas. After the war his attitude was conciliatory and he recommended a frank acceptance by the South of the war's political consequences. He was governor of his state in 1876-1879, being installed after a memorable contest; he served in the United States Senate in 1879-1891, and was United States commissioner of Pacific railways in 1893-1897. He died on the 11th of April 1902.

See E. L. Wells, *Hampton and Reconstruction* (Columbia, S. C., 1907).

HAMPTON, an urban district in the Uxbridge parliamentary division of Middlesex, England, 15 m. S.W. of St Paul's cathedral, London, on the river Thames, served by the London & South Western railway. Pop. (1901), 6813. Close to the river, a mile below the town, stands Hampton Court Palace, one of the finest extant specimens of Tudor architecture, and formerly a royal residence. It was erected by Cardinal Wolsey, who in 1515 received a lease of the old mansion and grounds for 99 years. As the splendour of the building seemed to awaken the cupidity of Henry VIII., Wolsey in 1526 thought it prudent to make him a present of it. It became Henry's favourite residence, and he made several additions to the building, including the great hall and chapel in the Gothic style. Of the original five quadrangles only two now remain, but a third was erected by Sir Christopher Wren for William III. In 1649 a great sale of the effects of the palace took place by order of parliament, and later the manor itself was sold to a private owner but immediately after came into the hands of Cromwell; and Hampton Court continued to be one of the principal residences of the English sovereigns until the time of George II. It was the birthplace of Edward VI., and the meeting-place (1604) of the conference held in the reign of James I. to settle the dispute between the Presbyterians and the state clergy. William III., riding in the grounds, met with the accident which resulted in his death. It is now partly occupied by persons of rank in reduced circumstances; but the state apartments and picture

galleries are open to the public, as is the home park. The gardens, with their ornamental waters, are beautifully laid out in the Dutch style favoured by William III., and contain a magnificent vine planted in 1768. In the enclosure north of the palace, called the Wilderness, is the Maze, a favourite resort. North again lies Bushey Park, a royal demesne exceeding 1000 acres in extent. It is much frequented, especially in early summer, when its triple avenue of horse-chestnut trees is in blossom.

Among several residences in the vicinity of Hampton is Garrick Villa, once, under the name of Hampton House, the residence of David Garrick the actor. Sir Christopher Wren and Sir Richard Steele are among famous former residents. HAMPTON WICK, on the river E. of Bushey Park, is an urban district with a population (1901) of 2606.

See E. Law, *History of Hampton Court Palace* (London, 1890).

HAMPTON, a city and the county-seat of Elizabeth City county, Virginia, U.S.A., at the mouth of the James river, on Hampton Roads, about 15 m. N.W. of Norfolk. Pop. (1890), 2513; (1900) 2764, including 1249 negroes; (1910) 5505. It is served by the Chesapeake & Ohio railway, and by trolley lines to Old Point Comfort and Newport News. Hampton is an agricultural shipping point, ships fish, oysters and canned crabs, and manufactures fish oil and brick. In the city are St John's church, built in 1727; a national cemetery, a national soldiers' home (between Phoebus and Hampton), which in 1907-1908 cared for 4093 veterans and had an average attendance of 2261; and the Hampton Normal and Agricultural Institute (co-educational), which was opened by the American Missionary Association in 1868 for the education of negroes. This last was chartered and became independent of any denominational control in 1870, and was superintended by Samuel Chapman Armstrong (q.v.) from 1868 to 1893. The school was opened in 1878 to Indians, whose presence has been of distinct advantage to the negro, showing him, says Booker T. Washington, the most famous graduate of the school, that the negro race is not alone in its struggle for improvement. The National government pays \$167 a year for the support of each of the Indian students. The underlying idea of the Institute is such industrial training as will make the pupil a willing and a good workman, able to teach his trade to others; and the school's graduates include the heads of other successful negro industrial schools, the organizers of agricultural and industrial departments in Southern public schools and teachers in graded negro schools. The mechanism of the school includes three schemes: that of "work students," who work during the day throughout the year and attend night school for eight months; that of day school students, who attend school for four or five days and do manual work for one or two days each week; and that of trade students, who receive trade instruction in their daily eight-hours' work and study in night school as well. Agriculture in one or more of its branches is taught to all, including the four or five hundred children of the Whittier school, a practice school with kindergarten and primary classes. Graduate courses are given in agriculture, business, domestic art and science, library methods, "matrons'" training, and public school teaching. The girl students are trained in every branch of housekeeping, cooking, dairying and gardening. The institute publishes *The Southern Workman*, a monthly magazine devoted to the interests of the Negro and the Indian and other backward races. In 1908 the Institute had more than 100 buildings and 188 acres of land S.W. of the national cemetery and on Hampton river and Jones Creek, and 600 acres at Shellbanks, a stock farm 6 m. away; the enrolment was 21 in graduate classes, 372 in day school, 489 in night school and 524 in the Whittier school. Of the total, 88 were Indians.

Hampton was settled in 1610 on the site of an Indian village, Kecoughtan, a name it long retained, and was represented at the first meeting (1619) of the Virginia House of Burgesses. It was fired by the British during the War of 1812 and by the Confederates under General J. B. Magruder in August 1861. During the Civil War there was a large Union hospital here, the building of the Chesapeake Female College, erected in 1857,

being used for this purpose. Hampton was incorporated as a town in 1887, and in 1908 became a city of the second class.

HAMPTON ROADS, a channel through which the waters of the James, Nansemond and Elizabeth rivers of Virginia, U.S.A., pass (between Old Point Comfort to the N. and Sewell's Point to the S.) into Chesapeake Bay. It is an important highway of commerce, especially for the cities of Norfolk, Portsmouth and Newport News, and is the chief rendezvous of the United States navy. For a width of 500 ft. the Federal government during 1902-1905 increased its minimum depth at low water from 25½ ft. to 30 ft. The entrance from Chesapeake Bay is defended by Fortress Monroe on Old Point Comfort and by Fort Wood on a small island called the Rip Raps near the middle of the channel; and at Portsmouth, a few miles up the Elizabeth river, is an important United States navy-yard.

Hampton Roads is famous in history as the scene of the first engagement between iron-clad vessels. In the spring of 1861 the Federals set fire to several war vessels in the Gosport navy yard on the Elizabeth river and abandoned the place. In June the Confederates set to work to raise one of these abandoned vessels, the frigate "Merrimac" of 3500 tons and 40 guns, and to rebuild it as an iron-clad. The vessel (re-named the "Virginia" though it is generally known in history by its original name) was first cut down to the water-line and upon her hull was built a rectangular casemate, constructed of heavy timber (24 in. in thickness), covered with bar-iron 4 in. thick, and rising from the water on each side at an angle of about 35°. The iron plating extended 2 ft. below the water line; and beyond the casemate, toward the bow, was a cast-iron pilot house, extending 3 ft. above the deck. The reconstruction of the vessel was completed on the 5th of March 1862. The vessel drew 22 ft. of water, was equipped with poor engines, so that it could not make more than 5 knots, and was so unwieldy that it could not be turned in less than 30 minutes. It was armed with 10 guns—2 (rifled) 7 in., 2 (rifled) 6 in., and 6 (smooth bore Dahlgren) 9 in. Her most powerful equipment, however, was her 18 in. cast-iron ram. In October 1861 Captain John Ericsson, an engineer, and a Troy (N.Y.) firm, as builders, began the construction of the iron-clad "Monitor" for the Federals, at Greenpoint, Long Island. With a view to enable this vessel to carry at good speed the thickest possible armour compatible with buoyancy, Ericsson reduced the exposed surface to the least possible area. Accordingly, the vessel was built so low in the water that the waves glided easily over its deck except at the middle, where was constructed a revolving turret¹ for the guns, and though the vessel's iron armour had a thickness of 1 in. on the deck, 5 in. on the side, and 8 in. on the turret, its draft was only 10 ft. 6 in., or less than one-half that of the "Merrimac." Its turret, 9 ft. high and 20 ft. in inside diameter, seemed small for its length of 172 ft. and its breadth of 41 ft. 6 in., and this, with the lowness of its freeboard, caused the vessel to be called the "Yankee cheese-box on a raft." Forward of the turret was the iron pilot house, square in shape, and rising about 4 ft. above the deck. The "Monitor's" displacement was about 1200 tons and her armament was two 11 in. Dahlgren guns; her crew numbered 58, while that of the "Merrimac" numbered about 300. She was seaworthy in the shallow waters off the southern coasts and steered fairly well. The "Monitor" was launched at Greenpoint, Long Island, on the 30th of January, and was turned over to the government on the 19th of the following month. The building of the two vessels was practically a race between the two combatants.

On the 8th of March about 1 p.m., the "Merrimac," commanded by Commodore Franklin Buchanan (1795-1871), steamed down the Elizabeth accompanied by two one-gun gun-boats, to engage the wooden fleet of the Federals, consisting of the frigate "Congress," 50 guns, and the sloop "Cumberland," 30 guns, both sailing vessels, anchored off Newport News, and

¹ For the idea of the low free-board and the revolving turret Ericsson was indebted to Theodore R. Timby (1819-1909), who in 1843 had filed a caveat for revolving towers for offensive or defensive warfare whether placed on land or water, and to whom the company building the "Monitor" paid \$5000 royalty for each turret.

the steam frigates "Minnesota," and "Roanoke," the sailing frigate "St Lawrence," and several gun-boats, anchored off Fortress Monroe. Actual firing began about 2 o'clock, when the "Merrimac" was nearly a mile from the "Congress" and the "Cumberland." Passing the first of these vessels with terrific broadsides, the "Merrimac" rammed the "Cumberland" and then turned her fire again on the "Congress," which in an attempt to escape ran aground and was there under fire from three other Confederate gun-boats which had meanwhile joined the "Merrimac." About 3.30 p.m. the "Cumberland," which, while it steadily careened, had been keeping up a heavy fire at the Confederate vessels, sank, with "her pennant still flying from the topmast above the waves." Between 4 and 4.30 the "Congress," having been raked fore and aft for nearly an hour by the "Merrimac," was forced to surrender. While directing a fire of hot shot to burn the "Congress," Commodore Buchanan of the "Merrimac" was severely wounded and was succeeded in the command by Lieutenant Catesby ap Roger Jones. The Federal steam frigates, "Roanoke," "St Lawrence" and "Minnesota" had all gone aground in their trip from Old Point Comfort toward the scene of battle, and only the "Minnesota" was near enough (about 1 m.) to take any part in the fight. She was in such shallow water that the Confederate iron-clad ram could not get near her at ebb tide, and about 5 o'clock the Confederates postponed her capture until the next day and anchored off Sewell's Point.

The "Monitor," under Lieut. John Lorimer Worden (1818-1897), had left New York on the morning of the 6th of March; after a dangerous passage in which she twice narrowly escaped sinking, she arrived at Hampton Roads during the night of the 8th, and early in the morning of the 9th anchored near the "Minnesota." When the "Merrimac" advanced to attack the "Minnesota," the "Monitor" went out to meet her, and the battle between the iron-clads began about 9 a.m. on the 9th. Neither vessel was able seriously to injure the other, and not a single shot penetrated the armour of either. The "Monitor" had the advantage of being able to out-mancœuvre her heavier and more unwieldy adversary; but the revolving turret made firing difficult and communications were none too good with the pilot house, the position of which on the forward deck lessened the range of the two turret-guns. The machinery worked so badly that the revolution of the turret was stopped. After two hours' fighting, the "Monitor" was drawn off, so that more ammunition could be placed in her turret. When the battle was renewed (about 11.30) the "Merrimac" began firing at the "Monitor's" pilot house; and a little after noon a shot struck the sight-hole of the pilot house and blinded Lieut. Worden. The "Monitor" withdrew in the confusion consequent upon the wounding of her commanding officer; and the "Merrimac" after a short wait for her adversary steamed back to Norfolk. There were virtually no casualties on either side. After the evacuation of Norfolk by the Confederates on the 9th of May Commodore Josiah Tattnall, then in command of the "Merrimac," being unable to take her up the James, sank her. The "Monitor" was lost in a gale off Cape Hatteras on the 31st of December 1862.

Though the battle between the two vessels was indecisive, its effect was to "neutralize" the "Merrimac," which had caused great alarm in Washington, and to prevent the breaking of the Federal blockade at Hampton Roads; in the history of naval warfare it may be regarded as marking the opening of a new era—the era of the armoured warship. On the 3rd of February 1865 near Fortress Monroe on board a steamer occurred the meeting of President Lincoln and Secretary Seward with Confederate commissioners which is known as the Hampton Roads Conference (see LINCOLN, ABRAMAM). At Sewell's Point, on Hampton Roads, in 1907 was held the Jamestown Tercentennial Exposition.

See James R. Soley, *The Blockade and the Cruisers* (New York, 1883); *Battles and Leaders of the Civil War*, vol. 1. (New York, 1887); chap. ii. of Frank M. Bennett's *The Monitor and the Navy under Steam* (Boston, 1900); and William Swinton, *Twelve Decisive Battles of the War* (New York, 1867).

HAMSTER, a European mammal of the order Rodentia, scientifically known as *Cricetus frumentarius* (or *C. cricetus*), and belonging to the mouse tribe, *Muridae*, in which it typifies the sub-family *Cricetinae*. The essential characteristic of the Cricetines is to be found in the upper cheek-teeth, which (as shown in the figure of those of *Cricetus* in the article RODENTIA) have their cusps arranged in two longitudinal rows separated by a groove. The hamsters, of which there are several kinds, are short-tailed rodents, with large cheek-pouches, of which the largest is the common *C. frumentarius*. Their geographical distribution comprises a large portion of Europe and Asia north of the Himalaya. All the European hamsters show more or less black on the under-parts, but the small species from Central Asia, which constitute distinct subgenera, are uniformly grey. The common species is specially interesting on account of its habits. It constructs elaborate burrows containing several chambers, one of which is employed as a granary, and filled with corn, frequently of several kinds, for winter use. As a rule, the males, females, and young of the first year occupy separate burrows. During the winter these animals retire to their burrows, sleeping the greater part of the time, but awakening about February or March, when they feed on the garnered grain. They are very prolific, the female producing several litters in the year, each consisting of over a dozen blind young; and these, when not more than three weeks old, are turned out of the parental burrow to form underground homes for themselves. The burrow of the young hamster is only about a foot in depth, while that of the adult descends 4 or 5 ft. beneath the surface. On retiring for the winter the hamster closes the various entrances to its burrow, and becomes torpid during the coldest period. Although feeding chiefly on roots, fruits and grain, it is also to some extent carnivorous, attacking and eating small quadrupeds, lizards and birds. It is exceedingly fierce and pugnacious, the males especially fighting with each other for possession of the females. The numbers of these destructive rodents are kept in check by foxes, dogs, cats and pole-cats, which feed upon them. The skin of the hamster is of some value, and its flesh is used as food. Its burrows are sought after in the countries where it abounds, both for capturing the animal and for rifling its store. America, especially North America, is the home of by far the great majority of *Cricetinae*, several of which are called white-footed or deer-mice. They are divided into numerous genera and the number of species is very large indeed. Both in size and form considerable variability is displayed, the species of *Holochilus* being some of the largest, while the common white-footed mouse (*Eligmodon leucopus*) of North America is one of the smaller forms. Some kinds, such as *Oryzomys* and *Peromyscus* have long, rat-like tails, while others, like *Acodon*, are short-tailed and more vole-like in appearance. In habits some are partially arboreal, others wholly terrestrial, and a few more or less aquatic. Among the latter, the most remarkable are the fish-eating rats (*Ichthyomys*) of North-western South America, which frequent streams and feed on small fish. The Florida rice-rat (*Sigmodon hispidus*) is another well-known representative of the group. In the Old World the group is represented by the Persian *Calomyscus*, a near relative of *Peromyscus*. (R. L. *)

HANAPER, properly a case or basket to contain a "hanap" (O. Eng. *hanap*; cf. Dutch *nap*), a drinking vessel, a goblet with a foot or stem; the term which is still used by antiquaries for medieval stemmed cups. The famous Royal Gold Cup in the British Museum is called a "hanap" in the inventory of Charles VI. of France. The word "hanaper" (Med. Lat. *hanaperium*) was used particularly in the English chancery of a wicker basket in which were kept writs and other documents, and hence it became the name of a department of the chancery, now abolished, under an officer known as the clerk or warden of the hanaper, into which were paid fees and other moneys for the sealing of charters, patents, writs, &c., and from which issued certain writs under the great seal (S. R. Scargill-Bird, *Guide to the Public Records* (1908). In Ireland it still survives in the office of the clerk of the crown and hanaper, from which are issued writs for the return of members of parliament for Ireland.

From "hanaper" is derived the modern "hamper," a wicker or rush basket used for the carriage of game, fish, wine, &c. The verb "to hamper," to entangle, obstruct, hinder, especially used of disturbing the mechanism of a lock or other fastening so as to prevent its proper working, is of doubtful origin. It is probably connected with a root seen in the Icel. *hemja*, to restrain, and Ger. *hemmen*, to clog.

HANAU, a town of Germany, in the Prussian province of Hesse-Nassau, on the right bank of the Main, 14 m. by rail E. from Frankfort and at the junction of lines to Friedberg, Bebra and Aschaffenburg. Pop. (1905) 31,637. It consists of an old and a new town. The streets of the former are narrow and irregular, but the latter, founded at the end of the 16th century by fugitive Walloons and Netherlanders, is built in the form of a pentagon with broad streets crossing at right angles, and possesses several fine squares, among which may be mentioned the market-place, adorned with handsome fountains at the four corners. Among the principal buildings are the ancient castle, formerly the residence of the counts of Hanau; the church of St John, dating from the 17th century, with a handsome tower; the old church of St Mary, containing the burial vault of the counts of Hanau; the church in the new town, built by the Walloons in the beginning of the 17th century in the form of two intersecting circles; the Roman Catholic church, the synagogue, the theatre, the barracks, the arsenal and the hospital. Its educational establishments include a classical school, and a school of industrial art. There is a society of natural history and an historical society, both of which possess considerable libraries and collections. Hanau is the birthplace of the brothers Grimm, to whom a monument was erected here in 1896. In the neighbourhood of the town are the palace of Philippsruhe, with an extensive park and large orangeries, and the spa of Wilhelmsbad.

Hanau is the principal commercial and manufacturing town in the province, and stands next to Cassel in point of population. It manufactures ornaments of various kinds, cigars, leather, paper, playing cards, silver and platinum wares, chocolate, soap, woollen cloth, hats, silk, gloves, stockings, ropes and matches. Diamond cutting is carried on and the town has also foundries, breweries, and in the neighborhood extensive powder-mills. It carries on a large trade in wood, wine and corn, in addition to its articles of manufacture.

From the number of urns, coins and other antiquities found near Hanau it would appear that it owes its origin to a Roman settlement. It received municipal rights in 1393, and in 1528 it was fortified by Count Philip III. who rebuilt the castle. At the end of the 16th century its prosperity received considerable impulse from the accession of the Walloons and Netherlanders. During the Thirty Years' War it was in 1631 taken by the Swedes, and in 1636 it was besieged by the imperial troops, but was relieved on the 13th of June by Landgrave William V. of Hesse-Cassel, on account of which the day is still commemorated by the inhabitants. Napoleon on his retreat from Leipzig defeated the Germans under Marshal Wrede at Hanau, on the 30th of October 1813; and on the following day the allies vacated the town, when it was entered by the French. Early in the 15th century Hanau became the capital of a principality of the Empire, which on the death of Count Reinhard in 1451 was partitioned between the Hanau-Münzenberg and Hanau-Lichtenberg lines, but was reunited in 1642 when the elder line became extinct. The younger line received princely rank in 1606, but as it became extinct in 1736 Hanau-Münzenberg was joined to Hesse-Cassel and Hanau-Lichtenberg to Hesse-Darmstadt. In 1785 the whole province was united to Hesse-Cassel, and in 1803 it became an independent principality. In 1815 it again came into the possession of Hesse-Cassel, and in 1866 it was joined to Prussia.

See R. Wille, *Hanau im dreissigjährigen Krieg* (Hanau, 1886); and Junghaus, *Geschichte der Stadt und des Kreises Hanau* (1887).

HANBURY WILLIAMS, SIR CHARLES (1708-1759), English diplomatist and author, was a son of Major John Hanbury (1664-1734), of Pontypool, Monmouthshire, and a scion of an ancient Worcestershire family. His great-great-grand-

father, Capel Hanbury, bought property at Pontypool and began the family iron-works there in 1565. His father John Hanbury was a wealthy iron-master and member of parliament, who inherited another fortune from his friend Charles Williams of Caerleon, his son's godfather, with which he bought the Coldbrook estate, Monmouthshire. Charles accordingly took the name of Williams in 1729. He went to Eton, and there made friends with Henry Fielding, the novelist, and, after marrying in 1732 the heiress of Earl Coningsby, was elected M.P. for Monmouthshire (1734-1747) and subsequently for Leominster (1754-1759). He became known as one of the prominent gallants and wits about town, and following Pope he wrote a great deal of satirical light verse, including *Isabella, or the Morning* (1740), satires on Ruth Darlington and Pullyey (1741-1742), *The Country Girl* (1742), *Lessons for the Day* (1742), *Letter to Mr Dodsley* (1743), &c. A collection of his poems was published in 1763 and of his *Works* in 1822. In 1746 he was sent on a diplomatic mission to Dresden, which led to further employment in this capacity; and through Henry Fox's influence he was sent as envoy to Berlin (1750), Dresden (1751), Vienna (1753), Dresden (1754) and St Petersburg (1755-1757); in the latter case he was the instrument for a plan for the alliance between England, Russia and Austria, which finally broke down, to his embarrassment. He returned to England, and committed suicide on the 2nd of November 1759, being buried in Westminster Abbey. He had two daughters, the elder of whom married William Capel, 4th earl of Essex, and was the mother of the 5th earl. The Coldbrook estates went to Charles's brother, George Hanbury-Williams, to whose heirs it descended.

See William Coxe's *Historical Tour in Monmouthshire* (1801), and T. Seccombe's article in the *Dict. Nat. Biog.* with bibliography.

HANCOCK, JOHN (1737-1793), American Revolutionary statesman, was born in that part of Braintree, Massachusetts, now known as Quincy, on the 23rd of January 1737. After graduating from Harvard in 1754, he entered the mercantile house of his uncle, Thomas Hancock of Boston, who had adopted him, and on whose death, in 1764, he fell heir to a large fortune and a prosperous business. In 1765 he became a selectman of Boston, and from 1766 to 1772 was a member of the Massachusetts general court. An event which is thought to have greatly influenced Hancock's subsequent career was the seizure of the sloop "Liberty" in 1768 by the customs officers for discharging, without paying the duties, a cargo of Madeira wine consigned to Hancock. Many suits were thereupon entered against Hancock, which, if successful, would have caused the confiscation of his estate, but which undoubtedly enhanced his popularity with the Whig element and increased his resentment against the British government. He was a member of the committee appointed in a Boston town meeting immediately after the "Boston Massacre" in 1770 to demand the removal of British troops from the town. In 1774 and 1775 he was president of the first and second Provincial Congresses respectively, and he shared with Samuel Adams the leadership of the Massachusetts Whigs in all the irregular measures preceding the War of American Independence. The famous expedition sent by General Thomas Gage of Massachusetts to Lexington and Concord on the 18th-19th of April 1775 had for its object, besides the destruction of materials of war at Concord, the capture of Hancock and Adams, who were temporarily staying at Lexington, and these two leaders were expressly excepted in the proclamation of pardon issued on the 12th of June by Gage, their offences, it was said, being "of too flagitious a nature to admit of any other consideration than that of condign punishment." Hancock was a member of the Continental Congress from 1775 to 1780, was president of it from May 1775 to October 1777, being the first to sign the Declaration of Independence, and was a member of the Confederation Congress in 1785-1786. In 1778 he commanded, as major-general of militia, the Massachusetts troops who participated in the Rhode Island expedition. He was a member of the Massachusetts Constitutional Convention of 1779-1780, became the first governor of the state, and served from 1780 to 1785 and again from 1787 until his death. Although

at first unfriendly to the Federal Constitution as drafted by the convention at Philadelphia, he was finally won over to its support, and in 1788 he presided over the Massachusetts convention which ratified the instrument. Hancock was not by nature a leader, but he wielded great influence on account of his wealth and social position, and was liberal, public-spirited, and, as his repeated election—the elections were annual—to the governorship attests, exceedingly popular. He died at Quincy, Mass., on the 8th of October 1793.

See Abram E. Brown, *John Hancock, His Book* (Boston, 1898), a work consisting largely of extracts from Hancock's letters.

HANCOCK, WINFIELD SCOTT (1824-1886), American general, was born on the 14th of February 1824, in Montgomery county, Pa. He graduated in 1844 at the United States Military Academy, where his career was creditable but not distinguished. On the 1st of July 1844 he was breveted, and on the 18th of June 1846 commissioned second lieutenant. He took part in the later movements under Winfield Scott against the city of Mexico, and was breveted first lieutenant for "gallant and meritorious conduct." After the Mexican war he served in the West, in Florida and elsewhere; was married in 1850 to Miss Almira Russell of St Louis; became first lieutenant in 1853, and assistant-quartermaster with the rank of captain in 1855. The outbreak of the Civil War found him in California. At his own request he was ordered east, and on the 23rd of September 1861 was made brigadier-general of volunteers and assigned to command a brigade in the Army of the Potomac. He took part in the Peninsula campaign, and the handling of his troops in the engagement at Williamsburg on the 5th of May 1862, was so brilliant that McClellan reported "Hancock was superb," an epithet always afterwards applied to him. At the battle of Antietam he was placed in command of the first division of the II. corps, and in November he was made major-general of volunteers, and about the same time was promoted major in the regular army. In the disastrous battle of Fredericksburg (*q.v.*), Hancock's division was on the right among the troops that were ordered to storm Marye's Heights. Out of the 5006 men in his division 2013 fell. At Chancellorsville his division received both on the 2nd and the 3rd of May the brunt of the attack of Lee's main army. Soon after the battle he was appointed commander of the II. corps.

The battle of Gettysburg (*q.v.*) began on the 1st of July with the defeat of the left wing of the Army of the Potomac and the death of General Reynolds. About the middle of the afternoon Hancock arrived on the field with orders from Meade to assume command and to decide whether to continue the fight there or to fall back. He decided to stay, rallied the retreating troops, and held Cemetery Hill and Ridge until the arrival of the main body of the Federal army. During the second day's battle he commanded the left centre of the Union army, and after General Sickles had been wounded, the whole of the left wing. In the third day's battle he commanded the left centre, upon which fell the full brunt of Pickett's charge, one of the most famous incidents of the war. Hancock's superb presence and power over men never shone more clearly than when, as the 150 guns of the Confederate army opened the attack he calmly rode along the front of his line to show his soldiers that he shared the dangers of the cannonade with them. His corps lost in the battle 4350 out of less than 10,000 fighting men. But it had captured twenty-seven Confederate battle flags and as many prisoners as it had men when the fighting ceased. Just as the Confederate troops reached the Union line Hancock was struck in the groin by a bullet, but continued in command until the repulse of the attack, and as he was at last borne off the field earnestly recommended Meade to make a general attack on the beaten Confederates. The wound proved a severe one, so that some six months passed before he resumed command.

In the battles of the year 1864 Hancock's part was as important and striking as in those of 1863. At the Wilderness he commanded, during the second day's fighting, half of the Union army; at Spottsylvania he had charge of the fierce and successful attack on the "salient"; at Cold Harbor his corps formed the

left wing in the unsuccessful assault on the Confederate lines. In August he was promoted to brigadier-general in the regular army. In November, his old wound troubling him, he obtained a short leave of absence, expecting to return to his corps in the near future. He was, however, detailed to raise a new corps, and later was placed in charge of the "Middle Division." It was expected that he would move towards Lynchburg, as part of a combined movement against Lee's communications. But before he could take the field Richmond had fallen and Lee had surrendered. It thus happened that Hancock, who for three years had been one of the most conspicuous figures in the Army of the Potomac did not take part in its final triumph.

After the assassination of Lincoln, Hancock was placed in charge of Washington, and it was under his command that Booth's accomplices were tried and executed. In July 1866 he was appointed major-general in the regular army. A little later he was placed in command of the department of the Missouri, and the year following assumed command of the fifth military division, comprising Louisiana and Texas. His policy, however, of discountenancing military trials and conciliating the conquered did not meet with approval at Washington, and he was at his own request transferred. Hancock had all his life been a Democrat. His splendid war record and his personal popularity caused his name to be considered as a candidate for the Presidency as early as 1868, and in 1880 he was nominated for that office by the Democrats; but he was defeated by his Republican opponent, General Garfield, though by the small popular plurality of seven thousand votes. He died at Governor's Island, near New York, on the 9th of February 1886. Hancock was in many respects the ideal soldier of the Northern armies. He was quick, energetic and resourceful, reckless of his own safety, a strict disciplinarian, a painstaking and hard-working officer. It was on the field of battle, and when the fighting was fiercest, that his best qualities came to the front. He was a born commander of men, and it is doubtful if any other officer in the Northern army could get more fighting and more marching out of his men. Grant said of him, "Hancock stands the most conspicuous figure of all the general officers who did not exercise a separate command. He commanded a corps longer than any other, and his name was never mentioned as having committed in battle a blunder for which he was responsible."

A biography of him has been written by General Francis A. Walker (New York, 1894). See also *History of the Second Corps*, by the same author (1886). (F. H. H.)

HANCOCK, a city of Houghton county, Michigan, U.S.A., on Portage Lake, opposite Houghton. Pop. (1890) 1772; (1900) 4050, of whom 1409 were foreign-born; (1904) 6037; (1910) 8081. Hancock is served by the Mineral Range, the Copper Range, the Chicago, Milwaukee & St Paul, and the Duluth, South Shore & Atlantic railways (the last two send their trains in over the Mineral Range tracks), and by steamboats through the Portage Lake Canal which connects with Lake Superior. Hancock is connected by a bridge and an electric line with the village of Houghton (pop. in 1910, 5113), the county-seat of Houghton county and the seat of the Michigan College of Mines (opened in 1886). Hancock has three parks, and a marine and general hospital. The city is the seat of a Finnish Lutheran Seminary—there are many Finns in and near Hancock, and a Finnish newspaper is published here. Hancock is in the Michigan copper region—the Quincy, Franklin and Hancock mines are in or near the city—and the mining, working and shipping of copper are the leading industries; among the city's manufactures are mining machinery, lumber, bricks and beer. The municipality owns and operates the water-works. The electric-lighting plant, the gas plant and the street railway are owned by private corporations. Hancock was settled in 1859, was incorporated as a village in 1875, and was chartered as a city in 1903.

HAND, FERDINAND GOTTHELF (1786-1851), German classical scholar, was born at Plauen in Saxony on the 15th of February 1786. He studied at Leipzig, in 1810 became professor

at the Weimar gymnasium, and in 1817 professor of philosophy and Greek literature in the university of Jena, where he remained till his death on the 14th of March 1851. The work by which Hand is chiefly known is his (unfinished) edition of the treatise of Horatius Tursellinus (Orazio Torsellino, 1545-1599) on the Latin particles (*Tursellinus, seu de particulis Latinis commentarii*, 1820-1845). Like his treatise on Latin style (*Lehrbuch des lateinischen Stils*, 3rd ed. by H. L. Schmitt, 1880), it is too abstruse and philosophical for the use of the ordinary student. Hand was also an enthusiastic musician, and in his *Ästhetik der Tonkunst* (1837-1841) he was the first to introduce the subject of musical aesthetics.

The first part of the last-named work has been translated into English by W. E. Lawson (*Aesthetics of Musical Art, or The Beautiful in Music*, 1880), and B. Sears's *Classical Studies* (1849) contains a "History of the Origin and Progress of the Latin Language," abridged from Hand's work on the subject. There is a memoir of his life and work by G. Queck (Jena, 1852).

HAND, (a word common to Teutonic languages; cf. Ger. *Hand*, Goth. *handus*), the terminal part of the human arm from below the wrist, and consisting of the fingers and the palm. The word is also used of the prehensile termination of the limbs in certain other animals (see **ANATOMY: Superficial and artistic; SKELETON: Appendicular**, and such articles as **MUSCULAR SYSTEM and NERVOUS SYSTEM**). There are many transferred applications of "hand," both as a substantive and in various adverbial phrases. The following may be mentioned: charge or authority, agency, source, chiefly in such expressions as "in the hands of," "by hand," "at first hand." From the position of the hands at the side of the body, the word means "direction," e.g., on the right, left hand, cf. "at hand." The hand as given in betrothal or marriage has been from early times the symbol of marriage as it also is of oaths. Other applications are to labourers engaged in manual occupations, the members of the crew of a ship, to a person who has some special skill, as in the phrase, "old parliamentary hand," and to the pointers of a clock or watch and to the number of cards dealt to each player in a card game. As a measure of length the term "hand" is now only used in the measurement of horses, it is equal to 4 in. The name "hand of glory," is given to a hand cut from the corpse of a hanged criminal, dried in smoke, and used as a charm or talisman, for the finding of treasures, &c. The expression is the translation of the Fr. *main de gloire*, a corruption of the O. Fr. *mandegloire*, *mandegoire*, i.e. *mandragore*, *mandragora*, the mandrake, to the root of which many magical properties are attributed.

HANDEL, GEORGE FREDERICK (1685-1759), English musical composer, German by origin, was born at Halle in Lower Saxony, on the 23rd of February 1685. His name was Händel, but, like most 18th-century musicians who travelled, he compromised with its pronunciation by foreigners, and when in Italy spelt it Hendel, and in England (where he became naturalized) accepted the version Handel, which is therefore correct for English writers, while Händel remains the correct version in Germany. His father was a barber-surgeon, who disapproved of music, and wished George Frederick to become a lawyer. A friend smuggled a clavichord into the attic, and on this instrument, which is inaudible behind a closed door, the little boy practised secretly. Before he was eight his father went to visit a son by a former marriage who was a valet-de-chambre to the duke of Saxe-Weissenfels. The little boy begged in vain to go also, and at last ran after the carriage on foot so far that he had to be taken. He made acquaintance with the court musicians and contrived to practise on the organ when he could be overheard by the duke, who, immediately recognizing his talent, spoke seriously to the father, who had to yield to his arguments. On returning to Halle Handel became a pupil of Zachau, the cathedral organist, who gave him a thorough training as a composer and as a performer on keyed instruments, the oboe and the violin. Six very good trios for two oboes and bass, which Handel wrote at the age of ten, are extant; and when he himself was shown them by an English admirer who had discovered them, he was much amused

and remarked, "I wrote like the devil in those days, and chiefly for the oboe, which was my favourite instrument." His master also of course made him write an enormous amount of vocal music, and he had to produce a motet every week. By the time he was twelve Zachau thought he could teach him no more, and accordingly the boy was sent to Berlin, where he made a great impression at the court.

His father, however, thought fit to decline the proposal of the elector of Brandenburg, afterwards King Frederick I. of Prussia, to send the boy to Italy in order afterwards to attach him to the court at Berlin. German court musicians, as late as the time of Mozart, had hardly enough freedom to satisfy a man of independent character, and the elder Händel had not yet given up hope of his son's becoming a lawyer. Young Handel, therefore, returned to Halle and resumed his work with Zachau. In 1697 his father died, but the boy showed great filial piety in finishing the ordinary course of his education, both general and musical, and even entering the university of Halle in 1702 as a law student. But in that year he succeeded to the post of organist at the cathedral, and after his "probation" year in that capacity he departed to Hamburg, where the only German opera worthy of the name was flourishing under the direction of its founder, Reinhold Keiser. Here he became friends with Matheson, a prolific composer and writer on music. On one occasion they set out together to go to Lübeck, where a successor was to be appointed to the post left vacant by the great organist Buxtehude, who was retiring on account of his extreme age. Handel and Matheson made much music on this occasion, but did not compete, because they found that the successful candidate was required to accept the hand of the elderly daughter of the retiring organist.

Another adventure might have had still more serious consequences. At a performance of Matheson's opera *Cleopatra* at Hamburg, Handel refused to give up the conductor's seat to the composer when the latter returned to his usual post at the harpsichord after singing the part of Antony on the stage. The dispute led to a duel outside the theatre, and, but for a large button on Handel's coat which intercepted Matheson's sword, there would have been no *Messiah* or *Israel in Egypt*. But the young men remained friends, and Matheson's writings are full of the most valuable facts for Handel's biography. He relates in his *Ehrenpforte* that his friend at that time used to compose "interminable cantatas" of no great merit; but of these no traces now remain, unless we assume that a *Passion according to St John*, the manuscript of which is in the royal library at Berlin, is among the works alluded to. But its authenticity, while strongly upheld by Chrysander, has recently been as strongly assailed on internal evidence.

On the 8th of January 1705, Handel's first opera, *Almira*, was performed at Hamburg with great success, and was followed a few weeks later by another work, entitled *Nero*. *Nero* is lost, but *Almira*, with its mixture of Italian and German language and form, remains as a valuable example of the tendencies of the time and of Handel's eclectic methods. It contains many themes used by Handel in well-known later works; but the current statement that the famous aria in *Rinaldo*, "Lascia ch'io pianga," comes from a saraband in *Almira*, is based upon nothing more definite than the inevitable resemblance between the simplest possible forms of saraband-rhythm.

In 1706 Handel left Hamburg for Italy, where he remained for three years, rapidly acquiring the smooth Italian vocal style which hereafter always characterized his work. He had before this refused offers from noble patrons to send him there, but had now saved enough money, not only to support his mother at home, but to travel as his own master. He divided his time in Italy between Florence, Rome, Naples and Venice; and many anecdotes are preserved of his meetings with Corelli, Lotti, Alessandro Scarlatti and Domenico Scarlatti, whose wonderful harpsichord technique still has a direct bearing on some of the most modern features of pianoforte style. Handel soon became famous as *Il Sassone* ("the Saxon"), and it is said that Domenico on first hearing him play incognito exclaimed,

"It is either the devil or the Saxon!" Then there is a story of Corelli's coming to grief over a passage in Handel's overture to *Il Trionfo del tempo*, in which the violins went up to A in altissimo. Handel impatiently snatched the violin to show Corelli how the passage ought to be played, and Corelli, who had never written or played beyond the third position in his life (this passage being in the seventh), said gently, "My dear Saxon, this music is in the French style, which I do not understand." In Italy Handel produced two operas, *Rodrigo* and *Agrippina*, the latter a very important work, of which the splendid overture was remodelled forty-four years afterwards as that of his last original oratorio, *Jephtha*. He also produced two oratorios, *La Resurrezione*, and *Il Trionfo del tempo*. This, forty-six years afterwards, formed the basis of his last work. *The Triumph of Time and Truth*, which contains no original matter. All Handel's early works contain material that he used often with very little alteration later on, and, though the famous "Lascia ch'io pianga" does not occur in *Almira*, it occurs note for note in *Agrippina* and the two Italian oratorios. On the other hand the cantata *Acis, Galatea e Polifemo* has nothing in common with *Acis and Galatea*. Besides these larger works there are several choral and solo cantatas of which the earliest, such as the great *Dixit Dominus*, show in their extravagant vocal difficulty how radical was the change which Handel's Italian experience so rapidly effected in his methods.

Handel's success in Italy established his fame and led to his receiving at Venice in 1709 the offer of the post of Kapellmeister to the elector of Hanover, transmitted to him by Baron Kielmansegge, his patron and staunch friend of later years. Handel at the time contemplated a visit to England, and he accepted this offer on condition of leave of absence being granted to him for that purpose. To England accordingly Handel journeyed after a short stay at Hanover, arriving in London towards the close of 1710. He came as a composer of Italian opera, and earned his first success at the Haymarket with *Rinaldo*, composed, to the consternation of the hurried librettist, in a fortnight, and first performed on the 24th of February 1711. In this opera the aria "Lascia ch'io pianga" found its final home. The work was produced with the utmost magnificence, and Addison's delightful reviews of it in the *Spectator* poked fun at it from an unmusical point of view in a way that sometimes curiously foreshadows the criticisms that Gluck might have made on such things at a later period. The success was so great, especially for Walsh the publisher, that Handel proposed that Walsh should compose the next opera, and that he should publish it. He returned to Hanover at the close of the opera season, and composed a good deal of vocal chamber music for the princess Caroline, the step-daughter of the elector, besides the instrumental works known to us as the oboe concertos. In 1712 Handel returned to London and spent a year with Andrews, a rich musical amateur, in Barn Elms, Surrey. Three more years were spent in Burlington, in the neighbourhood of London. He evidently was but little inclined to return to Hanover, in spite of his duties to the court there. Two Italian operas and the *Utrecht Te Deum* written by the command of Queen Anne are the principal works of this period. It was somewhat awkward for the composer when his deserted master came to London in 1714 as George I. of England. For some time Handel did not venture to appear at court, and it was only at the intercession of Baron Kielmansegge that his pardon was obtained. By his advice Handel wrote the *Water Music* which was performed at a royal water party on the Thames, and it so pleased the king that he at once received the composer into his good graces and granted him a salary of £400 a year. Later Handel became music master to the little princesses and was given an additional £200 by the princess Caroline. In 1716 he followed the king to Germany, where he wrote a second German Passion to the popular poem of Brockes, a text which, divested of its worst features, forms the basis of several of the arias in Bach's *Passion according to St. John*. This was Handel's last work to a German text.

On his return to England he entered the service of the duke

of Chandos as conductor of his concerts, receiving a thousand pounds for his first oratorio *Esther*. The music which Handel wrote for performance at "Cannons," the duke of Chandos's residence at Edgware, is comprised in the first version of *Esther*, *Acis and Galatea*, and the twelve *Chandos Anthems*, which are compositions approximately in the same form as Bach's church cantatas but without any systematic use of chorale tunes. The fashionable Londoner would travel 9 miles in those days to the little chapel of Whitchurch to hear Handel's music, and all that now remains of the magnificent scene of these visits is the church, which is the parish church of Edgware. In 1720 Handel appeared again in a public capacity as impresario of the Italian opera at the Haymarket theatre, which he managed for the institution called the Royal Academy of Music. Senesino, a famous singer, to engage whom Handel especially journeyed to Dresden, was the mainstay of the enterprise, which opened with a highly successful performance of Handel's opera *Radamisto*. To this time belongs the famous rivalry between Handel and Buononcini, a melodious Italian composer whom many thought to be the greater of the two. The controversy has been perpetuated in John Byrom's lines:

"Some say, compared to Buononcini
That Mynheer Handel's but a ninny;
Others aver that he to Handel
Is scarcely fit to hold a candle.
Strange all this difference should be
T'wixt tweedle-dum and tweedle-dee."

It must be remembered that at this time Handel had not yet asserted his greatness as a choral writer; the fashionable ideas of music and musicianship were based entirely upon success in Italian opera, and the contest between the rival composers was waged on the basis of works which have fallen into almost as complete an oblivion in Handel's case as in Buononcini's. None of Handel's forty-odd Italian operas can be said to survive, except in some two or three detached arias out of each opera; arias which reveal their essential qualities far better in isolation than when performed in groups of between twenty and thirty on the stage, as interruptions to the action of a classical drama to which nobody paid the slightest attention. But even within these limits Handel's artistic resources were too great to leave the issue in doubt; and when Handel wrote the third act of an opera *Musio Scevola*, of which Buononcini and Ariosti¹ wrote the other two, his triumph was decisive, especially as Buononcini soon got into discredit by failing to defend himself against the charge of producing as a prize-madrigal of his own a composition which proved to be by Lotti. At all events Buononcini left London, and Handel for the next ten years was without a rival in his ventures as an operatic composer. He was not, however, without a rival as an impresario; and the hostile competition of a rival company which obtained the services of the great Farinelli and also induced Senesino to desert him, led to his bankruptcy in 1737, and to an attack of paralysis caused by anxiety and overwork. The rival company also had to be dissolved from want of support, so that Handel's misfortunes must not be attributed to any failure to maintain his position in the musical world. Handel's artistic conscience was that of the most easy-going opportunist, or he would never have continued till 1741 to work in a field that gave so little scope for his genius. But the public seemed to want operas, and, if opera had no scope for his genius, at all events he could supply better operas with greater rapidity and ease than any three other living composers working together. And this he naturally continued to do so long as it seemed to be the best way to keep up his reputation. But with all this artistic opportunism he was not a man of tact, and there are numerous stories of the type of his holding the great prima donna Cuzzoni at arm's-length out of a window and threatening to drop her unless she consented to sing a song which she had declared unsuitable to her style.

Already before his last opera, *Deidamia*, produced in 1741, Handel had been making a growing impression with his oratorios.

¹ Chrysander says Mattei instead of Ariosti.

In these, freed from the restrictions of the stage, he was able to give scope to his genius for choral writing, and so to develop, or rather revive, that art of chorus singing which is the normal outlet for English musical talent. In 1726 Handel had become a naturalized Englishman, and in 1733 he began his public career as a composer of English texts by producing the second and larger version of *Esther* at the King's theatre. This was followed early in the same year by *Deborah*, in which the share of the chorus is much greater. In July he produced *Athalia* at Oxford, the first work in which his characteristic double choruses appear. The share of the chorus increases in *Saul* (1738); and *Israel in Egypt* (also 1738) is practically entirely a choral work, the solo movements, in spite of their fame, being as perfunctory in character as they are few in number. It was not unnatural that the public, who still considered Italian opera the highest, because the most modern form of musical art, obliged Handel at subsequent performances of this gigantic work to insert more solos.

The *Messiah* was produced at Dublin on the 13th of April 1742. *Samson* (which Handel preferred to the *Messiah*) appeared at Covent Garden on the 2nd of March 1744; *Belshazzar* at the King's theatre, 27th of March 1745; the *Occasional Oratorio* (chiefly a compilation of the earlier oratorios, but with a few important new numbers), on the 14th of February 1746 at Covent Garden, where all his later oratorios were produced; *Judas Maccabaeus* on the 1st of April 1747; *Joshua* on the 9th of March 1748; *Alexander Balus* on the 23rd of March 1748; *Solomon* on the 17th of March 1749; *Susanna*, spring of 1749; *Theodora*, a great favourite of Handel's, who was much disappointed by its cold reception, on the 16th of March 1750; *Jephtha* (strictly speaking, his last work) on the 26th of February 1752, and *The Triumph of Time and Truth* (transcribed from *Il Trionfo del tempo* with the addition of many later favourite numbers), 1757. Other important works, indistinguishable in artistic form from oratorios, but on secular subjects, are *Alexander's Feast*, 1736; *Ode for St Cecilia's Day* (words by Dryden); *L'Allegro, il penseroso ed il moderato* (the words of the third part by Jennens), 1740; *Semele*, 1744; *Hercules*, 1745; and *The Choice of Hercules*, 1751.

By degrees the enmity against Handel died away, though he had many troubles. In 1745 he had again become bankrupt; for, although he had no rival as a composer of choral music it was possible for his enemies to give balls and banquets on the nights of his oratorio performances. As with his first bankruptcy, so in his later years, he showed scrupulous sense of honour in discharging his debts, and he continued to work hard to the end of his life. He had not only completely recovered his financial position by the year 1750, but he must have made a good deal of money, for he then presented an organ to the Foundling Hospital, and opened it with a performance of the *Messiah* on the 15th of May. In 1751 his sight began to trouble him; and the autograph of *Jephtha*, published in facsimile by the *Händelgesellschaft*, shows pathetic traces of this in his handwriting,¹ and so affords a most valuable evidence of his methods of composition, all the accompaniments, recitatives, and less essential portions of the work being evidently filled in long after the rest. He underwent unsuccessful operations, one of them by the same surgeon who had operated on Bach's eyes. There is evidence that he was able to see at intervals during his last years, but his sight practically never returned after May 1752. He continued superintending performances of his works and writing new arias for them, or inserting revised old ones, and he attended a performance of the *Messiah* a week before his death, which took place, according to the *Public Advertiser* of the 16th of April, not on Good Friday, the 13th of April, according to his own pious wish and according to common report, but on the 14th of April 1759. He was buried in Westminster Abbey; and his monument is by L. F. Roubilliac,

¹ By a dramatic coincidence Handel's blindness interrupted him during the writing of the chorus, "How dark, oh Lord, are Thy decrees, . . . all our joys to sorrow turning . . . as the night succeeds the day."

the same sculptor who modelled the marble statue erected in 1739 in Vauxhall Gardens, where his works had been frequently performed.

Handel was a man of high character and intelligence, and his interest was not confined to his own art exclusively. He liked the society of politicians and literary men, and he was also a collector of pictures and articles of *vertu*. His power of work was enormous, and the *Händelgesellschaft's* edition of his complete works fills one hundred volumes, forming a total bulk almost equal to the works of Bach and Beethoven together. (F. H.; D. F. T.)

No one has more successfully popularized the greatest artistic ideals than Handel; no artist is more disconcerting to critics who imagine that a great man's mental development is easy to follow. Not even Wagner effected a greater transformation in the possibilities of dramatic music than Handel effected in oratorio, yet we have seen that Handel was the very opposite of a reformer. He was not even conservative, and he hardly took the pains to ascertain what an art-form was, so long as something externally like it would convey his idea. But he never failed to convey his idea, and, if the hybrid forms in which he conveyed it had no historic influence and no typical character, they were none the less accurate in each individual case. The same aptness and the same absence of method are conspicuous in his style. The popular idea that Handel's style is easily recognizable comes from the fact that he overshadows all his predecessors and contemporaries, except Bach, and so makes us regard typical 18th-century Italian and English style as Handelian, instead of regarding Handel's style as typical Italian 18th-century. Nothing in music requires more minute expert knowledge than the sifting of the real peculiarities of Handel's style from the mass of contemporary formulae which in his inspired pages he absorbed, and which in his uninspired pages absorbed him.

His easy mastery was acquired, like Mozart's, in childhood. The later sonatas for two voices and bass which he wrote in his eleventh year are, except in their diffuseness and an occasional slip in grammar, indistinguishable from his later works, and they show a boyish inventiveness worthy of Mozart's work at the same age. Such early choral works, as the *Dixit Dominus* (1707), show the ill-regulated power of his choral writing before he assimilated Italian influences. Its practical difficulties are at least as extravagant as Bach's, while they are not accounted for by any corresponding originality and necessity of idea; but the grandeur of the scheme and nobility of thought is already that for which Handel so often in later years found the simplest and easiest adequate means of expression that music has ever attained. His eminently practical genius soon formed his vocal style, and long before the period of his great oratorios, such works as *The Birthday Ode for Queen Anne* (1713) and the *Utrecht Te Deum* show not a trace of German extravagance. The only drawback to his practical genius was that it led him to bury perhaps half of his finest melodies, and nearly all the secular features of interest in his treatment of instruments and of the aria forms, in that deplorable limbo of vanity, the 18th-century Italian opera. It is not true, as has been alleged against him, that his operas are in no way superior to those of his contemporaries; but neither is it true that he stirred a finger to improve the condition of dramatic musical art. He was no slave to singers, as is amply testified by many anecdotes. Nor was he bound by the operatic conventions of the time. In *Teseo* he not only wrote an opera in five acts when custom prescribed three, but also broke a much more plausible rule in arranging that each character should have two arias in succession. He also showed a feeling for expression and style which led him to write arias of types which singers might not expect. But he never made any innovation which had the slightest bearing upon the stage-craft of opera, for he never concerned himself with any artistic question beyond the matter in hand; and the matter in hand was not to make dramatic music, or to make the story interesting or intelligible, but simply to provide a concert of between some twenty and thirty Italian arias and duets, wherein singers could display their abilities and spectators find distraction from the monotony of so large a dose of the aria form (which

was then the only possibility for solo vocal music) in the gorgeousness of the dresses and scenery.

When the question arose how a musical entertainment of this kind could be managed in Lent without protests from the bishop of London, Handelian oratorio came into being as a matter of course. But though Handel was an opportunist he was not shallow. His artistic sense seized upon the natural possibilities which arose as soon as the music was transferred from the stage to the concert platform; and his first English oratorio, *Esther* (1720), beautifully shows the transition. The subject is as nearly secular as any that can be extracted from the Bible, and the treatment was based on Racine's *Esther*, which was much discussed at the time. Handel's oratorio was reproduced in an enlarged version in 1732 at the King's theatre: the princess royal wished for scenery and action, but the bishop of London protested. And the choruses, of which in the first version there are already no less than ten, are on the one hand operatic and unecclesiastical in expression, until the last, where polyphonic work on a large scale first appears; but on the other hand they are all much too long to be sung by heart, as is necessary in operas. In fact, the turning-point in Handel's development is the emancipation of the chorus from theatrical limitations. This had as great effect upon his few but important secular English works as upon his other oratorios. *Acis and Galatea*, *Semele* and *Hercules*, are in fact secular oratorios; the choral music in them is not ecclesiastical, but it is large, independent and polyphonic.

We must remember, then, that Handel's scheme of oratorio is operatic in its origin and has no historic connexion with such principles as might have been generalized from the practice of the German Passion music of the time; and it is sufficiently astonishing that the chorus should have so readily assumed its proper place in a scheme which the public certainly regarded as a sort of Lenten biblical opera. And, although the chorus owes its freedom of development to the disappearance of theatrical necessities, it becomes no less powerful as a means of dramatic expression (as opposed to dramatic action) than as a purely musical resource. Already in *Athalie* the "Hallelujah" chorus at the end of the first act is a marvel of dramatic truth. It is sung by Israelites almost in despair beneath usurping tyranny; and accordingly it is a severe double fugue in a minor key, expressive of devout courage at a moment of depression. On purely musical grounds it is no less powerful in throwing into the highest possible relief the ecstatic solemnity of the psalm with which the second act opens. Now this sombre "Hallelujah" chorus is a very convenient illustration of Handel's originality, and the point in which his creative power really lies. It was not originally written for its situation in *Athalie*, but it was chosen for it. It was originally the last chorus of the second version of the anthem, *As pants the Hart*, from the autograph of which it is missing because Handel cut out the last pages in order to insert them into the manuscript of *Athalie*. The inspiration in *Athalie* thus lies not in the creation of the chorus itself, but in the choice of it.

In choral music Handel made no more innovation than he made in arias. His sense of fitness in expression was of little use to him in opera, because opera could not become dramatic until musical form became capable of developing and blending emotions in all degrees of climax in a way that may be described as pictorial and not merely decorative (see MUSIC; SONATA-FORMS; and INSTRUMENTATION). But in oratorio there was not the least necessity for reforming any art-forms. The ordinary choral resources of the time had perfect expressive possibilities where there were no actors to keep waiting, and where no dresses and scenery need distract the attention of the listener. When lastly, ordinary decorum dictated an attitude of reverent attention towards the subject of the oratorio, then the man of genius could find such a scope for his real sense of dramatic fitness as would make his work immortal.

In estimating Handel's greatness we must think away all orthodox musical and progressive prejudices, and learn to apply the lessons critics of architecture and some critics of literature

seem to know by nature. Originality, in music as in other arts, lies in the whole, and in a sense of the true meaning of every part. When Handel wrote a normal double fugue in a minor key on the word "Hallelujah" he showed that he at all events knew what a vigorous and dignified thing an 18th-century double fugue could be. In putting it at the end of a melancholy psalm he showed his sense of the value of the minor mode. When he put it in its situation in *Athalie* he showed as perfect a sense of dramatic and musical fitness as could well be found in art. Now it is obvious that in works like oratorios (which are dramatic schemes vigorously but loosely organized by the putting together of some twenty or thirty complete pieces of music) the proper conception of originality will be very different from that which animates the composer of modern lyric, operatic or symphonic music. When we add to this the characteristics of a method like Handel's, in which musical technique has become a masterly automatism, it becomes evident that our conception of originality must be at least as broad as that which we would apply in the criticism of architecture. The disadvantages of the want of such a conception have been aggravated by the dearth of general knowledge of the structure of musical art; a knowledge which shows that the parallel we have suggested between music and architecture, as regards the nature of originality, is no mere figure of speech.

In every art there is an antithesis between form and matter, which becomes reconciled only when the work of art is perfect in its execution. And, whatever this perfection, the antithesis must always remain in the mind of the artist and critic to this extent, that some part of the material seems to be the special subject of technical rule rather than another. In the plastic and literary arts one type of this antithesis is more or less permanently maintained in the relation between subject and treatment. The mere fact that these arts express themselves by representing things that have some previous independent existence, helps us to look for originality rather in the things that make for perfection of treatment than in novelty of subject. But in music we have no permanent means of deciding which of many aspects we shall call the subject and which the treatment. In the 16th century the a priori form existed mainly in the practice of basing almost every melodic detail of the work on phrases of Gregorian chant or popular song, treated for the most part in terms of very definitely regulated polyphonic design, and on harmonic principles regulated in almost every detail by the relation between the melodic aspects of the church modes and the necessity for occasional alterations of the strict mode to secure finality at the close. In modern music such a relation between form and matter, prescribing as it does for every aspect at every moment both of the shape and the texture of the music, would exclude the element of invention altogether. In 16th-century music it by no means had that effect. An inventive 16th-century composer is as clearly distinguishable from a dull one as a good architect from a bad. The originality of the composer resides, in 16th-century music as in all art, in his whole work; but naturally his conception of property and ideas will not extend to themes or isolated passages. That man is entitled to an idea who can show what it means, or who can make it mean what he likes. Let him wear the giant's robe if it fits him. And it is merely a local difference in point of view which makes us think that there is property in themes and no property in forms. Nowadays we happen to regard the shape of a whole composition as its form, and its theme as its matter. And, as artistic organization becomes more complex and heterogeneous, the need of the broadest and most forcible possible outline of design is more pressingly felt; so that in what we choose to call form we are willing to sacrifice all conception of originality for the sake of general intelligibility, while we insist upon complete originality in those thematic details which we are pleased to call matter. But, if this explains, it does not excuse our setting up a criterion for musical originality which can be accepted by no intelligent critics of other arts, and which is completely upset by the study of any music earlier than the beginning of the 19th century.

The difficulty many writers have found in explaining the subject of Handel's "plagiarisms" is not entirely accounted for by mere lack of these considerations; but the grossest confusion of ideas as to the difference between cases in point prevails to this day, and many discussions which have been raised in regard to the ethical aspect of the question are frankly absurd.¹ It has been argued, for instance, that great injustice was done to Buononcini over his unfortunate affair with the prize madrigal, while his great rival was allowed the credit of *Israel in Egypt*, which contains a considerable number of entire choruses (besides hosts of themes) by earlier Italian and German writers. But the very idea of Handelian oratorio is that of some three hours of music, religious or secular, arranged, like opera, in the form of a colossal entertainment, and with high dramatic and emotional interest imparted to it, if not by the telling of a story, at all events by the nature and development of the subject. It seems, moreover, to be entirely overlooked that the age was an age of *pasticcios*. Nothing was more common than the organization of some such solemn entertainment by the skilful grouping of favourite pieces. Handel himself never revived one of his oratorios without inserting in it favourite pieces from his other works as well as several new numbers; and the story is well known that the turning point in Gluck's career was his perception of the true possibilities of dramatic music from the failure of a *pasticcio* in which he had reset some rather definitely expressive music to situations for which it was not originally designed. The success of an oratorio was due to the appropriateness of its contrasts, together of course with the mastery of its detail, whether that detail were new or old; and there are many gradations between a *réchauffé* of an early work like *The Triumph of Time and Truth*, or a *pasticcio* with a few original numbers like the *Occasional Oratorio*, and such works as *Samson*, which was entirely new except that the "Dead March" first written for it was immediately replaced by the more famous one imported from *Saul*. That the idea of the *pasticcio* was extremely familiar to the age is shown by the practice of announcing an oratorio as "new and original," a term which would obviously be meaningless if it were as much a matter of course as it is at the present day, and which, if used at all, must obviously so apply to the whole work without forbidding the composer from gratifying the public with the reproduction of one or two favourite arias. But of course the question of originality becomes more serious when the imported numbers are not the composer's own. And here it is very noticeable that Handel derived no credit, either with his own public or with us, from whole movements that are not of his own designing. In *Israel in Egypt*, the choruses "Egypt was glad when they departed," "And I will exalt Him," "Thou sentest forth Thy Wrath" and "The Earth swallowed them," are without exception the most colourless and unattractive pieces of severe counterpoint to be found among Handel's works; and it is very difficult to fathom his motive in copying them from obscure pieces by Erba and Kaspar Kerl, unless it be that he wished to train his audiences to a better understanding of a polyphonic style. He certainly felt that the greatest possibilities of music lay in the higher choral polyphony, and so in *Israel in Egypt* he designed a work consisting almost entirely of choruses, and may have wished in these instances for severe contrapuntal movements which he had not time to write, though he could have done them far better himself. Be this as it may, these choruses have certainly added nothing to the "moral" question has been raised afresh in reviews of Mr Sedley Taylor's admirable volume of analysed illustrations (*The Indebtedness of Handel in works of other Composers*, Cambridge, 1906). The latest argument is that Handel shows moral obliquity in borrowing "regrettably" from sources no one could know at the time. This reasoning makes it mysterious that a man of such moral obliquity should ever have written a note of his own music in England when he could have stolen the complete choral works of Bach and most of the hundred operas of Alessandro Scarlatti with the certainty that the sources would not be printed for a century after his death, even if his own name did not then check curiosity among antiquarians. Of course Handel's plagiarisms would have damaged his reputation if contemporaries had known of them. His polyphonic scholarship was more "antiquated" in the 18th century than it is in the 20th.

to the popularity of a work of which the public from the outset complained that there was not enough solo music; and what effect they have is merely to throw Handel's own style into relief. To draw any parallel between the theft of such unattractive details in the grand and intensely Handelian scheme of *Israel in Egypt* and Buononcini's alleged theft of a prize madrigal is merely ridiculous. Handel himself, if he had any suspicion that contemporaries did not take a sane architect's view of the originality of large musical schemes,² probably gave himself no more trouble about their scruples on this matter than about other forms of musical banality.

The *History of Music* by Burney, the cleverest and most refined musical critic of the age, shows in the very freshness of its musical scholarship how completely unscholarly were the musical ideas of the time. Burney was incapable of regarding choral music as other than a highly improving academic exercise in which he himself was proficient; and for him Handel is the great opera-writer whose choral music will reward the study of the curious. If Handel had attempted to explain his methods to the musicians of his age, he would probably have found himself alone in his opinions as to the property of musical ideas. He did not trouble to explain, but he made no concealment of his sources. He left his whole musical library to his copyist, and it was from this that the sources of his work were discovered. And when the whole series of plagiarisms is studied, the fact forces itself upon us that nothing except themes and forms which are common property in all 18th-century music, has yet been discovered as the source of any work of Handel's which is not felt as part of a larger design. Operatic arias were never felt as parts of a whole. The opera was a concert on the stage, and it stood or fell, not by a dramatic propriety which it notoriously neglected to consider at all, but by the popularity of its arias. There is no aria in Handel's operas which is traceable to another composer. Even in the oratorios there is no solo number in which more than the themes are pilfered, for in oratorios the solo work still appealed to the popular criterion of novelty and individual attractiveness. And when we leave the question of copying of whole movements and come to that of the adaptation of passages, and still more of themes, Handel shows himself to be simply on a line with Mozart. Jahn compares the opening of Mozart's *Requiem* with that of the first chorus in Handel's *Funeral Anthem*. Mozart recreates at least as much from Handel's already perfect framework as Handel ever idealized from the inorganic fragments of earlier writers. The double counterpoint of the Kyrie in Mozart's *Requiem* is still more indisputably identical with that of the last chorus of Handel's *Joseph*, and if the themes are common property their combination certainly is not. But the true plagiarist is the man who does not know the meaning of the ideas he copies, and the true creator is he in whose hands they remain or become true ideas. The theme "He led them forth like sheep" in the chorus "But as for his people" is one of the most beautiful in Handel's works, and the bare statement that it comes from a serenata by Stradella seems at first rather shocking. But, to any one who knew Stradella's treatment of it first, Handel's would come as a revelation actually greater than if he had never heard the theme before. Stradella makes nothing more of it, and therefore presumably sees nothing more in it than an agreeable and essentially frivolous little tune which lends itself to comic dramatic purpose by a wearisome repetition throughout eight pages of patchy aria and instrumental ritornello at an ever-increasing pace. What Handel sees in it is what he makes of it, one of the most solemn and poetic things in music. Again, it may be very shocking to discover that the famous opening of the "Hailstone chorus" comes from the patchy and facetious overture to this same serenata, with which it is identical for ten bars all in the tonic chord (representing, according to Stradella, someone knocking at a door). And it is no doubt yet more shocking that the chorus "He spake the word, and

² Much light would be thrown on the subject if some one sufficiently ignorant of architecture were to make researches into Sir Christopher Wren's indebtedness to Italian architects!

there came all manner of flies" contains no idea of Handel's own except the realistic swarming violin-passages, the general structure, and the vocal colouring; whereas the rhythmic and melodic figures of the voice parts come from an equally patchy *sinfonica concertata* in Stradella's work. The real interest of these things ought not to be denied either by the misstatement that the materials adapted are mere common property, nor by the calumny that Handel was uninventive.

The effects of Handel's original inspiration upon foreign material are really the best indication of the range of his style. The comic meaning of the broken rhythm of Stradella's overture becomes indeed Handel's inspiration in the light of the gigantic tone-picture of the "Hailstone chorus." In the theme of "He led them forth like sheep" we have already cited a particular case where Handel perceived great solemnity in a theme originally intended to be frivolous. The converse process is equally instructive. In the short Carillon choruses in *Saul* where the Israelitish women welcome David after his victory over Goliath, Handel uses a delightful instrumental tune which stands at the beginning of a *Te Deum* by Urio, from which he borrowed an enormous amount of material in *Saul*, *L'Allegro*, the *Dettingen Te Deum* and other works. Urio's idea is first to make a jubilant and melodious noise from the lower register of the strings, and then to bring out a flourish of high trumpets as a contrast. He has no other use for his beautiful tune, which indeed would not bear more elaborate treatment than he gives it. The ritornello falls into statement and counterstatement, and the counterstatement secures one repetition of the tune, after which no more is heard of it. It has none of the solemnity of church music, and its value as a contrast to the flourish of trumpets depends, not upon itself, but upon its position in the orchestra. Handel did not see in it a fine opening for a great ecclesiastical work, but he saw in it an admirable expression of popular jubilation, and he understood how to bring out its character with the liveliest sense of climax and dramatic interest by taking it at its own value as a popular tune. So he uses it as an instrumental interlude accompanied with a jingle of carillons, while the daughters of Israel sing to a square-cut tune those praises of David which aroused the jealousy of Saul. But now turn to the opening of the *Dettingen Te Deum* and see what splendid use is made of the other side of Urio's idea, the contrast between a jubilant noise in the lowest part of the scale and the blaze of trumpets at an extreme height. In the fourth bar of the *Dettingen Te Deum* we find the same florid trumpet figures as we find in the fifth bar of Urio's, but at the first moment they are on oboes. The first four bars beat a tattoo on the tonic and dominant, with the whole orchestra, including trumpets and drums, in the lowest possible position and in a stirring rhythm with a boldness and simplicity characteristic only of a stroke of genius. Then the oboes appear with Urio's trumpet flourishes; the momentary contrast is at least as brilliant as Urio's; and as the oboes are immediately followed by the same figures on the trumpets themselves the contrast gains incalculably in subtlety and climax. Moreover, these flourishes are more melodious than the broad and massive opening, instead of being, as in Urio's scheme, incomparably less so. Lastly, Handel's primitive opening rhythmic figures inevitably underlie every subsequent inner part and bass that occurs at every half close and full close throughout the movement, especially where the trumpets are used. And thus every detail of his scheme is rendered alive with a rhythmic significance which the elementary nature of the theme prevents from ever becoming obtrusive.

No other great composer has ever so overcrowded his life with occasional and mechanical work as Handel, and in no other artist are the qualities that make the difference between inspired and uninspired pages more difficult to analyse. The libretti of his oratorios are full of absurdities, except when they are derived in every detail from Scripture, as in the *Messiah* and *Israel in Egypt*, or from the classics of English literature, as in *Samson* and *L'Allegro*. These absurdities, and the obvious fact that in every oratorio Handel writes many more numbers than

are desirable for one performance, and that he was continually in later performances adding, transferring and cutting out solo numbers and often choruses as well—all this may seem at first sight to militate seriously against the view that Handel's originality and greatness consists in his grasp of the works as wholes, but in reality it strengthens that view. These things militate against the perfection of the whole, but they would have been absolutely fatal to a work of which the whole is not (as in all true art) greater than the sum of its parts. That they are felt as absurdities and defects already shows that Handel created in English oratorio a true art-form on the largest possible scale.

There never has been a time when Handel has been overrated, except in so far as other composers have been neglected. But no composer has suffered so much from pious misinterpretation and the popular admiration of misleading externals. It is not the place here to dilate upon the burial of Handel's art beneath the "mammoth" performances of the Handel Festivals at the Crystal Palace; nor can we give more than a passing reference to the effects of "additional accompaniments" in the style of an altogether later age, started most unfortunately by Mozart (whose share in the work has been very much misinterpreted and corrupted) and continued in the middle of the 19th century by musicians of every degree of intelligence and refinement, until all sense of unity of style has been lost and does not seem likely to be recovered as a general element in the popular appreciation of Handel for some time to come. But in spite of this, Handel will never cease to be revered and loved as one of the greatest of composers, if we value the criteria of architectonic power, a perfect sense of style, and the power to rise to the most sublime height of musical climax by the simplest means.

Handel's important works have all been mentioned above with their dates, and a separate detailed list does not seem necessary. He was an extremely rapid worker, and his later works are dated almost day by day as they proceed. From this we learn that the *Messiah* was sketched and scored within twenty-one days, and that even *Jephtha*, with an interruption of nearly four months besides several other delays caused by Handel's failing sight, was begun and finished within seven months, representing hardly five weeks' actual writing. Handel's extant works may be roughly summarized from the edition of the *Händelgesellschaft* as 41 Italian operas, 2 Italian oratorios, 2 German Passions, 18 English oratorios, 4 English secular oratorios, 4 English secular cantatas, and a few other small works, English and Italian, of the type of oratorio or incidental dramatic music; 3 Latin settings of the *Te Deum*; the (English) *Dettingen Te Deum* and *Ulrecht Te Deum and Jubilate*; 4 coronation anthems; 3 volumes of English anthems (*Chandos Anthems*); 1 volume of Latin church music; 3 volumes of Italian vocal chamber-music; 1 volume of clavier works; 37 instrumental duets and trios (*sonatas*), and 4 volumes of orchestral music and organ concertos (about 40 works). Precise figures are impossible as there is no means of drawing the line between *posticcios* and original works. The instrumental pieces especially are used again and again as overtures to operas and oratorios and anthems.

The complete edition of the German *Händelgesellschaft* suffers from being the work of one man who would not recognize that his task was beyond any single man's power. The best arrangements of the vocal scores are undoubtedly those published by Novello that are not based on "additional accompaniments." None is absolutely trustworthy, and those of the editor of the German *Händelgesellschaft* are sad proofs of the uselessness of expert library-scholarship without a sound musical training. Yet Chrysander's services in the restoration of Handel are beyond praise. We need only mention his discovery of authentic trombone parts in *Israel in Egypt* as one among many of his priceless contributions to musical history and aesthetics. (D. F. T.)

HANDFASTING (A.S. *handfastnung*, pledging one's hand), primarily the O. Eng. synonym for *betwot* (*q.v.*), and later a peculiar form of temporary marriage at one time common in Scotland, the only necessary ceremony being the verbal pledge of the couple while holding hands. The pair thus handfasted were, in accordance with Scotch law, entitled to live together for a year and a day. If then they so wished, the temporary marriage could be made permanent; if not, they could go their several ways without reproach, the child, if any, being supported by the party who objected to further cohabitation.

HANDICAP (from the expression *hand in cap*, referring to drawing lots), a disadvantageous condition imposed upon the

superior competitor in sports and games, or an advantage allowed the inferior, in order to equalize the chances of both. The character of the handicap depends upon the nature of the sport. Thus in horse-racing the better horse must carry the heavier weight. In foot races the inferior runners are allowed to start at certain distances in advance of the best (or "scratch") man, according to their previous records. In distance competitions (weights, fly-casting, jumping, &c.) the inferior contestants add certain distances to their scores. In time contests (yachting, canoe-racing, &c.) the weaker or smaller competitors subtract certain periods of time from that actually made, reckoned by the mile. In stroke contests (e.g. golf) a certain number of strokes are subtracted from or added to the scores, according to the strength of the players. In chess and draughts the stronger competitor may play without one or more pieces. In court games (tennis, lawn-tennis, racquets, &c.) and in billiards certain points, or percentage of points, are accorded the weaker players.

Handicapping was applied to horse-racing as early as 1680, though the word was not used in this connexion much before the middle of the 18th century. A "Post and Handy-Cap Match" is described in *Pond's Racing Calendar for 1754*. A reference to something similar in Germany and Scandinavia, called *Freimark*, may be found in *Germania*, vol. xix.

Competitions in which handicaps are given are called *handicaps* or *handicaps*. There are many systems which depend upon the whim of the individual competitors. Thus a tennis player may offer to play against his inferior with a *selzer-bottle* instead of a racquet; or a golfer to play with only one club; or a chess-player to make his moves without seeing the board.

The name "handicap" was taken from an ancient English game, to which Pepys, in his *Diary* under the date of the 18th of September 1660, thus refers: "Here some of us fell to handicap, a sport that I never knew before, which was very good." This game, which became obsolete in the 19th century, was described as early as the 14th in *Piers the Plowman* under the name of "New Faire." It was originally played by three persons, one of whom proposed to "challenge," or exchange, some piece of property belonging to another for something of his own. The challenge being accepted an umpire was chosen, and all three put up a sum of money as a forfeit. The two players then placed their right hands in a cap, or in their pockets, in which there was loose money, while the umpire proceeded to describe the two objects of exchange, and to declare what sum of money the owner of the inferior article should pay as a bonus to the other. This declaration was made as rapidly as possible and ended with the invitation, "Draw, gentlemen!" Each player then withdrew and held out his hand, which he opened. If both hands contained money the exchange was effected according to the conditions laid down by the umpire, who then took the forfeit money for himself. If neither hand contained money the exchange was declined and the umpire took the forfeit money. If only one player signified his acceptance of the exchange by holding money in his hand, he was entitled to the forfeit-money, though the exchange was not made.

Handicap was also the name of an old game at cards, now obsolete. It resembled the game of Loo, and probably derived its name from the ancient sport described above.

HANSEL, the O. Eng. term for earnest money; especially in Scotland the first money taken at a market or fair. The termination *sel* is the modern "sell." "Hand" indicates, not a bargain by shaking hands, but the actual putting of the money into the hand. Hansels were also presents or earnest of goodwill in the North; thus Handsel Monday, the first Monday in the year, an occasion for universal tipping, is the equivalent of the English Boxing day.

HANDSWORTH. (1) An urban district in the Handsworth parliamentary division of Staffordshire, England, suburban to Birmingham on the north-west. Pop. (1891), 32,756; (1901) 52,021. (See BIRMINGHAM.) (2) An urban district in the Hallamshire parliamentary division of Yorkshire, 4 m. S.E.

of Sheffield. Pop. (1901), 13,404. In this neighbourhood are extensive collieries and quarries.

HANDWRITING. Under PALAEOGRAPHY and WRITING, the history of handwriting is dealt with. Questions of handwriting come before legal tribunals mainly in connexion with the law of evidence. In Roman law, the authenticity of documents was proved first by the attesting witnesses; in the second place, if they were dead, by comparison of handwritings. It was necessary, however, that the document to be used for purposes of comparison either should have been executed with the formalities of a public document, or should have its genuineness proved by three attesting witnesses. The determination was apparently, in the latter case, left to experts, who were sworn to give an impartial opinion (Code 4, 21. 20). Proof by comparison of handwritings, with a reference if necessary to three experts as to the handwriting which is to be used for the purposes of comparison, is provided for in the French Code of Civil Procedure (arts. 193 et seq.); and in Quebec (Code Proc. Civ. arts. 392 et seq.) and St Lucia (Code Civ. Proc. arts. 286 et seq.), the French system has been adopted with modifications. Comparison by witnesses of disputed writings with any writing proved to the satisfaction of the judge to be genuine is accepted in England and Ireland in all legal proceedings whether criminal or civil, including proceedings before arbitrators (Denman Act, 28 & 29 Vict. c. 18, 55. 1, 8); and such writings and the evidence of witnesses respecting the same may be submitted to the court and jury as evidence of the genuineness or otherwise of the writing in dispute. It is admitted in Scotland (where the term *comparatio litterarum* is in use) and in most of the American states, subject to the same conditions. In England, prior to the Common Law Procedure Act of 1854 (now superseded by the act of 1866), documents irrelevant to the matter in issue were not admissible for the sole purpose of comparison, and this rule has been adopted, and is still adhered to, in some of the states in America. In England, as in the United States, and in most legal systems, the primary and best evidence of handwriting is that of the writer himself. Witnesses who saw him write the writing in question, or who are familiar with his handwriting either from having seen him write or from having corresponded with him, or otherwise, may be called. In cases of disputed handwriting the court will accept the evidence of experts in handwriting, i.e. persons who have an adequate knowledge of handwriting, whether acquired in the way of their business or not, such as solicitors or bank cashiers (*R. v. Silverlock*, 1894, 2 Q.B. 766). In such cases the witness is required to compare the admitted handwriting of the person whose writing is in question with the disputed document, and to state in detail the similarities or differences as to the formation of words and letters, on which he bases his opinion as to the genuineness or otherwise of the disputed document. By the use of the magnifying glass, or, as in the *Parnell case*, by enlarged photographs of the letters alleged to have been written by Mr Parnell, the court and jury are much assisted to appreciate the grounds on which the conclusions of the expert are founded. Evidence of this kind, being based on opinion and theory, needs to be very carefully weighed, and the dangers of implicit reliance on it have been illustrated in many cases (e.g. the Beck case in 1904; and see *Seaman v. Netherclift*, 1876, 1 C.P.D. 540). Evidence by comparison of handwriting comes in principally either in default, or in corroboration, of the other modes of proof.

Where attestation is necessary to the validity of a document, e.g. wills and bills of sale, the execution must be proved by one or more of the attesting witnesses, unless they are dead or cannot be produced, when it is sufficient to prove the signature of one of them to the attesting clause (28 & 29 Vict. c. 18, s. 7). Signatures to certain public and official documents need not in general be proved (see e.g. Evidence Act, 1845, ss. 1, 2).

See Taylor, *Law of Evidence* (10th ed., London, 1906); Erskine, *Principles of the Law of Scotland* (20th ed., Edinburgh, 1905); Bouvier, *Law Dicty.* (Boston and London, 1897); Harris, *Identification* (Albany, 1892); Hagan, *Disputed Handwriting* (New York, 1894); also the article IDENTIFICATION. (A. W. R.)

HANG-CHOW-FU, a city of China, in the province of Cheh-Kiang, 2 m. N.W. of the T sien-tang-Kiang, at the southern terminus of the Grand canal, by which it communicates with Peking. It lies about 100 m. S.W. of Shanghai, in 30° 20' 20" N., 120° 7' 27" E. Towards the west is the Si-hu or Western Lake, a beautiful sheet of water, with its banks and islands studded with villas, monuments and gardens, and its surface traversed by gaily-painted pleasure boats. Exclusive of extensive and flourishing suburbs, the city has a circuit of 12 m.; its streets are well paved and clean; and it possesses a large number of arches, public monuments, temples, hospitals and colleges. It has long ranked as one of the great centres of Chinese commerce and Chinese learning. In 1869 the silk manufactures alone were said to give employment to 60,000 persons within its walls, and it has an extensive production of gold and silver work and tinsel paper. On one of the islands in the lake is the great Wên-lan-ko or pavilion of literary assemblies, and it is said that at the examinations for the second degree, twice every three years, from 10,000 to 15,000 candidates come together. In the north-east corner of the city is the Nestorian church which was noted by Marco Polo, the façade being "elaborately carved and the gates covered with elegantly wrought iron." There is a Roman Catholic mission in Hangchow, and the Church Missionary Society, the American Presbyterians, and the Baptists have stations. The local dialect differs from the Mandarin mainly in pronunciation. The population, which is remarkable for gaiety of clothing, was formerly reckoned at 2,000,000, but is now variously estimated at 300,000, 400,000 or 800,000. Hangchow-fu was declared open to foreign trade in 1896, in pursuance of the Japanese treaty of Shimonoseki. It is connected with Shanghai by inland canal, which is navigable for boats drawing up to 4 ft. of water, and which might be greatly improved by dredging. The cities of Shanghai, Hangchow and Suchow form the three points of a triangle, each being connected with the other by canal, and trade is now open by steam between all three under the inland navigation rules. These canals pass through the richest and most populous districts of China, and in particular lead into the great silk-producing districts. They have for many centuries been the highway of commerce, and afford a cheap and economical means of transport. Hangchow lies at the head of the large estuary of that name, which is, however, too shallow for navigation by steamers. The estuary or bay is funnel-shaped, and its configuration produces at spring tides a "bore" or tidal wave, which at its maximum reaches a height of 15 to 20 ft. The value of trade passing through the customs in 1899 was £1,729,000; in 1904 these figures had risen to £2,543,831.

Hangchow-fu is the Kinsai of Marco Polo, who describes it as the finest and noblest city in the world, and speaks enthusiastically of the number and splendour of its mansions and the wealth and luxuriance of its inhabitants. According to this authority it had a circuit of 100 m., and no fewer than 12,000 bridges and 3000 baths. The name Kinsai, which appears in Wassaf as Khanzai, in Ibn Batuta as Khansa, in Odoric of Pordenone as Camsay, and elsewhere as Campsay and Cassay, is really a corruption of the Chinese *King-see*, capital, the same word which is still applied to Peking. From the 10th to the 13th century (960-1272) the city, whose real name was then Ling-nan, was the capital of southern China and the seat of the Sung dynasty, which was dethroned by the Mongolians shortly before Marco Polo's visit. Up to 1861, when it was laid in ruins by the Taipings, Hangchow continued to maintain its position as one of the most flourishing cities in the empire.

HANGING, one of the modes of execution under Roman law (*ad furcam damnatio*), and in England and some other countries the usual form of capital punishment. It was derived by the Anglo-Saxons from their German ancestors (Tacitus, *Germ.* 12). Under William the Conqueror this mode of punishment is said to have been disused in favour of mutilation: but Henry I. decreed that all thieves taken should be hanged (*i.e.* summarily without trial), and by the time of Henry II. hanging was fully established as a punishment for homicide; the "right of pit

and gallows" was ordinarily included in the royal grants of jurisdiction to lords of manors and to ecclesiastical¹ and municipal corporations. In the middle ages every town, abbey, and nearly all the more important manorial lords had the right of hanging. The clergy had rights, too, in respect to the gallows. Thus William the Conqueror invested the abbot of Battle Abbey with authority to save the life of any criminal. From the end of the 12th century the jurisdiction of the royal courts gradually became exclusive; as early as 1212 the king's justices sentenced offenders to be hanged (*Seld. Soc. Publ.* vol. i.; *Select Pleas of the Crown*, p. 111), and in the Gloucester eyre of 1221 instances of this sentence are numerous (Maitland, pl. 72, 101, 228). In 1241 a nobleman's son, William Marise, was hanged for piracy. In the reign of Edward I. the abbot of Peterborough set up a gallows at Collingham, Notts, and hanged a thief. In 1279 two hundred and eighty Jews were hanged for clipping coin. The mayor and the porter of the South Gate of Exeter were hanged for their neglect in leaving the city gate open at night, thereby aiding the escape of a murderer. Hanging in time superseded all other forms of capital punishment for felony. It was substituted in 1790 for burning as a punishment of female traitors and in 1814 for beheading as a punishment for male traitors. The older and more primitive modes of carrying out the sentence were by hanging from the bough of a tree ("the father to the bough, the son to the plough") or from a gallows. Formerly in the worst cases of murder it was customary after execution to hang the criminal's body in chains near the scene of his crime. This was known as "gibbeting," and, though by no means rare in the earliest times, was, according to Blackstone, no part of the legal sentence. Holinshed is the authority for the statement that sometimes culprits were gibbeted alive, but this is doubtful. It was not until 1752 that gibbeting was recognized by statute. The act (25 Geo. II. c. 37) empowered the judges to direct that the dead body of a murderer should be hung in chains, in the manner practised for the most atrocious offences, or given over to surgeons to be dissected and anatomized, and forbade burial except after dissection (see Foster, *Crown Law*, 107, Earl Ferrers' case, 1760). The hanging in chains was usually on the spot where the murder took place. Pirates were gibbeted on the sea shore or river bank. The act of 1752 was repealed in 1828, but the alternatives of dissection or hanging in chains were re-enacted and continued in use until abolished as to dissection by the Anatomy Act in 1832, and as to hanging in chains in 1834. The last murderer hung in chains seems to have been James Cook, executed at Leicester on the 10th of August 1832. The irons used on that occasion are preserved in Leicester prison. Instead of chains, gibbet irons, a framework to hold the limbs together, were sometimes used. At the town hall, Rye, Sussex, are preserved the irons used in 1742 for one John Breeds who murdered the mayor.

The earlier modes of hanging were gradually disused, and the present system of hanging by use of the drop is said to have been inaugurated at the execution of the fourth Earl Ferrers in 1760. The form of scaffold now in use² has under the gallows a drop constructed on the principle of the trap-doors on a theatrical stage, upon which the convict is placed under the gallows, a white cap is placed over his head, and when the halter has been properly adjusted the drop is withdrawn by a mechanical contrivance worked by a lever, much like those in use on railways for moving points and signals. The convict falls into a pit,

¹ See Pollock and Maitland vol. i. 563. The sole survival of these grants is the jurisdiction of the justices of the Soke of Peterborough to try for capital offences at their quarter sessions.

² In most counties in Ireland the scaffold used (in 1852) to consist in an iron balcony permanently fixed outside the gaol wall. There was a small door in the wall commanding the balcony and opening out upon it. The bottom of the iron balcony or cage was so constructed that on the withdrawal of a pin or bolt which could be managed from within the gaol, the trap-door upon which the culprit stood dropped from under his feet. The upper end of the rope was fastened to a strong iron bar, which projected over the trap-door. There were usually two or three trap-doors on the same balcony, so that, if required, two or more men could be hanged simultaneously. (Trench, *Realities of Irish Life* (1869), 280.)

the length of the fall being regulated by his height and weight. Death results not from real hanging and strangulation, but from a fracture of the cervical vertebrae. Compression of the windpipe by the rope and the obstruction of the circulation aid in the fatal result. Recently the noose has had imbedded in its fibre a metal eyelet which is adjusted tightly beneath the ear and considerably expedites death. The convict is left hanging until life is extinct.

It was long considered essential that executions, like trials, should be public, and be carried out in a manner calculated to impress evil-doers. Partly to this idea, partly to notions of revenge and temporal punishment of sin, is probably due the rigour of the administration of the English law. But the methods of execution were unseemly, as delineated in Hogarth's print of the execution of the idle apprentice, and were ineffectual in reducing the bulk of crime, which was augmented by the inefficiency of the police and the uncertainty and severity of the law, which rendered persons tempted to commit crime either reckless or confident of escape. The scandals attending public executions led to an attempt to alter the law in 1841, although many protests had been made long before, among them those of the novelist Fielding. But perhaps the most forcible and effectual was that of Charles Dickens in his letters to *The Times* written after mixing in the crowd gathered to witness the execution of the Mannings at Horsemonger Lane gaol in 1849. After his experiences he came to the conclusion that public executions attracted the depraved and those affected by morbid curiosity; and that the spectacle had neither the solemnity nor the salutary effect which should attend the execution of public justice. His views were strongly resisted in some quarters; and it was not until 1868 (31 & 32 Vict. c. 24) that they were accepted. The last public hanging in England was that of Michael Barrett for murder by causing an explosion at Clerkenwell prison with the object of releasing persons confined there for treason and felony (Ann. Reg., 1868, p. 63). Under the act of 1868 (31 & 32 Vict. c. 24), which was adapted from similar legislation already in force in the Australian colonies convicted murderers are hanged within the walls of a prison. The sentence of the court is that the convict "be hanged by the neck until he is dead." The execution of the sentence devolves on the sheriff of the county (Sheriffs Act 1887, s. 13). As a general rule the sentence is carried out in England and Ireland at 8 a.m. on a week-day (not being Monday), in the week following the third Sunday after sentence was passed. In old times prisoners were often hanged on the day after sentence was passed; and under the act of 1752 this was made the rule in cases of murder. A public notice of the date and hour of execution must be posted on the prison walls not less than twelve hours before the execution and must remain until the inquest is over. The persons required to be present are the sheriff, the gaoler, chaplain and surgeon of the prison, and such other officers of the prison as the sheriff requires; justices of the peace for the jurisdiction to which the prison belongs, and such of the relatives, or such other persons as the sheriff or visiting justices allow, may also attend. It is usual to allow the attendance of some representatives of the press. The death of the prisoner is certified by the prison surgeon, and a declaration that judgment of death has been executed is signed by the sheriff. An inquest is then held on the body by the coroner for the jurisdiction and a jury from which prison officers are excluded. The certificate and declaration, and a duplicate of the coroner's inquiry also, are sent to the home office, or in Ireland to the lord-lieutenant, and the body of the prisoner is interred in quicklime within the prison walls if space is available. It is also the practice to toll the bell of the parish or other neighbouring church, for fifteen minutes before and fifteen minutes after the execution. The hoisting of the black flag at the moment of execution was abolished in 1902. The regulations as to execution are printed in the Statutory Rules and Orders, Revised ed. 1904, vol. x. (tits. Prison E. and Prison I). The act of 1868 applies only to executions for murder; but since the passing of the act there have been no executions for any other crime within the United Kingdom. (See further CAPITAL PUNISHMENT.)

In Scotland execution by hanging is carried out in the same manner as in England and Ireland, but under the supervision of the magistrates of the burgh in which it is decreed to take place, and in lieu of the inquest required in England and Ireland an inquiry is held at the instance of the procurator-fiscal before a sheriff or sheriff substitute (act of 1868, s. 13). The procedure at the execution is governed by the act of 1868 and the Scottish Prison Rules, rr. 465-469 (Stat. Rules and Orders, Revised ed. 1904, tit. Prison S).

British Dominions beyond the Seas.—Throughout the King's dominions hanging is the regular method of executing sentence of death. In India the Penal Code superseded the modes of punishment under Mahomedan law, and s. 368 of the Criminal Procedure Code of 1898 provides that sentence of death is to be executed by hanging by the neck.

In Canada the sentence is executed within a prison under conditions very similar to those in England (Criminal Code, 1892; ss. 936-945). In Australia the execution takes place within the prison walls, at a time and place appointed by the governor of the state. See Queensland Code, 1899, s. 664; Western Australia Code, 1901, s. 663; in these states no inquest is held. In Western Australia the governor may cause an aboriginal native to be executed outside a prison. In New Zealand the only mode of execution is by hanging within a prison (Act of 1883).

United States.—In all the states except New York, Massachusetts, New Jersey, North Carolina, Mississippi, Virginia, and Ohio (see ELECTROCUTION) persons sentenced to death are hanged. In Utah the criminal may elect to be shot instead.

The only countries, whose law is not of direct English origin, which inflict capital punishment by hanging are Japan, Austria, Hungary and Russia. (W. F. C.)

HANGÖ, a port and sea-bathing resort situated on the promontory of Hangöudd, to the extreme south-west of Finland. Hangö owes its commercial importance to the fact that it is practically the only winter ice-free port in Finland, and is thus of value both to the Finnish and the Russian sea-borne trade. When incorporated in 1874 it had only a few hundred inhabitants; in 1900 it had 2501 and it has now over six thousand (5986 in 1904). It is connected by railway with Helsingfors and Tammerfors, and is the centre of the Finnish butter export, which now amounts to over £1,000,000 yearly. There is a considerable import of coal, cotton, iron and breadstuffs, the chief exports being butter, fish, timber and wood pulp. During the period of emigration, owing to political troubles with Russia, over 12,000 Finns sailed from Hangö in a single year (1901), mostly for the United States and Canada. Hangö now takes front rank as a fashionable watering-place, especially for wealthy Russians, having a dry climate and a fine strand.

HANKA, WENCESLAUS (1791-1861), Bohemian philologist, was born at Horeniowes, a hamlet of eastern Bohemia, on the 10th of June 1791. He was sent in 1807 to school at Königgrätz, to escape the conscription, then to the university of Prague, where he founded a society for the cultivation of the Czech language. At Vienna, where he afterwards studied law, he established a Czech periodical; and in 1813 he made the acquaintance of Joseph Dobrowsky, the eminent philologist. On the 16th of September 1817 Hanka alleged that he had discovered some ancient Bohemian manuscript poems (the Königinhof MS.) of the 13th and 14th century in the church tower of the village of Kralodwor, or Königinhof. These were published in 1818, under the title *Kralodvorsky Rukopis*, with a German translation by Swoboda. Great doubt, however, was felt as to their genuineness, and Dobrowsky, by pronouncing *The Judgment of Libussa*, another manuscript found by Hanka, an "obvious fraud," confirmed the suspicion. Some years afterwards Dobrowsky saw fit to modify his decision, but by modern Czech scholars the MS. is regarded as a forgery. A translation into English, *The Manuscript of the Queen's Court*, was made by Wratislav in 1852. The originals were presented by the discoverer to the Bohemian museum at Prague, of which he was appointed librarian in 1818. In 1848 Hanka, who was an ardent Pan Slavist, took part in the Slavonic congress and

other peaceful national demonstrations, being the founder of the political society Slovenska Lipa. He was elected to the imperial diet at Vienna, but declined to take his seat. In the winter of 1848 he became lecturer and in 1849 professor of Slavonic languages in the university of Prague, where he died on the 12th of January 1861.

His chief works and editions are the following: *Hankowj Pjssie* (Prague, 1815), a volume of poems; *Starobyta Skladani* (1817-1826), in 5 vols.—a collection of old Bohemian poems, chiefly from unpublished manuscripts; *A Short History of the Slavonic Peoples* (1818); *A Bohemian Grammar* (1822) and *A Polish Grammar* (1839)—these grammars were composed on a plan suggested by Dobrowsky; *Igor* (1821), an ancient Russian epic, with a translation into Bohemian; a part of the Gospels from the Reims manuscript in the Glagolitic character (1846); the old Bohemian Chronicles of *Dalimil* (1848) and the *History of Charles IV.*, by Procop Lupáč (1848); *Evangelium Ostremis* (1853).

HANKOW ("Mouth of the Han"), the great commercial centre of the middle portion of the Chinese empire, and since 1858 one of the principal places opened to foreign trade. It is situated on the northern side of the Yangtze-kiang at its junction with the Han river, about 600 m. W. of Shanghai in 30° 32' 51" N., 114° 19' 55" E., at a height of 150 ft. By the Chinese it is not considered a separate city, but as a suburb of the now decadent city of Hanyang; and it may almost be said to stand in a similar relation to Wu-chang the capital of the province of Hupeh, which lies immediately opposite on the southern bank of the Yangtze-kiang. Hankow extends for about a mile along the main river and about two and a half along the Han. It is protected by a wall 18 ft. high, which was erected in 1863 and has a circuit of about 4 m. Within recent years the port has made rapid advance in wealth and importance. The opening up of the upper waters of the Yangtze to steam navigation has made it a commercial entrepôt second only to Shanghai. It is the terminus of a railway between Peking and the Yangtze, the northern half of the trunk line from Peking to Canton. There is daily communication by regular lines of steamers with Shanghai, and smaller steamers ply on the upper section of the river between Hankow and Ich'ang. The principal article of export continues to be black tea, of which staple Hankow has always been the central market. The bulk of the leaf tea, however, now goes to Russia by direct steamers to Odessa instead of to London as formerly, and a large quantity goes overland via Tientsin and Siberia in the form of brick tea. The quantity of brick tea thus exported in 1904 was upwards of 10 million lb. The exports which come next in value are opium, wood-oil, hides, beans, cotton yarn and raw silk. The population of Hankow, together with the city of Wuchang on the opposite bank, is estimated at 800,000, and the number of foreign residents is about 500. Large iron-works have been erected by the Chinese authorities at Hanyang, a couple of miles higher up the river, and at Wuchang there are two official cotton mills. The British concession, on which the business part of the foreign settlement is built, was obtained in 1861 by a lease in perpetuity from the Chinese authorities in favour of the crown. By 1863 a great embankment and a roadway were completed along the river, which may rise as much as 50 ft. or more above its ordinary levels, and not infrequently, as in 1849 and 1866, lays a large part of the town under water. On the former occasion little was left uncovered but the roofs of the houses. In 1864 a public assay office was established. Sub-leases for a term of years are granted by the crown to private individuals; local control, including the policing of the settlement, is managed by a municipal council elected under regulations promulgated by the British minister in China, acting by authority of the sovereign's orders in council. Foreigners, i.e. non-British, are admitted to become lease-holders on their submitting to be bound by the municipal regulations. The concession, however, gives no territorial jurisdiction. All foreigners, of whatever nationality, are justiciable only before their own consular authorities by virtue of the extra-territorial clauses of their treaties with China. In 1805 a concession, on similar terms to that under which the British is held, was obtained by Germany, and this was followed by concessions to France and Russia.

These three concessions all lie on the north bank of the river and immediately below the British. An extension of the British concession backwards was granted in 1898. The Roman Catholics, the London Missionary Society and the Wesleyans have all missions in the town; and there are two missionary hospitals. The total trade in 1904 was valued at £15,401,076 (£9,042,190 being exports and £6,358,886 imports) as compared with a total of £17,183,400 in 1891 and £11,628,000 in 1880.

HANLEY, a market town and parliamentary borough of Staffordshire, England, in the Potteries district, 148 m. N.W. from London, on the North Staffordshire railway. Pop. (1891) 54,946; (1901) 61,599. The parliamentary borough includes the adjoining town of Burslem. The town, which lies on high ground, has handsome municipal buildings, free library, technical and art museum, elementary, science and art schools, and a large park. Its manufactures include porcelain, encaustic tiles, and earthenware, and give employment to the greater part of the population, women and children being employed almost as largely as men. In the neighbourhood coal and iron are obtained. Hanley is of modern development. Its municipal constitution dates from 1857, the parliamentary borough from 1885, and the county borough from 1888. Shelton, Hope, Northwood and Wellington are populous ecclesiastical parishes included within its boundaries. That of Etruria, adjoining on the west, originated in the Ridge House pottery works of Josiah Wedgwood and Thomas Bentley, who founded them in 1769, naming them after the country of the Etruscans in Italy. Etruria Hall was the scene of Wedgwood's experiments. The parliamentary borough of Hanley returns one member. The town was governed by a mayor, 6 aldermen, and 18 councillors until under the "Potteries federation" scheme (1908) it became part of the borough of Stoke-on-Trent (*q.v.*) in 1910.

HANNA, MARCUS ALONZO (1837-1904), American politician, was born at New Lisbon (now Lisbon) Columbiana county, Ohio, on the 24th of September 1837. In 1852 he removed with his father to Cleveland, where the latter established himself in the wholesale grocery business, and the son received his education in the public schools of that city, and at the Western Reserve University. Leaving college before the completion of his course, he became associated with his father in business, and on his father's death (1862) became a member of the firm. In 1867 he entered into partnership with his father-in-law, Daniel P. Rhodes, in the coal and iron business. It was largely due to Hanna's progressive methods that the business of the firm, which became M. A. Hanna & Company in 1877, was extended to include the ownership of a fleet of lake steamships constructed in their own shipyards, and the control and operation of valuable coal and iron mines. Subsequently he became largely interested in street railway properties in Cleveland and elsewhere, and in various banking institutions. In early life he had little time for politics, but after 1880 he became prominent in the affairs of the Republican party in Cleveland, and in 1884 and 1888 was a delegate to the Republican National Convention, in the latter year being associated with William McKinley in the management of the John Sherman canvass. It was not, however, until 1896, when he personally managed the canvass that resulted in securing the Republican presidential nomination for William McKinley at the St Louis Convention (at which he was a delegate), that he became known throughout the United States as a political manager of great adroitness, tact and resourcefulness. Subsequently he became chairman of the Republican National Committee, and managed with consummate skill the campaign of 1896 against William Jennings Bryan and "free-silver." In March 1897 he was appointed, by Governor Asa S. Bushnell (1834-1904) United States senator from Ohio, to succeed John Sherman. In the senate, to which in January 1898 he was elected for the short term ending on the 3rd of March 1899 and for the succeeding full term, he took little part in the debates, but was recognized as one of the principal advisers of the McKinley administration, and his influence was large in consequence. Apart from politics he took a deep and active interest in the problems of capital and labour, was one of the

organizers (1901) and the first president of the National Civic Federation, whose purpose was to solve social and industrial problems, and in December 1901 became chairman of a permanent board of conciliation and arbitration established by the Federation. After President Roosevelt's policies became defined, Senator Hanna came to be regarded as the leader of the conservative branch of the Republican party and a possible presidential candidate in 1904. He died at Washington on the 15th of February 1904.

HANNAY, JAMES (1827-1873), Scottish critic, novelist and publicist, was born at Dumfries on the 17th of February 1827. He came of the Hannays of Sorbie, an ancient Galloway family. He entered the navy in 1840 and served till 1845, when he adopted literature as his profession. He acted as reporter on the *Morning Chronicle* and gradually obtained a connexion, writing for the quarterly and monthly journals. In 1857 Hannay contested the Dumfries burghs in the Conservative interest, but without success. He edited the *Edinburgh Courier* from 1860 till 1864, when he removed to London. From 1868 till his death on the 8th of January 1873 he was British consul at Barcelona. His letters to the *Pall Mall Gazette* "From an Englishman in Spain" were highly appreciated. Hannay's best books are his two naval novels, *Singleton Pomenoy* (1850) and *Eustace Conyers* (1855); *Satire and Satirists* (1854); and *Essays from the Quarterly Review* (1861). *Satire* not only shows loving appreciation of the great satirists of the past, but is itself instinct with wit and fine satiric power. The book sparkles with epigrams and apposite classical allusions, and contains admirable critical estimates of Horace (Hannay's favourite author), Juvenal, Erasmus, Sir David Lindsay, George Buchanan, Boileau, Butler, Dryden, Swift, Pope, Churchill, Burns, Byron and Moore.

Among his other works are *Biscuits and Grog*, *Claret Cup*, and *Hearts are Trumps* (1848); *King Dobbs* (1849); *Sketches in Ultramarine* (1853); an edition of the *Poems of Edgar Allan Poe*, to which he prefixed an essay on the poet's life and genius (1852); *Characters and Criticisms*, consisting mainly of his contributions to the *Edinburgh Courier* (1865); *A Course of English Literature* (1866); *Studies on Thackeray* (1869); and a family history entitled *Three Hundred Years of a Norman House* (the Gurneys) (1867).

HANNEN, JAMES HANNEN, BARON (1821-1894), English judge, son of a London merchant, was born at Peckham in 1821. He was educated at St Paul's school and at Heidelberg University, which was famous as a school of law. Called to the bar at the Middle Temple in 1848, he joined the home circuit. At this time he also wrote for the press, and supplied special reports for the *Morning Chronicle*. Though not eloquent in speech, he was clear, accurate and painstaking, and soon advanced in his profession, passing many more brilliant competitors. He appeared for the claimant in the Shrewsbury peerage case in 1858, when the 3rd Earl Talbot was declared to be entitled to the earldom of Shrewsbury as the descendant of the 2nd earl; was principal agent for Great Britain on the mixed British and American commission for the settlement of outstanding claims, 1853-1855; and assisted in the prosecution of the Fenian prisoners at Manchester. In 1868 Hannen was appointed a judge of the Court of Queen's Bench. In many cases he took a strong position of his own, notably in that of *Farrar v. Close* (1866), which materially affected the legal status of trade unions and was regarded by unionists as a severe blow to their interests. Hannen became judge of the Probate and Divorce Court in 1872, and in 1875 he was appointed president of the probate and admiralty division of the High Court of Justice. Here he showed himself a worthy successor to Cresswell and Penzance. Many important causes came before him, but he will chiefly be remembered for the manner in which he presided over the Parnell special commission. His influence pervaded the whole proceedings, and it is understood that he personally penned a large part of the voluminous report. Hannen's last public service was in connexion with the Bering Sea inquiry at Paris, when he acted as one of the British arbitrators. In January 1891 he was appointed a lord of appeal in ordinary (with the dignity of a life peerage), but in that capacity he had few oppor-

unities for displaying his powers, and he retired at the close of the session of 1893. He died in London, after a prolonged illness, on the 20th of March 1894.

HANNIBAL ("mercy" or "favour of Baal"), Carthaginian general and statesman, son of Hamilcar Barca (q.v.), was born in 249 or 247 B.C. Destined by his father to succeed him in the work of vengeance against Rome, he was taken to Spain, and while yet a boy gave ample evidence of his military aptitude. Upon the death of his brother-in-law Hasdrubal (221) he was acclaimed commander-in-chief by the soldiers and confirmed in his appointment by the Carthaginian government. After two years spent in completing the conquest of Spain south of the Ebro, he set himself to begin what he felt to be his life's task, the conquest and humiliation of Rome. Accordingly in 219 he seized some pretext for attacking the town of Saguntum (mod. Murviedro), which stood under the special protection of Rome, and disregarding the protests of Roman envoys, stormed it after an eight months' siege. As the home government, in view of Hannibal's great popularity, did not venture to repudiate this action, the declaration of war which he desired took place at the end of the year.

Of the large army of Libyan and Spanish mercenaries which he had at his disposal Hannibal selected the most trustworthy and devoted contingents, and with these determined to execute the daring plan of carrying the war into the heart of Italy by a rapid march through Spain and Gaul. Starting in the spring of 218 he easily fought his way through the northern tribes to the Pyrenees, and by conciliating the Gaulish chiefs on his passage contrived to reach the Rhone before the Romans could take any measures to bar his advance. After outmanoeuvring the natives, who endeavoured to prevent his crossing, Hannibal evaded a Roman force sent to operate against him in Gaul; he proceeded up the valley of one of the tributaries of the Rhone (Isère or, more probably, Durance), and by autumn arrived at the foot of the Alps. His passage over the mountain-chain, at a point which cannot be determined with certainty, though the balance of the available evidence inclines to the Mt Genève pass, and fair cases can be made out for the Col d'Argentière and for Mt Cenis, was one of the most memorable achievements of any military force of ancient times. Though the opposition of the natives and the difficulties of ground and climate cost Hannibal half his army, his perilous march brought him directly into Roman territory and entirely frustrated the attempts of the enemy to fight out the main issue on foreign ground. His sudden appearance among the Gauls, moreover, enabled him to detach most of the tribes from their new allegiance to the Romans before the latter could take steps to check rebellion. After allowing his soldiers a brief rest to recover from their exertions Hannibal first secured his rear by subduing the hostile tribe of the Taurini (mod. Turin), and moving down the Po valley forced the Romans by virtue of his superior cavalry to evacuate the plain of Lombardy. In December of the same year he had an opportunity of showing his superior military skill when the Roman commander attacked him on the river Trebia (near Placentia); after wearing down the excellent Roman infantry he cut it to pieces by a surprise attack from an ambush in the flank. Having secured his position in north Italy by this victory, he quartered his troops for the winter on the Gauls, whose zeal in his cause thereupon began to abate. Accordingly in spring 217 Hannibal decided to find a more trustworthy base of operations farther south; he crossed the Apennines without opposition, but in the marshy lowlands of the Arno he lost a large part of his force through disease and himself became blind in one eye. Advancing through the uplands of Etruria he provoked the main Roman army to a hasty pursuit, and catching it in a defile on the shore of Lake Trasimene destroyed it in the waters or on the adjoining slopes (see TRASIMENE). He had now disposed of the only field force which could check his advance upon Rome, but realizing that without siege engines he could not hope to take the capital, he preferred to utilize his victory by passing into central and southern Italy and exciting a general revolt against the sovereign power. Though closely watched

by a force under Fabius Maximus Cunctator, he was able to carry his ravages far and wide through Italy: on one occasion he was entrapped in the lowlands of Campania, but set himself free by a stratagem which completely deluded his opponent. For the winter he found comfortable quarters in the Apulian plain, into which the enemy dared not descend. In the campaign of 217 Hannibal had failed to obtain a following among the Italians; in the following year he had an opportunity of turning the tide in his favour. A large Roman army advanced into Apulia in order to crush him, and accepted battle on the site of Cannae. Thanks mainly to brilliant cavalry tactics, Hannibal, with much inferior numbers, managed to surround and cut to pieces the whole of this force; moreover, the moral effect of this victory was such that all the south of Italy joined his cause. Had Hannibal now received proper material reinforcements from his countrymen at Carthage he might have made a direct attack upon Rome; for the present he had to content himself with subduing the fortresses which still held out against him, and the only other notable event of 216 was the defection of Capua, the second largest city of Italy, which Hannibal made his new base.

In the next few years Hannibal was reduced to minor operations which centred mainly round the cities of Campania. He failed to draw his opponents into a pitched battle, and in some slighter engagements suffered reverses. As the forces detached under his lieutenants were generally unable to hold their own, and neither his home government nor his new ally Philip V. of Macedonia helped to make good his losses, his position in south Italy became increasingly difficult and his chance of ultimately conquering Rome grew ever more remote. In 212 he gained an important success by capturing Tarentum, but in the same year he lost his hold upon Campania, where he failed to prevent the concentration of three Roman armies round Capua. Hannibal attacked the besieging armies with his full force in 211, and attempted to entice them away by a sudden march through Samnium which brought him within 3 m. of Rome, but caused more alarm than real danger to the city. But the siege continued, and the town fell in the same year. In 210 Hannibal again proved his superiority in tactics by a severe defeat inflicted at Herdoniae (mod. Ortona) in Apulia upon a proconsular army, and in 208 destroyed a Roman force engaged in the siege of Locri Epizephyrii. But with the loss of Tarentum in 209 and the gradual reconquest by the Romans of Samnium and Lucania his hold on south Italy was almost lost. In 207 he succeeded in making his way again into Apulia, where he waited to concert measures for a combined march upon Rome with his brother Hasdrubal (q.v.). On hearing, however, of his brother's defeat and death at the Metaurus he retired into the mountain fastnesses of Bruttium, where he maintained himself for the ensuing years. With the failure of his brother Mago (q.v.) in Liguria (205-203) and of his own negotiations with Philip of Macedonia, the last hope of recovering his ascendancy in Italy was lost. In 203, when Scipio was carrying all before him in Africa and the Carthaginian peace-party were arranging an armistice, Hannibal was recalled from Italy by the "patriot" party at Carthage. After leaving a record of his expedition, engraved in Punic and Greek upon brazen tablets, in the temple of Juno at Crotona, he sailed back to Africa. His arrival immediately restored the predominance of the war-party, who placed him in command of a combined force of African levies and of his mercenaries from Italy. In 202 Hannibal, after meeting Scipio in a fruitless peace conference, engaged him in a decisive battle at Zama. Unable to cope with his indifferent troops against the well-trained and confident Roman soldiers, he experienced a crushing defeat which put an end to all resistance on the part of Carthage.

Hannibal was still only in his forty-sixth year. He soon showed that he could be a statesman as well as a soldier. Peace having been concluded, he was appointed chief magistrate (*suffetes, sofet*). The office had become rather insignificant, but Hannibal restored its power and authority. The oligarchy, always jealous of him, had even charged him with having betrayed the interests of his country while in Italy, and neglected to take Rome when

he might have done so. The dishonesty and incompetence of these men had brought the finances of Carthage into grievous disorder. So effectively did Hannibal reform abuses that the heavy tribute imposed by Rome could be paid by instalments without additional and extraordinary taxation.

Seven years after the victory of Zama, the Romans, alarmed at this new prosperity, demanded Hannibal's surrender. Hannibal thereupon went into voluntary exile. First he journeyed to Tyre, the mother-city of Carthage, and thence to Ephesus, where he was honourably received by Antiochus III. of Syria, who was then preparing for war with Rome. Hannibal soon saw that the king's army was no match for the Romans. He advised him to equip a fleet and throw a body of troops on the south of Italy, adding that he would himself take the command. But he could not make much impression on Antiochus, who listened more willingly to courtiers and flatterers, and would not entrust Hannibal with any important charge. In 190 he was placed in command of a Phoenician fleet, but was defeated in a battle off the river Eurymedon.

From the court of Antiochus, who seemed prepared to surrender him to the Romans, Hannibal fled to Crete, but he soon went back to Asia, and sought refuge with Prusias, king of Bithynia. Once more the Romans were determined to hunt him out, and they sent Flaminius to insist on his surrender. Prusias agreed to give him up, but Hannibal did not choose to fall into his enemies' hands. At Libyssa, on the eastern shore of the Sea of Marmora, he took poison, which, it was said, he had long carried about with him in a ring. The precise year of his death was a matter of controversy. If, as Livy seems to imply, it was 183, he died in the same year as Scipio Africanus.

As to the transcendent military genius of Hannibal there cannot be two opinions. The man who for fifteen years could hold his ground in a hostile country against several powerful armies and a succession of able generals must have been a commander and a tactician of supreme capacity. In the use of stratagems and ambuscades he certainly surpassed all other generals of antiquity. Wonderful as his achievements were, we must marvel the more when we take into account the grudging support he received from Carthage. As his veterans melted away, he had to organize fresh levies on the spot. We never hear of a mutiny in his army, composed though it was of Africans, Spaniards and Gauls. Again, all we know of him comes for the most part from hostile sources. The Romans feared and hated him so much that they could not do him justice. Livy speaks of his great qualities, but he adds that his vices were equally great, among which he singles out his "more than Punic perfidy" and "an inhuman cruelty." For the first there would seem to be no further justification than that he was consummately skillful in the use of ambuscades. For the latter there is, we believe, no more ground than that at certain crises he acted in the general spirit of ancient warfare. Sometimes he contrasts most favourably with his enemy. No such brutality stains his name as that perpetrated by Claudius Nero on the vanquished Hasdrubal. Polybius merely says that he was accused of cruelty by the Romans and of avarice by the Carthaginians. He had indeed bitter enemies, and his life was one continuous struggle against destiny. For steadfastness of purpose, for organizing capacity and a mastery of military science he has perhaps never had an equal.

AUTHORITIES.—Polybius iii.-xv., xxi.-ii., xxiv.; Livy xxi.-xxx.; Cornelius Nepos, *Vita Hannibalis*; Appian, *Bellum Hannibalicum*; E. Hennebert, *Histoire d'Hannibal* (Paris, 1870-1891, 3 vols.); F. A. Dodge, *Great Captains, Hannibal* (Boston and New York, 1891); D. Grassi, *Hannibal giudicato da Polibio e Tito Livio* (Vicenza, 1896); W. How, *Hannibal and the Great War between Rome and Carthage* (London, 1899); T. Montanari, *Hannibal*, down to 217 B.C. (Rovigo, 1901); K. Lehmann, *Die Angriffe der drei Barkiden auf Italien* (Leipzig, 1905), with bibliography. See also PUNIC WARS and articles on the chief battle sites. On Hannibal's passage through Gaul and the Alps see T. Arnold, *The Second Punic War* (ed. W. T. Arnold, London, 1886). Appendix B, pp. 362-373, with bibliography; D. Freshfield in *Alpine Journal* (1883), pp. 267-300; L. Montlabuc, *Le Vrai Chemin d'Hannibal à travers les Alpes* (Paris, 1896); J. Fuchs, *Hannibals Alpenübergang* (Vienna, 1897); G. E. Marinidin in *Classical Review* (1899), pp. 238-249; W. Osiander, *Der Hannibalsweg nach*

untersucht (Berlin, 1900); P. Azan, *Hannibal dans les Alpes* (Paris, 1902); J. L. Colin, *Hannibal en Gaule* (Paris, 1904); E. Hesselmeier, *Hannibals Alpenübergang im Lichte der neueren Kriegsgeschichte*, (1906); Kromyer, in *N. Jahrb. f. kl. Alt.* (1907). (M. O. B. C.)

HANNIBAL, a city of Marion county, Missouri, U.S.A., on the Mississippi river, about 120 m. N.W. of Saint Louis. Pop. (1890), 12,857; (1900), 12,780, including 920 foreign-born and 1836 negroes; (1910) 18,341. It is served by the Wabash, the Missouri, Kansas & Texas, the Chicago, Burlington & Quincy, and the St. Louis & Hannibal railways, and by boat lines to Saint Louis, Saint Paul and intermediate points. The business section is in the level bottom-lands of the river, while the residential portion spreads up the banks, which afford fine building sites with beautiful views. Mark Twain's boyhood was spent at Hannibal, which is the setting of *Life on the Mississippi*, *Huckleberry Finn* and *Tom Sawyer*; Hannibal Cave, described in *Tom Sawyer*, extends for miles beneath the river and its bluffs. Hannibal has a good public library (1889; the first in Missouri); other prominent buildings are the Federal building, the court house, a city hospital and the high school. The river is here spanned by a long iron and steel bridge connecting with East Hannibal, Ill. Hannibal is the trade centre of a rich agricultural region, and has an important lumber trade, railway shops, and manufactories of lumber, shoes, stoves, flour, cigars, lime, Portland cement and pearl buttons (made from mussel shells); the value of the city's factory products increased from \$2,698,720 in 1900 to \$4,442,099 in 1905, or 64.6%. In the vicinity are valuable deposits of crinoid limestone, a coarse white building stone which takes a good polish. The electric-lighting plant is owned and operated by the municipality. Hannibal was laid out as a town in 1819 (its origin going back to Spanish land grants, which gave rise to much litigation) and was first chartered as a city in 1839. The town of South Hannibal was annexed to it in 1843.

HANNINGTON, JAMES (1847-1885), English missionary, was born at Hurstpierpoint, in Sussex, on the 3rd of September 1847. From earliest childhood he displayed a love of adventure and natural history. At school he made little progress, and left at the age of fifteen for his father's counting-house at Brighton. He had no taste for office work, and much of his time was occupied in commanding a battery of volunteers and in charge of a steam launch. At twenty-one he decided on a clerical career and entered St Mary's Hall, Oxford, where he exercised a remarkable influence over his fellow-undergraduates. He was, however, a desultory student, and in 1870 was advised to go to the little village of Martinhoe, in Devon, for quiet reading, but distinguished himself more by his daring climbs after sea-gulls' eggs and his engineering skill in cutting a pathway along precipitous cliffs to some caves. In 1872 the death of his mother made a deep impression upon him. He began to read hard, took his B.A. degree, and in 1873 was ordained deacon and placed in charge of the small country parish of Trentishoe in Devon. Whilst curate in charge at Hurstpierpoint, his thoughts were turned by the murder of two missionaries on the shores of Victoria Nyanza to mission work. He offered himself to the Church Missionary Society and sailed on the 17th of May 1882, at the head of a party of six, for Zanzibar, and thence set out for Uganda; but, prostrated by fever and dysentery, he was obliged to return to England in 1883. On his recovery he was consecrated bishop of Eastern Equatorial Africa (June 1884), and in January 1885 started again for the scene of his mission, and visited Palestine on the way. On his arrival at Freretown, near Mombasa, he visited many stations in the neighbourhood. Then, filled with the idea of opening a new route to Uganda, he set out and reached a spot near Victoria Nyanza in safety. His arrival, however, roused the suspicion of the natives, and under King Mwanga's orders he was lodged in a filthy hut swarming with rats and vermin. After eight days his men were murdered, and on the 29th of October 1885 he himself was speared in both sides. His last words to the soldiers appointed to kill him being, "Go, tell Mwanga I have purchased the road to Uganda with my blood."

His *Last Journals* were edited in 1888. See also *Life* by E. C. Dawson (1887); and W. G. Berry, *Bishop Hannington* (1908).

HANNINGTON, a lake of British East Africa in the eastern rift-valley just south of the equator and in the shadow of the Laikipia escarpment. It is 7 m. long by 2 m. broad. The water is shallow and brackish. Standing in the lake and along its shores are numbers of dead trees, the remains of an ancient forest, which serve as eyries for storks, herons and eagles. The banks and flats at the north end of the lake are the resort of hundreds of thousands of flamingoes. The places where they cluster are dazzling white with guano deposits. The lake is named after Bishop James Hannington.

HANNO, the name of a large number of Carthaginian soldiers and statesmen. Of the majority little is known; the most important are the following:—

1. **HANNO**, Carthaginian navigator, who probably flourished about 500 B.C. It has been conjectured that he was the son of the Hamilcar who was killed at Himera (480), but there is nothing to prove this. He was the author of an account of a coasting voyage on the west coast of Africa, undertaken for the purpose of exploration and colonization. The original, inscribed on a tablet in the Phoenician language, was hung up in the temple of Melkarth on his return to Carthage. What is generally supposed to be a Greek translation of this is still extant, under the title of *Periplus*, although its authenticity has been questioned. Hanno appears to have advanced beyond Sierra Leone as far as Cape Palmas. On the island which formed the terminus of his voyage the explorer found a number of hairy women, whom the interpreters called Gorillas (*Γορillas*).

Valuable editions by T. Falconer (1797, with translation and defence of its authenticity) and C. W. Müller in *Geographici Graeci minores*, i.; see also E. H. Bunbury, *History of Ancient Geography*, i., and treatise by C. T. Fischer (1893), with bibliography.

2. **HANNO** (3rd century B.C.), called "the Great," Carthaginian statesman and general, leader of the aristocratic party and the chief opponent of Hamilcar and Hannibal. He appears to have gained his title from military successes in Africa, but of these nothing is known. In 240 B.C. he drove Hamilcar's veteran mercenaries to rebellion by withholding their pay, and when invested with the command against them was so unsuccessful that Carthage might have been lost but for the exertions of his enemy Hamilcar (q.v.). Hanno subsequently remained at Carthage, exerting all his influence against the democratic party, which, however, had now definitely won the upper hand. During the Second Punic War he advocated peace with Rome, and according to Livy even advised that Hannibal should be given up to the Romans. After the battle of Zama (202) he was one of the ambassadors sent to Scipio to sue for peace. Remarkably little is known of him, considering the great influence he undoubtedly exercised amongst his countrymen.

Livy xxi. 3 ff., xxiii. 12; Polybius i. 67 ff.; Appian, *Res Hispanicas*, 4. 5, *Res Punicas*, 34. 49, 68.

HANOI, capital of Tongking and of French Indo-China, on the right bank of the Song-koï or Red river, about 80 m. from its mouth in the Gulf of Tongking. Taking in the suburban population the inhabitants numbered in 1905 about 110,000, including 103,000 Annamese, 2280 Chinese and 2665 French, exclusive of troops. Hanoi resembles a European city in the possession of wide well-paved streets and promenades, systems of electric light and drainage and a good water-supply. A crowded native quarter built round a picturesque lake lies close to the river with the European quarter to the south of it. The public buildings include the palace of the governor-general, situated in a spacious botanical and zoological garden, the large military hospital, the cathedral of St Joseph, the Paul Bert college, and the theatre. The barracks and other military buildings occupy the site of the old citadel, an area of over 300 acres, to the west of the native town. The so-called pagoda of the Great Buddha is the chief native building. The river is embanked and is crossed by the Pont Doumer, a fine railway bridge over 1 m. long. Vessels drawing 8 or 9 ft. can reach the town. Hanoi is

¹ For others of the name see **CARTHAGE**; **HANNIBAL**; **PUNIC WARS**. Smith's *Classical Dictionary* has notices of some thirty of the name.

the seat of the general government of Indo-China, of the resident-superior of Tongking, and of a bishop, who is vicar-apostolic of central Tongking. It is administered by an elective municipal council with a civil service administrator as mayor. It has a chamber of commerce, the president of which has a seat on the superior council of Indo-China; a chamber of the court of appeal of Indo-China, a civil tribunal of the first order, and is the seat of the chamber of agriculture of Tongking. Its industries include cotton-spinning, brewing, distilling, and the manufacture of tobacco, earthenware and matches; native industry produces carved and inlaid furniture, bronzes and artistic metal-work, silk embroidery, &c. Hanoi is the junction of railways to Hai-Phong, its seaport, Lao-Kay, Vinh, and the Chinese frontier via Lang-Son. It is in frequent communication with Hai-Phong by steamboat.

See C. Madrolle, *Tonkin du sud: Hanoi* (Paris, 1907).

HANOTAUX, ALBERT AUGUSTE GABRIEL (1853—), French statesman and historian, was born at Beaufort in the department of Aisne. He received his historical training in the École des Chartes, and became *maître de conférences* in the École des Hautes Études. His political career was rather that of a civil servant than of a party politician. In 1879 he entered the ministry of foreign affairs as a secretary, and rose step by step through the diplomatic service. In 1886 he was elected deputy for Aisne, but, defeated in 1889, he returned to his diplomatic career, and on the 31st of May 1894 was chosen by Charles Dupuy to be minister of foreign affairs. With one interruption (during the Ribot ministry, from the 26th of January to the 2nd of November 1895) he held this portfolio until the 14th of June 1898. During his ministry he developed the *rapprochement* of France with Russia—visiting St Petersburg with the president, Felix Faure—and sent expeditions to delimit the French colonies in Africa. The Fashoda incident of July 1898 was a result of this policy, and Hanotiaux's distrust of England is frankly stated in his literary works. As an historian he published *Origines de l'institution des intendants de provinces* (1884), which is the authoritative study on the intendants; *Études historiques sur les XVI^e et XVII^e siècles en France* (1886); *Histoire de Richelieu* (2 vols., 1888); and *Histoire de la Troisième République* (1904, &c.), the standard history of contemporary France. He also edited the *Instructions des ambassadeurs de France à Rome, depuis les traités de Westphalie* (1888). He was elected a member of the French Academy on the 1st of April 1897.

HANOVER (Ger. *Hannover*), formerly an independent kingdom of Germany, but since 1866 a province of Prussia. It is bounded on the N. by the North Sea, Holstein, Hamburg and Mecklenburg-Schwerin, E. and S.E. by Prussian Saxony and the duchy of Brunswick, S.W. by the Prussian provinces of Hesse-Nassau and Westphalia, and W. by Holland. These boundaries include the grand-duchy of Oldenburg and the free state of Bremen, the former stretching southward from the North Sea nearly to the southern boundary of Hanover. A small portion of the province in the south is separated from Hanover proper by the interposition of part of Brunswick. On the 23rd of March 1873 the province was increased by the addition of the Jade territory (purchased by Prussia from Oldenburg), lying south-west of the Elbe and containing the great naval station and arsenal of Wilhelmshaven. The area of the province is 14,870 sq. m.

Physical Features.—The greater part of Hanover is a plain with sandhills, heath and moor. The most fertile districts lie on the banks of the Elbe and near the North Sea, where, as in Holland, rich meadows are preserved from encroachment of the sea by broad dikes and deep ditches, kept in repair at great expense. The main feature of the northern plain is the so-called *Lüneburger Heide*, a vast expanse of moor and fen, mainly covered with low brushwood (though here and there are oases of fine beech and oak woods) and intersected by shallow valleys, and extending almost due north from the city of Hanover to the southern arm of the Elbe at Harburg. The southern portion of the province is hilly, and in the district of Klausenburg, containing the Harz, mountainous. The higher elevations are covered by dense forests of fir and larch, and the lower slopes with deciduous trees. The eastern portion of the northern plain is covered with forests of fir. The whole of Hanover dips from the Harz Mountains to the north, and the rivers consequently flow in that direction. The three chief rivers of the province

are the Elbe in the north-east, where it mainly forms the boundary and receives the navigable tributaries Jetteze, Ilmenau, Seve, Este, Lülhe, Schwinge and Medon; the Weser in the centre, with its important tributary the Aller (navigable from Celle downwards); and in the west the Erna, with its tributaries the Aa and the Leda. Still farther west is the Vecht, which, rising in Westphalia, flows to the Zuider Zee. Canals are numerous and connect the various river systems.

The principal lakes are the Steinhuder Meer, about 4 m. long and 2 m. broad, and 20 fathoms deep, on the borders of Schaumburg-Lippe; the Dämmersee, on the borders of Oldenburg, about 12 m. in circuit; the lakes of Bederkesa and some others in the moorlands of the north; the Seeburger See, near Duderstadt; and the Oder-teich, in the Harz, 2100 ft. above the level of the sea.

Climate.—The climate in the low-lying districts near the coast is moist and foggy, in the plains mild, on the Harz mountains severe and variable. In spring the prevailing winds blow from the N.E. and E., in summer from the S.W. The mean annual temperature is about 46° Fahr.; in the town of Hanover it is higher. The average annual rainfall is about 23.5 in.; but this varies greatly in different districts. In the west the Herauch, a thick fog arising from the burning of the moors, is a plague of frequent occurrence.

Population; Divisions.—The province contains an area of 14,869 sq. m., and the total population, according to the census of 1905, was 2,759,699 (1,384,161 males and 1,375,538 females). In this connexion it is noticeable that in Hanover, almost alone among German states and provinces, there is a considerable proportion of male births over female. The density of the population is 175 to the sq. m. (English), and the proportion of urban to rural population, roughly, as 1 to 3 of the inhabitants. The province is divided into the six *Regierungsbezirke* (or departments) of Hanover, Hildesheim, Lüneburg, Stade, Osnabrück and Aurich, and these again into *Kreise* (circles, or local government districts)—76 in all. The chief towns—containing more than 10,000 inhabitants—are Hanover, Linden, Osnabrück, Hildesheim, Geestemünde, Wilhelmshaven, Harburg, Lüneburg, Celle, Göttingen and Emden. Religious statistics show that 84% of the inhabitants belong to the Evangelical Lutheran Church, 17 to the Roman Catholic and less than 1% to the Jewish communities. The Roman Catholics are mostly gathered around the episcopal sees of Hildesheim and Osnabrück and close to Münster (in Westphalia) on the western border, and the Jews in the towns. A court of appeal for the whole province sits at Celle, and there are eight superior courts. Hanover returns 19 members to the *Reichstag* (imperial diet) and 36 to the *Abgeordnetenhaus* (lower house) of the Prussian parliament (*Landtag*).

Education.—Among the educational institutions of the province the university of Göttingen stands first, with an average yearly attendance of 1500 students. There are, besides, a technical college in Hanover, an academy of forestry in Münden, a mining college in Clausthal, a military school and a veterinary college (both in Hanover), 26 gymnasia (classical schools), 18 semi-classical, and 14 commercial schools. There are also two naval academies, asylums for the deaf and dumb, and numerous charitable institutions.

Agriculture.—Though agriculture constitutes the most important branch of industry in the province, it is still in a very backward state. The greater part of the soil is of inferior quality, and much that is susceptible of cultivation is still lying waste. Of the entire area of the country 28.6% is arable, 16.2 in meadow or pasture land, 14% in forests, 37.2% in uncultivated moors, heaths, &c.; from 17 to 18% is in possession of the state. The best agriculture is to be found in the districts of Hildesheim, Calsenber, Göttingen and Grubenhagen, on the banks of the Weser and Elbe, and in East Friesland. Rye is generally grown for bread. Flax, for which much of the soil is admirably adapted, is extensively cultivated, and forms an important article of export, chiefly, however, in the form of yarn. Potatoes, hemp, turnips, hops, tobacco and beet are also extensively grown, the latter, in connexion with the sugar industry, showing each year a larger return. Apples, pears, plums and cherries are the principal kinds of fruit cultivated, while the wild red cranberries from the Harz and the black bilberries from the Lüneburger Heide form an important article of export.

Live Stock.—Hanover is renowned for its cattle and live stock generally. Of these there were counted in 1900 1,115,022 head of horned cattle, 824,000 sheep, 1,556,000 pigs, and 230,000 goats. The Lüneburger Heide yields an excellent breed of sheep, the *Heidschnucken*, which equal the Southdowns of England in delicacy of flavour. Horses famous for their size and quality are reared in the marshes of Aurich and Stade, in Hildesheim and Hanover; and, for breeding purposes, in the stud farm of Celle. Bees are principally kept on the Lüneburger Heide, and the annual yield of honey is very considerable. Large flocks of geese are kept in the moist lowlands; their flesh is salted for domestic consumption during the winter, and their feathers are prepared for sale. The rivers yield trout, salmon (in the Weser) and crayfish. The sea fisheries are important and have their chief centre at Geestemünde.

Mining.—Minerals occur in great variety and abundance. The Harz Mountains are rich in silver, lead, iron and copper; coal is found around Osnabrück, on the Deister, at Osterwald, &c., lignite in various places; salt-springs of great richness exist at Egestorfshall

and Neuhaus near Hanover, and at Lüneburg; and petroleum may be obtained south of Celle. In the cold regions of the northern lowlands peat occurs in beds of immense thickness.

Manufactures.—Works for the manufacture of iron, copper, silver, lead, vitriol and sulphur are carried on to a large extent. The iron works are very important: smelting is carried on in the Harz and near Osnaabrück; there are extensive foundries and machine factories at Hanover, Linden, Osnaabrück, Hameln, Geestmünde, Harburg, Osterode, &c., and manufactories of arms at Herzberg, and of cutlery in the towns of the Harz and in the Sollinger Forest. The textile industries are prosecuted chiefly in the towns. Linen yarn and cloth are largely manufactured, especially in the south about Osnaabrück and Hildesheim, and bleaching is engaged in extensively; woollen cloths are made to a considerable extent in the south about Einbeck, Göttingen and Hameln; cotton-spinning and weaving have their principal seats at Hanover and Linden. Glass houses, paper-mills, potteries, tile works and tobacco-pipe works are numerous. Wax is bleached to a considerable extent, and there are numerous tobacco factories, tanneries, breweries, vinegar works and brandy distilleries. Shipbuilding is an important industry, especially at Wilhelmshaven, Papenburg, Leer, Stade and Harburg; and at Münden river-barges are built.

Commerce.—Although the carrying trade of Hanover is to a great extent absorbed by Hamburg and Bremen, the shipping of the province counted, in 1903, 750 sailing vessels and 86 steamers of, together, 55,498 registered tons. The natural port is Bremen-Geestmünde and to it is directed the river traffic down the Weser, which practically forms the chief commercial artery of the province.

Communications.—The roads throughout are, on the whole, well laid, and those connecting the principal towns macadamized. Hanover is intersected by important trunk lines of railway; notably the lines from Berlin to Cologne, from Hamburg to Frankfurt-on-Main, from Hamburg to Bremen and Cologne, and from Berlin to Amsterdam.

History.—The name Hanover (*Hohenwiser* = high bank), originally confined to the town which became the capital of the duchy of Lüneburg-Calenberg, came gradually into use to designate, first, the duchy itself, and secondly, the electorate of Brunswick-Lüneburg; and it was officially recognized as the name of the state when in 1814 the electorate was raised to the rank of a kingdom.

The early history of Hanover is merged in that of the duchy of Brunswick (*g.v.*), from which the duchy of Brunswick-Lüneburg and its offshoots, the duchies of Lüneburg-Celle and Lüneburg-Calenberg have sprung. Ernest I. (1497-1546), duke of Brunswick-Lüneburg, who introduced the reformed doctrines into Lüneburg, obtained the whole of this duchy in 1539; and in 1569 his two surviving sons made an arrangement which was afterwards responsible for the birth of the kingdom of Hanover. By this agreement the greater part of the duchy, with its capital at Celle, came to William (1535-1592), the younger of the brothers, who gave laws to his land and added to its area; and this duchy of Lüneburg-Celle was subsequently ruled in turn by four of his sons: Ernest II. (1564-1611), Christian (1566-1633), Augustus (d. 1636) and Frederick (d. 1648). In addition to these four princes Duke William left three other sons, and in 1610 the seven brothers entered into a compact that the duchy should not be divided, and that only one of them should marry and continue the family. Casting lots to determine this question, the lot fell upon the sixth brother, George (1582-1641), who was a prominent soldier during the period of the Thirty Years' War and saw service in almost all parts of Europe, fighting successively for Christian IV. of Denmark, the emperor Ferdinand II., and for the Swedes both before and after the death of Gustavus Adolphus. In 1617 he aided his brother, Duke Christian, to add Grubenhagen to Lüneburg, and after the extinction of the family of Brunswick-Wolfenbüttel in 1634, he obtained Calenberg for himself, making Hanover the capital of his small dukedom. In 1648, on Duke Frederick's death, George's eldest son, Christian Louis (d. 1665), became duke of Lüneburg-Celle; and at this time he handed over Calenberg, which he had ruled since his father's death, to his second brother, George William (d. 1705). When Christian Louis died George William succeeded him in Lüneburg-Celle; but the duchy was also claimed by a younger brother, John Frederick, a cultured and enlightened prince who had forsaken the Lutheran faith of his family and had become a Roman Catholic. Soon, however, by an arrangement John Frederick

received Calenberg and Grubenhagen, which he ruled in absolute fashion, creating a standing army and modelling his court after that of Louis XIV., and which came on his death in 1679 to his youngest brother, Ernest Augustus (1630-1698), the Protestant bishop of Osnaabrück. During the French wars of aggression the Lüneburg princes were eagerly courted by Louis XIV. and by his opponents; and after some hesitation George William, influenced by Ernest Augustus, fought among the Imperialists, while John Frederick was ranged on the side of France. In 1689 George William was one of the claimants for the duchy of Saxe-Lauenburg, which was left without a ruler in that year; and after a struggle with John George III., elector of Saxony, and other rivals, he was invested with the duchy by the emperor Leopold I. It was, however, his more ambitious brother, Ernest Augustus, who did most for the prestige and advancement of the house. Having introduced the principle of primogeniture into Calenberg in 1682, Ernest determined to secure for himself the position of an elector, and the condition of Europe and the exigencies of the emperor favoured his pretensions. He made skilful use of Leopold's facilities; in 1692, in return for lavish promises of assistance to the Emperor and the Habsburgs, the emperor granted him the rank and office of elector of Brunswick-Lüneburg with the office of ambassador in the Holy Roman Empire. Indignant protests thus proceeding. A league was formed to prevent any such change to the electoral college; France and Sweden were courted for assistance; and the constitution of the Empire was thrown into a state of chaos. This agitation, however, soon subsided, and in 1708 George Louis, the son and successor of Ernest Augustus, was recognized as an elector by the Emperor. George Louis married his cousin Sophia Dorothea, daughter of George William of Lüneburg-Celle; and on his death in 1705 he united this duchy, together with Saxe-Coburg, with his paternal inheritance of Calenberg or Hanover. Ernest Augustus, had taken a step of great importance in the history of Hanover when he married Sophia, daughter of the elector palatine, Frederick V., and grand-daughter of James I. of England, for, through his mother, the elector George Louis became, by the terms of the Act of Settlement of 1701, king of Great Britain and Ireland in 1714.

From this time until the death of William IV. in 1837, Lüneburg or Hanover, was ruled by the same sovereign as Great Britain, and this personal union was not without important results for both countries. Under George I. Hanover joined the alliance against Charles XII. of Sweden in 1715; and by the peace of Stockholm in November 1719 the elector received the duchies of Bremen and Verden, which formed an important addition to the electorate. His son and successor, George II., who founded the university of Göttingen in 1737, was on bad terms with his brother-in-law Frederick William I. of Prussia, and his nephew Frederick the Great; and in 1729 war between Prussia and Hanover was only just avoided. In 1743 George took up arms on behalf of the empress Maria Theresa; but in August 1745 the danger in England from the Jacobites led him to sign the convention of Hanover with Frederick the Great, although the struggle with France raged around his electorate until the peace of Aix-la-Chapelle in 1748. Induced by political exigencies George allied himself with Frederick the Great when the Seven Years' War broke out in 1756; but in September 1757 his son William Augustus, duke of Cumberland, was compelled after his defeat at Hastenbeck to sign the convention of Klosterzeven and to abandon Hanover to the French. English money, however, came to the rescue; in 1758 Ferdinand, duke of Brunswick, cleared the electorate of the invader; and Hanover suffered no loss of territory at the peace of 1763. Both George I. and George II. preferred Hanover to England as a place of residence, and it was a frequent and perhaps justifiable cause of complaint that the interests of Great Britain were sacrificed to those of the smaller country. But George III. was more British than either his grandfather or his great-grandfather, and owing to a variety of causes the foreign policies of the two countries began to diverge in the later years of his reign. Two

main considerations dominated the fortunes of Hanover during the period of the Napoleonic wars, the jealousy felt by Prussia at the increasing strength and prestige of the electorate, and its position as a vulnerable outpost of Great Britain. From 1793 the Hanoverian troops fought for the Allies against France, until the treaty of Basel between France and Prussia in 1795 imposed a forced neutrality upon Hanover. At the instigation of Bonaparte Hanover was occupied by the Prussians for a few months in 1801, but at the settlement which followed the peace of Lunéville the secularized bishopric of Osnabrück was added to the electorate. Again tempting the fortune of war after the rupture of the peace of Amiens, the Hanoverians found that the odds against them were too great; and in June 1803 by the convention of Sulingen their territory was occupied by the French. The formation of the third coalition against France in 1805 induced Napoleon to purchase the support of Prussia by allowing her troops to seize Hanover; but in 1807, after the defeat of Prussia at Jena, he incorporated the southern part of the electorate in the kingdom of Westphalia, adding the northern portion to France in 1810. The French occupation was costly and aggressive; and the Hanoverians, many of whom were found in the allied armies, welcomed the fall of Napoleon and the return of the old order. Represented at the congress of Vienna by Ernest, Count Münster, the elector was granted the title of king; but the British ministers wished to keep the interests of Great Britain distinct from those of Hanover. The result of the congress, however, was not unfavourable to the new kingdom, which received East Friesland, the secularized bishopric of Hildesheim, the city of Goslar, and some smaller additions of territory, in return for the surrender of the greater part of the duchy of Saxe-Lauenburg to Prussia.

Like those of the other districts of Germany, the estates of the different provinces which formed the kingdom of Hanover had met for many years in an irregular fashion to exercise their varying and ill-defined authority; and, although the elector Ernest Augustus introduced a system of administrative councils into Celle, these estates, consisting of the three orders of prelates, nobles and towns, together with a body somewhat resembling the English privy council, were the only constitution which the country possessed, and the only check upon the power of its ruler. When the elector George Louis became king of Great Britain in 1714 he appointed a representative, or *statthalter*, to govern the electorate, and thus the union of the two countries was attended with constitutional changes in Hanover as well as in Great Britain. Responsible of course to the elector, the *Statthalter*, aided by the privy council, conducted the internal affairs of the electorate, generally in a peaceful and satisfactory fashion, until the welter of the Napoleonic wars. On the conclusion of peace in 1814 the estates of the several provinces of the kingdom were fused into one body, consisting of eighty-five members, but the chief power was exercised as before by the members of a few noble families. In 1819, however, this feudal relic was supplanted by a new constitution. Two chambers were established, the one formed of nobles and the other of elected representatives; but although they were authorized to control the finances, their power with regard to legislation was very circumscribed. This constitution was sanctioned by the prince regent, afterwards King George IV.; but it was out of harmony with the new and liberal ideas which prevailed in Europe, and it hardly survived George's decease in 1830. The revolution of that year compelled George's brother and successor, William, to dismiss Count Münster, who had been the actual ruler of the country, and to name his own brother, Adolphus Frederick, duke of Cambridge, a viceroy of Hanover; one of the viceroy's earliest duties being to appoint a commission to draw up a new constitution. This was done, and after William had insisted upon certain alterations, it was accepted and promulgated in 1833. Representation was granted to the peasants; the two chambers were empowered to initiate legislation; ministers were made responsible for all acts of government; a civil list was given to the king in return for the surrender of the crown lands; and, in short, the new constitution was similar to that of Great

Britain. These liberal arrangements, however, did not entirely allay the discontent. A strong and energetic party endeavoured to thwart the working of the new order, and matters came to a climax on the death of William IV. in 1837.

By the law of Hanover a woman could not ascend the throne, and accordingly Ernest Augustus, duke of Cumberland, the fifth son of George III., and not Victoria, succeeded William as sovereign in 1837, thus separating the crowns of Great Britain and Hanover after a union of 123 years. Ernest, a prince with very autocratic ideas, had disapproved of the constitution of 1833, and his first important act as king was to declare it invalid. He appears to have been especially chagrined because the crown lands were not his personal property, but the whole of the new arrangements were repugnant to him. Seven Göttingen professors who protested against this proceeding were deprived of their chairs; and some of them, including F. C. Dahlmann and Jakob Grimm, were banished from the country for publishing their protest. To save the constitution an appeal was made to the German Confederation, which Hanover had joined in 1815; but the federal diet declined to interfere, and in 1840 Ernest altered the constitution to suit his own illiberal views. Recovering the crown lands, he abolished the principle of ministerial responsibility, the legislative power of the two chambers, and other reforms, virtually restoring affairs to their condition before 1833. The inevitable crisis was delayed until the stormy year 1848, when the king probably saved his crown by hastily giving back the constitution of 1833. Order, however, having been restored, in 1850 he dismissed the Liberal ministry and attempted to evade his concessions; a bitter struggle had just broken out when Ernest Augustus died in November 1851. During this reign the foreign policy of Hanover both within and without Germany had been coloured by jealousy of Prussia and by the king's autocratic ideas. Refusing to join the Prussian *Zollverein*, Hanover had become a member of the rival commercial union, the *Steuerverein*, three years before Ernest's accession; but as this union was not a great success the *Zollverein* was joined in 1851. In 1849, after the failure of the German parliament at Frankfort, the king had joined with the sovereigns of Prussia and Saxony to form the "three kings' alliance"; but this union with Prussia was unequal, and with the king of Saxony he soon transferred his support to Austria and became a member of the "four kings' alliance."

George V., the new king of Hanover, who was unfortunately blind, sharing his father's political ideas, at once appointed a ministry whose aim was to sweep away the constitution of 1848. This project, however, was resisted by the second chamber of the *Landtag*, or parliament; and after several changes of government a new ministry advised the king in 1855 to appeal to the diet of the German Confederation. This was done, and the diet declared the constitution of 1848 to be invalid. Acting on this verdict, not only was a ministry formed to restore the constitution of 1840, but after some trouble a body of members fully in sympathy with this object was returned to parliament in 1857. But these members were so far from representing the opinions of the people that popular resentment compelled George to dismiss his advisers in 1862. But the more liberal government which succeeded did not enjoy his complete confidence, and in 1865 a ministry was once more formed which was more in accord with his own ideas. This contest soon lost both interest and importance owing to the condition of affairs in Germany. Bismarck, the director of the policy of Prussia, was devising methods for the realization of his schemes, and it became clear after the war over the duchies of Schleswig and Holstein that the smaller German states would soon be obliged to decide definitely between Austria and Prussia. After a period of vacillation Hanover threw in her lot with Austria, the decisive step being taken when the question of the mobilization of the federal army was voted upon in the diet on the 14th of June 1866. At once Prussia requested Hanover to remain unarmed and neutral during the war, and with equal promptness King George refused to assent to these demands. Prussian troops then crossed his frontier and took possession of his capital.

The Hanoverians, however, were victorious at the battle of Langensalza on the 27th of June 1866, but the advance of fresh bodies of the enemy compelled them to capitulate two days later. By the terms of this surrender the king was not to reside in Hanover, his officers were to take no further part in the war, and his ammunition and stores became the property of Prussia. The decree of the 20th of September 1866 formally annexed Hanover to Prussia, when it became a province of that kingdom, while King George from his retreat at Hietzing appealed in vain to the powers of Europe. Many of the Hanoverians remained loyal to their sovereign; some of them serving in the Guelph Legion, which was maintained largely at his expense in France, where a paper, *La Situation*, was founded by Oskar Meding (1829-1903) and conducted in his interests. These and other elaborate efforts, however, failed to bring about the return of the king to Hanover, though the Guelph party continued to agitate and to hope even after the Franco-German War had immensely increased the power and the prestige of Prussia. George died in June 1878. His son, Ernest Augustus, duke of Cumberland, continued to maintain his claim to the crown of Hanover, and refused to be reconciled with Prussia. Owing to this attitude the German imperial government refused to allow him to take possession of the duchy of Brunswick, which he inherited on the extinction of the elder branch of his family in 1884, and again in 1906 when the same subject came up for settlement on the death of the regent, Prince Albert of Prussia.

In 1867 King George had agreed to accept Prussian bonds to the value of about £1,600,000 as compensation for the confiscation of his estates in Hanover. In 1868, however, on account of his continued hostility to Prussia, the Prussian government sequestered this property; and, known as the *Welfenfonds*, or *Reptilienfonds*, it was employed as a secret service fund to combat the intrigues of the Guelphs in various parts of Europe; until in 1892 it was arranged that the interest should be paid to the duke of Cumberland. In 1885 measures were taken to incorporate the province of Hanover more thoroughly in the kingdom of Prussia, and there is little doubt but that the great majority of the Hanoverians have submitted to the inevitable, and are loyal subjects of the king of Prussia.

AUTHORITIES.—A. Hüne, *Geschichte des Königreichs Hannover und des Herzogtums Braunschweig* (Hanover, 1824-1839); A. F. H. Schaumann, *Handbuch der Geschichte der Lande Hannover und Braunschweig* (Hanover, 1864); G. A. Grotefend, *Geschichte der allgemeinen landständischen Verfassung des Königreichs Hannover, 1814-1848* (Hanover, 1857); H. A. Oppermann, *Zur Geschichte des Königreichs Hannover, 1832-1860* (Berlin, 1868); E. von Meier, *Hannoversche Verfassungs- und Verwaltungsgeschichte* (Leipzig, 1898-1899); W. von Hassell, *Das Kurfürstentum Hannover vom Baseler Frieden bis zur preussischen Okkupation* (Hanover, 1894); and *Geschichte des Königreichs Hannover* (Leipzig, 1898-1901); H. von Treitschke, *Der Herzog von Cumberland und das hannoversche Staatsgrundgesetz von 1833* (Leipzig, 1888); M. Bär, *Übersicht über die Bestände des königlichen Staatsarchivs zu Hannover* (Leipzig, 1900); *Hannoversches Portfolio* (Stuttgart, 1839-1841); and the authorities given for the history of Brunswick.

HANOVER, the capital of the Prussian province of the same name, situated in a sandy but fertile plain on the Leine, which here receives the Ihme, 38 m. N.W. from Brunswick, 78 S.E. of Bremen, and at the crossing of the main lines of railway, Berlin to Cologne and Hamburg to Frankfurt-on-Main. Pop. (1885) 139,731; (1900) 235,666; (1905) 250,032. On the north and east the town is half encircled by the beautiful woods and groves of the Eilenriede and the List which form the public park. The Leine flows through the city, having the old town on its right and the quaint Calenberger quarter between its left bank and the Ihme. The old town is irregularly built, with narrow streets and old-fashioned gabled houses. In its centre lies the Markt Kirche, a red-brick edifice of the 14th century, containing interesting monuments and some fine stained-glass windows, and with a steeple 310 ft. in height (the highest in Hanover). Its interior was restored in 1855. Close by, on the market square, is the red-brick mediæval town-hall (Rathaus), with an historical wine cellar beneath. It has been superseded for municipal business by a new building, and now contains the civic archives and museum. The new town, surrounding the

old on the north and east, and lying between it and the woods referred to, has wide streets, handsome buildings and beautiful squares. Among the last-mentioned are the square at the railway station—the Ernst August-Platz—with an equestrian statue of King Ernest Augustus in bronze; the triangular Theater-Platz, with statues of the composer Marschner and others; and the Georgs-Platz, with a statue of Schiller. To the south of the old town, on the banks of the Ihme, lies the Waterloo-Platz, with a column of victory, 154 ft. high, having inscribed on it the names of 800 Hanoverians who fell at Waterloo. In the adjacent gardens an open rotunda encloses a marble bust of the philosopher Leibnitz, and near it is a monument to General Count von Alten, the commander of the Hanoverian troops at Waterloo. Among the other churches the most noticeable are the Neustädterkirche, with a graceful shrine containing the tomb of Leibnitz, the Kreuzkirche, built about 1300, with a curious steeple, and the Aegidienkirche among ancient edifices, and among modern ones the Christuskirche, a gift of King George V., the Lukaakirche, the Lutherkirche, and the Roman Catholic church of St Mary, with a tower 300 ft. high, containing the grave of Ludwig Windthorst, "his little excellency," for many years leader of the Ultramontane (Centre) party in the imperial diet. Of secular buildings the most remarkable is the royal palace—Schloss—built 1636-1640, with a grand portal and handsome quadrangle. In its chapel are preserved the relics of saints which Henry the Lion brought from Palestine. The new provincial museum built in 1897-1902 contains the Cumberland Gallery and the Guelph Museum; and the Kestner Museum also contains interesting and valuable collections of works of art. The other principal public buildings are the royal archives and library, containing a library of 200,000 volumes and 3500 manuscripts; the old provincial museum, which houses a variety of collections, such as natural, historical and ethnographical, and a collection of modern paintings; the theatre (built 1845-1852), one of the largest in Germany, the archaeological museum, the railway station, and, in the west, close to Herrenhausen (see below), the magnificent Welfenschloss (Guelph-palace). The last, begun in 1859, was almost completed in 1866, but was never occupied by the Hanoverian royal family. Since 1875 it has been occupied by the technical high school, an academy with university privileges. Close to it lies the famous Herrenhausen, the summer palace of the former kings of Hanover, with fine gardens, an open-air theatre, a museum and an orangery, and approached by a grand avenue over a mile in length.

Hanover has a number of colleges and schools, and is the seat of several learned societies. It is largely frequented by foreign students, especially English, attracted by the educational facilities it offers and by the reputed purity of the German spoken. Hanover is the headquarters of the X. Prussian army corps, has a large garrison of nearly all arms and a famous military riding school. It occupies a leading position among the industrial and commercial towns of the empire, and of recent years has made rapid progress in prosperity. It is connected by railway with Berlin, Hamburg, Bremen, Hameln, Cologne, Altenbeken and Cassel, and the facilities of intercourse have, under the fostering care of the Prussian government, enormously developed its trade and manufactures. Almost all industries are represented; chief among them are machine-building, the manufacture of india-rubber, linen, cloth, hardware, chemicals, tobacco, pianos, furniture and groceries. The commerce consists principally in wine, hides, horses, coal, wood and cereals. There are extensive printing establishments. Hanover was the first German town that was lighted with gas. It is the birthplace of Sir William Herschel, the astronomer, of the brothers Schlegel, of Iffland and of the historian Pertz. The philosopher Leibnitz died there in 1716.

Close by, on the left bank of the Leine, lies the manufacturing town of Linden, which, though practically forming one town with Hanover, is treated under a separate heading.

The town of Hanover is first mentioned during the 12th century. It belonged to the family of Welf, then to the bishops of Hildesheim, and then, in 1369, it came again into the possession

of the Welfs, now dukes of Brunswick. It joined the Hanseatic League, and was later the residence of the branch of the ducal house, which received the title of elector of Hanover and ascended the British throne in the person of George I. One or two important treaties were signed in Hanover, which from 1810 to 1813 was part of the kingdom of Westphalia, and in 1866 was annexed by Prussia, after having been the capital of the kingdom of Hanover since its foundation in 1815.

See O. Ulrich, *Bilder aus Hannovers Vergangenheit* (1891); Hoppe, *Geschichte der Stadt Hannover* (1845); Hirschfeld, *Hannovers Grossindustrie und Grosshandel* (Leipzig, 1891); Frensdorff, *Die Stadtverfassung Hannovers in alter und neuer Zeit* (Leipzig, 1883); W. Bahrdt, *Geschichte der Reformation der Stadt Hannover* (1891); Hartmann, *Geschichte von Hannover mit besonderer Rücksichtnahme auf die Entwicklung der Residenzstadt Hannover* (1886); *Hannover und Umgegend, Entwicklung und Zustände seiner Industrie und Gewerbe* (1874); and the *Urkundenbuch der Stadt Hannover* (1860, fol.).

HANOVER, a town of Jefferson county, Indiana, U.S.A., on the Ohio river, about 5 m. below Madison. Pop. (1900) 377; (1910) 356. It is served by boats on the Ohio river and by stages to Madison, the nearest railway station. Along the border of the town and on a bluff rising about 500 ft. above the river is Hanover College, an institution under Presbyterian control, embracing a college and a preparatory department, and offering classical and scientific courses and instruction in music; there is no charge for tuition. In 1908-1909 there were 211 students, 75 being in the Academy. The institution was opened in a log cabin in 1827, was incorporated as Hanover Academy in 1828, was adopted as a synodical school by the Presbyterian Synod of Indiana in 1830 on condition that a Theological department be added, and in 1833 was incorporated under its present name. In 1840, however, the theological department became a separate institution and was removed to New Albany, whence in 1850 it was removed to Chicago, where it was named, first, the Presbyterian Theological Seminary of the North-west, and, in 1886, the McCormick Theological Seminary. In the years immediately after its incorporation in 1833 Hanover College introduced the "manual labor system" and was for a time very prosperous, but the system was not a success, the college ran into debt, and in 1843 the trustees attempted to surrender the charter and to acquire the charter of a university at Madison. This effort was opposed by a strong party, which secured a more liberal charter for the college. In 1880 the college became coeducational.

HANOVER, a township of Grafton county, New Hampshire, U.S.A., on the Connecticut river, 75 m. by rail N.W. of Concord. Pop. (1900) 1884; (1910) 2075. No railway enters this township; the Ledyard Free Bridge (the first free-bridge across the Connecticut) connects it with Norwich, Vt., which is served by the Boston & Maine railway. Ranges of rugged hills, broken by deep narrow gorges and by the wider valley of Mink Brook, rise near the river and culminate in the E. section in Moose Mountain, 2326 ft. above the sea. Near the foot of Moose Mountain is the birthplace of Laura D. Bridgman. Agriculture, dairying and lumbering are the chief pursuits of the inhabitants. The village of Hanover, the principal settlement of the township, occupies Hanover Plain in the S.W. corner, and is the seat of Dartmouth College (q.v.), which has a strikingly beautiful campus, and among its buildings several excellent examples of the colonial style, notably Dartmouth Hall. The Mary Hitchcock memorial hospital, a cottage hospital of 36 beds, was erected in 1890-1893 by Hiram Hitchcock in memory of his wife. The charter of the township was granted by Gov. Benning Wentworth on the 4th of July 1761, and the first settlement was made in May 1765. The records of the town meetings and selectmen, 1761-1818, have been published by E. P. Storrs (Hanover, 1905).

See Frederick Chase, *A History of Dartmouth College and the Town of Hanover* (Cambridge, 1891).

HANOVER, a borough of York county, Pennsylvania, U.S.A., 36 m. S. by W. of Harrisburg, and 6 m. from the S. border of the state. Pop. (1890) 3746; (1900) 5302, (133 foreign-born); (1910) 7057. It is served by the Northern Central and the Western Maryland railways. The borough is built on nearly

level ground in the fertile valley of the Conewago, at the point of intersection of the turnpike roads leading to Baltimore, Carlisle, York and Frederick, from which places the principal streets—sections of these roads—are named. Among its manufactures are foundry and machine-shop products, flour, silk, waggons, shoes, gloves, furniture, wire cloth and cigars. The settlement of the place was begun mostly by Germans during the middle of the 18th century. Hanover was laid out in 1763 or 1764 by Col. Richard MacAllister; and in 1815 it was incorporated. On the 30th of June 1863 there was a cavalry engagement in and near Hanover between the forces of Generals H. J. Kilpatrick (Union) and J. E. B. Stuart (Confederate) preliminary to the battle of Gettysburg. This engagement is commemorated by an equestrian statue erected in Hanover by the state.

HANRIOT, FRANÇOIS (1761-1794), French revolutionist, was born at Nanterre (Seine) of poor parentage. Having lost his first employment—with a *procureur*—through dishonesty, he obtained a clerkship in the Paris *octroi* in 1789, but was dismissed for abandoning his post when the Parisians burned the *octroi* barriers on the night of the 12th-13th of July 1789. After leading a hand-to-mouth existence for some time, he became one of the orators of the section of the *sans-culottes*, and commanded the armed force of that section during the insurrection on the 10th of August 1792 and the massacres of September. But he did not come into prominence until the night of the 30th-31st of May 1793, when he was provisionally appointed commandant-general of the armed forces of Paris by the council general of the Commune. On the 31st of May he was one of the delegates from the Commune to the Convention demanding the dissolution of the Commission of Twelve and the proscription of the Girondists (q.v.), and he was in command of the insurrectionary forces of the Commune during the *émée* of the 2nd of June (see FRENCH REVOLUTION). On the 11th of June he resigned his command, declaring that order had been restored. On the 13th he was impeached in the Convention; but the motion was not carried, and on the 1st of July he was elected by the Commune permanent commander of the armed forces of Paris. This position, which gave him enormous power, he retained until the revolution of the 9th Thermidor (July 27, 1794). His arrest was decreed; but he had the *général* sounded and the tocsin rung, and tried to rescue Robespierre, who was under arrest in the hall of the *Comité de Salut Générale*. Hanriot was himself arrested, but was rescued by his adherents, and hastened to the Hôtel de Ville. After a vain attempt to organize resistance he fled and hid in a secluded yard, where he was discovered the next day. He was arrested, sentenced to death, and guillotined with Robespierre and his friends on the 10th Thermidor of the year II. (the 28th of July 1794).

HANSARD, LUKE (1752-1828), English printer, was born on the 5th of July 1752 in St Mary's parish, Norwich. He was educated at Boston grammar school, and was apprenticed to Stephen White, a Norwich printer. As soon as his apprenticeship had expired Hansard started for London with only a guinea in his pocket, and became a compositor in the office of John Hughs (1703-1771), printer to the House of Commons. In 1774 he was made a partner, and undertook almost the entire conduct of the business, which in 1800 came completely into his hands. On the admission of his sons the firm became Luke Hansard & Sons. Among those whose friendship Hansard won in the exercise of his profession were Robert Orme, Burke and Dr Johnson; while Porson praised him as the most accurate printer of Greek. He printed the *Journals of the House of Commons* from 1774 till his death. The promptitude and accuracy with which Hansard printed parliamentary papers were often of the greatest service to government—notably on one occasion when the proof-sheets of the report of the Secret Committee on the French Revolution were submitted to Pitt twenty-four hours after the draft had left his hands. On the union with Ireland in 1801, the increase of parliamentary printing compelled Hansard to give up all private printing except when parliament was not sitting. He devised numerous expedients for reducing the expense of publishing the reports; and in 1805, when his workmen struck at a time

of great pressure, he and his sons themselves set to work as compositors. Luke Hansard died on the 29th of October 1828.

His son, THOMAS CURSON HANSARD (1776-1833), established a press of his own in Paternoster Row, and began in 1803 to print the *Parliamentary Debates*, which were not at first independent reports, but were taken from the newspapers. After 1889 the debates were published by the Hansard Publishing Union Limited. T. C. Hansard was the author of *Typographia, an Historical Sketch of the Origin and Progress of the Art of Printing* (1825). The original business remained in the hands of his younger brothers, James and Luke Graves Hansard (1777-1851). The firm was prosecuted in 1837 by John Joseph Stockwell for printing by order of the House of Commons, in an official report of the inspector of prisons, statements regarded by the plaintiff as libellous. Hansard sheltered himself on the ground of privilege, but it was not until after much litigation that the security of the printers of government reports was guaranteed by statute in 1840.

HANSEATIC LEAGUE. It is impossible to assign any precise date for the beginning of the Hanseatic League or to name any single factor which explains the origin of that loose but effective federation of North German towns. Associated action and partial union among these towns can be traced back to the 13th century. In 1241 we find Lübeck and Hamburg agreeing to safeguard the important road connecting the Baltic and the North Sea. The first known meeting of the "maritime towns," later known as the Wendish group and including Lübeck, Hamburg, Lüneburg, Wismar, Rostock and Stralsund, took place in 1256. The Saxon towns, during the following century, were joining to protect their common interests, and indeed at this period town confederacies in Germany, both North and South, were so considerable as to call for the declaration against them in the Golden Bull of 1356. The decline of the imperial power and the growing opposition between the towns and the territorial princes justified these defensive town alliances, which in South Germany took on a peculiarly political character. The relative weakness of territorial power in the North, after the fall of Henry the Lion of Saxony, diminished without however removing this motive for union, but the comparative immunity from princely aggression on land left the towns freer to combine in a stronger and more permanent union for the defence of their commerce by sea and for the control of the Baltic.

While the political element in the development of the Hanseatic League must not be underestimated, it was not so formative as the economic. The foundation was laid for the growth of German towns along the southern shore of the Baltic by the great movement of German colonization of Slavic territory east of the Elbe. This movement, extending in time from about the middle of the 11th to the middle of the 13th century and carrying a stream of settlers and traders from the Northwest, resulted not only in the Germanization of a wide territory but in the extension of German influence along the sea-coast far to the east of actual territorial settlement. The German trading towns, at the mouths of the numerous streams which drain the North European plain, were stimulated or created by the unifying impulse of a common and long-continued advance of conquest and colonization.

The impetus of this remarkable movement of expansion not only carried German trade to the East and North within the Baltic basin, but reanimated the older trade from the lower Rhine region to Flanders and England in the West. Cologne and the Westphalian towns, the most important of which were Dortmund, Soest and Münster, had long controlled this commerce but now began to feel the competition of the active traders of the Baltic, opening up that direct communication by sea from the Baltic to western Europe which became the essential feature in the history of the League. The necessity of seeking protection from the sea-rovers and pirates who infested these waters during the whole period of Hanseatic supremacy, the legal customs, substantially alike in the towns of North Germany, which governed the groups of traders in the outlying trading posts, the establishment of common factories, or "counters" (Kontors)

at these points, with aldermen to administer justice and to secure trading privileges for the community of German merchants—such were some of the unifying influences which preceded the gradual formation of the League. In the century of energetic commercial development before 1350 the German merchants abroad led the way.

Germans were early pushing as permanent settlers into the Scandinavian towns, and in Wisby, on the island of Gotland, the Scandinavian centre of Baltic trade, equal rights as citizens in the town government were possessed by the German settlers as early as the beginning of the 13th century. There also came into existence at Wisby the first association of German traders abroad, which united the merchants of over thirty towns, from Cologne and Utrecht in the West to Revel in the East. We find the Gotland association making in 1229 a treaty with a Russian prince and securing privileges for their branch trading station at Novgorod. According to the "Skra," the by-laws of the Novgorod branch, the four aldermen of the community of Germans, who among other duties held the keys of the common chest, deposited in Wisby, were to be chosen from the merchants of the Gotland association and of the towns of Lübeck, Soest and Dortmund. The Gotland association received in 1237 trading rights in England, and shortly after the middle of the century it also secured privileges in Flanders. It legislated on matters relating to common trade interests, and, in the case of the regulation of 1287 concerning shipwrecked goods, we find it imposing this legislation on the towns under the penalty of exclusion from the association. But with the extension of the East and West trade beyond the confines of the Baltic, this association by the end of the century was losing its position of leadership. Its inheritance passed to the gradually forming union of towns, chiefly those known as Wendish, which looked to Lübeck as their head. In 1293 the Saxon and Wendish merchants at Rostock decided that all appeals from Novgorod be taken to Lübeck instead of to Wisby, and six years later the Wendish and Westphalian towns, meeting at Lübeck, ordered that the Gotland association should no longer use a common seal. Though Lübeck's right as court of appeal from the Hanseatic counter at Novgorod was not recognized by the general assembly of the League until 1373, the long-existing practice had simply accorded with the actual shifting of commercial power. The union of merchants abroad was beginning to come under the control of the partial union of towns at home.

A similar and contemporary extension of the influence of the Baltic traders under Lübeck's leadership may be witnessed in the West. As a consequence of the close commercial relations early existing between England and the Rhenish-Westphalian towns, the merchants of Cologne were the first to possess a guild-hall in London and to form a "hansa" with the right of admitting other German merchants on payment of a fee. The charter of 1226, however, by which Emperor Frederick II. created Lübeck a free imperial city, expressly declared that Lübeck citizens trading in England should be free from the dues imposed by the merchants of Cologne and should enjoy equal rights and privileges. In 1266 and 1267 the merchants of Hamburg and Lübeck received from Henry III. the right to establish their own hansas in London, like that of Cologne. The situation thus created led by 1282 to the coalescence of the rival associations in the "Gild-hall of the Germans," but though the Baltic traders had secured a recognized foothold in the enlarged and unified organization, Cologne retained the controlling interest in the London settlement until 1476. Lübeck and Hamburg, however, dominated the German trade in the ports of the east coast, notably in Lynn and Boston, while they were strong in the organized trading settlements at York, Hull, Ipswich, Norwich, Yarmouth and Bristol. The counter at London, first called the Steelyard in a parliamentary petition of 1422, claimed jurisdiction over the other factories in England.

In Flanders, also, the German merchants from the West had long been trading, but here had later to endure not only the rivalry but the pre-eminence of those from the East. In 1252 the first treaty privileges for German trade in Flanders show

two men of Lübeck and Hamburg heading the "Merchants of the Roman Empire," and in the later organization of the counter at Bruges four or five of the six aldermen were chosen from towns east of the Elbe, with Lübeck steadily predominant. The Germans recognized the staple rights of Bruges for a number of commodities, such as wool, wax, furs, copper and grain, and in return for this material contribution to the growing commercial importance of the town, they received in 1309 freedom from the compulsory brokerage which Bruges imposed on foreign merchants. The importance and independence of the German trading settlements abroad was exemplified in the statutes of the "Company of German merchants at Bruges," drawn up in 1347, where for the first time appears the grouping of towns in three sections (the "Drittel"), the Wendish-Saxon, the Prussian-Westphalian, and those of Gothland and Livland. Even more important than the assistance which the concentration of the German trade at Bruges gave to that leading mart of European commerce was the service rendered by the German counter of Bruges to the cause of Hanseatic unity. Not merely because of its central commercial position, but because of its width of view, its political insight, and its constant insistence on the necessity of union, this counter played a leading part in Hanseatic policy. It was more Hanse than the Hanse towns.

The last of the chief trading settlements, both in importance and in date of organization, was that at Bergen in Norway, where in 1343 the Hansatics obtained special trade privileges. Scandinavia had early been sought for its copper and iron, its forest products and its valuable fisheries, especially of herring at Schonen, but it was backward in its industrial development and its own commerce had seriously declined in the 14th century. It had come to depend largely upon the Germans for the importation of all its luxuries and of many of its necessities, as well as for the exportation of its products, but regular trade with the three kingdoms was confined for the most part to the Wendish towns, with Lübeck steadily asserting an exclusive ascendancy. The fishing centre at Schonen was important as a market, though, like Novgorod, its trade was seasonal, but it did not acquire the position of a regularly organized counter, reserved alone, in the North, for Bergen. The commercial relations with the North cannot be regarded as an important element in the union of the Hanse towns, but the geographical position of the Scandinavian countries, especially that of Denmark, commanding the Sound which gives access to the Baltic, compelled a close attention to Scandinavian politics on the part of Lübeck and the League and thus by necessitating combined political action in defence of Hanseatic sea-power exercised a unifying influence.

Energetic and successful though the scattered trading settlements had been in establishing German trade connexions and in securing valuable trade privileges, the middle of the 14th century found them powerless to meet difficulties arising from internal dissension and still more from the political rivalries and trade jealousies of nascent nationalities. Flanders became a battle-field in the great struggle between France and England, and the war of trade prohibitions led to infractions of the German privileges in Bruges. An embargo on trade with Flanders, voted in 1358 by a general assembly, resulted by 1360 in the full restoration of German privileges in Flanders, but reduced the counter at Bruges to an executive organ of a united town policy. It is worth noting that in a document connected with this action the union of towns, borrowing the term from English usage, was first called the "German Hansa." In 1361 representatives from Lübeck and Wisby visited Novgorod to recodify the by-laws of the counter and to admonish it that new statutes required the consent of Lübeck, Wisby, Riga, Dorpat and Reval. This action was confirmed in 1366 by an assembly of the Hansa which at the same time, on the occasion of a regulation made by the Bruges counter and of statutes drawn up by the young Bergen counter, ordered that in future the approval of the towns must be obtained for all new regulations.

The counter at London was soon forced to follow the example of the other counters at Bruges, Novgorod and Bergen. After the failure of the Italians, the Hansatics remained the strongest

group of alien merchants in England, and, as such, claimed the exclusive enjoyment of the privileges granted by the *Carla Mercatoria* of 1303. Their highly favoured position in England, contrasting markedly with their refusal of trade facilities to the English in some of the Baltic towns and their evident policy of monopoly in the Baltic trade, incensed the English mercantile classes, and doubtless influenced the increases in customs-duties which were regarded by the Germans as contrary to their treaty rights. Unsuccessful in obtaining redress from the English government, the German merchants finally, in 1374, appealed for aid to the home towns, especially to Lübeck. The result of Hanseatic representations was the confirmation by Richard II, in 1377 of all their privileges, which accorded them the preferential treatment they had claimed and became the foundation of the Hanseatic position in England.

In the meanwhile, the conquest of Wisby by Waldemar IV. of Denmark in 1361 had disclosed his ambition for the political control of the Baltic. He was promptly opposed by an alliance of Hanse towns, led by Lübeck. The defeat of the Germans at Helsingborg only called into being the stronger town and territorial alliance of 1367, known as the Cologne Confederation, and its final victory, with the peace of Stralsund in 1370, which gave for a limited period the four chief castles on the Sound into the hands of the Hanseatic towns, greatly enhanced the prestige of the League.

The assertion of Hanseatic influence in the two decades, 1356 to 1377, marks the zenith of the League's power and the completion of the long process of unification. Under the pressure of commercial and political necessity, authority was definitely transferred from the Hansas of merchants abroad to the Hansa of towns at home, and the sense of unity had become such that in 1380 a Lübeck official could declare that "whatever touches one town touches all." But even at the time when union was most important, this statement went further than the facts would warrant, and in the course of the following century it became less and less true. Dortmund held aloof from the Cologne Confederation on the ground that it had no concern in Scandinavian politics. It became, indeed, increasingly difficult to obtain the support of the inland towns for a policy of sea-power in the Baltic. Cologne sent no representatives to the regular Hanseatic assemblies until 1383, and during the 15th century its independence was frequently manifested. It rebelled at the authority of the counter at Bruges, and at the time of the war with England (1469-1474) openly defied the League. In the East, the German Order, while enjoying Hanseatic privileges, frequently opposed the policy of the League abroad, and was only prevented by domestic troubles and its Hinterland enemies from playing its own hand in the Baltic. After the fall of the order in 1467, the towns of Prussia and Livland, especially Dantzic and Riga, pursued an exclusive trade policy even against their Hanseatic confederates. Lübeck, however, supported by the Bruges counter, despite the disaffection and jealousy on all sides hampering and sometimes thwarting its efforts, stood steadfastly for union and the necessity of obedience to the decrees of the assemblies. Its headship of the League, hitherto tacitly accepted, was definitely recognized in 1418.

The governing body of the Hansa was the assembly of town representatives, the "Hansetage," held irregularly as occasion required at the summons of Lübeck, and, with few exceptions, attended but scantily. The delegates were bound by instructions from their towns and had to report home the decisions of the assembly for acceptance or rejection. In 1469 the League declared that the English use of the terms "societas," "collegium" and "universitas" was inappropriate to so loose an organization. It preferred to call itself a "firma confederatio" for trade purposes only. It had no common seal, though that of Lübeck was accepted, particularly by foreigners, in behalf of the League. Disputes between the confederate towns were brought for adjudication before the general assembly, but the League had no recognized federal judiciary. Lübeck, with the counters abroad, watched over the execution of the measures voted by the assembly, but there was no regular administrative

of great pressure, he and his sons themselves set to work as compositors. Luke Hansard died on the 29th of October 1828.

His son, THOMAS CURSON HANSARD (1776-1833), established a press of his own in Paternoster Row, and began in 1803 to print the *Parliamentary Debates*, which were not at first independent reports, but were taken from the newspapers. After 1889 the debates were published by the Hansard Publishing Union Limited. T. C. Hansard was the author of *Typographia, an Historical Sketch of the Origin and Progress of the Art of Printing* (1825). The original business remained in the hands of his younger brothers, James and Luke Graves Hansard (1777-1851). The firm was prosecuted in 1837 by John Joseph Stockwell for printing by order of the House of Commons, in an official report of the inspector of prisons, statements regarded by the plaintiff as libellous. Hansard sheltered himself on the ground of privilege, but it was not until after much litigation that the security of the printers of government reports was guaranteed by statute in 1840.

HANSEATIC LEAGUE. It is impossible to assign any precise date for the beginning of the Hanseatic League or to name any single factor which explains the origin of that loose but effective federation of North German towns. Associated action and partial union among these towns can be traced back to the 13th century. In 1241 we find Lübeck and Hamburg agreeing to safeguard the important road connecting the Baltic and the North Sea. The first known meeting of the "maritime towns," later known as the Wendish group and including Lübeck, Hamburg, Lüneburg, Wismar, Rostock and Stralsund, took place in 1256. The Saxon towns, during the following century, were joining to protect their common interests, and indeed at this period town confederacies in Germany, both North and South, were so considerable as to call for the declaration against them in the Golden Bull of 1356. The decline of the imperial power and the growing opposition between the towns and the territorial princes justified these defensive town alliances, which in South Germany took on a peculiarly political character. The relative weakness of territorial power in the North, after the fall of Henry the Lion of Saxony, diminished without however removing this motive for union, but the comparative immunity from princely aggression on land left the towns freer to combine in a stronger and more permanent union for the defence of their commerce by sea and for the control of the Baltic.

While the political element in the development of the Hanseatic League must not be underestimated, it was not so formative as the economic. The foundation was laid for the growth of German towns along the southern shore of the Baltic by the great movement of German colonization of Slavic territory east of the Elbe. This movement, extending in time from about the middle of the 11th to the middle of the 13th century and carrying a stream of settlers and traders from the Northwest, resulted not only in the Germanization of a wide territory but in the extension of German influence along the sea-coast far to the east of actual territorial settlement. The German trading towns, at the mouths of the numerous streams which drain the North European plain, were stimulated or created by the unifying impulse of a common and long-continued advance of conquest and colonization.

The impetus of this remarkable movement of expansion not only carried German trade to the East and North within the Baltic basin, but reanimated the older trade from the lower Rhine region to Flanders and England in the West. Cologne and the Westphalian towns, the most important of which were Dortmund, Soest and Münster, had long controlled this commerce but now began to feel the competition of the active traders of the Baltic, opening up that direct communication by sea from the Baltic to western Europe which became the essential feature in the history of the League. The necessity of seeking protection from the sea-rovers and pirates who infested these waters during the whole period of Hanseatic supremacy, the legal customs, substantially alike in the towns of North Germany, which governed the groups of traders in the outlying trading posts, the establishment of common factories, or "counters" (Kontors)

at these points, with aldermen to administer justice and to secure trading privileges for the community of German merchants—such were some of the unifying influences which preceded the gradual formation of the League. In the century of energetic commercial development before 1350 the German merchants abroad led the way.

Germans were early pushing as permanent settlers into the Scandinavian towns, and in Wisby, on the island of Gotland, the Scandinavian centre of Baltic trade, equal rights as citizens in the town government were possessed by the German settlers as early as the beginning of the 13th century. There also came into existence at Wisby the first association of German traders abroad, which united the merchants of over thirty towns, from Cologne and Utrecht in the West to Reval in the East. We find the Gotland association making in 1229 a treaty with a Russian prince and securing privileges for their branch trading station at Novgorod. According to the "Skra," the by-laws of the Novgorod branch, the four aldermen of the community of Germans, who among other duties held the keys of the common chest, deposited in Wisby, were to be chosen from the merchants of the Gotland association and of the towns of Lübeck, Soest and Dortmund. The Gotland association received in 1237 trading rights in England, and shortly after the middle of the century it also secured privileges in Flanders. It legislated on matters relating to common trade interests, and, in the case of the regulation of 1287 concerning shipwrecked goods, we find it imposing this legislation on the towns under the penalty of exclusion from the association. But with the extension of the East and West trade beyond the confines of the Baltic, this association by the end of the century was losing its position of leadership. Its inheritance passed to the gradually forming union of towns, chiefly those known as Wendish, which looked to Lübeck as their head. In 1293 the Saxon and Wendish merchants at Rostock decided that all appeals from Novgorod be taken to Lübeck instead of to Wisby, and six years later the Wendish and Westphalian towns, meeting at Lübeck, ordered that the Gotland association should no longer use a common seal. Though Lübeck's right as court of appeal from the Hanseatic counter at Novgorod was not recognized by the general assembly of the League until 1373, the long-existing practice had simply accorded with the actual shifting of commercial power. The union of merchants abroad was beginning to come under the control of the partial union of towns at home.

A similar and contemporary extension of the influence of the Baltic traders under Lübeck's leadership may be witnessed in the West. As a consequence of the close commercial relations early existing between England and the Rhenish-Westphalian towns, the merchants of Cologne were the first to possess a guild-hall in London and to form a "hansa" with the right of admitting other German merchants on payment of a fee. The charter of 1226, however, by which Emperor Frederick II. created Lübeck a free imperial city, expressly declared that Lübeck citizens trading in England should be free from the dues imposed by the merchants of Cologne and should enjoy equal rights and privileges. In 1266 and 1267 the merchants of Hamburg and Lübeck received from Henry III. the right to establish their own hansas in London, like that of Cologne. The situation thus created led by 1282 to the coalescence of the rival associations in the "Gild-hall of the Germans," but though the Baltic traders had secured a recognized foothold in the enlarged and unified organization, Cologne retained the controlling interest in the London settlement until 1476. Lübeck and Hamburg, however, dominated the German trade in the ports of the east coast, notably in Lynn and Boston, while they were strong in the organized trading settlements at York, Hull, Ipswich, Norwich, Yarmouth and Bristol. The counter at London, first called the Steelyard in a parliamentary petition of 1422, claimed jurisdiction over the other factories in England.

In Flanders, also, the German merchants from the West had long been trading, but here had later to endure not only the rivalry but the pre-eminence of those from the East. In 1252 the first treaty privileges for German trade in Flanders show

two men of Lübeck and Hamburg heading the "Merchants of the Roman Empire," and in the later organization of the counter at Bruges four or five of the six aldermen were chosen from towns east of the Elbe, with Lübeck steadily predominant. The Germans recognized the staple rights of Bruges for a number of commodities, such as wool, wax, furs, copper and grain, and in return for this material contribution to the growing commercial importance of the town, they received in 1309 freedom from the compulsory brokerage which Bruges imposed on foreign merchants. The importance and independence of the German trading settlements abroad was exemplified in the statutes of the "Company of German merchants at Bruges," drawn up in 1347, where for the first time appears the grouping of towns in three sections (the "Dritt"), the Wendish-Saxon, the Prussian-Westphalian, and those of Gothland and Livland. Even more important than the assistance which the concentration of the German trade at Bruges gave to that leading mart of European commerce was the service rendered by the German counter of Bruges to the cause of Hanseatic unity. Not merely because of its central commercial position, but because of its width of view, its political insight, and its constant insistence on the necessity of union, this counter played a leading part in Hanseatic policy. It was more Hanse than the Hanse towns.

The last of the chief trading settlements, both in importance and in date of organization, was that at Bergen in Norway, where in 1343 the Hanseatics obtained special trade privileges. Scandinavia had early been sought for its copper and iron, its forest products and its valuable fisheries, especially of herring at Schonen, but it was backward in its industrial development and its own commerce had seriously declined in the 14th century. It had come to depend largely upon the Germans for the importation of all its luxuries and of many of its necessities, as well as for the exportation of its products, but regular trade with the three kingdoms was confined for the most part to the Wendish towns, with Lübeck steadily asserting an exclusive ascendancy. The fishing centre at Schonen was important as a market, though, like Novgorod, its trade was seasonal, but it did not acquire the position of a regularly organized counter, reserved alone, in the North, for Bergen. The commercial relations with the North cannot be regarded as an important element in the union of the Hanse towns, but the geographical position of the Scandinavian countries, especially that of Denmark, commanding the Sound which gives access to the Baltic, compelled a close attention to Scandinavian politics on the part of Lübeck and the League and thus by necessitating combined political action in defence of Hanseatic sea-power exercised a unifying influence.

Energetic and successful though the scattered trading settlements had been in establishing German trade connexions and in securing valuable trade privileges, the middle of the 14th century found them powerless to meet difficulties arising from internal dissension and still more from the political rivalries and trade jealousies of nascent nationalities. Flanders became a battle-field in the great struggle between France and England, and the war of trade prohibitions led to infractions of the German privileges in Bruges. An embargo on trade with Flanders, voted in 1358 by a general assembly, resulted by 1360 in the full restoration of German privileges in Flanders, but reduced the counter at Bruges to an executive organ of a united town policy. It is worth noting that in a document connected with this action the union of towns, borrowing the term from English usage, was first called the "German Hansa." In 1361 representatives from Lübeck and Wisby visited Novgorod to recodify the by-laws of the counter and to admonish it that new statutes required the consent of Lübeck, Wisby, Riga, Dorpat and Reval. This action was confirmed in 1366 by an assembly of the Hansa which at the same time, on the occasion of a regulation made by the Bruges counter and of statutes drawn up by the young Bergen counter, ordered that in future the approval of the towns must be obtained for all new regulations.

The counter at London was soon forced to follow the example of the other counters at Bruges, Novgorod and Bergen. After the failure of the Italians, the Hanseatics remained the strongest

group of alien merchants in England, and, as such, claimed the exclusive enjoyment of the privileges granted by the *Carta Mercatoria* of 1303. Their highly favoured position in England, contrasting markedly with their refusal of trade facilities to the English in some of the Baltic towns and their evident policy of monopoly in the Baltic trade, incensed the English mercantile classes, and doubtless influenced the increases in customs-duties which were regarded by the Germans as contrary to their treaty rights. Unsuccessful in obtaining redress from the English government, the German merchants finally, in 1374, appealed for aid to the home towns, especially to Lübeck. The result of Hanseatic representations was the confirmation by Richard II. in 1377 of all their privileges, which accorded them the preferential treatment they had claimed and became the foundation of the Hanseatic position in England.

In the meanwhile, the conquest of Wisby by Waldemar IV. of Denmark in 1361 had disclosed his ambition for the political control of the Baltic. He was promptly opposed by an alliance of Hanse towns, led by Lübeck. The defeat of the Germans at Helsingborg only called into being the stronger town and territorial alliance of 1367, known as the Cologne Confederation, and its final victory, with the peace of Stralsund in 1370, which gave for a limited period the four chief castles on the Sound into the hands of the Hanseatic towns, greatly enhanced the prestige of the League.

The assertion of Hanseatic influence in the two decades, 1356 to 1377, marks the zenith of the League's power and the completion of the long process of unification. Under the pressure of commercial and political necessity, authority was definitely transferred from the Hansas of merchants abroad to the Hansa of towns at home, and the sense of unity had become such that in 1380 a Lübeck official could declare that "whatever touches one town touches all." But even at the time when union was most important, this statement went further than the facts would warrant, and in the course of the following century it became less and less true. Dortmund held aloof from the Cologne Confederation on the ground that it had no concern in Scandinavian politics. It became, indeed, increasingly difficult to obtain the support of the inland towns for a policy of sea-power in the Baltic. Cologne sent no representatives to the regular Hanseatic assemblies until 1383, and during the 15th century its independence was frequently manifested. It rebelled at the authority of the counter at Bruges, and at the time of the war with England (1469-1474) openly defied the League. In the East, the German Order, while enjoying Hanseatic privileges, frequently opposed the policy of the League abroad, and was only prevented by domestic troubles and its Hinterland enemies from playing its own hand in the Baltic. After the fall of the order in 1467, the towns of Prussia and Livland, especially Dantzic and Riga, pursued an exclusive trade policy even against their Hanseatic confederates. Lübeck, however, supported by the Bruges counter, despite the disaffection and jealousy on all sides hampering and sometimes thwarting its efforts, stood steadfastly for union and the necessity of obedience to the decrees of the assemblies. Its headship of the League, hitherto tacitly accepted, was definitely recognized in 1418.

The governing body of the Hansa was the assembly of town representatives, the "Hansetage," held irregularly as occasion required at the summons of Lübeck, and, with few exceptions, attended but scantily. The delegates were bound by instructions from their towns and had to report home the decisions of the assembly for acceptance or rejection. In 1469 the League declared that the English use of the terms "societas," "collegium" and "universitas" was inappropriate to so loose an organization. It preferred to call itself a "firma confederatio" for trade purposes only. It had no common seal, though that of Lübeck was accepted, particularly by foreigners, in behalf of the League. Disputes between the confederate towns were brought for adjudication before the general assembly, but the League had no recognized federal judiciary. Lübeck, with the counters abroad, watched over the execution of the measures voted by the assembly, but there was no regular administrative

d'un voyage en Sibérie, 1857); but the chief work was not issued till 1863 (*Resultate magnetischer Beobachtungen*, &c.). Shortly after the return of the mission, an observatory was erected in the park of Christiania (1833), and Hansteen was appointed director. On his representation a magnetic observatory was added in 1839. In 1835-1838 he published text-books on geometry and mechanics; and in 1842 he wrote his *Disquisitiones de mutationibus quas patitur momentum acus magneticæ*, &c. He also contributed various papers to different scientific journals, especially the *Magazin for Naturvidenskaberne*, of which he became joint-editor in 1823. He superintended the trigonometrical and topographical survey of Norway, begun in 1837. In 1861 he retired from active work, but still pursued his studies, his *Observations de l'inclinaison magnétique* and *Sur les variations séculaires du magnétisme* appearing in 1865. He died at Christiania on the 11th of April 1873.

HANTHAWADDY, a district in the Pegu division of Lower Burma, the home district of Rangoon, from which the town was detached to make a separate district in 1880. It has an area of 3023 sq. m., with a population in 1901 of 484,811, showing an increase of 22% in the decade. Hanthawaddy and Henzada are the two most densely populated districts in the province. It consists of a vast plain stretching up from the sea between the To or China Bakir mouth of the Irrawaddy and the Pegu Yomas. Except the tract lying between the Pegu Yomas on the east and the Hlaing river, the country is intersected by numerous tidal creeks, many navigable by large boats and some by steamers. The headquarters of the district are in Rangoon, which is also the sub-divisional headquarters. The second sub-division has its headquarters at Insein, where there are large railway works. Cultivation is almost wholly confined to rice, but there are many vegetable and fruit gardens.

HANUKKAH, a Jewish festival, the "Feast of Dedication" (cf. John x. 22) or the "Feast of the Maccabees," beginning on the 25th day of the ninth month *Kislev* (December), of the Hebrew ecclesiastical year, and lasting eight days. It was instituted in 165 B.C. in commemoration of, and thanksgiving for, the purification of the temple at Jerusalem on this day by Judas Maccabæus after its pollution by Antiochus Epiphanes, king of Syria, who in 168 B.C. set up a pagan altar to Zeus Olympius. The Talmudic sources say that when the perpetual lamp of the temple was to be relighted only one flask of holy oil sufficient for the day remained, but this miraculously lasted for the eight days (cf. the legend in 2 Macc. i. 18). In memory of this the Jews burn both in synagogues and in houses on the first night of the festival one light, on the second two, and so on to the end (so the Hillelites), or vice versa eight lights on the first, and one less on each succeeding night (so the Shamaites). From the prominence of the lights the festival is also known as the "Festival of Lights" or "Illumination" (*Talmud*). It is said that the day chosen by Judas for the setting up of the new altar was the anniversary of that on which Antiochus had set up the pagan altar; hence it is suggested (e.g. by Wellhausen) that the 25th of Kislev was an old pagan festival, perhaps the day of the winter solstice.

For further details and illustrations of Hanukkah lamps see *Jewish Encyc.*, s.v.

HANUMAN, in Hindu mythology, a monkey-god, who forms a central figure in the *Ramayana*. He was the child of a nymph by the god of the wind. His exploits, as the ally of Rama (incarnation of Vishnu) in the latter's recovery of his wife Sita from the clutches of the demon Ravana, include the bridging of the straits between India and Ceylon with huge boulders carried away from the Himalayas. He is the leader of a host of monkeys who aid in these supernatural deeds. Temples in his honour are frequent throughout India.

HANWAY, JONAS (1712-1786), English traveller and philanthropist, was born at Portsmouth in 1712. While still a child, his father, a victualler, died, and the family moved to London. In 1729 Jonas was apprenticed to a merchant in Lisbon. In 1743, after he had been some time in business for himself in London, he became a partner with Mr Dingley, a merchant in

St Petersburg, and in this way was led to travel in Russia and Persia. Leaving St Petersburg on the 10th of September 1743, and passing south by Moscow, Tsaritsyn and Astrakhan, he embarked on the Caspian on the 22nd of November, and arrived at Astrabad on the 18th of December. Here his goods were seized by Mohammed Hassan Beg, and it was only after great privations that he reached the camp of Nadir Shah, under whose protection he recovered most (85%) of his property. His return journey was embarrassed by sickness (at Resht), by attacks from pirates, and by six weeks' quarantine; and he only reappeared at St Petersburg on the 1st of January 1745. He again left the Russian capital on the 9th of July 1750 and travelled through Germany and Holland to England (28th of October). The rest of his life was mostly spent in London, where the narrative of his travels (published in 1753) soon made him a man of note, and where he devoted himself to philanthropy and good citizenship. In 1756 he founded the Marine Society, to keep up the supply of British seamen; in 1758 he became a governor of the Foundling, and established the Magdalen hospital; in 1761 he procured a better system of parochial birth-registration in London; and in 1762 he was appointed a commissioner for victualling the navy (10th of July); this office he held till October 1783. He died, unmarried, on the 5th of September 1786. He was the first Londoner, it is said, to carry an umbrella, and he lived to triumph over all the hackney coachmen who tried to hoot and hustle him down. He attacked "vail-giving," or tipping, with some temporary success; by his onslaught upon tea-drinking he became involved in controversy with Johnson and Goldsmith. His last efforts were on behalf of little chimney-sweepers. His advocacy of solitary confinement for prisoners and opposition to Jewish naturalization were more questionable instances of his activity in social matters.

Hanway left seventy-four printed works, mostly pamphlets; the only one of literary importance is the *Historical Account of British Trade over the Caspian Sea, with a Journal of Travels*, &c. (London, 1753). On his life, see also Pugh, *Remarkable Occurrences in the Life of Jonas Hanway* (London, 1787); *Gentleman's Magazine*, vol. xxxii. p. 342; vol. lvi. pt. ii. pp. 812-814, 1090, 1143-1144; vol. lxx. pt. ii. pp. 721-722, 834-835; *Notes and Queries*, 1st series, i. 436, ii. 25; 3rd series, vii. 311; 4th series, viii. 416.

HANWELL, an urban district in the Brentford parliamentary division of Middlesex, England, 10½ m. W. of St Paul's cathedral, London, on the river Brent and the Great Western railway. Pop. (1891) 6139; (1901) 10,438. It ranks as an outer residential suburb of London. The Hanwell lunatic asylum of the county of London has been greatly extended since its erection 1831, and can accommodate over 2500 inmates. The extensive cemeteries of St Mary Abbots, Kensington, and St George, Hanover Square, London, are here. In the churchyard of St Mary's church was buried Jonas Hanway (d. 1786), traveller, philanthropist, and by repute, introducer of the umbrella into England. The Roman Catholic Convalescent Home for women and children was erected in 1865. Before the Norman period the manor of Hanwell belonged to Westminster Abbey.

HAPARANDA (Finnish *Haaparanta*, "Aspen Shore"), a town of Sweden in the district (*län*) of Norbotten, at the head of the Gulf of Bothnia. Pop. (1900) 1568. It lies about 1½ m. from the mouth of the Torne river, on the frontier with Russia (Finland), opposite the town of Torné which has belonged to Russia since 1809. The towns are divided by a marshy channel, formerly the bed of the Torne, but the main stream is now east of the Russian town. Haparanda was founded in 1812, and at first bore the name of Karljohannstad. It received its municipal constitution in 1842. Shipbuilding is prosecuted. Sea-going vessels load and unload at Salmio, 7 m. from Haparanda. Since 1859 the town has been the seat of an important meteorological station. Annual mean temperature, 32.4° Fahr.; February 10.5°; July 58.8°. Rainfall, 16.5 in. annually. Up the Torne valley (54 m.) is the hill *Avaxax*, whither pilgrimages were formerly made in order to stand in the light of the sun at midnight on St John's day (June 24).

HAPLODRILI (so called by Lankester), often called Archiannelida (Hatschek), the name provisionally given to a number of

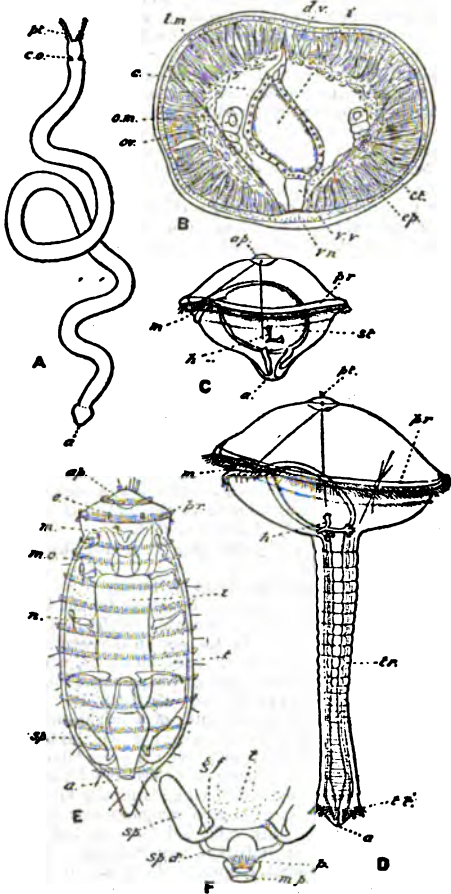

FIG. 1.

- A, *Polygordius neapolitanus*. (From Fraipont.)
 B, Transverse section of *Polygordius*. (From Fraipont.)
 C, Trochophore of *Polygordius*.
 and D, later stage of the same, showing the development of the trunk. (From Hatschek.)
 E, Dorsal view of *Dinophilus taeniatius*. (From Harmer.)
 F, Male apparatus of the same (From Harmer.)
 a, Anus.
 ap, Apical organ.
 c, Coelom.
 c.i, Ciliated pit.
 d.v, Dorsal vessel.
 e, Eye.
 ep, Epidermis.
 g.f, Genital funnel.
 h, "Head kidney" with second nephridium just below it.
 i, Intestine.
 i.m, Longitudinal muscles.
 m, Mouth.
 m.o, Muscular pharyngeal organ.
 m.p, Male pore.
 n, Nephridium.
 o.m, Oblique muscles.
 ov, Ovary.
 p, Penis.
 pr, Prototroch.
 pt, Prostomial tentacle.
 sp, Sperm-sac.
 spd, Sperm-duct.
 st, Stomach.
 t, Testes.
 tr, Trunk segment.
 u, Telotroch.
 v.n, Ventral nerve cord.
 v.v, Ventral vessel.

interesting lowly-organized marine worms, whose affinities are very doubtful (see CHAETOPODA). *Polygordius* and *Protodrilus*

live in sand, but while the former moves by means of the contraction of its body-wall muscles, *Protodrilus* can progress by the action of the bands of cilia surrounding its segments, and of the longitudinal ciliated ventral groove. *Saccocirrus*, which also lives in sand, and more closely resembles the Polychaeta, has throughout the greater length of its body on each segment a pair of small uniramous parapodia bearing a bunch of simple setae. No other member of the group is known to have any trace of setae or parapodia at any stage of development.

These three genera have the following characters in common. The body is composed of a large number of segments; the prostomium bears a pair of tentacles; the nervous system consists of a brain and longitudinal ventral cords closely connected with the epidermis (without distinct ganglia), widely separated in *Saccocirrus*, closely approximated in *Protodrilus*, fused together in *Polygordius*; the coelom is well developed, the septa are distinct; and the dorsal and ventral longitudinal mesenteries are complete; the nephridia are simple, and open into the coelom. *Polygordius* differs from *Protodrilus* and *Saccocirrus* in the absence of a distinct subesophageal muscular pouch, and in the absence of a peculiar closed cavity in the head region, which is especially well developed in *Saccocirrus*, and probably represents the specialized coelom of the first segment. Moreover, in *Saccocirrus* the genital organs,

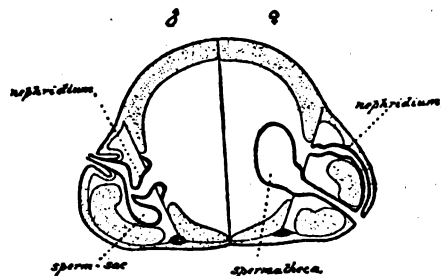

FIG. 2.—Diagram of a transverse section of *Saccocirrus* showing on the left side the organs in a genital segment of a male, and on the right side the organs in a genital segment of a female. (From Goodrich.)

present in the majority of the trunk segments, have become much complicated (fig. 2). In the female there is in every fertile segment a pair of spermathecae opening at the nephridiopores. In the male there are a right and a left protrusible penis in every genital segment, into which opens the nephridium and a sperm-sac. The wide funnels of the nephridia of this region are possibly of coelomic origin.

Dinophilus is a free-swimming form without tentacles, and with segmental bands of cilia (fig. 1). The parasitic *Histriodrilus* (*Histriobdella*) feeds on the eggs of the lobster. It resembles *Dinophilus* in the possession of a ventral pharyngeal pouch (which bears teeth in *Histriodrilus* only), the small number of segments, and absence of distinct septa, the absence of a vascular system, the presence of distinct ganglia on the ventral nerve cords, and of small nephridia which do not appear to open internally. *Histriodrilus* resembles *Saccocirrus* in the possession of two posterior adhesive processes, and to some extent in the structure of the complex genital organs, which, however, are restricted to a single segment. In *Dinophilus* there is also only a single pair of genital ducts behind; and in the male there are sperm-sacs and a median penis. In some species of *Dinophilus* there is pronounced sexual dimorphism (the male being small and without gut) as in the Rotifera. The resemblance of *Dinophilus* to the Rotifera is, however, quite superficial, and the general structure of this genus with distinct traces of segmentation, especially in the embryo, points to its close affinity, if not to *Polygordius* in particular, at all events to the Annelida.

That *Polygordius*, *Protodrilus* and *Saccocirrus* are on the whole primitive forms, and related to each other, there can be little doubt, but their place amongst the Annelida is difficult to determine. The development of *Polygordius* alone is well known, having been studied by Hatschek, Fraipont and others. The larva (fig. 1, C and D) is a typical but very specialized form of trochophore, provided with a branching nephridium bearing solenocytes. The trunk develops on the lower surface of the disk-like larva, which undergoes a more or less sudden metamorphosis into the young worm (fig. 1). There appears to be little either in the development or in the structure of the Haplodrili to warrant the view held by Hatschek and Fraipont that *Polygordius* and *Protodrilus* are exceedingly primitive forms, ancestral to the whole group of seta-bearing Annelids (*Oligochaeta*, *Polychaeta*, *Hirudinea* and *Echiuroidea*).

Whatever may be the conclusion as to the position of *Dinophilus* and *Histioglyphus*, it seems only reasonable to suppose that *Polygordius* and *Protodrilus*, so far from representing a stage in the phylogeny of the Annelida before setae were developed, have lost the setae, which are already in a reduced state in *Saccocirrus*.

AUTHORITIES.—Hätschek, "Studien z. Entw. der Anneliden," *Arch. Zool. Inst. Wien*, vol. i., 1878; "Protodrilus," *ibid.* vol. iii. (1881); Fraipont, "Le Genre *Polygordius*," *Fauna u. Flora d. Golfes v. Neapel*, xiv., 1887; Weldon, "Dinophilus gigas," *Quart. Journ. Micr. Sci.* vol. xxvii., 1886; Harmer, "Dinophilus," *Journ. Mar. Biol. N.S.* vol. i., 1889; Schimkewitsch, "Entwickl. des *Dinophilus*," *Zeit. f. wiss. Zool.* vol. lix., 1895; Korschelt, "Über Bau u. Entw. des *Dinophilus*," *Zeit. f. wiss. Zool.* vol. xxxvii., 1882; Foettinger, "Histioglyphella," *Arch. Biol.* vol. v., 1884; Goodrich, "On *Saccocirrus*," *Quart. Journ. Micr. Sci.* vol. xlv., 1901. (E. S. G.)

HAPTARA (lit. *conclusion*), the Hebrew title given to the prophetic lessons with which the ancient Synagogue service concluded. In the time of Christ these prophetic lessons were already in vogue, and Christ himself read the lessons and discoursed on them in the synagogues of Galilee. In the modern synagogue these readings from the prophets are regularly included in the ritual of Sabbaths, festivals and some other occasions.

A list of the current lessons is given in the *Jewish Encyclopedia*, vol. vi. pp. 136-137. (I. A.)

HAPUR, a town of British India in the Meerut district of the United Provinces, 18 m. S. of Meerut. Pop. (1901) 17,796. It is said to have been founded in the 10th century, and was granted by Sindhia to his French general Perron at the end of the 18th century. Several fine groves surround the town, but the wall and ditch have fallen out of repair, and only the names of the five gates remain. Considerable trade is carried on in sugar, grain, cotton, timber, bamboos and brass utensils.

HARA-KIRI (Japanese *hara*, belly, and *kiri*, cutting), self-disembowelment, primarily the method of suicide permitted to offenders of the noble class in feudal Japan, and later the national form of honourable suicide. Hara-kiri has been often translated as "the happy dispatch" in confusion with a native euphemism for the act. More usually the Japanese themselves speak of hara-kiri by its Chinese synonym, *Seppuku*. Hara-kiri is not an aboriginal Japanese custom. It was a growth of medieval militarism, the act probably at first being prompted by the desire of the noble to escape the humiliation of falling into an enemy's hands. By the end of the 14th century the custom had become a much valued privilege, being formally established as such under the Ashi-Kaga dynasty. Hara-kiri was of two kinds, obligatory and voluntary. The first is the more ancient. An official or noble, who had broken the law or been disloyal, received a message from the emperor, couched always in sympathetic and gracious tones, courteously intimating that he must die. The mikado usually sent a jewelled dagger with which the deed might be done. The suicide had so many days allotted to him by immemorial custom in which to make dignified preparations for the ceremony, which was attended by the utmost formality. In his own baronial hall or in a temple a *daïs* 3 or 4 in. from the ground was constructed. Upon this was laid a rug of red felt. The suicide, clothed in his ceremonial dress as an hereditary noble, and accompanied by his second or "Kaishaku," took his place on the mat, the officials and his friends ranging themselves in a semicircle round the *daïs*. After a minute's prayer the weapon was handed to him with many obeisances by the mikado's representative, and he then made a public confession of his fault. He then stripped to the waist. Every movement in the grim ceremony was governed by precedent, and he had to tuck his wide sleeves under his knees to prevent himself falling backwards, for a Japanese noble must die falling forward. A moment later he plunged the dagger into his stomach below the waist on the left side, drew it across to the right and, turning it, gave a slight cut upward. At the same moment the Kaishaku who crouched at his friend's side, leaping up, brought his sword down on the outstretched neck. At the conclusion of the ceremony the bloodstained dagger was taken to the mikado as a proof of the consummation of the heroic

act. The performance of hara-kiri carried with it certain privileges. If it was by order of the mikado half only of a traitor's property was forfeited to the state. If the gnawings of conscience drove the disloyal noble to voluntary suicide, his dishonour was wiped out, and his family inherited all his fortune.

Voluntary hara-kiri was the refuge of men rendered desperate by private misfortunes, or was committed from loyalty to a dead superior, or as a protest against what was deemed a false national policy. This voluntary suicide still survives, a characteristic case being that of Lieutenant Takeyoshi who in 1891 gave himself the "belly-cut" in front of the graves of his ancestors at Tokyo as a protest against what he considered the criminal lethargy of the government in not taking precautions against possible Russian encroachments to the north of Japan. In the Russo-Japanese War, when faced by defeat at Vladivostock, the officer in command of the troops on the transport "Kinshu Maru" committed hara-kiri. Hara-kiri has not been uncommon among women, but in their case the mode is by cutting the throat. The popularity of this self-immolation is testified to by the fact that for centuries no fewer than 1500 hara-kiris are said to have taken place annually, at least half being entirely voluntary. Stories of amazing heroism are told in connexion with the performance of the act. One noble, barely out of his teens, not content with giving himself the customary cuts, slashed himself thrice horizontally and twice vertically. Then he stabbed himself in the throat until the dirk protruded on the other side with the sharp edge to the front, and with a supreme effort drove the knife forward with both hands through his neck. Obligatory hara-kiri was obsolete in the middle of the 19th century, and was actually abolished in 1868.

See A. B. Mitford, *Tales of Old Japan*; Basil Hall Chamberlain, *Things Japanese* (1898).

HARALD, the name of four kings of Norway.

HARALD I. (850-933), surnamed Haarfager (of the beautiful hair), first king over Norway, succeeded on the death of his father Halfdan the Black in A.D. 860 to the sovereignty of several small and somewhat scattered kingdoms, which had come into his father's hands through conquest and inheritance and lay chiefly in south-east Norway (see Norway). The tale goes that the scorn of the daughter of a neighbouring king induced Harald to take a vow not to cut nor comb his hair until he was sole king of Norway, and that ten years later he was justified in trimming it; whereupon he exchanged the epithet "Shockhead" for the one by which he is usually known. In 866 he made the first of a series of conquests over the many petty kingdoms which then composed Norway; and in 872, after a great victory at Hafsford near Stavanger, he found himself king over the whole country. His realm was, however, threatened by dangers from without, as large numbers of his opponents had taken refuge, not only in Iceland, then recently discovered, but also in the Orkneys, Shetlands, Hebrides and Faeroes, and in Scotland itself; and from these winter quarters sallied forth to harry Norway as well as the rest of northern Europe. Their numbers were increased by malcontents from Norway; who resented Harald's claim of rights of taxation over lands which the possessors appear to have previously held in absolute ownership. At last Harald was forced to make an expedition to the west to clear the islands and Scottish mainland of Vikings. Numbers of them fled to Iceland, which grew into an independent commonwealth, while the Scottish isles fell under Norwegian rule. The latter part of Harald's reign was disturbed by the strife of his many sons. He gave them all the royal title and assigned lands to them which they were to govern as his representatives; but this arrangement did not put an end to the discord, which continued into the next reign. When he grew old he handed over the supreme power to his favourite son Erik "Bloody Axe," whom he intended to be his successor. Harald died in 933, in his eighty-fourth year.

HARALD II., surnamed Graafeld, a grandson of Harald I., became, with his brothers, ruler of the western part of Norway in 961; he was murdered in Denmark in 969.

HARALD III. (1015-1066), king of Norway, surnamed *Haardraade*, which might be translated "ruthless," was the son of King Sigurd and half-brother of King Olaf the Saint. At the age of fifteen he was obliged to flee from Norway, having taken part in the battle of Stiklestad (1030), at which King Olaf met his death. He took refuge for a short time with Prince Yaroslav of Novgorod (a kingdom founded by Scandinavians), and thence went to Constantinople, where he took service under the empress Zoe, whose Varangian guard he led to frequent victory in Italy, Sicily and North Africa, also penetrating to Jerusalem. In the year 1042 he left Constantinople, the story says because he was refused the hand of a princess, and on his way back to his own country he married Edisif or Elizabeth, daughter of Yaroslav of Novgorod. In Sweden he allied himself with the defeated Sven of Denmark against his nephew Magnus, now king of Norway, but soon broke faith with Sven and accepted an offer from Magnus of half his kingdom. In return for this gift Harald is said to have shared with Magnus the enormous treasure which he had amassed in the East. The death of Magnus in 1047 put an end to the growing jealousies between the two kings, and Harald turned all his attention to the task of subjugating Denmark, which he ravaged year after year; but he met with such stubborn resistance from Sven that in 1064 he gave up the attempt and made peace. Two years afterwards, possibly instigated by the banished Earl Tostig of Northumbria, he attempted the conquest of England, to the sovereignty of which his predecessor had advanced a claim as successor of Harthacnut. In September 1066 he landed in Yorkshire with a large army, reinforced from Scotland, Ireland and the Orkneys; took Scarborough by casting flaming brands into the town from the high ground above it; defeated the Northumbrian forces at Fulford; and entered York on the 24th of September. But the following day the English Harold arrived from the south, and the end of the long day's fight at Stamford Bridge saw the rout of the Norwegian forces after the fall of their king (25th of September 1066). He was only fifty years old, but he was the first of the six kings who had ruled Norway since the death of Harald Haarfager to reach that age. As a king he was unpopular on account of his harshness and want of good faith, but his many victories in the face of great odds prove him to have been a remarkable general, of never-failing resourcefulness and indomitable courage.

HARALD IV. (d. 1136), king of Norway, surnamed Gylle (probably from *Gylle Krist*, i.e. servant of Christ), was born in Ireland about 1103. About 1127 he went to Norway and declared he was a son of King Magnus III. (Barefoot), who had visited Ireland just before his death in 1103, and consequently a half-brother of the reigning king, Sigurd. He appears to have submitted successfully to the ordeal of fire, and the alleged relationship was acknowledged by Sigurd on condition that Harald did not claim any share in the government of the kingdom during his lifetime or that of his son Magnus. Living on friendly terms with the king, Harald kept this agreement until Sigurd's death in 1130. Then war broke out between himself and Magnus, and after several battles the latter was captured in 1134, his eyes were put out, and he was thrown into prison. Harald now ruled the country until 1136, when he was murdered by Sigurd Stenbi-Diakn, another bastard son of Magnus Barefoot. Four of Harald's sons, Sigurd, Ingi, Eysteian and Magnus, were subsequently kings of Norway.

HARBIN, or **KHARBIN**, town of Manchuria, on the right bank of the river Sungari. Pop. about 20,000. Till 1896 there was only a small village here, but in that year the town was founded in connexion with surveys for the Chinese Eastern railway company, at a point which subsequently became the junction of the main line of the Manchurian railway with the branch line southward to Port Arthur. Occupying such a position, Harbin became an important Russian military centre during the Russo-Japanese War. The portion of the town founded in 1896 is called Old Harbin, but the centre has shifted to New Harbin, where the chief public buildings and offices of the railway administration are situated. The river-port forms

a third division of the town, industrially the most important; here are railway workshops, factories and mercantile establishments. Trade is chiefly in the hands of the Chinese.

HARBINGER, originally one who provides a shelter or lodging for an army. The word is derived from the M.E. and O.Fr. *herbergere*, through the Late Lat. *heribergator*, formed from the O.H.Ger. *heri*, mod. Ger. *Heer*, an army, and *bergen*, shelter or defence, cf. "harbour." The meaning was soon enlarged to include any place where travellers could be lodged or entertained, and also by transference the person who provided lodgings, and so one who goes on before a party to secure suitable lodgings in advance. A herald sent forward to announce the coming of a king. A Knight Harbinger was an officer in the royal household till 1846. In these senses the word is now obsolete. It is used chiefly in poetry and literature for one who announces the immediate approach of something, a forerunner. This is illustrated in the "harbinger of spring," a name given to a small plant belonging to the Umbelliferae, which has a tuberous root, and small white flowers; it is found in the central states of North America, and blossoms in March.

HARBOUR (from M.E. *herberge*, *here*, an army; cf. Ger. *Heer* and *-beorg*, protection or shelter. Other early forms in English were *herberwe* and *harborow*, as seen in various place names, such as Market Harborough. The French *suberge*, an inn, derived through *heberger*, is thus the same word), a place of refuge or shelter. It is thus used for an asylum for criminals, and particularly for a place of shelter for ships.

Sheltered sites along exposed sea-coasts are essential for purposes of trade, and very valuable as refuges for vessels from storms. In a few places, natural shelter is found in combination with ample depth, as in the Bay of Rio de Janeiro, New York Harbour (protected by Long Island), Portsmouth Harbour and Southampton Water (sheltered by the Isle of Wight), and the land-locked creeks of Milford Haven and Kiel Harbour. At various places there are large enclosed areas which have openings into the sea; but these lagoons for the most part are very shallow except in the main channels and at their outlets. Access to them is generally obstructed by a bar as at the lagoon harbour of Venice (fig. 1), and similar harbours, like those of Poole and Wexford; and such harbours usually require works to prevent their deterioration, and to increase the depth near their outlet. Generally, however, harbours are formed where shelter is provided to a certain extent by a bay, creek or projecting headland, but requires to be rendered complete by one or more breakwaters (see BREAKWATER), or where the approach to a river, a ship-canal or a seaport, needs protection. A refuge harbour is occasionally constructed where a long length of stormy coast, near the ordinary track of vessels, is entirely devoid of natural shelter. Naval harbours are required by maritime powers as stations for their fleets, and dockyards for construction and repairs, and also in some cases as places of shelter from the night attacks of torpedoes. Commercial harbours have to be provided for the formation of ports within their shelter on important trade routes, or for the protection of the approaches from the sea of ports near the sea-coast, or maritime waterways running inland, in some cases at points on the coast devoid of all natural shelter. A greater latitude in the selection of suitable sites is, indeed, possible for refuge and naval harbours than for commercial harbours; but these three classes of harbours are very similar in their general outline and the works protecting them, only differing in size and internal arrangements according to the purpose for which they have been constructed, the chief differences being due to the local conditions.

Harbours may be divided into three distinct groups, namely, lagoon harbours, jetty harbours and sea-coast harbours, protected by breakwaters, including refuge, naval and commercial harbours.

Lagoon Harbours.—A lagoon, consisting of a sort of large shallow lake separated from the sea by a narrow belt of coast, formed of deposit from a deltaic river or of sand dunes heaped up by on-shore winds along a sandy shore, possesses good natural shelter; and, owing to the large expanse which is filled and emptied at each tide, even when the tidal range is quite small, together with the discharge

from any rivers flowing into the lagoon, one or more fairly deep outlets are maintained through the fringe of coast, which afford navigable access to the lagoon; whilst channels formed inside by



FIG. 1.—Venetian Lagoon Harbour.

the currents lead to ports on its banks. Lagoons, however, are liable to be gradually silted up, if rivers flowing into them bring down considerable quantities of alluvium, which is readily deposited in their fairly still waters; and their outlet channels are in danger of becoming shallower, by the sea in storms forming additional outlets by breaking through the narrow barrier separating them from the sea. Moreover, the approach from the sea to these channels through the fringe of coast is generally impeded by a bar, owing to the scour of the issuing current through these outlet channels becoming gradually too enfeebled, on entering the open sea, to overcome the heaping-up action of the waves along the shore, which tends to form a continuous beach across these openings. Rivers, accordingly, whose discharge is very valuable in maintaining a lagoon if their waters are free from sediment, must, if possible, be diverted from a lagoon if they bring down large amounts of silt; whilst the narrow belt of land in front of the lagoon must be protected from erosion by the waves, on its sea face, by groynes or revetments.

The depth over the bar in front of an outlet can be improved by concentrating the current through the outlet by jetties on each side, and prolonging the jetties, and consequently the scour, out to the bar so as to lower it, and by supplementing the scouring action, if necessary, by dredging.

Jetty Harbours.—Several small ports were formed on the sea-coast long ago at points where flat marshy ground lying below the level of high-water, and shut off from the sandy beach by dikes or sand dunes, was connected with the sea by a small creek or river. Such ports presented in their original condition a slight resemblance to lagoons on a very small scale. Several examples are to be found on the sandy shores of the English Channel and North Sea, such as Dieppe, Boulogne, Calais, Dunkirk, Nieuport and Ostend, where the influx and efflux of the water from these enclosed tide-covered areas, through a narrow opening, sufficed to maintain a shallow channel to the sea across the beach, deep enough near high-water for vessels of small draught. When the increase in draught necessitated the provision of an improved channel, the scour of the issuing current was concentrated and prolonged by erecting parallel jetties across the beach, raised solid to a little above low water of neap tides, with open timber-work above to indicate the channel and guide the vessels. Even this low obstruction, however, to the littoral drift of sand caused an advance of the low water line as the jetties were carried out, so that further extensions of the jetties had eventually to be abandoned, as occurred at Dunkirk (see Dock). Moreover, reclamation of the low-lying areas was gradually effected, thus reducing the tidal scour; and sluicing basins were excavated in part of the low ground, into which the tide flowed through the entrance channel, and the water being shut in at high tide by gates at the outlet of the basin, was released at low water, producing a rapid current through the channel as a compensation for the loss of the former natural scour. The current, however, from the sluicing basin gradually lost its velocity in passing down the channel, and besides, being most effective near the outlet of the basin, could only scour the channel down to a moderate depth below low water, on account of the increase in the volume of still water in the channel at low tide as its deepening progressed. Lastly, about 1880, improvements in suction dredgers (see DREDGE AND DREDGING) led to the adoption of sand-pump dredging in the outer part of the channel, and across the foreshore in front of deep water; and at Dunkirk, docks were formed on the site of the sluicing basin; whilst at Calais sluicing was abandoned in favour of dredging. Ostend is the only jetty harbour in which a large sluicing basin has been recently constructed, but it can only provide for the maintenance of deep-water quays in its vicinity; and dredging is relied upon to an increasing extent, both for the maintenance and further deepening of the outer portion of the approach channel, and for maintaining the direct channel dredged to deep water across the Siroombank extending in front of Ostend (fig. 2).

Similar methods of improving the entrance channel to ports possessing an extensive backwater have been adopted on a large scale in the United States. For instance at Charleston, converging jetties, about 2½ m. long, have been extended across the bar to concentrate the scour due to a small tidal range expanding over the enclosed backwater, 15 sq. m. in extent, and to protect the channel from littoral drift; but these jetties have caused an advance of the foreshore, and a progression seawards of the bar, necessitating dredging beyond the ends of the jetties to maintain the requisite depth.

Parallel jetties, moreover, across the beach, combined with extensive sand-pump dredging, have been employed with success at some of the ports situated at the outlet of rivers, enclosed bays, or lagoons, on the sandy shores of

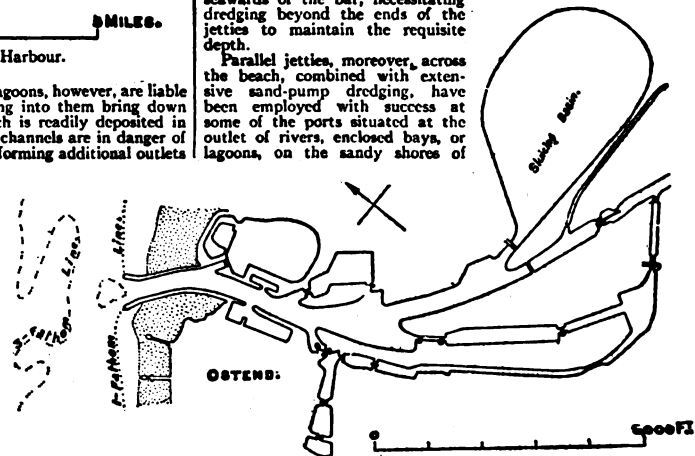

FIG. 2.—Ostend Harbour and Jetty Channel.

south-east Africa, for improving the access to them across encumbering shoals, where the littoral drift is too great to allow of the projection of breakwaters from the shore to shelter an approach channel.

Harbours Protected by Breakwaters.—The design for a harbour on

the sea-coast must depend on the configuration of the adjacent coast-line, the extent and direction of the exposure, the amount of sheltered area required and the depth obtainable, the prospect of the accumulation of drift or the occurrence of scour from the proposed works, and the best position for an entrance in respect of shelter and depth of approach.

Completion of Shelter of Harbours in Bays.—In the case of a deep, fairly landlocked bay, a detached breakwater across the outlet completes the necessary shelter, leaving an entrance between each extremity and the shore, provided there is deep enough water near the shore, as effected at Plymouth harbour, and also across the wider but shallower bay forming Cherbourg harbour. A breakwater may

a slight curve or bend inwards near its outer end, suffices to afford the necessary shelter. As examples of this form of harbour construction may be mentioned Newhaven breakwater, protecting the approach to the port from the west, and somewhat sheltered from the moderate easterly storms by Beachy Head, and Table Bay breakwater, which shelters the harbour from the north-east, and is somewhat protected on the opposite side by the wide sweep of the coast-line known as Table Bay. Generally, however, some partial embayment, or abrupt projection from the coast, is utilized as providing shelter from one quarter, which is completed by breakwaters enclosing the site, of which Dover and Colombo (fig. 5) harbours furnish typical and somewhat similar examples.

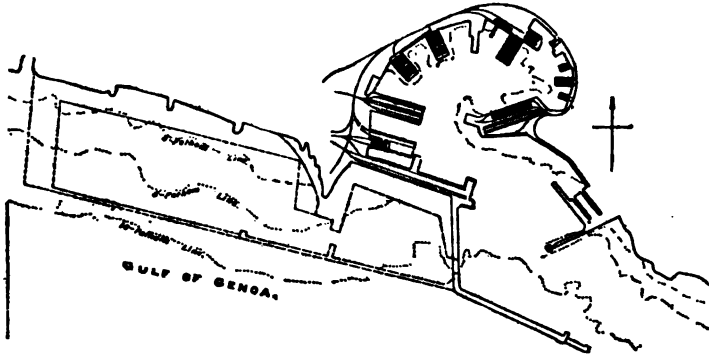

FIG. 3.—Genoa Harbour and Extensions.

instead be extended across the outlet from each shore, leaving a single central entrance between the ends of the breakwaters; and if one breakwater placed somewhat farther out is made to overlap an inner one, a more sheltered entrance is obtained. This arrangement has been adopted at the existing Genoa harbour within the bay (fig. 3), and for the harbour at the mouth of the Nervion (see RIVER ENGINEERING). The adoption of a bay with deep water for a harbour does not merely reduce the shelter to be provided artificially, but it also secures a site not exposed to silting up, and where the sheltering works do not interfere with any littoral drift along the open coast. A third method of sheltering a deep bay is that

sand accumulates in the sheltered angles outside the harbour between each converging breakwater and the shore. This has happened at Ymuiden harbour at the entrance to the Amsterdam ship-canal on the North Sea, but there the advance of the shore appears to have reached its limit only a short distance out from the old shore-line on each side; and the only evidence of drift consists in the advance seawards of the lines of soundings alongside, and in the considerable amount of sand which enters the harbour and has to be removed by dredging. The worst results occur where the littoral drift is almost wholly in one direction, so that the projection of a solid breakwater out from the shore causes a very large accretion on the side facing the exposed quarter; whilst owing to the arrest of the travel of sand, erosion of the beach occurs beyond the second breakwater enclosing the harbour on its comparatively sheltered side. These effects have been produced at Port Said harbour at the entrance to the Suez Canal from the Mediterranean, formed by two converging breakwaters, where, owing to the prevalent north-westerly winds, the drift is from west to east, and is augmented by the alluvium issuing from the Nile. Accordingly, the shore has advanced considerably against the outer face of the western breakwater; and erosion of the beach has occurred at the shore end of the eastern breakwater, cutting it off from the land.

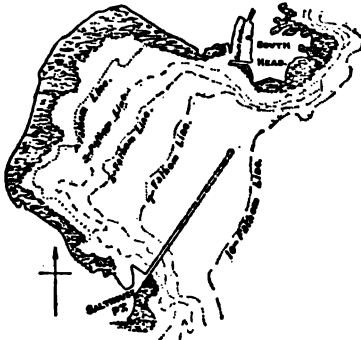

FIG. 4.—Peterhead Harbour of Refuge.

adopted for forming a refuge harbour at Peterhead (fig. 4), where a single breakwater is extended out from one shore for 3250 ft. across the outlet of the bay, leaving a single entrance between its extremity and the opposite shore and enclosing an area of about 250 acres at low tide, half of which has a depth of over 5 fathoms.

Harbours possessing partial Natural Shelter.—The most common form of harbour is that in which one or more breakwaters supplement a certain amount of natural shelter. Sometimes, where the exposure is from one direction only, approximately parallel with the coast-line at the site, and there is more or less shelter from a projecting headland or a curve of the coast in the opposite direction, a single breakwater extending out at right angles to the shore, with

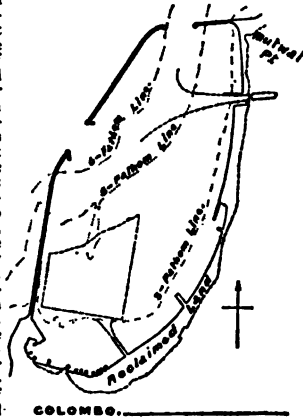

FIG. 5.—Colombo Harbour.

The advance of the shore-line, however, has been much slower during recent years; and though the progress seawards of the lines of soundings close to and in front of the harbour continues, the advance is checked by the sand and silt coming from the west passing through some apertures purposely left in the western breakwater, and falling into the approach channel, from which it is readily dredged and taken away. Madras harbour, begun in 1875, consists of two breakwaters, 3000 ft. apart, carried straight out to sea at right angles to the shore for 3000 ft., and completed by two return

arms inclined slightly seawards, enclosing an area of 220 acres and leaving a central entrance, 550 ft. wide, facing the Indian Ocean in a depth of about 8 fathoms. The great drift, however, of sand along the coast from south to north soon produced an advance of the shore against the outside of the south breakwater, and erosion beyond the north breakwater; and the progression of the foreshore has extended so far seawards as to produce shoaling at the entrance. Accordingly, the closing of the entrance, and the formation of a new entrance through the outer part of the main north breakwater, facing north and sheltered by an arm starting from the angle of the northern return arm and running north parallel to the shore, round the end of which vessels would turn to enter, have been recommended, to provide a deep entrance beyond the influence of the advancing foreshore.

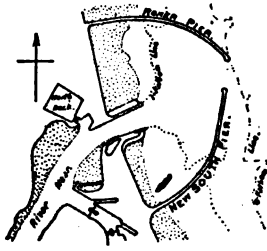

FIG. 6.—Sunderland Harbour.

large scale at the port of call and sheltering breakwater constructed in front of the entrance to the Bruges ship-canal, at Zeebrugge on the sandy North Sea coast, where a solid breakwater, provided with a wide quay furnished with sidings and sheds, and curving round so as to overlap thoroughly the entrance to the canal and shelter a certain water-area, is approached by an open metal viaduct extending out 1007 ft. from low water into a depth of 20 ft. (fig. 7). It is hoped that by thus avoiding interference with the littoral drift close to the shore, coming mainly from the west, the accumulation of silt to the west of the harbour, and also in the harbour itself, will be prevented; and though it appears probable that some accretion will occur within the area sheltered by the breakwater, it will to some

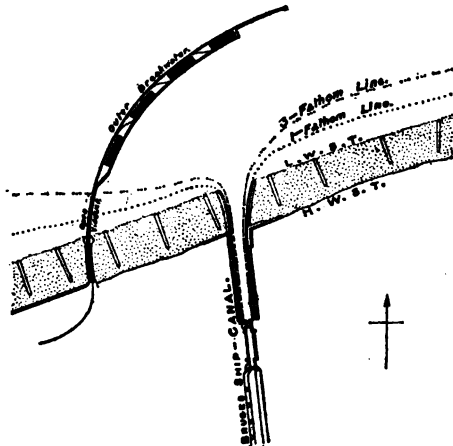

FIG. 7.—Zeebrugge Harbour.

extent be disturbed by the wash of the steamers approaching and leaving the quays, and can readily be removed under shelter by dredging.

Entrances to Harbours.—Though captains of vessels always wish for wide entrances to harbours as affording greater facility of safe access, it is important to keep the width as narrow as practicable, consistent with easy access, to exclude waves and swell as much as possible and secure tranquility inside. At Madras, the width of 550 ft. proved excessive for the great exposure of the entrance, and moderate size of the harbour, which does not allow of the adequate expansion of the entering swell. Where an adequately easy and safe approach can be secured, it is advantageous to make the entrance

face a somewhat sheltered quarter by the overlapping of the end of one of the breakwaters, as accomplished at Bilbao and Genoa harbours (fig. 3), and at the southern entrance to Dover harbour. Occasionally, owing to the comparative shelter afforded by a head in the adjacent coast-line, a very wide entrance can be left between a breakwater and the shore; typical examples are furnished by the former open northern entrance to Portland harbour, now closed against torpedoes, and the wide entrances at Holyhead and Zeebrugge (fig. 7). With a large harbour and the adoption of a detached breakwater, it is possible to gain the advantage of two entrances facing different quarters, as effected at Dover and Colombo, which enables vessels to select their entrance according to the state of the wind and weather; where there is a large tidal rise they reduce the current through the entrances, and they may, under favourable conditions, create a circulation of the water in the harbour, tending to check the deposit of silt. (L. F. V.-H.)

HARBURG, a seaport town of Germany, in the Prussian province of Hanover, on the left bank of the southern arm of the Elbe, 6 m. by rail S. of Hamburg. Pop. (1885), 26,320; (1905)—the area of the town having been increased since 1805—55,676. It is pleasantly situated at the foot of a lofty range of hills, which here dip down to the river, at the junction of the main lines of railway from Bremen and Hanover to Hamburg, which are carried to the latter city over two grand bridges crossing the southern and the northern arms of the Elbe. It possesses a Roman Catholic and two Protestant churches, a palace, which from 1524 to 1642 was the residence of the Harburg line of the house of Brunswick, a high-grade modern school, a commercial school and a theatre. The leading industries are the crushing of palm-kernels and linseed and the manufacture of india-rubber, phosphates, starch, nitrate and jute. Machines are manufactured here; beer is brewed, and shipbuilding is carried on. The port is accessible to vessels drawing 18 ft. of water, and, despite its proximity to Hamburg, its trade has of late years shown a remarkable development. It is the chief mart in the empire for resin and palm-oil. The Prussian government proposes establishing here a free port, on the lines of the *Freihafen* in Hamburg.

Harburg belonged originally to the bishopric of Bremen, and received municipal rights in 1207. In 1376 it was united to the principality of Lüneburg, along with which it fell in 1705 to Hanover, and in 1806 to Prussia. In 1813 and 1814 it suffered considerably from the French, who then held Hamburg, and who built a bridge between the two towns, which remained standing till 1816.

See Ludewig, *Geschichte des Schlosses und der Stadt Harburg* (Harburg, 1845); and Hoffmeyer, *Harburg und die nächste Umgegend* (1885).

HARCOURT, a village in Normandy, now a commune in the department of Eure, arrondissement of Bernay and canton of Brionne, which gives its name to a noble family distinguished in French history, a branch of which was early established in England. Of the lords of Harcourt, whose genealogy can be traced back to the 11th century, the first to distinguish himself was Jean II. (d. 1302) who was marshal and admiral of France. Godefroi d'Harcourt, seigneur of Saint Sauveur le Vicomte, surnamed "Le boiteux" (the lame), was a marshal in the English army and was killed near Coutances in 1356. The fief of Harcourt was raised to the rank of a countship by Philip of Valois, in favour of Jean IV., who was killed at the battle of Crecy (1346). His son, Jean V. (d. 1355) married Blanche, heiress of Jean II., count of Aumale, and the countship of Harcourt passed with that of Aumale until, in 1424, Jean VIII., count of Aumale and Mortain and lieutenant-general of Normandy, was killed at the battle of Verneuil, and with him the elder branch became extinct in the male line. The heiress, Marie, by her marriage with Anthony of Lorraine, count of Vaudeumont, brought the countship of Harcourt into the house of Lorraine. The title of count of Harcourt was borne by several princes of this house. The most famous instance was Henry of Lorraine, count of Harcourt, Brionne, and Armagnac, and nicknamed "Cadet la perle" (1601-1666). He distinguished himself in several campaigns against Spain, and later played an active part in the civil wars of the Fronde. He took the side of the princes, and fought against the

HARCOURT, 1ST VISCOUNT—HARCOURT, SIR WILLIAM 939

government in Alsace; but was defeated by Marshal de la Ferté, and made his submission in 1654.

The most distinguished among the younger branches of the family are those of Montgomery and of Beuvron. To the former belonged Jean d'Harcourt, bishop of Amiens and Tournai, archbishop of Narbonne and patriarch of Antioch, who died in 1452; and Guillaume d'Harcourt, count of Tancarville, and viscount of Melun, who was head of the administration of the woods and forests in the royal domain (*souverain maître et réformateur des eaux et forêts de France*) and died in 1487.

From the branch of the marquises of Beuvron sprang Henri d'Harcourt, marshal of France, and ambassador at the Spanish court, who was made duke of Harcourt (1700) and a peer of France (1709); also François Eugène Gabriel, count, and afterwards duke, of Harcourt, who was ambassador first in Spain, and later at Rome, and died in 1865. This branch of the family is still in existence.

* See G. A. de la Roque, *Histoire généalogique de la maison d'Harcourt* (4 vols., Paris, 1662); P. Anselme, *Histoire généalogique de la maison de France*, v. 114, &c.; and Dom le Noir, *Preuves généalogiques et historiques de la maison de Harcourt* (Paris, 1907).

(M. P.)*

HARCOURT, SIMON HARCOURT, 1ST VISCOUNT (c. 1661–1727), lord chancellor of England, only son of Sir Philip Harcourt of Stanton Harcourt, Oxfordshire, by his first wife, Anne, daughter of Sir William Waller, was born about 1661 at Stanton Harcourt, and was educated at a school at Shilton, Oxfordshire, and at Pembroke College, Oxford. He was called to the bar in 1683, and soon afterwards was appointed recorder of Abingdon, which borough he represented as a Tory in parliament from 1690 to 1705. In 1701 he was nominated by the Commons to conduct the impeachment of Lord Somers; and in 1702 he became solicitor-general and was knighted by Queen Anne. He was elected member for Bossiney in 1705, and as commissioner for arranging the union with Scotland was largely instrumental in promoting that measure. Harcourt was appointed attorney-general in 1707, but resigned office in the following year when his friend Robert Harley, afterwards earl of Oxford, was dismissed. He defended Sacheverell at the bar of the House of Lords in 1710, being then without a seat in parliament; but in the same year was returned for Cardigan, and in September again became attorney-general. In October he was appointed lord keeper of the great seal, and in virtue of this office he presided in the House of Lords for some months without a peerage, until, on the 3rd of September 1711, he was created Baron Harcourt of Stanton Harcourt; but it was not till April 1713 that he received the appointment of lord chancellor. In 1710 he had purchased the Nuneham-Courtney estate in Oxfordshire, but his usual place of residence continued to be at Cokethorpe near Stanton Harcourt, where he received a visit in state from Queen Anne. In the negotiations preceding the peace of Utrecht, Harcourt took an important part. There is no sufficient evidence for the allegations of the Whigs that Harcourt entered into treacherous relations with the Pretender. On the accession of George I. he was deprived of office and retired to Cokethorpe, where he enjoyed the society of men of letters, Swift, Pope, Prior and other famous writers being among his frequent guests. With Swift, however, he had occasional quarrels, during one of which the great satirist bestowed on him the sobriquet of "Trimming Harcourt." He exerted himself to defeat the impeachment of Lord Oxford in 1717, and in 1723 he was active in obtaining a pardon for another old political friend, Lord Bolingbroke. In 1721 Harcourt was created a viscount and returned to the privy councils; and on several occasions during the king's absences from England he was on the council of regency. He died in London on the 23rd of July 1727. Harcourt was not a great lawyer, but he enjoyed the reputation of being a brilliant orator; Speaker Onslow going so far as to say that Harcourt "had the greatest skill and power of speech of any man I ever knew in a public assembly." He was a member of the famous Saturday Club, frequented by the chief *littérateurs* and wits of the period, with several of whom he corresponded. Some letters to

him from Pope are preserved in the *Harcourt Papers*. His portrait by Kneller is at Nuneham.

Harcourt married, first, Rebecca, daughter of Thomas Clark, his father's chaplain, by whom he had five children; secondly, Elizabeth, daughter of Richard Spencer; and thirdly, Elizabeth, daughter of Sir Thomas Vernon. He left issue by his first wife only. His son, Simon (1684–1720), married Elizabeth, sister of Sir John Evelyn of Wotton, by whom he had one son and four daughters, one of whom married George Venables Vernon, afterwards Lord Vernon (see HARCOURT, SIR WILLIAM—foot-note). Simon Harcourt predeceased his father, the lord chancellor, in 1720, leaving a son SIMON HARCOURT (1714–1777), 1st Earl Harcourt, who succeeded his grandfather in the title of viscount in 1727. He was educated at Westminster school. In 1745, having raised a regiment, he received a commission as a colonel in the army; and in 1749 he was created Earl Harcourt of Stanton Harcourt. He was appointed governor to the prince of Wales, afterwards George III., in 1751; and after the accession of the latter to the throne he was appointed, in 1761, special ambassador to Mecklenburg-Strelitz to negotiate a marriage between King George and the princess Charlotte, whom he conducted to England. After holding a number of appointments at court and in the diplomatic service, he was promoted to the rank of general in 1772; and in October of the same year he succeeded Lord Townsend as lord lieutenant of Ireland, an office which he held till 1777. His proposal to impose a tax of 10% on the rents of absentee landlords had to be abandoned owing to opposition in England; but he succeeded in conciliating the leaders of Opposition in Ireland, and he persuaded Henry Flood to accept office in the government. Resigning in January 1777, he retired to Nuneham, where he died in the following September. He married, in 1735, Rebecca, daughter and heiress of Charles Samborne Le Bas, of Pipewell Abbey, Northamptonshire, by whom he had two daughters and two sons, George Simon and William, who succeeded him as 2nd and 3rd earl respectively.

See Lord Campbell, *Lives of the Lord Chancellors*, vol. v. (London, 1846); Edward Foss, *The Judges of England*, vol. viii. (London, 1848); Gilbert Burnet, *Hist. of his own Time* (with notes by earls of Dartmouth and Hardwicke, &c., Oxford, 1833); Earl Stanhope, *Hist. of England, comprising the reign of Queen Anne until the Peace of Utrecht* (London, 1870). In addition to the above-mentioned authorities many particulars concerning the 1st Viscount Harcourt, and also of his grandson, the 1st earl, will be found in the *Harcourt Papers*. For the earl, see also Horace Walpole, *Memoirs of the Reign of George II.* (3 vols., 2nd ed., London, 1847); *Memoirs of the Reign of George III.* (4 vols., London, 1845, 1804); also, for his vice-royalty of Ireland, see Henry Grattan, *Memoirs of the Life and Times of the Right Hon. H. Grattan* (5 vols., London, 1839–1846); Francis Hardy, *Memoirs of J. Caulfield, Earl of Charlemont* (2 vols., London, 1812); and for his genealogy, see Sir John Bernard Burke, *Genealogical History of Dormant and Extinct Peerages* (London, 1883).

HARCOURT, SIR WILLIAM GEORGE GRANVILLE VENABLES VERNON (1827–1904), English statesman, second son of the Rev. Canon William Vernon Harcourt (q.v.), of Nuneham Park, Oxford, was born on the 14th of October 1827. Canon Harcourt was the fourth son and eventually heir of Edward Harcourt (1757–1847), archbishop of York, who was the son of the 1st Lord Vernon (d. 1780), and who took the name of Harcourt alone instead of Vernon on succeeding to the property of his cousin, the last Earl Harcourt, in 1831. The subject

William, 3rd and last Earl Harcourt (1743–1830), who succeeded his brother in the title, was a soldier who distinguished himself in the American War of Independence by capturing General Charles Lee, and commanded the British forces in Flanders in 1794, eventually becoming a field-marshal. He was a son of Simon, 1st earl (1714–1777), created viscount and earl in 1749, a soldier, and from 1772 to 1777 viceroy of Ireland, who was grandson and heir of Simon, Viscount Harcourt (1661–1727), lord chancellor—the "trimming Harcourt" of Swift—the purchaser of the Nuneham-Courtney estates in Oxfordshire, and son of Sir Philip Harcourt of Stanton Harcourt. The knights of Stanton Harcourt, from the 13th century onwards, traced their descent to the Norman de Harcourts, a branch of that family having come over with the Conqueror; and the pedigree claims to go back to Bernard of Saxony, who in 876 acquired the lordships of Harcourt, Castleville and Beaufeuil in Normandy. Viscount Harcourt's second son Simon, who was father of the 1st earl, was also father of Martha, who married George

of this biography was therefore born a Vernon, and by his connexion with the old families of Vernon and Harcourt was related to many of the great English houses, a fact which gave him no little pride. Indeed, in later life his descent from the Plantagenets¹ was a subject of some banter on the part of his political opponents. He was educated at Trinity College, Cambridge, graduating with first-class honours in the classical tripos in 1851. He was called to the bar in 1854, became a Q.C. in 1866, and was appointed Whewell professor of international law, Cambridge, 1869. He quickly made his mark in London society as a brilliant talker; he contributed largely to the *Saturday Review*, and wrote some famous letters (1862) to *The Times* over the signature of "Historicus," in opposition to the recognition of the Southern States as belligerents in the American Civil War. He entered parliament as Liberal member for Oxford, and sat from 1868 to 1880, when, upon seeking re-election after acceptance of office, he was defeated by Mr Hall. A seat was, however, found for him at Derby, by the voluntary retirement of Mr Plimsoll, and he continued to represent that constituency until 1895, when, having been defeated at the general election, he found a seat in West Monmouthshire. He was appointed solicitor-general and knighted in 1873; and, although he had not shown himself a very strenuous supporter of Mr Gladstone during that statesman's exclusion from power, he became secretary of state for the home department on the return of the Liberals to office in 1880. His name was connected at that time with the passing of the Ground Game Act (1880), the Arms (Ireland) Act (1881), and the Explosives Act (1883). As home secretary at the time of the dynamite outrages he had to take up a firm attitude, and the Explosives Act was passed through all its stages in the shortest time on record. Moreover, as champion of law and order against the attacks of the Parnellites, his vigorous speeches brought him constantly into conflict with the Irish members. In 1884 he introduced an abortive bill for unifying the municipal administration of London. He was indeed at that time recognized as one of the ablest and most effective leaders of the Liberal party; and when, after a brief interval in 1885, Mr Gladstone returned to office in 1886, he was made chancellor of the exchequer, an office which he again filled from 1892 to 1895.

Between 1880 and 1892 Sir William Harcourt acted as Mr Gladstone's loyal and indefatigable lieutenant in political life. A first-rate party fighter, his services were of inestimable value; but in spite of his great success as a platform speaker, he was generally felt to be speaking from an advocate's brief, and did not impress the country as possessing much depth of conviction. It was he who coined the phrase about "stewing in Parnellite juice," and, when the split came in the Liberal party on the Irish question, even those who gave Mr Gladstone and Mr Morley the credit of being convinced Home Rulers could not be persuaded that Sir William had followed anything but the line of party expediency. In 1894 he introduced and carried a memorable budget, which equalized the death duties on real and personal property. After Mr Gladstone's retirement in 1894 and Lord Rosebery's selection as prime minister Sir William became the leader of the Liberal party in the House of Commons, but it was never probable that he would work comfortably in the new conditions. His title to be regarded as Mr Gladstone's successor had been too lightly ignored, and from the first it was evident that Lord Rosebery's ideas of Liberalism and of the policy of the Liberal party were not those of Sir William Harcourt. Their differences were patched up from time to time, but the Venables Vernon, of Sudbury, created 1st Baron Vernon in 1762. The latter was a descendant of Sir Richard Vernon (d. 1451), speaker of the Leicester parliament (1425) and treasurer of Calais, a member of a Norman family which came over with the Conqueror.

¹ The Plantagenet descent (see *The Blood Royal of Britain*, by the marquis of Ruvigny, 1903, for tables) could be traced through Lady Anna Leveson Gower (wife of Archbishop Harcourt) to Lady Frances Stanley, the wife of the 1st earl of Bridgewater (1579-1649), and so to Lady Eleanor Brandon, wife of the earl of Cumberland (1517-1570), and daughter of Mary Tudor (wife of Charles Brandon, duke of Suffolk, 1484-1545), the daughter of Henry VII. and granddaughter of Edward IV.

combination could not last. At the general election of 1895 it was clear that there were divisions as to what issue the Liberals were fighting for, and the effect of Sir William Harcourt's abortive Local Veto Bill on the election was seen not only in his defeat at Derby, which gave the signal for the Liberal rout, but in the set-back it gave to temperance legislation. Though returned for West Monmouthshire (1895, 1900), his speeches in debate only occasionally showed his characteristic spirit, and it was evident that for the hard work of Opposition he no longer had the same motive as of old. In December 1898 the crisis arrived, and with Mr John Morley he definitely retired from the counsels of the party and resigned his leadership of the Opposition, alleging as his reason, in letters exchanged between Mr Morley and himself, the cross-currents of opinion among his old supporters and former colleagues. The split excited considerable comment, and resulted in much heart-burning and a more or less open division between the section of the Liberal party following Lord Rosebery (*q.v.*) and those who disliked that statesman's Imperialistic views.

Though now a private member, Sir William Harcourt still continued to vindicate his opinions in his independent position, and his attacks on the government were no longer restrained by even the semblance of deference to Liberal Imperialism. He actively intervened in 1899 and 1900, strongly condemning the government's financial policy and their attitude towards the Transvaal; and throughout the Boer War he lost no opportunity of criticizing the South African developments in a pessimistic vein. One of the readiest parliamentary debaters, he savoured his speeches with humour of that broad and familiar order which appeals particularly to political audiences. In 1898-1900 he was conspicuous, both on the platform and in letters written to *The Times*, in demanding active measures against the Ritualistic party in the Church of England; but his attitude on that subject could not be dissociated from his political advocacy of Disestablishment. In March 1904, just after he had announced his intention not to seek election again to parliament, he succeeded, by the death of his nephew, to the family estates at Nuneham. But he died suddenly there on the 1st of October in the same year. He married, first, in 1859, Thérèse (d. 1863), daughter of Mr T. H. Lister, by whom he had one son, Lewis Vernon Harcourt (b. 1863), afterwards first commissioner of works both in Sir Henry Campbell-Bannerman's 1905 ministry (included in the cabinet in 1907) and in Mr Asquith's cabinet (1908); and secondly, in 1876, Elizabeth, widow of Mr T. Ives and daughter of Mr. J. L. Motley, the historian, by whom he had another son, Robert (b. 1878).

Sir William Harcourt was one of the great parliamentary figures of the Gladstonian Liberal period. He was essentially an aristocratic type of late 19th century Whig, with a remarkable capacity for popular campaign fighting. He had been, and remained, a brilliant journalist in the non-professional sense. He was one of those who really made the *Saturday Review* in its palmy days, and in the period of his own most ebullient vigour, while Mr Gladstone was alive, his sense of political expediency and platform effectiveness in controversy was very acute. But though he played the game of public life with keen zest, he never really touched either the country or his own party with the faith which creates a personal following, and in later years he found himself somewhat isolated and disappointed, though he was free to express his deeper objections to the new developments in church and state. A tall, fine man, with the grand manner, he was, throughout a long career, a great personality in the life of his time. (H. CH.)

HARCOURT, WILLIAM VERNON (1780-1871), founder of the British Association, was born at Sudbury, Derbyshire, in 1780, a younger son of Edward Vernon [Harcourt], archbishop of York (see above). Having served for five years in the navy he went up to Christ Church, Oxford, with a view to taking holy orders. He began his clerical duties at Bishopthorpe, Yorkshire, in 1811, and having developed a great interest in science while at the university, he took an active part in the foundation of the Yorkshire Philosophical Society, of which he

was the first president. The laws and the plan of proceedings for the British Association for the Advancement of Science were drawn up by him; and Harcourt was elected president in 1830. In 1824 he became canon of York and rector of Wheldrake in Yorkshire, and in 1837 rector of Bolton Percy. The Yorkshire school for the blind and the Castle Howard reformatory both owe their existence to his energies. His spare time until quite late in life was occupied with scientific experiments. Inheriting the Harcourt estates in Oxfordshire from his brother in 1861, he removed to Nuneham, where he died in April 1871.

HARDANGER FJORD, an inlet on the west coast of Norway, penetrating the mainland for 70 m. apart from the deep fringe of islands off its mouth, the total distance from the open sea to the head of the fjord being 114 m. Its extreme depth is about 350 fathoms. The entrance at Torø is 50 m. by water south of Bergen, 60° N., and the general direction is N.E. from that point. The fjord is flanked by magnificent mountains, from which many waterfalls pour into it. The main fjord is divided into parts under different names, and there are many fine branch fjords. The fjord is frequented by tourists, and the principal stations have hotels. The outer fjord is called the Kvindherredsfjord, flanked by the Melderskin (4680 ft.); then follow Sildefjord and Bonde Sund, separated by Varalds island. Here Mauranger-fjord opens on the east; from Sundal on this inlet the great Folgefond snowfield may be crossed, and a fine glacier (Bondhusbrae) visited. Bakke and Vikingnaes are stations on Hisfjord, Nordheimsund and Østensø on Ytre Samlen, which throws off a fine narrow branch northward, the Fiksensund. There follow Indre Samlen and Utnefjord, with the station of Utne opposite Oxen (4120 ft.), and its northward branch, Gravenfjord, with the beautiful station of Eide at its head, whence a road runs north-west to Vossevangen. From the Utne terminal branches of the fjord run south and east; the Sörfjord, steeply walled by the heights of the Folgefond, with the frequented resort of Odde at its head; and the Eidfjord, with its branch Osefjord, terminating beneath a tremendous rampart of mountains, through which the sombre Simodal penetrates, the river flowing from Dæmmevand, a beautiful lake among the fields, and forming with its tributaries the fine falls of Skykje and Rembesdal. Vik is the principal station on Eidfjord, and Ulvik on a branch of the Ose, with a road to Vossevangen. At Vik is the mouth of the Bjøreia river, which, in forming the Vöringfos, plunges 520 ft. into a magnificent rock-bound basin. A small stream entering Sörfjord forms in its upper course the Skjaeggedalsfos, of equal height with the Vöringfos, and hardly less beautiful. The natives of Hardanger have an especially picturesque local costume.

HARDEE, WILLIAM JOSEPH (1815-1873), American soldier, was born in Savannah, Georgia, on the 10th of November 1815 and graduated from West Point in 1838. As a subaltern of cavalry he was employed on a special mission to Europe to study the cavalry methods in vogue (1839). He was promoted captain in 1844 and served under Generals Taylor and Scott in the Mexican War, winning the brevet of major for gallantry in action in March 1847 and subsequently that of lieutenant-colonel. After the war he served as a substantive major under Colonel Sidney Johnston and Lieut. Colonel Robert Lee in the 2nd U.S. cavalry, and for some time before 1856 he was engaged in compiling the official manual of infantry drill and tactics which, familiarly called "Hardee's Tactics," afterwards formed the text-book for the infantry arm in both the Federal and the Confederate armies. From 1856 to 1861 he was commandant of West Point, resigning his commission on the secession of his state in the latter year. Entering the Confederate service as a colonel, he was shortly promoted brigadier-general. He distinguished himself very greatly by his tactical leadership on the field of Shiloh, and was immediately promoted major-general. As a corps commander he fought under General Bragg at Perryville and Stone River, and for his distinguished services in these battles was promoted lieutenant-general. He served in the latter part of the campaign of 1863 under Bragg and in that of 1864 under J. E. Johnston. When the latter officer was superseded

by Hood, Hardee was relieved at his own request, and for the remainder of the war he served in the Carolinas. When the Civil War came to an end in 1865 he retired to his plantation near Selma, Alabama. He died at Wytheville, Virginia, on the 6th of November 1873.

HARDENBERG, KARL AUGUST VON, PRINCE (1750-1822), Prussian statesman, was born at Essenroda in Hanover on the 31st of May 1750. After studying at Leipzig and Göttingen he entered the Hanoverian civil service in 1770 as councillor of the board of domains (*Kammerrat*); but, finding his advancement slow, he set out—on the advice of King George III.—on a course of travels, spending some time at Wetzlar, Regensburg (where he studied the mechanism of the Imperial government), Vienna and Berlin. He also visited France, Holland and England, where he was kindly received by the king. On his return he married, by his father's desire, the countess Reventlow. In 1778 he was raised to the rank of privy councillor and created a count. He now again went to England, in the hope of obtaining the post of Hanoverian envoy in London; but, his wife becoming entangled in an *amour* with the prince of Wales, so great a scandal was created that he was forced to leave the Hanoverian service. In 1782 he entered that of the duke of Brunswick, and as president of the board of domains displayed a zeal for reform, in the manner approved by the enlightened despots of the century, that rendered him very unpopular with the orthodox clergy and the conservative estates. In Brunswick, too, his position was in the end made untenable by the conduct of his wife, whom he now divorced; he himself, shortly afterwards, marrying a divorced woman. Fortunately for him, this coincided with the lapsing of the principalities of Ansbach and Bayreuth to Prussia, owing to the resignation of the last margrave, Charles Alexander, in 1791. Hardenberg, who happened to be in Berlin at the time, was on the recommendation of Herzberg appointed administrator of the principalities (1792). The position, owing to the singular overlapping of territorial claims in the old Empire, was one of considerable delicacy, and Hardenberg filled it with great skill, doing much to reform traditional anomalies and to develop the country, and at the same time labouring to expand the influence of Prussia in South Germany. After the outbreak of the revolutionary wars his diplomatic ability led to his appointment as Prussian envoy, with a roving commission to visit the Rhenish courts and win them over to Prussia's views; and ultimately, when the necessity for making peace with the French Republic had been recognized, he was appointed to succeed Count Golts as Prussian plenipotentiary at Basel (February 28, 1795), where he signed the treaty of peace.

In 1797, on the accession of King Frederick William III., Hardenberg was summoned to Berlin, where he received an important position in the cabinet and was appointed chief of the departments of Magdeburg and Halberstadt, for Westphalia, and for the principality of Neuchâtel. In 1793 Hardenberg had struck up a friendship with Count Haugwitz, the influential minister for foreign affairs, and when in 1803 the latter went away on leave (August-October) he appointed Hardenberg his *locum tenens*. It was a critical period. Napoleon had just occupied Hanover, and Haugwitz had urged upon the king the necessity for strong measures and the expediency of a Russian alliance. During his absence, however, the king's irresolution continued; he clung to the policy of neutrality which had so far seemed to have served Prussia so well; and Hardenberg contented himself with adapting himself to the royal will. By the time Haugwitz returned, the unyielding attitude of Napoleon had caused the king to make advances to Russia; but the mutual declarations of the 3rd and 25th of May 1804 only pledged the two powers to take up arms in the event of a French attack upon Prussia or of further aggressions in North Germany. Finally, Haugwitz, unable to persuade the cabinet to a more vigorous policy, resigned, and on the 14th of April 1804 Hardenberg succeeded him as foreign minister.

If there was to be war, Hardenberg would have preferred the French alliance, which was the price Napoleon demanded for the cession of Hanover to Prussia; for the Eastern powers would

scarcely have conceded, of their free will, so great an augmentation of Prussian power. But he still hoped to gain the coveted prize by diplomacy, backed by the veiled threat of an armed neutrality. Then occurred Napoleon's contemptuous violation of Prussian territory by marching three French corps through Ansbach; King Frederick William's pride overcame his weakness, and on the 3rd of November he signed with the tsar Alexander the terms of an ultimatum to be laid before the French emperor. Haugwitz was despatched to Vienna with the document; but before he arrived the battle of Austerlitz had been fought, and the Prussian plenipotentiary had to make the best terms he could with the conqueror. Prussia, indeed, by the treaty signed at Schönbrunn on the 15th of December 1805, received Hanover, but in return for all her territories in South Germany. One condition of the arrangement was the retirement of Hardenberg, whom Napoleon disliked. He was again foreign minister for a few months after the crisis of 1806 (April-July 1807); but Napoleon's resentment was implacable, and one of the conditions of the terms granted to Prussia by the treaty of Tilsit was Hardenberg's dismissal.

After the enforced retirement of Stein in 1810 and the unsatisfactory interlude of the feeble Altenstein ministry, Hardenberg was again summoned to Berlin, this time as chancellor (June 6, 1810). The campaign of Jena and its consequences had had a profound effect upon him; and in his mind the traditions of the old diplomacy had given place to the new sentiment of nationality characteristic of the coming age, which in him found expression in a passionate desire to restore the position of Prussia and crush her oppressors. During his retirement at Riga he had worked out an elaborate plan for reconstructing the monarchy on Liberal lines; and when he came into power, though the circumstances of the time did not admit of his pursuing an independent foreign policy, he steadily prepared for the struggle with France by carrying out Stein's far-reaching schemes of social and political reorganization. The military system was completely reformed, serfdom was abolished, municipal institutions were fostered, the civil service was thrown open to all classes, and great attention was devoted to the educational needs of every section of the community.

When at last the time came to put these reforms to the test, after the Moscow campaign of 1812, it was Hardenberg who, supported by the influence of the noble Queen Louise, determined Frederick William to take advantage of General York's loyal disloyalty and declare against France. He was rightly regarded by German patriots as the statesman who had done most to encourage the spirit of national independence; and immediately after he had signed the first peace of Paris he was raised to the rank of prince (June 3, 1814) in recognition of the part he had played in the War of Liberation.

Hardenberg now had an assured position in that close corporation of sovereigns and statesmen by whom Europe, during the next few years, was to be governed. He accompanied the allied sovereigns to England, and at the congress of Vienna (1814-1815) was the chief plenipotentiary of Prussia. But from this time the zenith of his influence, if not of his fame, was passed. In diplomacy he was no match for Metternich, whose influence soon overshadowed his own in the councils of Europe, of Germany, and ultimately even of Prussia itself. At Vienna, in spite of the powerful backing of Alexander of Russia, he failed to secure the annexation of the whole of Saxony to Prussia; at Paris, after Waterloo, he failed to carry through his views as to the further dismemberment of France; he had weakly allowed Metternich to forestall him in making terms with the states of the Confederation of the Rhine, which secured to Austria the preponderance in the German federal diet; on the eve of the conference of Carlsbad (1819) he signed a convention with Metternich, by which—to quote the historian Treitschke—"like a penitent sinner, without any formal *quod pro quo*, the monarchy of Frederick the Great yielded to a foreign power a voice in her internal affairs." At the congresses of Aix-la-Chapelle, Troppau, Laibach and Verona the voice of Hardenberg was but an echo of that of Metternich.

The cause lay partly in the difficult circumstances of the

loosely-knit Prussian monarchy, but partly in Hardenberg's character, which, never well balanced, had deteriorated with age. He continued amiable, charming and enlightened as ever; but the excesses which had been pardonable in a young diplomatist were a scandal in an elderly chancellor, and could not but weaken his influence with so pious a *Landesvater* as Frederick William III. To overcome the king's terror of Liberal experiments would have needed all the powers of an adviser at once wise and in character wholly trustworthy. Hardenberg was wise enough; he saw the necessity for constitutional reform; but he clung with almost senile tenacity to the sweets of office, and when the tide turned strongly against Liberalism he allowed himself to drift with it. In the privacy of royal commissions he continued to elaborate schemes for constitutions that never saw the light; but Germany, disillusioned, saw only the faithful henchman of Metternich, an accomplice in the policy of the Carlsbad Decrees and the Troppau Protocol. He died, soon after the closing of the congress of Verona, at Genoa, on the 26th of November 1822.

See L. v. Ranke, *Denkwürdigkeiten des Staatskanzlers Fürsten von Hardenberg* (5 vols., Leipzig, 1877); J. R. Seeley, *The Life and Times of Stein* (3 vols., Cambridge, 1878); E. Meier, *Reform der Verwaltungsgeschichte unter Stein und Hardenberg* (ib., 1881); Chr. Meyer, *Hardenberg und seine Verwaltung der Fürstentümer Ansbach und Bayreuth* (Breslau, 1892); Koser, *Die Neuordnung des preussischen Archivwesens durch den Staatskanzler Fürsten v. Hardenberg* (Leipzig, 1904).

HARDERWYK, a seaport in the province of Gelderland, Holland, on the shores of the Zuider Zee, 17 m. by rail N.N.E. of Amersfoort. Pop. (1900) 7425. It is a quaint old town, approached by a fine avenue of trees, and standing in the midst of a patch of fertile ground. Harderwyk is chiefly important as being the depot for recruits for the Dutch colonial army. It contains a small fort and large barracks. The principal buildings are the town hall, with some ancient furniture, a large 15th century church with a notable square tower, a municipal orphanage, and the Nassau-Veluwe gymnasium. Agriculture, fishing, and a few domestic industries form the only employment of the inhabitants. As a seaport its trade is now confined exclusively to the Zuider Zee.

HARDICANUTE [more correctly **HARDACNUT**] (c. 1019-1042), son of Canute, king of England, by his wife Ælfgifu or Emma, was born about 1019. In the contest for the English crown which followed the death of Canute in 1035 the claims of Hardicanute were supported by Emma and her ally, Godwine, earl of the West Saxons, in opposition to those of Harold, Canute's illegitimate son, who was backed by the Mercian earl Leofric and the chief men of the north. At a meeting of the witan at Oxford a compromise was ultimately arranged by which Harold was temporarily elected regent of all England, pending the final settlement of the question on the return of Hardicanute from Denmark. The compromise was strongly opposed by Godwine and Emma, who for a time forcibly held Wessex in Hardicanute's behalf. But Harold's party rapidly increased; and early in 1037 he was definitely elected king. Emma was driven out and took refuge at Bruges. In 1039 Hardicanute joined her, and together they concerted an attack on England. But next year Harold died; and Hardicanute peacefully succeeded. His short reign was marked by great oppression and cruelty. He caused the dead body of Harold to be dug up and thrown into a fen; he exacted so heavy a geld for the support of his foreign fleet that great discontent was created throughout the kingdom, and in Worcestershire a general uprising took place against those sent to collect the tax, whereupon he burned the city of Worcester to the ground and devastated the surrounding country; in 1041 he permitted Edwulf, earl of Northumbria, to be treacherously murdered after having granted him a safe-conduct. While "he stood at his drink" at the marriage feast of one of his sons he was suddenly seized with a fit, from which he died a few days afterwards on the 8th of June 1042.

HARDING, CHESTER (1792-1866), American portrait painter, was born at Conway, Massachusetts, on the 1st of September 1792. Brought up in the wilderness of New York state, Harding,

as a lad of splendid physique, standing over 6 ft. 3 in., marched as a drummer with the militia to the St Lawrence in 1813. He became subsequently chairmaker, peddler, inn-keeper, and house-painter, painting signs in Pittsburg, Pa., and eventually going on the road, self-taught, as an itinerant portrait painter. He made enough money to take him to the schools at the Philadelphia Academy of Design, and he soon became proficient enough to gain a competency, so that later he went to England and set up a studio in London. There he met with great success, painting royalty and the nobility, and, despite the lackings of an early education and social experience, he became a favourite in all circles. Returning to the United States, he settled in Boston and painted portraits of many of the prominent men and women of his time. He died on the 1st of April 1866.

HARDING, JAMES DUFFIELD (1798-1863), English landscape painter, was the son of an artist, and took to the same vocation at an early age, although he had originally been destined for the law. He was in the main a water-colour painter and a lithographer, but he produced various oil-paintings both at the beginning and towards the end of his career. He frequently contributed to the exhibitions of the Water-Colour Society, of which he became an associate in 1821, and a full member in 1822. He was also very largely engaged in teaching, and published several books developing his views of art—amongst others, *The Tourist in Italy* (1831); *The Tourist in France* (1834); *The Park and the Forest* (1841); *The Principles and the Practice of Art* (1845); *Elementary Art* (1846); *Scotland delineated in a Series of Views* (1847); *Lessons on Art* (1849). He died at Barnes on the 4th of December 1863. Harding was noted for facility, sureness of hand, nicety of touch, and the various qualities which go to make up an elegant, highly trained, and accomplished sketcher from nature, and composer of picturesque landscape material; he was particularly skillful in the treatment of foliage.

HARDINGE, HENRY HARDINGE, Viscount (1785-1856), British field marshal and governor-general of India, was born at Wrotham in Kent on the 30th of March 1785. After being at Eton, he entered the army in 1799 as an ensign in the Queen's Rangers, a corps then stationed in Upper Canada. His first active service was at the battle of Vimiera, where he was wounded; and at Corunna he was by the side of Sir John Moore when he received his death-wound. Subsequently he received an appointment as deputy-quartermaster-general in the Portuguese army from Marshal Beresford, and was present at nearly all the battles of the Peninsular War, being wounded again at Vittoria. At Albuera he saved the day for the British by taking the responsibility at a critical moment of strongly urging General Cole's division to advance. When peace was again broken in 1815 by Napoleon's escape from Elba, Hardinge hastened into active service, and was appointed to the important post of commissioner at the Prussian headquarters. In this capacity he was present at the battle of Ligny on the 16th of June 1815, where he lost his left hand by a shot, and thus was not present at Waterloo, fought two days later. For the loss of his hand he received a pension of £300; he had already been made a K.C.B., and Wellington presented him with a sword that had belonged to Napoleon. In 1820 and 1826 Sir Henry Hardinge was returned to parliament as member for Durham; and in 1828 he accepted the office of secretary at war in Wellington's ministry, a post which he also filled in Peel's cabinet in 1841-1844. In 1830 and 1834-1835 he was chief secretary for Ireland. In 1844 he succeeded Lord Ellenborough as governor-general of India. During his term of office the first Sikh War broke out; and Hardinge, waiving his right to the supreme command, magnanimously offered to serve as second in command under Sir Hugh Gough; but disagreeing with the latter's plan of campaign at Ferozshah, he temporarily reasserted his authority as governor-general (see SIKH WARS). After the successful termination of the campaign at Sohraon he was created Viscount Hardinge of Lahore and of King's Newton in Derbyshire, with a pension of £3000 for three lives; while the East India Company voted him an annuity of £5000, which he declined to accept. Hardinge's term of office in India was marked by many social and educational

reforms. He returned to England in 1848, and in 1855 succeeded the duke of Wellington as commander-in-chief of the British army. While in this position he had the home management of the Crimean War, which he endeavoured to conduct on Wellington's principles—a system not altogether suited to the changed mode of warfare. In 1855 he was promoted to the rank of field marshal. Viscount Hardinge resigned his office of commander-in-chief in July 1856, owing to failing health, and died on the 24th of September of the same year at South Park near Tunbridge Wells. His elder son, Charles Stewart (1822-1894), who had been his private secretary in India, was the 2nd Viscount Hardinge; and the latter's eldest son succeeded to the title. The younger son of the 2nd Viscount, Charles Hardinge (b. 1858), became a prominent diplomatist (see EDWARD VII.), and was appointed governor-general of India in 1910, being created Baron Hardinge of Penshurst.

See C. Hardinge, *Viscount Hardinge* (Rulers of India series, 1891); and R. S. Rait, *Life and Campaigns of Viscount Gough* (1903).

HARDOI, a town and district of British India, in the Lucknow division of the United Provinces. The town is 63 m. N.E. of Lucknow by rail. Pop. (1901) 12,174. It has a wood-carving industry, saltpetre works, and an export trade in grain.

The DISTRICT OF HARDOI has an area of 2331 sq. m. It is a level district watered by the Ganges, Ramganga, Deoha or Garra, Sukheta, Sai, Baita and Gumti—the three rivers first named being navigable by country boats. Towards the Ganges the land is uneven, and often rises in hillocks of sand cultivated at the base, and their slopes covered with lofty *munj* grass. Several large *jhils* or swamps are scattered throughout the district, the largest being that of Sandi, which is 3 m. long by from 1 to 2 m. broad. These *jhils* are largely used for irrigation. Large tracts of forest jungle still exist. Leopards, black buck, spotted deer, and *wilgai* are common; the mallard, teal, grey duck, common goose, and all kinds of waterfowl abound. In 1901 the population of the district was 1,092,834, showing a decrease of nearly 2% in the decade. The district contains a larger urban population than any other in Oudh, the largest town being Shahabad, 20,036 in 1901. It is traversed by the Oudh and Rohilkhand railway from Lucknow to Shahjahanpur, and its branches. The chief exports are grain, sugar, hides, tobacco and saltpetre.

The first authentic records of Hardoi are connected with the Mussulman colonization. Bāwan was occupied by Sayyid Sālār Masūd in 1028, but the permanent Moslem occupation did not begin till 1217. Owing to the situation of the district, Hardoi formed the scene of many sanguinary battles between the rival Afghan and Mogul empires. Between Bilgrām and Sandi was fought the great battle between Humāyūn and Sher Shāh, in which the former was utterly defeated. Hardoi, along with the rest of Oudh, became British territory under Lord Dalhousie's proclamation of February 1856.

HARDOUIN, JEAN (1646-1729), French classical scholar, was born at Quimper in Brittany. Having acquired a taste for literature in his father's book-shop, he sought and obtained about his sixteenth year admission into the order of the Jesuits. In Paris, where he went to study theology, he ultimately became librarian of the Collège Louis le Grand in 1683, and he died there on the 3rd of September 1729. His first published work was an edition of Themistius (1684), which included no fewer than thirteen new orations. On the advice of Jean Garnier (1612-1681) he undertook to edit the *Natural History* of Pliny for the Delphin series, a task which he completed in five years. His attention having been turned to numismatics as auxiliary to his great editorial labours, he published several learned works in that department, marred, however, as almost everything he did was marred, by a determination to be at all hazards different from other interpreters. It is sufficient to mention his *Nummi antiqui populorum et urbium illustrati* (1684), *Antirrheticus de nummis antiquis coloniarum et municipiorum* (1689), and *Chronologia Veteris Testamenti ad vulgaram versionem exacta et nummis illustrata* (1696). By the ecclesiastical authorities Hardouin was appointed to supervise the *Conciliorum collectio regia maxima*

(1715); but he was accused of suppressing important documents and foisting in apocryphal matter, and by the order of the parlement of Paris (then at war with the Jesuits) the publication of the work was delayed. It is really a valuable collection, much cited by scholars. Hardouin declared that all the councils supposed to have taken place before the council of Trent were fictitious. It is, however, as the originator of a variety of paradoxical theories that Hardouin is now best remembered. The most remarkable, contained in his *Chronologiae ex nummis antiquis restitutae* (1696) and *Prælogomena ad censuram veterum scriptorum*, was to the effect that, with the exception of the works of Homer, Herodotus and Cicero, the *Natural History* of Pliny, the *Georgics* of Virgil, and the *Satires and Epistles of Horace*, all the ancient classics of Greece and Rome were spurious, having been manufactured by monks of the 13th century, under the direction of a certain Severus Archontius. He denied the genuineness of most ancient works of art, coins and inscriptions, and declared that the New Testament was originally written in Latin.

See A. Debacker, *Bibliothèque des écrivains de la Compagnie de Jésus* (1853).

HARDT, HERMANN VON DER (1660–1746), German historian and orientalist, was born at Melle, in Westphalia, on the 15th of November 1660. He studied oriental languages in Jena and in Leipzig, and in 1690 he was called to the chair of oriental languages at Helmstedt. He resigned his position in 1727, but lived at Helmstedt until his death on the 28th of February 1746. Among his numerous writings the following deserve mention: *Autographa Lutheri aliorumque celeberrimorum virorum, ab anno 1517 ad annum 1546, Reformationis ætatem et historiam egregie illustrantia* (1690–1691); *Magnam occumenicam Constantiense concilium* (1697–1700); *Hebraeae linguae fundamenta* (1694); *Syriacae linguae fundamenta* (1694); *Elementa Chaldaica* (1693); *Historia litteraria reformationis* (1717); *Enigmata priæri orbis* (1723). Hardt left in manuscript a history of the Reformation which is preserved in the Helmstedt Juleum.

See F. Lamey, *Hermann von der Hardt in seinen Briefen* (Karlsruhe, 1891).

HARDT, THE, a mountainous district of Germany, in the Bavarian palatinate, forming the northern end of the Vosges range. It is, in the main, an undulating high plateau of sandstone formation, of a mean elevation of 1300 ft., and reaching its highest point in the Donnersberg (2254 ft.). The eastern slope, which descends gently towards the Rhine, is diversified by deep and well-wooded valleys, such as those of the Lauter and the Queich, and by conical hills surmounted by the ruins of frequent feudal castles and monasteries. Noticeable among these are the Madenburg near Eschbach, the Trifels (long the dungeon of Richard I. of England), and the Maxburg near Neustadt. Three-fifths of the whole area is occupied by forests, principally oak, beech and fir. The lower eastern slope is highly cultivated and produces excellent wine.

HARDWAR, or HURDWAR, an ancient town of British India, and Hindu place of pilgrimage, in the Saharanpur district of the United Provinces, on the right bank of the Ganges, 17 m. N.E. of Rurki, with a railway station. The Ganges canal here takes off from the river. A branch railway to Dehra was opened in 1900. Pop. (1901), 25,597. The town is of great antiquity, and has borne many names. It was originally known as Kapila from the sage Kapila. Hsüan Tsang, the Chinese Buddhist pilgrim, in the 7th century visited a city which he calls Mo-yu-lo, the remains of which still exist at Mayapur, a little to the south of the modern town. Among the ruins are a fort and three temples, decorated with broken stone sculptures. The great object of attraction at present is the Hari-ka-charan, or bathing ghat, with the adjoining temple of Gangadwara. The *chavan* or foot-mark of Vishnu, imprinted on a stone let into the upper wall of the ghat, forms an object of special reverence. A great assemblage of people takes place annually, at the beginning of the Hindu solar year, when the sun enters Aries; and every twelfth year a feast of peculiar sanctity occurs, known as a *Kumbh-mela*. The ordinary number of pilgrims at the annual fair

amounts to 100,000, and at the Kumbh-mela to 300,000; in 1903 there were 400,000 present. Since 1893 many sanitary improvements have been made for the benefit of the annual concourse of pilgrims. In early days riots and also outbreaks of cholera were of common occurrence. The Hardwar meeting also possesses mercantile importance, being one of the principal horse-fairs in Upper India. Commodities of all kinds, Indian and European, find a ready sale, and the trade in grain and food-stuffs forms a lucrative traffic.

HARDWICKE, PHILIP YORKE, 1ST EARL OF (1690–1764), English lord chancellor, son of Philip Yorke, an attorney, was born at Dover, on the 1st of December 1690. Through his mother, Elizabeth, daughter and co-heiress of Richard Gibbon of Rolvenden, Kent, he was connected with the family of Gibbon the historian. At the age of fourteen, after a not very thorough education at a private school at Bethnal Green, where, however, he showed exceptional promise, he entered an attorney's office in London. Here he gave some attention to literature and the classics as well as to law; but in the latter he made such progress that his employer, Salkeid, impressed by Yorke's powers, entered him at the Middle Temple in November 1708; and soon afterwards recommended him to Lord Chief Justice Parker (afterwards earl of Macclesfield) as law tutor to his sons. In 1715 he was called to the bar, where his progress was, says Lord Campbell, "more rapid than that of any other débutant in the annals of our profession," his advancement being greatly furthered by the patronage of Macclesfield, who became lord chancellor in 1718, when Yorke transferred his practice from the king's bench to the court of chancery, though he continued to go on the western circuit. In the following year he established his reputation as an equity lawyer in a case in which Sir Robert Walpole's family was interested, by an argument displaying profound learning and research concerning the jurisdiction of the chancellor, on lines which he afterwards more fully developed in a celebrated letter to Lord Kames on the distinction between law and equity. Through Macclesfield's influence with the duke of Newcastle Yorke entered parliament in 1719 as member for Lewes, and was appointed solicitor-general, with a knighthood, in 1720, although he was then a barrister of only four years' standing. His conduct of the prosecution of Christopher Layer in that year for treason as a Jacobite further raised Sir Philip Yorke's reputation as a forensic orator; and in 1723, having already become attorney-general, he passed through the House of Commons the bill of pains and penalties against Bishop Atterbury. He was excused, on the ground of his personal friendship, from acting for the crown in the impeachment of Macclesfield in 1725, though he did not exert himself to save his patron from disgrace largely brought about by Macclesfield's partiality for Yorke himself. He soon found a new and still more influential patron in the duke of Newcastle, to whom he henceforth gave his political support. He rendered valuable service to Walpole's government by his support of the bill for prohibiting loans to foreign powers (1730), of the increase of the army (1732) and of the excise bill (1733). In 1733 Yorke was appointed lord chief justice of the king's bench, with the title of Lord Hardwicke, and was sworn of the privy council; and in 1737 he succeeded Talbot as lord chancellor, thus becoming a member of Sir Robert Walpole's cabinet. One of his first official acts was to deprive the poet Thomson of a small office conferred on him by Talbot.

Hardwicke's political importance was greatly increased by his removal to the House of Lords, where the incompetency of Newcastle threw on the chancellor the duty of defending the measures of the government. He resisted Carteret's motion to reduce the army in 1738, and the resolutions hostile to Spain over the affair of Captain Jenkins's ears. But when Walpole bent before the storm and declared war against Spain, Hardwicke advocated energetic measures for its conduct; and he tried to keep the peace between Newcastle and Walpole. There is no sufficient ground for Horace Walpole's charge that the fall of Sir Robert was brought about by Hardwicke's treachery. No one was more surprised than himself when he retained the

chancellorship in the following administration, and he resisted the proposal to indemnify witnesses against Walpole in one of his finest speeches in May 1742. He exercised a leading influence in the Wilmington Cabinet; and when Wilmington died in August 1743, it was Hardwicke who put forward Henry Pelham for the vacant office against the claims of Pulteney. For many years from this time he was the controlling power in the government. During the king's absences on the continent Hardwicke was left at the head of the council of regency; it thus fell to him to concert measures for dealing with the Jacobite rising in 1745. He took a just view of the crisis, and his policy for meeting it was on the whole statesmanlike. After Culloden he presided at the trial of the Scottish Jacobite peers, his conduct of which, though judicially impartial, was neither dignified nor generous; and he must be held partly responsible for the unnecessary severity meted out to the rebels, and especially for the cruel, though not illegal, executions on obsolete attainders of Charles Radcliffe and (in 1753) of Archibald Cameron. He carried, however, a great reform in 1746, of incalculable benefit to Scotland, which swept away the grave abuses of feudal power surviving in that country in the form of private heritable jurisdictions in the hands of the landed gentry. On the other hand his legislation in 1748 for disarming the Highlanders and prohibiting the use of the tartan in their dress was vexatious without being effective. Hardwicke supported Chesterfield's reform of the calendar in 1751; in 1753 his bill for legalizing the naturalization of Jews in England had to be dropped on account of the popular clamour it excited; but he successfully carried a salutary reform of the marriage law, which became the basis of all subsequent legislation on the subject.

On the death of Pelham in 1754 Hardwicke obtained for Newcastle the post of prime minister, and for reward was created earl of Hardwicke and Viscount Royston; and when in November 1756 the weakness of the ministry and the threatening aspect of foreign affairs compelled Newcastle to resign, Hardwicke retired with him. He played an important and disinterested part in negotiating the coalition between Newcastle and Pitt in 1757, when he accepted a seat in Pitt's cabinet without returning to the woolsack. After the accession of George III. Hardwicke opposed the ministry of Lord Bute on the peace with France in 1762, and on the cider tax in the following year. In the Wilkes case Hardwicke condemned general warrants, and also the doctrine that seditious libels published by members of parliament were protected by parliamentary privilege. He died in London on the 6th of March 1764.

Although for a lengthy period Hardwicke was an influential minister, he was not a statesman of the first rank. On the other hand he was one of the greatest judges who ever sat on the English bench. He did not, indeed, by his three years' tenure of the chief-justiceship of the king's bench leave any impress on the common law; but Lord Campbell pronounces him "the most consummate judge who ever sat in the court of chancery, being distinguished not only for his rapid and satisfactory decision of the causes which came before him, but for the profound and enlightened principles which he laid down, and for perfecting English equity into a systematic science." He held the office of lord chancellor longer than any of his predecessors, with a single exception; and the same high authority quoted above asserts that as an equity judge Lord Hardwicke's fame "has not been exceeded by that of any man in ancient or modern times. His decisions have been, and ever will continue to be, appealed to as fixing the limits and establishing the principles of the great juridical system called Equity, which now not only in this country and in our colonies, but over the whole extent of the United States of America, regulates property and personal rights more than the ancient common law."¹ Hardwicke had prepared himself for this great and enduring service to English jurisprudence by study of the historical foundations of the chancellor's equitable jurisdiction, combined with profound

insight into legal principle, and a thorough knowledge of the Roman civil law, the principles of which he scientifically incorporated into his administration of English equity in the absence of precedents bearing on the causes submitted to his judgment. His decisions on particular points in dispute were based on general principles, which were neither so wide as to prove inapplicable to future circumstances, nor too restricted to serve as the foundation for a coherent and scientific system. His recorded judgments—which, as Lord Campbell observes, "certainly do come up to every idea we can form of judicial excellence"—combine luminous method of arrangement with elegance and lucidity of language.

Nor was the creation of modern English equity Lord Hardwicke's only service to the administration of justice. Born within two years of the death of Judge Jeffreys his influence was powerful in obliterating the evil traditions of the judicial bench under the Stuart monarchy, and in establishing the modern conception of the duties and demeanour of English judges. While still at the bar Lord Chesterfield praised his conduct of crown prosecutions as a contrast to the former "bloodhounds of the crown"; and he described Sir Philip Yorke as "naturally humane, moderate and decent." On the bench he had complete control over his temper; he was always urbane and decorous and usually dignified. His exercise of legal patronage deserves unmixt praise. As a public man he was upright and, in comparison with most of his contemporaries, consistent. His domestic life was happy and virtuous. His chief fault was avarice, which perhaps makes it the more creditable that, though a colleague of Walpole, he was never suspected of corruption. But he had a keen and steady eye to his own advantage, and he was said to be jealous of all who might become his rivals for power. His manners, too, were arrogant. Lord Waldegrave said of Hardwicke that "he might have been thought a great man had he been less avaricious, less proud, less unlike a gentleman." Although in his youth he contributed to the *Spectator* over the signature "Philip Homebred," he seems early to have abandoned all care for literature, and he has been reproached by Lord Campbell and others with his neglect of art and letters. He married, on the 16th of May 1719, Margaret, daughter of Charles Cocks (by his wife Mary, sister of Lord Chancellor Somers), and widow of John Lygon, by whom he had five sons and two daughters. His eldest daughter, Elizabeth, married Lord Anson; and the second, Margaret, married Sir Gilbert Heathcote. Three of his younger sons attained some distinction. Charles Yorke (*q.v.*), the second son, became like his father lord chancellor; the third, Joseph, was a diplomatist, and was created Lord Dover; while James, the fifth son, became bishop of Ely.

Hardwicke was succeeded in the earldom by his eldest son, PHILIP YORKE (1720-1795), 2nd earl of Hardwicke, born on the 19th of March 1720, and educated at Cambridge. In 1741 he became a fellow of the Royal Society. With his brother, Charles Yorke, he was one of the chief contributors to *Athenian Letters*; or the *Epistolary Correspondence of an agent of the King of Persia residing at Athens during the Peloponnesian War* (4 vols., London, 1741), a work that for many years had a considerable vogue and went through several editions. He sat in the House of Commons as member for Reigate (1741-1747), and afterwards for Cambridgeshire; and he kept notes of the debates which were afterwards embodied in Cobbett's *Parliamentary History*. He was styled Viscount Royston from 1754 till 1764, when he succeeded to the earldom. In politics he supported the Rockingham Whigs. He held the office of teller of the exchequer, and was lord-lieutenant of Cambridgeshire and high steward of Cambridge University. He edited a quantity of miscellaneous state papers and correspondence, to be found in MSS. collections in the British Museum. He died in London, on the 16th of May 1790. He married Jemima Campbell, only daughter of John, 3rd earl of Breadalbane, and granddaughter and heiress of Henry de Grey, duke of Kent, who became in her own right marchioness de Grey.

In default of sons, the title devolved on his nephew, PHILIP

¹ Lord Campbell, *Lives of the Lord Chancellors*, v. 43 (London, 1846).

YORKE (1757-1834), 3rd earl of Hardwicke, eldest son of Charles Yorke, lord chancellor, by his first wife, Catherine Freman, who was born on the 31st of May 1757 and was educated at Cambridge. He was M.P. for Cambridgeshire, following the Whig traditions of his family; but after his succession to the earldom in 1790 he supported Pitt, and took office in 1801 as lord lieutenant of Ireland (1801-1806), where he supported Catholic emancipation. He was created K.G. in 1803, and was a fellow of the Royal Society. He married Elizabeth, daughter of James Lindsay, 5th earl of Balcarres, in 1782, but left no son.

He was succeeded in the peerage by his nephew, CHARLES PHILIP YORKE (1799-1873), 4th earl of Hardwicke, English admiral, eldest son of Admiral Sir Joseph Sydney Yorke (1768-1831), who was second son of Charles Yorke, lord chancellor, by his second wife, Agneta Johnson. Charles Philip was born at Southampton on the 2nd of April 1799 and was educated at Harrow. He entered the royal navy in 1815, and served on the North American station and in the Mediterranean, attaining the rank of captain in 1825. He represented Reigate (1831) and Cambridgeshire (1832-1834) in the House of Commons; and after succeeding to the earldom in 1834, was appointed a lord in waiting by Sir Robert Peel in 1841. In 1858 he retired from the active list with the rank of rear-admiral, becoming vice-admiral in the same year, and admiral in 1863. He was a member of Lord Derby's cabinet in 1852 as postmaster-general and lord privy seal in 1858. In 1833 he married Susan, daughter of the 1st Lord Ravensworth, by whom he had five sons and three daughters. His eldest son, CHARLES PHILIP YORKE (1836-1897), 5th earl of Hardwicke, was comptroller of the household of Queen Victoria (1866-1868) and master of the buckhounds 1874-1880. He married in 1863, Sophia Georgiana, daughter of the 1st Earl Cowley. He was succeeded by his only son ALBERT EDWARD PHILIP HENRY YORKE (1867-1904), 6th earl of Hardwicke, who, after holding the posts of under-secretary of state for India (1900-1902) and for war (1902-1903), died unmarried on the 29th of November 1904; the title then went to his uncle, JOHN MANNERS YORKE (1840-1900), 7th earl of Hardwicke, second son of Charles Philip, the 4th earl, who joined the royal navy and served in the Baltic and in the Crimea (1854-1855). This earl died on the 13th of March 1900 and was succeeded by his son Charles Alexander (b. 1869) as 8th earl.

The contemporary authorities for the life of Lord Chancellor Hardwicke are voluminous, being contained in the memoirs of the period and in numerous collections of correspondence in the British Museum. See, especially, the *Hardwicke Papers*; the *Stone MSS.*; *Hist. MSS. Commission* (Reports 2, 3, 4, 5, 6, 8, 9, 11); Horace Walpole, *Letters* (ed. by P. Cunningham, 9 vols., London, 1857-1859); *Letters to Sir H. Mann* (ed. by Lord Dover, 4 vols., London, 1843-1844); *Memoirs of the Reign of George II.* (ed. by Lord Holland, 2nd ed. revised, London, 1847); *Memoirs of the Reign of George III.* (ed. by G. F. R. Barker, 4 vols., London, 1894); *Catalogue of Royal and Noble Authors of England, Scotland and Ireland* (ed. by T. Park, 5 vols., London, 1806). Horace Walpole was violently hostile to Hardwicke, and his criticism, therefore, must be taken with extreme reserve. See also the earl Waldegrave, *Memoirs 1754-1758* (London, 1821); Lord Chesterfield, *Letters*, ed. by Lord Mahon, 5 vols., London, 1892; Richard Cooksey, *Essay on John, Lord Somers, and Philip, Earl of Hardwicke* (Worcester, 1791); William Coxe, *Memoirs of Sir R. Walpole* (4 vols., London, 1816); *Memoirs of the Administration of Henry Pelham* (2 vols., London, 1829); Lord Campbell, *Lives of the Lord Chancellors*, vol. v. (8 vols., London, 1845); Edward Foss, *The Judges of England*, vols. vii. and viii. (9 vols., London, 1848-1864); George Harris, *Life of Lord Chancellor Hardwicke, with Selections from his Correspondence, Diaries, Speeches and Judgments* (3 vols., London, 1847). The last-named work may be consulted for the lives of the 2nd and 3rd earls. For the 3rd earl see also the duke of Buckingham, *Memoirs of the Court and Cabinets of George III.* (4 vols., London, 1853-1855). For the 4th earl see *Charles Philip Yorke*, by his daughter, Lady Biddulph of Ledbury (1910). (R. J. M.)

HARDY, ALEXANDRE (1569?-1631), French dramatist, was born in Paris. He was one of the most fertile of all dramatic authors, and himself claimed to have written some six hundred plays, of which, however, only thirty-four are preserved. He seems to have been connected all his life with a troupe of actors headed by a clever comedian named Valleran-Lecomte, whom he provided with plays. Hardy toured the provinces with this

company, which gave some representations in Paris in 1599 at the Hôtel de Bourgogne. Valleran-Lecomte occupied the same theatre in 1600-1603, and again in 1607, apparently for some years. In consequence of disputes with the Confrérie de la Passion, who owned the privilege of the theatre, they played elsewhere in Paris and in the provinces for some years, but in 1628, when they had long borne the title of "royal," they were definitely established at the Hôtel de Bourgogne. Hardy's numerous dedications never seem to have brought him riches or patrons. His most powerful friend was Isaac de Laffemas (d. 1657), one of Richelieu's most unscrupulous agents, and he was on friendly terms with the poet Théophile, who addressed him in some verses placed at the head of his *Théâtre* (1632), and Tristan l'Hermite had a similar admiration for him. Hardy's plays were written for the stage, not to be read; and it was in the interest of the company that they should not be printed and thus fall into the common stock. But in 1623 he published *Les Chastes et loyaux amours de Théagène et Cariclé*, a tragic-comedy in eight "days" or dramatic poems; and in 1624 he began a collected edition of his works, *Le Théâtre d'Alexandre Hardy, parisien*, of which five volumes (1624-1628) were published, one at Rouen and the rest in Paris. These comprise eleven tragedies: *Didon se sacrifiant*, *Scébase ou l'hospitalité violée*, *Panthée*, *Méleagre*, *La Mort d'Achille*, *Coriolan*, *Marianne*, a trilogy on the history of Alexander, *Alcibiade, ou la vengeance féminine*; five mythological pieces; thirteen tragic-comedies, among them *Csippé*, drawn from Boccaccio; *Phraarte*, taken from Giraldi's *Cent excellentes nouvelles* (Paris, 1584); *Cornélie*, *La Force du sang*, *Félimène*, *La Belle Égyptienne*, taken from Spanish subjects; and five pastorals, of which the best is *Alphée, ou la justice d'amour*. Hardy's importance in the history of the French theatre can hardly be over-estimated. Up to the end of the 16th century medieval farce and spectacle kept their hold on the stage in Paris. The French classical tragedy of Étienne Jodelle and his followers had been written for the learned, and in 1628 when Hardy's work was nearly over and Rotrou was on the threshold of his career, very few literary dramas by any other author are known to have been publicly represented. Hardy educated the popular taste, and made possible the dramatic activity of the 17th century. He had abundant practical experience of the stage, and modified tragedy accordingly, suppressing chorus and monologue, and providing the action and variety which was denied to the literary drama. He was the father in France of tragic-comedy, but cannot fairly be called a disciple of the romantic school of England and Spain. It is impossible to know how much later dramatists were indebted to him in detail, since only a fraction of his work is preserved, but their general obligation is amply established. He died in 1631 or 1632.

The sources for Hardy's biography are extremely limited. The account given by the brothers Parfaict in their *Hist. du Théâtre français* (1745, &c., vol. iv. pp. 2-4) must be received with caution, and no documents are forthcoming. Many writers have identified him with the provincial playwright picturesquely described in chap. xi. of *Le Page disgracié* (1643), the autobiography of Tristan l'Hermite, but if the portrait is drawn from life at all, it is more probably drawn from Théophile. See *Le Théâtre d'Alexandre Hardy*, edited by E. Stengel (Marburg and Paris, 1883-1884, 5 vols.); E. Lombard, "Étude sur Alexandre Hardy," in *Zeitschr. für vergleichende Spr. u. Lit.* (Oppeln and Leipzig, vol. i. and ii., 1880-1881); K. Nagel, *A. Hardy's Einfluss auf Pierre Corneille* (Marburg, 1884); and especially E. Fagel, *Alexandre Hardy* . . . (Paris, 1889) and *Le Théâtre français avant la période classique* (Paris, 1901).

HARDY, THOMAS (1840-), English novelist, was born in Dorsetshire on the 2nd of June 1840. His family was one of the branches of the Dorset Hardys, formerly of influence in and near the valley of the Frome, claiming descent from John Le Hardy of Jersey (son of Clement Le Hardy, lieutenant-governor of that island in 1488), who settled in the west of England. His maternal ancestors were the Sweetman, Childs or Child, and kindred families, who before and after 1635 were small landed proprietors in Melbury Osmond, Dorset, and adjoining parishes. He was educated at local schools, 1848-1854, and afterwards privately, and in 1856 was articled to Mr John Hicks, an

ecclesiastical architect of Dorchester. In 1859 he began writing verse and essays, but in 1861 was compelled to apply himself more strictly to architecture, sketching and measuring many old Dorset churches with a view to their restoration. In 1862 he went to London (which he had first visited at the age of nine) and became assistant to the late Sir Arthur Blomfield, R.A. In 1863 he won the medal of the Royal Institute of British Architects for an essay on *Coloured Brick and Terra-cotta Architecture*, and in the same year won the prize of the Architectural Association for design. In March 1865 his first short story was published in *Chambers's Journal*, and during the next two or three years he wrote a good deal of verse, being somewhat uncertain whether to take to architecture or to literature as a profession. In 1867 he left London for Weymouth, and during that and the following year wrote a "purpose" story, which in 1869 was accepted by Messrs Chapman and Hall. The manuscript had been read by Mr George Meredith, who asked the writer to call on him, and advised him not to print it, but to try another, with more plot. The manuscript was withdrawn and re-written, but never published. In 1870 Mr Hardy took Mr Meredith's advice too literally, and constructed a novel that was all plot, which was published in 1871 under the title *Desperate Remedies*. In 1872 appeared *Under the Greenwood Tree*, a "rural painting of the Dutch school," in which Mr Hardy had already "found himself," and which he has never surpassed in happy and delicate perfection of art. *A Pair of Blue Eyes*, in which tragedy and irony come into his work together, was published in 1873. In 1874 Mr Hardy married Emma Lavinia, daughter of the late T. Atterdell Gifford of Plymouth. His first popular success was made by *Far from the Madding Crowd* (1874), which, on its appearance anonymously in the *Cornhill Magazine*, was attributed by many to George Eliot. Then came *The Hand of Ethelberta* (1876), described, not inaptly, as "a comedy in chapters"; *The Return of the Native* (1878), the most sombre and, in some ways, the most powerful and characteristic of Mr Hardy's novels; *The Trumpet-Major* (1880); *A Laodicean* (1881); *Two on a Tower* (1882), a long excursion in constructive irony; *The Mayor of Casterbridge* (1886); *The Woodlanders* (1887); *Wessex Tales* (1888); *A Group of Noble Dames* (1891); *Tess of the D'Urbervilles* (1891), Mr Hardy's most famous novel; *Life's Little Ironies* (1894); *Jude the Obscure* (1895), his most thoughtful and least popular book; *The Well-Beloved*, a reprint, with some revision, of a story originally published in the *Illustrated London News* in 1892 (1897); *Wessex Poems*, written during the previous thirty years, with illustrations by the author (1898); and *The Dynasts* (2 parts, 1904-1906). In 1909 appeared *Time's Laughing-stocks and other Verses*. In all his work Mr Hardy is concerned with one thing, seen under two aspects; not civilization, nor manners, but the principle of life itself, invisibly realized in humanity as sex, seen visibly in the world as what we call nature. He is a fatalist, perhaps rather a determinist, and he studies the workings of fate or law (ruling through inexorable moods or humours), in the chief vivifying and disturbing influence in life, women. His view of women is more French than English; it is subtle, a little cruel, not as tolerant as it seems, thoroughly a man's point of view, and not, as with Mr Meredith, man's and woman's at once. He sees all that is irresponsible for good and evil in a woman's character, all that is untrustworthy in her brain and will, all that is alluring in her variability. He is her apologist, but always with a reserve of private judgment. No one has created more attractive women of a certain class, women whom a man would have been more likely to love or to regret loving. In his earlier books he is somewhat careful over the reputation of his heroines; gradually he allows them more liberty, with a franker treatment of instinct and its consequences. *Jude the Obscure* is perhaps the most unbiassed consideration in English fiction of the more complicated questions of sex. There is almost no passion in his work, neither the author nor his characters ever seeming able to pass beyond the state of curiosity, the most intellectually interesting of limitations, under the influence of any emotion. In his feeling for nature, curiosity sometimes seems to broaden into a more

intimate communion. The heath, the village with its peasants, the change of every hour among the fields and on the roads of that English countryside which he has made his own—the Dorsetshire and Wiltshire "Wessex"—mean more to him, in a sense, than even the spectacle of man and woman in their blind and painful and absorbing struggle for existence. His knowledge of woman confirms him in a suspension of judgment; his knowledge of nature brings him nearer to the unchanging and consoling element in the world. All the entertainment which he gets out of life comes to him from his contemplation of the peasant, as himself a rooted part of the earth, translating the dumbness of the fields into humour. His peasants have been compared with Shakespeare's; he has the Shakespearean sense of their placid vegetation by the side of hurrying animal life, to which they act the part of chorus, with an unconscious wisdom in their close, narrow and undistracted view of things. The order of merit was conferred upon Mr Hardy in July 1920.

See Annie Macdonell, *Thomas Hardy* (London, 1894); Lionel P. Johnson, *The Art of Thomas Hardy* (London, 1894). (A. S.)

HARDY, SIR THOMAS DUFFUS (1804-1878), English antiquary, was the third son of Major Thomas Bartholomew Price Hardy, and belonged to a family several members of which had distinguished themselves in the British navy. Born at Port Royal in Jamaica on the 22nd of May 1804, he crossed over to England and in 1819 entered the Record Office in the Tower of London. Trained under Henry Petrie (1768-1842) he gained a sound knowledge of palaeography, and soon began to edit selections of the public records. From 1861 until his death on the 15th of June 1878 he was deputy-keeper of the Record Office, which just before his appointment had been transferred to its new London headquarters in Chancery Lane. Hardy, who was knighted in 1873, had much to do with the appointment of the Historical Manuscripts Commission in 1869.

Sir T. Hardy edited the Close Rolls, *Rotuli litterarum clausurarum, 1204-1227* (2 vols., 1833-1844), with an introduction entitled "A Description of the Close Rolls, with an Account of the early Courts of Law and Equity"; and the Patent Rolls, *Rotuli litterarum patentium, 1201-1216* (1835), with introduction, "A Description of the Patent Rolls, to which is added an Itinerary of King John." He also edited the *Rotuli de oblatiis et finibus* (1835), which deal also with the time of King John; the *Rotuli Normannie, 1200-1205, and 1417-1418* (1835), containing letters and grants of the English kings concerning the duchy of Normandy; the Charter Rolls, *Rotuli chartarum, 1195-1216* (1837), giving with this work an account of the structure of charters; the Liberate Rolls, *Rotuli de liberatis ac de missis et propositis regnante Johanne* (1844); and the *Modus tenendi parliamentum*, with a translation (1846). He wrote *A Catalogue of Lords Chancellors, Keepers of the Great Seal, Masters of the Rolls and Officers of the Court of Chancery* (1843); the preface to Henry Petrie's *Monumenta historica Britannica* (1848); and *Descriptive Catalogue of Materials relating to the History of Great Britain and Ireland* (3 vols., 1862-1871). He edited William of Malmesbury's *De gestis regum anglorum* (2 vols., 1840); he continued and corrected John le Neve's *Fasti ecclesie Anglicane* (3 vols., Oxford, 1854); and with C. T. Martin he edited and translated *L'Estorie des Engles* of Geoffrey Gaimar (1888-1889). He wrote *Syllabus in English of Documents in Rymers's Foedera* (3 vols., 1869-1885), and gave an account of the history of the public records from 1837 to 1851 in his *Memoirs of the Life of Henry, Lord Langdale* (1853), Lord Langdale (1783-1851), master of the rolls from 1836 to 1851, being largely responsible for the erection of the new Record Office. Hardy took part in the controversy about the date of the Achanasian creed, writing *The Achanasian Creed in connection with the Utrecht Psalter* (1872); and *Further Report on the Utrecht Psalter* (1874).

His younger brother, SIR WILLIAM HARDY (1807-1887), was also an antiquary. He entered the Record Office in 1823, leaving it in 1830 to become keeper of the records of the duchy of Lancaster. In 1868, when these records were presented by Queen Victoria to the nation, he returned to the Record Office as an assistant keeper, and in 1878 he succeeded his brother Sir Thomas as deputy-keeper, resigning in 1886. He died on the 17th of March 1887.

Sir W. Hardy edited Jehan de Waurin's *Recueil des croniques et anciennes istories de la Grant Bretagne* (5 vols., 1864-1891); and he translated and edited the *Charters of the Duchy of Lancaster* (1845).

HARDY, SIR THOMAS MASTERMAN, Bart. (1769-1839), British vice-admiral, of the Portisham (Dorsetshire) family of Hardy, was born on the 5th of April 1769, and in 1781 began

his career as a sailor. He became lieutenant in 1793, and in 1796, being then attached to the "Minerve" frigate, attracted the attention of Nelson by his gallant conduct. He continued to serve with distinction, and in 1798 was promoted to be captain of the "Vanguard," Nelson's flagship. In the "St George" he did valuable work before the battle of Copenhagen in 1801, and his association with Nelson was crowned by his appointment in 1803 to the "Victory" as flag-captain, in which capacity he was engaged at the battle of Trafalgar in 1805, witnessed Nelson's will, and was in close attendance on him at his death. Hardy was created a baronet in 1806. He was then employed on the North American station, and later (1810), was made commodore and commander-in-chief on the South American station, where his able conduct came prominently into notice. In 1825 he became rear-admiral, and in December 1826 escorted the expeditionary force to Lisbon. In 1830 he was made first sea lord of the admiralty, being created G.C.B. in 1831. In 1834 he was appointed governor of Greenwich hospital, where thenceforward he devoted himself with conspicuous success to the charge of the naval pensioners; in 1837 he became vice-admiral. He died at Greenwich on the 20th of September 1839. In 1807 he had married Anne Louisa Emily, daughter of Sir George Cranfield Berkeley, under whom he had served on the North American station, and by her he had three daughters, the baronetcy becoming extinct.

See Marshall, *Royal Naval Biography*, ii. and iii.; Nicolas, *Despatches of Lord Nelson*; Broadley and Bartelot, *The Three Dorset Captains at Trafalgar* (1906), and *Nelson's Hardy, his Life, Letters and Friends* (1909).

HARDYNG or **HARDING**, **JOHN** (1378-1465), English chronicler, was born in the north, and as a boy entered the service of Sir Henry Percy (Hotspur), with whom he was present at the battle of Shrewsbury (1403). He then passed into the service of Sir Robert Umfraville, under whom he was constable of Warkworth Castle, and served in the campaign of Agincourt in 1415 and in the sea-fight before Harfleur in 1416. In 1424 he was on a diplomatic mission at Rome, where at the instance of Cardinal Beaufort he consulted the chronicle of Trogus Pompeius. Umfraville, who died in 1436, had made Hardyng constable of Kyme in Lincolnshire, where he probably lived till his death about 1465. Hardyng was a man of antiquarian knowledge, and under Henry V. was employed to investigate the feudal relations of Scotland to the English crown. For this purpose he visited Scotland, at much expense and hardship. For his services he says that Henry V. promised him the manor of Geddington in Northamptonshire. Many years after, in 1439, he had a grant of £10 a year for similar services. In 1457 there is a record of the delivery of documents relating to Scotland by Hardyng to the earl of Shrewsbury, and his reward by a further pension of £20. It is clear that Hardyng was well acquainted with Scotland, and James I. is said to have offered him a bribe to surrender his papers. But the documents, which are still preserved in the Record Office, have been shown to be forgeries, and were probably manufactured by Hardyng himself. Hardyng spent many years on the composition of a rhyming chronicle of England. His services under the Percies and Umfravilles gave him opportunity to obtain much information of value for 15th century history. As literature the chronicle has no merit. It was written and rewritten to suit his various patrons. The original edition ending in 1436 had a Lancastrian bias and was dedicated to Henry VI. Afterwards he prepared a version for Richard, duke of York (d. 1460), and the chronicle in its final form was presented to Edward IV. after his marriage to Elizabeth Woodville in 1464.

The version of 1436 is preserved in Lansdowne MS. 204, and the best of the later versions in Harley MS. 661, both in the British Museum. Richard Grafton printed two editions in January 1543, which differ much from one another and from the now extant manuscripts. Stow, who was acquainted with a different version, censured Grafton on this point somewhat unjustly. Sir Henry Ellis published the longer version of Grafton with some additions from the Harley MS. in 1812.

See Ellis' preface to *Hardyng's Chronicle*, and Sir F. Palgrave's *Documents illustrating the History of Scotland* (for an account of Hardyng's forgeries). (C. L. K.)

HARE, AUGUSTUS JOHN GUTHBERT (1834-1903), English writer and traveller, was born at Rome in 1834. He was educated at Harrow school and at University College, Oxford. His name is familiar as the author of a large number of guide-books to the principal countries and towns of Europe, most of which were written to order for John Murray. They were made up partly of the author's own notes of travel, partly of quotations from others' books taken with a frankness of appropriation that disarmed criticism. He also wrote *Memorials of a Quiet Life*—that of his aunt by whom he had been adopted when a baby (1872), and a tediously long autobiography in six volumes, *The Story of My Life*. He died at St Leonards-on-Sea on the 22nd of January 1903.

HARE, SIR JOHN (1844-), English actor and manager, was born in Yorkshire on the 16th of May 1844, and was educated at Giggleswick school, Yorkshire. He made his first appearance on the stage at Liverpool in 1864, coming to London in 1865, and acting for ten years with the Bancrofts. He soon made his mark, particularly in T. W. Robertson's comedies, and in 1875 became manager of the Court theatre. But it was in association with Mr and Mrs Kendal at the St James's theatre from 1879 to 1888 that he established his popularity in London, in important "character" and "men of the world" parts, the joint management of Hare and Kendal making this theatre one of the chief centres of the dramatic world for a decade. In 1889 he became lessee and manager of the Garrick theatre, where (though he was often out of the cast) he produced several important plays, such as Pinero's *The Profligate* and *The Notorious Mrs. Ebbesmire*, and had a remarkable personal success in the chief part in Sydney Grundy's *A Pair of Spectacles*. In 1897 he took the Globe theatre, where his acting in Pinero's *Gay Lord Quex* was another personal triumph. He became almost as well known in the United States as in England, his last tour in America being in 1900 and 1901. He was knighted in 1907.

HARE, JULIUS CHARLES (1795-1855), English theological writer, was born at Valdagne, near Vicenza, in Italy, on the 13th of September 1795. He came to England with his parents in 1799, but in 1804-1805 spent a winter with them at Weimar, where he met Goethe and Schiller, and received a bias to German literature which influenced his style and sentiments throughout his whole career. On the death of his mother in 1806, Julius was sent home to the Charterhouse in London, where he remained till 1812, when he entered Trinity College, Cambridge. There he became fellow in 1818, and after some time spent abroad he began to read law in London in the following year. From 1822 to 1832 he was assistant-tutor at Trinity College. Turning his attention from law to divinity, Hare took priest's orders in 1826; and, on the death of his uncle in 1832, he succeeded to the rich family living of Hurstmonceaux in Sussex, where he accumulated a library of some 12,000 volumes, especially rich in German literature. Before taking up residence in his parish he once more went abroad, and made in Rome the acquaintance of the Chevalier Bunsen, who afterwards dedicated to him part of his work, *Hippolytus and his Age*. In 1840 Hare was appointed archdeacon of Lewes, and in the same year preached a course of sermons at Cambridge (*The Victory of Faith*), followed in 1846 by a second, *The Mission of the Comforter*. Neither series when published attained any great popularity. Archdeacon Hare married in 1844 Esther, a sister of his friend Frederick Maurice. In 1851 he was collated to a prebend in Chichester; and in 1853 he became one of Queen Victoria's chaplains. He died on the 23rd of January 1855.

Julius Hare belonged to what has been called the "Broad Church party," though some of his opinions approach very closely to those of the Evangelical Arminian school, while others again seem vague and undecided. He was one of the first of his countrymen to recognize and come under the influence of German thought and speculation, and, amidst an exaggerated alarm of German heresy, did much to vindicate the authority of the sounder German critics. His writings, which are chiefly theological and controversial, are largely formed of charges to his clergy, and sermons on different topics; but, though valuable and full of thought, they lose some of their force by the cumbrous German structure of the sentences, and by certain orthographical peculiarities in which the author

indulged. In 1827 *Guesses of Truth by Two Brothers*¹ appeared. Hare assisted Thirlwall, afterwards bishop of St David's, in the translation of the 1st and 2nd volumes of Niebuhr's *History of Rome* (1828 and 1832), and published a *Vindication of Niebuhr's History* in 1829. He wrote many similar works, among which is a *Vindication of Luther against his recent English Assaults* (1854). In 1848 he edited the *Remains of John Sterling*, who had formerly been his curate. Carlyle's *Life of John Sterling* was written through dissatisfaction with the "Life" prefixed to Archdeacon Hare's book. *Memorials of a Quiet Life*, published in 1872, contain accounts of the Hare family.

HARE, the name of the well-known English rodent now designated *Lepus europaeus* (although formerly termed, incorrectly, *L. timidus*). In a wider sense the name includes all the numerous allied species which do not come under the designation of rabbits (see **RABBIT**). Over the greater part of Europe, where the ordinary species (fig. 1) does not occur, its place is taken by the closely allied Alpine, or mountain hare (fig. 2), the true *L. timidus* of Linnaeus, and the type of the genus *Lepus* and the family *Leporidae* (see **RODENTIA**). The second is a smaller animal than the first, with a more rounded and relatively smaller head, and the ears, hind-legs and tail shorter. In Ireland and the southern districts of Sweden it is permanently of a light fulvous grey colour, with black tips to the ears, but in more northerly districts the fur—except the black ear-tips—changes to white in winter, and still farther north the animal appears to be white at all seasons of the year. The range of the common or brown hare, inclusive of its local races, extends from England across southern and central Europe to the Caucasus; while that of the blue or mountain species, likewise inclusive of local races, reaches from Ireland, Scotland and Scandinavia through northern Europe and Asia to Japan and Kamchatka, and thence to Alaska.

The brown hare is a night-feeding animal, remaining during the day on its "form," as the slight depression is called which it makes in the open field, usually among grass. This it leaves at nightfall to seek fields of young wheat and other cereals whose tender herbage forms its favourite food. It is also fond of gnawing the bark of young trees, and thus often does great damage to plantations. In the morning it returns to its form, where it finds protection in the close approach which the colour of its fur makes to that of its surroundings; should it thus fail, however, to elude observation it depends for safety on its extra-



FIG. 1.—The Hare (*Lepus europaeus*).

ordinary fleetness. On the first alarm of danger it sits erect to reconnoitre, when it either seeks concealment by clapping close to the ground, or takes to flight. In the latter case its great speed, and the cunning endeavours it makes to outwit its canine pursuers, form the chief attractions of coursing. The hare takes readily to the water, where it swims well; an instance having been recorded in which one was observed crossing an arm of

¹ Julius Hare's co-worker in this book was his brother Augustus William Hare (1792-1834), who, after a distinguished career at Oxford, was appointed rector of Alton Barnes, Wiltshire. He died prematurely at Rome in 1834. He was the author of *Sermons to a Country Congregation*, published in 1837.

the sea about a mile in width. Hares are remarkably prolific, pairing when scarcely a year old, and the female bringing forth several broods in the year, each consisting of from two to five leverets (from the Fr. *lèvre*), as the young are called. These are born covered with hair and with the eyes open, and after being suckled for a month are able to look after themselves. In Europe this species has seldom bred in confinement, although an instance has recently been recorded. It will interbreed with the blue hare. Hares (and rabbits) have a cosmopolitan distribution with the exception of Madagascar and Australasia; and are now divided into numerous genera and subgenera, mentioned in the article



FIG. 2.—The Blue or Mountain Hare (*Lepus timidus*) in winter dress.

RODENTIA. Reference may here be made to a few species. Asia is the home of numerous species, of which the common Indian *L. ruficaudatus* and the black-necked hare *L. nigricollis*, are inhabitants of the plains of India; the latter taking its name from a black patch on the neck. In Assam there is a small spiny hare (*Caprolagus hispidus*), with the habits of a rabbit; and an allied species (*Nesolagus nitscheri*) inhabits Sumatra, and a third (*Pentalagus furnessi*) the Liu-kiu Islands. The plateau of Tibet is very rich in species, among which *L. hypobius* is very common.

Of African species, the Egyptian Hare (*L. aegyptius*) is a small animal, with long ears and pale fur; and in the south there are the Cape hare (*L. capensis*), the long-eared rock-hare (*L. saxatilis*) and the diminutive *Pronolagus crassicaudatus*, characterized by its thick red tail.

North America is the home of numerous hares, some of which are locally known as "cotton-tails" and others as "jack-rabbits." The most northern are the Polar hare (*L. arcticus*), the Greenland hare (*L. groenlandicus*) and the Alaska hare (*L. timidus tschuktschorum*), all allied to the blue hare. Of the others, two, namely the large prairie-hare (*L. campestris*) and the smaller varying hare (*L. [Poecilolagus] americanus*), turn white in winter; the former having long ears and the whole tail white, whereas in the latter the ears are shorter and the upper surface of the tail is dark. Of those which do not change colour, the wood-hare, grey-rabbit or cotton-tail, *Sylvilagus floridanus*, is a southern form, with numerous allied kinds. Distantly allied to the prairie-hare or white-tailed jack-rabbit, are several forms distinguished by having a more or less distinct black stripe on the upper surface of the tail. These include a buff-bellied species found in California, N. Mexico and S.W. Oregon (*L. [Macrotolagus] californicus*), a large, long-legged form from S. Arizona and Sonora (*L. [M.] alleni*), the Texan jack-rabbit (*L. [M.] texanus*) and the black-eared hare (*L. [M.] melanotis*) of the Great Plains, which differs from the third only by its shorter ears and richer coloration. In S. America, the small tapiti or Brazilian hare (*Sylvilagus brasiliensis*) is nearly allied to the wood-hare, but has a yellowish brown under surface to the tail.

See also **COURSING**.

(R. L.)

HAREBELL (sometimes wrongly written **HAIRBELL**), known also as the blue-bell of Scotland, and witches' thimbles, a well-known perennial wild flower, *Campanula rotundifolia*, a

member of the natural order Campanulaceae. The harebell has a very slender slightly creeping root-stock, and a wiry, erect stem.



Harebell (*Campanula rotundifolia*).

The radical leaves, that is, those at the base of the stem, to which the specific name *rotundifolia* refers, have long stalks, and are roundish or heart-shaped with crenate or serrate margin, the lower stem leaves are ovate or lanceolate, and the upper ones linear, subsessile, acute and entire, rarely pubescent. The flowers are slightly drooping, arranged in a panicle, or in small specimens single, having a smooth calyx, with narrow pointed erect segments, the corolla bell-shaped, with slightly recurved segments, and the capsule nodding, and opening by pores at the base. There are two varieties:—(a) *genuina*, with slender stem leaves, and (b) *montana*, in which the lower stem-leaves are broader and somewhat elliptical in shape. The plant is found on heaths and pastures throughout Great Britain and flowers in late summer and in autumn; it is widely spread in the north temperate zone. The harebell

has ever been a great favourite with poets, and on account of its delicate blue colour has been considered as an emblem of purity.

HAREM, less frequently **HARAM** or **HARIM** (Arab *harim*—commonly but wrongly pronounced *hârem*—“that which is illegal or prohibited”), the name generally applied to that part of a house in Oriental countries which is set apart for the women; it is also used collectively for the women themselves. Strictly the women's quarters are the *haremlik* (*lik*, belonging to), as opposed to *selamlık* the men's quarters, from which they are in large houses separated by the *mabeyn*, the private apartments of the householder. The word *harem* is strictly applicable to Mahomedan households only, but the system is common in greater or less degree to all Oriental communities, especially where polygamy is permitted. Other names for the women's quarters are *Seraglio* (Ital. *seraglio*, literally an enclosure, from Lat. *sera*, a bar; wrongly narrowed down to the sense of harem through confusion with Turkish *serâi* or *sarâi*, palace or large building, cf. *caravan-serâi*); *Zenana* (strictly *zanana*, from Persian *zan*, woman, allied with Gr. *γυνή*), used specifically of Hindu harems; *Andarûn* (or *Anderoon*), the Persian word for the “inner part” (*sc.* of a house). The Indian harem system is also commonly known as *pardah* or *pardah*, literally the name of the thick curtains or blinds which are used instead of doors to separate the women's quarters from the rest of the house. A male doctor attending a *zenana* lady would put his hand between the *pardah* to feel her pulse.

The seclusion of women in the household is fundamental to the Oriental conception of the sex relation, and its origin must, therefore, be sought far earlier than the precepts of Islam as set forth in the Koran, which merely regulate a practically universal Eastern custom.¹ It is inferred from the remains of many ancient Oriental palaces (Babylonian, Persian, &c.) that kings and wealthy nobles devoted a special part of the palace to their womankind. Though in comparatively early times there were not wanting men who regarded polygamy as wrong (e.g. the prophets of Israel), nevertheless in the East generally there has never been any real movement against the conception of woman as a chattel of her male relatives. A man may have as many wives and concubines as he can support, but each of these women must be

his exclusive property. The object of this insistence upon female chastity is partly the maintenance of the purity of the family with special reference to property, and partly to protect women from marauders, as was the case with the people of India when the Mahomedans invaded the country and sought for women to fill their harems. In Mahomedan countries theoretically a woman must veil her face to all men except her father, her brother and her husband; any violation of this rule is still regarded by strict Mahomedans as the gravest possible offence, though among certain Moslem communities (e.g. in parts of Albania) women of the poorer classes may appear in public unveiled. If any other man make his way into a harem he may lose his life; the attempted escape of a harem woman is a capital offence, the husband having absolute power of life and death, to such an extent that, especially in the less civilized parts of the Moslem world, no one would think of questioning a man's right to mutilate or kill a disobedient wife or concubine.

Turkish Harems.—A good deal of misapprehension, due to ignorance combined with strong prejudice against the whole system, exists in regard to the system in Turkey. It is often assumed, for example, that the sultan's seraglio is typical, though on a uniquely large scale, of all Turkish households, and as a consequence that every Turk is a polygamist. This is far from being the case, for though the Koran permits four wives, and etiquette allows the sultan seven, the man of average possessions is perforce content with one, and a small number of female servants. It is, therefore, necessary to take the imperial seraglio separately.

Though the sultan's household in modern times is by no means as numerous as it used to be, it is said that the harem of Abdul Hamid contained about 1000 women, all of whom were of slave origin. This body of women form an elaborately organized community with a complete system of officers, disciplinary and administrative, and strict distinctions of status. The real ruler of this society is the sultan's mother, the *Sultana Valide*, who exercises her authority through a female superintendent, the *Kyayya Khatun*. She has also a large retinue of subordinate officials (*Kalfas*) ranging downwards from the *Hasnadar onsa* (“Lady of the Treasury”) to the “Mistress of the Sherbets” and the “Chief Coffee Server.” Each of these officials has under her a number of pupil-slaves (*alâiks*), whom she trains to succeed her if need be, and from whom the service is recruited. After the sultana valide (who frequently enjoys considerable political power and is a mistress of intrigue) ranks the mother of the heir-apparent; she is called the *Bash Kodin Effendi* (“Her excellency the Chief Lady”), and also *hasseki* or *kaseky*, and is distinguished from the other three chief wives who only bear the title *Kodin Effendi*. Next come the ladies who have borne the younger children of the sultan, the *Hanum Effendis*, and after them the so-called *Odalisks* or *Odalisks* (a perversion of *odalik*, from *odak*, chamber). These are subdivided, according to the degree of favour in which they stand with the sultan or padishah, into *Ikbals* (“Favourites”) and *Genuds* (literally the “Eyed” ones), those whom the sultan has favourably noticed in the course of his visits to the apartments of his wives or his mother. All the women are at the disposal of the sultan, though it is contrary to etiquette for him actually to select recruits for his harem. The numbers are kept up by his female relatives and state officials, the latter of whom present girls annually on the evening before the 15th of Ramadan.

Every *odalisk* who has been promoted to the royal couch receives a *datra*, consisting of an allowance of money, a suite of apartments, and a retinue, in proportion to her status. It should be noted that, since all the harem women are slaves, the sultans, with practically no exceptions, have never entered into legal marriage contracts. Any slave, in however menial a position, may be promoted to the position of a *kodin effendi*. Hence all the slaves who have any pretension to beauty are carefully trained, from the time they enter the harem, in deportment, dancing, music and the arts of the toilette: they are instructed in the Moslem religion and learn the daily prayers (*sawâc*). A certain number are specially trained in reading and writing

¹ In Africa also, among the non-Mahomedan negroes of the west coast and the Bahima of the Victoria Nyanza, the seclusion of women of the upper classes has been practised in states (e.g. Ashanti and Buganda) possessing a considerable degree of civilization.

for secretarial work. Discipline is strict, and continued disobedience leads to corporal punishment by the eunuchs. All the women of the harem are absolutely under the control of the sultana validé (who alone of the harem of her dead husband is not sent away to an older palace when her son succeeds), and owe her the most profound respect, even to the point of having to obtain permission to leave their own apartments. Her financial secretary, the *Hasnadar Ousta*, succeeds to her power if she dies. The sultan's foster-mother also is a person of importance, and is known as the *Tais Kadîn*.

The security of the harem is in the hands of a body of eunuchs both black and white. The white eunuchs have charge of the outer gates of the seraglio, but they are not allowed to approach the women's apartments, and obtain no posts of distinction, their chief, however, the *kapu aghasi* ("master of the gates") has part control over the ecclesiastical possessions, and even the vizier cannot enter the royal apartments without his permission. The black eunuchs have the right of entering the gardens and chambers of the harem. Their chief, usually called the *kizlar aghasi* ("master of the maidens"), though his true title is *darus skadet aga* ("chief of the abode of felicity"), is an official of high importance. His appointment is for life. If he is deprived of his post he receives his freedom; and if he resigns of his own accord he is generally sent to Egypt with a pension of 100 francs a day. His secretary keeps count of the revenues of the mosques built by the sultans. He is usually succeeded by the second eunuch, who bears the title of treasurer, and has charge of the jewels, &c., of the women. The number of eunuchs is always a large one. The sultana validé and the sultana hasseki have each fifty at their service, and others are assigned to the kadins and the favourite odalisks.

The ordinary middle-class household is naturally on a very different scale. The *selamlık* is on the ground floor with a separate entrance, and there the master of the house receives his male guests; the rest of the ground floor is occupied by the kitchen and perhaps the stables. The *haremlık* is generally (in towns at least) on the upper floor fronting on and slightly overhanging the street; it has a separate entrance, courtyard and garden. The windows are guarded by lattices pierced with circular holes through which the women may watch without being seen. Communication with the *haremlık* is effected by a locked door, of which the Effendi keeps the key and also by a sort of revolving cupboard (*dulap*) for the conveyance of meals. The furniture, of the old-fashioned harems at least, is confined to divans, rugs, carpets and mirrors. For heating purposes the old brass tray of charcoal and wood ash is giving way to American stoves, and there is a tendency to import French furniture and decoration without regard to their suitability.

The presence of a second wife is the exception, and is generally attributable to the absence of children by the first wife. The expense of marrying a free woman leads many Turks to prefer a slave woman who is much more likely to be an amenable partner. If a slave woman bears a child she is often set free and then the marriage ceremony is gone through.

The harem system is, of course, wholly inconsistent with any high ideal of womanhood. Certain misapprehensions, however, should be noticed. The depravity of the system and the vapid idleness of harem life are much exaggerated by observers whose sympathies are wholly against the system. In point of fact much depends on the individuals. In many households there exists a very high degree of mutual consideration and the standard of conduct is by no means degraded. Though a woman may not be seen in the streets without the *yashmak* which covers her face except for her eyes, and does not leave her house except by her husband's permission, none the less in ordinary households the harem ladies frequently drive into the country and visit the shops and public baths. Their seclusion has very considerable compensations, and legally they stand on a far better basis in relation to their husbands than do the women of monogamous Christian communities. From the moment when a woman, free or slave, enters into any kind of wifely relation with a man, she has a legally enforceable right against him both for her own

and for her children's maintenance. She has absolute control over her personal property whether in money, slaves or goods; and, if divorce is far easier in Islam than in Christendom, still the marriage settlement must be of such amount as will provide suitable maintenance in that event.

On the other hand, of course, the system is open to the gravest abuse, and in countries like Persia, Morocco and India, the life of Moslem women and slaves is often far different from that of middle class women of European Turkey, where law is strict and culture advanced. The early age at which girls are secluded, the dulness of their surroundings, and the low moral standard which the system produces react unfavourably not only upon their moral and intellectual growth but also upon their capacity for motherhood and their general physique. A harem woman is soon *passée*, and the lot of a woman past her youth, if she is divorced or a widow, is monotonous and empty. This is true especially of child-widows.

Since the middle of the 19th century familiarity with European customs and the direct influence of European administrators has brought about a certain change in the attitude of Orientals to the harem system. This movement is, however, only in its infancy, and the impression is still strong that the time is not ripe for reform. The Oriental women are in general so accustomed to their condition that few have any inclination to change it, while men as a rule are emphatically opposed to any alteration of the system. The Young Turkish party, the upper classes in Egypt, as also the Babists in Persia, have to some extent progressed beyond the orthodox conception of the status of women, but no radical reform has been set on foot.

In India various attempts have been made by societies, missionary and other, as well as by private individuals, to improve the lot of the zenana women. Zenana schools and hospitals have been founded, and a few women have been trained as doctors and lawyers for the special purposes of protecting the women against their own ignorance and inertia. Thus in 1905 a Parsee Christian lady, Cornelia Sorabjee, was appointed by the Bengal government as legal adviser to the court of wards, so that she might give advice to the widowed mothers of minors within the harem walls. Similarly trained medical women are introduced into zenanas and harems by the Lady Dufferin Association for medical aid to Indian women. Gradually native Christian churches are making provision for the attendance of women at their services, though the sexes are rigorously kept apart. In India, as in Turkey, the introduction of Western dress and education has begun to create new ideas and ambitions, and not a few Eastern women have induced English women to enter the harems as companions, nurses and governesses. But training and environment are extremely powerful, and in some parts of the Mahomedan world, the supply of Asiatic, European and even American girls is so steady, that reform has touched only the fringe of the system.

Among the principal societies which have been formed to better the condition of Indian and Chinese women in general with special reference to the zenana system are the Church of England Zenana Missionary Society and the Zenana Bible and Medical Mission. Much information as to the medical, industrial and educational work done by these societies will be found in their annual reports and other publications. Among these are J. K. H. Denny's *Toward the Uprising*; Irene H. Barnes, *Behind the Pardah* (1897), an account of the former society's work; the general condition of Indian women is described in Mrs Marcus B. Fuller's *Wrongs of Indian Womanhood* (1900), and Maud Dover's *The Englishwoman in India* (1909); see also article MISSIONS.

AUTHORITIES.—The literature of the subject is very large, though a great deal of it is naturally based on insufficient evidence, and coloured by Western prepossessions. Among useful works are A. van Sommer and Zwerner, *Our Moslem Sisters* (1907), a collection of essays by authors acquainted with various parts of the Mahomedan world and strongly opposed to the whole harem system; Mrs W. M. Ramsay, *Everyday Life in Turkey* (1897), cc. iv. and v., containing an account of a day in a harem near Ahum-Kara-Hissar; cf. e.g. art. "Harem" in Hughes, *Dictionary of Islam*; Mrs S. Harvey's *Turkish Harems and Circassian Homes* (1871); for

Mahomet's regulations, see R. Bosworth Smith's *Mohammed and Mohammedanism* (1889); for Egypt, Lane, *Manners and Customs of the Modern Egyptians* (1837); and E. Lott, *Harem Life in Egypt and Constantinople* (1869); for the sultan's household in the 18th century, Lady Wortley Montagu's *Letters*, with which may be compared S. Lane-Poole, *Turkey* (ed. 1909); G. Dorys, *La Femme turque* (1902); especially Lucy M. J. Garnett (with J. S. Stuart-Glennie), *The Women of Turkey* (London, 1901), and *The Turkish People* (London, 1909). For the attempts which have been made to modify and improve the Indian zenana system, see, e.g. the reports of the Dufferin Association and other official publications. Other information will be found in Hoffman's article in Ersch and Gruber's *Encyclopædie*; Flandin in *Revue des deux mondes* (1852) on the harem of the Persian prince Malik Kasim Mirza; the count de Beauvoir, in *Voyage round the World* (1870), on Javanese and Siamese harems; Hantzschke in *Zeitschrift für allgemeine Erdkunde* (Berlin, 1864).

HARFLEUR, a port of France in the department of Seine-Inférieure, about 6 m. E. of Havre by rail. Pop. (1906) 2864. It lies in the fertile valley of the Lézarde, at the foot of wooded hills not far from the north bank of the estuary of the Seine. The port, which had been rendered almost inaccessible owing to the deposits of the Lézarde, again became available on the opening of the Tancarville canal (1887) connecting it with the port of Havre and with the Seine. Vessels drawing 18 ft. can moor alongside the quays of the new port, which is on a branch of the canal, has some trade in coal and timber, and carries on fishing. The church of St Martin is the most remarkable building in the town, and its lofty stone steeple forms a landmark for the pilots of the river. It dates from the 15th and 16th centuries, but the great portal is the work of the 17th, and the whole has undergone modern restoration. Of the old castle there are only insignificant ruins, near which, in a fine park, stands the present castle, a building of the 17th century. The old ramparts of the town are now replaced by manufactories, and the fosses are transformed into vegetable gardens. There is a statue of Jean de Grouchy, lord of Montérollier, under whose leadership the English were expelled from the town in 1435. The industries include distilling, metal founding and the manufacture of oil and grease.

Harfleur is identified with *Caracotinum*, the principal port of the ancient Calates. In the middle ages, when its name, Herosfoth, Harofoet or Harofot, was still sufficiently uncorrupted to indicate its Norman derivation, it was the principal seaport of north-western France. In 1415 it was captured by Henry V. of England, but when in 1435 the people of the district of Caux rose against the English, 104 of the inhabitants opened the gates of the town to the insurgents, and thus got rid of the foreign yoke. The memory of the deed was long perpetuated by the bells of St Martin's tolling 104 strokes. Between 1445 and 1449 the English were again in possession; but the town was recovered for the French by Dunois. In the 16th century the port began to dwindle in importance owing to the silting up of the Seine estuary and the rise of Havre. In 1562 the Huguenots put Harfleur to pillage, and its registers and charters perished in the confusion; but its privileges were restored by Charles IX. in 1568, and it was not till 1710 that it was subjected to the "taille."

HARIANA, a tract of country in the Punjab, India, once the seat of a flourishing Hindu civilization. It consists of a level upland plain, interspersed with patches of sandy soil, and largely overgrown with brushwood. The Western Jumna canal irrigates the fields of a large number of its villages. Since the 14th century Hissar has been the local capital. During the troubled period which followed on the decline of the Mogul empire, Haryana formed the battlefield where the Mahrattas, Bhattis and Sikhs met to settle their territorial quarrels. The whole country was devastated by the famine of 1783. In 1797-1798 Haryana was overrun by the famous Irish adventurer George Thomas, who established his capital at Hansi; in 1801 he was dispossessed by Sindhia's French general Perron; in 1803 Haryana passed under British rule. On the conquest of the Punjab Haryana was broken up into the districts of Hissar, Rohtak and Sirsa, which last has in its turn been divided between Hissar and Ferozepore.

HARINGTON, SIR JOHN (1561-1612), English writer, was born at Kelston, near Bath, in 1561. His father, John Harington, acquired considerable estates by marrying Etheldreda, a natural daughter of Henry VIII., and after his wife's death he was attached to the service of the Princess Elizabeth. He married Isabella Markham, one of her ladies, and on Mary's accession he and his wife were imprisoned in the Tower with the princess. John, the son of the second marriage, was Elizabeth's godson. He studied at Eton and at Christ's College, Cambridge, where he took the degree of M.A., his tutor being John Still, afterwards bishop of Bath and Wells, formerly reputed to be the author of *Gammer Gurton's Needle*. He came up to London about 1583 and was entered at Lincoln's Inn, but his talents marked him out for success at court rather than for a legal career. Tradition relates that he translated the story of Giocondo from Ariosto and was reproved by the queen for acquainting her ladies with so indiscreet a selection. He was to retire to his seat at Kelston until he completed the translation of the entire work. *Orlando Furioso* in English heroic verse was published in 1591 and reprinted in 1607 and 1634. Harington was high sheriff of Somerset in 1592 and received Elizabeth at his house during her western progress of 1591. In 1596 he published in succession *The Metamorphosis of Ajax*, *An Anatomie of the Metamorphosid Ajax*, and *Ulysses upon Ajax*, the three forming collectively a very absurd and indecorous work of a Pantagruelistic kind. An allusion to Leicester in this book threw the writer into temporary disgrace, but in 1598 he received a commission to serve in Ireland under Essex. He was knighted on the field, to the annoyance of Elizabeth. Harington saved himself from being involved in Essex's disgrace by writing an account of the Irish campaign which increased Elizabeth's anger against the unfortunate earl. Among some papers found in the chapter library at York was a *Tract on the Succession to the Crown* (1602), written by Harington to secure the favour of the new king, to whom he sent the gift of a lantern constructed to symbolize the waning glory of the late queen and James's own splendour. This pamphlet, which contains many details of great interest about Elizabeth and gives an unprejudiced sketch of the religious question, was edited for the Roxburghe Club in 1880 by Sir Clements Markham. Harington's efforts to win favour at the new court were unsuccessful. In 1605 he even asked for the office of chancellor of Ireland and proposed himself as archbishop. The document in which he preferred this extraordinary request was published in 1879 with the title of *A Short View of the State of Ireland written in 1605*. Harington was before his time in advocating a policy of generosity and conciliation towards that country. He eventually succeeded in obtaining a position as one of the tutors of Prince Henry, for whom he annotated Francis Godwin's *De praesulibus Angliae*. Harington's grandson, John Chetwind, found in this somewhat scandalous production an argument for the Presbyterian side, and published it in 1653, under the title of *A Briefe View of the State of the Church, &c.*

Harington died at Kelston on the 20th of November 1612. His *Epigrams* were printed in a collection entitled *Alcilia* in 1613, and separately in 1615. The translation of the *Orlando Furioso* was carried out with skill and perseverance. It is not to be supposed that Harington failed to realize the ironic quality of his original, but he treated it as a serious allegory to suit the temper of Queen Elizabeth's court. He was neither a very exact scholar nor a very poetical translator, and he cannot be named in the same breath with Fairfax. The *Orlando Furioso* was sumptuously illustrated, and to it was prefixed an *Apologie of Poetrie*, justifying the subject matter of the poem, and, among other technical matters, the author's use of disyllabic and trisyllabic rhymes, also a life of Ariosto compiled by Harington from various Italian sources. Harington's Rabelaisian pamphlets show that he was almost equally endowed with wit and indelicacy, and his epigrams are sometimes smart and always easy. His works include *The Englishman's Doctor, Or the School of Salerno* (1608), and *Nugae antiquae*, miscellaneous papers collected in 1779.

A biographical account of Harington is prefixed to the Roxburghe Club edition of his tract on the succession mentioned above.

HARĪRĪ [Abū Maḥmūd al-Qāsim ibn 'Alī ibn Maḥmūd al-Ḥarīrī, i.e. "the manufacturer or seller of silk" (1054-1122), Arabian writer, was born at Baḡra. He owned a large estate with 18,000 date-palms at Maḡhān, a village near Baḡra. He is said to have occupied a government position, but devoted his life to the study of the niceties of the Arabic language. On this subject he wrote a grammatical poem the *Muḥabāt ul-'Irāb* (French trans. *Les Rhetoriques grammaticales* with notes by L. Pinto, Paris 1885-1889; extracts in S. de Sacy's *Anthologie arabe*, pp. 145-151, Paris, 1829); a work on the faults of the educated called *Durrat ul-Ghawāḡ* (ed. H. Thorbecke, Leipzig, 1871), and some smaller treatises such as the two letters on words containing the letters *sin* and *shin* (ed. in Arnold's *Chrestomathy*, pp. 302-3). But his fame rests chiefly on his fifty *maqāmas* (see ARABIA: *Literature*, section "Belles Lettres"). These were written in rhymed prose like those of Ḥamadhānī, and are full of allusions to Arabian history, poetry and tradition, and discussions of difficult points of Arabic grammar and rhetoric.

The *Maqāmas* have been edited with Arabic commentary by S. de Sacy (Paris, 1822, 2nd ed. with French notes by Reinaud and J. Derenbourg, Paris, 1853); with English notes by F. Steingass (London, 1896). An English translation with notes was made by T. Preston (London, 1850), and another by T. Chenery and F. Steingass (London, 1867 and 1898). Many editions have been published in the East with commentaries, especially with that of Sharīshī (d. 1222). (G. W. T.)

HARI-RUD, a river of Afghanistan. It rises in the northern slopes of the Koh-i-Baba to the west of Kabul, and finally loses itself in the Tejed oasis north of the Trans-Caspian railway and west of Merv. It runs a remarkably straight course westward through a narrow trough from Daolatyar to Obek, amidst the bleak wind-swept uplands of the highest central elevations in Afghanistan. From Obek to Kuhsan 50 m. west of Herat, it forms a valley of great fertility, densely populated and highly cultivated; practically all its waters being drawn off for purposes of irrigation. It is the contrast between the cultivated aspect of the valley of Herat and the surrounding desert that has given Herat its great reputation for fertility. Three miles to the south of Herat the Kandahar road crosses the river by a masonry bridge of 26 arches now in ruins. A few miles below Herat the river begins to turn north-west, and after passing through a rich country to Kuhsan, it turns due north and breaks through the Paropamisan hills. Below Kuhsan it receives fresh tributaries from the west. Between Kuhsan and Zulfikar it forms the boundary between Afghanistan and Persia, and from Zulfikar to Sarakhs between Russia and Persia. North of Sarakhs it diminishes rapidly in volume till it is lost in the sands of the Turkman desert. The Hari-Rud marks the only important break existing in the continuity of the great central water-parting of Asia. It is the ancient Arius. (T. H. H.')

HARISCHANDRA, in Hindu mythology, the 28th king of the Solar race. He was renowned for his piety and justice. He is the central figure of legends in the *Aitareyabrahmana*, *Mahabharata* and the *Markandeyapurana*. In the first he is represented as so desirous of a son that he vows to Varuna that if his prayer is granted the boy shall be eventually sacrificed to the latter. The child is born, but Harischandra, after many delays, arranges to purchase another's son and make a vicarious sacrifice. According to the *Mahabharata* he is at last promoted to Paradise as the reward for his munificent charity.

HARĪTH IBN HILLIZA UL-YASHKURĪ, pre-Islamic Arabian poet of the tribe of Bakr, famous as the author of one of the poems generally received among the *Mu'allakāt* (q.v.). Nothing is known of the details of his life.

HARIZI, JUDAH BEN SOLOMON (13th cent.), called also **AL-HARIZI**, a Spanish Hebrew poet and traveller. He translated from the Arabic to Hebrew some of the works of Maimonides (q.v.) and also of the Arab poet Hariri. His own most considerable work was the *Tahkemoni*, composed between 1218 and 1220. This is written in Hebrew in unmetrical rhymes, in what is commonly termed "rhymed prose." It is a series of humorous episodes, witty verses, and quaint applications of Scriptural texts. The episodes are bound together by the presence of the

hero and of the narrator, who is also the author. Harizi not only brought to perfection the art of applying Hebrew to secular satire, but he was also a brilliant literary critic and his *mahame* on the Andalusian Hebrew poets is a fruitful source of information.

See, on the *Tahkemoni*, Kaempfer, *Nicht-andalusische Poesie andalusischer Dichter* (Prague, 1858). In that work a considerable section of the *Tahkemoni* is translated into German. (I. A.)

HARKNESS, ALBERT (1822-1907), American classical scholar, was born at Mendon, Massachusetts, on the 6th of October 1822. He graduated at Brown University in 1842, taught in the Providence high school in 1843-1853, studied in Berlin, Bonn (where in 1854 he was the first American to receive the degree of Ph.D.) and Göttingen, and was professor of Greek language and literature in Brown University from 1855 to 1892, when he became professor emeritus. He was one of the founders in 1869 of the American Philological Association, of which he was president in 1875-1876, and to whose *Transactions* he made various contributions; was a member of the Archaeological Institute's committee on founding the American School of Classical Studies at Athens, and served as the second director of that school in 1883-1884. He studied English and German university methods during trips to Europe in 1870 and 1883, and introduced a new scholarly spirit into American teaching of Latin in secondary schools with a series of Latin text-books, which began in 1851 with a *First Latin Book* and continued for more than fifty years. His *Latin Grammar* (1864, 1881) and *Complete Latin Grammar* (1898) are his best-known books. He was a member of the board of fellows of Brown University from 1904 until his death, and in 1904-1905 was president of the Rhode Island Historical Society. He died in Providence, Rhode Island, on the 27th of May 1907.

His son, ALBERT GRANGER HARKNESS (1857-), also a classical scholar, was born in Providence, Rhode Island, on the 19th of November 1857. He graduated at Brown University in 1879, studied in Germany in 1879-1883, and was professor of German and Latin at Madison (now Colgate) University from 1883 to 1889, and associate professor of Latin at Brown from 1889 to 1893, when he was appointed to the chair of Roman literature and history there. He was director of the American School of Classical Studies in Rome in 1902-1903.

HARKNESS, ROBERT (1816-1878), English geologist, was born at Ormskirk, Lancashire, on the 28th of July 1816. He was educated at the high school, Dumfries, and afterwards (1833-1834) at the university of Edinburgh where he acquired an interest in geology from the teachings of Robert Jameson and J. D. Forbes. Returning to Ormskirk he worked zealously at the local geology, especially on the Coal-measures and New Red Sandstone, his first paper (read before the Manchester Geol. Soc. in 1843) being on *The Climate of the Coal Epoch*. In 1848 his family went to reside in Dumfries and there he commenced to work on the Silurian rocks of the S.W. of Scotland, and in 1849 he carried his investigations into Cumberland. In these regions during the next few years he added much to our knowledge of the strata and their fossils, especially graptolites, in papers read before the Geological Society of London. He wrote also on the New Red rocks of the north of England and Scotland. In 1853 he was appointed professor of geology in Queen's College, Cork, and in 1856 he was elected F.R.S. During this period he wrote some articles on the geology of parts of Ireland, and exercised much influence as a teacher, but he returned to England during his vacations and devoted himself assiduously to the geology of the Lake district. He was also a constant attendant at the meetings of the British Association. In 1876 the syllabus for the Queen's Colleges in Ireland was altered, and Professor Harkness was required to lecture not only on geology, palaeontology, mineralogy and physical geography, but also on zoology and botany. The strain of the extra work proved too much, he decided to relinquish his post, and had retired but a short time when he died, on the 4th of October 1878.

"Memoir," by J. G. Goodchild, in *Trans. Cumberland Assoc. No.*

viii. (with portrait). In memory of Professor Harkness his sister established two Harkness scholarships. One scholarship (of the value of about £35 a year, tenable for three years) for women, tenable at either Girton or Newham College, Cambridge, is awarded triennially to the best candidate in an examination in geology and palaeontology, provided that proficiency be shown; the other, for men, is vested in the hands of the university of Cambridge, and is awarded annually, any member of the university being eligible who has graduated as a B.A., "provided that not more than three years have elapsed since the 19th day of December next following his final examination for the degree of bachelor of arts."

HARLAN, JAMES (1820-1899), American politician, was born in Clark county, Illinois, on the 26th of August 1820. He graduated from Indiana Asbury (now De Pauw) University in 1845, was president (1846-1847) of the newly founded and short-lived Iowa City College, studied law, was first superintendent of public instruction in Iowa in 1847-1848, and was president of Iowa Wesleyan University in 1853-1855. He took a prominent part in organizing the Republican party in Iowa, and was a member of the United States Senate from 1855 to 1865, when he became secretary of the interior. He had been a delegate to the peace convention in 1861, and from 1861 to 1865 was chairman of the Senate committee on public lands. He disapproved of President Johnson's conservative reconstruction policy, retired from the cabinet in August 1866, and from 1867 to 1873 was again a member of the United States Senate. In 1866 he was a delegate to the loyalists' convention at Philadelphia. One of his principal speeches in the Senate was that which he made in March 1871 in reply to Sumner's and Schurz's attack on President Grant's Santo Domingan policy. He was presiding judge of the court of commissioners of Alabama claims (1882-1885). He died in Mount Pleasant, Iowa, on the 5th of October 1899.

HARLAN, JOHN MARSHALL (1833-), American jurist, was born in Boyle county, Kentucky, on the 1st of June 1833. He graduated at Centre College, Danville, Ky., in 1850, and at the law department of Transylvania University, Lexington, in 1853. He was county judge of Franklin county in 1858-1859, was an unsuccessful candidate for Congress on the Whig ticket in 1859, and was elector on the Constitutional Union ticket in 1860. On the outbreak of the Civil War he recruited and organized the Tenth Kentucky United States Volunteer Infantry, and in 1861-1863 served as colonel. Retiring from the army in 1863, he was elected by the Union party attorney-general of the state, and was re-elected in 1865, serving from 1863 to 1867, when he removed to Louisville to practise law. He was the Republican candidate for governor in 1871 and in 1875, and was a member of the commission which was appointed by President Hayes early in 1877 to accomplish the recognition of one or other of the existing state governments of Louisiana (*q.v.*); and he was a member of the Bering Sea tribunal which met in Paris in 1893. On the 29th of November 1877 he became an associate justice of the United States Supreme Court. In this position he showed himself a liberal constructionist. In opinions on the Civil Rights cases and in the interpretation of the 13th, 14th and 15th Amendments to the Constitution, he dissented from the majority of the court and advocated increasing the power of the Federal government. He supported the constitutionality of the income tax clause in the Wilson Tariff Bill of 1894, and he drafted the decision of the court in the Northern Securities Company Case, which applied to railways the provisions of the Sherman Anti-Trust Law. In 1889 he became a professor in the Law School of the Columbian University (afterwards George Washington University) in Washington, D.C.

HARLAND, HENRY (1861-1905), American novelist, was born in St Petersburg, Russia, in March 1861, and was educated in New York and at Harvard. He went to Europe as a journalist, and, after publishing several novels, mainly of American-Jewish life (under the name of Sidney Luska), first made his literary reputation in London as editor of the *Yellow Book* in 1894. His association with this clever publication, and his own contributions to it, brought his name into prominence, but it was not till he published *The Cardinal's Snuff-box* (1900), followed

by *The Lady Paramount* (1902), that his lightly humorous touch and picturesque style as a novelist brought him any real success. His health was always delicate, and he died at San Remo on the 20th of December 1905.

HARLAY DE CHAMPVALLON, FRANÇOIS DE (1625-1695), 5th archbishop of Paris, was born in that city on the 14th of August 1625. Nephew of François de Harlay, archbishop of Rouen, he was presented to the abbey of Jumièges immediately on leaving the Collège de Navarre, and he was only twenty-six when he succeeded his uncle in the archiepiscopal see. He was transferred to the see of Paris in 1671, he was nominated by the king for the cardinalate in 1690, and the domain of St Cloud was erected into a duchy in his favour. He was commander of the order of the Saint Esprit and a member of the French Academy. During the early part of his political career he was a firm adherent of Mazarin, and is said to have helped to procure his return from exile. His private life gave rise to much scandal, but he had a great capacity for business, considerable learning, and was an eloquent and persuasive speaker. He definitely secured the favour of Louis XIV. by his support of the claims of the Gallican Church formulated by the declaration made by the clergy in assembly on the 19th of March 1682, when Bossuet accused him of truckling to the court like a valet. One of the three witnesses of the king's marriage with Madame de Maintenon, he was hated by her for using his influence with the king to keep the matter secret. He had a weekly audience of Louis XIV. in company with Père la Chaise on the affairs of the Church in Paris, but his influence gradually declined, and Saint-Simon, who bore him no good will for his harsh attitude to the Jansenists, says that his friends deserted him as the royal favour waned, until at last most of his time was spent at Conflans in company with the duchess of Lesdiguières, who alone was faithful to him. He urged the revocation of the edict of Nantes, and showed great severity to the Huguenots at Dieppe, of which he was temporal and spiritual lord. He died suddenly, without having received the sacraments, on the 6th of August 1695. His funeral discourse was delivered by the Père Gaillard, and Mme de Sévigné made on the occasion the severe comment that there were only two trifles to make this a difficult matter—his life and his death.

See Abbé Legendre, *Vita Francisci de Harlay* (Paris, 1720) and *Éloge de Harlay* (1695); Saint-Simon, *Mémoires* (vol. ii., ed. A. de Boislisle, 1879), and numerous references in the *Lettres* of Mme de Sévigné.

HARLECH (perhaps for *Harold lech*, fair slate, or *Harleigh*, an Anglicized variant), a town of Merionethshire, Wales, 38 m. from Aberystwyth, and 9 m. from Carnarvon on the Cambrian railway. Pop. 900. Ruins of a fortress crown the rock of Harlech, about half a mile from the sea. Discovery of Roman coins makes it probable that it was once occupied by the Romans. In the 3rd century Bronwen (white bosom), daughter of Bran Fendigaid (the blessed), is said to have stayed here, perhaps by force; and there was here a tower, called Twr Bronwen, and replaced about A.D. 550 by the building of Maelgwyn Gwynedd, prince of North Wales. In the early 10th century, Harlech castle was, apparently, repaired by Colwyn, lord of Ardudwy, founder of one of the fifteen North Wales tribes, and thence called Caer Colwyn. The present structure dates, like many others in the principality, from Edward I., perhaps even from the plans of the architect of Carnarvon and Conway castles, but with the retention of old portions. It is thought to have been square, each side measuring some 220 ft., with towers and turrets. Glendower held it for four years. Here, in 1460, Margaret, wife of Henry VI., defeated at Northampton, took refuge. Dafydd ap Ieuan ap Einion held it for the Lancastrians, until famine, rather than Edward IV., made him surrender. From this time is said to date the air "March of the men of Harlech" (*Rhyfelgwrdd gwyrr Harlech*). The castle was alternately Roundhead and Cavalier in the civil war. Edward I. made Harlech a free borough, and it was formerly the county town. It is in the parish of Llandanwg (pop. in 1901, 931). Though interesting from an antiquarian point of view, the district around, especially Dyffryn Ardudwy (the valley), is dreary and desolate,

e.g. Drws (the door of) Ardudwy, Rhinog fawr and Rhinog fach (cliffs); an exception is the verdant Cwm bychan (little combe or hollow). The Meini gwyr Ardudwy (stones of the men of Ardudwy) possibly mark the site of a fight.

HARLEQUIN, in modern pantomime, the posturing and acrobatic character who gives his name to the "harlequinade," attired in mask and parti-coloured and spangled tights, and provided with a sword like a bat, by which, himself invisible, he works wonders. It has generally been assumed that Harlequin was transferred to France from the "Arlecchino" of Italian medieval and Renaissance popular comedy; but Dr Driesen in his *Ursprung des Harlekins* (Berlin, 1904) shows that this is incorrect. An old French "Harlekin" (Herlekin, Hellequin and other variants) is found in folk-literature as early as 1100; he had already become proverbial as a ragamuffin of a demoniacal appearance and character; in 1262 a number of harlekins appear in a play by Adam de la Halle as the intermediaries of King Hellekin, prince of Fairyland, in courting Morgan le Fay; and it was not till much later that the French Harlekin was transformed into the Italian Arlecchino. In his typical French form down to the time of Gottsched, he was a spirit of the air, deriving thence his invisibility and his characteristically light and airy whirlings. Subsequently he returned from the Italian to the French stage, being imported by Marivaux into light comedy; and his various attributes gradually became amalgamated into the latter form taken in pantomime.

HARLESS (originally **HARLES**), **GOTTLIEB CHRISTOPH** (1738-1815), German classical scholar and bibliographer, was born at Culmbach in Bavaria on the 21st of June 1738. He studied at Halle, Erlangen and Jena. In 1765 he was appointed professor of oriental languages and eloquence at the Gymnasium Casimirianum in Coburg, in 1770 professor of poetry and eloquence at Erlangen, and in 1776 librarian of the university. He held his professorship for forty-five years till his death on the 2nd of November 1815. Harless was an extremely prolific writer. His numerous editions of classical authors, deficient in originality and critical judgment, although valuable at the time as giving the student the results of the labours of earlier scholars, are now entirely superseded. But he will always be remembered for his meritorious work in connexion with the great *Bibliotheca Graeca* of J. A. Fabricius, of which he published a new and revised edition (12 vols., 1790-1809, not quite completed),—a task for which he was peculiarly qualified. He also wrote much on the history and bibliography of Greek and Latin literature.

His life was written by his son, Johann Christian Friedrich Harless (1818).

HARLESS, GOTTLIEB CHRISTOPH ADOLF VON (1806-1879), German divine, was born at Nuremberg on the 21st of November 1806, and was educated at the universities of Erlangen and Halle. He was appointed professor of theology at Erlangen in 1836 and at Leipzig in 1845. He was a strong Lutheran and exercised a powerful influence in that direction as court preacher in Dresden and as president of the Protestant consistory at Munich. His chief works were *Theologische Encyclopädie und Methodologie* (1837) and *Die christliche Ethik* (1842, Eng. trans. 1868). He died on the 5th of September 1879, having, a few years earlier, written an autobiography under the title *Bruchstücke aus dem Leben eines süddeutschen Theologen*.

HARLINGEN, a seaport in the province of Friesland, Holland, on the Zuider Zee, and the terminus of the railway and canal from Leeuwarden (15½ m. E.). It is connected by steam tramway by way of Bolsward with Sneek. Pop. (1900) 10,448. Harlingen has become the most considerable seaport of Friesland since the construction of the large outer harbour in 1870-1877, and in addition to railway and steamship connexion with Bremen, Amsterdam, and the southern provinces there are regular sailings to Hull and London. Powerful sluices protect the inner harbour from the high tides. The only noteworthy buildings are the town hall (1730-1733), the West church, which consists of a part of the former castle of Harlingen, the Roman Catholic church, the Jewish synagogue and the schools of navigation and of design. The chief trade of Harlingen is the

exportation of Frisian produce, namely, butter and cheese, cattle, sheep, fish, potatoes, flax, &c. There is also a considerable import trade in timber, coal, raw cotton, hemp and jute for the Twente factories. The local industries are unimportant, consisting of saw-mills, rope-yards, salt refineries, and sail-cloth and margarine factories.

HARMATTAN, the name of a hot dry parching wind that blows during December, January and February on the coast of Upper Guinea, bringing a high dense haze of red dust which darkens the air. The natives smear their bodies with oil or fat while this parching wind is blowing.

HARMODIUS, a handsome Athenian youth, and the intimate friend of Aristogeiton. Hipparchus, the younger brother of the tyrant Hippias, endeavoured to supplant Aristogeiton in the good graces of Harmodius, but, failing in the attempt, revenged himself by putting a public affront on Harmodius's sister at a solemn festival. Thereupon the two friends conspired with a few others to murder both the tyrants during the armed procession at the Panathenaic festival (514 B.C.), when the people were allowed to carry arms (this licence is denied by Aristotle in *Ath. Pol.*). Seeing one of their accomplices speaking to Hippias, and imagining that they were being betrayed, they prematurely attacked and slew Hipparchus alone. Harmodius cut down on the spot by the guards, and Aristogeiton was soon captured and tortured to death. When Hippias was expelled (510), Harmodius and Aristogeiton became the most popular of Athenian heroes; their descendants were exempted from public burdens, and had the right of public entertainment in the Prytaneum, and their names were celebrated in popular songs and scolia (after-dinner songs) as the deliverers of Athens. One of these songs, attributed to a certain Callistratus, is preserved in Athenaeus (p. 695). Their statues by Antenor in the agora were carried off by Xerxes and replaced by new ones by Critius and Nesiotes. Alexander the Great afterwards sent back the originals to Athens. It is not agreed which of these was the original of the marble tyrannicide group in the museum at Naples, for which see article GREEK ART, Pl. I. fig. 50.

See Köpp in *Neues Jahrb. f. klass. Altert.* (1902), p. 609.

HARMONIA, in Greek mythology, according to one account the daughter of Ares and Aphrodite, and wife of Cadmus. When the government of Thebes was bestowed upon Cadmus by Athena, Zeus gave him Harmonia to wife. All the gods honoured the wedding with their presence. Cadmus (or one of the gods) presented the bride with a robe and necklace, the work of Hephaestus. This necklace brought misfortune to all who possessed it. With it Polyneices bribed Eriphyle to persuade her husband Amphiarus to undertake the expedition against Thebes. It led to the death of Eriphyle, of Alcmæon, of Phegeus and his sons. Even after it had been deposited in the temple of Athena Pronoia at Delphi, its baleful influence continued. Phayllus, one of the Phocian leaders in the Sacred War (352 B.C.) carried it off and gave it to his mistress. After she had worn it for a time, her son was seized with madness and set fire to the house, and she perished in the flames. According to another account, Harmonia belonged to Samothrace and was the daughter of Zeus and Electra, her brother Iasion being the founder of the mystic rites celebrated on the island (Diod. Sic. v. 48). Finally, Harmonia is rationalized as closely allied to Aphrodite Pandemos, the love that unites all people, the personification of order and civic unity, corresponding to the Roman Concordia.

Apollodorus iii. 4-7; Diod. Sic. iv. 65, 66; Pausanias, *Erotica*, 25; L. Preller, *Griech. Mythol.*; Crusius in Roemer's *Lexikon*.

HARMONIC. In acoustics, a harmonic is a secondary tone which accompanies the fundamental or primary tone of a vibrating string, reed, &c.; the more important are the 3rd, 5th, 7th, and octave (see SOUND; HARMONY). A harmonic proportion in arithmetic and algebra is such that the reciprocals of the proportionals are in arithmetical proportion; thus, if a, b, c be in harmonic proportion then $1/a, 1/b, 1/c$ are in arithmetical proportion; this leads to the relation $2/b = a/(a+c)$. A harmonic progression or series consists of terms whose reciprocals form an arithmetical progression; the simplest example is:

$1 + \frac{1}{2} + \frac{1}{3} + \frac{1}{4} + \dots$ (see ALGEBRA and ARITHMETIC). The occurrence of a similar proportion between segments of lines is the foundation of such phrases as harmonic section, harmonic ratio, harmonic conjugates, &c. (see GEOMETRY: II. *Projective*). The connexion between acoustical and mathematical harmonicals is most probably to be found in the Pythagorean discovery that a vibrating string when stopped at $\frac{1}{2}$ and $\frac{2}{3}$ of its length yielded the octave and 5th of the original tone, the numbers, $1, \frac{2}{3}, \frac{1}{2}$ being said to be, probably first by Archytas, in harmonic proportion. The mathematical investigation of the form of a vibrating string led to such phrases as harmonic curve, harmonic motion, harmonic function, harmonic analysis, &c. (see MECHANICS and SPHERICAL HARMONICS).

HARMONICA, a generic term applied to musical instruments in which sound is produced by friction upon glass bells. The word is also used to designate instruments of percussion of the Glockenspiel type, made of steel and struck by hammers (Ger. *Stahlharmonika*).

The origin of the glass-harmonica tribe is to be found in the fashionable 18th century instrument known as musical glasses (Fr. *verrillon*), the principle of which was known already in the 17th century.¹ The invention of musical glasses is generally ascribed to an Irishman, Richard Pockrich, who first played the instrument in public in Dublin in 1743 and the next year in England, but Eisel² described the *verrillon* and gave an illustration of it in 1738. The *verrillon* or *Glasspiel* consisted of 18 beer glasses arranged on a board covered with cloth, water being poured in when necessary to alter the pitch. The glasses were struck on both sides gently with two long wooden sticks in the shape of a spoon, the bowl being covered with silk or cloth. Eisel states that the instrument was used for church and other solemn music. Gluck gave a concert at the "little theatre in the Haymarket" (London) in April 1746, at which he performed on musical glasses a concerto of his composition with full orchestral accompaniment. E. H. Delaval is also credited with the invention. When Benjamin Franklin visited London in 1757, he was so much struck by the beauty of tone elicited by Delaval and Pockrich, and with the possibilities of the glasses as musical instruments, that he set to work on a mechanical application of the principle involved, the eminently successful result being the glass harmonica finished in 1762. In this the glass bowls were mounted on a rotating spindle, the largest to the left, and their under-edges passed during each revolution through a water-trough. By applying the fingers to the moistened edges, sound was produced varying in intensity with the pressure, so that a certain amount of expression was at the command of a good player. It is said that the timbre was extremely enervating, and, together with the vibration caused by the friction on the finger-tips, exercised a highly deleterious effect on the nervous system. The instrument was for many years in great vogue, not only in England but on the Continent of Europe, and more especially in Saxony, where it was accorded a place in the court orchestra. Mozart, Beethoven, Naumann and Hasse composed music for it. Marianne Davies and Marianna Kirchgessner were celebrated virtuosi on it. The curious vogue of the instrument, as sudden as it was ephemeral, produced emulation in a generation unsurpassed for zeal in the invention of musical instruments. The most notable of its offspring were Carl Leopold Röllig's improved harmonica with a keyboard in 1786, Chladni's euphon in 1791 and clavicylinder in 1799, Ruffelsen's melodicon in 1800 and 1803, Franz Leppich's panmelodicon 1810, Buschmann's uranion in the same year, &c. Of most of these nothing now remains but the name and a description in the *Allgemeine musikalische Zeitung*, but there are numerous specimens of the Franklin type in the museums for musical instruments of Europe. One specimen by Emanuel Pohl, a Bohemian maker, is preserved in the Victoria and Albert Museum, London.

For the steel harmonica see GLOCKENSPIEL.

(K. S.)

¹ See G. P. Harsdörfer, *Math. und philos. Erquickstunden* (Nuremberg, 1677), ii. 147.

² *Musikus abrotbäurus* (Erfurt, 1738), p. 70.

HARMONIC ANALYSIS, in mathematics, the name given by Sir William Thomson (Lord Kelvin) and P. G. Tait in their treatise on *Natural Philosophy* to a general method of investigating physical questions, the earliest applications of which seem to have been suggested by the study of the vibrations of strings and the analysis of these vibrations into their fundamental tone and its harmonics or overtones.

The motion of a uniform stretched string fixed at both ends is a periodic motion; that is to say, after a certain interval of time, called the fundamental period of the motion, the form of the string and the velocity of every part of it are the same as before, provided that the energy of the motion has not been sensibly dissipated during the period.

There are two distinct methods of investigating the motion of a uniform stretched string. One of these may be called the wave method, and the other the harmonic method. The wave method is founded on the theorem that in a stretched string of infinite length a wave of any form may be propagated in either direction with a certain velocity, V , which we may define as the "velocity of propagation." If a wave of any form travelling in the positive direction meets another travelling in the opposite direction, the form of which is such that the lines joining corresponding points of the two waves are all bisected in a fixed point in the line of the string, then the point of the string corresponding to this point will remain fixed, while the two waves pass it in opposite directions. If we now suppose that the form of the waves travelling in the positive direction is periodic, that is to say, that after the wave has travelled forward a distance l , the position of every particle of the string is the same as it was at first, then l is called the wave-length, and the time of travelling a wave-length is called the periodic time, which we shall denote by T , so that $l = VT$.

If we now suppose a set of waves similar to these, but reversed in position, to be travelling in the opposite direction, there will be a series of points, distant $\frac{l}{2}$ from each other, at which there will be no motion of the string; it will therefore make no difference to the motion of the string if we suppose the string fastened to fixed supports at any two of these points, and we may then suppose the parts of the string beyond these points to be removed, as it cannot affect the motion of the part which is between them. We have thus arrived at the case of a uniform string stretched between two fixed supports, and we conclude that the motion of the string may be completely represented as the resultant of two sets of periodic waves travelling in opposite directions, their wave-lengths being either twice the distance between the fixed points or a submultiple of this wave-length, and the form of these waves, subject to this condition, being perfectly arbitrary.

To make the problem a definite one, we may suppose the initial displacement and velocity of every particle of the string given in terms of its distance from one end of the string, and from these data it is easy to calculate the form which is common to all the travelling waves. The form of the string at any subsequent time may then be deduced by calculating the positions of the two sets of waves at that time, and compounding their displacements.

Thus in the wave method the actual motion of the string is considered as the resultant of two wave motions, neither of which is of itself, and without the other, consistent with the condition that the ends of the string are fixed. Each of the wave motions is periodic with a wave-length equal to twice the distance between the fixed points, and the one set of waves is the reverse of the other in respect of displacement and velocity and direction of propagation; but, subject to these conditions, the form of the wave is perfectly arbitrary. The motion of a particle of the string, being determined by the two waves which pass over it in opposite directions, is of an equally arbitrary type.

In the harmonic method, on the other hand, the motion of the string is regarded as compounded of a series of vibratory motions (*normal modes of vibration*), which may be infinite in number, but each of which is perfectly definite in type, and is in fact a particular solution of the problem of the motion of a string with its ends fixed.

A simple harmonic motion is thus defined by Thomson and Tait (§ 53):—When a point Q moves uniformly in a circle, the perpendicular QP , drawn from its position at any instant to a fixed diameter AA' of the circle, intersects the diameter in a point P whose position changes by a *simple harmonic motion*.

The amplitude of a simple harmonic motion is the range on one side or the other of the middle point of the course.

The period of a simple harmonic motion is the time which elapses from any instant until the moving-point again moves in the same direction through the same position.

The phase of a simple harmonic motion at any instant is the fraction of the whole period which has elapsed since the moving-point last passed through its middle position in the positive direction.

In the case of the stretched string, it is only in certain particular cases that the motion of a particle of the string is a simple harmonic motion. In these particular cases the form of the string at any instant is that of a curve of sines having the line joining the fixed

points for its axis, and passing through these two points, and therefore having for its wave-length either twice the length of the string or some submultiple of this wave-length. The amplitude of the curve of sines is a simple harmonic function of the time, the period being either the fundamental period or some submultiple of the fundamental period. Every one of these modes of vibration is dynamically possible by itself, and any number of them may coexist independently of each other.

By a proper adjustment of the initial amplitude and phase of each of these modes of vibration, so that their resultant shall represent the initial state of the string, we obtain a new representation of the whole motion of the string, in which it is seen to be the resultant of a series of simple harmonic vibrations whose periods are the fundamental period and its submultiples. The determination of the amplitudes and phases of the several simple harmonic vibrations so as to satisfy the initial conditions is an example of harmonic analysis.

We have thus two methods of solving the partial differential equation of the motion of a string. The first, which we have called the wave method, exhibits the solution in the form containing an arbitrary function, the nature of which must be determined from the initial conditions. The second, or harmonic method, leads to a series of terms involving sines and cosines, the coefficients of which have to be determined. The harmonic method may be defined in a more general manner as a method by which the solution of any actual problem may be obtained as the sum or resultant of a number of terms, each of which is a solution of a particular case of the problem. The nature of these particular cases is defined by the condition that any one of them must be conjugate to any other.

The mathematical test of conjugacy is that the energy of the system arising from two of the harmonics existing together is equal to the sum of the energy arising from the two harmonics taken separately. In other words, no part of the energy depends on the product of the amplitudes of two different harmonics. When two modes of motion of the same system are conjugate to each other, the existence of one of them does not affect the other.

The simplest case of harmonic analysis, that of which the treatment of the vibrating string is an example, is completely investigated in what is known as Fourier's theorem. Fourier's theorem asserts that any periodic function of a single variable period p , which does not become infinite at any phase, can be expanded in the form of a series consisting of a constant term, together with a double series of terms, one set involving cosines and the other sines of multiples of the phase.

Thus if $\phi(\xi)$ is a periodic function of the variable ξ having a period p , then it may be expanded as follows:

$$\phi(\xi) = A_0 + \sum_1^{\infty} A_1 \cos \frac{2i\pi\xi}{p} + \sum_1^{\infty} B_1 \sin \frac{2i\pi\xi}{p} \quad (1)$$

The part of the theorem which is most frequently required, and which also is the easiest to investigate, is the determination of the values of the coefficients A_0, A_1, B_1 . These are

$$A_0 = \frac{1}{p} \int_0^p \phi(\xi) d\xi; \quad A_1 = \frac{2}{p} \int_0^p \phi(\xi) \cos \frac{2i\pi\xi}{p} d\xi; \quad B_1 = \frac{2}{p} \int_0^p \phi(\xi) \sin \frac{2i\pi\xi}{p} d\xi.$$

This part of the theorem may be verified at once by multiplying both sides of (1) by $d\xi$, by $\cos(2i\pi\xi/p)d\xi$ or by $\sin(2i\pi\xi/p)d\xi$, and in each case integrating from 0 to p .

Fourier's theorem asserts that any periodic function of a single variable period p , which does not become infinite at any phase, can be expanded in the form of a series consisting of a constant term, together with a double series of terms, one set involving cosines and the other sines of multiples of the phase. It cannot therefore represent a function of ξ which has more than one value, or which becomes imaginary for any value of ξ . It is convergent, approaching to the true value of $\phi(\xi)$ for all values of ξ such that if ξ varies infinitesimally the function also varies infinitesimally.

Lord Kelvin, availing himself of the disk, globe and cylinder integrating machine invented by his brother, Professor James Thomson, constructed a machine by which eight of the integrals required for the expression of Fourier's series can be obtained simultaneously from the recorded trace of any periodically variable quantity, such as the height of the tide, the temperature or pressure of the atmosphere, or the intensity of the different components of terrestrial magnetism. If it were not on account of the waste of time, instead of having a curve drawn by the action of the tide, and the curve afterwards acted on by the machine, the time axis of the machine itself might be driven by a clock, and the tide itself might work the second variable of the machine, but this would involve the constant presence of an expensive machine at every tidal station. (J. C. M.)

For a discussion of the restrictions under which the expansion of a periodic function of ξ in the form (1) is valid, see FOURIER'S SERIES. An account of the contrivances for mechanical calculation of the coefficients A_1, B_1, \dots is given under CALCULATING MACHINES.

A more general form of the problem of harmonic analysis presents itself in astronomy, in the theory of the tides, and in various magnetic and meteorological investigations. It may happen, for instance, that a variable quantity $f(t)$ is known theoretically to be of the form

$$f(t) = A_0 + A_1 \cos n_1 t + B_1 \sin n_1 t + A_2 \cos n_2 t + B_2 \sin n_2 t + \dots \quad (2)$$

where the periods $2\pi/n_1, 2\pi/n_2, \dots$ of the various simple-harmonic constituents are already known with sufficient accuracy, although they may have no very simple relations to one another. The problem of determining the most probable values of the constants $A_0, A_1, B_1, A_2, B_2, \dots$ by means of a series of recorded values of the function $f(t)$ is then in principle a fairly simple one, although the actual numerical work may be laborious (see TIDE). A much more difficult and delicate question arises when, as in various questions of meteorology and terrestrial magnetism, the periods $2\pi/n_1, 2\pi/n_2, \dots$ are themselves unknown to begin with, or are at most conjectural. Thus, it may be desired to ascertain whether the magnetic declination contains a periodic element synchronous with the sun's rotation on its axis, whether any periodicities can be detected in the records of the prevalence of sun-spots, and so on. From a strictly mathematical standpoint the problem is, indeed, indeterminate, for when all the symbols are at our disposal, the representation of the observed values of a function, over a finite range of time, by means of a series of the type (2), can be effected in an infinite variety of ways. Plausible inferences can, however, be drawn, provided the proper precautions are observed. This question has been treated most systematically by Professor A. Schuster, who has devised a remarkable mathematical method, in which the action of a diffraction-grating in sorting out the various periodic constituents of a heterogeneous beam of light is closely imitated. He has further applied the method to the study of the variations of the magnetic declination, and of sun-spot records.

The question so far chiefly considered has been that of the representation of an arbitrary function of the time in terms of functions of a special type, viz. the circular functions $\cos nt, \sin nt$. This is important on dynamical grounds; but when we proceed to consider the problem of expressing an arbitrary function of space-coordinates in terms of functions of specified types, it appears that the preceding is only one out of an infinite variety of modes of representation which are equally entitled to consideration. Every problem of mathematical physics which leads to a linear differential equation supplies an instance. For purposes of illustration we will here take the simplest of all, viz. that of the transversal vibrations of a taut string. The equation of motion is of the form

$$\rho \frac{\partial^2 y}{\partial t^2} = T \frac{\partial^2 y}{\partial x^2} \quad (3)$$

where T is the tension, and ρ the line-density. In a "normal mode" of vibration y will vary as e^{ikt} , so that

$$\frac{\partial^2 y}{\partial x^2} + k^2 y = 0, \quad (4)$$

where

$$k^2 = n^2 \rho / T. \quad (5)$$

If ρ , and therefore k , is constant, the solution of (4) subject to the condition that $y=0$ for $x=0$ and $x=l$ is

$$y = B \sin kx \quad (6)$$

provided

$$k = s\pi, \quad [s = 1, 2, 3, \dots]. \quad (7)$$

This determines the various normal modes of free vibration, the corresponding periods ($2\pi/n$) being given by (5) and (7). By analogy with the theory of the free vibrations of a system of finite freedom it is inferred that the most general free motions of the string can be obtained by superposition of the various normal modes, with suitable amplitudes and phases; and in particular that any arbitrary initial form of the string, say $y=f(x)$, can be reproduced by a series of the type

$$f(x) = B_1 \sin \frac{\pi x}{l} + B_2 \sin \frac{2\pi x}{l} + B_3 \sin \frac{3\pi x}{l} + \dots \quad (8)$$

So far, this is merely a restatement, in mathematical language, of an argument given in the first part of this article. The series (8) may, moreover, be arrived at otherwise, as a particular case of Fourier's theorem. But if we no longer assume the density ρ of the string to be uniform, we obtain an endless variety of new expansions, corresponding to the various laws of density which may be prescribed. The normal modes are in any case of the type

$$y = C u(x) e^{ikt} \quad (9)$$

where u is a solution of the equation

$$\frac{d^2 u}{dx^2} + \frac{\rho}{T} u = 0. \quad (10)$$

The condition that $u(x)$ is to vanish for $x=0$ and $x=l$ leads to a transcendental equation in n (corresponding to $\sin kl=0$ in the previous case). If the forms of $u(x)$ which correspond to the various roots of this be distinguished by suffixes, we infer, on physical grounds alone, the possibility of the expansion of an arbitrary initial form of the string in a series

$$f(x) = C_1 u_1(x) + C_2 u_2(x) + C_3 u_3(x) + \dots \quad (11)$$

It may be shown further that if r and s are different we have the conjugate or orthogonal relation

$$\int_0^l \rho u_r(x) u_s(x) dx = 0 \quad (12)$$

This enables us to determine the coefficients, thus

$$C_n = \int_0^1 \rho_f(x) u_n(x) dx + \int_0^1 \rho_s u_n(x)^2 dx. \quad (13)$$

The extension to spaces of two or three dimensions, or to cases where there is more than one dependent variable, must be passed over. The mathematical theories of acoustics, heat-conduction, elasticity, induction of electric currents, and so on, furnish an indefinite supply of examples, and have suggested in some cases methods which have a very wide application. Thus the transverse vibrations of a circular membrane lead to the theory of Bessel's Functions; the oscillations of a spherical sheet of air suggest the theory of expansions in spherical harmonics, and so forth. The physical, or intuitional, theory of such methods has naturally always been in advance of the mathematical. From the latter point of view only a few isolated questions of the kind had, until quite recently, been treated in a rigorous and satisfactory manner. A more general and comprehensive method, which seems to derive some of its inspiration from physical considerations, has, however, at length been inaugurated, and has been vigorously cultivated in recent years by D. Hilbert, H. Poincaré, I. Fredholm, E. Picard and others.

REFERENCES.—Schuster's method for detecting hidden periodicities is explained in *Terrestrial Magnetism* (Chicago, 1898), 3, p. 13; *Camb. Trans.* (1900), 18, p. 102; *Proc. Roy. Soc.* (1906), 77, p. 136. The general question of expanding an arbitrary function in a series of functions of special types is treated most fully from the physical point of view in Lord Rayleigh's *Theory of Sound* (2nd ed., London, 1894-1896). An excellent detailed historical account of the matter from the mathematical side is given by H. Burkhardt, *Entwicklungen nach oscillierenden Funktionen* (Leipzig, 1901). A sketch of the more recent mathematical developments is given by H. Bateman, *Proc. Lond. Math. Soc.* (2), 4, p. 90, with copious references.

(H. Lb.)

HARMONICHORD, an ingenious kind of upright piano, in which the strings were set in vibration not by the blow of the hammer but by indirectly transmitted friction. The harmonichord, one of the many attempts to fuse piano and violin, was invented by Johann Gottfried and Johann Friedrich Kaufmann (father and son) in Saxony at the beginning of the 19th century, when the craze for new and ingenious musical instruments was at its height. The case was of the variety known as *giraffe*. The space under the keyboard was enclosed, a knee-hold being left in which were two pedals used to set in rotation a large wooden cylinder fixed just behind the keyboard over the levers, and covered with a roll-top similar to those of modern office desks. The cylinder (in some specimens covered with chamois leather) tapered towards the treble-end. When a key was depressed, a little tongue of wood, one end of which stopped the string, was pressed against the revolving cylinder, and the vibrations produced by friction were transmitted to the string and reinforced as in piano and violin by the soundboard. The adjustment of the parts and the velocity of the cylinder required delicacy and great nicety, for if the little wooden tongues rested too lightly upon the cylinder or the strings, harmonics were produced, and the note jumped to the octave or twelfth. Sometimes when chords were played the touch became so heavy that two performers were required, as in the early medieval organistrum, the prototype of the harmonichord. Carl Maria von Weber must have had some opinion of the possibilities of the harmonichord, which in tone resembled the glass harmonica, since he composed for it a concerto with orchestral accompaniment.

(K. S.)

HARMONIUM (Fr. *harmonium*, *orgue expressif*; Ger. *Physikarmonika*, *Harmonium*), a wind keyboard instrument, a small organ without pipes, furnished with free reeds. Both the harmonium and its later development, the American organ are known as free-reed instruments, the musical tones being produced by tongues of brass, technically termed "vibrators" (Fr. *anche libre*; Ger. *durchschlagende Zunge*; Ital. *ancia* or *lingua libera*). The vibrator is fixed over an oblong, rectangular frame, through which it swings freely backwards and forwards like a pendulum while vibrating, whereas the beating reeds (similar to those of the clarinet family), used in church organs, cover the entire orifice, beating against the sides at each vibration. A reed or vibrator, set in periodic motion by impact of a current of air, produces a corresponding succession of air puffs, the

rapidity of which determines the pitch of the musical note. There is an essential difference between the harmonium and the American organ in the direction of this current; in the former the wind apparatus forces the current upwards, and in the latter sucks it downwards, whence it becomes desirable to separate in description these varieties of free-reed instruments.

The *harmonium* has a keyboard of five octaves compass when complete, , and a simple action controlling the

valves, &c. The necessary pressure of wind is generated by bellows worked by the feet of the performer upon foot-boards or treadles. The air is thus forced up the wind-trunks into an air-chamber called the wind-chest, the pressure of it being equalized by a reservoir, which receives the excess of wind through an aperture, and permits escape, when above a certain pressure, by a discharge valve or pallet. The aperture admitting air to the reservoir may be closed by a drawstop named "expression." The air being thus cut off, the performer depends for his supply entirely upon the management of the bellows worked by the treadles, whereby he regulates the compression of the wind. The character of the instrument is then entirely changed from a mechanical response to the player's touch to an expressive one, rendering what emotion may be communicated from the player by increase or diminution of sound through the greater or less pressure of wind to which the reeds may be submitted. The drawstops bearing the names of the different registers in imitation of the organ, admit, when drawn, the wind from the wind-chest to the corresponding reed compartments, shutting them off when closed. These compartments are of about two octaves and a half each, there being a division in the middle of the keyboard scale dividing the stops into bass and treble. A stop being drawn and a key pressed down, wind is admitted by a corresponding valve to a reed or vibrator (fig. 1). Above each reed in the so-called sound-board or pan is a channel, a small air-chamber or cavity, the shape and capacity of which have greatly to do with the colour of tone of the note it reinforces. The air in this resonator is highly compressed at an even or a varying pressure as the expression-stop may not be or may be drawn. The wind finally escapes by a small pallet-hole opened by pressing down the corresponding key. In Mustel and other good harmoniums, the reed compartments that form the scheme of the instrument are eight in number, four bass and four treble, of three different pitches of octave and double octave distance. The front bass and treble rows are the "diapason" of the pitch known as 8 ft., and the bourdon (double diapason), 16 ft. These may be



By courtesy of Mustel & Co.

regarded as the foundation stops, and are technically the front organ. The back organ has Vibrator, Alexandre solo and combination stops, the principal of 4 Harmonium, ft. (octave higher than diapason), and bassoon (bass) and oboe (treble), 8 ft. These may be mechanically combined by a stop called full organ. The French maker, Mustel, added other registers for much-admired effects of tone, viz. "harpe éolienne," two bass rows of 2 ft. pitch, the one tuned a beat too sharp, the other a beat too flat, to produce a waving tremulous tone that has a certain charm; "musette" and "voix celeste" 16 ft.; and "baryton," a treble stop 32 ft., or two octaves lower than the normal note of the key. The "back organ" is usually covered by a swell box, containing louvers or shutters similar to a Venetian blind, and divided into fortes corresponding with the bass and treble division of the registers. The fortes are governed by knee pedals which act by pneumatic pressure. Tuning the reeds is effected by scraping them at the point to sharpen them, or near the shoulder or heel to flatten them in pitch. Air pressure affects the pitch but slightly, being noticeable only in the larger reeds, and harmoniums long retain their tuning, a decided advantage over the organ and the pianoforte. Mechanical contrivances in the harmonium, of frequent or occasional employment, besides those already referred to, are the "percussion," a small pianoforte action of hammer and escapement which, acting upon the reeds of the diapason rows at the moment air is admitted to them, gives prompter response to the depression of the key, or quicker speech; the "double expression," a pneumatic balance of great delicacy in the wind reservoir, exactly maintaining by gradation equal pressure of the wind; and the "double touch," by which the back organ registers speak sooner than those of the front that are called upon by deeper pressure of the key, thus allowing prominence or accentuation of certain parts by an expert performer. "Prolongement" permits selected notes to be sustained after the fingers have quitted

their keys. Dawes's "melody attachment" is to give prominence to an air or treble part by shutting off in certain registers all notes below it. This notion has been adapted by inversion to a "pedal substitute" to strengthen the lowest bass notes. The "tremolo" affects the wind in the vicinity of the reeds by means of small bellows which increase the velocity of the pulsation according to pressure; and the "sourdine" diminishes the supply of wind by controlling its admission to the reeds.

The *American Organ* acts by wind exhaustion. A vacuum is practically created in the air-chamber by the exhausting power of the footboards, and a current of air thus drawn downwards passes through any reeds that are left open, setting them in vibration. This instrument has therefore exhaust instead of force bellows. Valves in the board above the air-chamber give communication to reeds (fig. 2) made more slender than those of the harmonium and

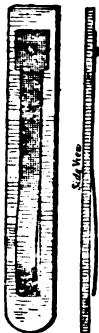

By courtesy of Metzler & Co.

FIG. 2.—Free Reed Vibrator, Mason & Hamlin American Organ.

are near the reeds, causes interferences of vibration that produce a tremulous effect, not unlike the beatings heard from combined voices, whence the name. The arrangement of reed compartments in American organs does not essentially differ from that of harmoniums; but there are often two keyboards, and then the solo and combination stops are found on the upper manual. The diapason treble register is known as "melodia"; different makers occasionally vary the use of fancy names for other stops. The "sub-bass," however, an octave of 16 ft. pitch and always apart from the other reeds, is used with great advantage for pedal effects on the manual, the compass of American organs being usually down to F (FF, 5 octaves). In large instruments there are sometimes foot pedals as in an organ, with their own reed boxes of 8 and 16 ft., the lowest note being then CC. Blowing for pedal instruments has to be done by hand, a lever being attached for that purpose. The "celeste" stop is managed as in the harmonium, by rows of reeds tuned not quite in unison, or by a shade valve that alters the air-current and flattens one row of reeds thereby.

Harmoniums and American organs are the result of many experiments in the application of free reeds to keyboard instruments. The principle of the free reed became widely known in Europe through the introduction of the Chinese cheng¹ during the second half of the 18th century, and culminated in the invention of the harmonium and kindred instruments. The first step in the invention of the harmonium is due to Professor Christian Gottlieb Kratzenstein of Copenhagen, who had had the opportunity of examining a cheng sent to his native city and of testing its merits.² In 1779 the Academy of Science of St Petersburg had offered a prize for an essay on the formation of the vowel sounds on an instrument similar to the "vox humana" in the organ, which should be capable of reproducing these sounds faithfully. Kratzenstein made as a demonstration of his invention a small pneumatic organ fitted with free reeds, and presented it to the Academy of St Petersburg.³ His essay was crowned and was republished with diagrams in Paris⁴ in

¹ See *Allg. musik. Ztg.* (Leipzig, 1821), Bd. xxiii. pp. 369-374. The cheng was made known in France by Père Amiot, who published a careful description of the instrument in *Mémoire sur la musique des Chinois*, p. 80 seq., with excellent diagrams.

² *Ib.*, Bd. xxv. p. 152.

³ The essay was published in *Acta Acad. Petrop.* (1780).

⁴ *Essai sur la naissance et sur la formation des voyelles* in Rozier's *Observations sur la physique* (Paris, 1782), *Supplément*, xxi, 358 seq., with two plates. The description of the instrument begins on p. 374. § xxii.

1782. Meanwhile, in 1780, a countryman of Kratzenstein's, an organ-builder named Kirsnick, established in St Petersburg, adapted these reed pipes to some of his organs and to an instrument of his invention called organochordium, an organ combined with piano. When Abt Vogler visited St Petersburg in 1788, he was so delighted with these reeds that in 1790 he induced Rackwitz, an assistant of Kirsnick's, to come to him and adapt some to an organ he was having built in Rotterdam. Three years later Abt Vogler's orchestraion, a chamber organ containing some 900 pipes, was completed, and, according to Rackwitz,⁵ was fitted with free-reed pipes. Vogler himself, however, does not mention the free reed when describing this wonderful instrument and his system of "simplification" for church organs.⁶ To Abt Vogler, who travelled all over Germany, Scandinavia and the Netherlands, exhibiting his skill on his orchestraion and reconstructing many organs, is due the credit of making Kratzenstein's invention known and inducing the musical world to appreciate the capabilities of the free reed. The introduction of free-reed stops into the organ, however, took a secondary place in his scheme for reform.⁷ Friedrich Kaufmann⁸ of Dresden states that Vogler told him he had imparted to J. N. Mälzel of Vienna particulars as to the construction of free-reed pipes, and that the latter used them in his panharmonicon,⁹ which he exhibited during his stay in Paris from 1805 to 1807. Kaufmann suggests that it was through him that G. J. Grenié obtained the knowledge which led to his experiments with free reeds in organs. It is more likely that Grenié had read Kratzenstein's essay and had experimented independently with free reeds. In 1812 his first *orgue expressif* was finished. It was a small organ with one register of free reeds—the expression stop, in fact, added to the pipe organ and having a separate wind-chest and bellows. It would seem from his description of the orchestraion in *Data zur Akustik* that Vogler knew of no such device. He used the swell shutter borrowed from England and a threefold screen of canvas covered with a blanket arranged outside the instrument, neither of which is capable of increasing the volume of sound from the organ, or at least only after having first damped the sound to a pianissimo. Vogler explains minutely the apparatus used to conceal the working of the screen from the eyes of the public.¹⁰ The credit of discovering in the free reed the capability of dynamic expression was undoubtedly due to Grenié, although Abt Vogler claims to have used compression in 1796,¹¹ and Kaufmann in his choraulodion in 1816. A larger *orgue expressif* was begun by Grenié for the Conservatoire of Paris in 1812, the construction of which was interrupted and then continued in 1816. Descriptions of Grenié's instrument have been published in French and German.¹² The organ of the Conservatoire had a pedal free-reed stop of 16 ft., with vibrators 0-240 m. long, 0-035 m. wide, and 0-003 m. thick.¹³ Two compressors, one for the treble and the other for the bass, worked by treadles, enabled the performer to regulate the pressure of wind on the reeds and therefore to obtain the gradations of forte and piano which gained for his instrument the name of *orgue expressif*. Grenié's instrument was a pipe organ, the pipes terminating in a cone with a hemispherical cap in the top of which was a small hole. There were eight registers including the pedal, and the positive on the first keyboard had reed stops furnished with

⁵ See "Über die Erfindung der Rohrwerke mit durchschlagenden Zungen," by Wilke, in *Allg. musik. Ztg.* (Leipzig, 1823), Bd. xxv. pp. 152-153 and Bd. xxvii. p. 263; also Thos. Ant. Kunz, "Orchestraion," *ib.*, Bd. i. p. 88 and Bd. ii. pp. 514, 542; and Dr Karl Emil von Schaffhäutl, *Abt Georg Joseph Vogler* (Augsburg, 1888), p. 37.

⁶ *Data zur Akustik, eine Abhandlung vorgelesen bey der Sitzung der naturforschenden Freunde in Berlin, den 15ten Dezember 1800* (Offenbach, 1801); also published in *Allg. musik. Ztg.* (1801), Bd. iii. pp. 517, 533, 565. See also an excellent article by the Rev. J. H. Mee on Vogler in Grove's *Dictionary of Music and Musicians*.

⁷ See *Data zur Akustik*, and a pamphlet by Vogler, "Über die Umgestaltung der St Marien Orgel in Berlin nach dem Voglerschen Simplifikations-System, eine Nachahmung des Orchestraion" (Berlin); also "Kurze Beschreibung der in der Stadtpfarrkirche zu St Peter zu München nach dem Voglerschen Simplifikations-System neuerbauten Orgel" (Munich, 1809).

⁸ See *Allg. musik. Ztg.* (1823), Bd. xxv. pp. 153 and 154 note, and 117-118 note.

⁹ A description of Mälzel's panharmonicon before the addition of the clarinet and oboe stops with free reeds is to be found in the *Allg. musik. Ztg.* (1800), Bd. ii. pp. 414-415.

¹⁰ In the article in Grove's *Dictionary* the screen is said to have been in the wind-trunk.

¹¹ See *Allg. musik. Ztg.* Bd. iii. p. 523.

¹² See J. B. Biot, *Précis élémentaire de physique expérimentale* (Paris, 1817), tome i. p. 386, and his *Traité de physique* (Paris, 1816), tome ii. p. 172 et seq., nl. ii.; "Über die Crescendo und Diminuendo Züge an Orgeln," by Wilke and Kaufmann, *Allg. musik. Ztg.* (1823), Bd. xxv. pp. 113-122; and *Allg. musik. Ztg.* Bd. xxxii. pp. 133-139 and 149-154, with diagrams on p. 167 which are not absolutely correct in small details.

¹³ J. B. Biot, *Traité*, tome ii. p. 174.

beating reeds. Biot insists on the importance of the regulating wires (Fr. *rasettes*; Ger. *Krücken*) for determining the vibrating length of the reed tongue and maintaining it invariable. These are clearly shown in his diagram (see article FREE REED VIBRATOR, fig. 1); they do not essentially differ from those used with the beating-reed stops in his organ (fig. 76, pl. 11.), or indeed from those figured by Praetorius.

Isolated specimens of the cheng must have found their way to Europe during the 15th and 16th centuries, for Mersenne¹ depicts part of one showing the free reed. It would seem that still earlier in the 17th century there was an organ in a monastery in Hesse with free reeds for the *Posaune* stop, for Praetorius gives a description of the "extraordinary" reed (p. 169); there is no record of the inventor in this case.

During the first half of the 19th century various tentative efforts in France and Germany, and subsequently in England, were made to produce new keyboard instruments with free reeds, the most notable of these being the physharmonica² of Anton Häckel, invented in Vienna in 1818, which, improved and enlarged, has retained its hold on the German people. The modern physharmonica is a harmonium without stops or percussion action; it does not therefore speak readily or clearly. It has a range of five to six octaves. Other instruments of similar type are the French melophone and the English scraphine, a keyboard harmonica with bellows but no channels for the tongues, for which a patent was granted to Myers and Storer in 1839; the aeoline or aelodicon³ of Eschenbach; the melodicon⁴ of Dietz; the melodica⁵ of Rieffeltson;

the apollonicon;⁶ the new cheng⁷ of Reichstein; the terpodion⁸ of Buschmann, &c. None of these has survived to the present day.

The inventor of the harmonium was indubitably Alexandre Debain, who took out a patent for it in Paris in 1840. He produced varied timbre registers by modifying reed channels, and brought these registers on to one keyboard. Unfortunately he patented too much, for he secured even the name *harmonium*, obliging contemporary and future experimenters to shelter their improvements under other names, and the venerable name of organ becoming impressed into connexion with an inferior instrument, we have now to distinguish between reed and pipe organs. The compromise of reed organ for the harmonium class of instruments must therefore be accepted. Debain's harmonium was at first quite mechanical; it gained expression by the expression-stop already described. The Alexandres, well-known French makers, by the ingenuity of one of their workmen, P. A. Martin, added the percussion and the prolongement. The melody attachment was the invention of an English engineer; the introduction of the double touch, now used in the harmoniums of Mustel, Bauer and others—also in American organs—was due to Tamplin, an English professor.

The principle of the American organ originated with the Alexandres, whose earliest experiments are said to have been made with the view of constructing an instrument to exhaust air. The realization of the idea proving to be more in consonance with the genius of the American people, to whom what we may call the devotional tone of the instrument appealed, the introduction of it by Messrs Mason and Hamlin in 1861 was followed by remarkable success. They made it generally known in Europe by exhibiting it at Paris in 1867, and from that time instruments have been exported in large numbers by different makers. (A. J. H.; K. S.)

¹ *Harmonie universelle* (Paris, 1636), livre v., prop. xxxv.

² *Wien. musik. Zig.* Bd. v. Nos. 30 and 87.

³ *Allg. musik. Zig.* Bd. xxii. p. 505, and Bd. xxxv. p. 354.

⁴ *Id.* Bd. viii. pp. 526 and 715.

⁵ *Id.* Bd. xi. p. 625.

⁶ *Allg. musik. Zig.* Bd. ii. p. 767, and *Wien. musik. Zig.* Bd. i. No. 501.

⁷ *Id.* Bd. xxxi. p. 489.

⁸ *Id.* Bd. xxxiv. pp. 856 and 858; and *Cæcilia*, Bd. xiv. p. 259.

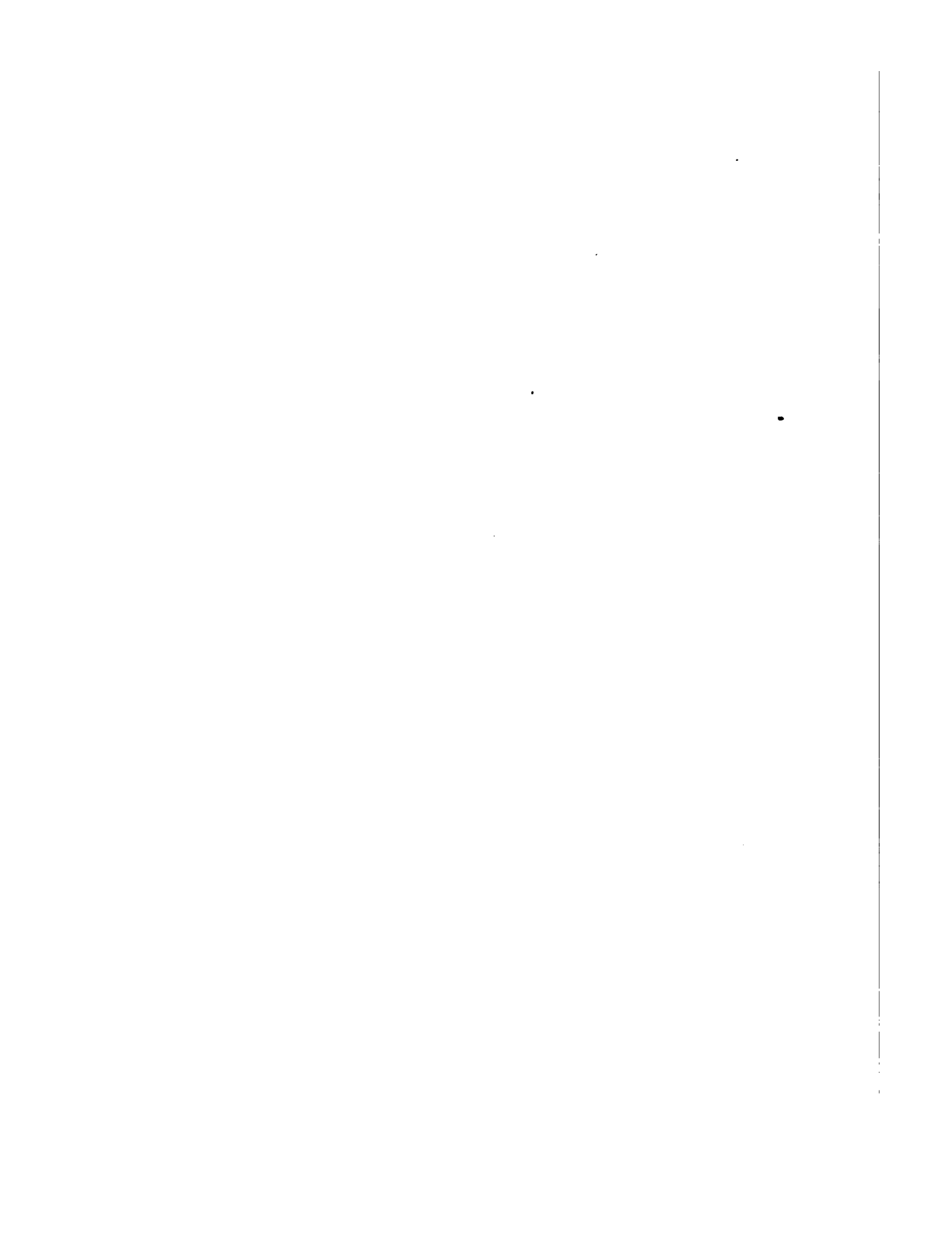

DOES NOT CIRCULATE

Stanford University Libraries



3 6105 024 854 197

CECIL H. GREEN LIBRARY
STANFORD UNIVERSITY LIBRARIES
STANFORD, CALIFORNIA 94305-6004
(650) 723-1493
grncirc@sulmail.stanford.edu
All books are subject to recall.

DATE DUE

