

B 4 139 436

ESSENTIALS

OF

CHEMICAL PHYSIOLOGY



LEA AND GIBBONSON

MEDICAL SCHOOL  
LIBRARY

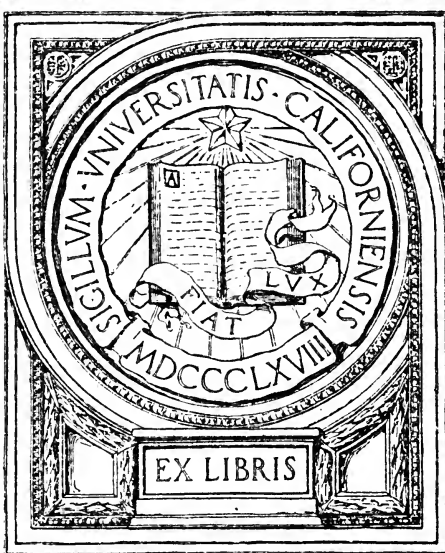

EX LIBRIS



MEDICAL SCHOOL  
LIBRARY

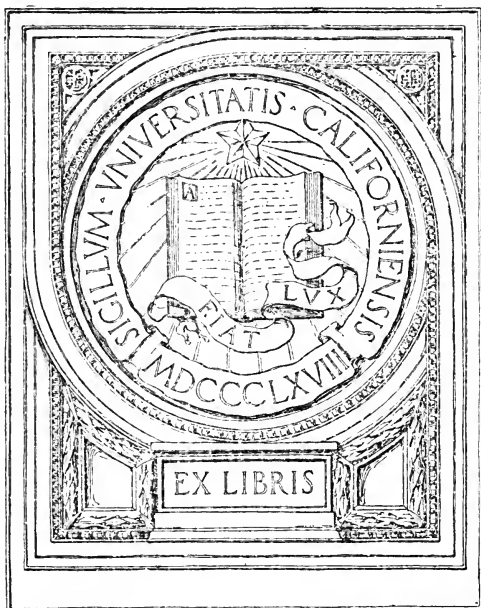

Hooper Foundation  
Accession

*Alice Rohde.*

**CHEMICAL PHYSIOLOGY**

STATE OF TEXAS

County of \_\_\_\_\_

\_\_\_\_\_

\_\_\_\_\_

\_\_\_\_\_

\_\_\_\_\_

\_\_\_\_\_

\_\_\_\_\_

\_\_\_\_\_

\_\_\_\_\_

\_\_\_\_\_

\_\_\_\_\_

\_\_\_\_\_

QP514  
H18  
1907

## PREFACE

TO

### THE SIXTH EDITION

I HAVE again subjected the book to a thorough revision, and the changes which are now introduced into the practical exercises are those which experience has shown to be advisable. In the large text it has been necessary to rewrite a good many parts, mainly on account of our increased knowledge of the proteins and of the way they are utilised in the body. The sections relating to blood coagulation and to respiration have been much amplified in order to include many facts which are the result of recent research.

In my endeavour to bring the work abreast of advances in science, and at the same time to keep it within moderate limits, I have to acknowledge help and valuable suggestions from Mr. J. Barcroft, M.A. (especially in connection with Respiration), from Professor T. G. Brodie, F.R.S., and from my two colleagues at King's College, Dr. Lyle and Dr. O. Rosenheim; both of these have been of great assistance to me in reading the proof-sheets, and Dr. Lyle is again responsible for the Index.

W. D. HALLIBURTON.

KING'S COLLEGE, 1907.

11089

Digitized by the Internet Archive  
in 2007 with funding from  
Microsoft Corporation



# CONTENTS

	PAGE
INTRODUCTION . . . . .	1

## *ELEMENTARY COURSE*

### LESSON

I. THE ELEMENTS CONTAINED IN PHYSIOLOGICAL COMPOUNDS. . . . .	9
II. THE CARBOHYDRATES. . . . .	13
III. THE FATS. . . . .	22
IV. THE PROTEINS . . . . .	27
V. THE PROTEINS (continued) . . . . .	29
VI. FOODS . . . . .	49
VII. THE DIGESTIVE JUICES—SALIVA AND GASTRIC DIGESTION . . . . .	62
VIII. THE DIGESTIVE JUICES (continued)—PANCREATIC DIGESTION AND BILE . . . . .	78
IX. THE BLOOD AND RESPIRATION . . . . .	101
X. URINE . . . . .	141
XI. URINE (continued) . . . . .	156
XII. PATHOLOGICAL URINE . . . . .	166
SCHEME FOR DETECTING PHYSIOLOGICAL PROXIMATE PRINCIPLES . . . . .	171

## *ADVANCED COURSE*

INTRODUCTION . . . . .	175
------------------------	-----

### LESSON

XIII. CARBOHYDRATES. . . . .	176
XIV. ACTION OF MALT UPON STARCH. . . . .	179
XV. CRYSTALLISATION OF EGG ALBUMIN . . . . .	180
XVI. MILK. . . . .	181
XVII. THE PROTEOSES . . . . .	182

LESSON	PAGE
XVIII. DIGESTION . . . . .	184
XIX. HÆMOGLOBIN AND ITS DERIVATIVES . . . . .	188
XX. SERUM . . . . .	192
XXI. COAGULATION OF BLOOD . . . . .	194
XXII. MUSCLE AND NERVOUS TISSUE . . . . .	197
XXIII. UREA AND CHLORIDES IN URINE . . . . .	204
XXIV. PHOSPHATES AND SULPHATES IN URINE . . . . .	207
XXV. URIC ACID AND CREATININE . . . . .	210
XXVI. THE PIGMENTS OF THE URINE . . . . .	213

## APPENDIX

HÆMACYTOMETERS . . . . .	217
HÆMOGLOBINOMETERS . . . . .	219
POLARISATION OF LIGHT . . . . .	222
POLARIMETERS . . . . .	226
THE SPECTRO-POLARIMETER . . . . .	229
RELATION BETWEEN CIRCULAR POLARISATION AND CHEMICAL CONSTITUTION . . . . .	230
MERCURIAL AIR-PUMPS . . . . .	231
ANALYSIS OF GASES . . . . .	234
KJELDAHL'S METHOD OF ESTIMATING NITROGEN . . . . .	235
SOLUTIONS, DIFFUSION, DIALYSIS, OSMOSIS . . . . .	236
INDEX . . . . .	245

## LIST OF ILLUSTRATIONS

FIG.	PAGE
1. DEXTROSE CRYSTALS . . . . .	<i>Frey</i> 17
2. INOSITE CRYSTALS . . . . .	<i>Frey</i> 18
3. MILK-SUGAR CRYSTALS . . . . .	<i>Frey</i> 19
4. SECTION OF PEA, SHOWING STARCH GRAINS . . . . .	<i>Yeo, after Sachs</i> 20
5. FAT CELLS . . . . .	<i>Schäfer</i> 23
6. SIMPLE WARM BATH . . . . .	29
7. DIALYSER. . . . .	37
8. DIALYSER. . . . .	37
9. DIAGRAM OF A CELL . . . . .	<i>Schäfer</i> 45
10. MILK . . . . .	<i>Yeo</i> 53
11. COLOSTRUM CORPUSCLES . . . . .	<i>Heidenhain</i> 53
12. YEAST CELLS . . . . .	<i>Yeo's Physiology</i> 63
13. SCHIZOMYCETES . . . . .	<i>After Zopf</i> 64
14. BACILLUS ANTHRACIS . . . . .	<i>Koch</i> 65
15. ALVEOLI OF SEROUS GLAND . . . . .	<i>Langley</i> 69
16. MUCOUS CELLS . . . . .	<i>Langley</i> 69
17. SUBMAXILLARY GLAND . . . . .	<i>Heidenhain</i> 69
18. FUNDUS GLAND . . . . .	<i>Klein</i> 71
19. PYLORIC GLAND . . . . .	<i>Ebstein</i> 71
20. FUNDUS GLAND . . . . .	<i>Langley</i> 72
21. ALVEOLUS OF PANCREAS . . . . .	<i>Kühne and Lea</i> 80
22. LEUCINE CRYSTALS . . . . .	<i>Kühne</i> 86
23. TYROSINE CRYSTALS . . . . .	<i>Frey</i> 86
24. HEMATOIDIN CRYSTALS . . . . .	<i>Frey</i> 89
25. CHOLESTERIN CRYSTALS . . . . .	<i>Frey</i> 93

FIG.		PAGE
26.	VILLUS OF RAT KILLED DURING FAT ABSORPTION . . . . . Schäfer	98
27.	MUCOUS MEMBRANE OF FROG'S INTESTINE DURING FAT ABSORPTION . . . . . Schäfer	99
28.	FIBRIN FILAMENTS AND BLOOD PLATELETS . . . . . Schäfer	103
29.	ACTION OF REAGENTS ON BLOOD CORPUSCLES . . . . . Schäfer	111
30.	OXYHÆMOGLOBIN CRYSTALS . . . . . <i>Quain's Anatomy</i>	112
31.	HÆMIN CRYSTALS . . . . . <i>Preyer</i>	113
32.	DIAGRAM OF SPECTROSCOPE . . . . .	116
33.	FIGURE OF SPECTROSCOPE AND ACCESSORIES . . . . . <i>McKendrick</i>	116
34.	ARRANGEMENT OF PRISMS IN DIRECT-VISION SPECTROSCOPE <i>Gscheidlen</i>	117
35.	STAND FOR DIRECT-VISION SPECTROSCOPE . . . . .	118
36.	ABSORPTION SPECTRA . . . . . <i>Rollett</i>	118
37.	ABSORPTION SPECTRA . . . . .	119
38.	LOEWY'S AËROTONOMETER . . . . .	132
39.	DISSOCIATION CURVES OF BLOOD AND HÆMOGLOBIN . . . . . <i>Bohr</i>	133
40.	BARCROFT'S BLOOD GAS APPARATUS . . . . .	135
41.	DUPRÉ'S UREA APPARATUS . . . . . <i>Gamgee</i>	142
42.	URINOMETER . . . . . <i>McKendrick</i>	144
43.	UREA CRYSTALS . . . . . <i>Frey</i>	144
44.	UREA NITRATE AND OXALATE . . . . . <i>Frey</i>	146
45.	TRIPLE PHOSPHATE CRYSTALS . . . . . <i>Frey</i>	155
46.	URIC ACID CRYSTALS . . . . . <i>Frey</i>	157
47.	ACID SODIUM URATE . . . . . <i>Frey</i>	163
48.	ACID AMMONIUM URATE . . . . . <i>Frey</i>	163
49.	ENVELOPE CRYSTALS OF CALCIUM OXALATE . . . . . <i>Frey</i>	164
50.	CYSTIN CRYSTALS . . . . . <i>Frey</i>	164
51.	TRIPLE PHOSPHATE CRYSTALS . . . . . <i>Bryant's Surgery</i>	164
52.	CALCIUM PHOSPHATE CRYSTALS . . . . . <i>Bryant's Surgery</i>	164
53.	ALBUMINOMETER OF ESBACH . . . . .	166
54.	TWO BURETTES ON STAND . . . . . <i>Sutton</i>	167
55.	HOT-AIR OVEN WITH GAS REGULATOR . . . . . <i>Gscheidlen</i>	176
56.	OSAZONE CRYSTALS . . . . . <i>Coloured plate to face</i>	177
57.	ABSORPTION SPECTRA OF HÆMOGLOBIN, &C. . . . .	189
58.	PHOTOGRAPHIC SPECTRUM OF HÆMOGLOBIN AND OXYHÆMOGLOBIN <i>Gamgee</i>	190

FIG.	PAGE
59. PHOTOGRAPHIC SPECTRUM OF OXYHÆMOGLOBIN AND METHÆMO- GLOBIN . . . . .	<i>Gamgee</i> 190
60. CENTRIFUGAL MACHINE . . . . .	195
61. ABSORPTION SPECTRA OF MYOHÆMATIN . . . . .	199
62. A DESICCATOR . . . . .	<i>Gscheidlen</i> 199
63. ABSORPTION SPECTRA OF URINARY PIGMENTS . . . . .	<i>After Hopkins</i> 215
64. GOWERS' HÆMACYTOMETER . . . . .	217
65. OLIVER'S HÆMACYTOMETER . . . . .	218
66. GOWERS' HÆMOGLOBINOMETER . . . . .	219
67. VON FLEISCHL'S HÆMOMETER . . . . .	220
68. OLIVER'S HÆMOGLOBINOMETER . . . . .	221
69. MODEL TO ILLUSTRATE POLARISED LIGHT . . . . .	223
70. MODEL TO ILLUSTRATE POLARISED LIGHT . . . . .	223
71. MODEL TO ILLUSTRATE POLARISED LIGHT . . . . .	224
72. DIAGRAM TO EXPLAIN POLARISATION OF LIGHT . . . . .	225
73. DIAGRAM TO EXPLAIN POLARISATION OF LIGHT . . . . .	226
74. SOLEIL'S SACCHARIMETER . . . . .	227
75. DIAGRAM OF OPTICAL ARRANGEMENTS IN SOLEIL'S SACCHARIMETER . . . . .	227
76. LAURENT'S POLARIMETER . . . . .	228
77. SPECTRO-POLARIMETER OF VON FLEISCHL . . . . .	229
78. DIAGRAM OF ASYMMETRIC CARBON ATOMS . . . . .	231
79. DIAGRAM OF PFLÜGER'S PUMP . . . . .	232
80. L. HILL'S AIR-PUMP . . . . .	233
81. WALLER'S APPARATUS FOR GAS ANALYSIS . . . . .	<i>Waller</i> 234
82. KJELDAHL'S METHOD, DISTILLING APPARATUS . . . . .	235
83. DIAGRAM TO ILLUSTRATE OSMOSIS . . . . .	239



# ESSENTIALS

OF

# CHEMICAL PHYSIOLOGY

## INTRODUCTION

**Chemical Physiology** or **Physiological Chemistry** deals with the chemical composition of the body and with the chemical changes it undergoes; it also deals with the composition of the food which enters, and the excretions which leave, the body.

When a chemist examines living things he is placed at a disadvantage when compared with an anatomist; for the latter can with the microscope examine cells, organisms, and structures in the living condition. The chemist, on the other hand, cannot at present state anything positive about the chemical structure of living matter, because the reagents he uses will destroy the life of the tissue he is examining. There is, however, no such disadvantage when he examines non-living matter, like food and urine, and it is therefore in the analysis of such substances that chemical physiology has made very important advances, and the knowledge so obtained is of the greatest practical interest to the student and practitioner of medicine.

The animal organism is in its earliest embryonic state a single cell; as development progresses it becomes an adherent mass of simple cells. In the later stages various tissues become differentiated from each other by the cells becoming grouped in different ways by alteration in the shape of the cells, by deposition of intercellular matter between the cells, and by chemical changes in the living matter of the cells themselves. Thus in some situations the cells are grouped into the various epithelial linings; in others the

cells become elongated, and form muscular fibres ; in the connective tissues we have a preponderating amount of intercellular material, which may become permeated with fibres, or be the seat of the deposition of calcareous salts, as in bone. Instances of chemical changes in the cells themselves are seen on the surface of the body, where the superficial layers of the epidermis become horny (*i.e.* filled with the chemical substance called keratin) ; in the mucous salivary glands, where the cells become filled with mucin, which they subsequently extrude ; and in adipose tissue, where they become filled with fat.

In spite of these changes, the variety of which produces the great complexity of the adult organism, there are many cells which still retain their primitive structure : notable among these are the white corpuscles of the blood.

A cell may be defined as a mass of living material containing in its interior a more solid structure called the *nucleus*. The nucleus exercises a controlling influence over the nutrition and subdivision of the cell.

The living substance is usually pervaded with granules : one of these minute particles called the *centrosome* exercises an attractive influence on the granules and fibrils of the protoplasm in its neighbourhood, and the appearance so produced is called the attraction sphere. The attraction sphere becomes specially prominent, and divides into two when the cell is about to divide ; this usually precedes the division of the nucleus.

Living material is called *protoplasm*, and protoplasm is characterised by (1) irritability—that is, the property of responding by some change when subjected to the influence of an external agent or stimulus : the most obvious of these changes is movement (amœboid movement, ciliary movement, muscular movement, &c.) ; (2) its power of assimilation—that is, it is able to convert into protoplasm the nutrient material or food which is ingested ; (3) its power of growth—this is a natural consequence of its power of assimilation ; (4) its power of reproduction—this is a variety of growth ; and (5) its power to excrete, to give out waste materials, the products of its other activities.

Of all the signs of life, those numbered 2 and 5 in the foregoing list are the most essential. Living material is in a continual state of unstable chemical equilibrium, building itself up on the one hand, breaking down on the other ; the term used for the sum total of these intra-molecular rearrangements is **metabolism**. The chemical substances in the protoplasm which are the most important from this



point of view are the complex nitrogenous compounds called *Proteins*.<sup>1</sup> So far as is at present known, protein material is never absent from living substance, and is never present in anything else than that which is alive or has been formed by the agency of living cells. It may therefore be stated that **Protein Metabolism** is the most essential characteristic of vitality.

The chemical structure of protoplasm can only be investigated after the protoplasm has been killed. The substances it yields are (1) **Water** ; protoplasm is semi-fluid, and at least three-quarters of its weight, often more, are due to water. (2) **Proteins**. These are the most constant and abundant of the solids. A protein or albuminous substance consists of carbon, hydrogen, nitrogen, oxygen, with sulphur and phosphorus in small quantities only. In *nuclein*, a protein-like substance obtained from the nuclei of cells, phosphorus is more abundant. The protein obtained in greatest abundance from the cell-protoplasm is *nucleo-protein*: that is, a compound of protein with varying amounts of *nuclein*. White of egg is a familiar instance of an albuminous substance or protein, and the fact (which is also familiar) that this sets into a solid on boiling will serve as a reminder that the greater number of the proteins found in nature have a similar tendency to coagulate under the influence of heat and other agencies. (3) Various other substances occur in smaller proportions, the most constant of which are **lecithin**, a phosphorised fat; **cholesterin**, a monatomic alcohol: and **inorganic salts**, especially phosphates and chlorides of calcium, sodium, and potassium.

It will be seen from this rapid survey of the composition of the body how many are the substances which it is necessary we should study; the food from which it is built up is also complex, for animals do not possess, to such an extent as plants do, the power of building up complex from simple materials.

The substances out of which the body is built consist of chemical elements and of chemical compounds, or unions of these elements.

The **elements** found in the body are carbon, hydrogen, nitrogen, oxygen, sulphur, phosphorus, fluorine, chlorine, iodine, silicon, sodium, potassium, calcium, magnesium, lithium, iron, and occasionally manganese, copper, and lead.

Of these very few occur in the free state. Oxygen and nitrogen (to a small extent) are found dissolved in the blood-plasma; hydrogen is

<sup>1</sup> In most English text-books these substances have hitherto been called *Proteids*. The change to *Protein* brings English, American, and German usage into harmony.

formed by putrefaction in the alimentary canal. With some few exceptions such as these, the elements enumerated above are found combined with one another to form compounds.

The **compounds**, or, as they are often termed in physiology, the *proximate principles*, found in the body are divided into—

- (1) Mineral or inorganic compounds.
- (2) Organic compounds, or compounds of carbon.

A convenient practical method of grouping these proximate principles of the body and of food is the following:—

Inorganic . . . . .	{	<i>Water.</i> <i>Salts—e.g. chlorides and phosphates of sodium and calcium.</i>
Organic {	{	<i>Proteins—e.g. albumin, myosin, gelatin.</i> <i>Simpler nitrogenous bodies—e.g. lecithin, creatine, urea.</i>
	{	<i>Fats—e.g. butter, fats of adipose tissue.</i> <i>Carbohydrates—e.g. sugar, starch.</i> <i>Simple organic bodies—e.g. alcohol, cholesterol, vegetable acids and salts, lactic acid.</i>

Many of the substances enumerated above only occur in small quantities. The most important are the inorganic substances, *water* and *salts*; and the organic substances, *proteins*, *carbohydrates*, and *fats*. It is necessary in our subsequent study of the principles of chemical physiology that we should always keep in mind this simple classification; the subdivision of organic substances into proteins, fats, and carbohydrates forms the starting point, the A B C, as one might say, of chemical physiology.

I shall conclude this introductory chapter by giving a list of the apparatus and reagents necessary for a practical study of the subject, and some tables to which it will be often found convenient to refer.

The following set of reagents conveniently contained in 4 to 6 oz. glass stoppered bottles should be provided for each two students:—

Sulphuric acid, concentrated.
"    "    25 per cent.
"    "    0·1 per cent.
Nitric acid, concentrated.
Fuming nitric acid.
Hydrochloric acid, concentrated.
"    "    0·2 per cent. <sup>1</sup>
Acetic acid, glacial.
"    "    20 per cent.
"    "    2    "
Glyoxylic acid.
Formaldehyde.

<sup>1</sup> Made by adding 994 c.c. of water to 6 c.c. of the concentrated hydrochloric acid of the British Pharmacopœia.

Caustic potash, 20 per cent.  
 " " 0.1 "  
 Ammonia.  
 Sodium carbonate, 1 per cent.  
 Ammonium sulphide solution.  
 Ammonium sulphate, saturated solution.  
 Silver nitrate, 1 per cent.  
 Barium chloride, saturated solution.  
 Ammonium molybdate solution.  
 Millon's reagent<sup>1</sup>  
 Solution of ferrocyanide of potassium.  
 " litmus.  
 " sodium phosphate.  
 " iodine in potassium iodide.  
 " ferrous sulphate.  
 " ferric chloride.  
 " sodium nitroprusside.  
 Alcohol.  
 Ether.  
 Esbach's reagent.<sup>2</sup>  
 Solution of copper sulphate, 1 per cent.  
 Fehling's solution.  
 Lime water.

The following additional reagents will be required by those taking the advanced course:—

Solution of mercuric chloride.  
 " potassium ferricyanide.  
 Sodium carbonate, saturated solution.  
 " chloride, saturated solution.  
 " " 10-per-cent. solution.  
 Magnesium sulphate, saturated solution.  
 Baryta mixture.<sup>3</sup>  
 Sodium acetate solution.<sup>4</sup>  
 Phosphoric acid, 0.5 per cent.

In addition to these, there should be kept in stock in the laboratory, to be given out for the lessons in which they are used, the following:—

Solid sodium chloride.  
 " magnesium sulphate.  
 " ammonium sulphate.  
 " sodio-magnesium sulphate.  
 Standard solution of uranium acetate or nitrate for estimating phosphates.<sup>5</sup>

<sup>1</sup> Mercury is dissolved in its own weight of strong nitric acid. The solution so obtained is diluted with twice its volume of water. The decanted clear liquid is Millon's reagent.

<sup>2</sup> Ten grammes of picric acid and 20 grammes of citric acid are dissolved in 800 to 900 c.c. of boiling water, and then sufficient water added to make up a litre.

<sup>3</sup> Made by mixing 1 volume of barium-nitrate solution with 2 of barium-hydrate solution, both saturated *in the cold*.

<sup>4</sup> Prepared as follows:—Sodium acetate, 100 grammes; water, 900 c.c.; glacial acetic acid, 100 c.c.

<sup>5</sup> Instructions how to make standard solutions will be given in the lessons where they are used.

Standard solution of mercuric nitrate for estimating urea.  
 " " silver " " chlorides.  
 Caustic soda, 40 per cent.  
 Bromine.  
 Solution of potassium bichromate.  
 Phenyl hydrazine hydrochloride.  
 Solid sodium acetate.  
 Phospho-tungstic acid.  
 Glacial phosphoric acid.  
 Dry cupric oxide.  
 Soda-lime.

Each student should be provided with—

A Bunsen burner.  
 1 dozen test-tubes in test-tube stand.  
 2 or 3 4-oz. flasks.  
 2 flat porcelain dishes.  
 2 or 4 4-oz. beakers.  
 2 small glass funnels and a funnel stand.  
 A glass stirring rod and a small pipette.  
 1 burette.  
 An iron tripod with wire gauze.  
 Filter papers and litmus papers.  
 A 100-c.c. cylindrical measuring glass.  
 A thermometer marked in degrees Centigrade.  
 A urinometer.  
 A tin can on a stand to be used as a water-bath.

Apparatus which is not so frequently used, such as that employed in generating carbonic anhydride, carbonic oxide, or sulphuretted hydrogen, may be given out as required. The laboratory should also possess a good balance, with its accessories, water and air baths, kept at various temperatures, retorts, and analytical apparatus generally. The microscope, polarimeter, spectroscope, dialyser, are also frequently employed in chemico-physiological investigations. Apparatus and reagents for carrying out the Kjeldahl process are also necessary.

## WEIGHTS AND MEASURES

The weights and measures usually employed in science are those of the metric system; but as in this country the practical physician still largely uses English grains and ounces, we may compare the two systems in the following way:—

### *Weights*

(English System)

1 grain	=	0.0648 gramme
1 ounce = 437.5 grains	=	28.3595 grammes
1 lb. = 16 oz. = 7,000 grains	=	453.5925 „

The scruple = 20 grains = 1.296 gramme, and the drachm = 60 grains = 3.888 grammes, are retained in use, but neither is an aliquot part of the ounce; though for practical purposes an ounce is considered to consist of 8 drachms.

## (Metric System)

1 milligramme =	0·001 gramme =	0·015432 grain
1 centigramme =	0·01        " =	0·154323       "
1 decigramme =	0·1         " =	1·543235       "
1 gramme		15·43235 grains
1 decagramme = 10	grammes =	154·3235       "
1 hectogramme = 100	" =	1543·235       "
1 kilogramme = 1,000	" =	15432·35       "
		= 2 lb. 3 oz. 119·8 "

*Measures of Length*

## (English System)

1 inch =	25·4 millimetres
1 foot =	12 inches = 304·8 millimetres

## (Metric System)

The standard of length is the metre; subdivisions and multiples of which with the prefixes milli-, centi-, and deci-, on the one hand, and deca-, hecto- and kilo-, on the other, have the same relation to the metre as the subdivisions and multiples of the gramme, in the table just given, have to the gramme, thus:

1 millimetre =	0·001 metre =	0·03937 inch
1 centimetre =	0·01       " =	0·3937       "
1 decimetre =	0·1        " =	3·93707 inches
1 metre		39·37079     "

*Measures of Capacity*

## (English System)

1 minim	=	0·59 cubic centimetre
1 fluid drachm = 60 minims	=	3·549 cubic centimetres
1 fluid ounce = 8 fluid drachms	=	28·398               "
1 pint = 20 fluid ounces	=	567·936             "
1 gallon = 8 pints	=	4·54837 litres

## (Metric System)

In the metric system the measures of capacity are intimately connected with the measures of length; we thus have cubic millimetres, cubic centimetres, and so forth. The standard of capacity is the litre, which is equal to 1,000 cubic centimetres; and each cubic centimetre is the volume of 1 gramme of distilled water at 4° C.<sup>1</sup>

1 cubic centimetre (generally written c.c.)	=	16·931 minims.
1 litre = 1,000 c.c. = 1 pint 15 oz. 2 drs. 11 m.	=	35·2154 fluid ounces.
1 cubic inch =	=	16·365 c.c.

## THERMOMETRIC SCALES

The scale most frequently used in this country is the Fahrenheit scale; in this the freezing-point of water is 32°, and the boiling point 212°. On the Continent the Réaumur scale is largely employed, in which the freezing-point is 0°, and the boiling-point 80°. In scientific work the Centigrade

<sup>1</sup> 4° C. is the temperature at which water has the greatest density. For practical purposes measures are more often constructed so that a cubic centimetre holds a gramme of water at 16° C., which is about the average temperature of rooms. The true cubic centimetre contains only 0·999 gramme at 16° C

scale has almost completely taken the place of these; in this system the freezing-point is  $0^{\circ}$  and the boiling-point  $100^{\circ}$ .

To convert degrees Fahrenheit into degrees Centigrade, subtract 32 and multiply by  $\frac{5}{9}$ , or  $C = (F - 32) \frac{5}{9}$ . Conversely, degrees Centigrade may be converted into degrees Fahrenheit by the following formula:  $F = \frac{9}{5}C + 32$ .

TENSION OF AQUEOUS VAPOUR IN MILLIMETRES OF  
MERCURY FROM  $10^{\circ}$  TO  $25^{\circ}$  C.

$10^{\circ}$ . 9.126	$14^{\circ}$ . 11.882	$18^{\circ}$ . 15.351	$22^{\circ}$ . 19.675
$11^{\circ}$ . 9.751	$15^{\circ}$ . 12.677	$19^{\circ}$ . 16.345	$23^{\circ}$ . 20.909
$12^{\circ}$ . 10.421	$16^{\circ}$ . 13.519	$20^{\circ}$ . 17.396	$24^{\circ}$ . 22.211
$13^{\circ}$ . 11.130	$17^{\circ}$ . 14.409	$21^{\circ}$ . 18.505	$25^{\circ}$ . 23.582

TABLE OF THE DENSITY OF WATER AT TEMPERATURES  
BETWEEN  $0^{\circ}$  AND  $30^{\circ}$  C.

$0^{\circ}$ . 0.99988	$8^{\circ}$ . 0.99988	$16^{\circ}$ . 0.99900	$24^{\circ}$ . 0.99738
$1^{\circ}$ . 0.99993	$9^{\circ}$ . 0.99982	$17^{\circ}$ . 0.99884	$25^{\circ}$ . 0.99714
$2^{\circ}$ . 0.99997	$10^{\circ}$ . 0.99974	$18^{\circ}$ . 0.99866	$26^{\circ}$ . 0.99689
$3^{\circ}$ . 0.99999	$11^{\circ}$ . 0.99965	$19^{\circ}$ . 0.99847	$27^{\circ}$ . 0.99662
$4^{\circ}$ . 1.00000	$12^{\circ}$ . 0.99955	$20^{\circ}$ . 0.99827	$28^{\circ}$ . 0.99635
$5^{\circ}$ . 0.99999	$13^{\circ}$ . 0.99942	$21^{\circ}$ . 0.99806	$29^{\circ}$ . 0.99607
$6^{\circ}$ . 0.99997	$14^{\circ}$ . 0.99930	$22^{\circ}$ . 0.99785	$30^{\circ}$ . 0.99579
$7^{\circ}$ . 0.99994	$15^{\circ}$ . 0.99915	$23^{\circ}$ . 0.99762	

SYMBOLS AND ATOMIC WEIGHTS OF THE PRINCIPAL  
ELEMENTS<sup>1</sup>

Aluminium	Al	27.1	Fluorine	F	19.0	Oxygen	O	16.0
Antimony	Sb	120.2	Gold	Au	197.2	Phosphorus	P	31.0
Arsenic	As	75.0	Hydrogen	H	1.0	Platinum	Pt	194.8
Barium	Ba	137.4	Iodine	I	126.97	Potassium	K	39.15
Bismuth	Bi	208.5	Iron	Fe	55.9	Silver	Ag	107.93
Boron	B	11.0	Lead	Pb	206.9	Silicon	Si	28.4
Bromine	Br	79.96	Magnesium	Mg	24.36	Sodium	Na	23.05
Cadmium	Cd	112.4	Manganese	Mn	55.0	Strontium	Sr	87.6
Calcium	Ca	40.1	Mercury	Hg	200.0	Sulphur	S	32.06
Carbon	C	12.0	Nickel	Ni	58.7	Tin	Sn	119.0
Chlorine	Cl	35.45	Nitrogen	N	14.04	Tungsten	W	184.0
Copper	Cu	63.6	Osmium	Os	191.0	Zinc	Zn	65.4

<sup>1</sup> The above atomic weights are taken on the basis that O = 16; that of hydrogen will then be 1.008.

# ELEMENTARY COURSE

## LESSON I

### THE ELEMENTS CONTAINED IN PHYSIOLOGICAL COMPOUNDS

1. TAKE a fragment of meat about the size of a pea and place it in a porcelain crucible over a Bunsen flame. Note that it chars, showing the presence of carbon, and that it gives off the unpleasant odour of burning flesh, which is due to the fact that it contains the nitrogenous substances called proteins. In course of time the organic material is completely burnt up, and a small amount of white ash or inorganic material is left behind.

2. Repeat the experiment with a pure organic substance like sugar. Note that no ash is left. Charring, as before, indicates the presence of carbon, but there is no characteristic smell of burning nitrogenous substances (absence of nitrogen).

3. The tests for carbon depend on the fact that when this element is oxidised it gives rise to carbon dioxide; the test for hydrogen depends on the fact that when this element is oxidised it gives rise to water. If all the carbon dioxide and water formed by oxidation from a weighed amount of any organic substance under examination are collected and estimated, the amount of carbon and hydrogen respectively which it contains can be easily calculated. The following exercises, however, deal only with the qualitative detection of these elements.

4. *Tests for Carbon.*—The following tests can be carried out with sugar.

(a) When burnt in the air it chars and subsequently the carbon entirely disappears, passing off in combination with oxygen as carbon dioxide (carbonic acid gas).

(b) Mix some of the powdered sugar in a dry mortar with about ten times the quantity of cupric oxide (which has been freed from water by previous heating); place the mixture in a dry test-tube provided with a rubber cork perforated by a bent glass tube which dips into either lime water or baryta water. Heat the tube over a Bunsen flame, and as the carbon of the sugar becomes oxidised carbon dioxide comes off and causes a white precipitate of calcium or barium carbonate, as the case may be.

5. *Test for Hydrogen.*—In the experiment just described (4 b) note that drops of water due to oxidation of hydrogen condense in the colder parts of the test-tube.

6. *Tests for Nitrogen.*—The greater number of tests for this element are due to the circumstance that on the breaking up of organic substances which contain it, it is given off as ammonia. If the ammonia is all collected and estimated, the amount of nitrogen can be easily calculated. Kjeldahl's method for carrying out this quantitative analysis is described in the Appendix. The following exercises, however, are qualitative only.

(a) The characteristic odour of burning flesh, horn, hair, feathers, &c., has been already noted, and, though only a rough test, is very trustworthy.

(b) Take a little dried albumin and mix it thoroughly in a mortar with about twenty times the amount of soda-lime and heat in a test-tube over a Bunsen flame. Ammonia comes off in the vapours produced, and may be recognised by (i.) its odour; (ii.) it turns moistened red litmus paper (held over the mouth of the tube) blue; (iii.) it gives off white fumes with a glass rod (held over the mouth of the tube) which has been dipped in hydrochloric acid.

(c) Mix some dried albumin with about ten times its weight of a mixture of equal parts of magnesium powder and anhydrous sodium carbonate. A small quantity of the mixture—such as would lie on the end of a penknife—is then carefully heated in a dry test-tube and finally heated more strongly for about half a minute to red heat. Dip the tube while still glowing into a beaker containing a few c.c. of distilled water; the tube will break and its contents mix with the water. Filter and label the filtrate A; add to this filtrate a little strong solution of potash, one or two drops of cold saturated solution of ferrous sulphate and a drop of ferric chloride solution. Bring the mixture to boiling point, then cool and acidify with hydrochloric acid. The fluid becomes bluish green, and gradually a precipitate of Prussian blue separates out. This test is due to the fact that some of the nitrogen is fixed as sodium cyanide, and this gives the Prussian blue reaction with the reagents added.

7. *Tests for Sulphur.*—(a) In the foregoing test (6 c) the sulphur of the albumin combines with the sodium to form sodium sulphide. This may be detected by taking some of the filtrate A and adding freshly prepared solution of sodium nitro-prusside; a reddish violet colour forms.

(b) *Test for loosely combined Sulphur.*—Add two drops of a neutral lead acetate solution to a few c.c. of caustic soda solution. The precipitate of lead hydroxide which is first formed soon dissolves. Heat a small portion of the albumin with this alkaline solution. The mixture turns black in consequence of the formation of lead sulphide, part of the sulphur present in albumin in the unoxidised form having been split off from it by the caustic soda as sodium sulphide.

(c) Take some dried albumin and fuse with a mixture of potash and potassium nitrate. Cool; dissolve in water and filter. The filtrate will give the following tests for sulphates:—Acidulate with hydrochloric acid and add barium chloride; a white precipitate of barium sulphate is produced.

(d) Take some solution of albumin and heat in an open dish in a fume cupboard for at least an hour with large excess of fuming nitric acid, renewing the acid from time to time as necessary. The resulting fluid will give the test for sulphate as in c.

8. *Test for Phosphorus.*—The two tests just described (7 c and d) may be repeated with some substance (such as caseinogen, nucleoprotein, or lecithin) which contains phosphorus in organic combination; or the organic matter may be more conveniently destroyed by Neumann's method, which consists in heating it with a mixture of sulphuric and nitric acids. The resulting fluid in each case gives the following test for phosphates:—Mix it with half its volume of nitric acid; add ammonium molybdate in excess and boil; a yellow crystalline precipitate falls.

The reactions described in the foregoing exercises show how the processes of pure chemistry may be employed for the detection of some of the most important elements that occur in substances of physiological importance, and thus form a fitting introduction to a study of physiological chemistry.



They show, in the first instance, how the substances with which we have to deal fall under the two main categories of organic and inorganic. In some of the tissues of the body, like bone and tooth, the inorganic or mineral material is in excess, but in the softer portions of the organism the organic compounds are in great preponderance.

Organic chemistry is sometimes defined as the chemistry of the carbon compounds; carbon is in all cases present, and is usually the most abundant element.

The most important of the nitrogenous substances are the proteins, as already explained in the introductory chapter, and the detection and estimation of nitrogen are thus exercises of the highest interest.

All the proteins contain a small amount of sulphur; keratin, or horny material, contains more than most of them do.

Phosphorus is another element of considerable importance, being present in nuclein and nucleo-proteins, and also in certain complex fats, of which lecithin may be taken as a type. Iodine occurs united to protein material in the colloid substance of the thyroid gland; iron in the pigment of the blood called hæmoglobin; sodium, calcium, potassium, and other metals in the inorganic substances of the body. It would, however, lead us too far into the regions of pure chemistry to undertake exercises for the detection of these and other elements which might be mentioned, and have been already commented upon. The teacher of physiological chemistry is bound to assume that the students who come before him have already passed through a course of ordinary chemistry.

The main interest of the exercises selected as types lies in their physiological application. As a rule an element is detected by breaking up or oxidising the more or less complex molecule in which it occurs into substances of simpler nature, and then performing tests for these simpler products. Thus carbon is identified by the formation of carbon dioxide, nitrogen by the formation of ammonia, and so forth.

A great many reactions which can be performed in the test-tube imitate those which are performed in the body. Reactions *in vitro* and *in vivo*, to use the technical phrases, often, though not always, run parallel. Life, from one point of view, is a process of combustion or oxidation; the fuel is supplied by the food; this becomes assimilated, and so forms an integral part of the living substance of the body; it is then burnt up by the oxygen brought to it by the blood-stream, giving rise to animal heat and other manifestations of

energy ; and finally the simple products of oxidation or chemical breakdown are carried to the organs of excretion (lung, skin, kidney, &c.), where they are discharged from the body.

A candle consists principally of carbon and hydrogen ; when it is burnt the products are carbonic acid gas and water ; the former may be detected by means of lime water, the latter, by holding a dry beaker upside down for a few moments over the burning candle, when the moisture will condense on the cold glass.

The body is more complex than a candle, but so far as its carbon and hydrogen are concerned the main products of combustion are the same. The carbon dioxide is discharged by the expired air, as may be proved by blowing it into lime water. The water finds an outlet by several channels, lungs, skin, and kidneys. The presence of nitrogen in the body is perhaps the most striking chemical distinction between it and a candle, and here again the process of metabolism runs a course analogous in some degree to our experiments *in vitro*. Here again the most important and abundant substance which contains the waste nitrogen is the simple material ammonia, but ammonia is only discharged as such to a very small extent in health. It unites with carbon and oxygen to form the body called urea ( $\text{CON}_2\text{H}_4$ ), which finds its way out of the body *via* the urine. The urine also contains the sulphates, due to the oxidation of the sulphur of the proteins, and the phosphates due to the similar oxidation of the phosphorus of such substances as lecithin and nuclein. Some of the salts of the urine, however, in particular the chlorides, come directly from the food. This we shall discuss at the proper place when we come to the study of the urine.

## LESSON II

### THE CARBOHYDRATES

1. NOTE the general appearance of the specimens of grape sugar or dextrose, cane sugar, dextrin, and starch which are given round.

2. Put some of each into cold water. Starch is insoluble; dextrose, cane sugar, and dextrin dissolve after a time, but more readily in hot water.

3. *Trommer's test*.—Put a few drops of copper sulphate solution into a test-tube, then solution of dextrose, and then strong caustic potash. On adding the caustic potash a precipitate is first formed, which, owing to the presence of the sugar, rapidly redissolves, forming a blue solution. On boiling this a yellow or red precipitate (cuprous hydrate or oxide) forms.

4. *Fehling's test*.—Fehling's solution is a mixture of copper sulphate, caustic soda, and Rochelle salt of a certain strength. It is used for estimating dextrose quantitatively (see Lesson XII.). It may be used as a qualitative test also. Boil some Fehling's solution; if it remains clear it is in good condition; add to it an equal volume of solution of dextrose and boil again. Reduction, resulting in the formation of cuprous hydrate or oxide, takes place as in Trommer's test.

5. *Moore's test*.—Add to the dextrose solution about half its volume of 20-per-cent. potash and heat. The solution becomes yellowish brown. Add to this some sulphuric acid (25 per cent.) and the odour of caramel becomes apparent.

6. *Fermentation test*.—Add a fragment of dried yeast to the dextrose solution in a test-tube; fill the test-tube up with mercury, and invert it over mercury in a trough. Place it in an incubator at body temperature for 24 hours. The sugar is broken up into alcohol and carbon dioxide; the latter gas collects in the upper part of the test-tube.

7. *Cane Sugar*.—(a) The solution of cane sugar when mixed with copper sulphate and caustic potash gives a blue solution. But on boiling no reduction occurs.

(b) Take some of the cane-sugar solution and boil it with a few drops of 25-per-cent. sulphuric acid. This converts it into equal parts of dextrose and levulose. It then gives Trommer's or Fehling's test in the typical way.

(c) Boil some of the cane-sugar solution with an equal volume of concentrated hydrochloric acid. A deep red solution is formed. Dextrose, lactose, and maltose do not give this test.

8. *Starch*.—(a) Examine microscopically the scrapings from the surface of a freshly cut potato. Note the appearance of the starch grains with their concentric markings.

(b) On boiling starch with water an opalescent solution is formed, which, if strong, gelatinises on cooling.

(c) Add iodine solution. An intense blue colour is produced, which disappears on heating, and if not heated too long reappears on cooling. N.B.—Prolonged heating drives off the iodine, and consequently no blue colour returns after cooling.

(d) Conversion into dextrin and dextrose. To some starch solution in a flask add a few drops of 25-per-cent. sulphuric acid, and boil for 15 minutes. Take some of the liquid, which is now clear, and show the presence of dextrin and dextrose.

9. *Dextrin*.—Add iodine solution to solution of dextrin; a reddish-brown colour is produced. The colour disappears on heating and reappears on cooling.

10. *Glycogen*.—Solution of glycogen is given round: (a) it is opalescent like that of starch.

(b) With iodine solution it gives a brown colour very like that given by dextrin. The colour disappears on heating and reappears on cooling.

(c) By boiling with 25-per-cent. sulphuric acid for 15 to 20 minutes it is converted into grape sugar.

**The carbohydrates** are found chiefly in vegetable tissues, and many of them form important foods. Some carbohydrates are, however, found in or formed by the animal organism. The most important of these are *glycogen*, or animal starch; *dextrose*; and *lactose*, or milk sugar.

The carbohydrates may be conveniently defined as compounds of carbon, hydrogen, and oxygen, the two last named elements being in the proportion in which they occur in water. But this definition is only a rough one, and if pushed too far would include many substances, like acetic acid, lactic acid, and inosite, which are not carbohydrates. Research has shown that the chemical constitution of the simplest carbohydrates is that of an aldehyde, or a ketone, and that the more complex carbohydrates are condensation products of the simple ones. In order, therefore, that we may understand the constitution of these substances, it is first necessary that we should understand what is meant by the terms aldehyde and ketone.

A primary alcohol is one in which the hydroxyl (OH) is attached to the last carbon atom of the chain; its end group is CH<sub>2</sub>OH. Thus the formula for common alcohol (primary ethyl alcohol) is



The formula for the next alcohol of the same series (primary propyl alcohol) is

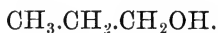

If a primary alcohol is oxidised, the first oxidation product is called an *aldehyde*; thus ethyl alcohol yields acetic aldehyde:—

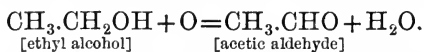

The typical end-group CHO of the aldehyde is not stable, but is easily oxidisable to form the group COOH, and the compound so formed is called an acid; in this way acetic aldehyde forms acetic acid:—

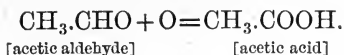

The majority of the simple sugars are aldehydes of more complex alcohols than this: they are spoken of as *aldoses*. The readiness with which aldehydes are oxidisable renders them powerful reducing agents, and this furnishes us with some of the tests for the sugars.

Let us now turn to the case of the ketones. A secondary alcohol is one in which the OH group is attached to a central carbon atom; thus secondary propyl alcohol has the formula



Its typical group is therefore CHOH. When this is oxidised, the first oxidation product is called a ketone, thus:—

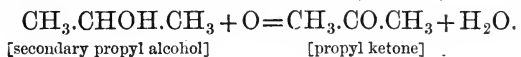

It therefore contains the group CO in the middle of the chain. Some of the sugars are ketones of more complex alcohols: these are called *ketoses*. The only one of these which is of physiological interest is levulose.

The alcohols of which we have already spoken are called *monatomic*, because they contain only one OH group. Those which contain two OH groups (like glycol) are called *diatomic*; those which contain three OH groups (like glycerin) are called *triatomic*; and so on. The hexatomic alcohols are those which contain six OH groups. Three of these hexatomic alcohols with the formula  $\text{C}_6\text{H}_8(\text{OH})_6$  are of physiological interest; they are isomerides, and their names are sorbite, mannite, and dulcite. By careful oxidation their aldehydes and ketones can be obtained; these are the simple sugars; thus, dextrose is the aldehyde of sorbite; mannose is the aldehyde of mannite; levulose is the ketone of mannite; and galactose is the aldehyde of dulcite. The sugars all have the empirical formula  $\text{C}_6\text{H}_{12}\text{O}_6$ . The constitutional formula for dextrose is:—

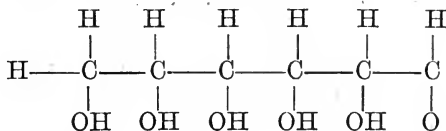

By further oxidation, the sugars yield acids with various names. If we take such a sugar as a typical specimen, we see that their general formula is



and as a general rule  $n=m$ ; that is, the number of oxygen and carbon atoms is equal. This number in the case of the sugars already mentioned is six. Hence they are called *hexoses*.

Sugars are known to chemists, in which this number is 3, 4, 5, 7, &c., and these are called trioses, tetroses, pentoses, heptoses, &c. The majority of these have no physiological interest. It should, however, be mentioned that a pentose has been obtained from the nucleoprotein of the pancreas, of the liver, and of yeast. If the pentoses that are found in various plants are given to an animal, they are excreted in great measure unchanged in the urine.

The hexoses are of great physiological importance. The principal ones are dextrose, levulose, and galactose. These are called *monosaccharides*.

Another important group of sugars is that of the *disaccharides*: these are formed by the combination of two molecules of monosaccharide together with the loss of a molecule of water, thus:—

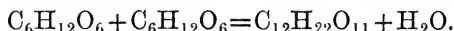

The principal members of the disaccharide group are cane sugar, lactose, and maltose.

If more than two molecules of the monosaccharide group undergo a corresponding condensation, we get what are called *polysaccharides*.



The polysaccharides are starch, glycogen, various dextrins, cellulose, gums, &c. We may therefore arrange the important carbohydrates of the hexose family in a tabular form as follows:—

1. Monosaccharides or Glucoses, $C_6H_{12}O_6$	2. Disaccharides, Sucroses, or Saccharoses, $C_{12}H_{22}O_{11}$	3. Polysaccharides or Amyloses ( $C_6H_{10}O_5$ ) $_n$
+ Dextrose. - Levulose. + Galactose.	+ Cane sugar. + Lactose. + Maltose.	+ Starch. + Glycogen. + Dextrin. Cellulose.

The signs + and - in the above list indicate that the substances to which they are prefixed are dextro- and levo-rotatory respectively as regards polarised light.<sup>1</sup> The formulæ given above are merely empirical; the quantity  $n$  in the starch group is variable and often large. The following are the chief facts in relation to each of the principal carbohydrates.

<sup>1</sup> For a description of polarised light and polarimeters see Appendix. This and the other matter in the Appendix are placed there for convenience, not because they are unimportant. Students are therefore urged to refer to and carefully study these subjects.

## MONOSACCHARIDES

**Dextrose or Grape Sugar.**—This carbohydrate is found in fruits, honey, and in minute quantities in the blood (0.12 per cent.) and numerous tissues, organs, and fluids of the body. It is the form of sugar found in large quantities in the blood and urine in the disease known as diabetes.

Dextrose is soluble in hot and cold water and in alcohol. It is crystalline (see fig. 1), but not so sweet as cane sugar. When heated with strong potash certain complex acids are formed which have a yellow or brown colour. This constitutes *Moore's test* for sugar. In alkaline solutions dextrose reduces salts of silver, bismuth, mercury, and copper. The reduction of cupric hydrate to cuprous hydrate or oxide constitutes *Trommer's test*, which has been already described at the head of the lesson. On boiling it with an alkaline solution of picric acid, a dark red opaque solution due to reduction of the picric to picramic acid is produced. Another important property of grape sugar is that under the influence of yeast it is converted into alcohol and carbonic acid ( $C_6H_{12}O_6 = 2C_2H_6O + 2CO_2$ ).

Dextrose may be estimated by the fermentation test, by the polarimeter, and by the use of Fehling's solution. The last method is the most important: it rests on the same principles as Trommer's test, and we shall study it and other methods of estimating sugar in connection with diabetic urine (see Lesson XII.).

**Levulose.**—When cane sugar is treated with dilute mineral acids it undergoes a process known as inversion—*i.e.* it takes up water and is converted into equal parts of dextrose and levulose. The previously dextro-rotatory solution of cane sugar then becomes levo-rotatory, the levo-rotatory power of the levulose being greater than the dextro-rotatory power of the dextrose formed. Hence the term *inversion*. The same hydrolytic change is produced by certain ferments, such as the invert ferment of the intestinal juice, and of yeast.

Pure levulose can be crystallised, but so great is the difficulty of obtaining crystals of it that one of its names was 'uncrystallisable sugar.' Small quantities of levulose have been found in blood, urine, and muscle. It has been recommended as an article of diet in diabetes in place of ordinary sugar; in this disease it does not

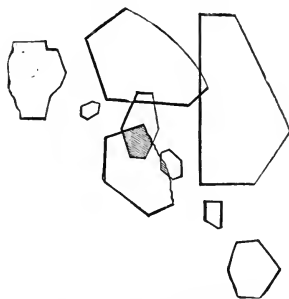

FIG. 1.—Dextrose crystals.

appear to have the harmful effect that other sugars produce. Levulose gives the same general reactions as dextrose.

**Galactose** is formed by the action of dilute mineral acids or inverting ferments on lactose or milk sugar. It resembles dextrose in being dextro-rotatory, in reducing cupric hydrate in Trommer's test, and in being directly fermentable with yeast. When oxidised by means of nitric acid it, however, yields an acid called mucic acid ( $C_6H_{10}O_8$ ), which is only sparingly soluble in water. Dextrose when treated in this way yields an isomeric acid—*i.e.* an acid with the same empirical formula, called saccharic acid, which is readily soluble in water.

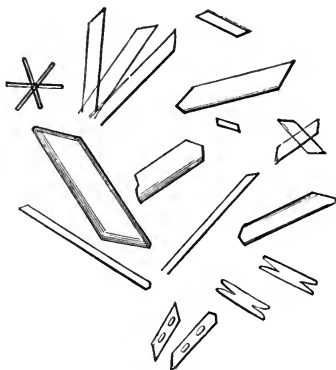

FIG. 2.—Inosite crystals.

**Inosite**, formerly called muscle sugar, is found in muscle, kidney, liver, and other parts of the body in small quantities. It is also largely found in the vegetable kingdom. It is a crystallisable substance (see fig. 2) and has the same formula ( $C_6H_{12}O_6$ ) as the glucoses. It is, however, not a sugar. It gives none of the sugar tests, and careful analysis has shown it has quite a different chemical constitution from the true sugars. It belongs to the aromatic series, and is only included here for convenience.

#### DISACCHARIDES

**Cane Sugar.**—This sugar is generally distributed throughout the vegetable kingdom in the juices of plants and fruits, especially the sugar cane, beetroot, mallow, and sugar maple. It is a substance of great importance as a food. After abundant ingestion of cane sugar traces may appear in the urine, but the greater part undergoes inversion in the alimentary canal.

Pure cane sugar is crystalline and dextro-rotatory. It holds cupric hydrate in solution in an alkaline liquid—that is, with Trommer's test it gives a blue solution. But no reduction occurs on boiling. After inversion it is strongly reducing.

Inversion may be brought about readily by boiling with dilute mineral acids, or by means of an inverting ferment, such as that occurring in the succus entericus or intestinal juice. It then takes up water and is split into equal parts of dextrose and levulose:—

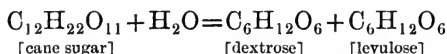



With yeast, cane sugar is first inverted by means of a special soluble ferment produced by the yeast cells, and then there is an alcoholic fermentation of the glucoses so formed.

**Lactose**, or **milk sugar**, occurs in milk. It has also been described as occurring in the urine of women in the early days of lactation or after weaning.

It crystallises in rhombic prisms (see fig. 3). It is much less soluble in water than cane sugar or dextrose, and has only a slightly sweet taste. It is insoluble in alcohol and ether; aqueous solutions are dextro-rotatory.

Solutions of lactose give Trommer's test, but when the reducing power is tested quantitatively by Fehling's solution it is found to be a less powerful reducing agent than dextrose. If it required seven parts of a solution of dextrose to reduce a given quantity of Fehling's solution, it would require ten parts of a solution of lactose of the same strength to reduce the same quantity of Fehling's solution.

Lactose, like cane sugar, can be hydrolysed by the same agencies as those already enumerated in connection with cane sugar. The glucoses formed are dextrose and galactose,

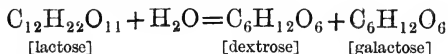

With yeast it is first inverted, and then alcohol is formed. This, however, occurs slowly.

With the lactic-acid organisms which bring about the souring of milk the lactic-acid fermentation is produced. This may also occur as the result of the action of putrefactive bacteria in the alimentary canal. The two stages of the lactic-acid fermentation are represented by the following equations :—

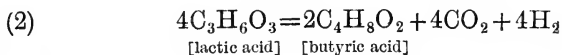
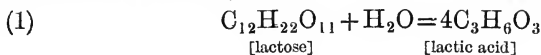

**Maltose** is the chief end product of the action of malt diastase on starch, and is also formed as an intermediate product in the action of dilute sulphuric acid on the same substance. It is also the chief sugar formed from starch by the diastatic ferments contained in the saliva (ptyalin) and pancreatic juice (amylpsin). It can be obtained

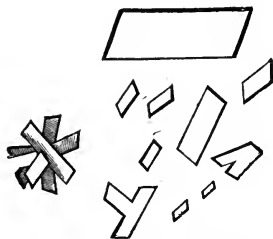
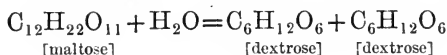

FIG. 3.—Milk-sugar crystals.

in form of acicular crystals; it is strongly dextro-rotatory. It gives Trommer's test; but its reducing power, as measured by Fehling's solution, is one-third less than that of dextrose.

By prolonged boiling with water, or, more readily, by boiling with a dilute mineral acid, or by means of an inverting ferment, such as occurs in the intestinal juice, it is converted into dextrose.



It undergoes readily the alcoholic fermentation.

The three important physiological sugars (dextrose, lactose, and maltose) may be distinguished from one another by their relative reducing action on Fehling's solution (1·0 : 0·71 : 0·63), by their rotatory power, or by the phenyl-hydrazine test described in Lesson XIII.

#### POLYSACCHARIDES

**Starch** is widely diffused through the vegetable kingdom. It occurs in nature in the form of microscopic grains, varying in size and appearance, according to their source. Each consists of a central spot (*hilum*) round which more or less concentric envelopes of starch proper or granulose alternate with layers of cellulose. Cellulose has very little digestive value, but starch is a most important food.

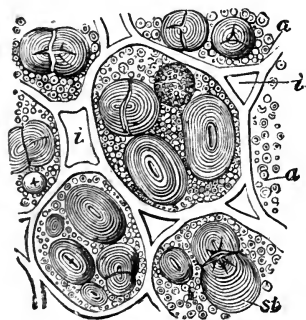

FIG. 4.—Section of pea showing starch and aleurone grains embedded in the protoplasm of the cells: *a*, aleurone grains; *st*, starch grains; *z*, intercellular spaces. (Yeo, after Sachs.)

Starch is insoluble in cold water: it forms an opalescent solution in boiling water, which if concentrated gelatinises on cooling. Its most characteristic reaction is the blue colour it gives with iodine solution.

On heating starch with dilute mineral acids dextrose is formed. By the action of diastatic ferments, maltose is the chief end product. In both cases dextrin is an intermediate stage in the process.

Before the formation of dextrin the starch solution loses its opalescence, a substance called *soluble starch* or *amidulin* being formed. This, like native starch, gives a blue colour with iodine solution. Although the molecular weight of starch is unknown, the formula for soluble starch is probably  $(\text{C}_6\text{H}_{10}\text{O}_5)_{200}$ . Equations that represent the formation of sugars and dextrins from this are very complex, and are at present hypothetical.

**Dextrin** is the name given to the intermediate products in the hydrolysis of starch, and two chief varieties are distinguished—*erythro-dextrin*, which gives a reddish-brown colour with iodine solution; and *achroö-dextrin*, which does not.

It is readily soluble in water, but insoluble in alcohol and ether. It is gummy and amorphous. It does not give Trommer's test, nor does it ferment with yeast. It is dextro-rotatory. By hydrating agencies it is converted into glucose.

**Glycogen**, or animal starch, is found in liver, muscle, colourless blood corpuscles and other tissues.

Glycogen is a white tasteless powder, soluble in water, but it forms, like starch, an opalescent solution. It is insoluble in alcohol and ether. It is dextro-rotatory. With Trommer's test it gives a blue solution, but no reduction occurs on boiling.

With iodine solution it gives a reddish or port-wine colour, very similar to that given by erythro-dextrin. Dextrin may be distinguished from glycogen by (1) the fact that it gives a clear, not an opalescent, solution with water; and (2) it is not precipitated by basic lead acetate as glycogen is. It is, however, precipitated by basic lead acetate and ammonia. (3) Glycogen is precipitated by 55 per cent. of alcohol; the dextrins require 85 per cent. or more.

**Cellulose.**—This is the colourless material of which the cell-walls and woody fibres of plants are composed. By treatment with strong mineral acids, it is like starch, converted into glucose, but with much greater difficulty. The various digestive ferments have little or no action on cellulose; hence the necessity of boiling starch before it is taken as food. Boiling bursts the cellulose envelope of the starch grains, and so allows the digestive juice to get at the starch proper. Cellulose is found in a few animals, as in the test or outer investment of the Tunicates.

*Salting out of the Colloid Carbohydrates.*—By saturating solutions of the colloid carbohydrates (starch, soluble starch, glycogen, and some varieties of dextrin) with such neutral salts as magnesium sulphate or ammonium sulphate the carbohydrate is thrown out of solution in the form of a white precipitate. The remaining carbohydrates (sugars and some of the smaller moleculéd dextrins like achroö-dextrin) are not precipitated by this means. We shall find in connection with the proteins that this method, known as 'salting out,' is one largely employed there for precipitating and distinguishing between classes of proteins. The student is therefore warned that a precipitate obtained under such circumstances will not necessarily indicate the presence of protein.

Further information regarding the carbohydrates is given in Lesson XIII.

## LESSON III

### THE FATS

LARD and olive oil are given round as examples of fats.

1. They are insoluble in water.

2. They dissolve readily in ether. On pouring some of the ethereal solution on to a piece of blotting paper, a greasy stain is left after the ether has evaporated.

3. *Saponification*.—By boiling with potash, fat yields a solution of soap. On adding some sulphuric acid to this and heating, the fatty acid collects in a layer on the surface of the fluid. This experiment may conveniently be performed in the following way:—Melt some lard in an evaporating basin and pour it into a solution of potash in alcohol<sup>1</sup> contained in a small flask and heated carefully on a *water-bath* nearly to boiling-point. Continue to boil and saponification is soon completed. When the process is completed drop some of the solution into a test-tube containing about 10 c.c. of water; the solution of soap will be clear, and no oil globules should separate out. If there is any separation of oil globules continue the boiling.

Then drop the soap solution into some 25-per-cent. sulphuric acid contained in a small beaker and heated nearly to boiling; the fatty acid soon separates out and floats on the surface.

4. *Reaction of Fatty Acids*.—(a) They produce a greasy stain on paper.

(b) Wash the fatty acid obtained in experiment 3 repeatedly with water, until the wash water is no longer acid, and divide it into two portions. Dissolve one portion in ether; this solution reacts acid to phenolphthalein; to show this, place a few drops of phenolphthalein in 5 c.c. of water containing a drop of 20-per-cent. potash. If this red solution is dropped into the solution of fatty acid, the colour is discharged. Place the second portion of fatty acid in some half-saturated solution of sodium carbonate and warm; a solution of sodium soap is obtained and carbon dioxide comes off.

5. *Separation of Neutral Fats from Fatty Acids*.—In most fats some free fatty acid is present. They may be separated by the fact that the latter only dissolves in a solution of sodium carbonate to form soap. The resulting mass is shaken with water and then with ether; the two fluids separate on standing; the ether contains the neutral fat and the water the soap.

6. *Test for Glycerin*.—The most important reaction for glycerin, the other constituent of a fat, is the acrolein test, which is performed in the following way:—Place some lard in a dry test-tube, add a crystal of potassium sulphate and heat. Acrolein is given off, which is recognised by its characteristic unpleasant odour, and by the fact that it blackens a piece of filter paper previously moistened with ammoniacal silver nitrate solution.

7. *Osmic Acid Test*.—Fat, if it contains olein or oleic acid, is blackened by osmic acid. Try this with both the lard and the olive oil.

<sup>1</sup> 30 grammes of potash are dissolved in 20 c.c. of water, and 200 c.c. of 90-per-cent. alcohol added.

8. To determine melting-point of a fat or fatty acid, place a small quantity in a very narrow test-tube strapped on to a thermometer with an india-rubber band. Place this in a water-bath which is gradually heated, and note the temperature at which it melts.

9. *Emulsification.*—(a) Take two test-tubes and label them A and B. Place water in A and soap solution in B. To each add a few drops of olive oil and shake. In B an emulsion is formed, but not in A.

(b) Shake a few drops of rancid oil with a dilute solution of potash; an emulsion is formed because the potash and free fatty acid unite to form a soap. Divide this into two parts, and to one of them add a little solution of gum or egg albumin; the emulsion is much more permanent in this specimen. These experiments illustrate the favourable action of soap and of a *suspending medium* like mucilage upon the formation of an emulsion.

**Fat** is found in small quantities in many animal tissues. It is, however, found in large quantities in three situations, viz. bone

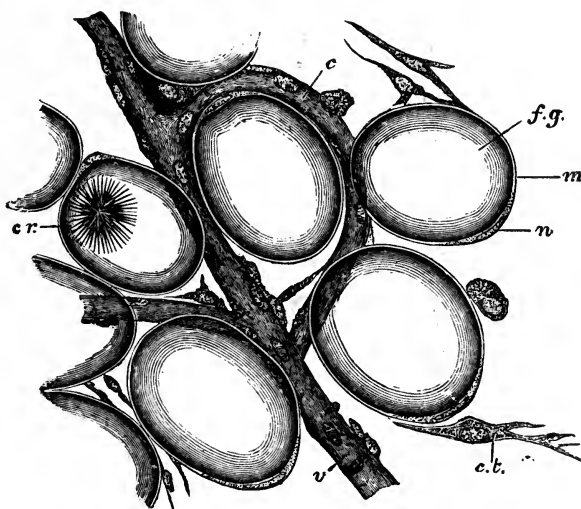

FIG. 5.—A few cells from the margin of a fat lobule; *f. g.*, fat globule distending fat cell; *n*, nucleus; *m*, membranous envelope of the cell; *c. r.*, bunch of crystals within a fat cell; *c*, capillary vessel; *v*, venule; *c. t.*, connective tissue cell. The fibres of the connective tissue are not represented.

marrow, adipose tissue, and milk. The consideration of the fat in milk is postponed to Lesson VI.

The contents of the fat cells of adipose tissue are fluid during life, the normal temperature of the body ( $37^{\circ}$  C., or  $99^{\circ}$  F.) being considerably above the melting-point ( $25^{\circ}$  C.) of the mixture of the fats found there. These fats are three in number, and are called palmitin, stearin, and olein. They differ from one another in chemical composition and in certain physical characters, such as melting-point and solubilities. Olein melts at  $-5^{\circ}$  C., palmitin at  $45^{\circ}$  C., and stearin at  $53-65^{\circ}$  C. Thus, it is olein which holds the other two dissolved at

the body temperature. Fats are all soluble in hot alcohol, ether, and chloroform, but insoluble in water.

**Chemical Constitution of the Fats.**—The fats are compounds of fatty acids with glycerin, and may be termed glycerides or glyceric ethers.

The fatty acids form a series of acids derived from the monatomic alcohols by oxidation. Thus, to take ordinary ethyl alcohol,  $C_2H_5HO$ , the first stage in oxidation is the removal of two atoms of hydrogen to form aldehyde,  $CH_3.CO$ : on further oxidation an atom of oxygen is added to form acetic acid,  $CH_3.COOH$  (see also p. 14).

A similar acid can be obtained from all the other alcohols, thus:

From methyl alcohol	$CH_3.HO$ ,	formic acid	$H.CO$	is obtained
„ ethyl	„ $C_2H_5.HO$ ,	acetic	„ $CH_3.CO$	„
„ propyl	„ $C_3H_7.HO$ ,	propionic,	„ $C_2H_5.CO$	„
„ butyl	„ $C_4H_9.HO$ ,	butyric	„ $C_3H_7.CO$	„
„ amyl	„ $C_5H_{11}.HO$ ,	valeric	„ $C_4H_9.CO$	„
„ hexyl	„ $C_6H_{13}.HO$ ,	caproic	„ $C_5H_{11}.CO$	„

and so on.

Or in general terms:—

From the alcohol with formula  $C_nH_{2n+1}.HO$  the acid with formula  $C_{n-1}H_{2n-1}.CO.OH$  is obtained. The sixteenth term of this series has the formula  $C_{15}H_{31}.CO.OH$ , and is called **palmitic acid**; the eighteenth has the formula  $C_{17}H_{35}.CO.OH$ , and is called **stearic acid**. Each acid, as will be seen, consists of a radical,  $C_{n-1}H_{2n-1}CO$ , united to hydroxyl (HO).

**Oleic acid**, however, is not a member of the fatty acid series proper, but belongs to a somewhat similar series of acids known as the acrylic series, of which the general formula is  $C_{n-1}H_{2n-3}COOH$ . It is the eighteenth term of the series, and its formula is  $C_{17}H_{33}.CO.OH$ .

The first member of the group of alcohols from which this acrylic series of acids is obtained is called *allyl alcohol* ( $CH_2:CH.CH_2OH$ ); the aldehyde of this is *acrolein* ( $CH_2:CH.CHO$ ), and the formula for the acid (acrylic acid) is  $CH_2:CH.COOH$ . It will be noticed that two of the carbon atoms are united by two valencies, and these bodies are therefore unsaturated; they are unstable and are prone to undergo by uniting with another element a conversion into bodies in which the carbon atoms are united by one bond only. This accounts for their reducing action, and it is owing to this construction that the colour reactions with osmic acid and Sudan III. are due. Fat which contains any member of the acrylic series like oleic acid blackens osmic acid, by reducing it to a lower (black) oxide. Fats like palmitin and stearin do not give this reaction.

**Glycerin** or **Glycerol** is a triatomic alcohol,  $C_3H_5(OH)_3$ —*i.e.* three atoms of hydroxyl united to a radical glyceryl ( $C_3H_5$ ). The hydrogen in the hydroxyl atoms is replaceable by other organic radicals. As an example take the radical of acetic acid called acetyl ( $CH_3.CO$ ). The following formulæ represent the derivatives that can be obtained by replacing one, two, or all three hydroxyl hydrogen atoms in this way:—

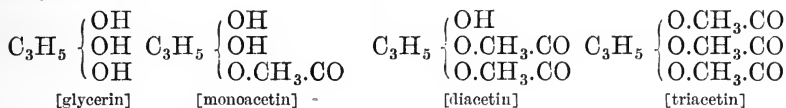

Triacetin is a type of a neutral fat; stearin, palmitin, and olein ought more properly to be called tristearin, tripalmitin, and triolein respectively. Each consists of glycerin in which the three atoms of hydrogen in the hydroxyls are replaced by radicals of the fatty acid. This is represented in the following formulæ:—

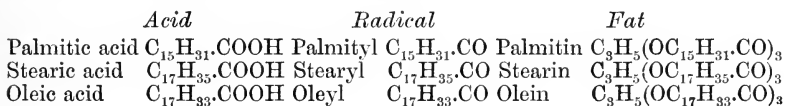

**Decomposition Products of the Fats.**—The fats split up into the substances out of which they are built up.

Under the influence of superheated steam, mineral acids, and in the body by means of certain ferments (for instance, the fat-splitting ferment steapsin of the pancreatic juice), a fat combines with water and splits into glycerin and the fatty acid. The following equation represents what occurs in a fat, taking tripalmitin as an example:—

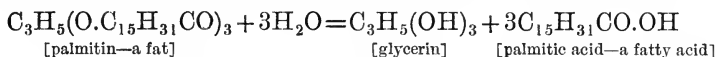

In the process of saponification, much the same sort of reaction occurs, the final products being glycerin and a compound of the base with the fatty acid, which is called a soap. Suppose, for instance, that potassium hydrate is used; we get—

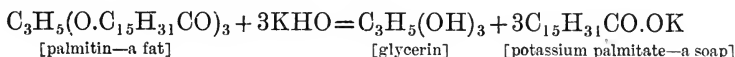

**Emulsification.**—Another change that fats undergo in the body is very different from saponification. It is a physical rather than a chemical change; the fat is broken up into very small globules, such as are seen in the natural *emulsion*—milk.

**Lecithin** ( $C_{42}H_{84}NPO_9$ ).—This is a very complex fat, which

yields on decomposition not only glycerin and a fatty acid, but phosphoric acid, and an alkaloid  $[N.(CH_3)_3C_2H_6O_2]$  called *choline* in addition. Lecithin is found to a great extent in the nervous system,<sup>1</sup> and to a small extent in bile. Together with **cholesterin**, a crystallisable, monatomic alcohol ( $C_{27}H_{45}.HO$ ) which we shall consider more at length in connection with the bile, it is found in small quantities in the protoplasm of all cells.

<sup>1</sup> See further under Nervous Tissues, Lesson XXII.



## LESSON IV

### THE PROTEINS

1. **Tests for Proteins.**—The following tests are to be tried with a mixture of one part of white of egg to ten of water. (Egg-white contains a mixture of albumin and globulin.)

(a) *Heat Coagulation.*—Faintly acidulate with a few drops of 2-per-cent. acetic acid and boil. The protein is rendered insoluble (coagulated protein).

(b) *Precipitation with Nitric Acid.*—The addition of strong nitric acid to the original solution also produces a white precipitate.

(c) *Xanthoproteic Reaction.*—On boiling the white precipitate produced by nitric acid it turns yellow; after cooling add ammonia; the yellow becomes orange.

(d) *Millon's Test.*—Millon's reagent (which is a mixture of the nitrates of mercury containing excess of nitric acid; see p. 5) gives a white precipitate, which turns brick-red on boiling.

(e) After the addition of a few drops of 20-per-cent. acetic acid, potassium ferrocyanide gives a white precipitate.

(f) *Rose's or Piotrowski's Test.*—Add *one drop* of a 1-per-cent. solution of cupric sulphate to the original solution and then caustic potash, and a violet solution is obtained.

Repeat experiment (f) with a solution of commercial peptone, and note that a rose-red solution is obtained. This is called the *biuret reaction*.

(g) *Rosenheim's Formaldehyde Reaction.*—Add to the solution of commercial peptone a very dilute solution of formaldehyde (1:2,500), and then about one third of the volume of strong sulphuric acid containing (as most commercial specimens of the acid do) a trace of an oxidising agent such as ferric chloride or nitrous acid. A purple ring develops at the surface of contact. This reaction probably plays a part in the original

(h) *Adamkiewicz Reaction*, in which glacial acetic acid was used instead of the formaldehyde. Most commercial specimens of glacial acetic acid contain hydrogen peroxide as an impurity; the oxidising action of this on the acetic acid leads to the formation of traces of glyoxylic acid and formaldehyde; the necessary factors for the occurrence of the formaldehyde reaction are thus present. (According to Hopkins glyoxylic acid itself with pure sulphuric acid gives the test with proteins.)

The same reactions (g and h) are given by the solution of egg-white, but not so markedly.

2. **Action of Neutral Salts.**—(a) Saturate the solution of egg-white with magnesium sulphate by adding crystals of the salt and grinding it up thoroughly in a mortar. A white precipitate of egg-globulin is produced. Filter. The filtrate contains egg-albumin. The precipitate of the globulin is very small.

(b) Half saturate the solution of egg-white with ammonium sulphate. This may be done by adding to the solution an equal volume of a saturated

solution of ammonium sulphate. The precipitate produced consists of the globulin; the albumin remains in solution.

(c) Completely saturate another portion with ammonium sulphate by adding crystals of the salt and grinding in a mortar—a precipitate is produced of both the globulin and albumin. Filter. The filtrate contains no protein.

(d) Repeat the last experiment (c) with a solution of commercial peptone. A precipitate is produced of the proteoses it contains. Filter. The filtrate contains the true peptone. This gives the biuret reaction (see above), but large excess of strong potash must be added on account of the presence of ammonium sulphate. *Ammonium sulphate added to saturation precipitates all proteins except peptone.*

## LESSON V

### THE PROTEINS (continued)

1.—*Action of Acids and Alkalis on Albumin.*—Take three test-tubes and label them A, B, and C.

In each place an equal amount of diluted egg-white, similar to that used in the last lesson.

To A add a few drops of 0·1-per-cent. solution of caustic potash.

To B add the same amount of 0·1-per-cent. solution of caustic potash.

To C add a rather large amount of 0·1-per-cent. sulphuric acid.

Put all three into the warm bath<sup>1</sup> at about the temperature of the body (36–40° C.).

After five minutes remove test-tube A, and boil. The protein is no longer coagulated by heat, having been converted into *alkali-albumin*. After

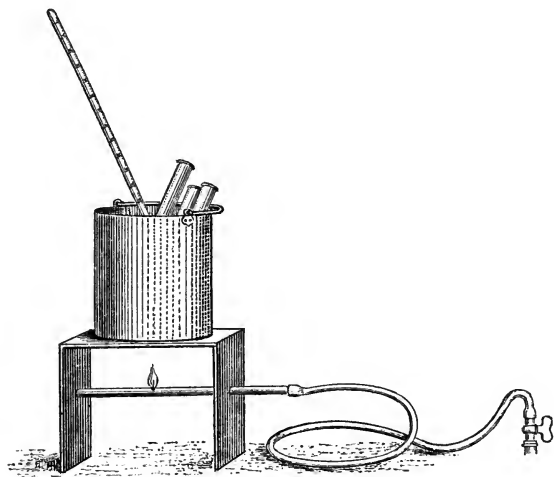

FIG. 6.—Simple warm bath, as described in footnote.

cooling, colour with litmus solution and neutralise with 0·1-per-cent. acid. At the neutral point a precipitate is formed which is soluble in excess of either acid or alkali.

Next remove B. This also now contains alkali-albumin. Add to it a few drops of sodium phosphate, colour with litmus, and neutralise as before.

<sup>1</sup> A convenient form of warm bath suitable for class purposes may be made by placing an ordinary tin pot half full of water over a bent piece of iron which acts as a warm stage as in the figure. The stage is kept warm by a small gas flame. Such a warm bath may be placed between every two or three students.

Note that the alkali-albumin now requires more acid for its precipitation than in A, the acid which is first added converting the sodium phosphate into acid sodium phosphate.

Now remove C from the bath. Boil it. Again there is no coagulation, the proteins having been converted into *acid-albumin*, or *syntonin*. After cooling, colour with litmus and neutralise with 0·1-per-cent. alkali. At the neutral point a precipitate is formed, soluble in excess of acid or alkali. (Acid-albumin is formed more slowly than alkali-albumin, so it is best to leave this experiment to the last.)

2. Take some gelatin and dissolve it in hot water. On cooling, the solution sets into a jelly (gelatinisation).

Take a dilute solution of gelatin, and try all the protein tests with it enumerated on p. 27. Carefully note down your results.

3. Add a few drops of acetic acid to some saliva. A stringy precipitate of mucin is formed.

4. A tendon has been soaked for a few days in lime water. The fibres are not dissolved, but they are loosened from one another owing to the solution of the interstitial or ground substance by the lime water. Take some of the lime-water extract and add acetic acid. A precipitate of mucoid is obtained. The fibres themselves consist of collagen, which yields gelatin on boiling. Vitreous humour or the Whartonian jelly of the umbilical cord is much richer in ground substance than tendon, and, if treated in the same way, a much larger yield of mucoid is obtained.

The **Proteins** are the most important substances that occur in animal and vegetable organisms, and *protein metabolism* is, as already noted, the most characteristic sign of life.

They are highly complex compounds of carbon, hydrogen, oxygen, nitrogen, and sulphur occurring in a solid viscous condition, or in solution in nearly all parts of the body. The different members of the group present, however, great differences in their chemical and physical properties.

The proteins in the food form the source of the proteins in the body tissues, but the latter are usually different in composition from the former. The food proteins are in the process of digestion broken up into simpler substances, usually called *cleavage products*, and it is from these that the body cells reconstruct the proteins peculiar to themselves. As a result of katabolic processes in the body, the proteins are finally again broken down, carbonic acid, water, sulphuric acid (combined as sulphates), urea, and creatinine being the principal final products which are discharged in the urine and other excretions. The intermediate substances between the proteins and such final katabolites as urea will be discussed under Urine.

The following figures will convince the student how different the proteins are in elementary composition; Hoppe-Seyler many years ago gave the variations in percentage composition as follows:—

	C	H	N	S	O
From	51·5	6·9	15·2	0·3	20·9
To	54·5	7·3	17·0	2·0	23·5

and recent research has since shown that the variations are even greater than those just stated.

The same fact is brought home more vividly when the cleavage products are separated and estimated. These differ both in kind and in amount, but nearly all of them are substances which are termed *amino-acids*. Emil Fischer, to whom we owe so much of our knowledge in this direction, considers that the proteins are linkages of a greater or lesser number of these amino-acids, and there is great hope that in the future his work will result in an actual synthesis of the protein molecule, and with that will come an accurate knowledge of its constitution.

When the protein molecule is broken down in the laboratory by processes similar to those brought about by the digestive ferments which occur in the alimentary canal, the essential change is due to what is called *hydrolysis*: that is, the molecule unites with water and then breaks up into smaller molecules. The first cleavage products, which are called *proteoses*, retain many of the characters of the original protein; and the same is true, though to a less degree, of the *peptones*, which come next in order of formation. The peptones in their turn are decomposed into short linkages of amino-acids which are called *polypeptides*, and finally the individual amino-acids are obtained separated from each other.

What we have already learnt about the fatty acids will help us in understanding what is meant by an amino-acid.

If we take acetic acid, which is one of the simplest of the fatty acids, we see that its formula is



If one of the three hydrogen atoms in the  $\text{CH}_3$  group is replaced by  $\text{NH}_2$  we get a substance which has the formula

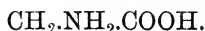

The combination  $\text{NH}_2$  which has stepped in is called the *amino-group*, and the new substance now formed is called *amino-acetic acid*; it is also termed **glycine** or *glycocoll*.

We may take another example from another fatty acid. Propionic acid is  $\text{C}_2\text{H}_5.\text{COOH}$ ; if we replace an atom of hydrogen by the amino-group as before, we obtain  $\text{C}_2\text{H}_4.\text{NH}_2.\text{COOH}$ , which is amino-propionic acid or **alanine**. Going a little higher in the scale, and taking caproic acid,  $\text{C}_5\text{H}_{11}.\text{COOH}$ , we obtain from it, in an exactly similar way,  $\text{C}_5\text{H}_{10}.\text{NH}_2.\text{COOH}$ , which is amino-caproic acid or **leucine**.

All the three amino-acids mentioned—glycine, alanine, and leucine

—are found among the final cleavage products of most proteins; but there are a good many more in addition, for instance:—

Serine (amino-oxypropionic acid,  $\text{CH}_2\text{OH}.\text{CHNH}_2.\text{COOH}$ );

Amino-valeric acid;

Amino-succinamic acid (asparagine);

Amino-succinic acid (aspartic acid);

Amino-pyrotartaric acid (glutamic acid),

some of which are derived from fatty acids of a different series from those first enumerated.

But in all these cases there is only one replacement of an atom of hydrogen by  $\text{NH}_2$ ; hence they are called *monoamino-acids*.

Passing to the next stage in complexity, we come to another group of amino-acids which are called *diamino-acids*: that is, fatty acids in which two hydrogen atoms are replaced by  $\text{NH}_2$  groups. Of these we may mention lysine, ornithine, arginine, and histidine.

**Lysine** is diamino-caproic acid.

Caproic acid is  $\text{C}_5\text{H}_{11}.\text{COOH}$ .

Mono-amino-caproic acid, or leucine, we have already learnt is  $\text{C}_5\text{H}_{10}.\text{NH}_2.\text{COOH}$ .

Lysine or diamino-caproic acid is  $\text{C}_5\text{H}_9(\text{NH}_2)_2\text{COOH}$ .

**Ornithine** is di-amino-valeric acid, and the following formulæ will show its relationship to its parent fatty acid:—

$\text{C}_4\text{H}_9.\text{COOH}$  is valeric acid.

$\text{C}_4\text{H}_7(\text{NH}_2)_2.\text{COOH}$  is diamino-valeric acid or ornithine.

**Arginine** is a somewhat more complex substance, which contains the ornithine radical. It belongs to the same group of substances as **creatine**, another important cleavage product of the protein molecule.

Creatine is methyl-guanidine acetic acid, and has the formula

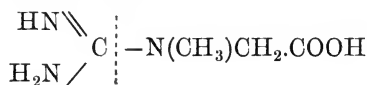

On boiling it with baryta water, it takes up water ( $\text{H}_2\text{O}$ ) and splits at the dotted line into urea [ $\text{CO}(\text{NH})_2$ ] and sarcosine, as shown below.



Arginine decomposes in a similar way, urea being split off on the left, and ornithine instead of sarcosine on the right. Arginine is therefore a compound of ornithine with a urea group.

**Histidine**, the last member of this class, has the formula

$C_6H_9N_3O_2$  is probably also a diamino-acid, but its exact constitution has not yet been made out with certainty.

These substances we have hitherto described as acids, but they may also play the part of bases, the introduction of a second amino-group into the fatty-acid molecules conferring upon them basic properties. The three substances

Lysine ( $C_6H_{14}N_2O_2$ )

Arginine ( $C_6H_{14}N_4O_2$ )

Histidine ( $C_6H_9N_3O_2$ )

are in fact often called the *hexone bases* because each of them contains six atoms of carbon, as the above empirical formulæ show.

But there is still an important group of amino-acids to be considered, and these are termed the *aromatic amino-acids*: that is, amino-acids united to the benzene ring; and of these we shall mention three: namely, phenyl-alanine, tyrosine, and a nearly related substance called tryptophane.

**Phenyl-alanine** is alanine or amino-propionic acid in which an atom of hydrogen is replaced by phenyl ( $C_6H_5$ ).

Propionic acid has the formula  $C_2H_5.COOH$ .

Alanine (amino-propionic acid) is  $C_2H_4.NH_2.COOH$ .

Phenyl-alanine is  $C_2H_3.C_6H_5.NH_2.COOH$ .

The formula of phenyl-alanine may also be written another way. The graphic formula of benzene ( $C_6H_6$ ) is:

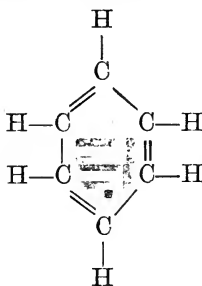

If the H placed lowermost in the above formula is replaced by  $CH_2.CH.NH_2.COOH$  we obtain the formula of phenyl-alanine:—



$CH_2.CHNH_2.COOH$

the remainder of the benzene ring which is unaltered being represented, as usual, by a simple hexagon.

**Tyrosine** is a little more complicated : it is oxyphenyl-alanine : that is, instead of phenyl ( $C_6H_5$ ) in the formula of phenyl-alanine we have now oxyphenyl ( $C_6H_4.OH$ ). This gives us  $C_2H_3.(C_6H_4.OH).NH_2.COOH$  as the formula for tyrosine written one way, or

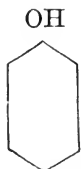

when written in the other way.

**Tryptophane** is more complex still ; it is indole-amino-propionic acid : that is, amino-propionic acid united to another ringed derivative called indole. Tryptophane is the portion of the protein molecule which is the parent substance of two evil-smelling products of protein

decomposition called indole  $C_6H_4 \begin{cases} CH.CH \\ NH \end{cases}$

and scatole or methyl indole. Tryptophane is also the radical in the protein molecule which is responsible for the colour test called the Adamkiewicz reaction.

We may sum up what we have learnt up to this point by enumerating the principal members of these three groups of amino-acids :—

1. *The mono-amino-acids* : glycine, alanine, leucine, amino-valeric acid, asparagine, aspartic acid, glutamic acid.
2. *The di-amino-acids* : lysine, ornithine, arginine, and histidine.
3. *The ringed amino-acids* : phenyl-alanine, tyrosine, and tryptophane.

But this does not bring us to the end of the list of the cleavage products of proteins, for we have still left several other groups most of which are still more complex, and which we will therefore be content with merely mentioning : namely—

4. Pyrimidine bases such as uracil, thymine and cytosine.
5. Pyrrolidine derivatives.
6. Cystine, a complex amino-acid in which sulphur is present, and in which the greater part of the sulphur of the protein molecule is combined.
7. Ammonia.

Our list now represents the principal groups of chemical nuclei united together in the protein molecule, and its length makes one



realise the complicated nature of that molecule and the difficulties which beset its investigation.

The workers in Fischer's laboratory are steadily working through the various known proteins, taking them to pieces, and identifying and estimating the fragments. I do not intend to burden the readers of this book with anything more than a sample of their results, and will therefore only give in a brief table the results obtained with some of the cleavage products of a few proteins. The numbers given are percentages.

	Serum albumin	Egg-albumin	Serum globulin	Caseinogen	Gelatin	Keratin from horse-hair	Edestin, a globulin from hemp seed	Zein from maize	Gliadin from wheat
Glycine . . .	0	0	3.5	0	16.5	0.3	3.8	+	0.9
Leucine . . .	20.0	6.1	18.7	10.5	2.1	7.1	15.5	11.2	6.0
Glutamic acid . . .	7.7	8.0	8.5	11.0	0.8	3.7	17.2	11.8	31.5
Tyrosine . . .	2.1	1.1	2.5	4.5	0	3.2	2.1	10.1	2.4
Arginine . . .				4.8	7.6		11.7	1.8	2.75
Tryptophane . . .	+	+	+	1.5	0		+		
Cystine . . .	2.3	0.2	0.7	0.06		more than 10	0.2		

Such numbers of course are not to be committed to memory, but they are sufficient to convey to the reader the differences between the proteins. There are several blanks left on account of no accurate estimations having yet been made. Where the sign + occurs, the substance in question has been proved to be present, but not yet determined quantitatively. Among the more striking points brought out are:—

1. The absence of glycine from albumins.
2. The high percentage of glycine in gelatin.
3. The absence of tyrosine and tryptophane in gelatin.
4. The high percentage of the sulphur containing substance (cystin) in keratin.
5. The high percentage of glutamic acid in vegetable proteins.

Emil Fischer in his work has sought to make such a list complete, and month by month the details are being filled in. He has next tried to discover the way in which the amino-acids are linked together into groups; and the culmination of his work will be the discovery of the way in which such groups are linked together to form the protein molecule. The last stage he has not yet reached, but it will be interesting to see what progress he has made in ascertaining how the amino-acids are linked together into groups.

These groups he terms *peptides* or *polypeptides*: many of these have been made synthetically in his laboratory, and so the synthesis of the protein molecule is foreshadowed.

We may take as our examples of these peptides some of the simplest, and may write the formulæ of a few amino-acids as follows:—

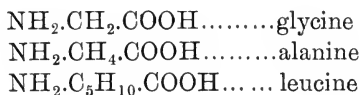

or in general terms

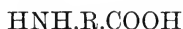

Two amino-acids are linked together as shown in the following formula:—



What happens is that the hydroxyl (OH) of the carboxyl (COOH) group of one acid unites with one atom of the hydrogen of the next amino (HNH) group, and water is thus formed, as shown within the dotted lines: this is eliminated and the rest of the chain closes up. In this way we get a *dipeptide*. The names glycylyl, alanyl, leucyl, &c. are given by Fischer to the  $\text{NH}_2.\text{R.CO}$  groups which replace the hydrogen of the next  $\text{NH}_2$  group. Thus glycylyl-glycine, glycylyl-leucine, leucyl-alanine, alanyl-leucine, and numerous other combinations and permutations are obtained. If the same operation is repeated we obtain tripeptides (leucyl-glycylyl-alanine, alanyl-leucyl-tyrosine &c.); then come the tetrapeptides and so on. In the end, by coupling the chains sufficiently often and in appropriate order, Fischer has already obtained substances which give some of the reactions of peptones.

### TESTS FOR PROTEINS

**Solubilities.**—The proteins as a class are insoluble in alcohol and in ether. Some are soluble in water, others insoluble. Many of the latter are soluble in weak saline solutions. Some are soluble, others insoluble in concentrated saline solutions. It is very largely on these varying solubilities that proteins are separated into classes, and from each other.

When, however, one speaks of the solution of a protein, the kind of solution obtained is usually what physical chemists call *colloidal solution*: the condition here is something intermediate between true solution and a suspension. Many of the properties of proteins, such

as the tendency to coagulate or solidify and the readiness with which they are 'salted out,' are shared in common with other *colloids* some of which are of inorganic nature.

All proteins are soluble with the aid of heat in concentrated mineral acids and alkalis. Such treatment, however, decomposes as well as dissolves the protein. Proteins are also soluble in gastric and pancreatic juices; but there, again, they undergo a change, being converted by hydrolysis into proteins of smaller molecular weight called *peptones*. The intermediate substances formed in this process are called *proteoses*. Commercial peptone contains a mixture of proteoses and true peptone.

**Heat Coagulation.**—Many of the proteins which are soluble in water or saline solution are rendered insoluble when those solutions

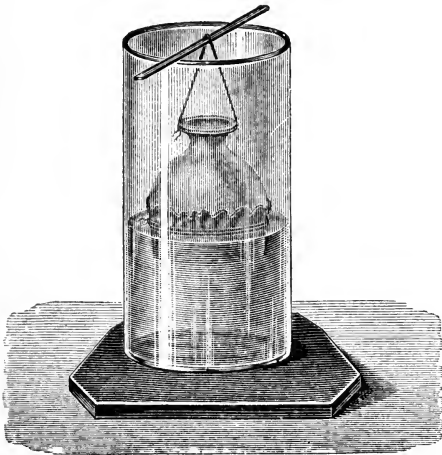

FIG. 7.—Dialyser. The lower opening of the bell jar suspended in water is tightly covered with parchment paper. The fluid to be dialysed is placed within this vessel; the crystalloids pass out into the distilled water outside through the parchment paper.

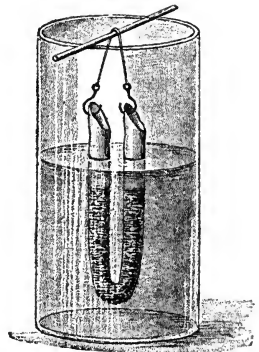

FIG. 8.—In this form of dialyser the substance to be dialysed is placed within the piece of tubing suspended in the larger vessel of water. The tubing is made of parchment paper.

are heated. This is true for most of the proteins that occur in nature. The solidifying of white of egg when heated is a familiar instance of this. The temperature of heat coagulation differs in different proteins: thus myosinogen and fibrinogen coagulate at about  $56^{\circ}$  C.; serum albumin and serum globulin at about  $75^{\circ}$  C.

The proteins which are coagulated by heating their solution come for the most part into two classes—the *albumins* and the *globulins*. The full distinction between these we shall see immediately. We may, however, state here that the albumins are soluble in distilled

water: the true globulins are not, but require salts to hold them in solution.

**Indiffusibility.**—The proteins (peptones excepted) belong to the class of substances called *colloids* by Thomas Graham: they pass with difficulty, or not at all, through animal membranes. In the construction of dialysers, vegetable parchment is very largely used (see figs. 7 and 8).

Proteins may thus be separated from diffusible (*crystalloid*) substances like salts, but the process is a somewhat tedious one. If some serum or white of egg is placed in a dialyser, and distilled water outside, the greater amount of the salts passes into the water through the membrane; the two proteins, albumin and globulin, remain inside. The globulin is, however, precipitated, as the salts which previously kept it in solution have been removed.

The terms 'diffusion' and 'dialysis' should be distinguished from each other.

If water is carefully poured on the surface of a solution of any substance, this substance gradually spreads through the water, and the composition of the mixture becomes uniform in time. The time occupied is short for substances like sodium chloride, and long for substances like albumin. The phenomenon is called *diffusion*. If the solutions are separated by a membrane the term 'dialysis' is employed. The word *osmosis* is properly restricted to the passage of water through membranes, and can be best studied when semi-permeable membranes are employed. See more fully article OSMOSIS in Appendix.

**Crystallisation.**—Hæmoglobin, the red pigment of the blood, is a protein substance, and is crystallisable (for further details, see THE BLOOD). Like other proteins, it has an enormously large molecule; though crystalline, it is not crystalloid in Graham's sense of that term, although it probably forms a true solution with water. Blood pigment is not the only crystallisable protein. Long ago crystals of protein (globulin or vitellin) were observed in the aleurone grains of many seeds, and in the similar protein occurring in the egg-yolk of some fishes and amphibians. By appropriate methods these have been separated and recrystallised. Further, egg-albumin itself has been crystallised. If a solution of white of egg is diluted with half its volume of saturated solution of ammonium sulphate, the globulin present is precipitated and is removed by filtration. The filtrate is now allowed to remain some days at the temperature of the air, and as it becomes more concentrated from evaporation, minute spheroidal globules and finally minute needles, either aggregated or separate, make their appearance (Hofmeister). Crystallisation is much more rapid and perfect if a little acetic or

sulphuric acid is added (Hopkins). Serum albumin (from some animals) has also been similarly crystallised (Gürber).

**Action on Polarised Light.**—All the proteins are levo-rotatory, but the amount of rotation they produce varies with the kind of protein. See Appendix. Several of the compound proteins (for instance, hæmoglobin and nucleo-proteins) are dextro-rotatory, though their protein components are levo-rotatory (Gamgee).

**Colour Reactions.**—The principal colour reactions have been already described in the heading of this lesson.

(1) The xantho-proteic reaction depends on the conversion of the aromatic group of the protein molecule into nitro-derivatives.

(2) Millon's reaction is due to the presence of the tyrosine group, and is given by all benzene derivatives which contain a hydroxyl group (OH) replacing hydrogen.

(3) The formaldehyde reaction (and the Adamkiewicz reaction, which is probably the same thing) is due to the presence of the tryptophan radical (indole-amino-propionic acid).

The presence, absence, or intensity of these colour tests in various proteins depends respectively on the presence, absence, or amount of the groups to which they are due.

(4) In the copper sulphate test the proteoses and peptones behave differently from the native proteins; the latter give a violet and the former a rose-red colour, which is called the *biuret reaction*, because the same tint is also given by the substance called biuret.<sup>1</sup> The name does not imply that biuret is present in protein, but both biuret and protein give the reaction because they possess the same group or groups which are probably two CONH<sub>2</sub> groups linked either to a carbon atom, or to a nitrogen atom, or directly to one another (Schiff).

**Precipitants of Proteids.**—Proteids are precipitated by a large number of reagents; the peptones and proteoses are exceptions in many cases, and will be considered separately afterwards (see Lesson VII.).

Solutions of the proteins are precipitated by—

1. Strong acids, like nitric acid.
2. Picric acid.
3. Acetic acid and potassium ferrocyanide.
4. Acetic acid and excess of neutral salts like sodium sulphate.

<sup>1</sup> Biuret is obtained by heating solid urea; ammonia is given off and leaves biuret thus:—

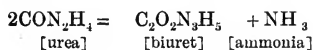

5. Salts of the heavy metals, like copper sulphate, mercuric chloride, lead acetate, silver nitrate, &c.

6. Tannin.

7. Alcohol.

8. Saturation with certain neutral salts, such as ammonium sulphate.

It is necessary that the words *coagulation* and *precipitation* should, in connection with the proteins, be carefully distinguished. The term *coagulation* is used when an insoluble protein (coagulated protein) is formed from a soluble one. This may occur—

1. When the protein is heated—*heat coagulation*.

2. Under the influence of a ferment; for instance, when a curd is formed in milk by rennet or a clot in shed blood by the fibrin ferment—*ferment coagulation*.

3. When an insoluble precipitate is produced by an addition of certain reagents (nitric acid, picric acid, tannin, &c.).

There are, however, other precipitants of proteins in which the precipitate formed is readily soluble in suitable reagents, like saline solution, and the protein continues to show its typical reactions. This precipitation is not coagulation. Such a precipitate is produced by saturation with ammonium sulphate. Certain proteins, called globulins, are more readily precipitated by such means than others. Thus, serum globulin is precipitated by half-saturation with ammonium sulphate. Full saturation with ammonium sulphate precipitates all proteins but peptone. The globulins are precipitated by certain salts like sodium chloride and magnesium sulphate, which do not precipitate the albumins. The precipitation of proteins by salts in this way is conveniently termed 'salting out.'

The precipitate produced by alcohol is peculiar in that after a time it becomes a coagulum. Protein freshly precipitated by alcohol is readily soluble in water or saline media; but after it has been allowed to stand some weeks under alcohol it becomes more and more insoluble. Albumins and globulins are most readily rendered insoluble by this method; proteoses and peptones are apparently never rendered insoluble by the action of alcohol. This fact is of value in the separation of these proteins from others.

## CLASSIFICATION OF PROTEINS

The knowledge of the chemistry of the proteins which is slowly progressing under Emil Fischer's leadership will no doubt in time enable us to give a classification of the substances on a strictly chemical basis. But until that time arrives we must be content very largely with the artificial classification (on the basis of solubility and so forth) which has hitherto prevailed. The following classification must therefore be regarded as a provisional one, which, while it retains the old familiar names as far as possible, yet attempts also to incorporate some of the new ideas. The classes of proteins, then, beginning with the simplest, are as follow :—

1. Protamines.
2. Histones.
3. Albumins.
4. Globulins.
5. Sclero-proteins.
6. Phospho-proteins.
7. Conjugated proteins.
  - (a) Gluco-proteins.
  - (b) Nucleo-proteins.
  - (c) Chromo-proteins.

We shall take these classes one by one.

### 1. The Protamines

These substances are obtainable from the heads of the spermatozoa of certain fishes, where they occur in combination with nuclein. Kossel's view that they are the simplest proteins in nature has met with general acceptance, and they give such typical protein reactions as the copper sulphate test (Rose's or Piotrowski's reaction). On hydrolytic decomposition they first yield substances of smaller molecular weight analogous to the peptones which are called *protones*, and then they split up into amino-acids. The number of resulting amino-acids is small as compared with other proteins; hence the hypothesis that they are simple proteins is confirmed. Notable among their decomposition products are the diamino-acids or hexone bases, which have the following names and formulæ :—

Lysine ( $C_6H_{14}N_2O_2$ )

Arginine ( $C_6H_{14}N_4O_2$ )

Histidine ( $C_6H_9N_3O_2$ )

The protamines differ in their composition according to their source, and yield these products in different proportions.

*Salmine* (from the salmon roe) and *clupeine* (from the herring roe) appear to be identical, and have the empirical formula  $C_{30}H_{57}N_{17}O_6$ : its principal decomposition products are arginine, amino-valeric acid, and a small quantity of an unknown residue. *Sturine* (from the sturgeon) yields the same products with lysine and histidine in addition. With one exception, the protamines yield no aromatic amino-acids, of which tyrosine is a familiar instance; the exception is *cyclopterine* (from *Cyclopterus lumpus*); this substance is thus an important chemical link between the other protamines, and the more complex members of the protein family.

## 2. The Histones

These are substances which have been separated from blood corpuscles; *globin*, the protein constituent of hæmoglobin, is a well-marked instance. They yield a larger number of amino-compounds than do the protamines. They are coagulable by heat, soluble in dilute acids, and precipitable from such solutions by ammonia. The precipitability by ammonia is a property possessed by no other protein group.

## 3. The Albumins

These are typical proteins, and yield the majority of the cleavage products enumerated on pp. 31-35.

They enter into colloidal solution in water in dilute saline solutions, and in saturated solutions of sodium chloride and magnesium sulphate. They are, however, precipitated by saturating their solutions with ammonium sulphate. Their solutions are coagulated by heat usually at  $70^{\circ}$ - $73^{\circ}$  C. Serum albumin, egg-albumin, and lact-albumin are instances.

## 4. The Globulins

The globulins give the same general tests as the albumins: they are coagulated by heat, but differ from the albumins mainly in their solubilities. This difference in solubility may be stated in tabular form as follows:—

Reagent	Albumin	Globulin
Water . . . . .	soluble	insoluble
Dilute saline solution . . . . .	soluble	soluble
Saturated solution of magnesium sulphate or sodium chloride . . . . .	soluble	insoluble
Half-saturated solution of ammonium sulphate . . . . .	soluble	insoluble
Saturated solution of ammonium sulphate . . . . .	insoluble	insoluble



In general terms globulins are more readily salted out than albumins; they may therefore be precipitated and thus separated from the albumins by saturation with such salts as sodium chloride, or, better, magnesium sulphate, or by half saturation with ammonium sulphate.

The typical globulins are also insoluble in water, and so may be precipitated by removing the salt which keeps them in solution. This may be accomplished by dialysis (see p. 38).

Their temperature of heat coagulation varies considerably. The following are the commoner globulins:—fibrinogen and serum globulin in blood; egg-globulin in white of egg, myosinogen in muscle, and crystallin in the crystalline lens. We must also include under the same heading certain proteins which are the result of ferment coagulation on globulins, such as fibrin (see Blood) and myosin (see Muscle).

The most striking and real distinction between globulins and albumins is that the latter on hydrolysis yield no glycine, whereas the globulins do.

### 5. The Sclero-proteins

These substances form a heterogeneous group of substances, which are frequently termed *albuminoids*. The prefix *sclero-* indicates the skeletal origin and often insoluble nature of the members of the group. The principal proteins under this head are the following:—

1. **Collagen**, the substance of which the white fibres of connective tissue are composed. Some observers regard it as the anhydride of gelatin.

2. **Ossein**.—This is the same substance derived from bone.<sup>1</sup>

3. **Gelatin**.—This substance is produced by boiling collagen with water. It possesses the peculiar property of setting into a jelly when a solution made with hot water cools. On digestion it is like ordinary proteins converted into peptone-like substances and is readily

<sup>1</sup> In round numbers the solid matter in *bone* contains two thirds inorganic or earthy matter, and one third organic or animal matter. The inorganic constituents are calcium phosphate (84 per cent. of the ash), calcium carbonate (13 per cent.), and smaller quantities of calcium chloride, calcium fluoride, and magnesium phosphate. The organic constituents are ossein (this is the most abundant), elastin from the membranes lining the Haversian canals, lacunæ, and canaliculi, and other proteins and nuclein from the bone corpuscles. There is also a small quantity of fat even after removal of all the marrow. *Dentine* is like bone chemically, but the proportion of earthy matter is rather greater. *Enamel* is the hardest tissue in the body; the mineral matter is like that found in bone and dentine; but the organic matter is so small in quantity as to be practically non-existent (Tomes). Enamel is epiblastic, not mesoblastic, like bone and dentine.

absorbed. Though it will replace in diet a certain quantity of such proteins and thus acts as a 'protein-sparing' food, it cannot altogether take their place as a food. Animals whose sole nitrogenous food is gelatin waste rapidly. The reason for this is that gelatin contains neither the tyrosine nor the tryptophane radicals, and so it gives neither Millon's nor the Adamkiewicz reaction. Animals which receive in their food gelatin to which tyrosine and tryptophane are added thrive well.:

4. **Chondrin**.—This is the name given to the mixture of gelatin and mucoid which is obtained by boiling cartilage.

5. **Elastin**.—This is the substance of which the yellow or elastic fibres of connective tissue are composed. It is a very insoluble material. The sarcolemma of muscular fibres and certain basement membranes are very similar.

6. **Keratin**, or horny material, is the substance found in the surface layers of the epidermis, in hairs, nails, hoofs, and horns. It is very insoluble, and chiefly differs from most proteins in its high percentage of sulphur. A similar substance, called *neurokeratin*, is found in neuroglia and nerve fibres. In this connection it is interesting to note that the epidermis and the nervous system are both formed from the same layer of the embryo—the epiblast.

## 6. The Phospho-proteins

Vitellin (from egg-yolk), caseinogen, the principal protein of milk and casein, the result of the action of the rennet-ferment on caseinogen (see Milk), are the principal members of this group. Among their decomposition products is a considerable quantity of phosphoric acid. They have been frequently confused with the nucleo-proteins we shall be studying immediately, and the prefix nucleo- so often applied to them is entirely misleading, since they do not yield the products (purine bases) which are characteristic of nucleo-compounds.

## 7. The Conjugated Proteins

These very complex substances are compounds in which the protein molecule is united to other organic materials, which are, as a rule, also of complex nature. This second constituent of the compound is usually termed a *prosthetic group*. They may be divided into the following sub-classes.

i. **Chromo-proteins**.—These are compounds of proteins with a pigment, which usually contains iron. They are typified by hæmoglobin and its allies, which will be fully considered under Blood

ii. **Glucoproteins.**—These are compounds of protein with a carbohydrate group. This class includes the mucins and the mucoids.

The *mucins* are widely distributed and may occur in epithelial cells, or be shed out by these cells (mucus, mucous glands, goblet cells). The mucin obtained from different sources varies in composition and reactions, but they all agree in the following points:—

(a) Physical character. Viscid and tenacious.

(b) They are soluble in dilute alkalis, such as lime water, and are precipitable from solution by acetic acid.

The *mucoids* generally resemble the mucins, but differ from them in minor details. The term is applied to the mucin-like substances which form the chief constituent of the ground substance of connective tissues (tendo-mucoid, chondro-mucoid, &c.). Another, ovomucoid is found in white of egg, and others (pseudo-mucin and para-mucin) are occasionally found in dropsical effusions, and in the fluid of ovarian cysts.

It is probable that the differences between the mucins and the mucoids are due either to the nature of the carbohydrate group or, more probably, to the nature of the protein to which it is united. The carbohydrate substance in the majority of cases is not sugar, but a nitrogenous substance which has a similar reducing power to sugar, and which is called *glucosamine* ( $C_6H_{11}O_5NH_2$ ): that is, glucose in which HO is replaced by  $NH_2$ .

Pavy and others have shown that a *small* quantity of the same carbohydrate derivative can be split off from various other proteins which we have already placed among the albumins and globulins. It is, however, probable that this must not be considered a prosthetic group, but is more intimately united within the protein molecule.

iii. **Nucleo-proteins.** These are compounds of protein with a complex organic acid called nucleic acid which contains phosphorus. They are found both in the nuclei and cell-protoplasm of cells. In physical characters they often simulate mucin.

*Nuclein* is the name given to the chief constituent of cell-nuclei. It is identical with the chromatin of histologists (see fig. 9).

On decomposition it yields an organic acid called nucleic acid together with a variable but usually small amount of protein. It

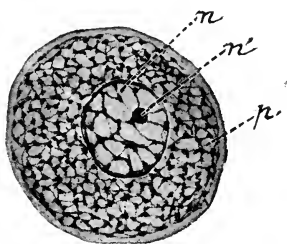

FIG. 9.—Diagram of a cell; *p*, protoplasm composed of spongioplasm and hyaloplasm; *n*, nucleus with intranuclear network of chromatin or nuclein; and *n'*, nucleolus (Schäfer.)

contains a high percentage (10-11) of phosphorus. The nuclein obtained from the nuclei or heads of the spermatozoa consists of nucleic acid without any protein admixture. In fishes' spermatozoa, however, there is an exception to this rule, for there it is, as we have already seen, united to protamine.

*The nucleo-proteins of cell protoplasm* are compounds of nucleic acid with a much larger quantity of protein, so that they usually contain only 1 per cent. or less of phosphorus. Some also contain iron, and it is probable that the normal supply of iron to the body is contained in the nucleo-proteins or *hematogens* (Bunge) of plant or animal cells.

Nucleo-proteins may be prepared from cellular structures like thymus, testis, kidney, &c., by two principal methods:—

1. *Wooldridge's method.* The organ is minced and soaked in water for twenty-four hours. Dilute acetic acid added to the aqueous extract precipitates the nucleo-protein.

2. *Sodium chloride method.* The minced organ is ground up in a mortar with solid sodium chloride; the resulting viscous mass is poured into excess of water, and the nucleo-protein rises in strings to the top of the water.

The solvent usually employed for a nucleo-protein, by whichever method it is prepared, is a 1-per-cent. solution of sodium carbonate. The relationship of nucleo-proteins to the coagulation of the blood is described under that heading.

*Nucleic acid* on decomposition yields phosphoric acid, various bases of the xanthine group, and bases also of the pyrimidine group (cytosine, uracil, &c.). In some cases a carbohydrate radical is also obtained; thus a pentose is obtained from the nucleic acid of the pancreas, the liver, and yeast cells. There appear to be several nucleic acids, which vary in the relative amount they yield of their decomposition products, especially of the members of the xanthine family, which are sometimes called *alloxuric*, or, more usually, *purine* bases. The purine bases are closely allied chemically to uric acid, and we shall have to study them again in relation to that substance. The following diagrammatic way of representing the decomposition of nucleo-protein will assist the student in remembering the relationships of these substances:—

## NUCLEO-PROTEIN

subjected to gastric digestion yields

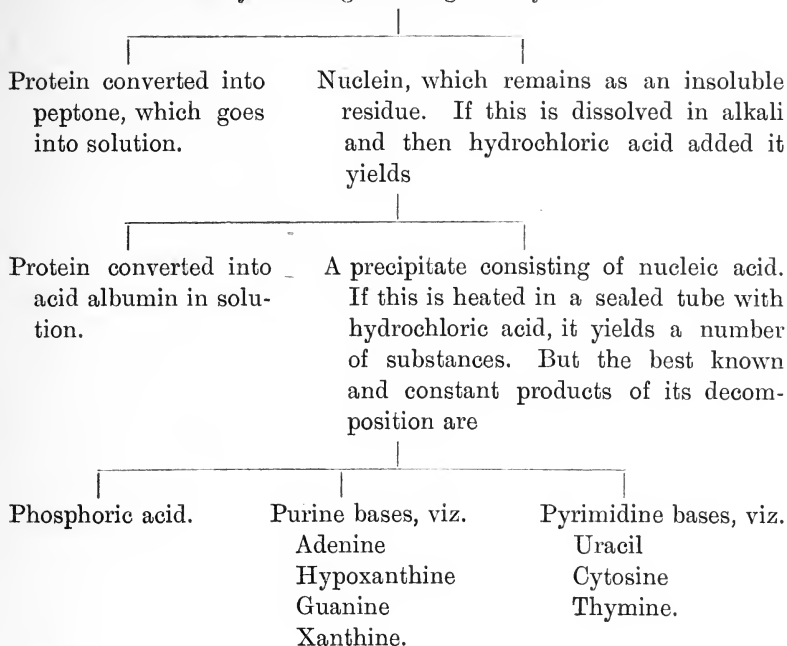
**Protein-hydrolysis**

When protein material is subjected to hydrolysis, as it is when heated with mineral acid, or superheated steam, or to the action of such ferments as pepsin or trypsin in the alimentary canal, it is finally resolved into the numerous amino-acids of which it is built. But before this ultimate stage is reached, it is split into substances of progressively diminishing molecular size, which still retain many of the protein characters. These may be classified in order of formation as follows :—

1. Infra-proteins.
2. Proteoses.
3. Peptones.
4. Polypeptides.

The polypeptides are linkages of two or more amino-acids as already explained. They do not give the biuret reaction. Although most of the polypeptides at present known are products of laboratory synthesis, some have been definitely separated from the digestion of

proteins, and so they must appear in our classification. The proteoses and peptones give the biuret reaction; the peptones, however, cannot be salted out of solution like the proteoses; their molecules are smaller than those of the proteoses. We shall study them more fully under digestion. It is, however, necessary to add here a brief description of the infra-proteins, since some of the practical exercises at the head of this lesson deal with them.

They are obtained as the first stage of hydrolysis, and also by the action of dilute acids or alkalis on either albumins or globulins. The general properties of the *acid-albumin* or *syntonin* and the *alkali-albumin*, which are thereby respectively formed are as follows:— they are insoluble in pure water, but are soluble in either acid or alkali, and are precipitated by neutralisation unless certain disturbing influences like sodium phosphate are present. They are precipitated as globulins are by saturation with such neutral salts as sodium chloride or magnesium sulphate. They are not coagulated by heat if in solution. In alkali-albumin some of the sulphur in the original protein is removed.

The name *albuminate* used to be applied to these substances; but this is an objectionable term, for these first degradation products of protein hydrolysis are not salts, as the termination *-ate* would imply. Moreover, they are obtainable from both albumins and globulins. The prefix 'infra-' (or possibly 'meta-', which some prefer) may be taken as an indication of comparatively slight chemical alteration.

A variety of alkali-albumin (probably a compound containing a large quantity of alkali) may be formed by adding strong potash to undiluted white of egg. The resulting jelly is called *Lieberkühn's jelly*. A similar jelly is obtainable by adding strong acetic acid to undiluted egg-white.

The word 'albuminate' is also used for compounds of protein with mineral substances. Thus if a solution of copper sulphate is added to a solution of albumin a precipitate of copper albuminate is formed. Similarly, by the addition of other salts of the heavy metals, other metallic albuminates are obtainable. The halogens (chlorine, bromine, iodine) also form albuminates in this sense, and may be used for the precipitation of proteins.

It should be noted, in conclusion, that the foregoing classification of proteins is mainly applicable to those of animal origin. The vegetable proteins may roughly be arranged under the same main headings, although it is doubtful if a real and complete analogy exists in all cases. The cleavage products of the vegetable proteins are in the main the same as those of the animal proteins, but the quantity of each yielded is usually different. Vegetable proteins, for instance, as a rule give a very much higher yield of glutamic acid than do those of animal origin.

Further, there are certain vegetable proteins which have hitherto been regarded as peptones, but which do not give the biuret reaction. It seems impossible at present to bring exceptional substances of this kind into any general classification, and the same is true for those curious vegetable proteins, such as gliadin from the gluten of wheat, and zein from maize, which stand apart from all other members of the group in being soluble in alcohol.

## LESSON VI

### FOODS

A. **Milk.** 1. Examine a drop of milk with the microscope.

2. Note the specific gravity of fresh milk with the lactometer; compare this with the specific gravity of milk from which the cream has been removed (skimmed milk). The specific gravity of skimmed milk is higher owing to the removal of the lightest constituent—the cream.

3. The reaction of fresh milk is neutral or slightly alkaline to litmus.

4. Warm some milk in a test-tube to the temperature of the body, and add a few drops of rennet. After standing, a *curd* is formed from the conversion of *caseinogen*, the chief protein in milk, into *casein*. The casein entangles the fat globules. The liquid residue is termed *whey*. No curdling is produced if the rennet solution is previously-boiled, because heat kills ferments.

5. Take some milk to which 0.2 per cent. of potassium oxalate has been added; warm to 40° C. and add rennet. No curdling takes place because the oxalate has precipitated the calcium salts which are necessary in the coagulation process.

Take a second specimen of oxalated milk and add a few drops of 2-per-cent. solution of calcium chloride, and then rennet; curdling or coagulation takes place if the mixture is kept warm in the usual way.

6. To another portion of warm milk diluted with water add a few drops of 20-per-cent. acetic acid. A lumpy precipitate of caseinogen entangling the fat is formed.

7. Filter off this precipitate, and in the filtrate test for *lactose* or *milk sugar* by Trommer's test (see Lesson II.); for *lact-albumin* by boiling, or by Millon's reagent (see Lesson IV.); and for earthy (that is, calcium and magnesium) *phosphates* by ammonia, which precipitates these phosphates. Phosphates may also be detected by adding nitric acid and ammonium molybdate and boiling; a yellow crystalline precipitate is formed.

8. Fat (*butter*) may be extracted from the precipitate by shaking it with ether; on evaporation of the ethereal extract the fat is left behind, forming a greasy stain on paper. The presence of fat may also be demonstrated by the black colour produced by the addition of osmic acid to the milk.

9. Shake up a little milk with twice its volume of ether; the opacity of the milk remains nearly as great as before. Repeat this, but first add to the milk a few drops of caustic potash before adding the ether and then shake. The milk which lies beneath the ethereal solution of fat becomes translucent. As a matter of fact ether dissolves the fat without the addition of alkali, and the opacity of milk is therefore not due to the fat globules alone, but largely to their caseinogen envelope. The clearing which takes place when ether and alkali are added is due to an action of the reagents on the caseinogen.

10. *Caseinogen*, like globulins, is precipitated by saturating milk with sodium chloride or magnesium sulphate, and by half saturation with ammonium sulphate, but differs from the globulins in not being coagulated

by heat. The precipitate produced by saturation with salt floats to the surface with the entangled fat, and the clear salted whey is seen below after an hour or two.

**B. Flour.**—Mix some wheat flour with a little water into a stiff dough. Wrap this up in a piece of muslin and knead it under a tap or in a capsule of water. The starch grains come through the holes in the muslin (identify by iodine test), and an elastic sticky mass remains behind. This is a protein called *gluten*. Suspend a fragment of gluten in water; add nitric acid and boil; it turns yellow; cool and add ammonia; it turns orange (xanthoproteic reaction). Boil another fragment with Millon's reagent; it turns a brick-red colour.

**C. Bread** contains the same constituents as flour, except that some of the starch has been converted into dextrin and dextrose during baking (most flours, however, contain a small quantity of sugar). Extract breadcrust with cold water, and test the extract for dextrin (iodine test) and for dextrose (Trommer's test). If hot water is used, starch also passes into solution.

**D. Meat.**—This is our main source of protein food. Cut up some lean meat into fine shreds and grind these up with salt solution. Filter and test for proteins.

### THE PRINCIPAL FOOD-STUFFS

We can now proceed to apply the knowledge we have obtained of the proteins, carbohydrates, and fats to the investigation of some important foods. The chief proximate principles in food are:—

- |                  |   |            |
|------------------|---|------------|
| 1. Proteins      | } | organic.   |
| 2. Carbohydrates |   |            |
| 3. Fats          |   |            |
| 4. Water         | } | inorganic. |
| 5. Salts         |   |            |

In milk and in eggs, which form the exclusive foods of young animals, all varieties of these proximate principles are present in suitable proportions. Hence they are spoken of as perfect foods. Eggs, though a perfect food for the developing bird, contain too little carbohydrate for a mammal. In most vegetable foods carbohydrates are in excess, while in animal food, like meat, the proteins are predominant. In a suitable diet these should be mixed in proper proportions, which must vary for herbivorous and carnivorous animals. We must, however, limit ourselves to the omnivorous animal, man.

A healthy and suitable diet must possess the following characters:—

1. It must contain the proper amount and proportion of the various proximate principles.
2. It must be adapted to the climate, to the age of the individual, and to the amount of work done by him.



3. The food must contain, not only the necessary amount of proximate principles, but these must be present in a digestible form. As an instance of this, many vegetables (peas, beans, lentils) contain even more protein than beef and mutton, but are not so nutritious, as they are less digestible, much passing off in the fæces unused.

The nutritive value of a diet depends mainly on the amount of carbon and nitrogen it contains in a readily digestible form. A man doing a moderate amount of work, and taking an ordinary diet, will eliminate, chiefly from the lungs in the form of carbonic acid, from 250 to 280 grammes of carbon *per diem*. During the same time he will eliminate, chiefly in the form of urea in the urine, about 15 to 18 grammes of nitrogen. These substances are derived from the food, and from the metabolism of the tissues; various forms of energy, work and heat being the chief, are simultaneously liberated. During muscular exercise the output of carbon greatly increases; the increased excretion of nitrogen is not nearly so marked. Taking, then, the state of moderate exercise, it is necessary that the waste of the tissues should be replaced by fresh material in the form of food; and the proportion of carbon to nitrogen should be the same as in the excretions: 250 to 15, or 16·6 to 1. The proportion of carbon to nitrogen in protein is, however, 53 to 15, or 3·5 to 1. The extra supply of carbon comes from non-nitrogenous foods—viz. fat and carbohydrate.

Voit gives the following daily diet:—

Protein	118 grammes.
Fat	100 „
Carbohydrate	333 „

Ranke's diet closely resembles Voit's; it is—

Protein	100 grammes.
Fat	100 „
Carbohydrate	250 „

In preparing diet tables, such adequate diets as those just given should be borne in mind. The following dietary (from G. N. Stewart) will be seen to be rather more liberal, but may be taken as fairly typical of what is usually consumed by an adult man in the twenty-four hours, doing an ordinary amount of work.

Food-stuff	Quantity		Grammes of					
			Nitro- gen	Car- bon	Pro- teins	Fats	Carbo- hydrates	Salts
Lean meat	Metric system 250 grammes	English weights 9 oz.	8	33	55	8.5	0	4
Bread .	500 "	18 "	6	112	40	7.5	245	6.5
Milk .	500 "	$\frac{3}{4}$ pint	3	35	20	20	25	3.5
Butter .	30 "	1 oz.	0	20	0	27	0	0.5
Fat with meat .	30 "	1 "	0	22	0	30	0	0
Potatoes .	450 "	16 "	1.5	47	10	0	95	4.5
Oatmeal .	75 "	3 "	1.7	30	10	4	48	2
			20.2	299	135	97	413	21

Recent research has shown that, for a certain time at any rate, a man will maintain his weight and health on diets even scantier than those of Voit and Ranke. The most convincing of these experiments have been performed by Chittenden upon himself and others. Chittenden urges that the normal diet should contain only about half the customary quantity of protein. The body certainly does not assimilate the larger amount usually taken, for the greater part of the nitrogenous constituents is converted into amino-acids, which are rapidly transformed by the liver into urea and cast out of the body, leaving the non-nitrogenous remainder to be utilised as fats and carbohydrates are, for the production of heat and energy. Whether Chittenden's views will meet with general acceptance is at present doubtful, although his work will bring home to many people that temperance is necessary in food as well as in drink. The majority of well-to-do people certainly eat an excess of meat, and so throw an unnecessary strain upon their digestive and excretory organs. One should hesitate, however, in accepting Chittenden's conclusions to the full, for it is doubtful if the *minimum* is also the *optimum* diet. It may be that there is a real need for an excess of protein beyond the apparent minimum. In diamond mining a large quantity of earth must be crushed to obtain the precious stones. It may be that among the many cleavage products of protein the majority may be compared to this waste earth, and we get rid of them as quickly as possible in the excretions, but some few may be unusually precious for protein synthesis in the body, and that, in order to get an adequate supply of these, a comparatively large amount of protein must be ingested.

## MILK

**Milk** is often spoken of as a 'perfect food,' and it is so for infants. For those who are older it is so voluminous that unpleasantly large quantities of it would have to be taken in the course of the day to insure the proper supply of nitrogen and carbon. Moreover, for adults it is relatively too rich in protein and fat. It also contains too little iron (Bunge); hence children weaned late become anæmic.

The microscope reveals that it consists of two parts: a clear fluid and a number of minute particles that float in it. These consist of minute oil globules, varying in diameter from 0.0015 to 0.005 millimetre.

The milk secreted during the first few days of lactation is called *colostrum*. It contains very little caseinogen, but large quantities

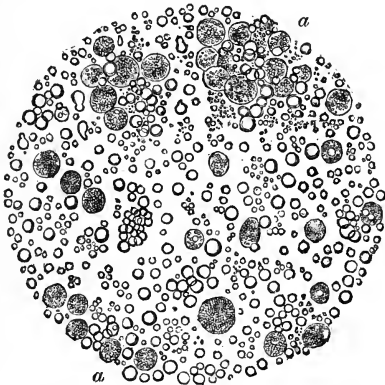

FIG. 10.—Microscopic appearance of milk in the early stage of lactation, showing colostrum corpuscles (*a*) in addition to fat globules. (Yeo.)

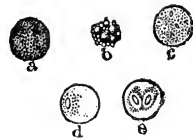

FIG. 11.—*a, b*, colostrum corpuscles with fine and coarse fat globules respectively; *c, d, e*, pale cells devoid of fat. (Heidenhain.)

of globulin instead. Microscopically, cells from the acini of the mammary gland are seen, which contain fat globules in their interior: they are called colostrum corpuscles.

**Reaction and Specific Gravity.**—The reaction of fresh cow's milk and of human milk is amphoteric. This is due to the presence of both acid and alkaline salts; the latter are usually in excess. Milk readily turns acid or sour as the result of fermentative change, part of its lactose being transformed into lactic acid (see p. 19). The specific gravity of milk is usually ascertained with the hydrometer. That of normal cow's milk varies from 1,028 to 1,034. When the milk is skimmed the specific gravity rises, owing to the removal of the light constituent, the fat, to 1,033 to 1,037. In all cases the specific

gravity of water, with which other substances are compared, is taken as 1,000.

**Composition.**—Bunge gives the following table, contrasting the milk of woman and cow :—

—	Woman	Cow
	Per cent.	Per cent.
Proteins (chiefly caseinogen) . . . . .	1·7	3·5
Butter (fat) . . . . .	3·4	3·7
Lactose . . . . .	6·2	4·9
Salts . . . . .	0·2	0·7

Hence, in feeding infants on cow's milk, it will be necessary to dilute it, and add sugar to make it approximately equal to natural human milk.

**The Proteins of Milk.**—The principal protein in milk is called *caseinogen*: this is the one which is coagulated by rennet to form *casein*. Cheese consists of casein with the entangled fat. The other protein in milk is an albumin. It is present in small quantities only; it differs in some of its properties (specific rotation, coagulation, temperature, and solubilities) from serum-albumin; it is called *lact-albumin*.

**The Coagulation of Milk.**—Rennet is the agent usually employed for this purpose: it is a ferment secreted by the stomach, especially by sucking animals, and is generally obtained from the calf.

The *curd* consists of the casein and entangled fat: the liquid residue called *whey* contains the sugar, salts, and albumin of the milk. There is also a small quantity of a new protein called *whey-protein*, which differs from caseinogen by not being convertible into casein. It is produced by the decomposition of the caseinogen molecule during the process of curdling.

The curd formed in human milk is more finely divided than that in cow's milk: hence it is more digestible. In feeding children and invalids on cow's milk, the lumpy condition of the curd may be obviated by the addition of lime water or barley water to the milk.

Considerable discussion has taken place as to whether the caseinogen of human milk may not be a different protein from that of cow's milk, especially in relation to the amount and manner of combination of its phosphorus. The differences, however, appear to be explicable on the hypothesis that they are due to variations in the amounts of calcium salts and of citric acid which are present.

Caseinogen itself may be precipitated by acids such as acetic acid,

or by saturation with neutral salts like sodium chloride. This, however, is not coagulation, but precipitation. The precipitate may be collected and dissolved in lime water; the addition of rennet then produces coagulation in this solution, provided that a sufficient amount of calcium salts is present.

In milk also, rennet produces coagulation, provided that a sufficient amount of calcium salts is present. If the calcium salts are precipitated by the addition of potassium oxalate, rennet causes no formation of casein. The process of curdling in milk is a double one; the first action due to rennet is to produce a change in caseinogen; the second action is that of the calcium salt, which precipitates the altered caseinogen as casein. In blood also calcium salts are necessary for coagulation; but there they act in a different way, namely, in the production of fibrin-ferment (see COAGULATION OF BLOOD).

Caseinogen is not coagulable by heat. We have already classed it with vitellin as a phospho-protein (see p. 44).

Caseinogen, as was originally pointed out by Hammarsten, is a protein with acid properties: it is quite insoluble in water, but it forms soluble salts with such metallic bases as potassium, sodium, and calcium. The caseinogen as it exists in milk is combined with calcium as calcium caseinogenate. When acetic acid is added to milk, we therefore get calcium acetate, and a precipitate of free caseinogen. On 'dissolving' this caseinogen in an alkali like soda or potash, we have the formation of sodium caseinogenate or potassium caseinogenate, as the case may be. The precipitate obtained in milk by the addition of alcohol, or by 'salting out,' is not free caseinogen, but calcium caseinogenate. When we add potassium oxalate to milk, we get the reaction represented in the following equation:—Calcium caseinogenate + potassium oxalate = calcium oxalate + potassium caseinogenate. When we add calcium chloride to oxalated milk, the following equation represents what occurs:—Potassium caseinogenate + calcium chloride = calcium caseinogenate + potassium chloride.

Calcium caseinogenate forms an opalescent solution in water, and reacts with the rennin ferment. The caseinogenates of magnesium, barium, and strontium have similar characters. The caseinogenates of potassium, sodium, and ammonium differ from the above by forming a nearly clear solution in water, and they do not react with the rennin ferment. (W. A. Osborne.)

**The Fats of Milk.**—The chemical composition of the fat of milk (butter) is very like that of adipose tissue. It consists chiefly of palmitin, stearin, and olein. There are, however, smaller quantities of fats derived from fatty acids lower in the series, especially butyric and caproic. The old statement that each fat globule is surrounded by a membrane of caseinogen is, according to Ramsden's recent work, correct. Milk also contains small quantities of lecithin, a phosphorised fat; of cholesterol, an alcohol which resembles fat in its solubilities (see BILE); and a yellow fatty pigment or lipochrome.

**Milk Sugar or Lactose.**—This is a saccharose ( $C_{12}H_{22}O_{11}$ ). Its properties have already been described in Lesson II., p. 19.

**Souring of Milk.**—When milk is allowed to stand, the chief change which it is apt to undergo is a conversion of a part of its lactose into lactic acid. This is due to the action of micro-organisms, and would not occur if the milk were contained in closed sterilised vessels. Equations showing the change produced are given on p. 19. When souring occurs, the acid which is formed precipitates a portion of the caseinogen. This must not be confounded with the formation of casein from caseinogen which is produced by rennet. There are, however, some bacterial growths which produce true coagulation like rennet.

**Alcoholic Fermentation in Milk.**—When yeast is added to milk, the sugar does not readily undergo the alcoholic fermentation. Other somewhat similar fungoid growths are, however, able to produce the change, as in the preparation of koumiss; the milk sugar is first inverted, that is, dextrose and galactose are formed from it (see p. 19), and it is from these sugars that alcohol and carbonic acid originate.

**The Salts of Milk.**—The chief salt present is calcium phosphate: a small quantity of magnesium phosphate is also present. The other salts are chiefly chlorides of sodium and potassium.

## EGGS

In this country the eggs of hens and ducks are those particularly selected as foods. The *shell* is made of calcareous matter, especially calcium carbonate. The *white* is composed of a richly albuminous fluid enclosed in a network of firmer and more fibrous material. The amount of solids is 13·3 per cent.: of this 12·2 is protein in nature. The proteins are albumin, with smaller quantities of egg-globulin and ovo-mucoid (p. 45). The remainder is made up of sugar (0·5 per cent.), traces of fats, lecithin and cholesterin, and 0·6 per cent. of inorganic salts. The *yolk* is rich in food materials for the development of the future embryo. In it there are two varieties of yolk-spherules, one kind yellow and opaque (due to admixture with fat and a yellow lipochrome), and the other smaller, transparent and almost colourless: these are protein in nature, consisting of the phospho-protein called *vitellin* (p. 44). Small quantities of sugar, lecithin, cholesterin, and inorganic salts are also present.

The nutritive value of eggs is high, as they are so readily digestible; but the more an egg is cooked the more insoluble do its protein constituents become.

**MEAT**

This is composed of the muscular and connective (including adipose) tissues of certain animals. The flesh of some animals is not eaten; in some cases this is a matter of fashion; some flesh, like that of the carnivora, is stated to have an unpleasant taste; and in other cases (*e.g.* the horse) it is more lucrative to use the animal as a beast of burden.

Meat is the most concentrated and most easily assimilable of nitrogenous foods. It is our chief source of nitrogen. Its chief solid constituent is protein, and the principal protein is myosin. In addition to the extractives and salts contained in muscle, there is always a certain percentage of fat, even though all visible adipose tissue is dissected off. The fat-cells are placed between the muscular fibres, and the amount of fat so situated varies in different animals. It is particularly abundant in pork; hence the indigestibility of this form of flesh; the fat prevents the gastric juice from obtaining ready access to the muscular fibres.

The following table gives the chief substances in some of the principal meats used as food:—

Constituents	Ox	Calf	Pig	Horse	Fowl	Pike
Water . . .	76·7	75·6	72·6	74·3	70·8	79·3
Solids . . .	23·3	24·4	27·4	25·7	29·2	20·7
Proteins, including gelatin . .	20·0	19·4	19·9	21·6	22·7	18·3
Fat . . .	1·5	2·9	6·2	2·5	4·1	0·7
Carbohydrate . .	0·6	0·8	0·6	0·6	1·3	0·9
Salts . . .	1·2	1·3	1·1	1·0	1·1	0·8

The large percentage of water in meat should be particularly noted; if a man wished to take his daily quantity of 100 grammes of protein entirely in the form of meat, it would be necessary for him to consume about 500 grammes (*i.e.* a little more than 1 lb.) of meat *per diem*.

**FLOUR**

The best wheat flour is made from the interior of wheat grains, and contains the greater proportion of the starch of the grain and most of the protein. Whole flour is made from the whole grain *minus* the husk, and thus contains, not only the white interior, but also the harder and browner outer portion of the grain. This outer region contains a somewhat larger proportion of the proteins of the

grain. Whole flour contains 1 to 2 per cent. more protein than the best white flour, but it has the disadvantage of being less readily digested. Brown flour contains a certain amount of bran in addition; it is still less digestible, but is useful as a mild laxative, the insoluble cellulose mechanically irritating the intestinal canal as it passes along.

The best flour contains very little sugar. The presence of sugar indicates that germination has commenced in the grains. In the manufacture of malt from barley this is purposely allowed to go on.

When mixed with water, wheat flour forms a sticky adhesive mass called dough. This is due to the formation of gluten, and the forms of grain poor in gluten cannot be made into dough (oats, rice, &c.). Gluten does not exist in the flour as such, but is formed on the addition of water from the pre-existing soluble proteins (*e.g.* globulins) in the flour. It is a mixture of several proteins (gliadin, mucedin, gluten-fibrin, &c.).

The following table contrasts the composition of some of the more important vegetable foods:—

Constituents	Wheat	Barley	Oats	Rice	Lentils	Peas	Potatoes
Water . . .	13·6	13·8	12·4	13·1	12·5	14·8	76·0
Protein . . .	12·4	11·1	10·4	7·9	24·8	23·7	2·0
Fat . . .	1·4	2·2	5·2	0·9	1·9	1·6	0·2
Starch . . .	67·9	64·9	57·8	76·5	54·8	49·3	20·6
Cellulose . . .	2·5	5·3	11·2	0·6	3·6	7·5	0·7
Mineral salts . . .	1·8	2·7	3·0	1·0	2·4	3·1	1·0

We see from this table—

1. The great quantity of starch always present.
2. The small quantity of fat; that bread is generally eaten with butter is a popular recognition of this fact.

Protein, except in potatoes, is pretty abundant, and especially so in the pulses (lentils, peas, &c.). The protein in the pulses is not gluten, but consists of vitellin and globulin-like substances.

In the mineral matters in vegetables, salts of potassium and magnesium are, as a rule, more abundant than those of sodium and calcium.

## BREAD

**Bread** is made by cooking the dough of wheat flour mixed with yeast, salt, and flavouring materials. A ferment in the flour acts at the commencement of the process when the temperature is kept a little over that of the body, and forms dextrin and sugar from the



starch, and then the alcoholic fermentation, due to the action of the yeast, begins. The bubbles of carbonic acid, burrowing passages through the bread, make it light and spongy. This enables the digestive juices subsequently to soak into it readily and affect all parts of it. During baking the gas and alcohol are expelled from the bread, the yeast is killed, and a crust forms from the drying of the outer portions of the dough.

White bread contains, in 100 parts, 7 to 10 of protein, 55 of carbohydrate, 1 of fat, 2 of salts, and the rest water.

### COOKING OF FOOD

The cooking of foods is a development of civilisation, and much relating to this subject is a matter of education and taste rather than of physiological necessity. Cooking, however, serves many useful ends :--

1. It destroys all parasites and danger of infection. This relates, not only to bacterial growths, but also to larger parasites, such as tapeworms and trichinæ.

2. In the case of vegetable foods it breaks up the starch grains, bursting the cellulose and allowing the digestive juices to come into contact with granulose.

3. In the case of animal foods it converts the insoluble collagen of the universally distributed connective tissues into the soluble gelatin. The loosening of the fibres is assisted by the formation of steam between them. By thus loosening the binding material, the more important elements of the food, such as muscular fibres, are rendered accessible to the gastric and other juices. Meat before it is cooked is generally kept a certain length of time to allow *rigor mortis* to pass off.

Of the two chief methods of cooking, roasting and boiling, the former is the more economical, as by its means the meat is first surrounded with a coat of coagulated protein on its exterior, which keeps in the juices to a great extent, letting little else escape than the dripping (fat). Whereas in boiling, unless bouillon and bouilli are used, there is considerable waste. Cooking, especially boiling, renders the proteins more insoluble than they are in the raw state, but this is counterbalanced by the other advantages that cooking possesses.

**Beef Tea.**—In making beef tea and similar extracts of meat it is necessary that the meat should be placed in cold water, and this is gradually and carefully warmed. In cooking a joint it is usual to

put the meat into boiling water at once, so that the outer part is coagulated, and the loss of material minimised.

An extremely important point in this connection is that beef tea and similar meat extracts should not be regarded as foods. They are valuable as pleasant stimulating drinks for invalids, but they contain very little of the nutritive material of the meat, their chief constituents, next to water, being the salts and extractives (creatine, hypoxanthine, lactic acid, &c.) of flesh.

Many invalids restricted to a liquid diet get tired of milk, and imagine that they get sufficient nutriment by taking beef tea instead. It is very important that this erroneous idea should be corrected. One of the greatest difficulties that a physician has to deal with in these cases is the distaste which many adults evince for milk. It is essential that this should be obviated as far as possible by preparing the milk in different ways to avoid monotony. Some can take koumiss; but a less expensive variation may be introduced in the shape of junkets, which, although well known in the West of England, are comparatively unknown in other parts. The preparation of a junket consists of adding to warm milk in a bowl or dish a small quantity of rennet (Clark's essence is very good for this purpose) and flavouring material according to taste. The mixture is then put aside, and in a short time the milk sets into a jelly (coagulation of casein), which may then be served with or without cream.

**Soup** contains the extractives of meat, a small proportion of the proteins, and the principal part of the gelatin. The gelatin is usually increased by adding bones and fibrous tissue to the stock. It is the presence of this substance which causes the soup when cold to gelatinise.

### ACCESSORIES TO FOOD

Among these must be placed *alcohol*, the value of which within moderate limits is not as a food, but as a stimulant; *condiments* (mustard, pepper, ginger, curry powder, &c.), which are stomacheal stimulants, the abuse of which is followed by dyspeptic troubles; and *tea, coffee, cocoa*, and similar drinks. These are stimulants chiefly to the nervous system; tea, coffee, maté (Paraguay), guarana (Brazil), cola nut (Central Africa), bush tea (South Africa), and a few other plants used in various countries all owe their chief property to an alkaloid called *theine* or *caffeine* ( $C_8H_{10}N_4O_2$ ); cocoa to the closely related alkaloid, *theobromine* ( $C_7H_8N_4O_2$ ); coca to *cocaine*. These alkaloids are all poisonous, and used in excess, even in the form of infusions of tea and coffee, produce over-excitment,

loss of digestive power, and other disorders well known to physicians. Coffee differs from tea in being rich in aromatic matters; tea contains a bitter principle, tannin. To avoid the injurious solution of too much tannin, tea should only be allowed to infuse (draw) for a few minutes. Cocoa is not only a stimulant, but a food as well: it contains about 50 per cent. of fat and 12 per cent. of protein. In cocoa, as manufactured for the market, the amount of fat is reduced to 30 per cent., and the amount of protein rises proportionally to about 20 per cent.

*Green vegetables* are taken as a palatable adjunct to other foods rather than for their nutritive properties. Their potassium salts are, however, abundant. Cabbage, turnips, and asparagus contain 80 to 92 water, 1 to 2 protein, 2 to 4 carbohydrates, and 1 to 1.5 cellulose per cent. The small amount of nutriment in most green foods accounts for the large meals made by and the vast capacity of the alimentary canal of herbivorous animals.

## LESSON VII

### THE DIGESTIVE JUICES

#### SALIVA

1. To a little saliva in a test-tube add acetic acid. Mucin is precipitated in stringy flakes.
2. Filter some fresh saliva to separate cells and mucus, and apply the xanthoproteic or Millon's test to the filtrate; the presence of protein is shown.
3. Put some 0·5-per-cent. starch solution into two test-tubes. Add some filtered saliva to one of them, and put both in the water-bath at 40° C. After five minutes remove them and test both fluids with iodine and Trommer's test. The saliva will be found to have converted the starch into dextrin and sugar (maltose).
4. The presence of potassium sulphocyanide (KCNS) in saliva may be shown by the red colour given by a drop of ferric chloride. This colour is discharged by mercuric chloride.
5. The reaction of saliva is alkaline to litmus paper.

#### GASTRIC DIGESTION

1. Half fill four test-tubes—  
A with water. B with 0·2-per-cent. hydrochloric acid. C with 0·2-per-cent. hydrochloric acid. D with solution of white of egg (1 to 10 of water).
  2. To A add a few drops of glycerin extract of stomach<sup>1</sup> (this contains pepsin) and a piece of a solid protein like fibrin.  
To B also add pepsin solution and a piece of fibrin.  
To C add only a piece of fibrin.  
To D add a few drops of pepsin solution and fill up the tube with 0·2-per-cent. hydrochloric acid.
  3. Put the tubes into the water-bath at 40° C. and observe them carefully.  
In A the fibrin remains unaltered.  
In B it becomes swollen, and gradually dissolves.  
In C it becomes swollen, but does not dissolve.
  4. After half an hour examine the solution in test-tube B.  
(a) Colour some of the liquid with litmus and neutralise with dilute alkali. Acid-albumin or syntonin is precipitated.  
(b) Take another test-tube, and put into it a drop of 1-per-cent. solution of copper sulphate; empty it out so that the merest trace of copper sulphate remains adherent to the wall of the tube; then add the solution from test-tube B and a few drops of strong caustic potash. A pink colour (biuret
- <sup>1</sup> Benger's liquor pepticus may be used instead of the glycerin extract of stomach.

reaction) is produced. This should be carefully compared with the violet tint given by unaltered albumin.

(c) To a third portion of the fluid in test-tube B add a drop of nitric acid proteoses or propeptones are precipitated. This precipitate dissolves on heating and reappears on cooling.

5. Repeat these three tests with the digested white of egg in test-tube D.

6. Examine an artificial gastric digestion which has been kept a week. Note the absence of putrefactive odour; in this it contrasts very forcibly with an artificial pancreatic digestion under similar circumstances.

## FERMENTS

The word **fermentation** was first applied to the change of sugar into alcohol and carbonic acid by means of yeast. The evolution of carbonic acid causes frothing and bubbling; hence the term 'fermentation.' The agent yeast which produces this is called the ferment. Microscopic investigation shows that yeast is composed of minute rapidly growing unicellular organisms (*torulæ*) belonging to the fungus group of plants.

The souring of milk, the transformation of urea into ammonium carbonate in decomposing urine, and the formation of vinegar (acetic acid) from alcohol are produced by the growth of very similar organisms. The complex series of changes known as putrefaction, which are accompanied by the formation of malodorous gases, and which are produced by the growth of various forms of bacteria, also come into the same category.

That the change or fermentation is produced by these organisms is shown by the fact that it occurs only when the organisms are present, and stops when they are removed or killed by a high temperature or by certain substances (carbolic acid, mercuric chloride, &c.) called antiseptics. The organisms produce fermentative effects by shedding out soluble ferments or enzymes.

The 'germ theory' of disease explains the infectious diseases by considering that the change in the system is of the nature of fermentation, and, like the others we have mentioned, produced by microbes; the transference of the bacteria or their spores from one person to another constitutes infection. The poisons produced by the growing bacteria appear to be either alkaloidal (ptomaines) or protein in nature. The existence of poisonous proteins is a very remarkable thing, as no profound chemical differences have yet been shown to exist between them and those which are not poisonous, but which are



FIG. 12.—Cells of the yeast plant in process of budding, between which are some bacteria. (Yeo's 'Physiology'.)

useful as foods. Snake venom is an instance of a very virulent poison of protein nature.

There is another class of chemical transformations which at first sight differ very considerably from all of these. They, however, resemble these fermentations in the fact that they occur independently of any apparent change in the agents that produce them. The agents that produce them are not living organisms, but chemical

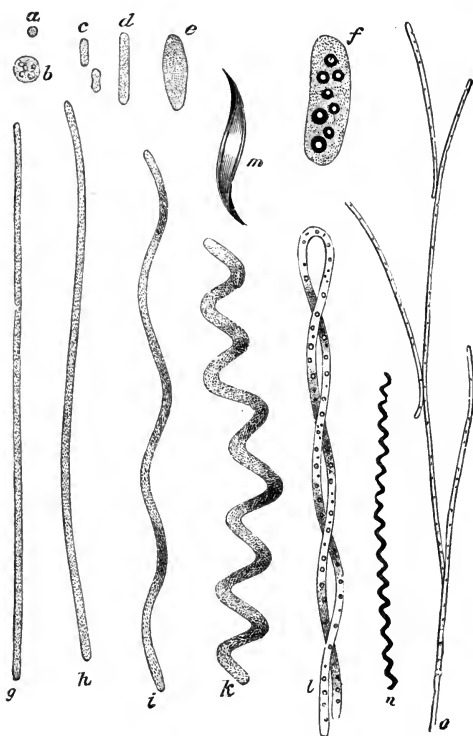

FIG. 13.—Typical forms of Schizomycetes (after Zopf) : *a*, micrococcus ; *b*, macrococcus ; *c*, bacterium ; *d*, bacillus ; *e*, clostridium ; *f*, monas Okenii ; *g*, leptothrix ; *h*, *i*, vibrio ; *k*, spirillum ; *l*, spirulina ; *m*, spirochæte ; *n*, spirochæte ; *o*, cladotrix.

substances, the result of the activity of living cells. The change of starch into sugar by the ptyalin of the saliva is an instance.

Ferments may therefore be divided into two classes:—

1. The organised ferments—torulæ, bacteria, &c.

2. The unorganised ferments or enzymes—like ptyalin.

Each may be again subdivided according to the nature of the chemical change produced.

In digestion, the study of which we are just commencing, it is the

unorganised ferments with the action of which we have chiefly to deal. The unorganised ferments may be classified as follows :—

(a) Amylolytic—those which change amyloses (starch, glycogen) into sugars. Examples : ptyalin, diastase, amylopsin.

(b) Proteolytic—those which change native proteins into proteoses and peptones. Examples : pepsin, trypsin.

(c) Steatolytic or lipolytic—those which split fats into fatty acids and glycerin. An example, steapsin, is found in pancreatic juice.

(d) Inversive—those which convert saccharoses (cane sugar, maltose, lactose) into glucose. Examples : invertin of intestinal juice and of yeast cells.

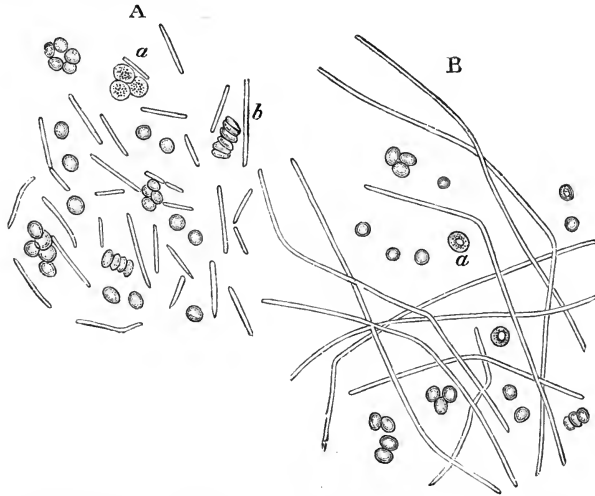
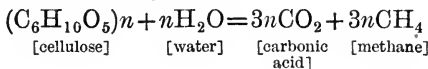

FIG. 14.—*Bacillus anthracis*, the agent that produces anthrax or splenic fever (Koch) : A, bacilli mingled with blood corpuscles from the blood of guinea-pig, some of the bacilli dividing ; B, the same after three hours' culture in a drop of aqueous humour. They grow out into long leptothrix-like filaments, which subsequently divide up, and spores are developed in the segments.

(e) Coagulative—those which convert soluble into insoluble proteins. Examples : rennet, fibrin ferment.

Most ferment actions are hydrolytic—*i.e.* water is added to the material acted on, which then splits into new materials. This is seen by the following examples :—

1. Conversion of cellulose into carbonic acid and marsh gas (methane) by putrefactive organisms.



2. Inversion of cane sugar by the unorganised ferment invertin :—

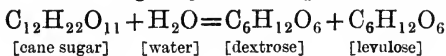

It appears also that some enzymes are oxygen carriers and produce oxidation: they are termed **oxidases**.

A remarkable fact concerning the ferments is, that the substances they produce, in time put a stop to their activity; thus in the case of the organised ferments the alcohol produced by yeast, the phenol, cresol, &c., produced by putrefactive organisms from proteins, first stop the growth of, and ultimately kill, the organisms which produce them. In the case of the unorganised ferments the products of their activity hinder and finally stop their action, but on the removal of these products the ferments resume work.

This fact suggested to Croft Hill the question whether ferments will act in the reverse manner to their usual action; and in the case of one ferment, at any rate, he found this to be the case. Inverting ferments, as we have just seen, usually convert a disaccharide into monosaccharides. One of these inverting ferments, called *maltase*, converts maltose into dextrose. If, however, the ferment is allowed to act on strong solutions of dextrose, it converts a small proportion of that sugar back into maltose. 'Reversible action' has since this been shown to occur in the case of other enzymes.

Ferments act best at a temperature of about 40° C. Their activity is stopped, but the ferments are not destroyed, by cold; it is stopped and the ferments killed by great heat. A certain amount of moisture and oxygen is also necessary; there are, however, certain micro-organisms that act without free oxygen: these are called **anaërobic**, in contradistinction to those that require oxygen, and which are therefore called **aërobic**.

The chemical nature of the enzymes is very difficult to investigate; they are substances that to a great extent elude the grasp of the chemist. So far research has taught us that they are either protein in nature or are substances closely allied to the proteins.

The distinction between organised ferments and enzymes is, however, more apparent than real; for the micro-organisms exert their action by enzymes that they secrete. This has long been known in connection with the invertin of yeast and with the enzyme secreted by the micrococcus ureæ which converts urea into ammonium carbonate. In recent years Buchner by crushing yeast cells succeeded in obtaining from them an enzyme which produces the alcoholic fermentation, and there is now no doubt that what is true for yeast is true for all the organised ferments; in several cases this has already been proved experimentally.

The view at present current regarding ferment action is that they



are *catalysing* agents. That is to say, their presence induces a chemical reaction to occur rapidly which in their absence also occurs, but so slowly that any action at all is difficult to discover. To use the technical phrase, their action is to increase the *velocity* of chemical reactions. The enzymes are catalysts of a colloidal nature, and certain properties, in which they differ from most inorganic catalysts are due to this circumstance.

### THE SALIVA

The secretion of **saliva** is a reflex action; the taste or smell of food excites the nerve-endings of the afferent nerves (glossopharyngeal and olfactory); the efferent or secretory nerves are contained in the chorda tympani (a branch of the seventh cranial nerve) which supplies the submaxillary and sublingual, and in a branch of the glossopharyngeal which supplies the parotid. The sympathetic branches which supply the blood-vessels with constrictor nerves contain in some animals secretory fibres also.

The parotid gland is called a serous or albuminous gland; before secretion the cells of the acini are swollen out with granules; after secretion has occurred the cells shrink, owing to the granules having been shed out to contribute to the secretion (see fig. 15).

The submaxillary and sublingual glands are called mucous glands: their secretion contains mucin. Mucin is absent from parotid saliva. The granules in the cells are larger than those of the parotid gland: they are composed of mucinogen, the precursor of mucin (see fig. 16).

In a section of a mucous gland prepared in the ordinary way the mucinogen granules are swollen out, and give a highly refracting appearance to the mucous acini (see fig. 17).

### COMPOSITION OF SALIVA

On microscopic examination of mixed saliva a few epithelial scales from the mouth and salivary corpuscles from the tonsils are seen. The liquid is transparent, slightly opalescent, of slimy consistency, and may contain lumps of nearly pure mucin. On standing it becomes cloudy owing to the precipitation of calcium carbonate, the carbonic acid which held it in solution as bicarbonate escaping.

Of the three forms of saliva which contribute to the mixture found in the mouth, the sublingual is richest in solids (2.75 per cent.).

The submaxillary saliva comes next (2·1 to 2·5 per cent.). When artificially obtained by stimulation of nerves in the dog the saliva obtained by stimulation of the sympathetic is richer in solids than that obtained by stimulation of the chorda tympani. The parotid saliva is poorest in total solids (0·3 to 0·5 per cent.), and contains no mucin. Mixed saliva contains in man an average of about 0·5 per cent. of solids: it is alkaline in reaction, due to the salts in it; and has a specific gravity of 1002 to 1006.

The solid constituents dissolved in saliva may be classified thus:—

<b>Organic</b>	{	a. Mucin: this may be precipitated by acetic acid.
		b. Ptyalin: an amylolytic ferment.
		c. Protein: of the nature of a globulin.
		d. Potassium sulphocyanide.
<b>Inorganic</b>	{	e. Sodium chloride: the most abundant salt.
		f. Other salts: sodium carbonate; calcium phosphate and carbonate; magnesium phosphate; potassium chloride.

### THE ACTION OF SALIVA

The action of saliva is twofold, physical and chemical.

The physical use of saliva consists in moistening the mucous membrane of the mouth, assisting the solution of soluble substances in the food, and in virtue of its mucin lubricating the bolus of food to facilitate swallowing.

The chemical action of saliva is due to its active principle, ptyalin. This substance belongs to the class of *unorganised ferments* or *enzymes*, and to that special class of unorganised ferments which are called *amylolytic* (starch-splitting) or *diastatic* (resembling diastase, the similar ferment in germinating barley and other grains).

The starch is first split into dextrin and maltose; the dextrin is subsequently converted into maltose also: this occurs more quickly with erythro-dextrin, which gives a red colour with iodine, than with the other variety of dextrin called achroö-dextrin, which gives no colour with iodine. Brown and Morris give the following equation:—

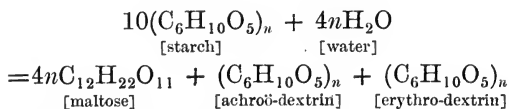

Ptyalin acts in a similar way, but more slowly on glycogen: it

has no action on cellulose; hence it is inoperative on uncooked starch grains, for in these the cellulose layers are intact.

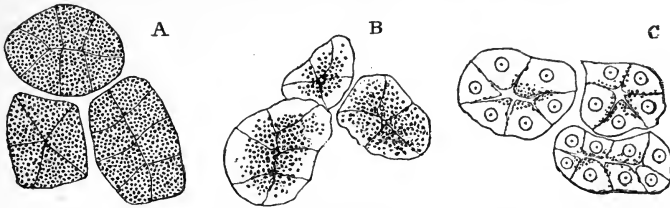

FIG. 15.—Alveoli of serous gland; A, loaded before secretion; B, after a short period of active secretion; C, after a prolonged period. (Langley.)

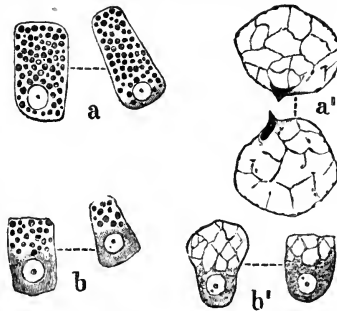

FIG. 16.—Mucous cells from a fresh submaxillary gland of dog: *a*, loaded with mucinogen granules before secretion; *b*, after secretion: the granules are fewer, especially at the attached border of the cell; *a'* and *b'* represent cells in a loaded and discharged condition respectively which have been irrigated with water or dilute acid. The mucous granules are swollen into a transparent mass of mucin traversed by a network of protoplasmic cell-substance. (Foster, after Langley.)

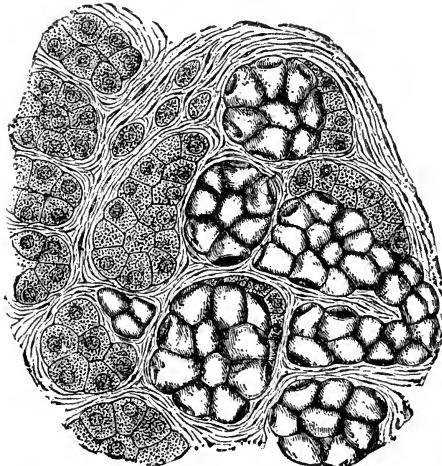

FIG. 17.—Section of part of the human submaxillary gland. (Heidenhain.) To the right is a group of mucous alveoli, to the left a group of serous alveoli.

Ptyalin acts best about the temperature of the body ( $35-40^{\circ}$ ), and in a neutral medium; a small amount of alkali makes but

little difference; a very small amount of acid stops its activity. The conversion of starch into sugar by saliva in the stomach continues for a considerable time, for the swallowed masses which fall into the fundus of the stomach are not subjected to peristalsis and admixture with gastric juice until a later stage in digestion; the hydrochloric acid which is poured out by the gastric glands first neutralises the saliva and combines with the proteins in the food; but immediately free hydrochloric acid appears the ptyalin is destroyed, so that it does not resume work even when the semi-digested food once more becomes alkaline in the duodenum.

### THE SECRETION OF GASTRIC JUICE

The juice secreted by the glands in the mucous membrane of the stomach varies in composition in the different regions, but the mixed juice is a solution of a proteolytic ferment called pepsin in a saline solution, which also contains a little free hydrochloric acid.

The gastric juice can be obtained during the life of an animal by means of a gastric fistula. Gastric fistulae have also been made in human beings, either by accidental injury or by surgical operations. The most celebrated case is that of Alexis St. Martin, a young Canadian who received a musket wound in the abdomen in 1822. Observations made on him by Dr. Beaumont formed the starting-point for our correct knowledge of the physiology of the stomach and its secretion.

We now make artificial gastric juice by mixing weak hydrochloric acid (0.2 to 0.4 per cent.) with a glycerin or aqueous extract of the stomach of a recently killed animal. This acts like the normal juice.

Three kinds of glands are distinguished in the stomach, which differ from each other in their position, in the character of their epithelium, and in their secretion. The *cardiac glands* are simple tubular glands quite close to the cardiac orifice. The *fundus glands* are those situated in the remainder of the cardiac half of the stomach: their ducts are short, their tubules long in proportion. The latter are filled with polyhedral cells, only a small lumen being left: they are more closely granular than the corresponding cells in the pyloric glands. They are called *principal* or *central* cells. Between them and the basement membrane of the tubule are other cells which stain readily with aniline dyes. They are called *parietal* or *oxyntic* (*i.e.* acid-forming) cells. The *pyloric glands*, in the pyloric half of the stomach, have long ducts and short tubules lined with cubical cells. There are no parietal cells.

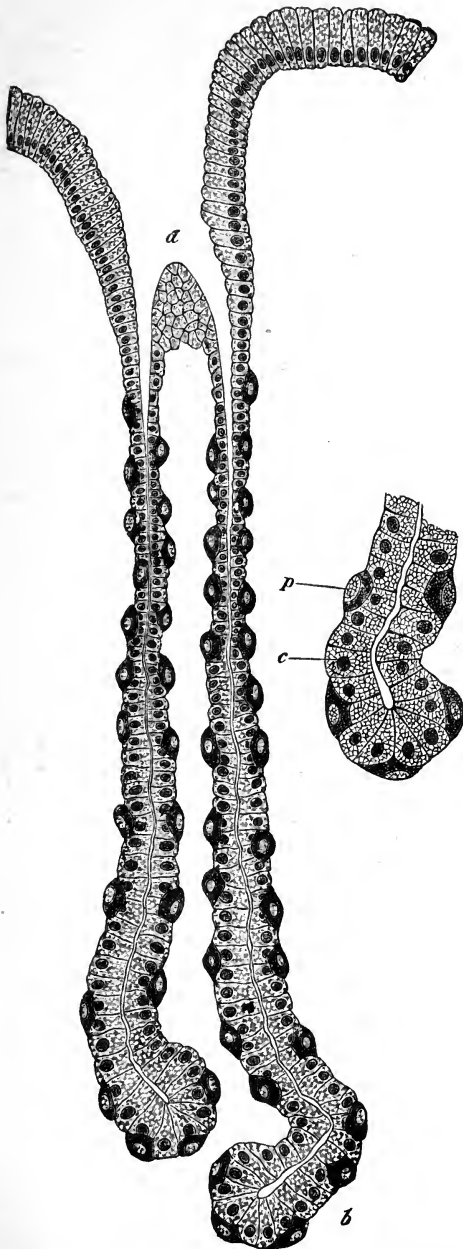

FIG. 18.—A fundus gland from the dog's stomach (Klein): *d*, duct or mouth of the gland; *b*, base of one of its tubules; on the right the base of a tubule is more highly magnified; *c*, central cell; *p*, parietal cell.

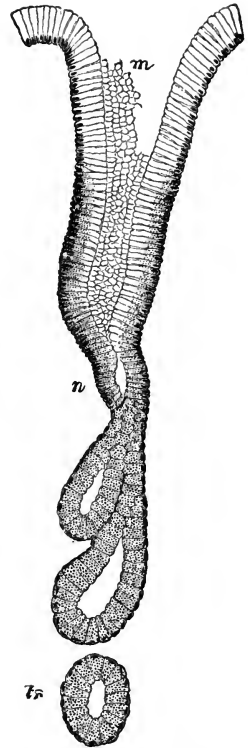

FIG. 19.—A pyloric gland from a section of the dog's stomach (Ebstein): *m*, mouth; *n*, neck; *tr*, a deep portion of tubule cut transversely.

The **central cells** of the fundus glands and the cells of the pyloric glands are loaded with granules. During secretion they discharge their granules, those that remain being chiefly situated near the lumen, leaving in each cell a clear outer zone (see fig. 20). These are the cells that secrete the pepsin. Like secreting cells generally, they select certain materials from the lymph that bathes them: these materials are worked up by the protoplasmic activity of the

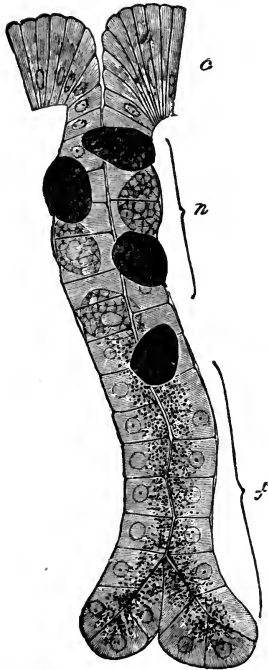

FIG. 20.—A fundus gland of simple form from the bat's stomach. Osmic acid preparation (Langley): *c*, columnar epithelium of the surface; *n*, neck of the gland, with central and parietal cells; *f*, base occupied only by principal or central cells, which exhibit the granules accumulated towards the lumen of the gland.

cells into the secretion, which is then discharged into the lumen of the gland. The most important substance in a digestive secretion is the ferment. In the case of a gastric juice this is pepsin. We can trace an intermediate step in this process by the presence of the granules. The granules are not, however, composed of pepsin, but of a mother-substance, which is readily converted into pepsin. We shall find a similar ferment precursor in the cells of the pancreas, and the term *zymogen* is applied to these ferment precursors. The zymogen in the gastric cells is called *pepsinogen*. The rennet-ferment or rennin that causes the curdling of milk is distinct from pepsin,<sup>1</sup> and is preceded by another zymogen; it is, however, formed by the same cells.

The **parietal cells** are also called oxyntic cells, because they secrete the hydrochloric acid of the juice. Heidenhain succeeded in making in one dog a *cul-de-sac* of the fundus, in another of the pyloric region of the stomach; the former secreted a juice containing both acid and pepsin; the latter, parietal cells being absent, secreted a viscid alkaline juice containing pepsin. The formation of a free acid from the alkaline blood and lymph is an important but puzzling problem. There is no doubt that it is formed from the chlorides of the blood and lymph, and of the chemical theories advanced as to how this is done, Maly's is the most satisfactory. He considers that the

<sup>1</sup> The individuality of rennin has been questioned by Pawlow, who regards its action as a phase of pepsin activity.

acid originates by the interaction of sodium chloride and sodium dihydrogen phosphate, as is shown in the following equation:—

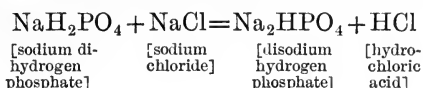

The sodium dihydrogen phosphate in the above equation is probably derived from the interaction of the disodium hydrogen phosphate and the carbonic acid of the blood, thus:—

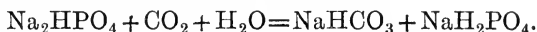

Other theories have tried to explain the formation of such a strong acid as hydrochloric by the law of 'mass action.' We know that by the action of large quantities of carbonic acid on salts of the mineral acids the latter may be liberated in small quantities. We know, further, that small quantities of acid ions may be continually formed in the organism by ionisation. But in every case we can only make use of these explanations if we assume that the small quantities of acid are carried away as soon as they are formed, and thus give room for the formation of fresh acid. Even then it is impossible to explain the whole process. A specific action of the cells is no doubt exerted, for these reactions can hardly be considered to occur in the blood generally, but rather in the oxyntic cells, which possess the necessary selective powers in reference to the constituents of the blood, and the hydrochloric acid, as soon as it is formed, passes into the secretion of the gland in consequence of its high power of diffusion.

### COMPOSITION OF GASTRIC JUICE

The following table gives the percentage composition of the gastric juice of man and dog:—

Constituents	Human	Dog
Water . . . . .	99.44	97.30
Organic substances (chiefly pepsin) . . . . .	0.32	1.71
HCl . . . . .	0.20	0.50
CaCl <sub>2</sub> . . . . .	0.006	0.06
NaCl . . . . .	0.14	0.25
KCl . . . . .	0.05	0.11
NH <sub>4</sub> Cl . . . . .	—	0.05
Ca <sub>3</sub> (PO <sub>4</sub> ) <sub>2</sub> . . . . .	0.01	0.17
Mg <sub>3</sub> (PO <sub>4</sub> ) <sub>2</sub> . . . . .		0.02
FePO <sub>4</sub> . . . . .		0.008

One sees from this how much richer in all constituents the gastric juice of the dog is than that of man. Carnivorous animals have always a more powerful gastric juice than other animals: they have more work for it to do; but the great contrast seen in the table is, no doubt, partly due to the fact that the persons from whom it has been possible to collect gastric juice have been invalids. In the foregoing table one also sees the great preponderance of chlorides over other salts: apportioning the total chlorine to the various metals present, that which remains over must be combined with hydrogen to form the free hydrochloric acid of the juice.

Pepsin stands apart from nearly all other ferments by requiring an acid medium in order that it may act. A compound of the two substances called *pepsin-hydrochloric acid* is the really active agent. Other acids may take the place of hydrochloric acid, but none act so well. Lactic acid is often found in gastric juice; this, however, is derived by fermentative processes from the food.

Pawlow has shown that in dogs the secretory fibres for the gastric glands are contained in the vagus nerves.

By an ingenious surgical operation he succeeded in separating off from the stomach a diverticulum which pours its secretion through an opening in the abdominal wall. This small stomach was found to act in every way like the main stomach of the animal. The pure juice so obtained is clear and colourless: it has a specific gravity of 1003 to 1006. It is feebly dextro-rotary, and gives some of the protein reactions. It contains from 0.4 to 0.6 per cent. of hydrochloric acid. It is strongly proteolytic, and inverts cane sugar. When cooled to 0° C. it deposits a fine precipitate of pepsin: this settles in layers, and the layers first deposited contain most of the acid, which is loosely combined with and carried down by the pepsin. Pepsin is also precipitable by saturation with ammonium sulphate (Kühne). Elementary analysis gave the following results:—

Pepsin precipitated by cold—	Precipitated by $(\text{NH}_4)_2\text{SO}_4$
Carbon . . . . 50.73 per cent.	50.37
Hydrogen . . . . 7.23 „	6.88
Chlorine . . . . 1.01 to 1.17 „	0.89
Sulphur . . . . 0.98 „	1.34
Nitrogen . . . . not estimated	14.55 to 15.0
Oxygen . . . . the remainder	the remainder.

The juice is most abundant in the early periods of digestion, but it continues to be secreted in declining quantity as long as any food remains to be dealt with. When there is no food given there is no juice. But sham feeding with meat will cause it to flow.

The larger the proportion of protein in the diet, the more abundant



and active is the juice secreted, provided the animal is hungry: the psychological element is of great importance.

### THE ACTION OF GASTRIC JUICE

The principal actions of the gastric juice have been already practically studied: the action of pepsin in converting the proteins of the food into the diffusible peptones is its chief action. The curdling of milk by rennet will be found described in Lesson VI.

There is still further action—that is, the gastric juice is anti-septic; putrefactive processes do not normally occur in the stomach, and the organisms that produce such processes, many of which are swallowed with the food, are in great measure destroyed, and thus the body is protected from them. The acid is the agent in the juice that possesses this power.

The formation of peptones is a process of hydrolysis; peptones may be formed by other hydrating agencies like superheated steam and heating with dilute mineral acids. There are certain intermediate steps in this process; the intermediate substances are called propeptones or proteoses. The word 'proteose' is the best to employ: it includes the albumoses (from albumin), globuloses (from globulin), vitelloses (from vitellin), &c. Similar substances are also formed from gelatin (gelatoses) and elastin (elastoses).

Another intermediate step in gastric digestion is acid-albumin or syntonin. In classifying the products of digestion it will be convenient to take albumin as our example, but we must remember that globulin, myosin, and all the other proteins form corresponding products. The products of digestion may be classified according to the order in which they are formed as follows:—

#### 1. Acid-albumin.

- |              |   |   |   |  |
|--------------|---|---|---|--|
| 2. Proteoses | { | (a) Proto-albumose<br>(b) Hetero-albumose<br>(c) Deutero-albumose | { | The primary albumoses, <i>i.e.</i><br>those which are formed<br>first. |
|--------------|---|---|---|--|

#### 3. Peptone.

1. **Acid albumin.**—The properties of the infra-proteins which are the first degradation products in the cleavage of the proteins which occurs during digestion have been described in Lesson V. (see pp. 29 and 48). We shall find later that, in pancreatic digestion, alkali-albumin is formed instead of acid-albumin. The theory has been put forward that a protein is capable of playing the part of a base in

virtue of its  $\text{NH}_2$  groups, and also of an acid in virtue of its  $\text{COOH}$  groups.

2. **Proteoses.**—These are the intermediate products in the hydrolysis of native proteins into peptones.

They are not coagulated by heat; they are precipitated but not coagulated by alcohol; like peptone they give the biuret reaction. They are precipitated by nitric acid, the precipitate being soluble on heating, and reappearing when the liquid cools. The last is a distinctive property of proteoses. They are slightly diffusible.

The difference between the different proteoses is mainly one of solubility. The primary proteoses (proto- and hetero-) are precipitated by saturation with magnesium sulphate or sodium chloride. Deutero-proteose is not; it is, however, precipitated by saturation with ammonium sulphate. Proto- and deutero-proteoses are soluble in water: hetero-proteose is not: it requires a salt to hold it in solution.

3. **Peptones.**—These are the final products of the action of gastric juice on native proteins. If the action is very prolonged, polypeptides and amino-acids are split off from the peptones, but in the usual short stay of food in the stomach very little of these ultimate cleavage products is found there.

They are soluble in water, are not coagulated by heat, and are not precipitated by nitric acid, copper sulphate, ammonium sulphate, and a number of other precipitants of proteins. They are precipitated but not coagulated by alcohol. They are also precipitated by tannin, picric acid, potassio-mercuric iodide, phospho-molybdic acid, and phospho-tungstic acid. They give the biuret reaction (rose-red, with a trace of copper sulphate and caustic potash or soda) and are readily diffusible through animal membranes.

To sum up: the main action of the gastric juice is upon the proteins of the food, converting them into more soluble and diffusible products. The protein envelopes of the fat globules are dissolved, and the solid fats are melted. According to some, gastric juice contains a fat-splitting ferment in small quantities which acts like the steapsin of pancreatic juice; but this action if present is very slight. Starch is unaffected; but cane sugar is inverted. The inversion of cane sugar is due to the hydrochloric acid of the juice, and is frequently assisted by inverting ferments contained in the vegetable food swallowed. The stomach does not digest itself, because it forms an antipepsin; similarly in the intestine an antitrypsin is formed. The formation of anti-bodies will be treated under the heading Immunity. (See BLOOD.)

The following table gives us at a glance the chief characters of proteoses and peptones in contrast with those of such native proteins as albumin and globulin.

Variety of protein	Action of heat	Action of alcohol	Action of nitric acid	Action of ammonium sulphate	Action of copper sulphate and caustic potash	Diffusibility
Albumin	Coagulated	Precipitated, then coagulated	Precipitated in the cold; not readily soluble on heating	Precipitated by complete saturation	Violet colour	Nil
Globulin	Ditto	Ditto	Ditto	Precipitated by half saturation; also precipitated by saturation with $MgSO_4$	Ditto	Ditto
Proteoses	Not coagulated	Precipitated but not coagulated	Precipitated in the cold; readily soluble on heating; the precipitate reappears on cooling <sup>1</sup>	Precipitated by saturation	Rose-red colour (biuret reaction)	Slight
Peptones	Not coagulated	Precipitated but not coagulated	Not precipitated	Not precipitated	Rose-red colour (biuret reaction)	Great

<sup>1</sup> In the case of deuterio-albumose this reaction only occurs in the presence of excess of salt.

## LESSON VIII

### THE DIGESTIVE JUICES (*continued*)

#### Pancreatic Digestion

1. A 1-per-cent. solution of sodium carbonate, to which a little glycerin extract of pancreas<sup>1</sup> has been added, forms a good artificial pancreatic fluid.

2. Half fill three test-tubes with this solution.

A. To this add half its bulk of diluted egg-white (1 in 10).

B. To this add a piece of fibrin.

C. Boil this; cool; then add fibrin.

3. Put all into the water-bath at 40° C. After half an hour, test A and B for alkali-albumin by neutralisation, for proteoses by nitric acid, and for proteoses and peptone by the biuret reaction.

4. Note in B that the fibrin does not swell up and dissolve, as in gastric digestion, but that it is eaten away from the edges to the interior.

5. In C no digestion occurs, as the ferments have been destroyed by boiling.

6. Take a solution of starch, equal quantities in three test-tubes.

D. To this add a few drops of glycerin extract of pancreas (without the sodium carbonate).

E. To this add a few drops of bile.

F. To this add both bile and pancreatic extract.

7. Put these into the water bath, and test small portions of each every half-minute by the iodine reaction. It disappears first in F; then in D; while E undergoes no change. Test D and F for maltose by Fehling's solution.

8. Shake up a few drops of olive oil with artificial pancreatic juice (extract of pancreas and sodium carbonate). A milky fluid (emulsion) is formed, from which the oil does not readily separate on standing.

9. The foregoing experiments illustrate the action that pancreatic juice has on all three classes of organic food.

i. *On Proteins*.—Fibrin, albumin, &c. are converted into proteoses and peptone by the ferment *trypsin* in an alkaline medium.

ii. *On Carbohydrates*.—Starch is converted into sugar (maltose) by the ferment *amyllopsin*, especially in presence of bile.

iii. *On Fats*.—These are emulsified. In the body they are also split into fatty acid and glycerin by the ferment *steapsin*; but this cannot be shown with the artificial juice, as *steapsin* is not soluble in glycerin.

#### Bile

1. Ox bile is given round. Observe its colour, taste, smell, and reaction to litmus paper.

2. Acidulate a little bile with 20-per-cent. acetic acid. A stringy precipitate

<sup>1</sup> Benger's liquor pancreaticus diluted with two or three times its volume of 1-per-cent. sodium carbonate may be used instead.

of a mucinoid substance is obtained. Filter this off and boil the filtrate; no protein coagulable by heat is present.

3. Add a few drops of bile to (a) acid-albumin prepared as described in Lesson V., and (b) solution of proteoses to which half its volume of 0.2-per-cent. hydrochloric acid has been added. A precipitate occurs in each case. Bile salts precipitate the unpeptonised protein which leaves the stomach.

4. *Pettenkofer's Test for Bile Salts.*—To a thin film of bile in a capsule add a drop of solution of cane sugar and a drop of concentrated sulphuric acid. A purple colour is produced. This occurs more quickly on the application of heat. The test may also be performed as follows:—Shake up some bile and cane sugar solution in a test-tube until a froth is formed. Pour concentrated sulphuric acid gently down the side of the tube: it produces a purple colour in the froth.

5. *Gmelin's Test for Bile Pigments.*—On to a little fuming nitric acid (*i.e.* nitric acid containing nitrous acid in solution) in a test-tube pour gently a little bile. Notice the succession of colours—green, blue, red, and yellow—at the junction of the two liquids. This test may also be performed in a capsule. Place a drop of fuming nitric acid in the middle of a thin film of bile: it becomes surrounded by rings of the above-mentioned colours.

6. *Hay's Test for Bile Salts.*—Take two beakers full of water; to one add a few drops of bile, or solution of bile salts. Sprinkle a little flowers of sulphur on the surface of each. It remains floating on the pure water; but where bile is present the surface tension of the water is reduced, and the sulphur consequently rapidly sinks. This test is very sensitive.

7. *Preparation of Glycocholic Acid.*—The preparation of the bile acids is usually a task of some difficulty; the following exercise is a simple one, though unfortunately, for reasons which are not explicable, it does not always succeed. Take a stoppered cylinder, place in it 200 c.c. of ox bile, 10 c.c. of hydrochloric acid, and 25 c.c. of ether, and shake vigorously. Add a crystal of glycocholic acid, and allow the mixture to stand in a cool place. In a time varying from a few minutes to some hours, a mass of crystals of glycocholic acid separates out. This may be filtered off, washed, and dissolved in a little boiling water, and filtered hot. On cooling, needle-like crystals of the acid again separate out.

8. *Cholesterin.*—(a) Examine crystals of this substance with the microscope. Heat these on a slide with a drop of sulphuric acid and water (5:1); the edges of the crystals turn red.

(b) Salkowski's reaction. Dissolve some cholesterin in chloroform in a dry test-tube, and gently shake with an equal amount of concentrated sulphuric acid; the solution turns red, and the subjacent acid acquires a green fluorescence. The chloroformic solution of cholesterin is rendered colourless by pouring it into a wet test-tube, and the colour is restored by the addition of sulphuric acid.

(c) Liebermann's reaction. Two or three drops of acetic anhydride are added to a chloroformic solution of cholesterin and then sulphuric acid drop by drop. A rose-red colour first develops; this becomes blue and finally bluish-green.

## THE PANCREAS

The **Pancreas** is a compound tubulo-racemose gland; between the secreting acini are situated little masses of epithelial cells without ducts called 'islets of Langerhans.' Examination of the secreting cells in different stages of activity reveals changes comparable to those already described in the case of salivary and gastric cells.

Granules indicating the presence of a zymogen which is called *trypsinogen* (that is, the precursor of trypsin, the most important ferment of the pancreatic juice) crowd the cells before secretion: these are discharged during secretion, so that in an animal whose pancreas has been powerfully stimulated to secrete, as by the administration of pilocarpine, the granules are seen only at the free border of the cells (see fig. 21).

As in the case of gastric juice, experiments on the pancreatic secretion are usually performed with an artificial juice, made by mixing a weak alkaline solution (1-per-cent. sodium carbonate) with an extract of pancreas. The pancreas should be kept some time before the extract is made, so as to ensure that the transformation of trypsinogen into trypsin has taken place.

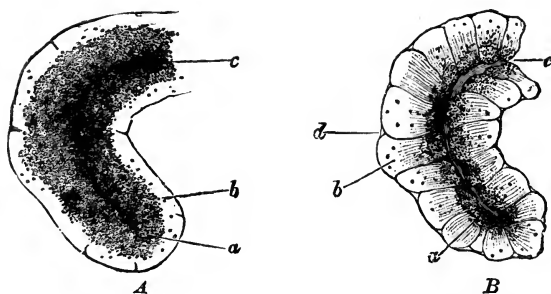

FIG. 21.—Part of an alveolus of the rabbit's pancreas: A, before discharge; B, after. (From Foster, after Kühne and Lea.)

Quantitative analysis of human pancreatic juice gives the following results:—

Water . . . . .	97.6 per cent.
Organic solids . . . . .	1.8 „
Inorganic salts . . . . .	0.6 „

Dog's pancreatic juice is considerably richer in solids.

The organic substances in pancreatic juice are:—

(a) Ferments. These are the most important both quantitatively and functionally. They are four in number:—

- i. Trypsin, a proteolytic ferment.
- ii. Amylopsin or pancreatic diastase, an amylolytic ferment.
- iii. Steapsin, a fat-splitting ferment.
- iv. A milk-curdling ferment.

(b) A small amount of protein matter, coagulable by heat.

(c) Traces of leucine, tyrosine, xanthine, and soaps.

The inorganic substances in pancreatic juice are :—

Sodium chloride, which is the most abundant, and smaller quantities of potassium chloride, and phosphates of sodium, calcium, and magnesium. The alkalinity of the juice is due to phosphates and carbonates, especially of sodium.

### ACTION OF PANCREATIC JUICE

The action of pancreatic juice, which is the most powerful and important of all the digestive juices, may be described under the headings of its four ferments.

1. **Action of Trypsin.**—Trypsin acts like pepsin, but with certain differences, which are as follows :—

(a) It acts in an alkaline, pepsin in an acid medium.

(b) It acts more rapidly than pepsin; deutero-proteoses can be detected as intermediate products in the formation of peptone. Primary (*i.e.* proto- and hetero-) proteoses have not been found; the action is apparently too rapid to admit of their detection.

(c) The first degradation product is alkali-albumin in place of the acid-albumin of gastric digestion.

(d) It acts more powerfully on certain proteins (such as elastin) which are difficult of digestion in gastric juice. Collagen, however, is not digested.

(e) Acting on solid proteins like fibrin, it eats them away from the surface to the interior; there is no preliminary swelling as in gastric digestion.

(f) Trypsin acts further than pepsin, decomposing peptone into simpler products, of which the most familiar are leucine and tyrosine.

Besides leucine and tyrosine, other amino-acids such as aspartic acid, glutamic acid, lysine, arginine, and tryptophan and ammonia are also formed. A more complete list of the cleavage products with their chemical constitution is given on pp. 31–35.

We know that the action of proteolytic enzymes is, by the process of hydrolysis, to split the heavy protein molecule into smaller and smaller molecules; first we get proteoses, then peptones, and finally after prolonged action simple substances like leucine and tyrosine.

This cleavage is more easily performed by the more powerful tryptic enzyme than by the comparatively feeble agent, pepsin-hydrochloric acid. Still we have already seen that by the very prolonged action of the latter, leucine, tyrosine, and other amino-acids

are formed, although the quantity of these in an ordinary gastric digest is negligible. The essential difference between the two enzymes is one of degree only; trypsin is by far the more powerful catalytic agent, and increases the velocity of the reaction much more markedly than does pepsin-hydrochloric acid.

2. **Action of Amylopsin.**—The conversion of starch into maltose is the most powerful and rapid of all the actions of the pancreatic juice. It is much more powerful than saliva, and will act even on unboiled starch. The absence of this ferment in the pancreatic juice of infants is an indication that milk, and not starch, is their natural diet.

3. **Action on Fats.**—The action of pancreatic juice on fats is a double one: it forms an *emulsion*, and it decomposes the fats into fatty acids and glycerin by means of its fat-splitting ferment steapsin. The fatty acids unite with the alkaline bases to form soaps (*saponification*). The chemistry of this is described on p. 25.

With regard to the formation of emulsions the following are the principal facts. If olive oil and water are shaken up together and the mixture is then allowed to stand, the finely divided oil globules soon separate from and float on the surface of the water; but if the oil is shaken up with a solution of soap, the conditions of surface tension are such that the oil globules remain as such in the mixture, and a milky fluid or emulsion is the result. This emulsion is rendered still more permanent by the presence of colloid or viscous materials, especially when a small amount of free fatty acid is being continually liberated. The acid combines with the alkali to form a soap; the soap probably forms a thin layer on the outside of each oil globule, which prevents them running together again. Pancreatic fluid possesses all the necessary qualifications for forming an emulsion. It is alkaline, and it liberates fatty acids from the fat: these acids form soap with the alkali present; moreover, it is viscous from the presence of protein.

4. **Milk-curdling Ferment.**—The addition of pancreatic extracts to milk causes clotting, which differs in some of its details from the curdling produced by rennin; but this action can hardly ever be called into play, as the milk upon which the juice has to act has been already curdled by the rennin of the stomach.



## THE SECRETION OF PANCREATIC JUICE

One of the most effective ways of producing a flow of the juice is to introduce acid into the duodenum, and no doubt the acid of the gastric juice is the normal stimulus for the pancreatic flow. This flow still occurs when all the nerves supplying the duodenum and pancreas are cut, and it was held by Popielski and by Wertheimer and Le Page that it must be due to a local reflex, the centres being situated in the scattered ganglia of the pancreas and of the solar plexus. Starling and Bayliss, however, pointed out that it cannot be a nervous reflex, since it occurs after extirpation of the solar plexus, and destruction of all nerves passing to an isolated loop of intestine. Moreover, atropine does not paralyse the secretory action. It must therefore be due to direct excitation of the pancreatic cells by a substance or substances conveyed to the gland from the bowel by the blood-stream.

The exciting substance is not acid; injection of 0.4 per cent. of hydrochloric acid into the blood-stream has no influence on the pancreas. The substance in question must be produced in the intestinal mucous membrane under the influence of the acid. This conclusion was confirmed by experiment. If the mucous membrane of the duodenum or jejunum is exposed to the action of 0.4 per cent. hydrochloric acid, a body is produced which, when injected into the blood-stream in minimal doses, produces a copious secretion of pancreatic juice. This substance is termed *secretin*. It is associated with another substance which lowers arterial blood-pressure. The two substances are not identical, since acid extracts of the lower end of the ileum produce a lowering of blood-pressure, but have no excitatory influence on the pancreas.

Secretin is split off from a precursor, *pro-secretin*, which is present in relatively large amounts in the duodenal mucous membrane, and gradually diminishes in amount throughout the intestine until it entirely disappears in the ileum. Pro-secretin can be dissolved out of the mucous membrane by normal saline solution. It has no influence on the pancreatic secretion. Secretin can be split off from it by boiling or by treatment with acid.

What secretin is chemically, we do not yet know. It is soluble in alcohol and ether. It is not a protein, but probably is an organic substance of low molecular weight. It is, moreover, the same substance in all animals, and not specific to different kinds of animals.

Whether there are any secretory nerves for the pancreas is at present doubtful. Pawlow thought he had discovered them in the

vagus; but as he did not exclude in his experiments the passage of the acid chyme from the stomach into the duodenum, it is probable that the pancreatic secretion he obtained was due to that circumstance and the consequent formation of secretin.

Injection of secretin also stimulates the flow of bile.

Secretin is an instance of the chemical messengers or *hormones* (Starling) of the body. Evidence is accumulating to show that hormones are extremely important. It has already, for instance, been shown that one called *gastrin* is formed as the result of salivary digestion, and stimulates the flow of gastric juice. Another is formed from the foetal tissues, which, passing into the mother's circulation, stimulates the mammæ to enlarge and secrete milk.

### INTESTINAL DIGESTION

The pancreatic juice does not act alone on the food in the intestines. There are, in addition, the bile, the succus entericus (secreted by the crypts of Lieberkühn), and bacterial action to be considered.

The **succus entericus** or intestinal juice has no action on fats or native proteins, but it appears to have to some extent the power of converting starch into sugar; its best known action is due to a ferment it contains called *invertin*, which inverts saccharoses—that is, converts cane sugar and maltose into glucose. The original use of the term 'inversion' has been explained on p. 17. It may be extended to include the similar hydrolysis of other saccharoses, although there may be no formation of levo-rotatory substances. There are probably several inverting ferments in the succus entericus, one of which acts on cane sugar, one on maltose, and one on milk sugar.

A few years ago, however, Pawlow showed that succus entericus has a still more important action, which is to intensify the proteolytic power of the pancreatic juice. Fresh pancreatic juice has very little power on proteins, for what it contains is not trypsin, but its precursor, trypsinogen.

If fresh pancreatic and intestinal juices are mixed together, the result is a very powerful proteolytic mixture, though neither juice by itself has any proteolytic activity. The substance in the intestinal juice that activates trypsinogen or, in other words, liberates trypsin from trypsinogen has been called by Pawlow a 'ferment of the ferments,' or *entero-kinase*.

Intestinal juice contains another ferment called *erepsin* (Otto Cohnheim), which is capable of breaking up proteoses and peptone into simple substances (leucine, tyrosine, hexone bases, ammonia, &c.), and so assisting the action of trypsin.

**Bacterial Action.**—The gastric juice is an antiseptic; the pancreatic juice is not. An alkaline fluid like pancreatic juice is just the most suitable medium for bacteria to flourish in. Even in an artificial digestion the fluid is very soon putrid, unless special precautions to exclude or kill bacteria are taken. It is often difficult to say where pancreatic action ends and bacterial action begins, as many of the bacteria that grow in the intestinal contents, having reached that situation in spite of the gastric juice, act in the same way as the pancreatic juice. Some form sugar from starch, others peptone, leucine, and tyrosine from proteins, while others again break up fats. There are, however, certain actions that are entirely or mainly due to these putrefactive organisms.

i. On carbohydrates. The most frequent fermentation they set up is the lactic acid fermentation: this may go further and result in the formation of carbonic acid, hydrogen, and butyric acid (see p. 19). Cellulose is broken up into carbonic acid and methane. This is the chief cause of the gases in the intestine, the amount of which is increased by vegetable food.

ii. On fats. In addition to acting like steapsin, lower acids (valeric, butyric, &c.) are produced. The formation of acid products from fats and carbohydrates gives to the intestinal contents an acid reaction. Recent researches show that the contents become acid much higher up in the small intestine than was formerly considered to be the case. These organic acids do not hinder pancreatic digestion to any appreciable extent.

iii. On proteins. Fatty acids and amino-acids are produced, but these putrefactive organisms are specially efficacious in liberating the protein cleavage products which have an evil odour like indole, skatole, and phenol. There are also gaseous products in some cases.

If excessive, putrefactive processes are harmful; if within normal limits, they are useful, helping the pancreatic juice and, further, preventing the entrance into the body of poisonous products. It is possible that, in digestion, poisonous alkaloids are formed. Certainly this is so in one well-known case. Lecithin, a material contained in small quantities in many foods, and in large quantities in egg-yolk and brain, is broken up by the pancreatic juice into glycerin, phosphoric acid, fatty acids, and an alkaloid called choline. We are, however, protected from the poisonous action of choline by the bacteria, which break it up into carbonic acid, methane, and ammonia.

## LEUCINE AND TYROSINE

These two substances have been frequently mentioned in the preceding pages, and they are the final cleavage products of proteins which have been longest known. *Leucine* is usually the most abundant of all the cleavage products (see table on p. 35).

We have already learnt that they are amino-acids, and that leucine is amino-caproic acid (see p. 31). There are, however, several isomeric amino-caproic acids. It was thought until quite recently

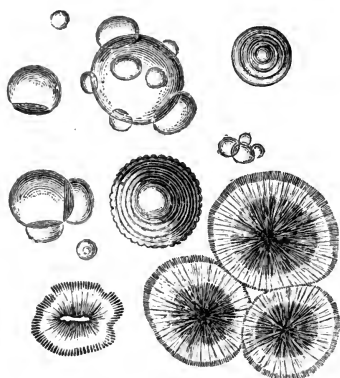
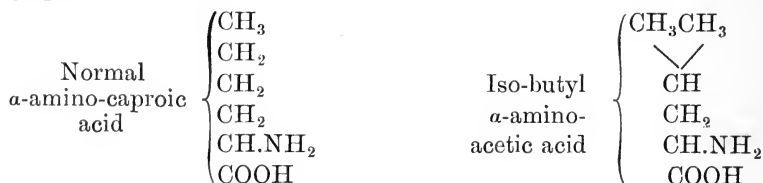

FIG. 22.—L-leucine crystals.



FIG. 23.—Tyrosine crystals.

that leucine was the amino-acid of normal caproic acid, but it has been shown to be  $\alpha$ -amino-iso-butyl-acetic acid. The difference in the structure of these two compounds may be represented by the following graphic formulæ:—



*Tyrosine* is a little more complicated, as it is not only an amino-acid, but also contains an aromatic radical (see p. 34). Figs. 22 and 23 represent the crystalline forms of leucine and tyrosine.

## EXTIRPATION OF THE PANCREAS

Complete removal of the pancreas in animals and diseases of the pancreas in man produce a condition of diabetes, in addition to the loss of pancreatic action in the intestines. Grafting the pancreas from another animal into the abdomen of the animal from which the pancreas has been previously removed relieves the diabetic condition.

How the pancreas acts otherwise than in producing the pancreatic juice is not known. It must, however, have other functions related to the general metabolic phenomena of the body, which are disturbed by removal or disease of the gland. This is an illustration of a universal truth—viz. that each part of the body does not merely do its own special work, but is concerned in the great cycle of changes which is called general metabolism. Interference with any organ upsets, not only its specific function, but causes disturbances through the body generally. The interdependence of the circulatory and respiratory systems is a well-known instance. Removal of the thyroid gland upsets the whole body, producing widespread changes known as myxœdema. Removal of the testes produces, not only a loss of the spermatic secretion, but changes the whole growth and appearance of the animal. Removal of the greater part of the kidneys produces rapid wasting and the breaking down of the tissues to form an increased quantity of urea. The precise way in which these glands are related to the general body processes is, however, a subject of which we know as yet very little. The theory at present most in favour is that certain glands produce an internal secretion, which leaves the gland *via* the lymph or venous blood, and is then distributed to minister to parts elsewhere. Removal of such glands as the thyroid or suprarenal produces disease or death because this internal secretion can no longer be formed. In the case of the pancreas, the external secretion of the pancreas (that is, pancreatic juice) is formed by the cells lining the acini, and the internal secretion, stoppage of which in some way leads to diabetes, has been attributed by some to the islets of Langerhans; but if these islets are only stages in the formation of acini, as they have been shown to be, it is difficult to fully accept this view.

In diabetes the oxidative powers of the body cells are lessened, and the capability of these cells to prepare sugar for oxidation is impaired. In this process the sugar or its derivative glycuronic acid is split into smaller molecules, and ultimately into water and carbon dioxide. The

close relationship of sugar and glycuronic acid is shown by the following formulæ:—

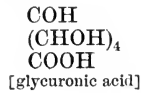
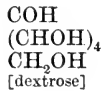

That is, two hydrogen atoms in the  $\text{CH}_2\text{OH}$  group are replaced by one of oxygen. This oxidation is readily brought about in the body, and glycuronic acid is usually found in diabetic urine; but the further oxidation into water and carbon dioxide is a more difficult task, because it involves the disruption of the linkage of the carbon atoms. Perhaps it is here that the internal secretion of the pancreas is effective. This, however, is at present a mere theory, and certainly Lépine's idea that the ferment of the pancreatic internal secretion is one which initiates glycolysis or sugar-splitting *in the blood*, has been abundantly disproved. It may be that the active principle of the pancreatic internal secretion stimulates the glycolytic action of the tissue-cells. It is conceivable that in the other great cause of experimental glycosuria, namely, injury to nervous structures, as in Bernard's puncture experiment, the derangement of the nervous system exerts some unknown influence on the pancreas as well as on the liver.

Many poisons produce temporary glycosuria, but the most interesting and powerful of these is phloridzin. The diabetes produced is very intense. Phloridzin is a glucoside, but the sugar passed in the urine is too great to be accounted for by the small amount of sugar derivable from the drug. Besides that, phloretin, a derivative of phloridzin, free from sugar, produces the same results.

Phloridzin produces diabetes in starved animals, or in those in which any carbohydrate store must have been got rid of by the previous administration of the same drug. Phloridzin-diabetes is therefore analogous to those intense forms of diabetes in man in which the sugar must be derived from protoplasmic metabolism.

A puzzling feature is the absence of an increase of sugar in the blood; if the phloridzin is directly injected into one renal artery, sugar rapidly appears in the secretion of that kidney; the sugar is formed within the kidney cells from some substance in the blood, but whether that substance is protein or not is uncertain. The action of the kidney cells in forming sugar has been compared to that of the mammary cells in forming lactose.

Death in diabetic patients is usually preceded by deep coma, or unconsciousness. Some poison must be produced that acts soporifically upon the brain. The breath and urine of these patients smell strongly of acetone; hence the term *acetonæmia*. This apple-like smell should always suggest the possible onset of coma and death, but it is quite certain that acetone (which can certainly be detected in the urine) is not the true poison; ethyl-diacetic acid, which accompanies and is the source of the acetone, was regarded by some as the actual poison; but these substances, when introduced into the circulation artificially, do not cause serious symptoms. The principal poison is  $\beta$ -hydroxybutyric acid or its amino derivative. The alkalinity and carbonic acid of the blood are decreased, and the ammonia of the urine is increased: this indicates an attempt of the body to neutralise the poisonous acid. The acid is the source of the ethyl-diacetic acid and of the acetone. Research has shown that  $\beta$ -hydroxybutyric acid originates in the body from fat.

## THE BILE

**Bile** is the secretion of the liver which is poured into the duodenum: it has been collected in living animals by means of a biliary fistula; the same operation has occasionally been performed in human beings. At death the gall bladder yields a good supply of bile which is more concentrated than that obtained from a fistula.

Bile is being continuously poured into the intestine, but there is an increased discharge immediately on the arrival of food in the duodenum; there is a second increase in secretion a few hours later.

Though the chief blood supply of the liver is by a vein (the portal vein), the amount of blood in the liver varies with its needs, being increased during the periods of digestion. This is due to the fact that in the area from which the portal vein collects blood—stomach, intestine, spleen, and pancreas—the arterioles are all dilated, and the capillaries are thus gorged with blood. Further, the active peristalsis of the intestine and the pumping action of the spleen are additional factors in driving more blood onwards to the liver.

The bile is secreted from the portal blood at a much lower pressure than one finds in glands, such as the salivary glands, the blood supply of which is arterial. Heidenhain found that the pressure in the bile duct of a dog averaged 15 mm. of mercury, which is about double that in the portal vein.

The second increase in the flow of bile—that which occurs some hours after the arrival of the semi-digested food (chyme) in the intestine—was at one time attributed to the effect of the digestive products carried by the blood to the liver stimulating the hepatic cells to activity: this was supported by the fact that protein food increases the quantity of bile secreted, whereas fatty food, which is absorbed, not by the portal vein, but by the lacteals, has no such effect. The facts are now more readily explained by the circumstance that secretin is a stimulant of the liver as well as of the pancreas.

The chemical processes by which the constituents of the bile are formed are obscure. We, however, know that the biliary pigment is



FIG. 24.—Hæmatoidin crystals.

produced by the decomposition of hæmoglobin. Bilirubin is, in fact, identical with the iron-free derivative of hæmoglobin called hæmatoidin, which is found in the form of crystals in old blood-clots such as occur in the brain after cerebral hæmorrhage (see fig. 24).

An injection of hæmoglobin into the portal vein, or of substances such as water which liberate hæmoglobin from the red blood corpuscles, produces an increase of bile pigment. If the spleen takes any part in the elaboration of bile pigment, it does not proceed so far as to liberate hæmoglobin from the corpuscles. No free hæmoglobin is discoverable in the blood plasma in the splenic vein.

The amount of bile secreted is differently estimated by different observers; the amount secreted daily in man appears to vary from 500 c.c. to 1 litre (1,000 c.c.).

### THE CONSTITUENTS OF BILE

The constituents of the bile are the bile salts proper (taurocholate and glycocholate of soda), the bile pigments (bilirubin, biliverdin), a mucinoid substance, small quantities of fats, soaps, cholesterin, lecithin, urea, and mineral salts, of which sodium chloride and the phosphates of iron, calcium, and magnesium are the most important.

Bile is a yellowish, reddish-brown or green fluid, according to the relative preponderance of its two chief pigments. It has a musk-like odour, a bitter-sweet taste, and a neutral or faintly alkaline reaction.

The specific gravity of human bile from the gall bladder is 1026 to 1032; that from a fistula, 1010 to 1011. The greater concentration of gall-bladder bile is partly but not wholly explained by the addition to it from the walls of that cavity of the mucinoid material.

The amount of solids in gall-bladder bile varies from 9 to 14 per cent., in fistula bile from 1.5 to 3 per cent. The following table shows that this low percentage of solids is almost entirely due to want of bile salts. This can be accounted for in the way first suggested by Schiff—that there is normally a bile circulation going on in the body; a large quantity of the bile salts that passes into the intestine is first split up, then reabsorbed and again secreted. Such a circulation would obviously be impossible in cases where all the bile is discharged to the exterior.

The following table gives some important analyses of human bile:—



Constituents	Fistula bile (healthy woman. Copeman and Winston)	Fistula bile (case of cancer. Yeo and Herroun)	Normal bile (Frerichs)
Sodium glycocholate . . .	0·6280	0·165	9·14
Sodium taurocholate . . .		0·055	
Cholesterin, lecithin, fat	0·0990	0·038	1·18
Mucinoid material . . .	0·1725	0·148	2·98
Pigment . . . . .	0·0725		
Inorganic salts . . . . .	0·4510	0·878	0·78
Total solids . . . . .	1·4230	1·284	14·08
Water (by difference) . . .	98·5570	98·716	85·92
	100·0000	100·000	100·00

**Bile Mucin.**—There has been considerable diversity of opinion as to whether bile mucin is really mucin. The most recent work in Hammarsten's laboratory shows that differences occur in different animals. Thus in the ox there is very little true mucin, but a great amount of nucleo-protein; in human bile, on the other hand, there is very little if any nucleo-protein; the mucinoid material present there is really mucin. (On the general characters of MUCIN and NUCLEO-PROTEINS see pp. 45 to 47.)

**The Bile Salts.**—The bile contains the sodium salts of complex amino-acids called the bile acids. The acids most frequently found are glycocholic and taurocholic acids. The former is more abundant in the bile of man and herbivora; the latter in carnivora like the dog. The most important difference between the two acids is that taurocholic acid contains sulphur, and glycocholic acid does not.

**Glycocholic acid** ( $C_{26}H_{43}NO_6$ ) is by the action of dilute acids and alkalis, and also in the intestine, hydrolysed and split into glycine or amino-acetic acid and cholalic acid.

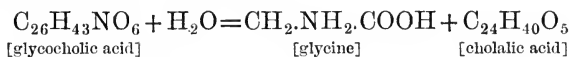

The glycocholate of soda has the formula  $C_{26}H_{42}NaNO_6$ .

**Taurocholic acid** ( $C_{26}H_{45}NO_7S$ ) similarly splits into taurine or amino-ethyl-sulphonic acid and cholalic acid,

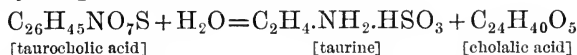

The taurocholate of soda has the formula  $C_{26}H_{44}NaNO_7S$ .

Glycocholic and taurocholic acids have lately been prepared synthetically from cholalic acid and glycine and taurine respectively.

The colour reaction called **Pettenkofer's reaction**, described in the

practical exercises at the head of this lesson, is due to the presence of cholalic acid. The sulphuric acid acting on sugar forms a small quantity of furfuraldehyde, in addition to other products. It is the furfuraldehyde which gives the purple colour with cholalic acid.

**The Bile Pigments.**—The two chief bile pigments are bilirubin and biliverdin. Bile which contains chiefly the former (such as dog's bile) is of a golden or orange-yellow colour, while the bile of many herbivora, which contains chiefly biliverdin, is either green or bluish green. Human bile is generally described as containing chiefly bilirubin, but there have been some cases described in which biliverdin was in excess. The bile pigments show no absorption bands with the spectroscope; their origin from the blood pigment has already been stated (p. 90).

**Bilirubin** has the formula  $C_{16}H_{18}N_2O_3$ : it is thus an iron-free derivative of hæmoglobin. The iron is apparently stored up in the liver cells, perhaps for future use in the manufacture of new hæmoglobin. The bile contains only a trace of iron.

**Biliverdin** has the formula  $C_{16}H_{18}N_2O_4$  (*i.e.* one atom of oxygen more than in bilirubin): it may occur as such in bile; it may be formed by simply exposing red bile to the oxidising action of the atmosphere; or it may be formed, as in Gmelin's test, by the more vigorous oxidation produced by fuming nitric acid.

**Gmelin's test** consists of a play of colours—green, blue, red, and finally yellow—produced by the oxidising action of fuming nitric acid (that is, nitric acid containing nitrous acid in solution). The end or yellow product is called *choletelin*,  $C_{16}H_{18}N_2O_6$ .

**Hydrobilirubin.**—If a solution of bilirubin or biliverdin in dilute alkali is treated with sodium amalgam or allowed to putrefy, a brownish pigment is formed called hydrobilirubin,  $C_{32}H_{44}N_4O_7$ . With the spectroscope it shows a dark absorption band between *b* and *F*, and a fainter band in the region of the *D* line.

**Urobilin.**—Hydrobilirubin is interesting because a similar substance is formed from the bile pigment by reduction processes in the intestine, and constitutes *stercobilin*, the pigment of the fæces. Some of this is absorbed and ultimately leaves the body in the urine as one of its pigments called *urobilin*. A small quantity of urobilin is sometimes found preformed in the bile. The identity of urobilin and stercobilin has been frequently disputed, but the recent work of Garrod and Hopkins has confirmed the old statement that they are the same substance with different names. Urobilin has a well-marked absorption band in the region of the *F* line, and when partially precipitated from an alkaline solution by acidification, it also shows an absorption band

in the region of the E line. Hydrobilirubin differs from urobilin in containing much more nitrogen in its molecule (9.2 instead of 4.1 per cent.), and is probably a product of less complete reduction than urobilin. (See further Lesson XXVI.) Urobilin is also formed by the oxidation of hæmopyrrol (see Hæmoglobin, p. 114).

**Cholesterin.**—This substance is contained, not only in bile, but very largely in nervous tissues. Like lecithin, it is an abundant constituent of the white substance of Schwann. It is found also in blood corpuscles, and in blood plasma as an ester of oleic and palmitic acids. The cholesterin of nervous tissues is, however, free. In bile it is normally present in small quantities only, but it may occur in excess, and so form the concretions known as gallstones, which are generally more or less tinged with bilirubin.

Though its solubilities remind one of a fat, cholesterin is not a fat, but a monatomic alcohol, probably of the terpene series. Its formula is  $C_{27}H_{45}\cdot HO$ .

From alcohol or ether containing water it crystallises in the form of rhombic tables, which contain a molecule of water of crystallisation: these are easily recognised under the microscope (fig. 25). It gives the tests described under the practical exercises on p. 79. What the physiological uses of cholesterin are is entirely unknown.

A substance called iso-cholesterin, isomeric with ordinary cholesterin, is found in the fatty secretion of the skin (sebum): it is largely contained in the preparation called lanoline made from sheep's-wool fat. It does not give Salkowski's reaction.

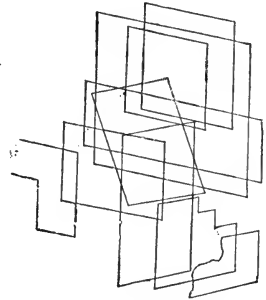

FIG. 25.—Cholesterin crystals.

## THE USES OF BILE

Bile is doubtless, to a certain extent, excretory. In some animals it has a slight action on fats and starch, but it appears to be rather a coadjutor to the pancreatic juice (especially in the digestion of fat) than to have any independent digestive activity. Its auxiliary action in starch digestion has been shown in one of our practical exercises (p. 78). It has a similar assisting power in the digestion of proteins.

Bile is said to be a natural antiseptic, lessening the putrefactive processes in the intestine. This is very doubtful. Though the bile salts are weak antiseptics, the bile itself is readily putrescible, and the power it has of diminishing putrescence in the intestine is due

chiefly to the fact that by increasing absorption it lessens the amount of putrescible matter in the bowel.

When the bile meets the chyme the turbidity of the latter is increased, owing to the precipitation of unpeptonised protein. This is an action due to the bile salts, and it has been surmised that this conversion of the chyme into a more viscid mass is to hinder somewhat its progress through the intestines: it clings to the intestinal wall, thus allowing absorption to take place. The neutralisation of the acid gastric juice by the bile also allows the alkalinity of the pancreatic juice to have full play. Bile is a solvent of fatty acids, and assists the absorption of fat.

### THE FATE OF THE BILIARY CONSTITUENTS

We have seen that fistula bile is poor in solids as compared with normal bile, and that this is explained on the supposition that the normal bile circulation is not occurring—the liver cannot excrete what it does not receive back from the intestine. Schiff was the first to show that if the bile is led back into the duodenum, or even if the animal is fed on bile, the percentage of solids in the bile excreted is at once raised. It is on these experiments that the theory of a bile circulation is mainly founded. The bile circulation relates, however, chiefly, if not entirely, to the bile salts: they are found but sparingly in the fæces; they are only represented to a slight extent in the urine; hence it is calculated that seven-eighths of them are reabsorbed from the intestine. Small quantities of cholalic acid, taurine, and glycine are found in the fæces; the greater part of these products of the decomposition of the bile salts is taken by the portal vein to the liver, where they are once more synthesised into the bile salts. Some of the taurine is absorbed and excreted as tauro-carbamic acid ( $C_2H_4NHCO.NH_2HSO_3$ ) in the urine. Some of the absorbed glycine may be excreted as urea. The cholesterin and mucus are found in the fæces; the pigment is changed into stercobilin, a substance like hydrobilirubin. Some of the stercobilin is absorbed, and leaves the body as the urinary pigment, urobilin.

### THE FÆCES

The fæces are alkaline in reaction, and contain the following substances:—

1. Water: in health from 68 to 82 per cent.; in diarrhœa it is more abundant still.
2. Undigested food: that is, if food is taken in excess, some escapes

the action of the digestive juices. On a moderate diet unaltered protein is never found.

3. Indigestible constituents of the food : cellulose, keratin, mucin, chlorophyll, gums, resins, cholesterin.

4. Constituents digestible with difficulty : uncooked starch, tendons, elastin, various phosphates, and other salts of the alkaline earths.

5. Products of decomposition of the food : indole, skatole, phenol, acids such as fatty acids, lactic acid, &c. ; hæmatin from hæmoglobin ; insoluble soaps like those of calcium and magnesium.

6. Bacteria of all sorts and *débris* from the intestinal wall ; cells, nuclei, mucus, &c. This forms a very large contribution.

7. Bile residues : mucus, cholesterin, traces of bile acids and their products of decomposition, stercobilin from the bile pigment.<sup>1</sup>

### MECONIUM

Meconium is the name given to the greenish-black contents of the intestine of new-born children. It is chiefly concentrated bile, with *débris* from the intestinal wall. The pigment is a mixture of bilirubin and biliverdin ; it is not stercobilin.

### ABSORPTION

Food is digested in order that it may be absorbed. It is absorbed in order that it may be assimilated—that is, become an integral part of the living material of the body.

Having now considered the action of digestive juices, we can study the absorption which follows. In the mouth and œsophagus the thickness of the epithelium and the quick passage of the food through these parts reduce absorption to a minimum. Absorption takes place to a small extent in the stomach ; the small intestine, with its folds and villi to increase its surface, is, however, the great place for absorption ; and, although the villi are absent from the large intestine, absorption occurs there also, but to a less extent.

Foods such as water and soluble salts like sodium chloride are absorbed unchanged. The organic foods, however, are considerably changed, colloid materials like starch and protein being converted respectively into the diffusible materials sugar and amino-acids.

There are two channels of absorption, the blood vessels (portal capillaries) and the lymphatic vessels or lacteals.

Absorption, however, is no mere physical process of diffusion and filtration. We must also take into account the fact that the cells

<sup>1</sup> Stercobilin may originate also from the hæmatin of the food. (MacMunn.)

through which the absorbed substances pass are living, and in virtue of their vital activity not only select materials for absorption, but also change those substances while in contact with them. These cells are of two kinds: (1) the columnar epithelium that covers the surface; and (2) the lymph cells in the lymphoid tissue beneath. It is now generally accepted that of the two the former, the columnar epithelium, is the more important. When these cells are removed, or rendered inactive by sodium fluoride, absorption practically ceases, though the opportunities for simple filtration or diffusion would be by such means increased.

**Absorption of Carbohydrates.**—Though the sugar formed from starch by ptyalin and amylopsin is maltose, that found in the blood is glucose. Under normal circumstances little if any is absorbed by the lacteals. The glucose is formed from the maltose by the succus entericus, and perhaps also by the vital action of the epithelial cells. Cane sugar and milk sugar are also converted into glucose before absorption.

The carbohydrate food which enters the blood as glucose is taken to the liver, and there stored up in the form of glycogen—a reserve store of carbohydrate material for the future needs of the body. Glycogen, however, is found in animals which take no carbohydrate food. It must then be formed by the protoplasmic activity of the liver cells from their protein constituents. The carbohydrate store leaves the liver in the blood of the hepatic vein as glucose (dextrose) once more.

The above is a brief statement of the glycogenic functions of the liver as taught by Claude Bernard, and accepted by the majority of physiologists. It has always been strongly contested by Pavy, who holds that the glycogen formed in the liver from the sugar of the portal blood is never during life reconverted into sugar, but is used in the formation of other substances like fat and protein; in support of this he has shown that proteins contain a carbohydrate radical. He denies that the post-mortem formation of sugar from glycogen that occurs in an excised liver is a true picture of what occurs during life.

**Absorption of Proteins.**—It is possible that under abnormal conditions a certain amount of soluble protein is absorbed unchanged. Thus, after eating a large number of eggs, egg-albumin has been stated to be discoverable in the urine. Patients fed *per rectum* derive nourishment from protein food, although proteolytic ferments are not present in this part of the intestine.

Under normal conditions, however, the food-proteins are broken

up into substances with smaller molecules, and the ready diffusibility of peptones led most physiologists to consider that protein was usually absorbed as peptone, or as proteose and peptone. But proteose and peptone are absent from the blood and lymph under all circumstances, even from the portal blood during the most active digestion. It is fortunate that this is so, for proteose and peptone when introduced into the blood produce poisonous effects; the coagulability of the blood is lessened, blood pressure falls, secretion ceases, and in the dog 0·3 gramme of commercial peptone per kilogramme of body-weight is often sufficient to produce death.

This absence of 'peptone' (using the word to include the proteoses) did not, however, absolutely negative the idea that 'peptone' is the form in which proteins are absorbed, and the difficulty was met by supposing that during absorption the products of proteolysis were reconverted into native proteins (albumins and globulins). This synthesis was further considered to be accomplished by the epithelial cells that line the intestine.

This view has now had its day, and the change of opinion that has relegated it to the past is due (1) to our increased knowledge of the power of trypsin and erepsin; (2) to a more careful examination of the intestinal contents, and of the blood during absorption. We now know that in the intestine the proteins are, by the two enzymes trypsin and erepsin, broken down beyond the peptone stage into their final cleavage products, the amino-acids, and that these probably pass into the blood as such, for the amount of non-protein nitrogen in that fluid is increased during absorption. These amino-acids are partly utilised by the cells of the body to repair their waste, but partly and to a still greater extent converted by the liver into the waste substance urea, which is finally excreted by the kidneys. The view that the absorptive epithelium of the alimentary tract has any special power in building up proteins from these simple cleavage products has not been confirmed. If an animal is fed on the cleavage products obtained from a pancreatic digest nitrogenous equilibrium is still maintained.

We thus see that the cells of the body possess the power of rebuilding the proteins peculiar to themselves from the fragments of the molecules of the food proteins. This accounts for the fact that the animal tissues retain their chemical individuality in spite of the great variations in the composition of the diet the animal takes.

If a man wishes to build a new house, and to employ for the purpose the bricks previously used in the building of another house, he takes the old house to pieces and uses the bricks and stones most

appropriate for his purpose, rearranges them in such a way that the new house has its own special architectural features, and discards as waste the bricks and stones which are not suitable. This idea underlies the term so often used by German writers, who speak of the cleavage products of protein as *Bausteine* (building stones). Each tissue has special architectural features in its protein molecules, and these molecules are reconstructed by using the *Bausteine* that previously had been used in the building of other protein molecules, either in another animal or in vegetable structures. The *Bausteine* which are in excess or are unsuitable are simply got rid of as waste substance.

A large number of the *Bausteine* are never actually built into protoplasm, but are converted by the liver into urea, and this is discharged from the body *via* the urine (see Urea formation, p. 148).

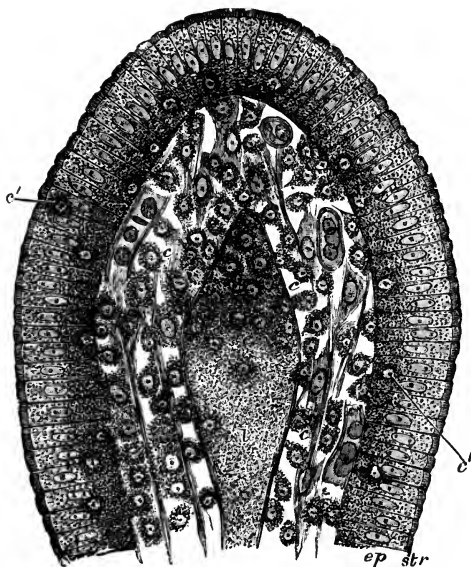

FIG. 26.—Section of the villus of a rat killed during fat-absorption (E. A. Schäfer): *ep*, epithelium; *str*, striated border; *c*, lymph cells; *c'*, lymph cells in the epithelium; *l*, central lacteal containing disintegrating lymph cells.

One can only conjecture at present which are the ones that on p. 52 we compared to diamonds, because they are unusually precious for the synthesis of protein by tissue cells; but probably phenylalanine and its near relation tyrosine come into this category, for if they are injected into the blood-stream they do not give rise to any increase in the urea formed.



**Absorption of fats.**—The fats undergo in the intestine two changes: one a physical change (emulsification), the other a chemical change (saponification). The lymphatic vessels are the great channels for fat-absorption, and their name, lacteals, is derived from the milk-like appearance of their contents (chyle) during the absorption of fat.

The way in which the minute fat globules pass from the intestine into the lacteals has been studied by killing animals at varying periods after a meal of fat and making osmic acid microscopic preparations of the villi. Figs. 26 and 27 illustrate the appearances observed.

The columnar epithelium cells become first filled with fatty globules of varying size, which are generally larger near the free border. The globules pass down the cells, the larger ones breaking up into smaller ones during the journey; they are then transferred to the amœboid cells of the lymphoid tissue beneath: these ultimately penetrate into the central lacteal, where they either disintegrate or discharge their cargo into the lymph stream. The globules are by this time divided into immeasurably small ones, the molecular basis of chyle. The chyle enters the blood stream by the thoracic duct, and after an abundant fatty meal the blood plasma is quite milky; the fat droplets are so small that they circulate without hindrance through the capillaries. The fat in the blood after a meal is eventually stored up in connective tissue cells of adipose tissue. It must, however, be borne in mind that the fat of the body is not exclusively derived from the fat of the food, but it may originate also from carbohydrates, and possibly, in the opinion of some physiologists, from protein as well.

As the fat globules were never seen penetrating the striated border of the epithelial cells, there was a difficulty in understanding how they reached the interior of these cells; the cells will not take up other particles, and it is certain that they do not in the higher animals protrude pseudopodia from their borders (this, however, does occur in the endoderm of some of the lower invertebrates).

Recent research has solved this difficulty. In the first place particles may be present in the epithelium and lymphoid cells while no fat is being absorbed. These particles are protoplasmic in nature,

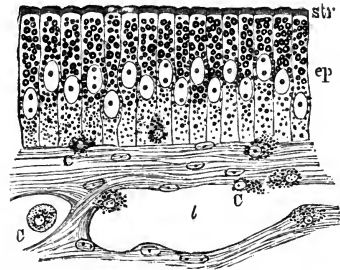

FIG. 27.—Mucous membrane of frog's intestine during fat-absorption (E. A. Schäfer): ep, epithelium; str, striated border; c, lymph cells; l, lacteal.

as they stain with reagents that stain protoplasmic granules ; but as they also stain darkly with osmic acid, they are apt to be mistaken for fat. There is, however, no doubt that the particles found during fat-absorption are composed of fat. There is also no doubt that the epithelial cells have the power of again forming fat out of the fatty acids and glycerin into which it has been broken up in the intestine. Munk, who performed a large number of experiments on the subject, showed that the splitting of fats into glycerin and fatty acids occurs to a much greater extent than was formerly supposed : these substances, being soluble, pass readily into the epithelium cells, and these cells perform the synthetic act of building them into fat once more ; the fat so formed appears in the form of small globules, surrounding or becoming mixed with the protoplasmic granules that are ordinarily present. Another remarkable fact which he made out is that after feeding an animal on fatty acids the chyle contains fat. The necessary glycerin must have been formed by protoplasmic activity during absorption. The more recent work of Moore and Rockwood has shown that fat is absorbed entirely as glycerin and either fatty acid or soap ; and that preliminary emulsification, though advantageous for the formation of these substances, is not essential.

Bile aids the digestion of fat, in virtue of its being a solvent of fatty acids, and it probably assists fat-absorption by reducing the surface tension of the intestinal contents ; membranes moistened with bile allow fatty materials to pass through them more readily than would otherwise be the case. In cases of disease in which bile is absent from the intestines a large proportion of the fat in the food passes into the fæces.

## LESSON IX

### THE BLOOD AND RESPIRATION

#### Blood Plasma.

1. The coagulation of the blood has been prevented in specimen A by the addition of neutral salt (an equal volume of saturated sodium-sulphate solution, or a quarter of its volume of saturated magnesium-sulphate solution). The corpuscles have settled, and the supernatant salted plasma has been siphoned off.

2. The coagulation of the blood in specimen B has been prevented by the addition of an equal volume of a 0.4-per-cent. solution of potassium oxalate in normal saline solution.

3. Put a small quantity of A into three test-tubes and dilute each with about ten times its volume of liquid :

A 1. With distilled water.

A 2. With solution of fibrin ferment containing a little calcium chloride.<sup>1</sup>

A 3. With the same.

4. Put A 1 and A 2 into the water-bath at 40° C. ; leave A 3 at the temperature of the air. A 1 coagulates slowly or not at all ; A 2 coagulates rapidly ; A 3 coagulates less rapidly than A 2.

5. Add to some of B a few drops of dilute (2 per cent.) calcium-chloride solution : it coagulates, and more quickly, if the temperature is 40° C.

#### Blood Serum.

Blood serum is the fluid residue of the blood after the separation of the clot ; it is blood plasma *minus* the fibrin which it yields. The general appearance of fibrin obtained by whipping fresh blood will already be familiar to the student, as he has used it in experiments on digestion.

Serum has a yellowish tinge due to serum lutein, but as generally obtained it is often contaminated with a small amount of oxyhæmoglobin, and so looks reddish. It contains proteins (giving the general tests already studied in Lesson IV.), extractives, and salts in solution. The proteins are serum albumin and serum globulin. The fibrin ferment is also a protein-like substance. It is present in only small quantities, and in the following experiments is precipitated with serum globulin.

*Separation of the serum proteins.*—(a) Dilute serum with fifteen times its volume of water. It becomes cloudy owing to the partial precipitation of

<sup>1</sup> An easy way of preparing an impure but efficient solution of fibrin ferment is to take 5 c.c. of blood serum and dilute it with a litre of distilled water. A partial precipitation of globulin takes place, and carries down the ferment with it. After a few hours pour off the supernatant fluid and dissolve the precipitate in half a litre of tap-water to which a few drops of 2-per-cent. solution of calcium chloride have been added. The solution can be then given round to the class as fibrin ferment.

serum globulin. Add a few drops of 2-per-cent. acetic acid; the precipitate becomes more abundant, but dissolves in excess of the acid.

(b) Pass a stream of carbonic acid through serum diluted with twenty times its bulk of water. A partial precipitation of serum globulin occurs.

(c) Saturate some serum with magnesium sulphate by adding crystals of the salt and grinding in a mortar. A precipitate of serum globulin is produced.

(d) Half saturate the serum with ammonium sulphate by adding to it an equal volume of a saturated solution of the salt. Serum globulin is precipitated.

(e) Completely saturate the serum with ammonium sulphate by adding crystals of the salt and grinding in a mortar; a precipitate is produced of both the globulin and the albumin. Filter through a dry filter paper; the filtrate contains no protein.

### Hæmoglobin.

6. Direct the spectroscope to the window and carefully focus Fraunhofer's lines. Note especially D in the yellow, and E, the next well-marked line, in the green.

7. Direct the spectroscope to a luminous gas flame: these lines are absent. Place a little sodium chloride in the flame. Notice the bright yellow line in the position of the D line.

8. Take a series of six test-tubes of about equal size. Fill the first with diluted defibrinated ox-blood (1 part of blood to 31 of water); then fill the second tube with the same mixture diluted with an equal bulk of water (1 in 64); half fill the third tube with this and fill up the tube with an equal bulk of water (1 in 128), and so on. The sixth tube will contain 1 part of blood to 1,024 of water, and will be nearly colourless.

9. Into another series of six test-tubes put a few drops of ammonium sulphide; then pour in some of the contents of each of the first series and warm *very* gently.

10. Examine the tubes with the spectroscope and map out on a chart the typical absorption bands of oxyhæmoglobin in the first series, and of (reduced) hæmoglobin in the second series. Notice that in the more dilute specimens of hæmoglobin the bands are no longer seen, whereas those of oxyhæmoglobin in specimens similarly diluted are still visible.

11. Take a tube which shows the single band of reduced hæmoglobin and shake it with the air; the bright red colour returns to it and it shows spectroscopically the two bands of oxyhæmoglobin for a short time. Continue watching the two bands, and note that they fade and are replaced by a single band as reduction again occurs.

12. Mix a drop of defibrinated rat's blood on a slide with a drop of water, or mount it in a drop of Canada balsam. Examine the crystals of oxyhæmoglobin as they form.

13. Smear a little blood, obtained by pricking the finger, on a slide, and allow it to dry; cover, and run glacial acetic acid under the cover glass, and boil. Examine microscopically for the dark brown crystals of hæmin.

## COAGULATION OF BLOOD

Microscopic investigation of vertebrate blood shows that it consists of a fluid which holds in suspension large numbers of solid bodies—the red and the white corpuscles and the blood platelets.

After blood is shed it rapidly becomes viscous and then sets into

a firm red jelly. The jelly soon contracts and squeezes out a straw-coloured fluid called the serum, in which the shrunken clot ultimately floats.

With the microscope, filaments of fibrin are seen forming a network throughout the fluid, many radiating from small clumps of blood platelets. It is the formation of fibrin which is the essential act of coagulation: this entangles the corpuscles and forms the clot. Fibrin is formed from the plasma, and may be obtained free from corpuscles when blood plasma is allowed to clot, the corpuscles having previously been removed. It may also be obtained from blood by whipping it with a bunch of twigs; the fibrin adheres to the twigs and entangles but few corpuscles. These may be removed by



FIG. 28.—Fibrin filaments and blood platelets: A, network of fibrin shown after washing away the corpuscles from a preparation of blood that has been allowed to clot. Many of the filaments radiate from small clumps of blood platelets. B (from Osler), blood corpuscles and blood platelets within a small vein.

washing with water. Serum is plasma *minus* the fibrin which it yields. The relation of plasma, serum, and clot can be seen at a glance in the following scheme of the constituents of the blood:—

$$\text{Blood} \left\{ \begin{array}{l} \text{Plasma} \left\{ \begin{array}{l} \text{Serum} \\ \text{Fibrin} \end{array} \right\} \\ \text{Corpuscles} \end{array} \right\} \text{Clot}$$

It may be roughly stated that in 100 parts by weight of blood 60-65 parts consist of plasma and 35-40 of corpuscles.

The *buffy coat* is seen when blood coagulates slowly, as in horse's blood. The red corpuscles sink more rapidly than the white, and the upper stratum of the clot (*buffy coat*) consists mainly of fibrin and white corpuscles.

Coagulation is hastened by—

1. A temperature a little over that of the body.
2. Contact with foreign matter.
3. Injury to the vessel walls.
4. Agitation.
5. Addition of calcium salts.
6. Injection of nucleo-protein produces intravascular clotting

(positive phase). Very minute doses, however, produce the opposite effect: namely, delay of coagulation (negative effect).

Coagulation is hindered or prevented by—

1. A low temperature. In a vessel cooled by ice, coagulation may be prevented for an hour or more.

2. The addition of a large quantity of neutral salts, like sodium sulphate or magnesium sulphate.

3. Addition of a soluble oxalate, fluoride or citrate.

4. Injection of commercial peptone (which consists chiefly of proteoses) into the circulation of the living animal.

5. Addition of leech extract to the blood, or injection of leech extract into the circulation while the animal is alive.

6. Contact with the living vascular walls.

7. Contact with oil.

The cause of the coagulation of the blood may be briefly stated as follows:—

When blood is within the vessels one of the constituents of the plasma, a protein of the globulin class called *fibrinogen*, exists in a soluble form.

When the blood is shed the fibrinogen molecule is altered in such a way that it gives rise to the comparatively insoluble material *fibrin*. The statement has been made that the fibrinogen molecule is split into two parts: one part is a globulin (fibrinoglobulin), which remains in solution; the other and larger part is the insoluble substance fibrin. It is, however, doubtful if this really represents what occurs, for recent work seems to show that the fibrinoglobulin is not a product of fibrinogen, but exists in the blood plasma beforehand. At any rate, whether this is so or not, the fact remains that fibrin is the important product and the only one which need concern us.

The next question is, What causes the transformation of fibrinogen into fibrin? And the answer to that is, that the change is due to the activity of a special unorganised ferment which is called *fibrin ferment* or *thrombin*.

This ferment does not exist in healthy blood contained in healthy blood vessels, but is formed by the *disintegration* of the blood platelets and colourless corpuscles which occurs when the blood leaves the blood vessels or comes into contact with foreign matter. Hence the blood does not coagulate during life. But, it will be said, disintegration of the blood corpuscles occurs during life; why, then, does the blood not coagulate? The reason is that although the formed elements do disintegrate in the living blood, such a phenomenon takes place

very slowly and gradually, so that there can never in normal circumstances be any massive liberation of fibrin ferment, and, further, that there are agencies at work to neutralise the fibrin ferment as it is formed. The most noteworthy of these neutralising agencies is the presence in the blood of an antiferment called *antithrombin*, analogous to the antipepsin and antitrypsin which, we have seen, are efficacious in preventing the stomach and intestines from undergoing self-digestion.

Thrombin or fibrin ferment belongs to the class of nucleo-proteins, and other nucleo-proteins (see pp. 45, 46) obtained from most of the cellular organs of the body produce intravascular clotting when injected into the circulation of a living animal. In certain diseased conditions intravascular clotting, or thrombosis, sometimes occurs. This must be due either to the entrance of nucleo-protein into the circulation from diseased tissues, or to a failure of the body to produce sufficient antithrombin to neutralise its effect, or to both of these conditions together.

Thrombin is believed to originate chiefly from the blood platelets and in part from the leucocytes. Birds' blood clots very slowly, and the absence of blood platelets in this variety of blood will in part account for this. Lymph which contains colourless corpuscles, but no platelets, also clots in time, so in this case the colourless corpuscles must be the source of the ferment. One should, however, be careful in speaking of the disintegration of leucocytes to remember that the word disintegration does not mean complete breakdown, leading to disappearance; the colourless corpuscles do not appreciably diminish in number when the blood is shed, but what occurs in the surviving leucocytes is a shedding out of certain products, among which fibrin-ferment is one.

We have now traced fibrin-formation, the essential cause of blood-clotting, to the activity of thrombin; it is next necessary to allude to what has been discovered in relation to the origin of thrombin. Like other ferments, it is preceded by a mother substance or zymogen. This zymogen is called prothrombin, or *thrombogen*, and there appear to be two necessary agents concerned in the conversion of thrombogen into thrombin: one of these is the action of *calcium salts*, the other is the presence of an activating agent, analogous to entero-kinase (see p. 84), and called *thrombo-kinase*. The exact rôle played by each is still a matter of speculation, but we may learn a good deal by studying a little more in detail some of the methods already enumerated for preventing the blood from coagulating.

The part played by calcium salts is well illustrated by the fact that coagulation is prevented by the decalcification of the blood. This can be accomplished by the addition of a small amount of soluble oxalate or fluoride to the blood immediately it is shed. The calcium of the blood plasma is then immediately precipitated as insoluble calcium oxalate or fluoride, and is thus not available for the transformation of thrombogen into thrombin. The addition of the oxalate or fluoride must be rapidly performed, otherwise time will be given for the conversion of thrombogen into thrombin, and thrombin, when formed, will act upon fibrinogen whether the calcium has been removed or not. In other words, calcium is only necessary for the formation of fibrin-ferment, and not for the action of fibrin-ferment on fibrinogen. Fibrin is thus not a compound of calcium and fibrinogen.

The action of a soluble citrate is also in a certain sense a decalcifying action, for although calcium citrate is a soluble salt it does not ionise in solution so as to liberate the free calcium ions which are essential for thrombin formation.

Oxalated blood (or oxalated plasma) will clot when the calcium is once more restored by the addition of a small amount of calcium chloride, but such an addition to fluoride plasma will not induce clotting; thrombin must be added also. In some way sodium fluoride interferes with the formation of thrombin, probably by preventing the liberation of thrombo-kinase from the formed elements of the blood.

The other activating agent, thrombo-kinase, is in part liberated from the formed elements of the blood, but it is also obtained from many other tissues. If a hæmorrhage takes place under ordinary circumstances the blood as it flows from the wound passes over the muscles and skin that have been cut, and rapidly clots owing to the thrombo-kinase supplied by those tissues. If blood is obtained by drawing it off through a perfectly clean cannula into a clean vessel without allowing it to touch the tissues, it remains unclotted for a long time; in the case of birds' blood this time may extend to many days; but the addition of a small piece of tissue such as muscle, or of an extract of such a tissue, produces almost immediate clotting. If a solution of fibrinogen is prepared and calcium added it will not clot; if thrombin or a fluid such as serum which contains thrombin is added also it will clot. It will not clot if birds' plasma obtained as above is added to it; nor if tissue extract is added to it; but if both are added it will. In other words, the thrombogen of the birds' plasma *plus* the thrombo-kinase of the tissue extract have the same effect as thrombin.



The next point to consider is why blood obtained after the previous injection of proteoses (or commercial peptone) into the circulation should not clot. It certainly contains calcium salts, and probably both thrombogen and thrombo-kinase, for it can be made to clot without the addition of either; for instance, by dilution or the passage of a stream of carbon dioxide through it. There must be something in peptone blood which antagonises the action of thrombin. This something is an excess of antithrombin. Peptone will not hinder blood coagulation, or only very slightly if it is added to the blood after it is shed. The antithrombin must therefore have been added to the blood while it was circulating in the body. We can even go further than this and say what part of the body it is which is concerned in the production of antithrombin: it is the liver, for if the liver is shut off from the circulation, peptone is ineffective in its action. The converse experiment confirms this conclusion, for if a solution of peptone is artificially perfused through an excised surviving liver, a substance is formed which has the power of hindering or preventing the coagulation of shed blood.

We are thus justified in two conclusions:—

(1) That the antithrombin which is normally present in healthy blood in sufficient quantities to prevent intravascular clotting, is formed in the liver.

(2) That commercial peptone in virtue of the proteoses it contains stimulates this action of the liver to such an extraordinary degree, that the accumulation of antithrombin in the blood becomes sufficiently great to prevent the blood from clotting even after it is shed.

It should be noted, however, that this effect upon the liver varies in different animals, and is most marked in the dog.

We shall conclude by considering only one more of the hindrances to coagulation, and that by no means the least interesting. The leech lives by sucking the blood of other animals; from the leech's point of view it is therefore necessary that the blood should flow freely and not clot. The glands at the head end of the leech, often spoken of roughly as its salivary glands, secrete something which hinders the blood from coagulating, and everyone knows by experience who has been treated by leeches how difficult it is to prevent a leech-bite from bleeding after the leech has been removed; complete cleansing is necessary to wash away the leech's secretion from the wound. Now if an extract of leeches' heads is made with salt solution and filtered, that fluid will prevent coagulation, whether it is injected into the blood-stream or added to shed blood. The substance in the extract is called *hirudin*, and this is believed to be antithrombin itself.

We may summarise our present knowledge of the causes of coagulation in the following tabular way:—

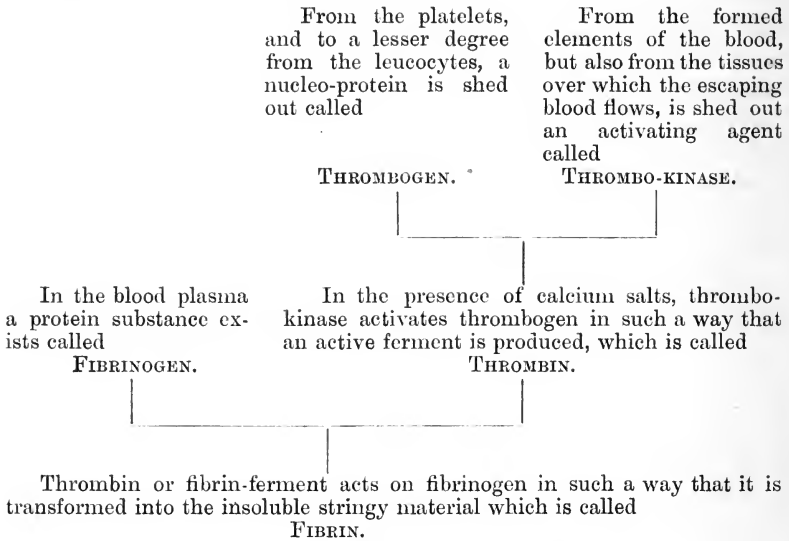

### THE PLASMA AND SERUM

The liquid in which the corpuscles float may be obtained by employing one or other of the methods already described for preventing the blood from coagulating. The corpuscles, being heavy, sink, and the supernatant plasma can then be removed by a pipette or siphon; the separation can be effected more thoroughly by the use of a centrifugal machine (see fig. 60, Lesson XXI.).

On counteracting the influence which has prevented the blood from coagulating, the plasma then itself coagulates. Thus plasma obtained by the use of cold, clots on warming gently; plasma which has been decalcified by the action of a soluble oxalate clots on the addition of a calcium salt; plasma obtained by the use of a strong solution of salt coagulates when this is diluted by the addition of water, the addition of fibrin ferment being necessary in most cases; where coagulation occurs without the addition of fibrin-ferment, no doubt some is present from the partial disintegration of the corpuscles which has already occurred. Pericardial and hydrocele fluids resemble pure plasma very closely in composition. As a rule, however, they contain few or no white corpuscles, and do not clot spontaneously, but after the addition of fibrin ferment or liquids like serum that contain fibrin ferment they always yield fibrin.

Pure plasma may be obtained from horse's veins by what is known as the 'living test-tube' experiment. If the jugular vein is ligatured in two places, so as to include a quantity of blood within it, then removed from the animal and hung in a cool place, the blood will not coagulate for many hours. The corpuscles settle, and the supernatant plasma can be removed with a pipette.

The plasma is alkaline, yellowish in tint, and its specific gravity is about 1,026 to 1,029.

Its chief constituents may be enumerated as follows:—

1,000 parts of plasma contain—

Water . . . . .	902.90
Solids . . . . .	97.10
Proteins: 1, yield of fibrin . . . . .	4.05
2, other proteins . . . . .	78.84
Extractives (including fat) . . . . .	5.66
Inorganic salts . . . . .	8.55

In round numbers plasma contains 10 per cent. of solids, of which 8 per cent. are protein in nature.

Serum contains the same three classes of constituents—proteins, extractives, and salts. The extractives and salts are the same in the two liquids. The proteins differ, as is shown in the following table:—

*Proteins of Plasma*

*Proteins of Serum*

Fibrinogen  
Serum globulin  
Serum albumin

Serum globulin  
Serum albumin  
Fibrin ferment (nucleo-protein)

The gases of the plasma and serum are small quantities of oxygen, nitrogen, and carbonic acid. The greater part of the oxygen of the blood is combined in the red corpuscles with hæmoglobin; the carbonic acid is chiefly combined as carbonates (see RESPIRATION).

We may now consider one by one the various constituents of the plasma and serum.

A. **Proteins.**—*Fibrinogen.*—This is the parent substance of fibrin. It is a globulin. It differs from serum globulin, and may be separated from it by the fact that half saturation with sodium chloride precipitates it. It coagulates by heat at the low temperature of 56° C. As judged from the yield of fibrin, it is the *least* abundant of the proteins of the plasma (see table on upper part of this page).

*Serum globulin and serum albumin.*—These substances are considered in the practical exercises at the head of this lesson; see also

Lesson IV. Both serum globulin and serum albumin probably consist of more than one protein substance (see Lesson XX.).

*Fibrin ferment.*—Schmidt's method of preparing it is to take serum and add excess of alcohol. This precipitates all the proteins, fibrin ferment included. After some weeks the alcohol is poured off; the serum globulin and serum albumin have been by this means rendered insoluble in water; an aqueous extract is, however, found to contain fibrin ferment, which is not so easily coagulated by alcohol as the other proteins are. A simpler method of preparing fibrin ferment in an impure but efficient form is given in the footnote on p. 101.

**B. Extractives.**—These are non-nitrogenous and nitrogenous. The non-nitrogenous are sugar (0.12 per cent.), fats, soaps, cholesterin; and the nitrogenous are urea (0.02 to 0.04 per cent.), and still smaller quantities of uric acid, creatine, creatinine, xanthine, and hypoxanthine.

**C. Salts.**—The most abundant salt is sodium chloride: it constitutes between 60 and 90 per cent. of the total mineral matter. Potassium chloride is present in much smaller amount. It constitutes about 4 per cent. of the total ash. The other salts are phosphates and sulphates.

Schmidt gives the following table:—

1,000 parts of plasma yield—	
Mineral matter . . . . .	8.550
Chlorine . . . . .	3.640
SO <sub>3</sub> . . . . .	0.115
P <sub>2</sub> O <sub>5</sub> . . . . .	0.191
Potassium . . . . .	0.323
Sodium . . . . .	3.341
Calcium phosphate . . . . .	0.311
Magnesium phosphate . . . . .	0.222

## THE WHITE BLOOD CORPUSCLES

These corpuscles are typical animal cells. Their nucleus consists of nuclein; their cell-protoplasm yields proteins belonging to the nucleo-protein and globulin groups. The protoplasm of these cells often contains small quantities of fat and glycerin.

## THE RED BLOOD CORPUSCLES

The red blood corpuscles are much more numerous than the white, averaging in man 5,000,000 per cubic millimetre, or 400 to 500 red to each white corpuscle. The method of enumeration of the corpuscles is described in the Appendix.

They vary in size and structure in different groups of vertebrates. In mammals they are biconcave (except in the camel tribe, where they are biconvex) non-nucleated discs, in man averaging  $\frac{1}{3200}$  inch in diameter; during foetal life nucleated red corpuscles are, however, found. In birds, reptiles, amphibians, and fishes they are biconvex oval discs with a nucleus: they are largest in the amphibia.

*Water* causes the corpuscles to swell up, and dissolves out the red pigment (oxyhæmoglobin), leaving a globular colourless stroma.

*Salt solution* causes the corpuscles to shrink: they become crenated or wrinkled.

The action of water and salt solution is explained by the existence of a membrane on the surface of the corpuscles through which osmosis takes place.

*Dilute alkalis* (0.2 per cent. potash) dissolve the corpuscles.

*Dilute acids* (1 per cent. acetic acid) act like water, and in nucleated corpuscles render the nucleus distinct.

*Tannic acid* causes a discharge of hæmoglobin from the stroma, but this is immediately altered and precipitated.

It remains adherent to the stroma as a brown globule, consisting probably of hæmatin.

*Boric acid* acts similarly, but in nucleated red corpuscles the pigment collects chiefly round the nucleus, which may then be extruded from the corpuscles.

It remains adherent to the stroma as a brown globule, consisting probably of hæmatin.

*Boric acid* acts similarly, but in nucleated red corpuscles the pigment collects chiefly round the nucleus, which may then be extruded from the corpuscles.

**Composition.**—1,000 parts of red corpuscles contain—

Water	.	.	.	.	688	parts
Solids	{	organic	.	.	303.88	"
		inorganic	.	.	8.12	"
100 parts of dried corpuscles contain—						
Protein	.	.	.	.	5 to 12	parts
Hæmoglobin	.	.	.	.	86	„ 94 „
Lecithin	.	.	.	.	1.8	part
Cholesterin	.	.	.	.	0.1	„

The protein present appears to be identical with the nucleoprotein of white corpuscles. The mineral matter consists chiefly of chlorides of potassium and sodium, and phosphates of calcium and magnesium. In man potassium chloride is more abundant than sodium chloride; this, however, does not hold good for all animals.

Oxygen is contained in combination with the hæmoglobin to form oxyhæmoglobin. The corpuscles also contain a certain amount of carbonic acid (see RESPIRATION, at the end of this lesson).

**The pigment of the red corpuscles.**—The pigment is by far the

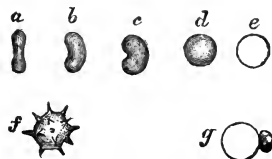

FIG. 29.—*a-c*, successive effects of water on a red blood corpuscle: *f*, a red corpuscle crenated by salt solution; *g*, action of tannin on a red corpuscle.

most abundant and important of the constituents of the red corpuscles. It differs from most other proteins in containing the element iron; it is also readily crystallisable.

It exists in the blood in two conditions: in arterial blood it is combined loosely with oxygen, is of a bright red colour, and is called oxyhæmoglobin; the other condition is the deoxygenated or reduced hæmoglobin (better called simply hæmoglobin). This is found in the blood after asphyxia. It also occurs in all venous blood—that is, blood which is returning to the heart after it has supplied the tissues with oxygen. Venous blood, however, always contains a considerable quantity of oxyhæmoglobin also. Hæmoglobin is the oxygen-carrier of the body, and it may be called a respiratory pigment.

Crystals of oxyhæmoglobin may be obtained with readiness from the blood of such animals as the rat, guinea-pig, or dog; with difficulty from other animals, such as man, ape, and most of the common mammals. The following methods are the best:—

1. Mix a drop of defibrinated blood of the rat on a slide with a drop of water; put on a cover glass; in a few minutes the corpuscles are rendered colourless, and then the oxyhæmoglobin crystallises out from the solution so formed.

2. Microscopical preparations may also be made by Stein's method, which consists in using Canada balsam instead of water in the above experiment.

3. On a larger scale the crystals may be obtained by shaking the blood with one-sixteenth of its volume of

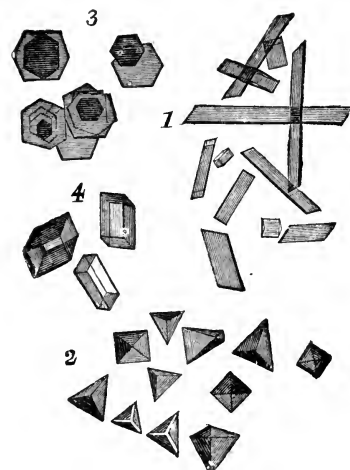

FIG. 30.—Oxyhæmoglobin crystals magnified: 1, from human blood; 2, from the guinea-pig; 3, squirrel; 4, hamster.

ether; the corpuscles dissolve and the blood assumes a *laky* appearance. After a period, varying from a few minutes to days, abundant crystals are deposited.

The accompanying figures represent the form of the crystals so obtained.

In nearly all animals the crystals are rhombic prisms; but in the guinea-pig they are rhombic tetrahedra (four-sided pyramids); in the squirrel, hexagonal plates; and in the hamster, rhombohedra and hexagonal plates.

The crystals also contain a varying amount of water of crystallisation: this may in part explain their different crystalline forms and solubilities. Different observers have analysed hæmoglobin. They find carbon, hydrogen, nitrogen, oxygen, sulphur, and iron. The percentage of iron is 0.4. Oxyhæmoglobin may be estimated in the blood (1) by the amount of iron in the ash, or (2) by certain colorimetric methods which are described in the Appendix.

Hæmoglobin is a conjugated protein (see p. 44), and on the addition of an acid or alkali it is broken up into two parts, a protein called *globin*, and a brown pigment called *hæmatin*, which contains all the iron of the original substance.

**Globin** is coagulable by heat, soluble in dilute acids, and precipitable from such solutions, by ammonia. It is a member of the group of proteins called *histones* (see p. 42).

**Hæmatin** is not crystallisable: according to Nencki and Sieber its formula is  $C_{32}H_{32}N_4O_4Fe$ . It presents different spectroscopic appearances in acid and alkaline solutions, and yields several products under the influence of certain reagents, which we shall consider in the advanced course. For the present, we shall mention only three of these, hæmin, hæmatoporphyrin, and hæmopyrrol.

**Hæmin** is of great importance, as the obtaining of this substance in a crystalline form is the best chemical test for blood. Hæmin crystals, sometimes called Teichmann's crystals, are prepared for microscopic examination by boiling a fragment of dried blood with a drop of glacial acetic acid on a slide; on cooling, dark-brown plates and prisms belonging to the triclinic system, often in star-shaped clusters and with rounded angles (fig. 31), separate out.

In the case of an old blood-stain it is necessary to add a crystal of sodium chloride. Fresh blood contains sufficient sodium chloride in itself. The action of the acetic acid is (1) to split the hæmoglobin into hæmatin and globin; and (2) to evolve hydrochloric acid from the sodium chloride. The hæmatin unites with the hydrochloric acid, and thus hæmin is formed. Nencki has further shown that, when prepared in this way, hæmin also contains the acetyl group.

**Hæmatoporphyrin** is iron-free hæmatin: it may be prepared by



FIG. 31.—Hæmin crystals magnified. (Preyer.)

mixing blood with strong sulphuric acid; the iron is taken out as ferrous sulphate. This substance is also found sometimes in nature; it occurs in certain invertebrate pigments, and may also be found in certain forms of pathological urine. It shows well-marked spectroscopic bands, and so is not identical with the iron-free derivative of hæmoglobin called hæmatoidin which is formed in extravasations of blood in the body (see p. 90). The two substances are possibly isomeric.

**Hæmopyrrol** is methyl-propyl-pyrrol, with the formula

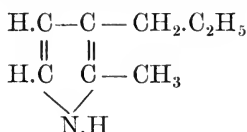

and is obtained by reduction from hæmatoporphyrin. It is also similarly obtained from the derivative of chlorophyll called phylloporphyrin, a fact which illustrates the near relationship of the principal animal and vegetable pigments.

### COMPOUNDS OF HÆMOGLOBIN WITH GASES

Hæmoglobin forms at least four compounds with gases:—

With oxygen	{	1. Oxyhæmoglobin.
		2. Methæmoglobin.
With carbonic oxide		3. Carbonic oxide hæmoglobin.
With nitric acid		4. Nitric oxide hæmoglobin.

These compounds have similar crystalline forms: each probably consists of a molecule of hæmoglobin combined with one of the gas. They part with the combined gas somewhat readily, and are arranged in order of stability in the above list, the least stable first.

**Oxyhæmoglobin** is the compound that exists in arterial blood. The oxygen linked to the hæmoglobin, which is removed by the tissues through which the blood circulates, may be called the *respiratory oxygen of hæmoglobin*. The processes that occur in the lungs and tissues, resulting in the oxygenation and deoxygenation respectively of the hæmoglobin, may be imitated outside the body, using either blood or pure solutions of hæmoglobin. The respiratory oxygen can be removed, for example, in the Torricellian vacuum of a mercurial air-pump, or by passing a neutral gas like hydrogen through the blood or by the use of reducing agents such as ammonium sulphide or



Stokes's reagent.<sup>1</sup> One gramme of hæmoglobin will combine with 1.34 c.c. of oxygen.

If any of these methods for reducing oxyhæmoglobin is used, the bright red (arterial) colour of oxyhæmoglobin changes to the purplish (venous) tint of hæmoglobin. On once more allowing oxygen to come into contact with the hæmoglobin, as by shaking the solution with the air the bright arterial colour returns.

These colour-changes may be more accurately studied with the spectroscope, and the constant position of the absorption bands seen constitutes an important test for blood pigment.

**The Spectroscope.**—When a ray of white light is passed through a prism, it is refracted or bent at each surface of the prism; the whole ray is, however, not equally bent, but it is split into its constituent colours, which may be allowed to fall on a screen. The band of colours beginning with the red, passing through orange, yellow, green, blue, and ending with violet, is called a *spectrum*: this is seen in nature in the rainbow.

The spectrum of sunlight is interrupted by numerous dark lines crossing it vertically called Fraunhofer's lines. These are perfectly constant in position, and serve as landmarks in the spectrum. The more prominent are A, B, and C, in the red; D, in the yellow; E, *b*, and F, in the green; G and H, in the violet. These lines are due to certain volatile substances in the solar atmosphere. If the light from burning sodium or its compounds is examined spectroscopically, it will be found to give a bright yellow line, or rather two bright yellow lines very close together. Potassium gives two bright red lines and one violet line; and the other elements, when incandescent, give characteristic lines, but none so simple as sodium. If now the flame of a lamp be examined, it will be found to give a continuous spectrum like that of sunlight in the arrangement of its colours, but unlike it in the absence of dark lines; but if the light from the lamp be made to pass through sodium vapour before it reaches the spectroscope, the bright yellow light will be found absent, and in its place a dark line, or rather two dark lines very close together, occupying the same position as the two bright lines of the sodium spectrum. The sodium vapour thus absorbs the same rays as those which it itself produces at a higher temperature. Thus the D line, as we term it, in the solar spectrum is due to the presence of sodium vapour in the solar atmosphere. The other dark lines are similarly accounted for by other elements.

<sup>1</sup> Stokes's reagent must always be freshly prepared: it is a solution of ferrous sulphate to which a little tartaric acid has been added, and then ammonia till the reaction is alkaline.

The large form of spectroscope (fig. 32) consists of a tube A, called the collimator, with a slit at the end S, and a convex lens at the end L. The latter makes the rays of light passing through the slit from the source of light parallel: they fall on the prism P, and then the spectrum so formed is focussed by the telescope T.

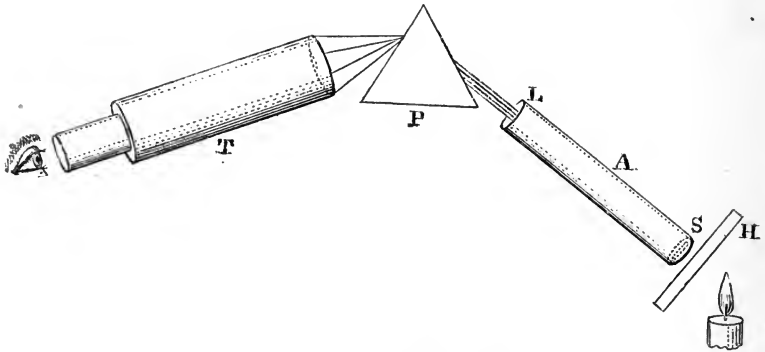

FIG. 32.—Diagram of spectroscope.

The third tube, D, seen in the next figure (fig. 33) carries a small transparent scale of wave-lengths, so that the position of any point in the spectrum may be given in terms of the corresponding wave-lengths.

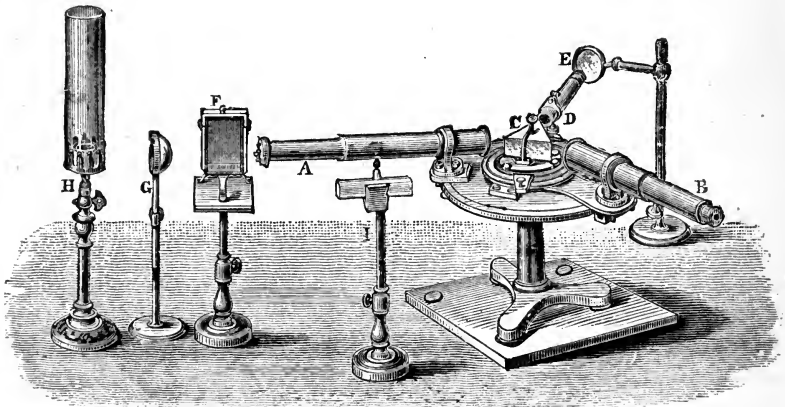

FIG. 33.—Spectroscope: A, collimator with adjustable slit at one (left) end and collimating lens at the other (right) end; B, telescope moving on graduated arc divided into degrees; C, prism or combination of prisms; D, tube for scale; E, mirror for illuminating scale; F, vessel with parallel glass sides for holding fluid, shown with the flat side towards the reader; I, long spectroscope bottle for examining a deep layer of fluid; H, Argand burner; G, condenser for concentrating the light from H on the slit. (From a photograph taken by Dr. MacMunn for McKendrick's 'Physiology'.)

If we now interpose between the source of light and the slit S a piece of coloured glass (H in fig. 32), or a solution of a coloured

substance contained in a vessel with parallel sides (the hæmatoscope of Hermann, F in fig. 33), the spectrum is found to be no longer continuous, but is interrupted by a number of dark shadows, or *absorption bands*, corresponding to the light absorbed by the coloured medium. Thus a solution of oxyhæmoglobin of a certain strength gives two bands between the D and E lines; hæmoglobin gives only one; and other red solutions, though to the naked eye similar to oxyhæmoglobin, will give characteristic bands in other positions.

A convenient form of small spectroscopé is the *direct-vision spectroscopé*, in which, by an arrangement of alternating prisms of crown and flint glass (see fig. 34), the spectrum is observed by the eye in the same line as the tube furnished with the slit. Such small spectroscopes may be used for class purposes, and may for convenience be mounted on a stand provided with a gas-burner and a receptacle for the test-tube (see fig. 35). In the examination of the spectrum of small coloured objects, a combination of the microscope and direct-vision spectroscopé, called the *micro-spectroscopé*, is used.

Fig. 36 illustrates a method of representing absorption spectra

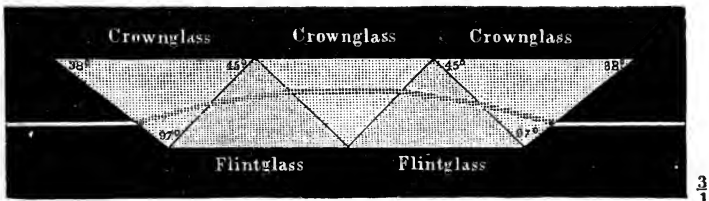

FIG. 34.—Arrangement of prisms in direct-vision spectroscopé.

diagrammatically. The solution was examined in a layer 1 centimetre thick. The base line has on it at the proper distances the chief Fraunhofer lines, and along the right-hand edges are the percentage amounts of oxyhæmoglobin present in I, of hæmoglobin in II. The width of the shadings at each level represents the position and amount of absorption corresponding to the percentages.

The characteristic spectrum of oxyhæmoglobin, as it actually appears through the spectroscopé, is seen in the next figure (fig. 37, spectrum 2). There are two distinct absorption bands between the D and E lines; the one nearest to D (the  $\alpha$  band) is narrower, darker, and has better defined edges than the other (the  $\beta$  band). As will be seen on looking at fig. 36, a solution of oxyhæmoglobin of concentration greater than 0.65 per cent. and less than 0.85 per cent. (examined in a cell of the usual thickness of 1 centimetre) gives one

thick band overlapping both D and E, and a stronger solution only lets the red light through between C and D. A solution which gives

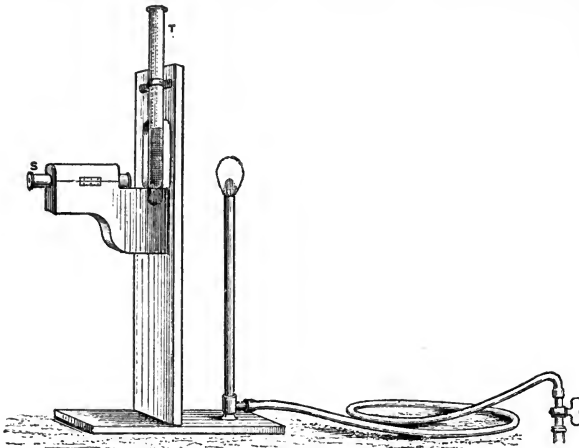

FIG. 35.—Stand for direct-vision spectroscope : S, spectroscope ; T, test-tube for coloured substance under investigation.

the two characteristic bands must therefore be a very dilute one. The one band ( $\gamma$  band) of hæmoglobin (fig. 37, spectrum 3) is not so

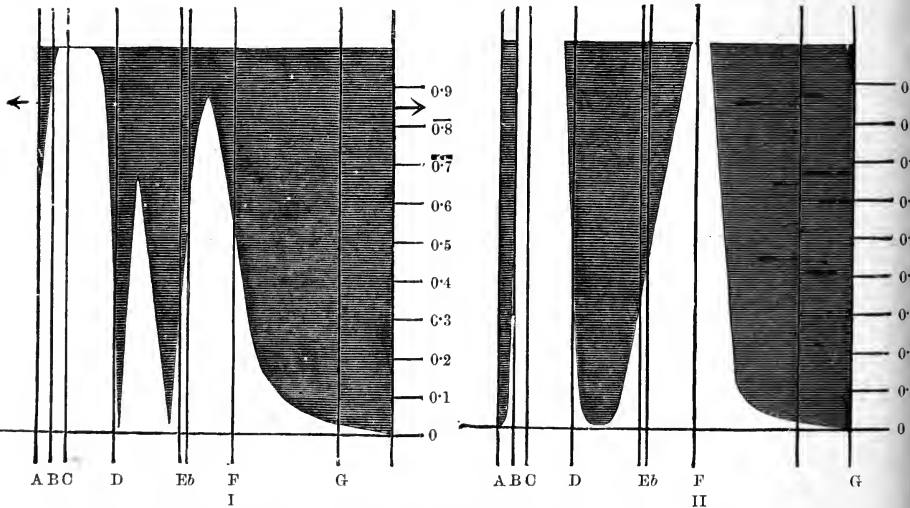

FIG. 36.—Graphic representations of the amount of absorption of light by solution (I) of oxyhæmoglobin, (II) of hæmoglobin, of different strengths. The shading indicates the amount of absorption of the spectrum ; the figures on the right border express percentages. (Rollett.)

well defined as the  $\alpha$  and  $\beta$  bands. On dilution it fades rapidly, so that in a solution of such strength that both bands of oxyhæmoglobin

would be quite distinct the single band of hæmoglobin has disappeared from view. The oxyhæmoglobin bands can be distinguished in a solution which contains only one part of the pigment to 10,000 of water, and even in more dilute solutions which seem to be colourless the  $\alpha$  band is still visible.

**Methæmoglobin.**—This may be produced artificially by adding such reagents as potassium ferricyanide or amyl nitrite to a solution of oxyhæmoglobin; it may also occur in certain diseased conditions in the urine; it is therefore of considerable practical importance. It can be crystallised, and is found to contain the same amount of oxygen as oxyhæmoglobin, only combined differently. The oxygen is not removable by the air-pump, nor by a stream of a neutral gas

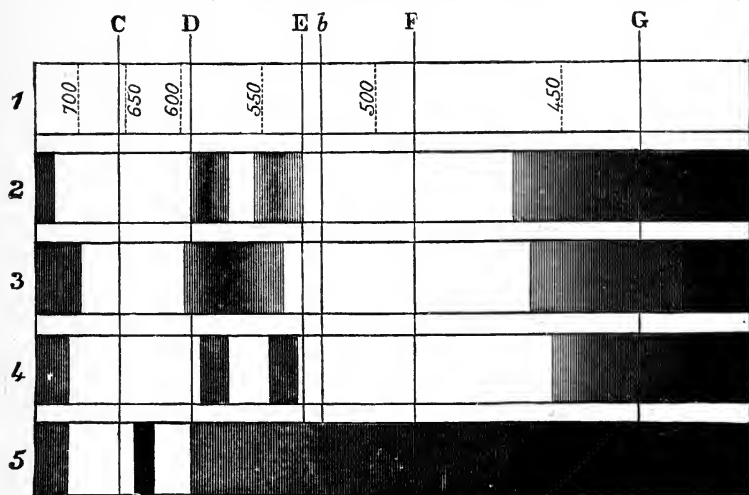

FIG. 37.—1, Solar spectrum; 2, spectrum of oxyhæmoglobin (0.37 per cent. solution); 3, spectrum of hæmoglobin; 4, spectrum of CO-hæmoglobin; 5, spectrum of methæmoglobin (concentrated solution).

like hydrogen. It can, however, by reducing agents like ammonium sulphide, be made to yield hæmoglobin. Methæmoglobin is of a brownish-red colour, and gives a characteristic absorption band in the red between the C and D lines (fig. 37, spectrum 5).

The ferricyanide of potassium or sodium not only causes the conversion of oxyhæmoglobin into methæmoglobin, but if the reagent is added to blood which has been previously laked by the addition of twice its volume of water there is an evolution of oxygen. If a small amount of sodium carbonate or ammonia is added as well to prevent the evolution of any carbonic acid, and the oxygen is collected and measured, it is found that all the oxygen previously combined in oxyhæmoglobin is discharged. This is at first sight puzzling, because,

as just stated, methæmoglobin contains the same amount of oxygen that is present in oxyhæmoglobin. What occurs is that, after the oxygen is discharged from oxyhæmoglobin, an equal quantity of oxygen takes its place from the reagents added. The oxygen atoms of the methæmoglobin must be attached to a different part of the hæmatin group from the oxygen atoms of the oxyhæmoglobin, so that the hæmatin group when thus altered loses its power of combining with oxygen and carbonic oxide to form compounds which are dissociable in a vacuum.

Haldane, to whom we owe these interesting results, gives the following provisional equation to represent what occurs:—

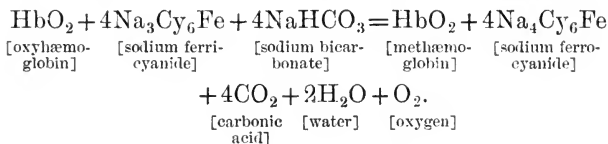

**Carbonic Oxide Hæmoglobin** may be readily prepared by passing a stream of carbonic oxide or coal gas through blood or through a solution of oxyhæmoglobin. It has a peculiar cherry-red colour. Its absorption spectrum is very like that of oxyhæmoglobin, but the two bands are slightly nearer the violet end of the spectrum (fig. 37, spectrum 4). Reducing agents, such as ammonium sulphide, do not change it; the gas is more firmly combined than the oxygen in oxyhæmoglobin. CO-hæmoglobin forms crystals like those of oxyhæmoglobin: it resists putrefaction for a very long time.

Carbonic oxide is given off during the imperfect combustion of carbon such as occurs in charcoal stoves; it is a powerful poison combining with the hæmoglobin of the blood, and thus interfering with normal respiratory processes. The colour of the blood and its resistance to reducing agents are in such cases characteristic.

**Nitric Oxide Hæmoglobin.**—When ammonia is added to blood, and then a stream of nitric oxide is passed through it, this compound is formed. It may be obtained in crystals isomorphous with oxy- and CO-hæmoglobin. It also has a similar spectrum. It is even more stable than CO-hæmoglobin; it has little practical interest, but is of theoretical importance as completing the series.

## TESTS FOR BLOOD

These may be gathered from preceding descriptions. Briefly, they are microscopic, spectroscopic, and chemical. The best chemical test is the formation of hæmin crystals. The old test with tincture

of guaiacum and hydrogen peroxide, the blood causing the red tincture to become green, is not very trustworthy, as it is also given by many other organic substances; it is, however, with certain precautions, used by some.

In medico-legal cases it is often necessary to ascertain whether a red fluid or stain upon clothing is or is not blood. In any such case it is advisable not to rely upon one test only, but to try every means of detection at one's disposal. To discover whether it is blood or not, is by no means a difficult problem, but to distinguish human blood from that of the common mammals is possible only by the 'biological' test described at the end of the next section.

### IMMUNITY

The chemical defences of the body against injury and disease are numerous. The property that the blood possesses of coagulating is a defence against hæmorrhage; the acid of the gastric juice is a protection against harmful bacteria introduced with food. Bacterial activity in urine is inhibited by the acidity of that secretion.

Far more important and widespread in its effects than any of the foregoing is the bactericidal (*i.e.* bacteria-killing) action of the blood and lymph; a study of this question has led to many interesting results, especially in connection with the important problem of immunity.

It is a familiar fact that one attack of many of the infective maladies protects us against another attack of the same disease. The person is said to be *immune*, either partially or completely, against that disease. Vaccination produces in a patient an attack of cowpox or vaccinia. This disease is either closely related to smallpox, or may be it is smallpox modified and rendered less malignant by passing through the body of a calf. At any rate, an attack of vaccinia renders a person immune to smallpox for a certain number of years. Vaccination is an instance of what is called *protective inoculation*, which is now practised with more or less success in reference to other diseases, such as plague and typhoid fever. The study of immunity has also rendered possible what may be called *curative inoculation*, or the injection of antitoxic material as a cure for diphtheria, tetanus, snake poisoning, &c.

The power the blood possesses of slaying bacteria is not limited to the colourless corpuscles or *phagocytes*, but is also a property of the fluid part of the blood, at any rate in the case of some micro-organisms. The chemical characters of the substances which kill the bacteria are not fully known; but they appear to be protein

in nature. The bactericidal powers of blood are destroyed by heating it for an hour to 55° C. The balance of evidence appears to be in favour of the view that the substances in question originate from the leucocytes, and phagocytosis becomes more intelligible if this is accepted. The substances, whatever be their source or their chemical nature, are called *bacterio-lysins*.

Closely allied to the bactericidal power of blood, or blood-serum, is its globulicidal power. By this one means that the blood-serum of one animal has the power of dissolving the red blood-corpuscles of another species. If the serum of one animal is injected into the blood-stream of an animal of another species, the result is a destruction of its red corpuscles, which may be so excessive as to lead to the passing of the liberated hæmoglobin into the urine (hæmoglobinuria). The substances in the serum that possess this property are called *hæmolysins*, and though there is some doubt whether bacterio-lysins and hæmolysins are absolutely identical, there is no doubt that they are closely related substances.

Normal blood thus possesses not only *phagocytes*, which eat up bacteria, but also a certain amount of chemical substances which are inimical to the life of our bacterial foes. But suppose a person gets 'run down'; everyone knows he is then more liable to 'catch anything.' This coincides with a diminution in the bactericidal power of his blood. But even a perfectly healthy person has not an unlimited supply of bacterio-lysins, and if the bacteria are sufficiently numerous he will fall a victim to the disease they produce. Here, however, comes in the remarkable part of the defence. In the struggle he will produce more and more bacterio-lysin, and if he gets well it means that the bacteria are finally vanquished, and his blood remains rich in the particular bacterio-lysin he has produced, and so will render him immune to further attacks from that particular species of bacterium. Every bacterium seems to cause the development of a specific anti-substance.

Immunity can more conveniently be produced gradually in animals; and this applies, not only to the bacteria, but also to the toxins they form. If, for instance, the bacilli which produce diphtheria are grown in a suitable medium, they produce the diphtheria poison, or toxin, much in the same way that yeast-cells will produce alcohol when grown in a solution of sugar. Diphtheria toxin is associated with a proteose, as is also the case with the poison of snake venom. If a certain small dose called a 'lethal dose' is injected into a guinea-pig the result is death. But if the guinea-pig receives a smaller dose it will recover; a few days after it will stand a rather larger



dose ; and this may be continued until, after many successive gradually increasing doses, it will finally stand an amount equal to many lethal doses without any ill effects. The gradual introduction of the toxin has called forth the production of an antitoxin. If this is done in the horse instead of the guinea-pig the production of antitoxin is still more marked, and the serum obtained from the blood of an immunised horse may be used for injecting into human beings suffering from diphtheria, and it rapidly cures the disease. The two actions of the blood, antitoxic and antibacterial, are frequently associated, but may be entirely distinct.

The antitoxin is also a protein probably of the nature of a globulin ; at any rate it is a protein of larger molecular weight than a proteose. This suggests a practical point. In the case of snake-poisoning the poison gets into the blood rapidly owing to the comparative ease with which it diffuses, and so it is quickly carried all over the body. In treatment with the antitoxin or antivenin, speed is everything if life is to be saved ; injection of this material under the skin is not much good, for the diffusion into the blood is too slow. It should be injected straight away into a blood-vessel.

There is no doubt that in these cases the antitoxin neutralises the toxin much in the same way that an acid neutralises an alkali. If the toxin and antitoxin are mixed in a test-tube, and time allowed for the interaction to occur, the result is an innocuous mixture. The toxin, however, is merely neutralised, not destroyed ; for if the mixture in the test-tube is heated to 68° C. the antitoxin is coagulated and destroyed, and the toxin remains as poisonous as ever.

Immunity is distinguished into *active* and *passive*. Active immunity is produced by the development of protective substances in the body ; passive immunity by the injection of a protective serum. Of the two the former is the more permanent.

*Ricin*, the poisonous protein of castor-oil seeds, and *abrin*, that of the Jequirity bean, also produce when gradually given to animals an immunity, due to the production of antiricin and antiabrin respectively.

Ehrlich's hypothesis to explain such facts is usually spoken of as the *side-chain theory* of immunity. He considers that the toxins are capable of uniting with the protoplasm of the living cells by possessing groups of atoms like those by which nutritive proteins are united to cells during normal assimilation. He terms these *haptophor* groups, and the groups to which these are attached in the cells he terms *receptor* groups. The introduction of a toxin stimulates an excessive production of receptors, which are finally thrown out into the circulation, and the free circulating receptors constitute the antitoxin. The comparison of the process to assimilation is justified by the fact that non-toxic substances like milk or egg-white introduced gradually by successive doses into the blood-stream cause the formation of anti-substances capable of coagulating them.

Up to this point I have spoken only of the blood, but month by month workers are bringing forward evidence to show that other cells of the body

may by similar measures be rendered capable of producing a corresponding protective mechanism.

One further development of the theory I must mention. At least two different substances are necessary to render a serum bactericidal or globulicidal. The bacterio-lysin or hæmolysin consists of these two substances. One of these is called the *immune body*, the other the *complement*. We may illustrate the use of these terms by an example. The repeated injection of the blood of one animal (*e.g.* the goat) into the blood of another animal (*e.g.* a sheep) after a time renders the latter animal immune to further injections, and at the same time causes the production of a serum which dissolves readily the red blood-corpuscles of the first animal. The sheep's serum is thus hæmolytic towards goat's blood-corpuscles. This power is destroyed by heating to 56° C. for half an hour, but returns when fresh serum of any animal is added. The specific immunising substance formed in the sheep is called the immune body; the ferment-like substance destroyed by heat is the complement. The latter is not specific, since it is furnished by the blood of non-immunised animals, but it is nevertheless essential for hæmolysis. Ehrlich believes that the immune body has two side groups—one which connects with the receptor of the red corpuscles, and one which unites with the haptophor group of the complement, and thus renders possible the ferment-like action of the complement on the red corpuscles. Various antibacterial serums, which have not been the success in treating disease they were expected to be, are probably too poor in complement, though they may contain plenty of the immune body.

To put it another way: the cell-dissolving substances cannot act on their objects of attack without an intermediate substance to anchor them on the substance in question. This intermediary substance, known as the immune body or amboceptor, is specific, and varies with the substance to be attacked (red corpuscles, bacterium, toxin, &c.). The complement may be compared to a person who wants to unlock a door; to do this effectively he must be provided with the proper key (amboceptor or immune body).

Quite distinct from the bactericidal, globulicidal, and antitoxic properties of blood is its agglutinating action. This is another result of infection with many kinds of bacteria or their toxins. The blood acquires the property of rendering immobile and clumping together the specific bacteria used in the infection. The test applied to the blood in cases of typhoid fever, and generally called Widal's reaction, depends on this fact.

The substances that produce this effect are called *agglutinins*. They also are probably protein-like in nature, but are more resistant to heat than the lysins. Prolonged heating to over 60° C. is necessary to destroy their activity.

We thus see that the means the body possesses of combating bacterial invasion are numerous. In some cases the bacteria are killed by bacterio-lysin, and in other cases they are directly attacked and devoured by the phagocytes. Bacteria which are destroyed in this way produce no evil results, whereas those which are not destroyed are called *pathogenic*, or disease-producing organisms. There is still another means of defence, for if the bacteria are not

destroyed the poisons or toxins they produce are in certain other cases neutralised by antitoxins.

Metschnikoff's view, which is very widely accepted by bacteriologists, is that the most stress should be laid upon phagocytosis as the principal factor in the resistance of the body to bacteria; and the recent discovery of *opsonins* by Sir A. E. Wright not only emphasises this opinion, but shows how the body fluids co-operate with the phagocytes in the process. The word 'opsonin' is derived from a Greek word which means 'to prepare the feast.' Washed bacteria from a culture are distasteful to leucocytes, and would therefore, other things being equal, be pathogenic if injected into an animal's body. But if the bacteria have been previously soaked in serum, especially if that serum has been obtained from the blood of an animal previously immunised against that special bacterium, then the leucocytes devour them eagerly. It was at first supposed that something had been added to the bacterium to make it tasty, and that each kind of bacterium requires its own special sauce or opsonin. It is, however, equally possible that the serum has not added anything to the bacterium, but removed from it something that previously made it distasteful. At any rate the ultimate effect is the same, and the bacterium is rendered *non-pathogenic*. When a person is attacked with some invading organism, say the tubercle bacillus, if that person's blood is naturally rich in the proper kind of opsonin he will not be troubled with tuberculosis; but if the opsonic power of his blood is low the organism will produce the disease. The modern treatment of tuberculosis aims at increasing the opsonic power of the blood by improving the general condition of the patient by good food and pure air, and also by the injection of the appropriate opsonin into his blood.

Lastly, we come to a question which more directly appeals to the physiologist than the preceding, because experiments in relation to immunity have furnished us with what has hitherto been lacking, a means of distinguishing human blood from the blood of other animals.

The discovery was made by Tschistovitch (1899), and his original experiment was as follows:—Rabbits, dogs, goats, and guinea-pigs were inoculated with eel-serum, which is toxic; he thereby obtained from these animals an antitoxic serum. But the serum was not only antitoxic; it also produced a precipitate when added to eel-serum, though not when added to the serum of any other animal. In other words, not only has a specific antitoxin been produced, but also a specific *precipitin*. Numerous observers have since found that this is

a general rule throughout the animal kingdom, including man. If, for instance, a rabbit is treated with human blood, the serum ultimately obtained from the rabbit contains a specific precipitin for human blood; that is to say, a precipitate is formed on adding such a rabbit's serum to human blood, but not when added to the blood of any other animal.<sup>1</sup> The great value of the test is its delicacy: it will detect the specific blood when it is greatly diluted, after it has been dried for weeks, or even when it is mixed with the blood of other animals.

### CHEMISTRY OF RESPIRATION

The consideration of the blood, and especially of its pigment, is so closely associated with respiration that a brief account of that process follows conveniently here.

The air in the alveoli of the lungs, and the blood in the pulmonary capillaries are only separated by the thin capillary and alveolar walls. The blood parts with its excess of carbonic acid and watery vapour to the alveolar air; the blood at the same time receives from the alveolar air the oxygen which renders it arterial.

The intake of oxygen is the commencement, and the output of carbonic acid the end, of the series of changes known as respiration. The intermediate steps take place all over the body, and constitute what is known as *internal* or *tissue respiration*. The exchange of gases which occurs in the lungs is sometimes called in contradistinction *external respiration*. We have already seen that the oxyhæmoglobin is only a loose compound, and in the tissues it parts with its oxygen. The oxygen does not necessarily undergo immediate union with carbon to form carbonic acid, and with hydrogen to form water, but in most cases, as in muscle, is held in reserve by the tissue itself. Ultimately, however, these substances pass into the venous blood, and the carbonic acid and a portion of the water find an outlet by the lungs.

**Inspired and Expired Air.**—The composition of the inspired and expired air may be compared in the following table:—

—	Inspired or atmospheric Air	Expired Air
Oxygen . . . .	20·96 vols. per cent.	16·03 vols. per cent.
Nitrogen . . . .	79   "   "	79   "   "
Carbonic acid . . . .	0·04   "   "	4·4   "   "
Watery vapour . . . .	variable	saturated
Temperature . . . .	"	that of body (37° C.)

<sup>1</sup> There may be a slight reaction with the blood of allied animals; for instance with monkey's blood in the case of man.

The nitrogen remains unchanged. The recently discovered gases, argon, crypton, &c., are in the above table reckoned in with the nitrogen. They are, however, only present in minute quantities. The chief change is in the proportion of oxygen and carbonic acid. The loss of oxygen is about 5, the gain in carbonic acid  $4\frac{1}{2}$ . If the inspired and expired airs are carefully measured at the same temperature and barometric pressure, the volume of expired air is thus rather less than that of the inspired. The conversion of oxygen into carbonic acid would not cause any change in the volume of the gas, for a molecule of oxygen ( $O_2$ ) would give rise to a molecule of carbonic acid ( $CO_2$ ) which would occupy the same volume (Avogadro's law). It must, however, be remembered that carbon is not the only element which is oxidised. Fats contain a number of atoms of hydrogen which during metabolism are oxidised to form water; a certain small amount of oxygen is also used in the formation of urea. Carbohydrates contain sufficient oxygen in their own molecules to oxidise their hydrogen; hence the apparent loss of oxygen is least when a vegetable diet (that is, one consisting largely of starch and other carbohydrates) is taken, and greatest when much fat and protein are eaten. The quotient  $\frac{CO_2 \text{ given off}}{O_2 \text{ absorbed}}$  is called the *respiratory quotient*.

Normally it is  $\frac{4.5}{5} = 0.9$ , but this varies considerably with diet, as just stated.

**Gases of the Blood.**—From 100 volumes of blood about 60 volumes of gas can be removed by the mercurial air-pump (see Appendix). The average composition of this gas from dog's blood is—

—	Arterial Blood	Venous Blood
Oxygen . . . . .	20	8 to 12
Nitrogen . . . . .	1 to 2	1 to 2
Carbonic acid . . . . .	40	46

The nitrogen in the blood is simply dissolved from the air just as water would dissolve it: it has no physiological importance. The other two gases are present in much greater amount than can be explained by simple solution; they are, in fact, chiefly present in loose chemical combinations. Less than one volume of the oxygen and about two of carbonic acid are present in simple solution in the plasma.

**Oxygen in the Blood.**—The amount of gas dissolved in a liquid varies with the pressure of the gas; double the pressure and the

amount of gas dissolved is doubled. The oxygen in the blood does not vary directly with oxygen pressure, for the amount of that gas in simple solution forms only a small fraction of the total present. This small amount is of course doubled by doubling the pressure, but such an increase is insignificant, the bulk of the gas being in chemical union with hæmoglobin. The oxygen of oxyhæmoglobin can be replaced by equivalent quantities of other gases, such as carbonic oxide. The tension or partial pressure of oxygen in the air of the alveoli is less than that in the atmosphere, but greater than that in venous blood; hence oxygen passes from the alveolar air into the blood; the oxygen immediately combines with the hæmoglobin, and thus leaves the plasma free to absorb more oxygen; and this goes on until the hæmoglobin is entirely, or almost entirely, saturated with oxygen. The reverse change occurs in the tissues where the partial pressure of oxygen is lower than in the plasma, or the lymph that bathes the tissue elements; the plasma parts with its oxygen to the lymph, the lymph to the tissues; the oxyhæmoglobin then undergoes dissociation to supply more oxygen to the plasma and lymph, and this in turn to the tissues once more. This goes on until the oxyhæmoglobin loses a great portion of its store of oxygen, but even in asphyxia it does not lose all.

The following values are given for the tension of oxygen in percentages of an atmosphere:—

External air . . . . .	20·96	
Alveolar air . . . . .	13-16	↗
Arterial blood . . . . .	14	↓
Tissues . . . . .	0	

The arrow shows the direction in which the gas passes.

The methods of obtaining the gases of the blood and analysing them are described in the Appendix. When the gases are being pumped off from the blood, very little oxygen comes off until the pressure is greatly reduced, and then, at a certain point, it is suddenly disengaged. This shows it is not in simple solution, but is united chemically to the hæmoglobin as oxyhæmoglobin, which is dissociated when the pressure is extremely low.

The ability of the tissues to form reduction products is shown by Ehrlich's experiments with methylene blue and similar pigments. Methylene blue is more stable than oxyhæmoglobin; but if it is injected into the circulation of a living animal, and the animal killed a few minutes later, the blood is found dark blue, but the organs colourless. On exposure to oxygen the organs become blue. In other words the tissues have formed a colourless reduction product from the

methylene blue ; on exposure to the air this is oxidised, and the blue pigment is thus regenerated.

**Carbonic Acid in the Blood.**—What has been said for oxygen holds good in the reverse direction for carbonic acid. Compounds are formed in the tissues where the tension of the gas is high : these pass into the lymph, then into the blood, and in the lungs the compounds undergo dissociation, carbonic acid passing into the alveolar air where the tension of the gas is comparatively low, though it is greater here than in the expired air.

The relations of this gas and the compounds it forms are more complex than in the case of oxygen. If blood is divided into plasma and corpuscles it will be found that both yield carbonic acid, but the yield from the plasma is the greater. If we place blood in a vacuum it bubbles, and gives out all its gases ; addition of a weak acid causes no further liberation of carbonic acid. If plasma or serum is similarly treated the gas comes off, but from 10 to 18 per cent. of the carbonic acid is fixed—that is, the addition of some stronger acid, such as phosphoric acid, is necessary to displace it. Fresh red corpuscles will, however, take the place of the phosphoric acid, and thus it has been surmised that oxyhæmoglobin has the properties of an acid.

One hundred volumes of venous blood contain forty-six volumes of carbonic acid. Whether this is in solution or in chemical combination is determined by ascertaining the tension of the gas in the blood. One hundred volumes of blood plasma would dissolve more than an equal volume of the gas at atmospheric pressure if its solubility in plasma were equal to that in water.<sup>1</sup> If, then, the carbonic acid were in a state of solution, its tension would be very high, but it proves to be only equal to about 5 per cent. of an atmosphere. This means that when venous blood is brought into an atmosphere containing 5 per cent. of carbonic acid, the blood neither gives off any carbonic acid nor takes up any. Hence the remainder of the gas, 95 per cent., is in a condition of chemical combination. The chief compound appears to be sodium bicarbonate.

The carbonic acid and phosphoric acid of the blood are in a state of constant struggle for the possession of the sodium. The salts formed by these two acids depend on their relative masses. If carbonic acid is in excess we get sodium carbonate ( $\text{Na}_2\text{CO}_3$ ), and mono-sodium phosphate ( $\text{NaH}_2\text{PO}_4$ ) ; but if the carbonic acid is diminished, the phosphoric acid obtains the greater share of sodium

<sup>1</sup> To be exact, the solubility of carbon dioxide in plasma is a little less than in pure water.

to form disodium phosphate ( $\text{Na}_2\text{HPO}_4$ ). In this way, as soon as the amount of free carbonic acid diminishes, as in the lungs, the amount of carbonic acid in combination also decreases; whereas in the tissues, where the tension of the gas is highest, a large amount is taken up into the blood, where it forms sodium bicarbonate.

The tension of the carbonic acid in the tissues is high, but one cannot give exact figures; we can measure the tension of the gas in certain secretions; in the urine it is 9, in the bile 7 per cent. The tension in the cells themselves must be higher still.

The following figures (from Fredericq) give the tension of carbonic dioxide in percentages of an atmosphere:—

Tissues . . . . .	5 to 9	} in dog ↓
Venous blood . . . . .	3·8 to 5·4	
Alveolar air . . . . .	2·8	
External air . . . . .	0·04	

The arrow indicates the direction in which the gas passes: namely, in the direction of pressure from the tissues to the atmosphere.

In some other experiments, also on dogs, the following are the figures given:—

Arterial blood . . . . .	2·8	} ↓
Venous blood . . . . .	5·4	
Alveolar air . . . . .	3·56	
Expired air . . . . .	2·8	

It will be seen from these figures that the tension of carbonic acid in the venous blood (5·4) is higher than in the alveolar air (3·56); its passage into the alveolar air is therefore intelligible by the laws of diffusion. Diffusion, however, should cease when the tension of the gas in the blood and in the alveolar air are equal. But the transference goes beyond the establishment of such an equilibrium, for the tension of the gas in the blood continues to sink until it is, when the blood is arterial, ultimately less (2·8) than in the alveolar air.

The whole question is beset with great difficulties and contradictions. Analyses by different observers have given very different results, but if such figures as those just quoted are ultimately found to be correct, we can only explain this apparent reversal of a law of nature by supposing with Bohr, that the alveolar epithelium possesses the power of excreting carbonic acid, just as the cells of secreting glands are able to select certain materials from the blood and reject others. Recent work by Bohr and Haldane has also shown that in all probability the same explanation—epithelial activity—must be called in to account for the absorption of oxygen. Haldane, in fact, states that the tension of oxygen in the blood is



greater than in the atmosphere. In the swim-bladder of fishes (which is analogous to the lung of mammals) the oxygen is certainly far in excess of anything that can be explained by mere diffusion. The storage of oxygen, moreover, ceases when the vagus nerves which supply the swim-bladder are divided.

Some Continental observers have stated that certain noxious substances are ordinarily contained in expired air, which are much more poisonous than carbonic acid, but researches in this country have entirely failed to substantiate this. If precautions be taken by absolute cleanliness to prevent admixture of the air with exhalations from skin, teeth, and clothes, the expired air only contains one noxious substance, and that is carbonic acid.

**Tension of Gases in Fluids.**—It is necessary to understand thoroughly the expression 'tension of gases in fluids'; we will therefore go into the matter a little more fully.

The first question which arises is, In what circumstances will a gas, dissolved in a fluid, diffuse out of the fluid into the air in contact with it? or *vice versa*, in what circumstances will a gas diffuse out of the air into the fluid, and at what rate will it do so?

The answer depends upon the physical constants of the fluid and of the atmosphere; and these must be determined experimentally.

As an example the following instance may be taken:—100 c.c. of water charged with 80 c.c. of carbonic acid are shaken with pure air in a closed bottle of 500 c.c. capacity. The carbonic acid will come out of the water at first, but as the shaking continues the carbonic acid will come out more and more slowly until it entirely ceases to do so. Analysis of the air and of the water in the bottle would show that the water had not parted with all its carbonic acid. It would be found that the water contained 16 c.c. of carbonic acid dissolved in it, while 64 c.c. have diffused out into the air.

At the end of this experiment, then, there will be in the atmosphere 64 c.c. of carbonic acid in a space of 400 c.c. If the whole space (400 c.c.) were filled with carbonic acid its pressure would be 760 mm. The partial pressure of carbonic acid in the atmosphere of the bottle is therefore  $760 \times \frac{64}{400}$  mm. of mercury = 122 mm. Water, therefore, containing 16 volumes per cent. of carbonic acid is in equilibrium with an atmosphere in which the carbonic acid exerts a pressure of 122 mm. This fact is stated shortly by the phrase 'when water has a carbonic acid *tension* of 122 mm. it contains 16 per cent. of carbonic acid.'

The amount of carbonic acid which would be contained in any other fluid when it was in equilibrium with an atmosphere having a

122 mm. pressure of carbonic acid would be different from that contained in water. For instance, alcohol would contain 50 per cent. of the gas. In both fluids the *tension* of carbonic acid is the same but the *quantity* of carbonic acid would be as stated, and therefore different.

The tension of a gas in a liquid, therefore, is the pressure of that gas in an atmosphere of such a composition, that the liquid would neither acquire that gas from the atmosphere nor impart that gas to it, if the liquid and the atmosphere were brought into intimate contact, as by shaking.

**Measurement of Tension in Fluids—Aërotonometer.**—The measurement of the tension of gases in fluids is conducted upon the principles

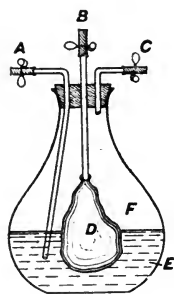

FIG. 38.  
Loewy's Aërotonometer.

of the example given above. The instrument for the purpose is called an aërotonometer. The form used by Loewy consists simply of a closed bottle, into which the blood and the air can be put, and from which they can be withdrawn by suitable means. Through the stopper of the bottle three tubes pass—A, B, and C—each of which is provided with a piece of rubber tubing and a clip. The tube A is used for introducing or expelling the blood (E). C is used for introducing or expelling the air; B is connected with a rubber bag containing water inside the bottle, while outside a connection can be made with a syringe. A little mercury should be put into the bottle to defibrinate the blood. To determine the carbonic acid tension in blood several bottles should be filled with gases of known composition from gasometers before the experiment. Into each bottle some blood is drawn from the animal. This is done by attaching A to a cannula in one of its vessels, and then, when water is withdrawn from the bag D by the syringe, a corresponding amount of blood enters the aërotonometer. Each bottle is shaken violently for some time. When equilibrium has been established the air can be taken from the air space F by attaching C to an air-analysis apparatus, and forcing water into the bag D from the syringe attached to B. An example may illustrate the result which might be obtained.

*Determination of carbonic acid tension of blood.*

Bottle	I	II	III	IV	V
Initial percentage of the gas	6.0	5.5	5.0	4.5	4
Final percentage of gas present	5.8	5.4	5.1	4.7	4.3

From the above figures it will be seen that the blood has acquired

carbonic acid from the air in bottles I and II, while the reverse has taken place in bottles III, IV, and V. The carbonic acid tension of the blood is therefore between 5.4 and 5.1 per cent.

**Relation of Tension to Composition.**—The aërotonometer may be used to determine the relation of the tension of a gas in the blood (oxygen or carbonic acid) to the quantity contained in that fluid. The example given above might be extended for this purpose in the following way. After the air has been withdrawn for analysis, it is only necessary to attach A to the blood-bulb of a mercurial gas pump, and, by forcing more water into B, expel a sufficient quantity of blood for analysis. If an analysis was made for each of the bottles, the quantity of carbonic acid would be determined corresponding to the tensions, 5.8, 5.4, 5.1, 4.7, and 4.3 per cent. respectively.

The comparison of the quantity of carbonic acid in the blood with its tension is not of importance, but the corresponding measurements for oxygen have been carried out with great care by a number of observers, both for blood and for solutions of hæmoglobin.

It is found that the two sets of observations agree very closely, and this fact forms the most substantial evidence for our belief that the oxygen in the blood is almost entirely associated with the hæmoglobin.

The relation of the quantity of oxygen in the blood to the tension which it exerts may be conveniently set forth in a curve, which is called the dissociation curve of oxyhæmoglobin.

An example may illustrate the use to which the information, given in this curve, may be put. The amount of blood which comes, say, from the pancreas is too small to allow of a direct determination of the tension of the oxygen which it contains. We can, however,

calculate it from the following data. (1) The amount of oxygen which the blood would contain if saturated (this can be arrived at by saturating arterial blood and analysing it). (2) The amount of oxygen in the venous blood. In an actual experiment (1) was 22.0 c.c., (2) was 10.7 c.c. The saturation then was  $100 \times \frac{10.7}{22.0} = 49$  per cent. By referring to the dissociation curve we see that 49 per cent.

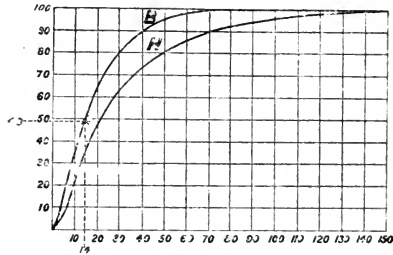

FIG. 39.—Dissociation of oxygen curves for blood (B) and hæmoglobin solution (H) at 38° C. The figures along the base line are pressures in millimetres of mercury, and those along the ordinate are percentages of oxygen. (Bohr.)

saturation corresponds with an oxygen tension of about 14 mm. of mercury, or 1·8 per cent. of an atmosphere.

**The Carbonic Oxide Method of Estimating the Oxygen Tension of Arterial Blood.**—This method was devised by Haldane, and is considered by him and Lorrain Smith to give more trustworthy results than those obtained by the aërotonometer. If blood is exposed to a mixture of carbonic oxide and oxygen, the hæmoglobin will become saturated by these gases according to their relative tensions. If a number of experiments are performed using different percentages of carbonic oxide, the results may be expressed graphically as the curve of dissociation of carboxyhæmoglobin in air. When, in place of such experiments *in vitro*, an animal is made to breathe air containing a known percentage of carbonic oxide, the comparison of the saturation of its blood with the saturation of its blood *in vitro*, exposed to the same percentage of carbonic oxide in air (which has an oxygen tension of 20·9 per cent.) gives us the means of discovering the oxygen tension in the arterial blood of the lung capillaries: this will be higher or lower than that of the air according as the saturation by carbonic oxide is correspondingly lower or higher. A small animal like a mouse is made to breathe air containing a known percentage of carbonic oxide. After a sufficient time the animal is killed and the amount of carboxyhæmoglobin is determined colorimetrically in a drop of its blood. The data thus obtained are compared with the data previously expressed in the curve of dissociation of carboxyhæmoglobin in air; it is then easy to calculate whether the oxygen tension in the blood is higher or lower than that of air. The results of the method show generally that the tension of oxygen in the arterial blood as it leaves the lungs is higher than could result from simple diffusion of the oxygen through the alveolar epithelium; in other words, the epithelial cells are capable of secreting oxygen into the blood until an oxygen pressure is reached considerably above that in the alveolar air.

The results expressed in percentages of an atmosphere are as follows:—

Oxygen tension of arterial blood in man, 38·5; in mouse, 22·6; in dog, 21; in cat, 35·3; in rabbit, 27·6, and in birds 30 to 50 per cent. The results in the case of man and larger animals probably require revision, as it is not certain that the time allowed for the establishment of the balance of carbonic oxide and oxygen has been sufficient in any of the experiments.

**Tissue-Respiration.**—Before the processes of respiration were fully understood the lungs were looked upon as the seat of combustion; they were regarded as the stove for the rest of the body where effete material was brought by the venous blood to be burnt up. When it was shown that the venous blood going to the lungs already contained carbonic acid, and that the temperature of the lungs is not greater than that of the rest of the body, this explanation had of necessity to be dropped.

Physiologists next transferred the seat of the combustion to the blood; but since then innumerable facts and experiments have shown that it is in the tissues themselves, and not in the blood, that combustion occurs. The methylene-blue experiment already described (p. 128) shows this; and the following experiment is also quite conclusive. A frog can be kept alive for some time after salt solution is

substituted for its blood. The metabolism goes on actively if the animal is kept in pure oxygen. The taking up of oxygen and giving out of carbonic acid must therefore occur in the tissues, as the animal has no blood.

The following are the amounts of oxygen used up per minute by one gramme of certain epithelial and muscular organs respectively:—Submaxillary gland 0.04 c.c., pancreas 0.05 c.c., kidney 0.03 c.c., heart (contracting very feebly and slowly) 0.007 c.c., muscles of leg (with spinal cord destroyed) 0.003 c.c.

In order to obtain data, such as the above, it is necessary (1) to analyse the blood going to the organ; (2) to analyse the blood emerging from the organ; (3) to determine the amount of blood passing through the organ in one minute.

Analysis of the blood may be performed by either of two methods, the mercurial air-pump (see Appendix) or the chemical method of expelling the oxygen and carbonic acid from the blood by means of potassium ferricyanide and phosphoric acid respectively.

#### Chemical Method of Blood Gas Analysis.—

When a solution of hæmoglobin is treated with potassium ferricyanide it yields all its oxygen to the air on shaking, just as urea yields its nitrogen when treated with sodium hypobromite. The apparatus used for determining the oxygen in blood is very similar to a Dupré's urea apparatus (see p. 142). The blood (5 c.c.) is placed in the large bottle (F) (fig. 40) underneath a layer of dilute ammonia solution. The blood is thus protected from the air, while the apparatus becomes equal in temperature to the bath in which it is placed. The blood is shaken with the ammonia solution which laves it thoroughly; the ferricyanide solution is then spilt into the laked blood from the tube G, and the oxygen is shaken out of the solution. When the oxygen has been determined the bottle is opened and phosphoric acid is placed in the small tube G: this is subsequently spilt into the mixture of blood, ammonia, and ferricyanide; it liberates the carbonic acid, which is also shaken out of the fluid. The carbonic acid does not come completely out, however, and a correction has to be introduced for the quantity which remains in solution. The gas which

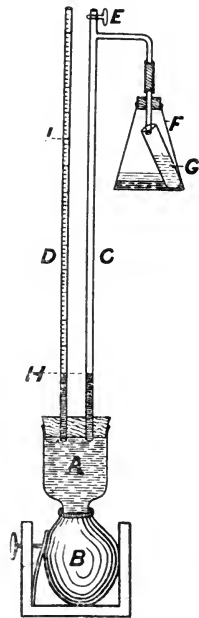

FIG. 40.—Barcroft's apparatus for obtaining the blood gases.

comes off passes into the tube c, which was originally filled up to the zero mark with water in continuity with that in the reservoir a. This would depress the column of fluid in c and raise that in the open tube d, which is graduated in millimetres. In practice, however, it is convenient to keep the gas always at the same volume: this may be done by raising the pressure in the open tube (d) by squeezing some of the water with which the gauge is filled out of a rubber reservoir b, which forms the base of the gauge; thus the level of the water in c is kept at the zero, while that in d rises from h to i. The actual measurement then is the increase of pressure (*i.e.* the height of the column of water HI) which is necessary to keep the gases in the tube c at the same volume as that which was previously occupied by the air in that tube. From this the quantity coming off can be calculated.

The chemical method is not quite so accurate as the vacuum pump, but it is much more convenient for the study of many problems, as it requires less blood, and, owing to its simplicity, a great number of observations can be made upon a single animal.

**Changes in Tissue Respiration caused by Activity.**—In all organs, so far as is known, increased activity is associated with increased tissue respiration. The increase is commonly three- to six-fold. It is

Organ	Condition of rest	Oxygen used per minute	Condition of activity	Oxygen used per minute
Muscle . . .	Nerves cut	0·003 c.c.	Tonic (nerves uncut)	0·006 c.c. 0·020 c.c.
Heart . . .	Very slow and feeble contractions	0·007 c.c.	Normal contractions Very active	0·014 0·054
Submaxillary gland .	Nerves cut	0·04 c.c.	Chorda tympani stimulated	0·12 c.c.
Pancreas . .	Not secreting	0·05 c.c.	Secretion after injection of secretin	0·20
Kidney . . .	Scanty secretion	0·03 c.c.	After injection of a diuretic	0·07 c.c.

often more easy to demonstrate the augmented oxygen consumption than the augmented output of carbonic acid. This is due to several causes: (1) carbonic acid is soluble in the tissues in which it is produced; (2) any change in the chemical reaction of the tissues alters the amount of carbonic acid which they give out to the blood; if, for instance, it becomes more alkaline it retains a portion of its carbonic acid.

The preceding table shows the variations which take place in the oxygen intake of several organs as the result of activity produced by widely different forms of stimulus (Barcroft).

The relation of the oxygen taken in to the carbonic acid given out is well shown in the following experiment performed by Zuntz on the leg of the dog:—

Blood-vessel	Gases in blood per cent.		Remarks
	Oxygen	Carbon dioxide	
Femoral vein . . .	1·2	36·32	Muscles tonic, nerves being intact
Carotid artery . . .	14·4	4·92	
Exchange . . . . .	13·20	14·4	
Femoral vein . . .	2·85	33·16	After section of sciatic and crural
Carotid artery . . .	13·30	23·06	
Exchange . . . . .	10·45	10·1	

Two points must be noted in considering the above table:—

(1) That the exchange of gases was decreased on cutting the nerves. The decrease in metabolism was greater even than the figures show, for the blood flow through the leg was decreased.

(2) That the oxygen exchange and the carbonic acid exchange changed in about the same proportions. The ratio of the carbonic acid given out to the oxygen taken in was  $\frac{14·4}{13·2}$  with the nerves intact and  $\frac{10·1}{10·45}$  with the nerves cut.

**Effect of reduced Oxygen Tension on Tissue Respiration.**—When the oxygen tension in the blood is reduced, the tissues still take up the same quantity of oxygen as before and give out as much, or slightly

more, carbonic acid; thus, in the case of a dog, when the oxygen tension in the blood is approximately 18 millimetres of mercury or one fortieth of an atmosphere, 163 c.c. of oxygen per minute were used up by the animal, and 172 c.c. of carbonic acid were given out; normally by the same animal the oxygen consumption was 157 c.c. and the carbonic acid output 158 c.c. The reason why the tissues extract oxygen with such readiness from the blood, even when the oxygen exists in the blood at a low tension, is that there is no free oxygen in the tissues themselves (and they always thirst for it). This fact can be demonstrated in more than one way.

(1) No oxygen can be extracted from the tissues by exposing them to the vacuum of an air-pump.

(2) The tissues possess the power of reducing such substances as methylene blue (see p. 128).

**Respiration in excised Tissues.**—Excised frog's muscle retains its power of contraction for a considerable time. During this time it gives out carbonic acid. These facts are true whether the muscle be in air or in nitrogen. In either case the muscle must be regarded as partially or entirely asphyxiated, for the individual elements of the muscle are cut off from that ready supply of oxygen which normally reaches them. During life (and the living condition can be imitated by placing an excised muscle in an atmosphere of pure oxygen) the muscular substance breaks down into a number of somewhat simpler substances: one of these is carbonic acid. The others, however, or some of them, are at once built up again with the inclusion of oxygen and some carbon-containing substance, perhaps sugar, into living material. The muscle, therefore, does not contain any of the by-products of its own metabolism. In excised muscle, when the oxygen supply is deficient the by-products accumulate, as a result of which very striking alterations take place. (1) The reaction of the muscle becomes acid and the phenomena of fatigue and functional death set in. (2) The proteins become coagulated, and this is the physical basis of *rigor mortis*.

**The Chemical Stimulus to Respiration.**—Haldane and Priestley have introduced a new and simple method of obtaining the composition of the air in the alveoli. It consists in collecting one sample of air expelled by a deep expiration at the end of a quiet inspiration, and another of the air expelled by a deep expiration at the end of a quiet expiration; the mean of the two gives the composition of alveolar air. This is much simpler than the method formerly employed by Pflüger, which consisted in pumping off the air from an occluded portion of a dog's lung by the means of a fine



elastic catheter introduced *via* the trachea and bronchus. It has the further advantage that it can be applied to the human subject.

They found that under constant atmospheric pressure in man, the alveolar air contains a nearly constant percentage of carbon dioxide in the same person. In different individuals this percentage varies somewhat, but averages in men 5·16, in women and children 4·77 per cent. of an atmosphere. With varying atmospheric pressures the percentage varies inversely as the atmospheric pressure, so that the pressure or tension of the carbon dioxide remains constant. The oxygen pressure, however, varies widely under the same conditions.

These observations and the next to be immediately described furnish the chemical key to the cause of the amount of pulmonary ventilation, and play an important part in conjunction with the respiratory nervous system in the regulation of breathing. For the respiratory centre is not only affected by the impulses reaching it by the vagi and other afferent nerves, but it is also very sensitive to any rise in the tension of carbon dioxide in the blood that supplies it. The changes in the tension of this gas in the arterial blood are normally proportional to the changes in the carbon-dioxide pressure in the alveoli, and thus the changes in the lung alveoli are transmitted to the respiratory centre. They found that a rise of 0·2 per cent. in the alveolar carbon-dioxide pressure is sufficient to double the amount of alveolar ventilation during rest. During work the alveolar carbon-dioxide pressure increases slightly, and the pulmonary ventilation is consequently increased. Changes in the oxygen pressure within wide limits have no such influence; the normal chemical stimulus to respiration is therefore the presence of an increase of carbon dioxide, and not diminution of oxygen. If these limits are exceeded, as when the oxygen pressure falls below 13 per cent. of an atmosphere, the respiratory centre begins to be excited by want of oxygen, for the alveolar carbon-dioxide pressure is lower than normal under such circumstances. 'Apnoea' is the name given to the cessation of breathing which temporarily follows excessive ventilation of the lungs, as when one takes a number of deep breaths in rapid succession. The deep and rapid breathing clears out the carbon dioxide in the alveoli until it is so small in quantity that it is insufficient to excite the respiratory centre *via* the blood to action, the oxygen pressure at the same time remaining sufficiently high not to excite the centre either. Hence breathing ceases. The old idea that apnoea is due to over-oxygenation of the blood has been abundantly disproved, but Head and others have gone to an extreme in assuming that apnoea is purely nervous

in origin. Haldane considers it is unnecessary to assume the existence of a vagus apnoea in man at all under normal circumstances. It is, however, probable that in normal breathing the nervous reflex and the chemical stimulus have both to be reckoned with, though the relative importance of these two factors is a question for the future.

## LESSON X

### URINE

1. Test the reaction of urine on litmus paper.
2. Determine its specific gravity by the urinometer.
3. Test for the following **inorganic salts** :

(a) *Chlorides*.—Acidulate with nitric acid and add silver nitrate; a white precipitate of silver chloride, soluble in ammonia, is produced. The object of acidulating with nitric acid is to prevent phosphates being precipitated by the nitrate of silver.

(b) *Sulphates*.—Acidulate with hydrochloric acid and add barium chloride. A white precipitate of barium sulphate is produced. Hydrochloric acid is again added first, to prevent precipitation of phosphates.

(c) *Phosphates*.—i. Add ammonia; a white crystalline precipitate of *earthy* (that is, calcium and magnesium) phosphates is produced. This becomes more apparent on standing. The *alkaline* (that is, sodium and potassium) phosphates remain in solution.

ii. Mix another portion of urine with half its volume of nitric acid; add ammonium molybdate, and boil. A yellow crystalline precipitate falls. This test is given by both kinds of phosphates.

4. **Urea**.—Take some urea crystals. Observe that they are readily soluble in water, and that effervescence occurs when fuming nitric acid (*i.e.* nitric acid containing nitrous acid in solution) is added to the solution. The effervescence is due to the breaking up of the urea. Carbonic acid and nitrogen come off. A similar bubbling, due to evolution of nitrogen, occurs when an alkaline solution of sodium hypobromite is added to another portion of the solution.

5. Heat some urea crystals in a dry test-tube. Biuret is formed, and ammonia comes off. Add a drop of copper-sulphate solution and a few drops of 20-per-cent. potash. A rose-red colour is produced.

6. Quantitative estimation of urea.

For this purpose Dupré's apparatus (fig. 41) is the most convenient. It consists of a bottle united to a measuring tube by indiarubber tubing. The measuring tube (an inverted burette will do very well) is placed within a cylinder of water, and can be raised and lowered at will. Measure 25 c.c. of alkaline solution of sodium hypobromite (made by mixing 2 c.c. of bromine with 23 c.c. of a 40-per-cent. solution of caustic soda) into the bottle. Measure 5 c.c. of urine into a small tube, and lower it carefully, so that no urine spills, into the bottle. Close the bottle securely with a stopper perforated by a glass tube: this glass tube<sup>1</sup> is connected to the measuring tube by

<sup>1</sup> The efficiency of the apparatus is increased by having a glass bulb blown on this tube to prevent froth passing into the rest of the apparatus. This is not shown in the figure.

indiarubber tubing and a T-piece. The third limb of the T-piece is closed by a piece of indiarubber tubing and a pinch-cock, seen at the top of the figure. Open the pinch-cock and lower the measuring tube until the surface

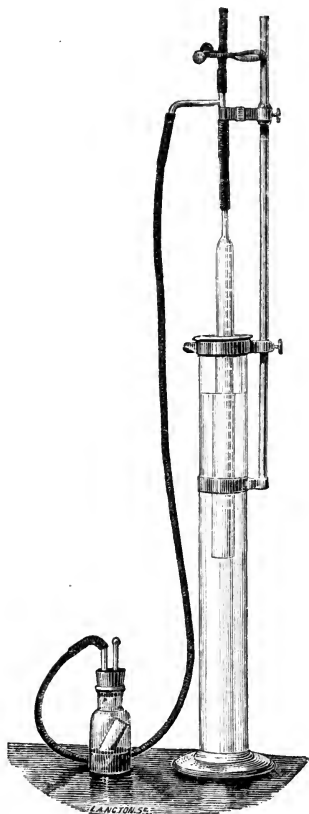

FIG. 41.—Dupré's urea apparatus.

of the water with which the outer cylinder is filled is at the zero point of the graduation. Close the pinch-cock, and raise the measuring tube to ascertain whether the apparatus is air-tight. Then lower it again. Tilt the bottle so as to upset the urine, and shake well for a minute or so. During this time there is an evolution of gas. Then immerse the bottle in a large beaker containing water of the same temperature as that in the cylinder. After two or three minutes raise the measuring tube until the surfaces of the water inside and outside it are at the same level. Read off the amount of gas evolved. This is nitrogen. The carbonic acid resulting from the decomposition of urea has been absorbed by the excess of soda in the bottle. 35.4 c.c. of nitrogen are yielded by 0.1 gramme of urea. From this the quantity of urea in the 5 c.c. of urine and the percentage of urea can be calculated. If the total urea passed in the twenty-four hours is to be ascertained, the twenty-four hours' urine must be carefully measured and thoroughly mixed. A sample is then taken from the total for analysis; and then, by a simple sum in proportion, the total amount of urea is ascertained.

**7. Creatinine.**—This substance may be detected by adding a little sodium nitro-prusside and caustic soda to the urine. A red colour develops, which fades on boiling.

The kidney is a compound tubular gland, the tubules of which it is composed differing much in the character of the epithelium that lines them in various parts of their course. The true secreting part of the kidney is the glandular epithelium that lines the convoluted portion of the tubules; there is in addition to this what is usually termed the filtering apparatus: tufts of capillary blood-vessels called the Malpighian glomeruli are supplied with afferent vessels from the renal artery; the efferent vessels that leave these have a smaller calibre, and thus there is high pressure in the Malpighian capillaries. Certain constituents of the blood, especially water and salts, pass

through the thin walls of these vessels into the surrounding Bowman's capsule, which forms the commencement of each renal tubule. Bowman's capsule is lined by a flattened epithelium, which is reflected over the capillary tuft. Though the process which occurs here is generally spoken of as a filtration, yet it is no purely mechanical process, but the cells undoubtedly exercise a selective influence, and, among other things, prevent the albuminous constituents of the blood from escaping. During the passage of this dilute urine through the rest of the renal tubule it gains the constituents, urea, urates, &c., which are poured into it by the secreting cells of the convoluted tubules.

### GENERAL CHARACTERS OF URINE

**Quantity.**—A man of average weight and height passes from 1,400 to 1,600 c.c., or about 50 oz., daily. This contains about 50 grammes ( $1\frac{1}{2}$  oz.) of solids. The urine should be collected in a tall graduated glass vessel capable of holding 3,000 c.c., which should have a smooth-edged neck accurately covered by a ground-glass plate to exclude dust and avoid evaporation. From the total quantity thus collected in the twenty-four hours samples should be drawn off for examination.

**Colour.**—This is some shade of yellow which varies considerably in health with the concentration of the urine. It appears to be due to a mixture of pigments: of these *urobilin* is the one of which we have the most accurate knowledge. Urobilin has a reddish tint and is ultimately derived from the blood pigment, and, like bile pigment, is an iron-free derivative of hæmoglobin. The bile pigment (and possibly also the hæmatin of the food) is in the intestines converted into stercobilin; most of the stercobilin leaves the body with the fæces; but some is reabsorbed and is excreted with the urine as urobilin. Urobilin is very like the artificial reduction product of bilirubin called hydrobilirubin (see p. 92). Normal urine, however, contains very little urobilin. The actual body present is a chromogen or mother substance called urobilinogen, which by oxidation (such as occurs when the urine stands exposed to the air) is converted into the pigment proper. In certain diseased conditions the amount of urobilin is considerably increased.

The most abundant urinary pigment is a yellow one called *urochrome*. It shows no absorption bands. It is probably an oxidation product of urobilin (Riva, A. E. Garrod). (See Lesson XXVI.)

**Reaction.**—The reaction of normal urine is acid. This is not due

to free acid, as the uric and hippuric acids in the urine are combined as urates and hippurates respectively. The acidity is due to acid salts, especially acid sodium phosphate. In certain circumstances the urine becomes less acid and even alkaline; the most important of these are as follows:—

1. During digestion. Here there is a formation of free acid in the stomach, and a corresponding liberation of bases in the blood which passing into the urine diminish its acidity, or even render it alkaline. This is called *the alkaline tide*; the opposite condition, *the acid tide*, occurs after a fast—for instance, before breakfast.

2. In herbivorous animals and vegetarians. The food here contains excess of alkaline salts of acids such as tartaric, citric, malic, &c.

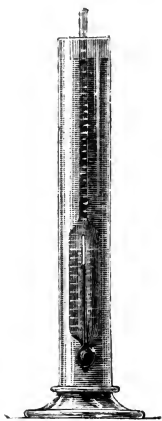

FIG. 42.—Urinometer floating in urine in a testing glass.

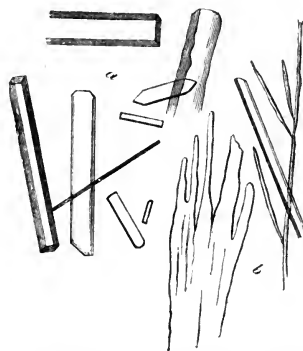

FIG. 43.—Crystals of urea: *a*, four-sided prisms; *b*, indefinite crystals, such as are usually formed from alcohol solutions.

These acids are oxidised into carbonates, which passing into the urine give it an alkaline reaction.

**Specific Gravity.**—This should be taken in a sample of the twenty-four hours' urine with a good urinometer (see fig. 42).

The specific gravity varies inversely as the quantity of urine passed under normal conditions from 1015 to 1025. A specific gravity below 1010 should excite suspicion of hydruria; one over 1030 of a febrile condition, or diabetes, a disease in which it may rise to 1050. The specific gravity has, however, been known to sink as low as 1002 (after large potations, *urina potus*), or to rise as high as 1035 (after great sweating) in perfectly healthy persons.

**Composition.**—The following table gives the average amounts of the urinary constituents passed by a man (taking an ordinary

diet containing about 100 grammes of protein) in the twenty-four hours:—

Water	1500·00 grammes
Total solids	72·00 "
Urea	33·18 "
Uric acid	0·55 "
Hippuric acid	0·40 "
Creatinine	0·91 "
Pigment and other organic substances	10·00 "
Sulphuric acid	2·01 "
Phosphoric acid	3·16 "
Chlorine	7·50 "
Ammonia	0·77 "
Potassium	2·50 "
Sodium	11·09 "
Calcium	0·26 "
Magnesium	0·21 "

The most abundant constituents of the urine are water, urea, and sodium chloride. In the foregoing table the student must not be misled by seeing the names of the acids and metals separated. The acids and the bases are combined to form salts:—urates, chlorides, sulphates, phosphates, &c.

### UREA

**Urea** or **Carbamide**,  $\text{CO}(\text{NH}_2)_2$ , is isomeric (that is, has the same empirical, but not the same structural formula) with ammonium cyanate  $(\text{NH}_4)\text{CNO}$ , from which it was first prepared synthetically by Wöhler in 1828. Since then it has been prepared synthetically in other ways. Wöhler's observation derives interest from the fact that this was the first organic substance which was prepared synthetically by chemists.

When separated from the urine, it is found to be readily soluble both in water and in alcohol: it has a saltish taste, and is neutral to litmus paper. The form of its crystals is shown in fig. 43.

When treated with nitric acid, nitrate of urea ( $\text{CON}_2\text{H}_4\cdot\text{HNO}_3$ ) is formed; this crystallises in octahedra, lozenge-shaped tablets, or hexagons (fig. 44, *a*). When treated with oxalic acid, prismatic crystals of urea oxalate ( $\text{CON}_2\text{H}_4\cdot\text{H}_2\text{C}_2\text{O}_4 + \text{H}_2\text{O}$ ) are formed (fig. 44, *b*).

These crystals may be readily obtained in an impure form by adding excess of the respective acids to urine which has been concentrated to a third or a quarter of its bulk.<sup>1</sup>

Under the influence of certain organised ferments, such as the micrococcus ureæ, which grows readily in stale urine, urea takes up

<sup>1</sup> The preparation of urea nitrate and urea oxalate is postponed to the next lesson, when other microscopic crystals will also be under examination.

water, and is converted into ammonium carbonate [ $\text{CON}_2\text{H}_4 + 2\text{H}_2\text{O} = (\text{NH}_4)_2\text{CO}_3$ ]. Hence the ammoniacal odour of putrid urine.

By means of nitrous acid, urea is broken up into carbonic acid, water, and nitrogen,  $\text{CON}_2\text{H}_4 + 2\text{HNO}_2 = \text{CO}_2 + 3\text{H}_2\text{O} + 2\text{N}_2$ . This may be used as a test for urea. Add fuming nitric acid (*i.e.* nitric acid containing nitrous acid in solution) to a solution of urea, or to urine; an abundant evolution of gas bubbles takes place.

Hypobromite of soda decomposes urea in the following way:—

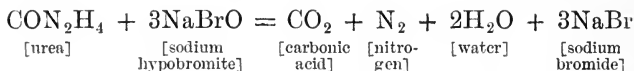

This reaction is important, for on it one of the readiest methods for estimating urea depends. There have been various pieces of apparatus invented for rendering the analysis easy; but the one described

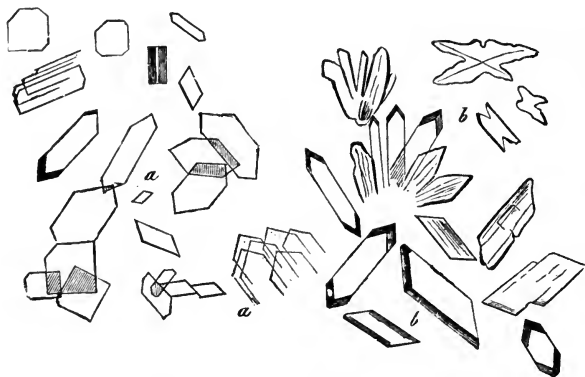

FIG. 44.—*a*, nitrate; *b*, oxalate of urea.

in the practical exercise at the head of this lesson is the best. If the experiment is performed as directed, nitrogen is the only gas that comes off, the carbonic acid being absorbed by excess of soda. The amount of nitrogen is a measure of the amount of urea.

The quantity of urea excreted is somewhat variable, the chief cause of variation being the amount of protein food ingested. In a man taking the usual Voit diet containing about 100 grammes of protein (which will contain about 16 grammes of nitrogen) the quantity of urea excreted daily averages 33 grammes (500 grains). The percentage in human urine would then be 2 per cent.; but this also varies, because the concentration of the urine varies considerably in health. The excretion of urea is usually at a maximum three hours after a meal, especially after a meal rich in protein.

Muscular exercise has but little effect on the amount of nitrogen



discharged. This is strikingly different from what occurs in the case of carbonic acid; the more the muscles work, the more carbonic acid do they send into venous blood, which is rapidly discharged by the expired air. Muscular energy is derived normally from the combustion of non-nitrogenous material; this is very largely carbohydrate. If the muscles, however, are not supplied with the proper amount of carbohydrate and fat, or if the work done is very excessive, then they consume some of their more precious protein material.

**Where is Urea formed?**—The older authors considered that it was formed in the kidneys, just as they also erroneously thought that carbonic acid was formed in the lungs. Prévost and Dumas were the first to show that after complete extirpation of the kidney the formation of urea and other waste products goes on, and these accumulate in the blood and tissues. Similarly, in those cases of disease in which the kidneys cease work, urea is still formed and accumulates. This condition is called *uræmia* (or urea in the blood), and unless the waste substances are discharged from the body the patient dies.

*Uræmia.*—This term was originally applied on the erroneous supposition that it is urea or some antecedent of urea which acts as the poison. There is no doubt that the poison is not any constituent of normal urine; if the kidneys of an animal are extirpated the animal dies in a few days, but there are no uræmic convulsions. In man also, if the kidneys are healthy or approximately so, and suppression of urine occurs from the simultaneous blocking of both renal arteries by clot, or of both ureters by stones, again uræmia does not follow. On the other hand, uræmia may occur even while a patient with diseased kidneys is passing a considerable amount of urine. What the poison is that is responsible for the convulsions and coma is unknown. It is doubtless some abnormal katabolic product, but whether this is produced by the diseased kidney cells, or in some other part of the body, is also unknown.

Where, then, is the seat of urea formation? The facts of experiment and of pathology point very strongly in support of the theory that urea is formed in the liver. The principal are the following:—

1. After removal of the liver in such animals as frogs, urea formation almost ceases, and ammonia is found in the urine instead.

2. In mammals, the extirpation of the liver is such a serious operation that the animals die. But the liver of mammals can be very largely thrown out of gear by the operation known as Eck's fistula, which consists in connecting the portal vein directly to the inferior vena cava. In these circumstances the liver receives blood only by the hepatic artery. The amount of urea is lessened, and its place is taken by ammonia.

3. When degenerative changes occur in the liver, as in *cirrhosis* of that organ, the urea formed is much lessened, and its place is taken by ammonia. In *acute yellow atrophy*, urea is almost absent from the

urine, and, again, there is considerable increase in the ammonia. In this disease amino-acids such as leucine and tyrosine are also found in the urine; these originate in the intestine, and, escaping further decomposition in the degenerated liver, pass as such into the urine.

We have to consider next the intermediate stages between protein and urea. In order that the student may grasp the meaning of urea formation it would be advisable for him to turn again to p. 52 and read the paragraph there relating to Chittenden's views on diet, and to pp. 96 to 98, which treat of protein absorption, for the question, What is a normal diet? is intimately bound up with the question, What is a normal urine? If, for instance, the diet of the future is to contain only half as much protein as in the past, the urine of the future will naturally show a nitrogenous output of half of that which has hitherto been regarded as normal. In people on such a reduced diet, Folin has shown that the decrease in urinary nitrogen falls mainly on the urea, but certain other nitrogenous katabolites, particularly one called creatinine, remain remarkably constant in absolute amount in spite of the great reduction in the protein ingested.

The laws governing the composition of urine are obviously the effect of the laws that govern protein katabolism. Many years ago Voit supposed that the protein ingested was utilised partly in tissue formation, and partly remained in the circulating fluids as 'circulating protein'; he further considered that the breakdown of the protein in the tissues was accomplished with much greater difficulty than that in blood and lymph, and that the small amount of 'tissue-protein' which disintegrates as the result of the wear and tear of the tissues was dissolved and added to the 'circulating protein,' in which alone the formation of final katabolic products such as urea was supposed to occur. As time went on, it was shown that many facts were incompatible with this theory, and so it was largely displaced by Pflüger's view, in which it was held that the food protein must first be assimilated, and become part and parcel of living cells, before katabolism occurs. We now know that neither of these views is correct, and that nitrogenous katabolism is of two kinds: one kind varies with the food; it is therefore variable in amount, and occurs almost immediately or within a few hours after the food is absorbed; the amino-acids absorbed from the intestine are in great measure never built into living protoplasm at all, and are simply taken to the liver, where they are converted into urea. This variety of katabolism is called *exogenous*. The other kind of metabolism is constant in quantity and smaller in amount, and is due to the actual breakdown of protein matter in the body cells and tissues, which had been built into them

previously. This form of metabolism is called *endogenous* or *tissue* metabolism, and the final product is not urea to any great extent, but the waste nitrogen finds its way out of the body in other substances, of which creatinine appears to be the most important. This form of metabolism sets a limit to the lowest level of nitrogenous requirement attainable; the protein sufficient to maintain it is indispensable. Whether the amount of protein which is exogenously metabolised can be entirely dispensed with is at present questionable, and those who seek to replace it entirely by non-nitrogenous food are living dangerously near the margin. A point of considerable importance in this connection is, that the nitrogen of the protein is split off from it by hydrolysis without oxidation. There is thus very little loss of potential energy, the energy of the products being nearly equal to that of the original protein; it is, however, the non-nitrogenous residue which is mainly available for oxidation, and thus for calorific processes. The fact that muscular work does not normally increase nitrogenous metabolism becomes intelligible in the light of the consideration that protein katabolism, in so far as its nitrogen is concerned, is independent of the oxidations which give rise to heat, or to the energy which is converted into work. Those who in the past have endeavoured to study the relation of muscular work to nitrogen excretion have usually estimated the urea. Now that we know urea is the chief end product of exogenous and not of tissue katabolism, we see that estimations of urea can give us but little real information on this point. The substance which ought to be estimated is creatinine, and it has been found recently that even this is not notably increased in the urine, provided the muscles receive their normal supply of fat and carbohydrate. The body is very economical in so far as protein is concerned, and tissue or endogenous katabolism is kept at a low level.

What is the proportion between exogenous and endogenous nitrogen katabolism? It is very difficult to give any exact estimate. We do know that in ordinary diets, the former is far in excess, and probably in a man excreting 16 grammes of nitrogen daily (that is, the amount corresponding to an intake of 100 grammes of protein), only a quarter of this or even less represents tissue breakdown.

The view we have advanced concerning urea formation, then, is, that it is mainly the result of the conversion, by the liver, of amino-acids absorbed from the intestine into that substance. This view receives confirmation from experiments in which certain amino-acids, such as glycine, leucine, and arginine, have been injected direct into the blood-stream. The result is an increased formation of urea. In

the case of arginine the exact chemical decomposition which takes place is known. We have already seen that arginine is a compound of a urea radical and a substance called ornithine (di-amino-valeric acid, see p. 32); the liver is able to hydrolyse arginine, and so urea is liberated. This power is due to the action of a special ferment called *arginase*, which, although it is also found in other organs, is specially abundant in the liver. It is, however, possible that the ornithine itself may be further broken up, and so an extra quantity of urea formed. On the other hand there are some amino-acids (*e.g.* tyrosine) which on injection do not lead to any increase in urea formation.

If, however, we glance at the formula of ornithine, we see that it has one point in common with other amino-acids, such as glycine and leucine, to take simple examples:—

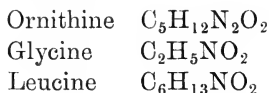

This is, that in all cases the carbon atoms are more numerous than the nitrogen atoms. In urea,  $CON_2H_4$ , the reverse is the case. The amino-acids must therefore be split into simpler compounds, which unite with one another to form urea. Urea formation is thus in part synthetic. These simpler compounds are ammonium salts. Schröder's work proves that ammonium carbonate is one of the urea precursors, if not the principal one. The equation which represents the reaction is as follows:—

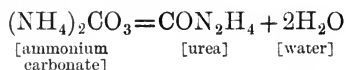

Schröder's principal experiment was this: a mixture of defibrinated blood and ammonium carbonate was injected into the liver by the portal vein; the blood leaving the liver by the hepatic vein was found to contain urea in great abundance. This does not occur when the same experiment is performed with any other organ of the body, so that Schröder's experiments also prove the great importance of the liver in urea formation. Similar results were obtained by Nencki with ammonium carbamate.

We must further remember that ammonia itself is one of the products of digestion of protein in the intestine, and it may possibly, to a small extent, be a result of tissue katabolism. This ammonia passes into the blood, where it unites with carbonic acid to form either the carbamate or carbonate of ammonium. Thus ammonia, whether

formed directly or by the breakdown of amino-acids, is the principal immediate precursor of urea.

The following structural formulæ show the relationship between ammonium carbonate, ammonium carbamate, and urea :—

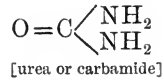
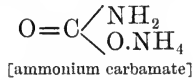
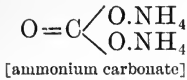

The loss of one molecule of water from ammonium carbonate produces ammonium carbamate; the loss of a second molecule of water produces urea.

### AMMONIA

The urine of man and carnivora contains small quantities of ammonium salts. The reason that some ammonia always slips through into the urine is that a part of the ammonia-containing blood passes through the kidney before reaching organs, such as the liver, which are capable of synthesising urea. In man the daily amount of ammonia excreted varies between 0·3 and 1·2 gramme: the average is 0·7 gramme. The ingestion of ammonium carbonate does not increase the amount of ammonia in the urine, but increases the amount of urea, into which substance the ammonium carbonate is easily converted. But if a more stable salt, like ammonium chloride, is given, it appears as such in the urine.

Under normal circumstances the amount of ammonia depends on the adjustment between the production of acid substances in metabolism and the supply of bases in the food. Ammonia formation is the physiological remedy for deficiency of bases.

When the production of acids is excessive (as in diabetes), or when mineral acids are given by the mouth or injected into the blood-stream, the result is an increase of the physiological remedy, and excess of the ammonia passes over into the urine. Under normal conditions ammonia is kept at a minimum, being finally converted into the less toxic substance urea, which the kidneys easily excrete. The defence of the organism against acids which are very toxic is an increase of ammonia formation, or, to put it more correctly, less of the ammonia formed is converted into urea.

Under the opposite conditions—namely, excess of alkali, either in food or given as such—the ammonia disappears from the urine, all being converted into urea. Hence the diminution of ammonia in the urine of man on a vegetable diet, and its absence in the urine of herbivorous animals.

Not only is this the case but if ammonium chloride is given to a

herbivorous animal like a rabbit, the urinary ammonia is but little increased. It reacts with sodium carbonate in the tissues, forming ammonium carbonate (which is excreted as urea) and sodium chloride. Herbivora also suffer much more from, and are more easily killed by, acids than carnivora, their organisation not permitting a ready supply of ammonia to neutralise excess of acids.

### CREATININE

Creatinine is one of the substances in the urine which represents the end-stage of the tissue or endogenous katabolism of protein. It is the most abundant of such katabolites, and the one concerning which we know most.

The most abundant of our active tissues is muscle, and the amount of nitrogenous waste in this tissue which leaves it as urea is insignificant. The place of urea is taken by another substance called *creatine*. As already explained on p. 32, creatine is a compound of a urea radical with another group, and when it is boiled with baryta water it takes up water and splits into two substances—namely, urea and sarcosine or methyl-glycine; this is shown in the following equation:—

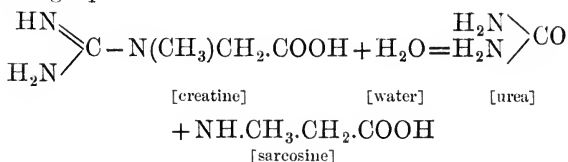

It is, however, extremely doubtful whether this decomposition occurs in the body, and therefore whether creatine is to any important degree a precursor of urea. For, when creatine is introduced directly into the blood-stream, the amount of urea is not increased in the urine. What is increased is another substance called creatinine, which is creatine *minus* water, as shown in the following equation:—

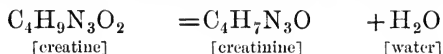

Creatinine, therefore, comes from nitrogenous katabolism in the tissues, especially muscular tissues, and creatine is an intermediate stage in its formation. Some of the creatinine, however, has a different origin—namely, an *exogenous* one; that is, from the food instead of from tissue metabolism; and the substance in the food which gives rise to it is the creatine contained in the flesh eaten.

The best method for estimating creatinine and creatine is given in Lesson XXV.

## THE INORGANIC CONSTITUENTS OF URINE

The inorganic or mineral constituents of urine are chiefly chlorides, phosphates, sulphates, and carbonates; the metals with which these are in combination are sodium, potassium, ammonium, calcium, and magnesium. The total amount of these salts excreted varies from 19 to 25 grammes daily. The most abundant is sodium chloride, which averages in amount 10 to 13 grammes per diem. These substances are derived from two sources—first from the food, and secondly as the result of metabolic processes. The chlorides and most of the phosphates come from the food; the sulphates and some of the phosphates are a result of metabolism. The sulphates are derived from the changes that occur in the proteins; the nitrogen of proteins leaves the body chiefly as urea; the sulphur of the proteins is oxidised to form sulphuric acid, which passes into the urine in the form of sulphates. The excretion of sulphates, moreover, runs parallel to that of urea. Sulphates, like urea, are the result of exogenous protein metabolism; endogenous metabolism so far as sulphur is concerned is represented in the urine partly as ethereal sulphates, but chiefly by less fully oxidised compounds of sulphur. The chief tests for the various salts have been given in the practical exercises at the head of this lesson.

**Chlorides.**—The chief chloride is that of sodium. The ingestion of sodium chloride is followed by its appearance in the urine, some on the same day, some on the next day. Some is decomposed to form the hydrochloric acid of the gastric juice. The salt, in passing through the body, fulfils the useful office of stimulating metabolism and excretion.

**Sulphates.**—The sulphates in the urine are principally those of potassium and sodium. They are derived from the metabolism of proteins in the body. Only the smallest trace enters the body with the food. Sulphates have an unpleasant bitter taste (for instance, Epsom salts); hence we do not take food that contains them. The sulphates vary in amount from 1.5 to 3 grammes daily.

In addition to these sulphates there is a small quantity of sulphuric acid comprising about one-tenth of the total which is combined with organic radicals; the compounds are known as ethereal sulphates, and they originate mainly from putrefactive processes occurring in the intestine. The most important of these ethereal sulphates are phenyl sulphate of potassium and indoxyl sulphate of potassium. The latter originates from the indole formed in the intestine, and as it yields indigo when treated with certain

reagents it is sometimes called *indican*. It is very important to remember that the indican of urine is not the same thing as the indican of plants. Both yield indigo, but there the resemblance ceases.

The equation representing the formation of potassium phenyl-sulphate is as follows :—

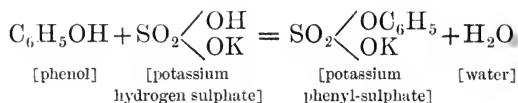

The formation of potassium indoxyl-sulphate may be represented

as follows :— Indole,  $\text{C}_6\text{H}_4 \begin{array}{l} \text{CH} \\ \diagdown \diagup \\ \text{NH} \end{array} \text{CH}$  on absorption is converted

into indoxyl:  $\text{C}_6\text{H}_4 \begin{array}{l} \text{C.OH} \\ \diagdown \diagup \\ \text{NH} \end{array} \text{CH}$

Indoxyl then interacts with potassium hydrogen sulphate as follows :—

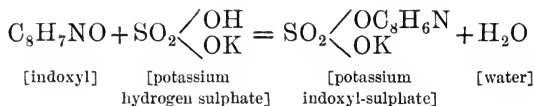

The formation of such sulphates is important ; the aromatic substances liberated by putrefactive processes in the intestine are poisonous, but their conversion into ethereal sulphates renders them innocuous. (For tests for indoxyl in urine see Advanced Course, Lesson XXVI.)

**Carbonates.**—Carbonates and bicarbonates of sodium, calcium, magnesium, and ammonium are present in alkaline urine only. They arise from the carbonates of the food, or from vegetable acids (malic, tartaric, &c.) in the food. They are, therefore, found in the urine of herbivora and vegetarians, whose urine is thus rendered alkaline. Urine containing carbonates becomes, like saliva, cloudy on standing, the precipitate consisting of calcium carbonate, and also phosphates.

**Phosphates.**—Two classes of phosphates occur in normal urine :—

(1) Alkaline phosphates—that is, phosphates of sodium (abundant) and potassium (scanty).



(2) Earthy phosphates—that is, phosphates of calcium (abundant) and magnesium (scanty).

The composition of the phosphates in urine is liable to variation. In acid urine the acidity is due to the acid salts. These are chiefly sodium dihydrogen phosphate,  $\text{NaH}_2\text{PO}_4$ , and calcium dihydrogen phosphate,  $\text{Ca}(\text{H}_2\text{PO}_4)_2$ .

In neutral urine, in addition, disodium hydrogen phosphate ( $\text{Na}_2\text{HPO}_4$ ), calcium hydrogen phosphate,  $\text{CaHPO}_4$ , and magnesium hydrogen phosphate,  $\text{MgHPO}_4$ , are found. In alkaline urine there may be instead of, or in addition to the above, the normal phosphates of sodium, calcium, and magnesium [ $\text{Na}_3\text{PO}_4$ ,  $\text{Ca}_3(\text{PO}_4)_2$ ,  $\text{Mg}_3(\text{PO}_4)_2$ ].

The earthy phosphates are precipitated by rendering the urine alkaline by ammonia. In decomposing urine, ammonia is formed from the urea: this also precipitates the earthy phosphates. The phosphates most frequently found in the white creamy precipitate which occurs in decomposing urine are—

(1) Triple phosphate or ammonio-magnesium phosphate ( $\text{NH}_4\text{MgPO}_4 + 6\text{H}_2\text{O}$ ). This crystallises in 'coffin-lid' crystals (see fig. 45) or feathery stars.

(2) Stellar phosphate, or calcium phosphate, which crystallises in star-like clusters of prisms.

As a rule, normal urine gives no precipitate when it is boiled; but sometimes neutral, alkaline, and occasionally faintly acid urines give a precipitate of calcium phosphate when boiled; this precipitate is amorphous, and is liable to be mistaken for albumin. It may be distinguished readily from albumin, as it is soluble in a few drops of acetic acid, whereas coagulated protein does not dissolve.

The phosphoric acid in the urine chiefly originates from the phosphates of the food, but is partly a decomposition product of the phosphorised organic materials in the body, such as lecithin and nuclein. The amount of  $\text{P}_2\text{O}_5$  in the twenty-four hours' urine varies from 2.5 to 3.5 grammes, of which the earthy phosphates contain about half (1 to 1.5 gr.).

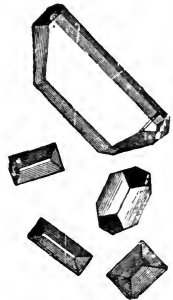

FIG. 45.—Ammonio-magnesium or triple phosphate.

## LESSON XI

### URINE (*continued*)

1. **Urea Nitrate.**—Evaporate some urine in a capsule to a quarter of its bulk. Pour the concentrated urine into a watch-glass; let it cool, and add a few drops of strong, but not fuming, nitric acid. Crystals of urea nitrate separate out. Examine these microscopically.

2. **Urea Oxalate.**—Concentrate the urine as in the last exercise, and add oxalic acid. Crystals of urea oxalate separate out. Examine these microscopically.

3. **Uric Acid.**—Examine microscopically the crystals of uric acid in some urine, to which 5 per cent. of hydrochloric acid has been added twenty-four hours previously. Note that they are deeply tinged with pigment, and to the naked eye look like granules of cayenne pepper.

When microscopically examined, the crystals are seen to be large bundles, principally in the shape of barrels, with spicules projecting from the ends, and whetstones. If oxalic acid is used instead of hydrochloric acid in this experiment, the crystals are smaller, and more closely resemble those observed in pathological urine in cases of uric acid gravel (see fig. 46).

Dissolve the crystals in caustic potash and then carefully add excess of hydrochloric acid. Small crystals of uric acid again form.

**Murexide Test.**—Place a little uric acid, or a urate (for instance, serpent's urine), in a capsule; add a little dilute nitric acid and evaporate to dryness. A yellowish-red residue is left. Add a little ammonia carefully. The residue turns to violet. This is due to the formation of murexide or purpurate of ammonia. On the addition of potash the colour becomes bluer.

**Schiff's Test.**—Dissolve some uric acid in sodium carbonate solution. Put a drop of this on blotting paper, add a drop of silver nitrate, and warm gently; the black colour of reduced silver is seen on the paper.

4. **Deposits of Urates or Lithates (Lateritious Deposit).**—The specimen of urine from the hospital contains excess of urates, which have become deposited on the urine becoming cool. They are tinged with pigment (uroerythrin), and have a pinkish colour, like brickdust; hence the term 'lateritious.' Examine microscopically. The deposit is usually amorphous—that is, non-crystalline. Sometimes crystals of calcium oxalate (envelope crystals—octahedra) are seen also; these are colourless.

The deposit of urates dissolves on heating the urine.

5. **Deposit of Phosphates.**—Another specimen of pathological urine contains excess of phosphates, which have formed a white deposit on the urine becoming alkaline. This precipitate does not dissolve on heating; it may be increased. It is, however, soluble in acetic acid. Examine microscopically for coffin-lid crystals of triple phosphate (ammonio-magnesium phosphate), for crystals of stellar (calcium) phosphate, and for mucus. Mucus is flocculent to the naked eye, amorphous to the microscope.

N.B.—On boiling neutral, alkaline, or even faintly acid urine it may become turbid from deposition of phosphates. The solubility of this deposit in

a few drops of acetic acid distinguishes it from albumin, for which it is liable to be mistaken.

Some of the facts described in the foregoing exercises have been already dwelt upon in the preceding lesson. They are, however, conveniently grouped together here, as all involve the use of the microscope.

## URIC ACID

**Uric Acid** ( $C_5N_4H_4O_3$ ) is in mammals the medium by which only a small quantity of nitrogen is excreted from the body. It is, however, in birds and reptiles the principal nitrogenous constituent of their urine. It is not present in the free state, but is combined with bases to form urates.

It may be obtained from human urine by adding 5 c.c. of hydrochloric acid to 100 c.c. of the urine, and allowing the mixture to stand for twelve to twenty-four hours. The crystals which form are deeply tinged with urinary pigment, and though by repeated solution in caustic soda or potash, and reprecipitation by hydrochloric acid, they may be obtained fairly free from pigment, pure uric acid is more readily obtained from the solid urine of a serpent or bird, which consists principally of the acid ammonium urate. This is dissolved in soda, and then the addition of hydrochloric acid produces as before the crystallisation of uric acid from the solution.

The pure acid crystallises in colourless rectangular plates or prisms. In striking contrast to urea it is a most insoluble substance, requiring for its solution 1,900 parts of hot and 15,000 parts of cold water. The forms which uric acid assumes when precipitated from human urine, either by the addition of hydrochloric acid or in certain pathological processes, are very various, the most frequent being the whetstone shape; there are also bundles of crystals resembling sheaves, barrels, and dumb-bells (see fig. 46).

The murexide test which has just been described among the practical exercises is the principal test for uric acid. The test has received the name on account of the resemblance of the colour to the purple of the ancients, which was obtained from certain snails of the genus *Murex*.

Another reaction that uric acid undergoes (though it is not applicable as a test) is that on treatment with certain oxidising reagents



FIG. 46.—Uric acid crystals.

urea and oxalic acid can be obtained from it. It is, however, doubtful whether a similar oxidation occurs in the normal metabolic processes of the body.

Uric acid is dibasic, and thus there are two classes of urates—the normal urates and the acid urates. A normal urate is one in which two atoms of the hydrogen are replaced by two of a monad metal like sodium; an acid urate is one in which only one atom of hydrogen is thus replaced. The formulæ would be—

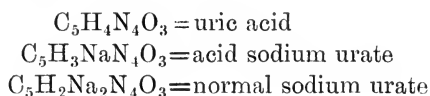

The acid sodium urate is the chief constituent of the pinkish deposit of urates, which, as we have already stated, is called the lateritious deposit.

If uric acid is represented by  $\text{H}_2\text{U}$ , the normal urates may be represented by  $\text{M}_2\text{U}$  and the acid urates by  $\text{MHU}$ . Bence Jones, and later Sir W. Roberts, considered that the urates which actually occur in urine are quadriurates,  $\text{MHU.H}_2\text{U}$ . There is much doubt whether such compounds actually exist; if they do they are readily decomposed into acid urates  $\text{MHU}$  and free uric acid,  $\text{H}_2\text{U}$ .

The quantity of uric acid excreted by an adult varies from 7 to 10 grains (0.5 to 0.75 gramme) daily.

The best method for determining the quantity of uric acid in the urine is that of Hopkins. Ammonium chloride in crystals is added to the urine until no more will dissolve. This saturation completely precipitates all the uric acid in the form of ammonium urate. After standing for two hours the precipitate is collected on a filter, washed with saturated solution of ammonium chloride, and then dissolved in weak alkali. From this solution the uric acid is precipitated by neutralising with hydrochloric acid. The precipitate of uric acid is collected on a weighed filter, dried and weighed, or titration may be performed with potassium permanganate (see Advanced Course).

**Origin of Uric Acid.**—Uric acid is not made by the kidneys. When the kidneys are removed uric acid continues to be formed and accumulates in the organs, especially in the liver and spleen. The liver has been removed from birds, and uric acid is then hardly formed at all, its place being taken by ammonia and lactic acid. It is therefore probable that in these animals ammonia and lactic acid are normally synthesised in the liver to form uric acid.

This synthetic origin of uric acid, which is so important in birds and snakes, does not, however, occur in mammals. In mammals uric acid is the chief end-product of the katabolism of cell nuclei or

of nuclein, the principal constituent of the nuclei. This therefore leads us next to study:—

**Purine Substances.**—Emil Fischer has shown that the decomposition products of nuclein are derivatives of a substance he has named purine. The empirical formulæ for purine, the purine bases, and uric acid are as follows:—

Purine . . .	$C_5H_4N_4$		
Hypoxanthine .	$C_5H_4N_4O$	Monoxypurine	} Purine bases.
Xanthine . . .	$C_5H_4N_4O_2$	Dioxypurine	
Adenine . . .	$C_5H_3N_4.NH_2$	Amino-purine	
Guanine . . .	$C_5H_3N_4O.NH_2$	Amino-oxypurine	
Uric acid . . .	$C_5H_4N_4O_3$	Trioxypurine	

There are a vast number of purine derivatives, but only a few of them have at present any physiological importance. Others in addition to those already enumerated are theophylline (dimethyl-xanthine), theobromine (also a dimethyl-xanthine), caffeine (trimethyl-xanthine); these are of interest, as they occur in tea, cocoa, and coffee. A few words more may be added in respect to those in our list.

**Purine** itself has never been discovered in the body. It has the following structural formula:

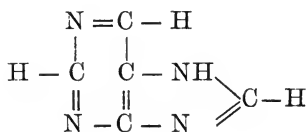

The purine nucleus is depicted in the next formula, and its atoms have been empirically numbered as shown for convenience of description:—

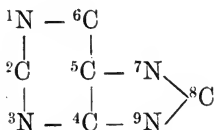

**Hypoxanthine** or **Sarcine** is found in the body tissues and fluids, and in the urine. It is derived from some nucleins, especially those from fishes' spermatozoa. It may be termed 6-oxypurine, as the oxygen is attached to the atom number 6 in the purine nucleus.

**Xanthine** is found with hypoxanthine in the body, and has been obtained from a number of nucleins (from spermatozoa, thymus,

pancreas, &c.). It is 2, 6-dioxypurine, its oxygen atoms being attached to the atoms numbered 2 and 6 in the purine nucleus.

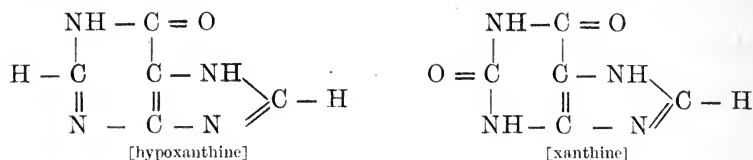

**Adenine** is found in the tissues, blood, and urine. It is obtained from several nucleins, but especially from the nuclein derived from the thymus. It is 6-amino-purine.

**Guanine** is also a decomposition product of nucleins, especially of that obtained from the pancreas. Combined with calcium it gives the brilliancy to the scales of fishes, and is also found in the bright tapetum of the eyes in these animals. It is a constituent of guano, and here is probably derived from the fish eaten by marine birds. It is 2-amino-6-oxypurine.

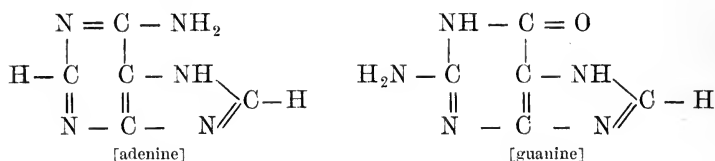

**Uric acid** is 2, 6, 8-trioxypurine.

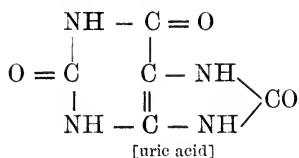

The close chemical relationship of uric acid to the purine bases is obvious from a study of the formulæ just given. Just as in the case of urea, uric acid, however, may be exogenously or endogenously formed. Certain kinds of food increase uric acid because they contain nuclein (for instance, sweetbreads) in abundance, or purine bases (for instance, hypoxanthine in meat); the uric acid which originates in this way is termed *exogenous*. Certain diets, on the other hand, increase uric acid formation by leading to an increase of leucocytes, and consequently increase in the metabolism of their nuclei; in other cases the leucocytes may increase from other causes, as in the disease named leucocythæmia. The uric acid that arises from nuclear katabolism is termed *endogenous*. Although special attention has been

directed to the nuclei of leucocytes because they can be readily examined during life, it must be remembered that nuclein metabolism of all cells may contribute to uric acid formation.

A study of uric acid formation forms a useful occasion on which to allude to ferment actions in metabolism generally. Ferments of a digestive kind are not confined to the interior of the alimentary canal; but most of the body cells are provided with ferments to assist them either in utilising the nutrient materials brought to them by the blood-stream, or in breaking them down previously to expelling them as waste substances. The ferment which enables the liver cells to turn glycogen into sugar is the one which has been known longest. The ferment called arginase (see p. 150), which leads to the hydrolysis of arginine into urea and ornithine, is one of the most recently discovered. Other examples which may be mentioned are proteolytic enzymes (tissue erepsin, &c.) found in many organs.

The formation of uric acid from nuclein is perhaps the best instance of all, for here we have to deal with numerous ferments acting one after another. The first to come into play is called *nuclease*; this liberates purine bases such as adenine and guanine from the nuclein; the next ferments that act remove the amino-group from the purine bases just mentioned; in this way adenine ( $C_5H_3N_4.NH_2$ ) is converted into hypoxanthine  $C_5H_4N_4O$ ; and guanine ( $C_5H_3N_4O.NH_2$ ) into xanthine  $C_5H_4N_4O_2$ . These two ferments are respectively called *adenase* and *guanase*. Finally, oxidising ferments, or *oxidases*, step in and oxidise hypoxanthine into xanthine, and xanthine into uric acid. By examining extracts of various organs, the distribution of these numerous ferments has been determined, and in general terms the spleen and liver are the organs where they are most abundant. But the examination of such extracts has shown in addition that the list of ferments is not yet complete; for some extracts in part break up the uric acid, which is formed into simpler substances; the uric acid destroying ferment is called the *uricolytic* ferment. We therefore learn that the uric acid discharged in the urine is only the balance left over when the amount destroyed is deducted from the amount originally formed. In other words, the body possesses to some extent the power of protecting itself from an excessive formation of uric acid, and so from the evils which would result from an accumulation of this substance.

### HIPPURIC ACID

**Hippuric acid** ( $C_9H_9NO_3$ ), combined with bases to form hippurates, is present in small quantities in human urine, but in large quantities in that of herbivora. This is due to the food of herbivora containing substances belonging to the aromatic group—the benzoic acid series. If benzoic acid is given to a man, it unites with glycine with the elimination of a molecule of water, and is excreted as hippuric acid—

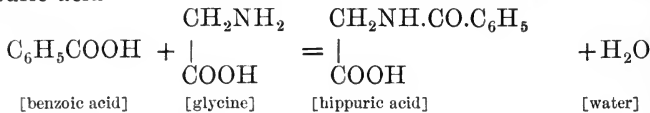

This is a well-marked instance of synthesis carried out in the animal body, and experimental investigation shows that it is accomplished by the living cells of the kidney itself; for if a mixture of glycine, benzoic acid, and defibrinated blood is injected through the kidney (or mixed with a minced kidney just removed from the body of an animal), their place is found to have been taken by hippuric acid.

It may be crystallised from horse's urine by evaporating to a syrup and saturating with HCl. The crystals are dissolved in boiling water, filtered, and on cooling the acid again crystallises out. It melts at  $186^\circ C.$ , and on further heating gives rise to the odour of bitter almond oil.

### URINARY DEPOSITS

The different substances that may occur in urinary deposits are formed elements and chemical substances.

The **formed** or **histological elements** may consist of blood corpuscles, pus, mucus, epithelium cells, spermatozoa, casts of the urinary tubules, fungi, and entozoa. All of these, with the exception of a small quantity of mucus, which forms a flocculent cloud in the urine, are pathological, and the microscope is chiefly employed in their detection.

The **chemical substances** are uric acid, urates, calcium oxalate, calcium carbonate, and phosphates. Rarer forms are leucine, tyrosine, xanthine, and cystin. We shall, however, here only consider the commoner deposits, and for their identification the microscope and chemical tests must both be employed.

**Deposit of Uric Acid.**—This is a sandy reddish deposit resembling cayenne pepper. It may be recognised by its crystalline form (fig. 46, p. 157) and by the murexide reaction. The presence of these crystals generally indicates an increased formation of uric acid, and,



if excessive, may lead to the formation of stones or calculi in the bladder.

**Deposit of Urates.**—This is much commoner, and may, if the urine is concentrated, occur in normal urine when it cools. It is generally found in the concentrated urine of fevers; and there appears to be a kind of fermentation, called the acid fermentation, which occurs in the urine after it has been passed, and which leads to the same result. The chief constituent of the deposit is the acid sodium urate, the formation of which from the normal sodium urate of the urine may be represented by the equation—

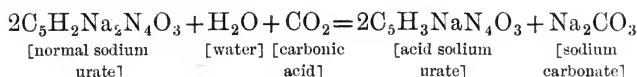

This deposit may be recognised as follows :—

1. It has a pinkish colour; the pigment called *uro-erythrin* is one

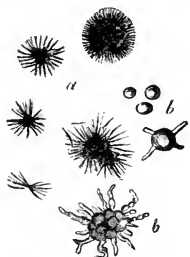

FIG. 47.—Acid sodium urate.



FIG. 48.—Acid ammonium urate.

of the pigments of the urine, but its relationship to the other urinary pigments is not known (see further Lesson XXVI.).

2. It dissolves upon warming the urine.

Microscopically it is usually amorphous, but crystalline forms similar to those depicted in figs. 47 and 48 may occur.

Crystals of calcium oxalate may be mixed with this deposit (see fig. 49).

**Deposit of Calcium Oxalate.**—This occurs in envelope crystals (octahedra) or dumb-bells.

It is insoluble in ammonia, and in acetic acid. It is soluble with difficulty in hydrochloric acid.

**Deposit of Cystin.**—Cystin ( $\text{C}_6\text{H}_{12}\text{N}_2\text{S}_2\text{O}_4$ ) is recognised by its colourless six-sided crystals (fig. 50). These are rare: they occur only in acid urine, and they may form concretions or calculi. Cystinuria (cystin in the urine) is hereditary.

**Deposit of Phosphates.**—These occur in alkaline urine. The

urine may be alkaline when passed, due to fermentative changes occurring in the bladder. All urine, however, if exposed to the air (unless the air is perfectly pure, as on the top of a snow mountain), will in time become alkaline owing to the growth of the *micrococcus ureæ*. This forms ammonium carbonate from the urea.

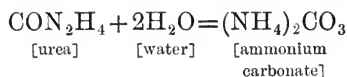

The ammonia renders the urine alkaline, and precipitates the



FIG. 49.—Envelope crystals of calcium oxalate.

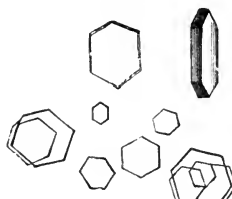

FIG. 50.—Cystin crystals.

earthy phosphates. The chief forms of phosphates that occur in urinary deposits are—

1. Calcium phosphate,  $\text{Ca}_3(\text{PO}_4)_2$ ; amorphous.
2. Triple or ammonio-magnesium phosphate,  $\text{MgNH}_4\text{PO}_4 + 6\text{H}_2\text{O}$ ; coffin-lids and feathery stars (fig. 51).

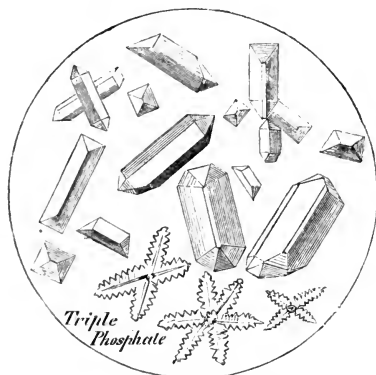

FIG. 51.—Triple phosphate crystals.



FIG. 52.—Crystals of phosphate of lime (stellar phosphate).

3. Crystalline phosphate of calcium,  $\text{CaHPO}_4$ , in rosettes of prisms, in spherules, or in dumb-bells (fig. 52).

4. Magnesium phosphate,  $\text{Mg}_3(\text{PO}_4)_2 + 2\text{H}_2\text{O}$ , occurs occasionally, and crystallises in long plates.

All these phosphates are dissolved by acids, such as acetic acid, without effervescence.

They do not dissolve on heating the urine; in fact, the amount of precipitate may be increased by heating.

A solution of ammonium carbonate (1-in-5) eats magnesium phosphate away from the edges; it has no effect on the triple phosphate. A phosphate of calcium ( $\text{CaHPO}_4 + 2\text{H}_2\text{O}$ ) may occasionally be deposited in acid urine. Pus in urine is apt to be mistaken for phosphates, but can be distinguished by the microscope.

**Deposit of calcium carbonate**,  $\text{CaCO}_3$ , appears but rarely as whitish balls or biscuit-shaped bodies. It is commoner in the urine of herbivora (see p. 154). It dissolves in acetic or hydrochloric acid, with effervescence.

The following is a summary of the chemical sediments that may occur in urine:—

### CHEMICAL SEDIMENTS IN URINE

#### IN ACID URINE

*Uric Acid*.—Whetstone, dumb-bell, or sheaf-like aggregations of crystals deeply tinged by pigment (fig. 46).

*Urates*.—Generally amorphous. The acid urate of sodium (fig. 47) and of ammonium (fig. 48) may sometimes occur in star-shaped clusters of needles or spheroidal clumps with projecting spines. Tinged brick-red. Soluble on warming.

*Calcium Oxalate*.—Octahedra, so-called envelope crystals (fig. 49). Insoluble in acetic acid.

*Cystin*.—Hexagonal plates (fig. 50). Rare.

*Leucine and Tyrosine*.—Rare.

*Calcium Phosphate*.

$\text{CaHPO}_4 + 2\text{H}_2\text{O}$ .—Rare.

#### IN ALKALINE URINE

*Phosphates*.—Calcium phosphate,  $\text{Ca}_3(\text{PO}_4)_2$ . Amorphous.

Triple phosphate,  $\text{MgNH}_4\text{PO}_4 + 6\text{H}_2\text{O}$ . Coffin-lids or feathery stars (figs. 45 and 51).

Calcium hydrogen phosphate,  $\text{CaHPO}_4$ . Rosettes, spherules, or dumb-bells (fig. 52).

Magnesium phosphate,  $\text{Mg}_3(\text{PO}_4)_2 + 2\text{H}_2\text{O}$ . Long plates.

All soluble in acetic acid without effervescence.

*Calcium Carbonate*,  $\text{CaCO}_3$ .—Biscuit-shaped crystals. Soluble in acetic acid with effervescence.

*Ammonium Urate*,  $\text{C}_5\text{H}_2(\text{NH}_4)_2\text{N}_4\text{O}_3$ .—'Thorn-apple' spherules.

*Leucine and Tyrosine*.—Very rare.

## LESSON XII

### *PATHOLOGICAL URINE*

1. **Urine A** is pathological urine containing albumin. It gives the usual protein tests. The following two are most frequently used in practice.

(a) Boil the top of a long column of urine in a test-tube. If the urine is acid, the albumin is coagulated. If the quantity of albumin is small, the cloudiness produced is readily seen, as the unboiled urine below it is clear. This is insoluble in a few drops of acetic acid, and so may be distinguished from phosphates. If the urine is alkaline, it should be first rendered acid with a little dilute acetic acid.

(b) *Heller's Nitric-Acid Test*.—Pour some of the urine gently on to the surface of some nitric acid in a test-tube. A ring of white precipitate occurs at the junction of the two liquids. This test is used for small quantities of albumin.

If the urine is cloudy, it should be filtered before applying these tests.

2. **Estimation of Albumin by Esbach's Albuminometer**.—Esbach's reagent for precipitating the albumin is made by dissolving 10 grammes of picric acid and 20 grammes of citric acid in 800 or 900 c.c. of boiling water, and then adding sufficient water to make up to a litre (1,000 c.c.).



FIG. 53.—Albuminometer of Esbach.

Pour the urine into the tube up to the mark U; then the reagent up to the mark R. Close the tube with a cork, and to ensure complete mixture tilt it to and fro a dozen times without shaking. Allow the corked tube to stand upright twenty-four hours; then read off on the scale the height of the precipitate. The figures indicate grammes of dried albumin in a litre of urine. The percentage is obtained by dividing by 10. Thus, if the sediment stands at 3, the amount of albumin is 3 grammes per litre, or 0.3 gr. in 100 c.c. If the sediment falls between any two figures, the distance  $\frac{1}{4}$ ,  $\frac{1}{2}$ , or  $\frac{3}{4}$  from the upper or lower figure can be read off with sufficient accuracy. Thus the surface of the sediment, being midway between 3 and 4, would be read as 3.5. When the albumin is so abundant that the sediment is above 4, a more accurate result is obtained by first diluting the urine with one or two volumes of water, and then multiplying the resulting figure by 2 or 3, as the case may be. If the amount of albumin is less than 0.05 per cent., it cannot be accurately estimated by this method.

3. **Urine B** is diabetic urine. It has a high specific gravity. The presence of sugar is shown by the reduction (yellow precipitate of cuprous oxide) that occurs on boiling with Fehling's solution. Fehling's solution is an alkaline solution of copper sulphate to which Rochelle salt has been added. The Rochelle salt (double tartrate of potash and soda) holds the cupric hydrate in

solution. Fehling's solution should always be freshly prepared, as, on standing, an isomeride is formed from the tartaric acid, and this substance itself reduces the cupric to cuprous oxide. Fehling's solution should, therefore, always be tested by boiling before it is used. If it remains unaltered by boiling, it is in good condition.

4. **Quantitative Determination of Sugar in Urine.**—Fehling's solution is prepared as follows:—34·639 grammes of copper sulphate are dissolved in about 200 c.c. of distilled water; 173 grammes of Rochelle salt are dissolved in 600 c.c. of a 14-per-cent. solution of caustic soda. The two solutions are mixed and diluted to a litre. Ten c.c. of this solution are equivalent to 0·05 gramme of dextrose. Dilute 10 c.c. of this solution with about 40 c.c. of water, and boil it in a white porcelain dish. Run into this from the burette (see fig. 54) the urine (which should be previously diluted with nine times its volume of distilled water) until the blue colour of the copper solution disappears—that is, till all the cupric hydrate is reduced. The mixture in the basin should be boiled after every addition.<sup>1</sup> The quantity of diluted urine used from the burette contains 0·05 gramme of sugar. Calculate the percentage from this, remembering that the urine has been diluted to ten times its original volume.

*Example.*—Suppose that 20 c.c. of the diluted urine are found necessary to reduce the 10 c.c. of Fehling's solution. This will be equivalent to 2 c.c. of the undiluted urine; 2 c.c. of the original urine will therefore contain 0·05 gramme of sugar; 1 c.c. will contain  $\frac{0\cdot05}{2}$  and 100 c.c. will contain  $\frac{0\cdot05}{2} \times 100 = 2\cdot5$  grammes of sugar.

Pavy's modification of Fehling's solution is sometimes used. Here ammonia holds the cuprous oxide in solution, so that no precipitate forms on boiling Pavy's solution with a reducing sugar. The reduction is complete when the blue colour disappears: 10 c.c. of Pavy's solution = 1 c.c. of Fehling's solution = 0·005 gramme of dextrose.

In some cases of diabetic urine where there is excess of ammonio-magnesium phosphate, the full reduction is not obtained with Fehling's solution, and when the quantity of sugar is small it may be missed. In such a case excess of soda or potash should be first added; the precipitated phosphates filtered off; and the filtrate, after it has been well boiled, may then be titrated with Fehling's or Pavy's solution.

5. **Picric Acid Test.**—The work of Sir George Johnson and G. S. Johnson has shown the value of this reagent in detecting both albumin and sugar in the urine. The same reagent may be employed for the detection of both substances. The method of testing for albumin has been already studied with Esbach's tubes. To test for sugar perform the following experiment. Take a drachm (about 4 c.c.) of diabetic urine; add to it an equal volume of saturated aqueous solution of picric acid, and half the volume (*i.e.* 2 c.c.) of the liquor potassæ of the British Pharmacopœia. Boil the mixture for about a minute, and it becomes so intensely dark red as to be opaque. Now do the same experiment with normal urine. An orange-red colour appears even in the cold, and is deepened by boiling, but it never becomes opaque,

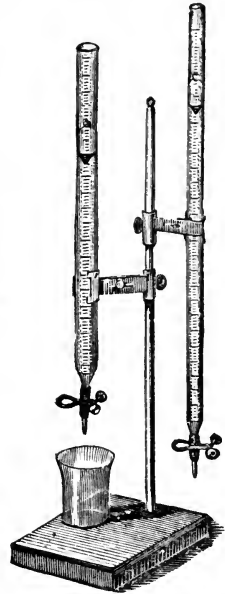

FIG. 54.—Two burettes on stand. (Sutton.)

<sup>1</sup> On cooling the blue colour reappears, owing to re-oxidation.

and so the urine for clinical purposes may be considered free from sugar. This reduction of picric acid by normal urine is due to creatinine.

6. **Test for Acetone.**—Acetone is often found in diabetic urine. Add to the urine a dilute solution of sodium nitro-prusside and a little 20-per-cent. caustic potash. A red colour is produced. Acidify with strong acetic acid. The colour disappears at once in the absence of acetone, but remains or is intensified in its presence.

The full significance and causes of pathological urine cannot be appreciated until a theoretical and practical acquaintance with disease is obtained, and we shall briefly consider only those abnormal constituents which are most frequently met with.

### PROTEINS IN THE URINE

There is no protein matter in normal urine, and the most common cause of the appearance of albumin in the urine is disease of the kidney (Bright's disease). The best methods of testing for and estimating the albumin are given in the practical heading to this lesson. The term 'albumin' is the one used by clinical observers. Properly speaking, it is a mixture of serum albumin and serum globulin.

A condition called 'peptonuria,' or peptone in the urine, is observed in certain pathological states, especially in diseases where there is a formation of pus, and particularly if the pus is decomposing owing to the action of a bacterial growth called staphylococcus; one of the products of disintegration of pus cells appears to be peptone; and this leaves the body by the urine. The term 'peptone,' however, is in the strict sense incorrect; the protein present is deutero-proteose. In the disease called 'osteomalacia' a proteose is usually found in the urine, which more nearly resembles hetero-proteose in its characters.

### SUGAR IN THE URINE

Normal urine contains no sugar, or so little that for clinical purposes it may be considered absent. It occurs in the disease called diabetes mellitus, which can be artificially produced by the methods described on pp. 87, 88.

The methods usually adopted for detecting and estimating the sugar are given at the head of this lesson. The sugar present is dextrose. Lactose may occur in the urine of nursing mothers. Diabetic urine also contains hydroxybutyric acid, and may contain or yield on distillation acetone and ethyl-diacetic acid.

Fehling's test is not absolutely trustworthy. Often a normal urine will decolorise Fehling's solution, though seldom a red precipitate is formed. This is due to excess of urates and creatinine. Another substance, called

glycuronic acid ( $C_6H_{10}O_7$ ) is, however, very likely to be confused with sugar by Fehling's test; the cause of its appearance is sometimes the administration of drugs (chloral, camphor, &c.); but sometimes it appears independently of drug treatment (see p. 88).

Then, too, in the rare condition called alcaptonuria, confusion may similarly arise. Alcapton is a substance which probably originates from tyrosine by an unusual form of metabolism. It gives the urine a brown tint, which darkens on exposure to the air. It is an aromatic substance, and the researches of Baumann and Wolkow have identified it with homogentisinic acid [ $C_6H_3(OH)_2CH_2COOH$ ].

The best confirmatory tests for sugar are the *phenyl-hydrazine test* (see Lesson XIII.), and the *fermentation test* (Lesson II.).

Sir W. Roberts introduced a method for estimating sugar in urine, by the diminution in specific gravity which it undergoes on fermentation with yeast. Every degree lost in the specific gravity corresponds to one grain of sugar per fluid ounce. Suppose that the specific gravity of the unfermented urine is 1040, and that of the urine which has undergone fermentation is 1030: the number of degrees lost is ten; *i.e.* the urine contained 10 grains of sugar per ounce. The percentage of sugar may be ascertained by multiplying the degrees of specific gravity lost by 0.22; thus the percentage in the example just given will be  $0.22 \times 10 = 2.2$ . The method, however, is rough and has dropped out of use.

### BILE IN THE URINE

This occurs in jaundice. The urine is dark-brown, greenish, or in extreme cases almost black in colour. The most readily applied test is Gmelin's test for the bile pigments. Pettenkofer's test for the bile acids seldom succeeds in urine if the test is done in the ordinary way. The best method is to warm a thin film of urine and cane-sugar solution in a flat porcelain dish. Then dip a glass rod in strong sulphuric acid, and draw it across the film. Its track is marked by a purplish line. Hay's sulphur test (p. 79) is very trustworthy. Excess of urobilin should not be mistaken for bile pigment.

### BLOOD AND BLOOD PIGMENT IN THE URINE

When hæmorrhage occurs in any part of the urinary tract, blood appears in the urine. It is found in the acute stage of Bright's disease. If a large quantity is present, the urine is deep red. Microscopic examination then reveals the presence of blood corpuscles, and on spectroscopic examination the bands of oxyhæmoglobin are seen.

If only a small quantity of blood is present, the secretion—especially if acid—has a characteristic reddish-brown colour, which physicians term 'smoky.'

The blood pigment may, under certain circumstances, appear in

the urine without the presence of any blood corpuscles at all. This is produced by a disintegration of the corpuscles occurring in the circulation. The condition so produced is called *hæmoglobinuria*, and it occurs in several pathological states, as, for instance, in the tropical disease known as 'Black-water fever.' The pigment is in the condition of methæmoglobin mixed with more or less oxyhæmoglobin, and the spectroscope is the means used for identifying these substances (see p. 119).

### PUS IN THE URINE

**Pus** occurs in the urine as the result of suppuration in any part of the urinary tract. It forms a white sediment resembling that of phosphates, and, indeed, is always mixed with phosphates. The pus corpuscles may, however, be seen with the microscope; their nuclei are rendered evident by treatment with 1-per-cent. acetic acid, and the pus corpuscles are seen to resemble white blood corpuscles, which, in fact, they are in origin. Some of the protein constituents of the pus cells—and the same is true for blood—pass into solution, so that the urine pipetted off from the surface of the deposit gives the tests for albumin. On the addition of liquor potassæ to the deposit of pus cells a ropy gelatinous mass is obtained. This is distinctive. Mucus treated in the same way is dissolved.



## DETECTION OF PHYSIOLOGICAL PROXIMATE PRINCIPLES

Subsequent lessons may be very usefully employed by the class in testing for the various substances the properties of which have been previously studied. The following scheme will form a rough guide to the tests to be employed for the most important of the proximate principles:—

1. Note reaction, colour, clearness or opalescence, taste, smell. Coloured liquids suggest blood, bile, urine, &c. Opalescent liquids suggest starch, glycogen, or certain proteins.

2. Add iodine. A colour is produced:

If blue: **Starch**. Confirm by converting into a reducing sugar by saliva at 40° C., or by boiling with dilute sulphuric acid.

If reddish brown: **Glycogen** or **dextrin**. Glycogen forms an opalescent solution in water, and is readily precipitated by alcohol. It is precipitated by basic lead acetate. Dextrin forms a clear solution: it is not precipitated by basic lead acetate unless ammonia is added also. It is not precipitated by alcohol unless a large excess is added. Both dextrin and glycogen are, like starch, convertible into a reducing sugar.

3. Add copper sulphate and caustic potash.

(a) Blue solution: boil; yellow or red precipitate. **Dextrose, levulose, maltose, lactose**, and other reducing sugars (for distinguishing tests see Lesson XIII.).

(b) Blue solution: no reduction on boiling; boil some of the original solution with 25-per-cent. sulphuric acid, and then boil with copper sulphate and caustic potash; abundant yellow or red precipitate: **Cane sugar**. Confirm by HCl test (see p. 13).

(c) Violet solution: **Proteins** (albumins, globulins, infra-proteins). In presence of magnesium sulphate the potash causes also a white precipitate of magnesia.

(d) Pink solution; biuret reaction. **Peptones** or **proteoses**. In presence of ammonium sulphate very large excess of potash is necessary for this test. Only a trace of copper sulphate must be used.

4. When proteins are present proceed as follows: Boil the original solution (after adding a trace of 2-per-cent. acetic acid).

(a) Precipitate produced: **Albumins** or **globulins**.

(b) No precipitate: **Infra-proteins**,<sup>1</sup> **proteoses**, or **peptones**.

5. If albumin, or globulin, or both are present, saturate a fresh portion with magnesium sulphate or half saturate with ammonium sulphate; filter; the precipitate contains the **globulin**, the filtrate the **albumin**. Test temperature of heat coagulation.

<sup>1</sup> The infra-proteins (see pp. 47 and 75) are by some called 'meta-proteins.'

6. If proteins are present, but albumin or globulin absent :

(a) Neutralisation causes a precipitate soluble in excess of weak acid or alkali. **Acid albumin** or **alkali albumin**, according as the reaction of the original liquid is acid or alkaline respectively. If the original liquid is neutral, acid albumin and alkali albumin must be both absent.

(b) Neutralisation produces no such precipitate : **Proteose** or **peptone**.

7. If proteose, or peptone, or both are present, saturate a fresh portion with ammonium sulphate :

(a) Precipitate : **Proteose**. (b) No precipitate : **Peptone**.

If both are present, the precipitate contains the proteose, and the filtrate the peptone.

8. To a fresh portion add nitric acid (proteins having been proved to be present).

(a) No precipitate, even though excess of sodium chloride be also added : **Peptone**.

(b) No precipitate, until excess of sodium chloride is added : **Deutero-proteose**.

(c) Precipitate which disappears on heating and reappears on cooling : **Proteoses**. This is the distinctive test of all the proteoses or albumoses, and is given by all of them. For one of them, however (deutero-proteose), excess of sodium chloride must be added also.

(d) Precipitate little altered by heating : **Albumin** or **globulin**.

In all four cases nitric acid *plus* heat causes a yellow colour, turned orange by ammonia (xantho-proteic reaction).

9. Confirmatory tests for proteins :—

(a) Millon's test (see p. 27).

(b) Adamkiewicz's reaction (see p. 27).

(c) Ferrocyanide of potassium and acetic acid cause a precipitate (except in the case of peptones and some proteoses).

(d) To test for fibrinogen :—

i. It coagulates by heat at 56° C.

ii. It is changed into fibrin by fibrin ferment and calcium chloride.

(e) To test for caseinogen :—

i. It is not coagulated by heat.

ii. It is changed into casein by rennet and calcium chloride.

10. If **blood** is suspected :

(a) Examine spectroscopically, diluting if necessary.

i. Oxyhæmoglobin shows two bands between D and E.

ii. Add ammonium sulphide ; one band only appears.

iii. Carbonic oxide hæmoglobin shows two bands also, but will not reduce with ammonium sulphide.

iv. Methæmoglobin gives a typical band in the red between C and D.

v. Hæmatin, &c., show special spectra (see Advanced Course, Lesson XIX.).

(b) Dry : boil with glacial acetic acid and a crystal of sodium chloride on a glass slide under a cover glass. When cold, hæmin crystals are seen.

(c) If the blood is old and dry, and its hæmoglobin converted into hæmatin:

i. Try hæmin test.

ii. Dissolve it in potash; add ammonium sulphide, and examine for spectrum of hæmochromogen.

11. If bile is suspected:

(a) Try Gmelin's test for bile pigments (see p. 79).

(b) Try Pettenkofer's test for bile salts (see p. 79).

(c) Try Hay's sulphur test (see p. 79).

12. Miscellaneous substances.

(a) **Mucin.** Precipitated by acetic acid or by alcohol. The precipitate is soluble in lime water. By collecting the precipitate and boiling it with 25-per-cent. sulphuric acid, a reducing sugar-like substance is obtained. Mucin gives the protein colour tests.

(b) **Nucleo-protein.**—Precipitated by acetic acid or by alcohol. The precipitate is often viscous. It is soluble in dilute alkalis such as 1-per-cent. sodium carbonate. This solution causes intravascular clotting. If the precipitate is collected and subjected to gastric digestion, an insoluble deposit of nuclein is left, which is rich in phosphorus. Nucleo-protein gives the protein colour tests.

(c) **Gelatin.** This also gives some of the proteid colour tests, but not those of Millon or Adamkiewicz. It is not coagulated, but dissolved in hot water. The solution gelatinises when cold.

(d) **Urea.** Very soluble in water. The solution effervesces when sodium hypobromite or fuming nitric acid is added. Concentrate a fresh portion, add nitric acid, and examine for crystals of urea nitrate. Solid urea heated in a dry test-tube gives off ammonia, and the residue is called biuret. This gives a rose-red colour with copper sulphate and caustic potash.

(e) **Uric acid.** Very insoluble in water; soluble in potash, and precipitated from this solution in crystals by hydrochloric acid. Uric acid crystals from human urine are deeply pigmented red. Try murexide test (see p. 156).

(f) **Cholesterin.** Characteristic flat crystalline plates. For various colour tests see p. 79.

13. **Urine.** Normal constituents

(a) Chlorides. Acidulate with nitric acid; add silver nitrate; white precipitate.

(b) Sulphates. Acidulate with nitric or hydrochloric acid: add barium chloride; white precipitate.

(c) Phosphates. Acidulate with nitric acid; add ammonium molybdate; boil; and a yellow crystalline precipitate forms. To another portion add ammonia; earthy (*i.e.* calcium and magnesium) phosphates are precipitated.

(d) Urea (see above).

(e) Uric acid. To 100 c.c. of urine add 5 c.c. of hydrochloric acid; leave for twenty-four hours, and pigmented crystals of uric acid are formed. For tests see above.

(f) Hippuric acid. Evaporate the urine with nitric acid, and heat the residue in a dry test-tube. A smell of oil of bitter almonds is given off.

(g) Creatinine. Take 100 c.c. of urine : add 5 c.c. of a saturated solution of sodium acetate and 20 c.c. of a saturated solution of mercuric chloride. Filter. Set the filtrate aside for twenty-four hours, and a spherical mercury compound of creatinine crystallises out. Examine this with a microscope.

For colour test with sodium nitro-prusside see p. 142.

14. **Urine.** Abnormal constituents.

(a) *Blood.* Microscope (blood corpuscles). Spectroscope (for oxyhæmoglobin or methæmoglobin). Hæmin test.

(b) *Blood pigment* may be present without blood corpuscles. Spectroscope.

(c) *Bile.* Gmelin's test. Hay's sulphur test.

(d) *Pus.* White deposit. Microscope (pus cells). Add potash ; it becomes stringy.

(e) *Albumin.* (i.) Precipitated, if acid, by boiling ; precipitate insoluble in acetic acid, so distinguishing it from phosphates. (ii.) Precipitated by nitric acid in the cold. (iii.) Precipitated by picric acid.

(f) *Sugar.* (i.) Brown colour with potash and heat (Moore's test). (ii.) Ferments with yeast. (iii.) Reduces Fehling's solution. (iv.) Urine has a high specific gravity. (v.) Add picric acid, potash, and boil ; the urine becomes a dark opaque red ; the similar slight coloration in normal urine is due to creatinine.

(g) *Acetone.* For colour test see p. 168.

(h) *Mucus.* Flocculent cloud ; may be increased by acetic acid ; soluble in alkalis. A little mucus in urine is not abnormal.

(i) *Deposits.*

i. Examine microscopically for blood corpuscles, pus cells, crystals, &c.

ii. Phosphates. White deposit often mixed with mucus or pus. Insoluble on heating ; soluble in acetic acid. Urine generally alkaline. Examine microscopically for coffin-lids of triple phosphate and star-like clusters of stellar (calcium) phosphate.

iii. Urates. Pink deposit, usually amorphous ; may be mixed with envelope crystals of calcium oxalate. Deposit soluble on heating urine. Murexide test.

iv. Uric acid. Deposit like cayenne pepper. Microscope. Tests as above.

# ADVANCED COURSE

## INTRODUCTION

It will be presupposed that students who take the following lessons have already been through the elementary course. The order in which the subjects are treated is the same as that already adopted. The instructions given will be mainly practical; theoretical matter on which they depend, or to which they lead, is, as a rule, too lengthy to be discussed in a short manual like the present volume. The Appendix contains a description of various instruments which are not generally contained in sufficient numbers in a physiological laboratory to admit of each student being able to use them in a class. It also contains a description of certain methods of research which should always be shown in demonstrations, though there may be practical difficulties in allowing each member of the class to perform the experiments. The few experiments in which living animals are employed will also necessarily be of the nature of demonstrations.

## LESSON XIII

### CARBOHYDRATES

1. **Glycogen.**—A rabbit which has been fed five or six hours previously on carrots is killed by bleeding. The chest and abdomen are opened quickly and a cannula inserted into the portal vein, and another into the vena cava inferior. A stream of salt solution is then allowed to pass through the liver until it is uniformly pale. The washings are collected in three beakers labelled *a*, *b*, and *c*.

The liver is cut out quickly, chopped into small pieces, and thrown into

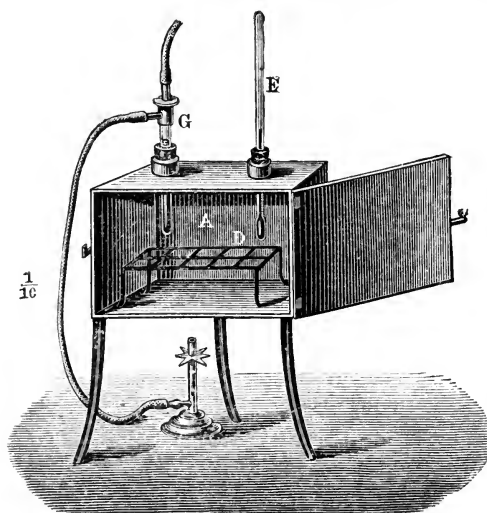

FIG. 55.—Hot-air oven with gas regulator (g). (Gscheidlen.)

boiling water acidulated with acetic acid. The acidulated water extracts a small quantity of glycogen. The pieces of scalded liver are then ground up in a mortar with hot water, and thoroughly extracted with boiling water. Filter. A strong solution of glycogen is thus obtained.

Test the solution when cold with iodine.

To separate the glycogen evaporate the solution to a small bulk on the water-bath and then add excess of alcohol; the glycogen is precipitated as a flocculent powder,

which is collected on a filter and dried in an oven at the temperature of 100° (see fig. 55).

If the experiment is to be a quantitative one, the piece of liver taken and the glycogen obtained must be weighed.<sup>1</sup>

2. Examine the washings of the liver in the beakers *a*, *b*, and *c* for sugar. This may be done in a rough quantitative manner as follows:—Take equal

<sup>1</sup> This method of preparation of glycogen has the advantage that only traces of protein are mixed with it. In Kùlz's method (extraction with dilute potash) there is more protein. This is precipitated by the alternate addition of hydrochloric acid and potassio-mercuric iodide. Pavy and also Pflüger recommend extraction with strong potash, and subsequent precipitation with a certain percentage of alcohol; this method extracts all the glycogen easily.

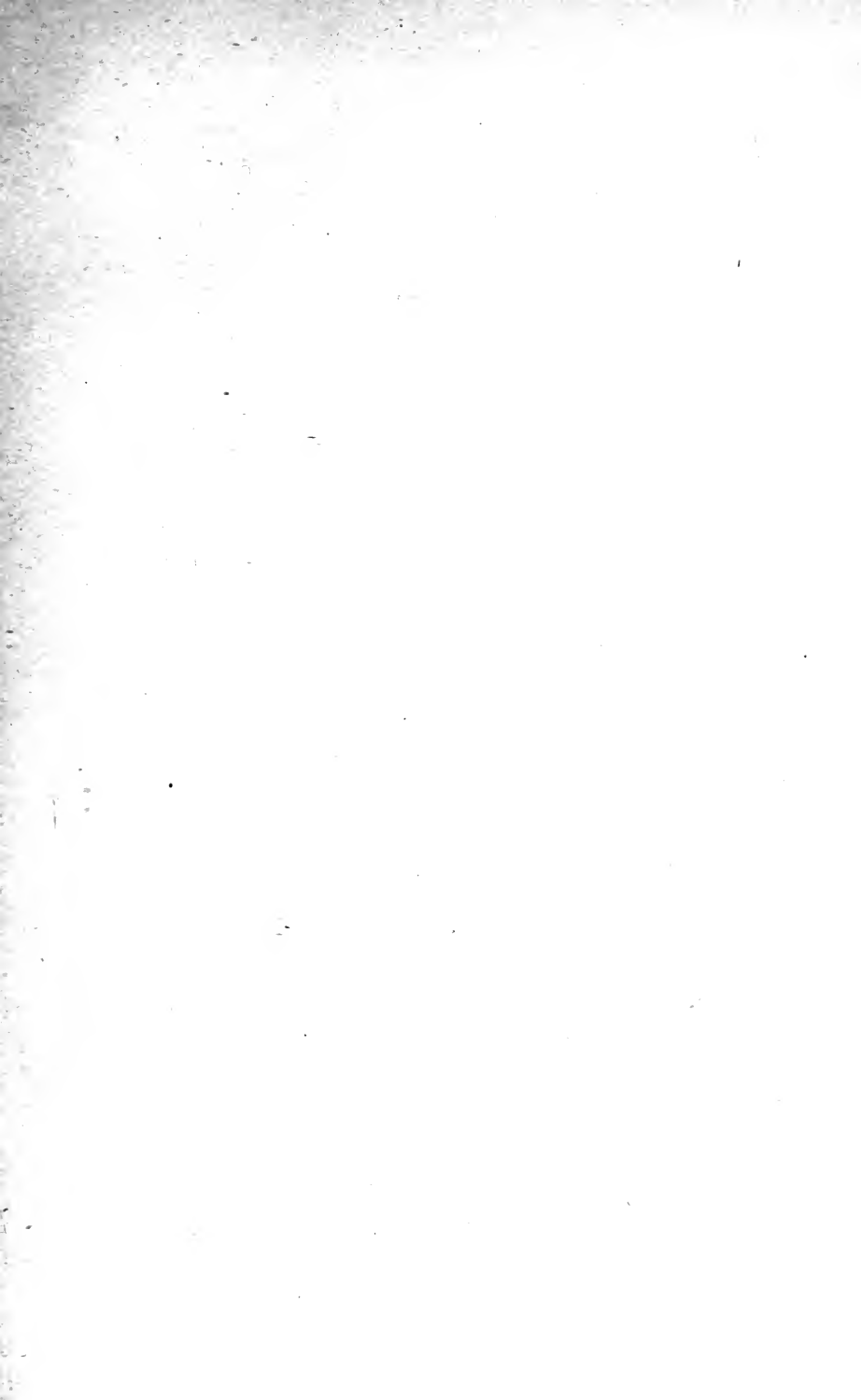

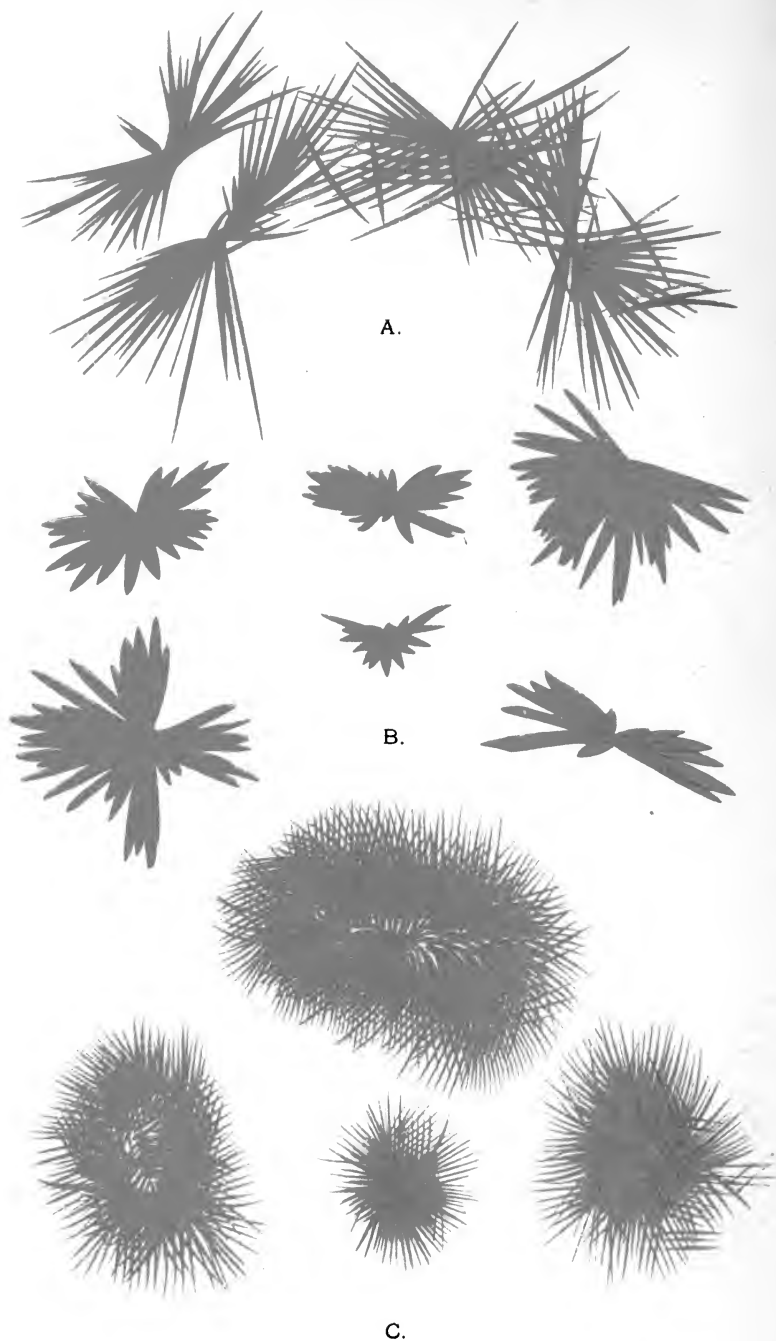

Fig. 56.—Plate of osazone crystals highly magnified.

*A*, phenyl-glucosazone. *B*, phenyl-maltosazone. *C*, phenyl-lactosazone.



quantities of *a*, *b*, and *c* in three test-tubes; to each add an equal amount of Fehling's solution, and boil: *a* will give a heavy precipitate of cuprous oxide, *b* one not so heavy, and *c* least of all, or none at all.

3. **Micro-chemical detection of Glycogen.**—A thin piece of the same liver is hardened in 90 per cent. alcohol. Sections are cut by the free hand, or after embedding in paraffin. If paraffin is used, this is got rid of by means of turpentine; and the sections prepared by either method are treated with chloroform in which iodine is dissolved, and mounted in chloroform balsam containing some iodine. The glycogen is stained brown, and is most abundant in the cells around the radicals of the hepatic vein.

4. **Phenyl-Hydrazine Test for Sugars.**—To 5 c.c. of the suspected fluid (*e.g.* diabetic urine) add 1 decigramme of phenyl-hydrazine hydrochloride, 2 decigrammes of sodium-acetate, and heat on the water-bath at 100° C. for 30 to 60 minutes. On cooling, if not before, a crystalline or amorphous precipitate separates out. If amorphous, dissolve it in hot alcohol; dilute the solution with water, and boil to expel the alcohol, whereupon the osazone separates out in yellow crystals. Examine the crystals with the microscope (see accompanying plate).

*Dextrose* gives a precipitate of phenyl-glucosazone  $C_6H_{10}O_4(N_2H.C_6H_5)_2$ , which crystallises in yellow needles (melting-point 205° C.).

*Levulose* yields an osazone identical with this.

*Galactose* yields a very similar osazone (phenyl-galactosazone). It differs from phenyl-glucosazone by melting at 190–193°, and in being optically inactive when dissolved in glacial acetic acid.

*Cane sugar* does not form a compound with phenyl-hydrazine.

*Lactose* yields phenyl-lactosazone  $C_{12}H_{20}O_9(N_2H.C_6H_5)_2$ . It crystallises in needles, usually in clusters (melting-point 200° C.). It is soluble in 80–90 parts of boiling water. Lactose in urine does not give this test readily.

*Maltose* yields phenyl-maltosazone ( $C_{24}H_{32}N_4O_{10}$ ). It crystallises in yellow needles much wider than those yielded by glucose or lactose (melting-point 206° C.). Unlike phenyl-glucosazone, it dissolves in 75 parts of boiling water, and is still more soluble in hot alcohol.

The chemistry of the phenyl-hydrazine reaction is represented in the following equations, dextrose being taken as an example of the sugar used:

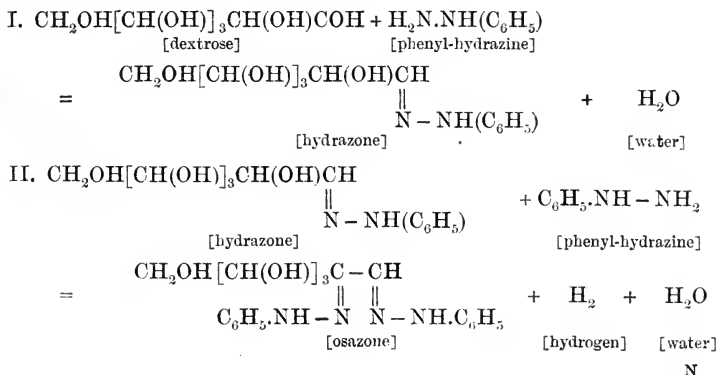

5. **Barfoed's Reagent.**—Dissolve 1 part of cupric acetate in 15 parts of water; to 200 c.c. of this solution add 5 c.c. of acetic acid containing 38 per cent. of glacial acetic acid. Dextrose reduces this reagent on boiling; maltose and lactose do not. This test is not very delicate, and the reagent must be freshly prepared.

6. **The Polarimeter.**—Estimate the strength of a solution of dextrose by means of the polarimeter (see Appendix).

7. **Formation of Mucic Acid.**—Take 1 gramme of lactose and heat it in a porcelain capsule with 12 c.c. of nitric acid on a water-bath until the fluid is reduced to one-third of its original volume. A precipitate of mucic acid separates out. Cane sugar, maltose, dextrose, dextrin, and starch treated in the same way, yield an isomeric acid called saccharic acid, which, being soluble, does not separate out. Lactose yields both acids; galactose mucic acid only.

8. **Pentoses** give the ordinary reduction tests for sugar and yield osazones, but do not ferment with yeast. They give the two following characteristic tests; they may be performed with gum arabic (which contains arabinose) or pine-wood shavings (which contain xylose).

(a) **Phloroglucin reaction.** Warm some distilled water with an equal volume of concentrated hydrochloric acid in a test-tube and add phloroglucin until a little remains undissolved. Add a small quantity of gum arabic, and keep the mixture warm in the water-bath at 100° C. The solution becomes cherry-red, and a precipitate settles out, which is soluble in amyl alcohol. This solution gives an absorption band between the D and E lines.

(b) **Orcin reaction.** Substitute orcin for phloroglucin in the foregoing experiment. The solution becomes violet on warming, then blue, red, and finally green. A bluish green precipitate settles out, soluble in amyl alcohol. This solution gives an absorption band between C and D.

9. **Glycuronic acid** gives all the above reactions; it may be distinguished as follows:—

Take 50 c.c. of glycuronic acid solution in a capsule; add 1 gramme of *p*-bromphenyl-hydrazine and rather more than the same amount of sodium acetate. Keep the mixture in the water-bath at 100° C. for a quarter of an hour, when yellow crystals of *p*-bromphenyl-hydrazone separate out. After cooling filter off the crystals and wash them with absolute alcohol, in which they are insoluble. Under the same conditions carbohydrates yield *p*-bromphenyl-osazones, but these are soluble in absolute alcohol. The *p*-bromphenyl-hydrazone is soluble in absolute alcohol to which pyridine has been added; the rotatory power of this solution is greater than that of any of the osazones.

## LESSON XIV

### CARBOHYDRATES: ACTION OF MALT UPON STARCH

1. Prepare a 0·5-per-cent. solution of starch.

2. Prepare some malt extract by digesting 10 grammes of powdered malt with 50 c.c. of water at 50° C. for three hours, and subsequently straining. This extract contains the diastatic or malting ferment.

Solutions 1 and 2 may be conveniently prepared beforehand by the demonstrator.

3. To the starch solution add one-tenth of its volume of malt extract, and place the mixture in a water-bath at 40° C. From time to time test portions of the liquid by mixing a drop with a drop of iodine solution on a testing slab. The blue colour at first seen is soon replaced by a violet (mixture of blue and red), and then by a red reaction (due to *erythro-dextrin*), which gradually vanishes. Alcohol added to the liquid when all starch and erythro-dextrin have gone still causes a precipitate of a dextrin, which, as it gives no colour with iodine, is called *achroö-dextrin*. The liquid also contains a reducing sugar, maltose.

4. Take 50 c.c. of a solution of maltose and determine how much of it is necessary to reduce 10 c.c. of Fehling's solution.

5. Take another 50 c.c. and boil it with 1 c.c. of strong sulphuric acid for half an hour in a flask. This converts it into dextrose. After cooling bring the liquid to its original volume (50 c.c.) by adding water, and again determine its increased reducing power with Fehling's solution. If  $x = \text{c.c. of maltose solution necessary to reduce 10 c.c. of Fehling's solution}$ , then  $\frac{2x}{3} = \text{c.c. of dextrose solution necessary for the same purpose}$ . The strength of the maltose solution can be calculated from the fact that 10 c.c. of Fehling's solution correspond to 0·05 gramme of dextrose.

## LESSON XV

### *CRYSTALLISATION OF EGG ALBUMIN*

Fresh egg-white is mixed with an equal bulk of fully saturated, filtered neutral ammonium sulphate solution. 100 c.c. of the former are measured into a porcelain basin or strong beaker, and 100 c.c. of ammonium sulphate solution are added in successive quantities of 10 or 15 c.c., the mixture being thoroughly churned with an egg whisk after each addition. The whole should be finally so thoroughly beaten up as to form a large proportion of light froth. After the greater part of the froth has broken down, the mixture is thrown on a folded filter-paper, moderately rapid filtration being obtained without the use of a filter-pump. The filtrate is strongly alkaline to litmus, and smells of ammonia. To the filtrate in a flask, or to as much of it as can be obtained in a convenient time of filtration, further ammonium sulphate solution is very cautiously added (best, drop by drop from a burette) until a slight permanent precipitate remains, and this precipitate is afterwards just redissolved by the equally cautious addition of water. Dilute acetic acid (10 per cent.) from a burette is now added drop by drop until such a stage of reaction is reached that a precipitate forms and only just redissolves. Finally one or two drops (not more) of acid are added in excess of this, whereupon a bulky white precipitate falls. The flask is now corked and allowed to stand. In 24 hours or less the precipitate, which will have increased in quantity, will be found to consist entirely of acicular crystals. Small portions should be examined under a 4th objective, avoiding pressure on the cover slip. (F. G. Hopkins.)

## LESSON XVI

### MILK

1. Caseinogen in milk exists in the form of a salt (calcium caseinogenate). Add acetic acid to milk, and this salt is decomposed, and free caseinogen (with entangled fat) is precipitated. Collect the precipitate so produced from a pint of milk on a filter, and wash thoroughly with distilled water: grind it up with calcium carbonate in a mortar, and add about a pint of distilled water; allow the mixture to stand for about an hour. The fat rises to the top: the excess of calcium carbonate falls to the bottom. The intermediate fluid contains the caseinogen in solution; it is usually very opalescent. Take some of this solution and divide it into three parts, A, B, and C.

To A add rennet.

To B add a few drops of 2-per-cent. solution of calcium chloride.

To C add both rennet and calcium chloride.

Put all three in the water-bath at  $40^{\circ}$  C. A clot of casein forms in C, but not in A if all calcium salts have been successfully washed away, nor in B.

2. The formation of casein from caseinogen is a double process; the first action is that of the ferment, which converts the caseinogen into what may be called soluble casein; the second action is that of the calcium salt, which precipitates the casein in an insoluble form, or curd. This may be shown by taking some of the caseinogen solution and adding rennet. Warm to  $40^{\circ}$  C.; no visible change occurs, but nevertheless soluble casein and not caseinogen is now present. Then boil this mixture to destroy the rennet, cool, and add calcium chloride. A formation of insoluble curd now occurs.

3. Caseinogen may be precipitated as a salt from milk by the addition of alcohol. This reagent also precipitates the other milk proteins.

4. The method of salting out described in Lesson VI., Exercise 10 (p. 41), may also be used. Add to some milk an equal volume of saturated solution of ammonium sulphate. Caseinogen as a salt is thus precipitated, and entangles the fat with it. Filter off the precipitate and examine the filtrate as follows:—Saturate it with sodium chloride; a small amount of precipitate comes down. This is the so-called lacto-globulin. This contains only a trace of true globulin; it is mostly caseinogen previously left in solution together with calcium sulphate. Filter it off; acidify the filtrate with a few drops of 2-per-cent. acetic acid and heat it in a water-bath gradually. About  $77^{\circ}$  C. the remaining protein (lactalbunin) is coagulated.

## LESSON XVII

### THE PROTEOSES

1. Witte's peptone contains very little true peptone, but consists chiefly of proteoses, which are soluble like peptone, in neutral saline solutions.

2. Make a solution of this substance in 10-per-cent. sodium chloride solution, and filter. Very little residue is left on the filter. This consists of dysalbumose, an insoluble form of hetero-albumose, formed during the process of preparing the substance. If hot saline solution is used instead of cold as a solvent, this amount of insoluble residue is increased, hetero-albumose being to a slight extent precipitated by heat.

3. The solution gives the following tests:—

(a) It does not coagulate on heating.

(b) Biuret reaction (due both to peptone and proteoses).

(c) A drop of nitric acid, best added by a glass rod, gives a precipitate which dissolves upon heating and reappears on cooling. (This is due to the proteoses present.)

(d) The precipitate produced by the addition of acetic acid and a drop of potassium ferrocyanide is also soluble on heating, and reappears on cooling.

4. For the separation of the proteoses and peptone proceed as follows:—

(a) Saturate the solution with ammonium sulphate, and filter. The filtrate contains the peptone, and the precipitate the proteoses. The peptone is not precipitated by nitric acid, nor by most of the reagents that precipitate other proteins. It is precipitated completely by alcohol, tannin, and potassium-mercuric iodide; imperfectly by phospho-tungstic and phospho-molybdic acid.

It gives the biuret reaction, *but in the presence of ammonium sulphate a large excess of caustic potash is necessary.*

(b) Dialyse another portion of the solution; hetero-proteose is precipitated.

(c) Saturate another portion of the solution with sodium chloride (or half saturate with ammonium sulphate) after faintly acidulating with acetic acid. Proto-proteose and hetero-proteose are precipitated. Filter. The filtrate contains the deuterio-proteose and peptone.

The proto- and hetero-proteose may be redissolved by adding distilled water, and may be separated from each other by dialysis (see *b*).

Deuterio-proteose may be separated from the peptone by saturation with ammonium sulphate, or by the addition of a crystal of phosphoric acid. These reagents precipitate the deuterio-proteose, but not the peptone.

Deuterio-proteose gives the nitric acid reaction (see 3, *c*) characteristic of the proteoses only in the presence of excess of salt. If the salt is removed by dialysis, nitric acid then causes no precipitate.

5. Among the important reactions of proteins is Rose's or Piotrowski's reaction—that is, the coloration produced by copper sulphate and a caustic alkali; the term 'biuret reaction' is applied to the rose-red colour which proteoses and peptones give with these reagents, because biuret (a derivative of urea) gives a similar colour (see p. 39). Gnezda found that if a dilute solution of nickel sulphate is used instead of copper sulphate, the native proteins give different colours from the peptones and proteoses, and Pickering has found the same with cobalt. Their results may be given in the following table:—

Protein	Copper sulphate and ammonia	Copper sulphate and potash	Nickel sulphate and ammonia	Nickel sulphate and potash	Cobalt sulphate and ammonia	Cobalt sulphate and potash
Albumins and globulins }	Blue	Violet	Nil	Yellow	Nil	Heliotrope-purple
Proteoses and peptones }	Rose-red	Rose-red	Yellow	Orange	Nil	Red brown

6. Another delicate test introduced by McWilliam may here be mentioned. Salicyl-sulphonic acid precipitates albumins and globulins: on heating, the precipitate is coagulated. The same reagent precipitates proteoses. On heating, the precipitate dissolves and reappears on cooling. It does not precipitate peptones.

7. The use of trichloroacetic acid for the separation of various proteins may be illustrated by the following experiment. Take some blood and add to it some solution of Witte's peptone (*i.e.* proteoses and peptone). Add to this mixture an equal volume of a 10-per-cent. solution of trichloroacetic acid. There is an abundant precipitate. Boil rapidly and filter hot. The filtrate contains the proteoses and peptone, all the other proteins being contained in the precipitate. On cooling, the filtrate deposits some of the proteose. The proteose and peptone may be detected in the usual way.

## LESSON XVIII

### DIGESTION

1. **Activity of Pepsin Solutions (Grützner's Method).**—Examine the comparative digestive power of the glycerin extracts of two stomachs. Take, in two test-tubes, an equal small weighed quantity of fibrin stained with carmine. Add to each 10 c.c. of 0·2-per-cent. hydrochloric acid. Add to one a measured quantity of one glycerin extract, and to the other an equal quantity of the other glycerin extract. As the fibrin is digested the carmine is set free, and colours the liquid; that which is more deeply stained is that which contains the more active preparation of pepsin. In the original method the amount of carmine set free is estimated by an artificial scale consisting of ten solutions of carmine of different known strengths.

The carmine solution for staining the fibrin is prepared by dissolving 1 gramme of carmine in about 1 c.c. of ammonia; to this 400 c.c. of water are added, and the mixture is kept in a loosely stoppered bottle till the smell of ammonia has become faint.

The fibrin is stained by taking it perfectly fresh and clean. It is chopped finely and placed in the carmine solution for twenty-four hours. The fluid is strained off and the fibrin washed in water till the washings are colourless. It is kept in a stoppered bottle with just enough ether to cover it.

2. **Mett's Tubes.**—A method which is now more generally employed for estimating the proteolytic activity of a digestive juice is one originally introduced by Mett. Pieces of capillary glass tubing of known length are filled with white of egg. This is set into a solid by heating to 95° C. They are then placed in the digestive fluid at 36° C., and the coagulated egg-white is digested. After a given time the tubes are removed; and if the digestive process has not gone too far, only a part of the little column of coagulated protein will have disappeared; the length of the remaining column is easily measured, and the length that has been digested is a measure of the digestive strength of the fluid.<sup>1</sup> This forms a very convenient method to use in experiments on velocity of reaction. Schütz's Law states that the amount of action is proportional to the square root of the amount of ferment. If this rule applies (which is doubtful) it applies only to the action of pepsin hydrochloric

<sup>1</sup> Hamburger has used the same method in investigating the digestive action of juices on gelatin. The tubes are filled with warm gelatin solution, and this jellies on cooling. They are placed as before in the digestive mixture, and the length of the column that disappears can be easily measured. These experiments must, however, be performed at room temperature, for the usual temperature (36°-40° C.) at which artificial digestion is usually carried out would melt the gelatin. He has also used the same method for estimating amylolytic activity, by filling the tubes with thick starch paste.



acid. In most cases the rapidity of action is directly proportional to the amount of ferment present.

3. **The Acid of Gastric Juice.**—The digestive powers of the acids are proportional to their dissociation and the number of H ions liberated. The anions, however, modify this by having different powers of retarding the action. The greater suitability of hydrochloric over lactic acid, for instance, in gastric digestion is due to the fact that the former acid more readily undergoes dissociation.

*Hydrochloric acid* is absent or diminished in some diseases of the stomach, especially in cancer; this is true for cancer in general even when the stomach is not involved; the best colour tests for it are the following:—

(a) Gunsberg's reagent consists of 2 parts of phloroglucinol, 1 part of vanillin, and 30 parts of rectified spirit. A drop of filtered gastric juice is evaporated with an equal quantity of the reagent. Red crystals form, or, if much peptone is present, there will be a red paste. The reaction takes place with one part of hydrochloric acid in 10,000. The organic acids do not give the reaction.

(b) Tropæolin test. Drops of a saturated solution of tropæolin-OO in 94 per cent. methylated spirit are allowed to dry on a porcelain slab at 40° C. A drop of the fluid to be tested is placed on the tropæolin drop, still at 40° C.; and if hydrochloric acid is present a violet spot is left when the fluid has evaporated. A drop of 0.006-per-cent. hydrochloric acid leaves a distinct mark.

(c) Töpfer's test. A drop of dimethyl-amino-azo-benzol is spread in a thin film on a white plate. A drop of dilute hydrochloric acid (up to 1 in 10,000) strikes with this in the cold a bright red colour.

*Lactic acid* is sometimes present in the gastric contents, being derived by fermentative processes from the food. It is soluble in ether, and is generally detected by making an ethereal extract of the stomach contents, and evaporating the ether. If lactic acid is present in the residue it may be identified by Uffelmann's reaction in the following way:—

A solution of dilute ferric chloride and carbolic acid is made as follows:—  
10 c.c. of a 4-per-cent. solution of carbolic acid.  
20 c.c. of distilled water.

1 drop of the liquor ferri perchloridi of the British Pharmacopœia.

On mixing a solution containing a mere trace (up to 1 part in 10,000) of lactic acid with this violet solution, it is instantly turned yellow. Larger percentages of other acids—for instance, more than 0.2 per cent. of hydrochloric acid—are necessary to decolorise the test solution.

The reaction is not absolutely convincing, since other acids (though in larger percentages) decolorise the solution, but the characteristic yellow colour given even by dilute lactic acid is not developed. Note the decolorisation which occurs when 0.2 hydrochloric acid is added to Uffelmann's reagent.

*Hopkins's reaction for Lactic Acid.*—Place 3 drops of a 1-per-cent. alcoholic solution of lactic acid in a clean, *dry* test-tube, add 5 c.c. of concentrated sulphuric acid and 3 drops of a saturated solution of copper sulphate. Mix thoroughly and place the test-tube in a beaker of boiling water for five minutes. Then cool thoroughly under the tap, and add 2 drops of a 0.2-per-

cent. alcoholic solution of thiophene and shake. Replace the tube in the boiling water; as the mixture gets warm a cherry-red colour develops.

4. **Demonstration of Pancreatic Secretion.**—In an anæsthetised dog insert a cannula into the main pancreatic duct, and collect the juice in a suitable vessel. Inject some 0·4-per-cent. hydrochloric acid into the duodenum, and note after some minutes the abundant flow of pancreatic juice. Next ligature off and remove two or three feet of the upper part of the small intestine, wash out the contents and slit it open; scrape off the mucous membrane with the back of a scalpel; preserve a small quantity of the scrapings for future use and label this A. Grind up the remainder in a mortar with clean sand or powdered glass, and add 0·4 per cent. hydrochloric acid. Transfer the mixture to a flask, boil thoroughly, and when cool neutralise with a little caustic soda solution. Filter; the filtrate contains *secretin*, which has been formed by the acid from the *pro-secretin* of the intestinal epithelium. Inject some of this solution through a cannula into the external jugular vein of the dog, and an abundant flow of pancreatic juice is an almost immediate result.

5. Characters of the juice so obtained:—

(a) It is a clear, colourless fluid, and very strongly alkaline.

(b) Mixed with starch solution and kept at 40° C. dextrin and maltose are rapidly formed.

(c) Mixed with milk there may be some curdling produced, but the most marked effect is that the milk rapidly becomes acid, and a smell of fatty acids is noticeable.

(d) Added to fibrin and kept at 40° protein digestion occurs very slowly; next day, however, the fibrin will be in large measure digested.

(e) Mix some of the pancreatic juice with the scraping of the intestine which was preserved and labelled A. Then add fibrin. The fluid is now strongly proteolytic, and at 40° C. the fibrin rapidly dissolves; trypsin has been liberated from the trypsinogen of the juice by the intestinal *enterokinase*.

6. **Products of Pancreatic Digestion of Proteins.**—A pancreatic digest should be prepared beforehand by the demonstrator. This may be done by digesting a quantity of protein with artificial pancreatic juice, if the natural juice prepared by the action of secretin is not available; in the latter case the addition of intestinal epithelium (*entero-kinase*) should not be forgotten. Unless an antiseptic has been added putrefaction will also occur, and its odour will be very perceptible after the mixture has been placed in the warm chamber for some time.

A very good mixture for the purpose will be found to be the following:—

- 100 grammes of plasmon (caseinogen).
- 10 grammes of sodium carbonate.
- 1 litre of water.
- 25 c.c. of Bengel's liquor pancreaticus.
- 0·5 gramme sodium fluoride.
- 3 c.c. chloroform.

The last two items on the list are added to prevent putrefaction,

After digestion has progressed for one to two days another 10 c.c. of liquor pancreaticus may be added.

The products of digestion in one case should be examined, say, after six hours' digestion, and in another case after thirty-six hours' digestion or more. The digestive products should then be searched for; the early products of digestion (alkali-albumin, deutero-proteose, &c.) will become less abundant with the length of time that digestion has been allowed to progress, and the later products (peptone, leucine, tyrosine, tryptophane, &c.) will become more abundant. The methods for testing most of these substances have been already given. The following are the tests for tryptophane, leucine, and tyrosine:—

(a) *Tryptophane*.—Add a few drops of bromine water; a violet colour is produced.

(b) *Leucine and Tyrosine*.—i. Examine microscopical specimens of these. The deposit generally found in rather old specimens of Benger's liquor pancreaticus will be a convenient source of these crystals.

ii. To some of the pancreatic digest add Millon's reagent and filter off the precipitated protein. Boil the filtrate, and the presence of tyrosine is indicated by a red colour. If tyrosine is abundant the red colour appears without boiling. Leucine does not give this test.

iii. Faintly acidify another portion of the filtered digest with acetic acid and boil; if any protein matter is still undigested it will be thus coagulated and can be filtered off. Reduce the filtrate to a small bulk until it begins to become syrupy. Leave overnight in a cool place, and crystals mainly of tyrosine will separate out. Filter these off through fine muslin, and evaporate down the filtrate to the consistency of a thick syrup; leave this overnight again, and a second crop of crystals, forming a skin on the surface and consisting mainly of leucine, will have separated out.

7. **Zymogen Granules**.—Examine microscopically, mounting in aqueous humour or serum (or in glycerin after treatment with osmic acid vapour), small pieces of the pancreas, parotid, and submaxillary glands in a normal guinea-pig,<sup>1</sup> and also in one in which profuse secretion had been produced by the administration of pilocarpine.

Note that zymogen granules are abundant in the former, and scarce in the latter, being situated chiefly at the free border of the cells.

Extremely good, though not permanent, microscopic specimens may be obtained by teasing in a 33-per-cent. solution of caustic potash.

<sup>1</sup> The guinea-pigs should be killed by bleeding, and the blood collected and defibrinated, and utilised for the preparation of oxyhæmoglobin crystals. This will give students an opportunity of seeing the exceptional form (tetrahedra) in which the blood-pigment of this animal crystallises.

The three methods of obtaining crystals described on p. 112 all give good results. If amyl nitrite is used instead of ether in the third method, crystals of methæmoglobin are obtained.

## LESSON XIX

### HÆMOGLOBIN AND ITS DERIVATIVES

Defibrinated ox-blood suitably diluted may be used in the following experiments as in those described in Lesson IX.

1. Place some in a hæmatoscope (see fig. 33, p. 116) in front of the large spectroscop. Note the position of the two characteristic bands of **oxyhæmoglobin**; these are replaced by the single band of **hæmoglobin** after reduction by the addition of Stokes's reagent (see footnote, p. 115) or ammonium sulphide. By means of a small rectangular prism a comparison spectrum showing the bright sodium line (in the position of the dark line named D in the solar spectrum) may be obtained, and focussed with the absorption spectrum.

2. Obtain similar comparison spectra by the use of the microspectroscope. For this purpose a cell containing a small quantity of oxyhæmoglobin solution may be placed on the microscope stage, and a test-tube containing **carbonic oxide hæmoglobin** in front of the slit in the side of the instrument. Notice that the two bands of carbonic oxide hæmoglobin are very like those of oxyhæmoglobin, but are a little nearer to the violet end of the spectrum.

Carbonic oxide hæmoglobin may be readily prepared by passing a stream of coal gas through the diluted blood. It has a cherry-red colour and is not reduced by the addition of ammonium sulphide (fig. 57, spectrum 4).

3. **Methæmoglobin**.—Add a few drops of ferricyanide of potassium to dilute blood and warm gently. The colour changes to mahogany-brown. Place the test-tube in front of the small direct-vision spectroscop. Note the characteristic band in the red (fig. 57, spectrum 5). On dilution other bands appear (fig. 57, spectrum 6). Treat with ammonium sulphide and the band of hæmoglobin appears.

4. **Acid Hæmatin**.—(a) Prepare the following mixture:—150 c.c. of 90-per-cent. alcohol and 6 c.c. of concentrated sulphuric acid; take about 5 c.c. of this mixture and boil it in a test-tube. While still hot drop into it a few drops of undiluted defibrinated blood, and filter. Note the brown colour of the filtrate. Compare the position of the absorption band in the red with that of methæmoglobin; that of acid hæmatin is further from the D line (fig. 57, spectrum 7).

(b) Add some glacial acetic acid to undiluted defibrinated blood. Extract this with ether by gently agitating it with that fluid. The ethereal extract should then be poured off and examined spectroscopically. The band in the red is seen, and on further diluting with ether three additional bands appear.

5. **Alkaline Hæmatin**.—(a) Add to diluted blood a small quantity of strong

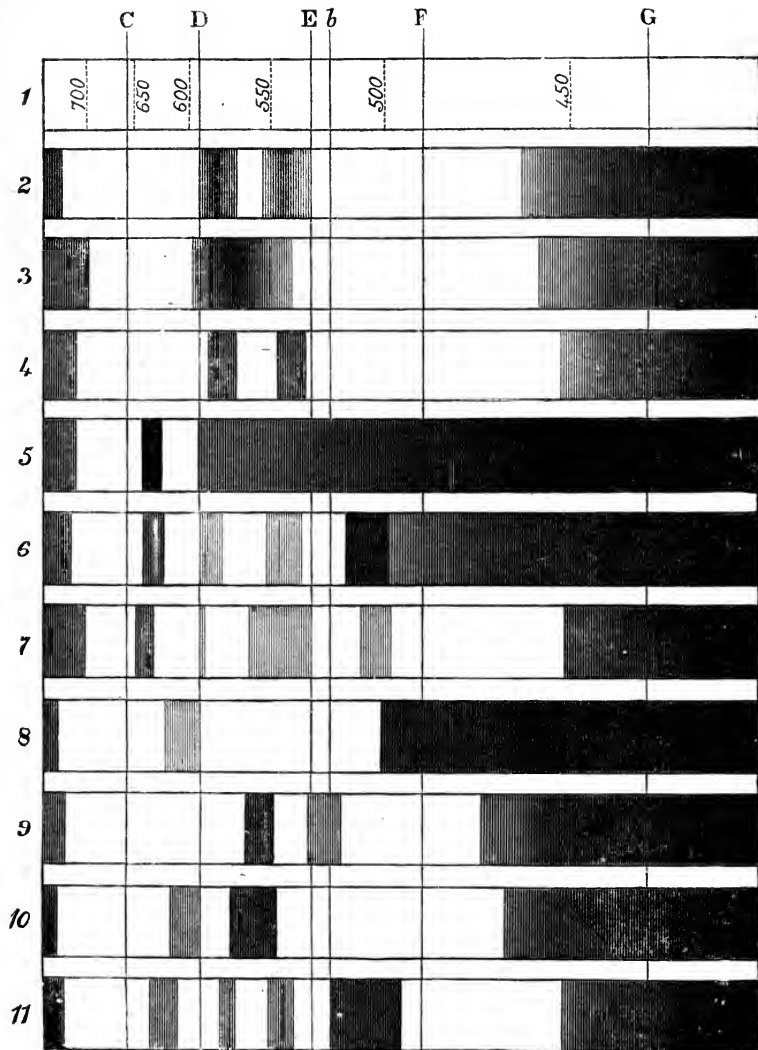

FIG. 57.—1, Solar spectrum. 2, Spectrum of oxyhæmoglobin (0.37 p.c. solution). First band,  $\lambda$  589-564; second band,  $\lambda$  555-517. 3, Spectrum of hæmoglobin. Band,  $\lambda$  597-535. 4, Spectrum of CO-hæmoglobin. First band,  $\lambda$  583-561; second band,  $\lambda$  547-521. 5, Spectrum of methæmoglobin (concentrated solution). 6, Spectrum of methæmoglobin (dilute solution). First band,  $\lambda$  647-622; second band,  $\lambda$  587-571; third band,  $\lambda$  552-532; fourth band,  $\lambda$  514-490. 7, Spectrum of acid hæmatin (etheral solution). First band,  $\lambda$  656-615; second band,  $\lambda$  597-577; third band,  $\lambda$  557-529; fourth band,  $\lambda$  517-488. 8, Spectrum of alkaline hæmatin. Band from  $\lambda$  630-581. 9, Spectrum of hæmochromogen (reduced hæmatin). First band,  $\lambda$  569-542; second band,  $\lambda$  535-504. 10, Spectrum of acid hæmatoporphyrin. First band,  $\lambda$  607-593; second band,  $\lambda$  585-536. 11, Spectrum of alkaline hæmatoporphyrin. First band,  $\lambda$  633-612; second band,  $\lambda$  589-564; third band,  $\lambda$  549-529; fourth band,  $\lambda$  518-488. The above measurements (after MacMunn) are in millionths of a millimetre. The liquid was examined in a layer 1 centimetre thick. The edges of ill-defined bands vary a good deal with the concentration of the solutions.

caustic potash and boil. The colour changes to brown, and with the spectroscope a faint shading on the left side of the D line is seen (fig. 57, spectrum 8).

(b) The band is much better seen in an alcoholic solution. Prepare the following mixture :—150 c.c. of 90-per-cent. alcohol, and 18 c.c. of 50-per-cent. potash. Take about 5 c.c. of this mixture in a test-tube and boil it.



FIG. 58.—The photographic spectrum of hæmoglobin oxyhæmoglobin. (Gamble.)

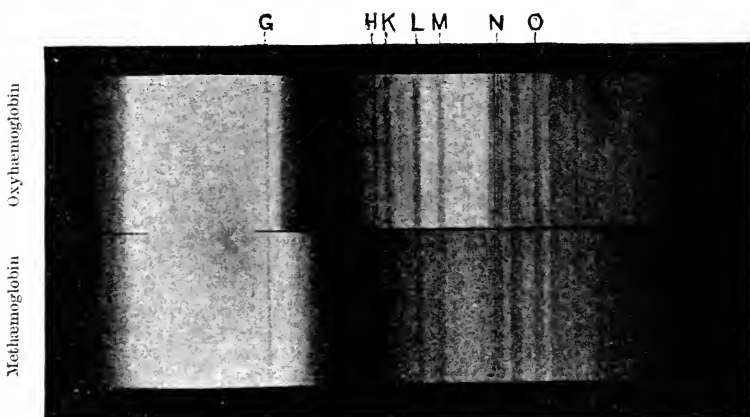

FIG. 59.—The photographic spectrum of oxyhæmoglobin and methæmoglobin. (Gamble.)

While still hot drop into it a few drops of undiluted defibrinated blood. The fluid then shows the spectrum of alkaline hæmatin. This may then be used for the next experiment.

6. **Hæmochromogen.**—Add ammonium sulphide to the solution of alkaline hæmatin; the colour changes to red, and two bands are seen, one between D

and E, and the other nearly coinciding with E and *b* (fig. 57, spectrum 9). The spectrum of alkaline hæmatin reappears for a short time after vigorous shaking with air.

7. **Hæmatoporphyrin.**—To some strong sulphuric acid in a test-tube add a few drops of undiluted blood, and observe the spectrum of acid hæmatoporphyrin (iron-free hæmatin) (fig. 57, spectrum 10). Map out all the spectra you see on a chart.

8. **The photographic Spectrum.**—Hæmoglobin and its compounds also show absorption bands in the ultra-violet portion of the spectrum. This portion of the spectrum is not visible to the eye, but can be rendered visible by allowing the spectrum to fall on a fluorescent screen, or on a sensitive photographic plate. In order to show absorption bands in this part of the spectrum very dilute solutions of the pigment must be used.

In order to demonstrate these bands, the telescope of a large spectroscope is removed, and a beam of sunlight or of light from the positive pole of an arc lamp is allowed to fall on the slit of the collimator. The spectrum is focussed on a fluorescent screen.<sup>1</sup> The slit is then opened very widely, and the coloured solution is interposed on the path of the beam falling on the slit.

Oxyhæmoglobin shows a band (Soret's band) between the lines G and H. In hæmoglobin, carbonic oxide hæmoglobin, and nitric oxide hæmoglobin, this band is rather nearer G. Methæmoglobin and hæmatoporphyrin show similar bands.

The two preceding figures show the 'photographic spectra' of hæmoglobin, oxyhæmoglobin, and methæmoglobin, and will serve as examples of the results obtained. I am greatly indebted to Prof. Gamgee, to whom we owe most of our knowledge on this subject, for permission to reproduce these two specimens of his numerous photographs.

9. **Preparation of Pure Oxyhæmoglobin.**—The following method is described in Stirling's 'Practical Physiology.' Centrifugalise dog's defibrinated blood and pour off the serum. Centrifugalise again with physiological saline solution repeatedly until the supernatant fluid contains only traces of protein. Mix the magma of corpuscles with two or three volumes of water saturated with acid-free ether; the solution becomes clear. Then add a few drops of 1-per-cent. solution of acid sodium sulphate till the mixture looks tinted like fresh blood, owing to the precipitation of the stromata. These can be separated by filtration. Pour off the clear red fluid: cool it to 0° C., add one-fourth of its volume of absolute alcohol previously cooled to 0° C. Shake well, and then let the mixture stand at 5°–15° C. for 24 hours. As a rule the whole passes into a glittering crystalline mass. Filter at 0° C. and wash with ice-cold 25-per-cent. alcohol. Redissolve the crystals in a small quantity of water, and recrystallise as before. The crystals may then be spread on plates of porous porcelain, and dried in a vacuum over sulphuric acid.

<sup>1</sup> Fluorescent screens, similar to those in common use in observations made with Röntgen rays, may be made by coating white cardboard with barium platino-cyanide.

## LESSON XX

### SERUM

1. The following methods of precipitating serum globulin should be performed:—

(a) **Panam's Method.**—Dilute serum with fifteen times its bulk of water. It becomes cloudy owing to partial precipitation of the serum globulin. Add a few drops of 2-per-cent. acetic acid; the precipitate becomes more abundant and it dissolves in excess of the acid. It was formerly called 'serum casein.'

(b) **Alexander Schmidt's Method.**—Dilute serum with twenty times its bulk of water and pass a stream of carbonic acid through it. A fairly abundant precipitate of serum globulin falls. Let it settle and an additional precipitate can be obtained from the decanted liquid by treating it with a trace of acetic acid (the 'serum casein' mentioned above). Repeat the carbonic acid method without dilution; no precipitate forms.

(c) **By Dialysis.** - Put some serum in a dialyser with distilled water in the outer vessel. The water must be frequently changed. In order to prevent decomposition a few crystals of thymol are added. In a day or two the salts have passed out; the proteins remain behind: of these the serum albumin is still in solution; the serum globulin is in part precipitated, as it requires a small quantity of salt to hold it in solution. (See also bottom of p. 193.)

(d) **By addition of Salts:—**

(i.) Schmidt's method. Saturate some serum with sodium chloride. A precipitate of serum globulin is produced.

(ii.) Hammarsten's method. Use magnesium sulphate instead of sodium chloride. A more abundant precipitate is produced, because this salt is a more perfect precipitant of serum globulin than sodium chloride. In order to obtain complete saturation with these salts it is necessary to shake the mixture of salt and serum for some hours.<sup>1</sup>

(iii.) Kauder's method. Half saturate serum with ammonium sulphate. This is done by adding to the serum an equal volume of saturated solution of ammonium sulphate. This precipitates the globulin. Complete saturation with the salt precipitates the albumin also.

2. **Heat Coagulation.**—Saturate serum with magnesium sulphate and filter off the precipitate; preserve the filtrate and label it 'B.' Wash the precipitate on the filter with saturated solution of magnesium sulphate until the washings do not give the tests for albumin,<sup>2</sup> then dissolve the precipitate by adding distilled water. It readily dissolves, owing to the salt adherent to it. The solution is opalescent. Label it 'A.'

<sup>1</sup> This may be conveniently done by a shaking machine before the class meets.

<sup>2</sup> On account of the prolonged nature of these operations, they must necessarily be performed by the demonstrator beforehand.



Render A faintly acid with a drop of 2-per-cent. acetic acid, and heat in a test-tube. The temperature of the test-tube may be raised by placing it in a flask of water gradually heated over a flame. A thermometer is placed in the test-tube, and should be kept moving so as to ensure that all parts of the liquid are at the same temperature. The quantity of liquid in the test-tube should be just sufficient to cover the bulb of the thermometer. A flocculent precipitate of coagulated serum globulin separates out at about 75°.

Now take the filtrate B. This contains the serum albumin. Dilute it with an equal volume of water; render it faintly acid as before, testing the reaction with litmus paper. Heat. A flocculent precipitate ( $\alpha$ ) falls at about 73° C.; filter this off; note that the filtrate is less acid than that from which the precipitate has separated, or it may even be alkaline. If so, make it faintly acid again, and heat; a precipitate falls at 77–79° C. ( $\beta$ ). A third precipitate is similarly obtained at 84–86° C. ( $\gamma$ ). In the serum of the ox, sheep, and horse the  $\alpha$  precipitate is absent: in cold-blooded animals, the  $\beta$  and  $\gamma$  varieties are absent.

3. Take a fresh portion of B, and saturate it with sodium sulphate. The serum albumin is precipitated (completely after a long shaking). This is due to the formation of sodio-magnesium sulphate. B was already saturated with magnesium sulphate ( $\text{MgSO}_4 + 7\text{H}_2\text{O}$ ); on adding sodium sulphate a double salt ( $\text{MgSO}_4 \cdot \text{Na}_2\text{SO}_4 + 6\text{H}_2\text{O}$ ) is formed. Shake some serum with sodium sulphate alone. A small precipitate of globulin is produced.<sup>1</sup> Saturate another portion of the serum with sodio-magnesium sulphate; both globulin and albumin are precipitated.

Of the methods used for precipitating serum globulin practically only two are used now. There are Hammarsten's and Kauder's. The other methods only precipitate the globulin incompletely. Kauder's method is rapid and efficacious: if the globulin is filtered off, the albumin may be precipitated in the filtrate by complete saturation with the same salt, ammonium sulphate. This method avoids the trouble of using two salts as described under 3. This last method is instructive, but not nearly so quick as Kauder's.

With regard to the separation of serum albumin into  $\alpha$ ,  $\beta$ , and  $\gamma$  varieties by the use of the method of fractional heat coagulation, it must be mentioned that at present no further difference has been shown to exist between them, and the opinion has been very freely expressed that the results obtained are not trustworthy. I am convinced that the method is a good one, especially as in other cases (see MUSCLE) the proteins so separated can be shown to possess other differences. In the case of serum, however—and the same is true for egg albumin—the matter must still be considered *sub judice*.

Recent research has shown that serum globulin is not a single protein. We have already seen that the precipitation which occurs by means of dialysis is incomplete. It has now been shown that serum globulin as 'salted out' by means of the sulphate of magnesium or ammonium really consists of two proteins; one of these (eu-globulin) is precipitable by dialysis: the other (pseudo-globulin) is not.

<sup>1</sup> That is at room temperature; if the temperature is raised to 36° C. sodium sulphate acts like ammonium sulphate and precipitates all the proteins, except peptone.

## LESSON XXI

### COAGULATION OF BLOOD

**1. Effect of decalcifying Agents in hindering Coagulation.**—From an anaesthetised dog collect samples of blood from the carotid artery, into which a suitable cannula should have been previously inserted.

(a) Collect the first sample in an equal volume of 0·4 per cent. solution of potassium oxalate made with physiological salt solution.

(b) Collect the second sample in an equal volume of 0·4 solution of sodium fluoride.

(c) Collect the third sample in a quarter of its volume of 10 per cent. solution of sodium citrate.

In all three cases mix thoroughly, and coagulation is hindered owing to decalcification, as explained on page 106.

The separation of the plasma from the corpuscles may be most readily carried out by a centrifugal machine, one form of which is shown in the next figure; the corpuscles settle and the supernatant plasma can be then pipetted off. Sedimentation is specially rapid in the case of citrate blood, and a well-marked layer of colourless corpuscles and platelets may usually be seen on the top of the mass of red corpuscles.

Oxalate plasma and citrate plasma coagulate on the restoration of the calcium by adding a few drops of calcium chloride solution, as we have already seen in the elementary course (p. 101). Fluoride plasma does not coagulate unless fibrin ferment (or some fluid such as serum which contains fibrin ferment or thrombin) is added as well as the calcium salt. Fluoride plasma thus forms a convenient test-fluid for fibrin ferment.

If in either case the plasma is previously heated to 60° C. and filtered, coagulation—that is to say, fibrin formation—can never be produced, because its mother-substance, fibrinogen, which is coagulated by heat at 56° C., has been destroyed and removed.

**2. Influence of Leech Extract on Coagulation.**—The same dog still under the anaesthetic may be next used for the following experiments:—

(a) Draw off a sample of blood into a clean test-tube, and note the time it takes to clot.

(b) Draw off a second sample into about half its volume of leech extract, made by grinding up the heads of about twenty leeches in 20 c.c. of salt solution, and filtering. This remains unclotted for hours or days.

(c) Inject 10 c.c. of the extract into the jugular vein of the animal, and draw off samples of blood from time to time, comparing the coagulation time (which gradually lengthens) with that of specimen *a*.

(d) Having obtained a specimen which does not clot at all, dilute it with

salt solution and pass a stream of carbon dioxide through it. Clotting is not produced as it is in 'peptone' blood (which see). In order to produce clotting, excess of serum, or some fluid containing thrombin must be added. The action of leech extract is mainly due to the fact that it contains anti-thrombin.

(e) The experiments described under *d* may be repeated with leech extract plasma, obtained from the blood by centrifugalising.

(f) Instead of leech extract, a solution of its active principle (hirudin) may be used. This produces no fall of blood pressure, and so contrasts

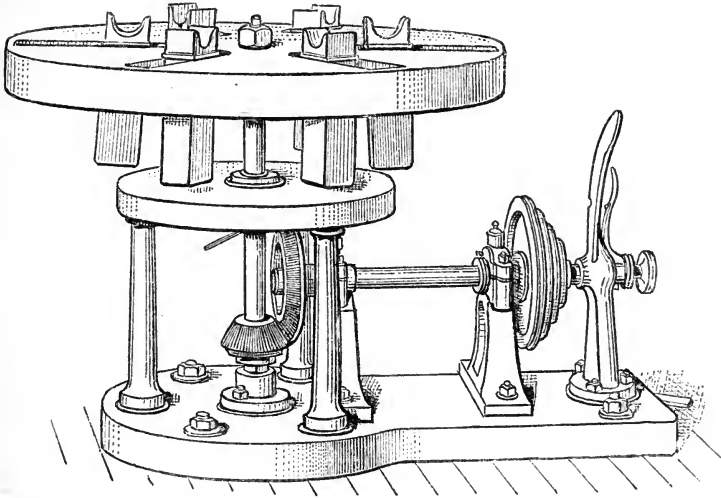

FIG. 60.—Centrifugal machine as made by Runne. Glass vessels containing the substances to be centrifugalised are placed within the six metallic tubes which hang vertically while the disc is at rest; when the machinery is set going they fly out into the horizontal position.

with what occurs in 'peptone' injection. Leech extract produces a very small fall of arterial pressure.

**3. Influence of Commercial Peptones (Proteoses) on Coagulation.**—For the purpose of the following experiments another dog must be employed.

The animal having been anaesthetised a cannula is placed in the external jugular vein for the injection of the 'peptone.'

The carotid artery is connected to a mercurial manometer for the registration of arterial pressure.

Another convenient artery must be exposed and a cannula inserted into it for the collection of samples of blood.

(a) First draw off a sample of blood and note its coagulation time.

(b) Draw a second sample into a strong solution of commercial peptone. The coagulation time is somewhat longer than in *a*.

(c) Then inject the peptone quickly, so that the animal receives 0.3 gramme per kilo. of body-weight. Note during and for some time after the injection a great fall in arterial blood pressure. This has been shown by the oncometer to be due to vascular dilatation.

(d) After the injection draw off successive samples, and note the great prolongation of the coagulation time which is soon produced.

(e) Dilute some of the blood which does not clot with twice its volume of salt solution, and pass a stream of carbonic acid through the mixture; coagulation soon occurs.

(f) The same experiment may be repeated with the same result, if 'peptone' plasma obtained by centrifugalising is used instead of the whole blood.

(g) Finally bleed the animal to death, collecting the blood in three successive glass cylinders. Place them in the ice chest, and examine them a few days or a week later.

The first lot of blood collected will show sedimentation of corpuscles, and a slight clot at the junction of the corpuscles and supernatant plasma—that is, at the place where the white corpuscles and platelets lie.

The last lot of blood collected shows less sedimentation, and will probably have clotted throughout. This is because the blood removed last has been diluted by tissue lymph, which has passed into the blood-stream in an attempt to increase the volume of the blood, which has been lessened by the previous bleeding; the clot produced is probably due to the action of thrombokinase.

The middle sample will show something intermediate between the two extremes, the usual state of things being clot through the sediment, and the plasma above it still fluid.

4. **Intravascular Coagulation.**—A solution of nucleo-protein from the thymus, testis, lymphatic glands, or kidney has been prepared beforehand by the demonstrator. It may be prepared in one or two ways.

(a) *Wooldridge's Method.*—The gland is cut up small and extracted with water for twenty-four hours. Weak acetic acid (0.5 c.c. of the acetic acid of the 'Pharmacopœia' diluted with twice its volume of water for every 100 c.c. of extract) is then added to the decanted liquid. After some hours the precipitated nucleo-protein (called tissue-fibrinogen by Wooldridge) falls to the bottom of the vessel. This is collected and dissolved in 1-per-cent. sodium carbonate solution.

(b) *The Sodium Chloride Method.*—The finely divided gland is ground up in a mortar with about an equal volume of sodium chloride. The resulting viscous mass is poured into excess of distilled water. The nucleo-protein rises to the surface of the water, where it may be collected and dissolved as before.

A rabbit is anaesthetised, and a cannula inserted into the external jugular vein. The solution is injected into the circulation through this. The animal soon dies from cessation of respiration; the eyeballs protrude and the pupils are widely dilated. On opening the animal the heart will be found still beating, and its cavities (especially on the right side) distended with clotted blood. The vessels, especially the veins, also are full of clot. The blood of the portal vein is usually clotted most. If a dog is employed instead of a rabbit in this experiment, coagulation is usually confined to the portal area. This is related to the greater venosity of the blood in this situation. If venosity is increased in any other area, as by tetanising the muscles of one leg, clotting will be found also in the veins of this region.

## LESSON XXII

### *MUSCLE AND NERVOUS TISSUE*

1. **Hopkins's Lactic Acid Test** (see p. 185) may be applied as follows. Remove one hind limb of a pithed frog. Stimulate the sacral plexus of the other side for ten minutes with a strong Faradic current. Then amputate the other hind limb. Skin both legs, and chop up the muscles of the two sides separately. Pound each in a mortar with clean sand and then with 15 c.c. of 95-per-cent. alcohol. Transfer the mixture to a beaker, and warm in the water-bath for a few minutes. Filter, and evaporate the filtrate to dryness in a water-bath. Extract the residue with about 5 c.c. of cold water, rubbing it up thoroughly with a glass rod. Filter and boil the filtrate in a test-tube for about a minute with as much animal charcoal as will lie on a threepenny-piece. Filter again and evaporate the filtrate to dryness in a water-bath. Allow the residue to cool, and dissolve it by shaking in 5 c.c. of concentrated sulphuric acid. Transfer this to a dry test-tube; add three drops of saturated solution of copper sulphate, and place the tube in boiling water for five minutes. Cool and add 2 drops of 0.2-per-cent. solution of thiophene in alcohol; replace the tube in the boiling water. A cherry-red colour develops in the tube containing the extract from tetanised muscle, but not in the other.

2 A rabbit has been killed and its muscles washed free from blood by a stream of salt solution injected through the aorta. The muscles have been quickly removed, chopped up small, and extracted with 5-per-cent. solution of magnesium sulphate. This extract is given out. It will probably be faintly acid. The acid is sarco-lactic acid. It may be identified by Uffelmann's (p. 185) or Hopkins's reaction.

3. The coagulation of muscle is very like that of blood. This may be shown with the salted muscle plasma (the extract given out) as follows: Dilute some of it with four times its volume of water; divide it into two parts; keep one at 40° C. and the other at the ordinary temperature. Coagulation—that is, formation of a clot of myosin—occurs in both, but earliest in that at 40° C.

4. Remove the clot of myosin from 3; observe it is soluble in 10-per-cent. sodium chloride, and also in 0.2-per-cent. hydrochloric acid, forming syntonin.

5. Make an extract of muscle in the same way, using a small quantity of physiological salt solution instead of the strong solution of magnesium sulphate employed in the foregoing experiments. Such an extract contains the two principal muscular proteins, viz. paramyosinogen (v. Fürth's myosin)

and myosinogen (v. Fürth's myogen), the two precursors of the muscle-clot or myosin (v. Fürth's muscle-fibrin). Small quantities of other proteins also present are mainly due to unavoidable mixture with small amounts of blood and lymph.

These two proteins differ in temperature of heat coagulation. Take the extract and heat it in a test-tube within a water-bath; at 47° C. paramyosinogen is coagulated; filter this off and heat the filtrate; at 56° C. flocculi of the coagulated myosinogen separate out.

6. Paramyosinogen is precipitable by dialysis and is a true globulin. Myosinogen is what is called an atypical globulin, and corresponds to the pseudo-globulin of blood serum and egg-white. Though readily salted out of solution like paramyosinogen it is not precipitable by dialysis.

7. In the process of clotting, such as occurs in *rigor mortis*, paramyosinogen is directly converted into myosin; whereas myosinogen first passes into a soluble modification (coagulable by heat at the remarkably low temperature of 40° C.) before myosin is formed. This is shown in a diagrammatic way in the following scheme:—

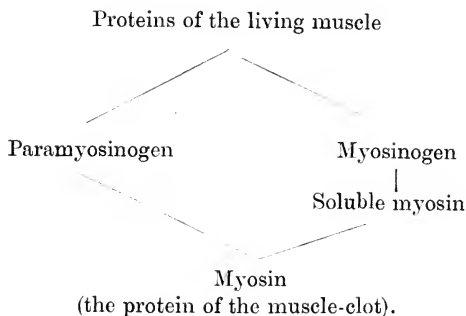

8. When a muscle is gradually heated, at a certain temperature it contracts permanently and loses its irritability. This phenomenon is known as *heat-rigor*, and is due to the coagulation of the proteins in the muscle. If a tracing is taken of the shortening, it is found that the first shortening occurs at the coagulation temperature of paramyosinogen (47°–50° C.), and if the heating is continued a second shortening occurs at 56° C., the coagulation temperature of myosinogen. If frog's muscles are used there are three shortenings—namely, at 40°, 47°, and 56° C.; frog's muscle thus contains an additional protein which coagulates at 40° C. This additional protein is the soluble myosin alluded to above, some of which, in the muscle of cold-blooded animals, is present before *rigor mortis* occurs.

In addition to the proteins mentioned, there is a small quantity of nucleo-protein.

9. **Involuntary Muscle.**—The main facts just described for voluntary are true also for involuntary muscle. The chief distinction lies in the quantity of nucleo-protein, which is more abundant in those forms of muscle the fibres of which are least different from the mesoblastic cells from which all ultimately originate. This may be readily shown by the following simple experiment.

Take equal parts of voluntary muscle, heart muscle, and plain muscle (say from the stomach wall), and extract each for the same time with equal amounts of 0.15-per-cent. solution of sodium carbonate. Filter and add to each filtrate acetic acid, drop by drop. The extract of voluntary muscle

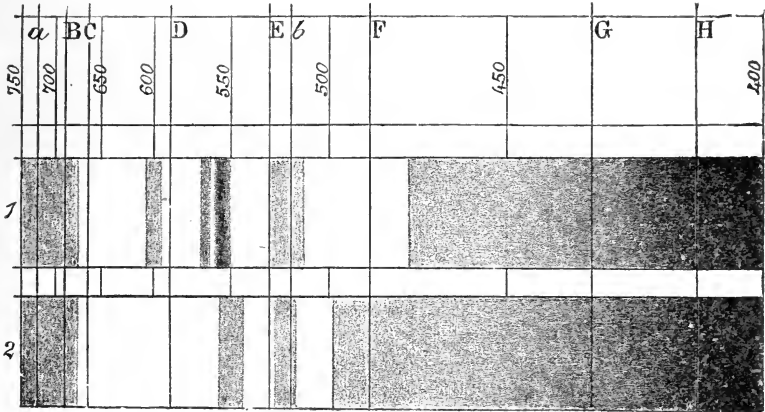

FIG. 61.—1, Absorption spectrum of myohaematin, as seen in muscle rendered transparent by glycerin. 2, Absorption spectrum of modified myohaematin.

gives an opalescence only; in the case of the plain muscle there is an abundant precipitate; the heart muscle gives a result intermediate between the other two.

#### 10. Pigments of Muscle :—

(a) Notice the difference between the red and pale muscles of the rabbit.

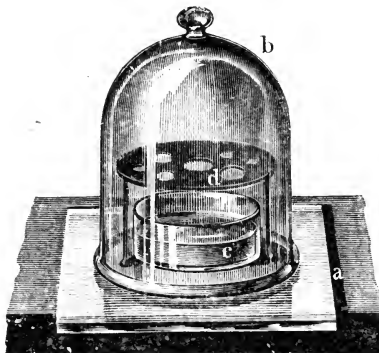

FIG. 62.—A desiccator. (Gscheidlen.) a, glass plate; b, bell-jar; c, dish of sulphuric acid; d, stand for capsules.

(b) Examine a piece of red muscle (*e.g.* the diaphragm) spectroscopically for oxyhæmoglobin (or it may be more convenient to make an aqueous extract of the muscle and examine that).

(c) A piece of the pectoral muscle of a pigeon has been soaked in glycerin.

Press a small piece between two glass slides and place it in front of the spectroscope. Observe and map out the bands of myohæmatin. This pigment is doubtless a derivative of hæmoglobin.

(d) Pieces of the same muscles have been placed in ether for twenty-four hours. The ether dissolves out a yellow lipochrome from the adherent fat. A watery fluid below contains modified myohæmatin. Filter it; compare its spectrum with that of hæmochromogen. The myohæmatin bands are rather nearer the violet end of the spectrum (fig. 61, spectrum 2) than those of hæmochromogen (fig. 57, spectrum 9).

#### 11. Creatine :—

(a) Take some of the red fluid described in 10, d, and let it evaporate to dryness in a desiccator over sulphuric acid (fig. 62).

In a day or two crystals of creatine tinged with myohæmatin separate out.

(b) Take an aqueous extract of muscle, like Liebig's extract or beef-tea; add baryta water to precipitate the phosphates, and filter. Remove excess of baryta by a stream of carbonic acid; filter off the barium carbonate and evaporate the filtrate on the water-bath to a thick syrup. Set it aside to cool, and in a few days crystalline deposits of creatine will be found at the bottom of the vessel. These are washed with alcohol and dissolved in hot water. On concentrating the aqueous solution crystals once more separate out, which may be still further purified by recrystallisation.

### NERVOUS TISSUES

The chemical investigation of nervous tissues is not well adapted to class exercises; still it may not be uninteresting to state briefly the principal known facts in relation to this subject. The most important points which any table of analysis will show are: (1) the large percentage of water, especially in the grey matter; (2) the large percentage of protein. In grey matter, where the cells are prominent structures, this is most marked, and of the solids, protein material here comprises more than half of the total. The following are some analyses which give the mean of a number of observations on the nervous tissues of human beings, monkeys, dogs, and cats :—

—	Water	Solids	Percentage of Proteins in Solids
Cerebral grey matter . . . .	83·5	16·5	51
"    white    " . . . .	69·9	30·1	33
Cerebellum . . . . .	79·8	20·2	42
Spinal cord as a whole . . . .	71·6	28·4	31
Cervical cord . . . . .	72·5	27·5	31
Dorsal cord . . . . .	69·8	30·2	28
Lumbar cord . . . . .	72·6	27·4	33
Sciatic nerves . . . . .	65·1	34·9	29

The most important protein is *nucleo-protein*; there is also a certain amount of *globulin*, which, like the paramyosinogen of muscle, is coagulated by heat at the low temperature of 47° C. A certain small amount of neuro-



keratin (especially abundant in white matter) is included in the above table with the proteins. The granules in nerve cells (Nissl's bodies), which stain readily with methylene blue, are nucleo-protein in nature. The next most abundant substances are of a fatty nature; the most prominent of these is the phosphorised fat called *lecithin* (see p. 25). A complex substance called *protagon*, which crystallises out on cooling a hot alcoholic extract of brain or other nervous structures is of uncertain composition. *Cerebrin* is a term which probably includes several substances, which are nitrogenous glucosides; they yield on hydrolysis the sugar called galactose (see p. 18). They are sometimes called cerebrosides. There are other phosphorised fats as well, of which *kephalin* is the best known. The crystalline monatomic alcohol *cholesterin* (see p. 93) is also a fairly abundant constituent of nervous structures, especially of the white substance of Schwann. Finally there are smaller quantities of other extractives, and a small proportion of mineral salts (about 1 per cent. of the solids).

Fresh nervous tissues are alkaline, but like most other living structures, they turn acid after death. The change is particularly rapid in grey matter. The acidity is due to lactic acid.

Very little is known of the chemical changes nervous tissues undergo during activity. We know that oxygen is very essential, especially for the activity of grey matter; cerebral anæmia is rapidly followed by loss of consciousness and death. Waller has suggested that small quantities of carbonic acid are produced during activity, because the increase in the action current (detected by the galvanometer) which occurs after a nerve has been repeatedly excited is very like the increase also noted on the application of small quantities of this gas. Waller's suggestion has recently been confirmed by direct experiments in which the amount of carbon dioxide formed has been estimated. Large quantities of carbonic acid act like an anæsthetic, abolishing nervous activity. Of all parts of the nervous system, the cells in the grey matter are those which most readily manifest fatigue; the next most sensitive region is the termination of nerves in such endings as the end-plates. Fatigue in a medullated nerve-trunk has never yet been experimentally demonstrated; Waller's view that this is due to inter-nutritional changes between the axis cylinder and the investing medullary sheath can hardly be considered proved, for it is just as difficult to demonstrate fatigue in non-medullated nerves.

**Chemistry of Nerve-degeneration.**—Mott and I have shown that, in the disease General Paralysis of the Insane, the marked degeneration that occurs in the brain is accompanied by the passing of the products of degeneration into the cerebro-spinal fluid. Of these, nucleo-protein and choline—a decomposition product of the lecithin (see p. 26)—are those which can be most readily detected. Choline can also be found in the blood. But this is not peculiar to the disease just mentioned, for in various other degenerative nervous diseases (combined sclerosis, disseminated sclerosis, meningitis, alcoholic neuritis, beri-beri, &c.) choline can also be detected in these situations. The tests employed to detect choline are mainly three: (1) The fluid is diluted with about five times its volume of alcohol and the precipitated proteins are filtered off. The filtrate is evaporated to dryness at 40° C. and the residue

dissolved in absolute alcohol and filtered; the filtrate from this is again evaporated to dryness, and again dissolved in absolute alcohol, and this should be again repeated. To the final alcoholic solution, an alcoholic solution of platinum chloride is added, and the precipitate so formed is allowed to settle and is washed with absolute alcohol by decantation; the precipitate is then dissolved in 15-per-cent. alcohol, filtered, and the filtrate is allowed to slowly evaporate in a watch-glass at 40° C. The crystals can then be seen with the microscope. They are recognised not only by their yellow colour and octahedral form, and by their solubility in water and 15-per cent. alcohol, but also by the fact that on incineration they yield 81 per-cent. of platinum and give off the odour of trimethylamine. There is a danger of mistaking such crystals for those obtained from the chlorides of potassium and ammonium; but the presence of such contaminations may be minimised by the use of alcohol as water-free as possible. (2) The following test, however, is entirely distinctive of choline and leads to no risk of confusion with other substances. The final alcoholic solution prepared as above is evaporated to dryness, and the residue taken up with water, to this is added a strong solution of iodine (2 grammes of iodine and 6 grammes of potassium iodide in 100 c.c. of water). In a few minutes dark-brown prisms of choline periodide are formed. These look very like hæmin crystals. If the slide is allowed to stand so that the liquid gradually evaporates, the crystals slowly disappear, and their place is taken by brown oily droplets, but if a fresh drop of the iodine solution is added the crystals slowly form once more. (3) A physiological test, namely the lowering of arterial blood-pressure (partly cardiac in origin, and partly due to dilatation of peripheral vessels) which a saline solution of the residue of the alcoholic extract produces: this fall is abolished, or even replaced by a rise of arterial pressure, if the animal has been atropinised. Such tests have already been shown to be of diagnostic value in the distinction between organic and so-called functional diseases of the nervous system.

A similar condition can be produced artificially in animals by a division of large nerve-trunks; and is most marked in those animals in which the degenerative process is at its height as tested histologically by the Marchi reaction.<sup>1</sup> A chemical analysis of the nerves themselves was also made. A series of cats was taken, both sciatic nerves divided, and the animals subsequently killed at intervals varying from 1 to 106 days. The nerves remain practically normal as long as they remain irritable: that is, up to about three days after the operation. They then show a progressive increase in the percentage of water, and a progressive decrease in the percentage of phosphorus until degeneration is complete. When regeneration occurs, the nerves return approximately to their previous chemical condition. One chemical feature of degeneration is the replacement of phosphorised by non-phosphorised fat. When the Marchi reaction disappears in the later stages of degeneration, the

<sup>1</sup> The Marchi reaction is the black staining that the medullary sheath of degenerated nerve fibres shows when, after being hardened in Müller's fluid, they are treated with Marchi's reagent, a mixture of Müller's fluid and osmic acid. Healthy nerve fibres are but little affected by the reagent, but degenerated myelin is blackened like the fat of normal adipose tissue.

non-phosphorised fat has been absorbed. This absorption occurs earlier in the peripheral nerves than in the central nervous system. The non-phosphorised fat of degenerated myelin is also either richer in olein, or the olein is more loosely combined than in the healthy medullary sheath; hence the deeper reaction with osmic acid even in the presence of chromic acid as in the Marchi test. The following table gives details of these experiments :—

Cat's sciatic nerves				Percentage of phosphorus in solids	Condition of blood	Condition of nerves
—	Water	Solids				
Normal	65.1	34.9	1.1	{ Minimal traces of choline present	{ Nerves irritable and histologically healthy	
1 to 3 days after section	64.5	35.5	0.9			
4 to 6	69.3	30.7	0.9	{ Choline more abundant	{ Irritability lost; degeneration beginning	
8	68.2	31.8	0.5	{ Choline abundant	{ Degeneration well shown by Marchi reaction	
10	70.7	29.3	0.3			
13	71.3	28.7	0.2			
25-27	72.1	27.9	traces	{ Choline much less	{ Marchi reaction still seen, but absorption of degenerated fat has set in	
29	72.5	27.5	0			
44	72.6	27.4	0	{ Choline almost disappeared	{ Absorption of fat practically complete	
100 to 106	66.2	33.8	0.9			{ Return of function, nerves regenerated

The foregoing figures relate to the peripheral portions of the nerves. Noll has also shown that the phosphorised fat diminishes somewhat in the central ends of cut nerves due to 'disuse atrophy.'

Further, it has been found that in human spinal cords in which a unilateral degeneration of the pyramidal tract has been produced by a lesion in the opposite hemisphere, and which gives the Marchi reaction, there is a similar increase of water and diminution of phosphorus on the degenerated side.

**Cerebro-spinal Fluid.**—This plays the part of the lymph of the central nervous system, but differs considerably from all other forms of lymph. It is a very watery fluid, containing, besides some inorganic salts similar to those of the blood, a trace of protein matter (globulin) and a small amount of a reducing substance, the nature of which was for a long time uncertain but which seems now to have been proved to be sugar. It contains the merest trace of choline; but this is not devoid of significance, for this fact taken in conjunction with another—namely, that physiological saline solution will extract from perfectly fresh nervous matter a small quantity of choline—shows us that lecithin is not a stable substance, but is constantly breaking down and building itself up afresh; in fact, undergoing the process called metabolism. This is most marked in the most active region of the brain—viz. the grey matter.

## LESSON XXIII

### UREA AND CHLORIDES IN URINE

#### ESTIMATION OF UREA

If albumin is present it must be first separated by boiling after acidulation with acetic acid if necessary, and filtering off the flakes of coagulated protein. The hypobromite method of estimation (see p. 141) holds its own, as it is easy and sufficiently exact for clinical purposes. It has entirely replaced the older method of Liebig (titration with mercuric nitrate), which is now of purely historical interest.

When absolute accuracy is necessary, one or other of many recently introduced methods must be employed. We shall be content with describing two of these.

(a) **Folin's Method.**—This depends on the fact that urea is decomposed quantitatively into ammonia and carbonic acid by boiling with magnesium chloride solution. The ammonia is estimated by distillation into standard acid and subsequent titration.

*Analysis.*—Three c.c. of urine, 20 grammes of magnesium chloride and 2 c.c. of concentrated hydrochloric acid are boiled in a flask, closed by a cork through which a glass tube 20 centimetres in height passes. This acts as a reflux condenser. The boiling is continued for 25 to 30 minutes. After diluting with water the mixture is then transferred to a litre flask, 7 c.c. of 20-per-cent. caustic soda are added, and the ammonia is distilled off and estimated as described in the final operation in Kjeldahl's method (see Appendix, p. 235). Every c.c. of decinormal ammonia in the distillate corresponds to 3 milligrammes of urea. A small correction has to be made for the ammonia present as such in the original urine.

(b) **Method of Mörner and Sjöqvist.**—The following reagents are necessary:

i. A saturated solution of barium chloride containing 5 per cent. of barium hydrate.

ii. A mixture of ether and alcohol in proportion 1 : 2.

iii. The apparatus, &c., necessary for carrying out Kjeldahl's method of estimating nitrogen (see p. 235).

*Analysis.*—Five c.c. of urine are mixed with 5 c.c. of the barium mixture and 100 c.c. of the mixture of ether and alcohol. By this means all nitrogenous substances except urea are precipitated. Twenty-four hours later this is filtered off, and the precipitate is washed with 50 c.c. of the ether-alcohol mixture, the filter-pump being used to accelerate the process. The washings are added to the filtrate; a little magnesia is added to this to drive off ammonia.

The alcohol and ether are then driven off at a temperature of 55° C., and evaporation is continued at this temperature until the volume of the residue is 10–15 c.c. The nitrogen in this is estimated by Kjeldahl's method. The nitrogen found is multiplied by 2·143, and the result is the amount of urea.

#### PREPARATION OF UREA FROM URINE

(1) Evaporate the urine to a small bulk. Add strong pure nitric acid in excess, keeping the mixture cool during the addition of the acid. Pour off the excess of fluid from the crystals of urea nitrate which are formed; strain through muslin and press between filter paper. Add to the dry product barium carbonate in large excess. This forms barium nitrate and sets the urea free. Mix thoroughly with sufficient methylated spirit to form a paste. Dry on a water-bath and extract with alcohol; filter; evaporate the filtrate on a water-bath and set aside. The urea crystallises out, and may be decolourised by animal charcoal and purified by recrystallisation.

(2) The following method is well adapted for the preparation of microscopic specimens of urea and urea nitrate: Take 20 c.c. of urine; add baryta mixture (see footnote 3, p. 5) until no further precipitate is produced; filter, evaporate the filtrate to a thick syrup on the water-bath, and extract with alcohol; pour off and filter the alcoholic extract; evaporate it to dryness on the water-bath and take up the residue with water. Place a drop of the aqueous solution on a slide and allow it to crystallise; crystals of urea separate out. Place another drop on another slide and add a drop of nitric acid; crystals of urea nitrate separate out.

#### ESTIMATION OF CHLORIDES

The chlorides in the urine consist of those of sodium and potassium, the latter only in small quantities. The method adopted for the determination of the total chlorides consists in their precipitation by a standard solution of silver nitrate (Mohr's method).

The following solutions must be prepared:—

Standard silver nitrate solution. Dissolve 29·075 grammes of fused nitrate of silver in a litre (1,000 c.c.) of distilled water: 1 c.c. = 0·01 gramme of sodium chloride.

(a) Saturated solution of neutral potassium chromate.

*Analysis.*—Take 10 c.c. of urine; dilute with 100 c.c. of distilled water.

Add to this a few drops of the potassium chromate solution.

Drop into this mixture from a burette the standard silver nitrate solution; the chlorine combines with the silver to form silver chloride, a white precipitate. When all the chlorides are so precipitated, silver chromate (red in colour) goes down, but not while any chloride remains in solution. The silver nitrate must therefore be added until the precipitate has a pink tinge.

From the amount of standard solution used, the quantity of sodium chloride in 10 c.c. of urine, and thence the percentage, may be calculated.

*Sources of Error and Corrections.*—A high-coloured urine may give rise to difficulty in seeing the pink tinge of the silver chromate: this is overcome by diluting the urine more than stated in the preceding paragraph.

One c.c. should always be subtracted from the total number of c.c. of the

silver nitrate solution used, as the urine contains small quantities of certain compounds more easily precipitable than the chromate.

To obviate such sources of error the following modification of the test, as described by Sutton, may be used: 10 c.c. of urine are measured into a thin porcelain capsule and 1 gramme of pure ammonium nitrate added; the whole is then evaporated to dryness, and gradually heated over a small spirit lamp to low redness till all vapours are dissipated and the residue becomes white. It is then dissolved in a small quantity of water, and the carbonates produced by the combustion of the organic matter neutralised by dilute acetic acid; a few grains of pure calcium carbonate to remove all free acid are then added, and one or two drops of potassium chromate. The mixture is then titrated with decinormal silver solution (16.966 gr. of silver nitrate per litre) until the end reaction, a pink colour, appears. Each c.c. of silver solution represents 0.005837 gr. of salt; consequently, if 12.5 c.c. have been used, the weight of salt in the 10 c.c. of urine is 0.07296 gr., or 0.7296 per cent. If 5.9 c.c. of urine are taken for titration, the number of c.c. of silver solution used will represent the number of parts of salt per 1,000 parts of urine.

## LESSON XXIV

### ESTIMATION OF PHOSPHATES AND SULPHATES IN URINE

#### ESTIMATION OF PHOSPHATES

The phosphoric acid in the urine is combined with soda, potash, lime, and magnesia.

(a) *Estimation of the total phosphates.*

For this purpose the following reagents are necessary:—

i. A standard solution of uranium nitrate. The uranium nitrate solution contains 35.5 grammes in a litre of water; 1 c.c. corresponds to 0.005 gramme of phosphoric acid ( $P_2O_5$ ).

ii. Acid solution of sodium acetate. Dissolve 100 grammes of sodium acetate in 900 c.c. of water; add to this 100 c.c. of glacial acetic acid.

iii. Solution of potassium ferrocyanide.

*Method.*—Take 50 c.c. of urine. Add 5 c.c. of the acid solution of sodium acetate.<sup>1</sup> Heat the mixture to 80° C.

Run into it while hot the standard uranium nitrate solution from a burette until a drop of the mixture gives a distinct brown colour with a drop of potassium ferrocyanide placed on a porcelain slab. Read off the quantity of solution used and calculate therefrom the percentage amount of phosphoric acid in the urine.

Another indicator which may be used is cochineal tincture, a few drops of which may be added to the mixture. A change of colour from red to green is the sign of the end of the reaction.

(b) *Estimation of the phosphoric acid combined with lime and magnesia (alkaline earths).*

Take 200 c.c. of urine. Render it alkaline with ammonia. Lay the mixture aside for twelve hours. Collect the precipitated earthy phosphates on a filter; wash with dilute ammonia (1 in 3). Wash the precipitate off the filter with water acidified by a few drops of acetic acid. Dissolve with the aid of heat, adding a little more acetic acid if necessary. Add 5 c.c. of the acid solution of sodium acetate. Bring the volume up to 50 c.c., and estimate the phosphates in this volumetrically by the standard uranium nitrate as before. Subtract the phosphoric acid combined with the alkaline earths thus obtained from the total quantity of phosphoric acid, and the difference is the amount of acid combined with the alkalis, soda and potash.

<sup>1</sup> In using uranium nitrate it is imperative that sodium acetate should accompany the titration in order to avoid the possible occurrence of free nitric acid in the solution. If uranium acetate is used, it may be omitted.

(c) Instead of uranium nitrate, a standard solution of uranium acetate may be used. The directions for the making of these standard solutions will be found in Sutton's 'Volumetric Analysis.' As a rule, it is less troublesome, and not much more expensive, to purchase standard solutions ready made.

### ESTIMATION OF SULPHATES

The sulphates in the urine are of two kinds: the pre-formed sulphates—viz. those of soda and potash—and the combined or ethereal sulphates.

(a) For the determination of the total amount of sulphuric acid ( $\text{SO}_3$ ) (*i.e.* pre-formed and combined sulphuric acid together) in the urine, one of two methods is adopted:—

1. Volumetric method.
2. Gravimetric method.

Both methods will be given here: the former is, however, better suited for class experiments.

1. *Volumetric Determination.*—This process consists in adding to a given volume of the urine a standard solution of chloride of barium so long as a precipitate of barium sulphate is formed.

The following solutions are necessary:—

- i. Standard barium chloride solution: 30.5 grammes of crystallised chloride of barium in a litre of distilled water; 1 c.c. of this solution corresponds to 0.01 gramme of sulphuric acid ( $\text{SO}_3$ ).
- ii. Solution of sulphate of potash: 20 per cent.
- iii. Pure hydrochloric acid.

*Method.*—100 c.c. of urine are taken in a flask. This is rendered acid by 5 c.c. of hydrochloric acid, and boiled. The combined sulphates are thus converted into ordinary sulphates, and give a precipitate like them with barium chloride. The chloride of barium solution is allowed to drop into this mixture as long as any precipitate occurs, the mixture being heated before every addition of barium chloride to it. After adding 5 to 8 c.c. of the standard solution, allow the precipitate to settle; pipette off a few drops of the clear supernatant fluid into a watch-glass; add to it a few drops of the standard barium chloride solution. If any precipitate occurs, return the whole to the flask and add more barium chloride; again allow the precipitate to settle, and test as before; go on in this way until no more barium sulphate is formed on the addition of barium chloride.

Excess of barium chloride must also be avoided; when only a trace of excess is present a drop of the clear fluid removed from the precipitate gives a cloudiness with a drop of the potassium sulphate solution placed on a glass plate over a black ground. If more than a cloudiness appears, too large a quantity of barium chloride has been added and the operation must be repeated. From the quantity of barium chloride solution used, the percentage of sulphuric acid in the urine is calculated.

2. *Gravimetric Determination* (*i.e.* by weight).—This method consists in weighing the precipitate of barium sulphate obtained by adding barium chloride to a known volume of urine; 100 parts of sulphate of barium correspond to 34.33 parts of sulphuric acid ( $\text{SO}_3$ ).



*Method* (Salkowski).—100 c.c. of urine are taken in a beaker. This is boiled with 5 c.c. of hydrochloric acid as before.

Chloride of barium is added till no more precipitate occurs.

The precipitate is collected on a small filter of known ash, and washed with hot distilled water till no more barium chloride occurs in the filtrate—*i.e.* until the filtrate remains clear after the addition of a few drops of sulphuric acid. Then wash with hot alcohol, and afterwards with ether. Remove the filter, and place it with its contents in a platinum crucible. Heat to redness. Cool over sulphuric acid in a desiccator; weigh, and deduct the weight of the crucible and filter ash; the remainder is the weight of barium sulphate formed.

*Error*.—When the experiment is carried out as above there is a slight error from the formation of a small quantity of sulphide of barium. This may be corrected as follows:—After the platinum crucible has become cool add a few drops of pure sulphuric acid ( $H_2SO_4$ ). The sulphide is converted into sulphate. Heat again to redness to drive off excess of sulphuric acid.

(*b*) The following is Salkowski's method of estimating the *combined sulphuric acid*—that is, the amount of  $SO_3$  in ethereal sulphates:—100 c.c. of urine are mixed with 100 c.c. of alkaline barium chloride solution, which is a mixture of two volumes of solution of barium hydrate with one of barium chloride, both saturated in the cold. The mixture is stirred, and after a few minutes filtered: 100 c.c. of the filtrate (= 50 c.c. of urine) are acidified with 10 c.c. of hydrochloric acid, boiled, kept at  $100^\circ C$ . on the water-bath for an hour, and then allowed to stand till the precipitate has completely settled; if possible, it should be left in this way for twenty-four hours. The further treatment of this precipitate (= combined sulphates) is then carried out as in the last case.

*Calculation*.—233 parts of barium sulphate correspond to 98 parts of  $H_2SO_4$ , or 80 parts of  $SO_3$  or 32 parts of S. To calculate the  $H_2SO_4$ , multiply the weight of barium sulphate by  $\frac{98}{233} = 0.421$ ; to calculate the  $SO_3$ , multiply by  $\frac{80}{233} = 0.343$ ; to calculate the S multiply by  $\frac{32}{233} = 0.137$ . This method of calculation applies to the gravimetric estimation both of total sulphates and of combined sulphates.

(*c*) To obtain the amount of pre-formed sulphuric acid, subtract the amount of combined  $SO_3$  from the total amount of  $SO_3$ . The difference is the pre-formed  $SO_3$ .

Example: 100 c.c. of urine gave 0.5 gramme of total barium sulphate. This multiplied by  $\frac{80}{233} = 0.171$  gr. = total  $SO_3$ . Another 100 c.c. of the same urine gave 0.05 gr. of barium sulphate from ethereal sulphates; this multiplied by  $\frac{80}{233} = 0.017$  gr. of combined  $SO_3$ . Total  $SO_3$  - combined  $SO_3$  =  $0.171 - 0.017 = 0.154$  gr. of pre-formed  $SO_3$ .

## LESSON XXV

### URIC ACID AND CREATININE

1. **Preparation of Pure Uric Acid.**—If one wishes to prepare pure uric acid, the solid urine of a reptile or bird, which consists principally of the acid ammonium salt, should be selected; one has not then to separate any pigment. It is boiled with 10-per-cent. caustic soda or ammonia, diluted, and then allowed to stand. The clear fluid is decanted and poured into a large excess of water to which 10 per cent. of hydrochloric acid has been added; after twenty-four hours crystals of uric acid are deposited. These may be purified by washing, re-solution in soda, and re-precipitation by acid.

2. **Estimation of Uric Acid (Hopkins's method).**—The following reagents are required: Pure chloride of ammonium, finely powdered.

A wash-bottle containing a filtered saturated solution of the same salt.

A twentieth normal solution of potassium permanganate made by dissolving 1.581 grammes of permanganate in a litre of water.

Measure 100 c.c. of urine into a beaker of about 150 c.c. capacity.

Add to this 25 grammes (approximately weighed) of ammonium chloride, stirring briskly till all the salt is dissolved. Now add 2 c.c. of strong ammonia, and allow the mixture to stand until the precipitate of ammonium urate, which rapidly forms, has wholly settled to the bottom of the beaker its subsidence is promoted by occasional brisk stirring.

Adjust a small filter paper (7 cm. diam.) in a funnel of such size that only a small margin of glass projects above the edge of the folded paper, and transfer to this the ammonium urate precipitate.

Filtration should not be commenced until the precipitate has settled satisfactorily. The precipitate should be as far as possible retained in the beaker until the greater part of the clear liquid has filtered through; finally transfer the whole to the filter with the help of a wash-bottle containing saturated ammonium chloride solution. After the filter has thoroughly drained, wash the precipitate twice again with the same solution.

While the last washings are running through the paper, distilled water should be heated to boiling in a wash-bottle provided with a *fine* jet. The funnel containing the filter is now held horizontally over a small porcelain basin (of about 50 c.c. capacity) and the precipitate washed into the latter with a jet of hot water, the filter itself being afterwards opened out over the basin in order that any urate adhering to its folds may be washed off. Not more than 20–30 c.c. of water need be employed in this transference: if much more has been used the liquid should be concentrated over the water-bath at

this stage. A little strong HCl (1 c.c.) is next added to the contents of the basin, and the whole is then heated over a burner until it just reaches the boiling point. It is then set aside for the uric acid to crystallise out.

If the mixture is artificially cooled all the uric acid will separate out in two hours, otherwise it is best allowed to stand overnight or longer.

The crystals are filtered off through a very small filter paper (4 cm. diam.); the filtrate is received into a graduated cylinder so that the amount of mother liquid may be noted (see below). The uric acid is next washed with cold distilled water until free from chlorides. It is unnecessary to transfer the whole to the filter; the greater part may be washed by decantation. Such of the crystals as are upon the filter are now washed back into the basin (best by the aid of hot water) and the whole quantity is dissolved by heating to boiling with 1 c.c. of 10-per-cent. sodium carbonate solution and as much distilled water as the basin will safely hold.

The solution is transferred to a  $\frac{1}{4}$ -litre Erlenmeyer flask, which should be marked roughly at 100 c.c. The solution is made up to this mark with distilled water, and cooled to the temperature of the room.

Twenty c.c. of strong sulphuric acid are added to the contents of the flask, and the mixture shaken and titrated with the standard permanganate solution.

During the addition of the standard solution the liquid in the flask should be kept in vigorous movement. It will be found that at first the disappearance of the pink colour is so rapid that each drop as it is added is decolorised before it has time to *diffuse* through the whole liquid. The first instantaneous appearance of a diffused flush throughout the solution indicates the end point of the reaction. This colour rapidly disappears, but it will be found that the effect of adding further quantities of permanganate after the end point has been passed is quite different from the effect before the end point was reached; each drop is now able to diffuse throughout the fluid.

For each c.c. of the solution necessary to produce the end point just described 0.00375 gramme of uric acid is present. To the value so obtained 1 mgm. must be added for each 15 c.c. of the mother liquor from which the crystals separated. Thus the uric acid from 100 c.c. of a sample of urine used up 18.5 c.c. of the standard permanganate solution. The mother liquor filtered from crystals measured 25 c.c.

$$\begin{aligned} 18.5 \times .00375 &= .0694 \text{ gr.} \\ .001 \times \frac{25}{15} &= .0017 \\ \text{Total} &= .0711 \end{aligned}$$

The urine contained 71 mgms. uric acid per 100 c.c.

**3. Estimation of Creatinine.**—The following colorimetric method (Folin's) is now generally employed for the estimation of creatinine; and with a slight modification it may also be used for the estimation of creatine. It is based on the red colour which Jaffé showed develops when an alkaline solution of picric acid is added to a solution of creatinine; this is compared with the colour of a standard solution of potassium bichromate, the tint of the two fluids being almost identical. If creatine has to be estimated, this is

first transformed into creatinine by boiling with hydrochloric acid. The apparatus and reagents necessary are:—

1. A colorimeter consisting of two tubes, the height of the column in which can be read by graduations in tenths of a millimetre.

2. A half normal solution of potassium bichromate (24.5 grammes per litre).

3. A saturated solution of picric acid.

4. 10 per cent. caustic soda.

To perform the analysis one tube of the colorimeter is filled with the bichromate solution up to the height of 8 mm. Ten c.c. of urine are measured into a half-litre flask, 15 c.c. of the picric acid solution and 5 c.c. of the caustic soda solution added, and then water until the total volume of the mixture is 500 c.c. This solution is poured into the second tube of the colorimeter to such a height (which is read off) that, on looking down through it the intensity of the colour is the same as that in the standard tube by its side. The amount necessary for this corresponds exactly to 8.1 milligrammes of creatinine. From this the total in the sample of urine can be easily calculated.

## LESSON XXVI

### THE PIGMENTS OF THE URINE

The urinary pigments are numerous, and have from time to time been described under different names by various observers.

1. **Urochrome.**—This is the essential yellow pigment of the urine. The word was originally introduced by Thudichum, and the substance he obtained is now recognised to have been a mixture of several pigments, of which, however, the essential yellow pigment formed a large proportion. Garrod's method of separating it from the urine is as follows:—

The urine is saturated with ammonium sulphate and filtered. The filtrate contains the pigment; this is shaken with alcohol. The alcohol separates readily from the saline mixture, and as it does so dissolves out much of the urochrome. By repeated extraction all the pigment passes into solution in the alcohol. The alcoholic solution is diluted with water, and the mixture again saturated with ammonium sulphate. The alcohol containing the pigment in solution again separates out. The second alcoholic solution is made faintly alkaline with ammonia and evaporated to dryness. The residue is extracted once or twice with acetic ether, and then again dissolved in strong alcohol. Finally the alcohol is concentrated till it is deep orange in tint, and poured into an equal volume of ether. The pure pigment is by this means precipitated as an amorphous brown powder.

Urochrome shows no absorption bands. As already stated (p. 143), it is probably an oxidation product of urobilin.

2. **Urobilin.**—Urobilin is a derivative of the blood-pigment, and is identical with stercobilin (see pp. 92, 143). Probably both reduction and hydration occur in its formation. It is very like the substance named hydrobilirubin by Maly, which he obtained by the action of sodium amalgam on bilirubin. The following formulæ show the relationship between these allied pigments:—

Hæmatin . . . . .	$C_{32}H_{32}N_4O_4Fe$
Bilirubin . . . . .	$C_{32}H_{36}N_4O_6$
Hydrobilirubin . . . . .	$C_{32}H_{40}N_4O_7$

Urobilin is probably a further stage in reduction.

Normal urine contains but little urobilin; what is present is chiefly in the form of a colourless chromogen, which by oxidation is converted into urobilin. In numerous pathological conditions urobilin is abundant.

The following are the two methods introduced by Garrod and Hopkins for its separation from the urine:—

(a) The urine is first saturated with ammonium chloride, and the urate

so precipitated is filtered off. The filtrate is then acidified with sulphuric acid and saturated with ammonium sulphate. This causes a precipitate of urobilin, which may be collected and dissolved in water. The aqueous solution is again saturated with ammonium sulphate, and the pigment is thus precipitated in a state of purity.

(b) The urates are first removed, then the urine is acidified and saturated with ammonium sulphate as before. The urobilin is then extracted from the mixture by shaking it with a mixture of chloroform and ether (1 : 2) in a large separating funnel. The ether-chloroform extract is then rendered faintly alkaline and shaken with distilled water, and the urobilin passes into solution in the water. The aqueous solution is now once more saturated with ammonium sulphate and slightly acidified; it then once more yields its pigment to ether-chloroform.

By means of either of these methods urobilin is obtained in a pure condition; even normal urine will give some, for the chromogen is partly converted into the pigment by the acid employed.

Urobilin dissolved in alcohol exhibits a green fluorescence, which is greatly increased by the addition of zinc chloride and ammonia. It shows a well-marked absorption band between *b* and F, slightly overlapping the latter (fig. 63, spectrum 4).

Urobilin, like most animal pigments, shows acidic tendencies and forms compounds with bases; it is liberated from such combinations by the addition of an acid.

If urobilin is dissolved in caustic potash or soda, and sufficient sulphuric or hydrochloric acid is added to render the liquid faintly acid, a turbidity is produced. This turbid liquid shows an additional band in the region of the E line (fig. 63, spectrum 6), which is probably due to the special light absorption exercised by fine particles of urobilin in suspension. It wholly disappears when the precipitate is filtered off, and when it is re-dissolved the ordinary band alone is visible.

**3. Uroerythrin.**—This is the colouring matter of pink urate sediments. It may be separated from the sediment as follows:—The deposit is washed with ice-cold water, dried, and placed in absolute alcohol. The alcohol, though a solvent for uroerythrin, does not extract it from the urates. The alcohol is poured off, and the deposit dissolved in warm water. From this solution the pigment is easily extracted by amylie alcohol.

Uroerythrin has a great affinity for urates, with which it appears to form a loose compound. Its solutions are rapidly decolorised by light. Spectroscopically it shows two rather ill-defined bands (fig. 63, spectrum 7). It gives a green colour with caustic potash, and red or pink with mineral acids. Uroerythrin appears to be a small but constant constituent of urine. Its origin and relationship to other pigments are unknown.

**4. Hæmatoporphyrin.**—This also occurs in small quantities in normal urine. In some pathological conditions, especially after the administration of certain drugs (*e.g.* sulphonal), its amount is increased. Its amount is stated to increase when the urine stands; this points to the existence of a colourless chromogen. It may be separated from the urine as follows:—Caustic alkali is added to the urine; this causes a precipitate of phos-

phates, which carries down the pigment with it: the pigment may be dissolved out with chloroform. The chloroform is evaporated, the residue washed with alcohol, and finally dissolved in acidified alcohol. Urines rich in the pigment yield it easily to acetic ether or to amyl alcohol.

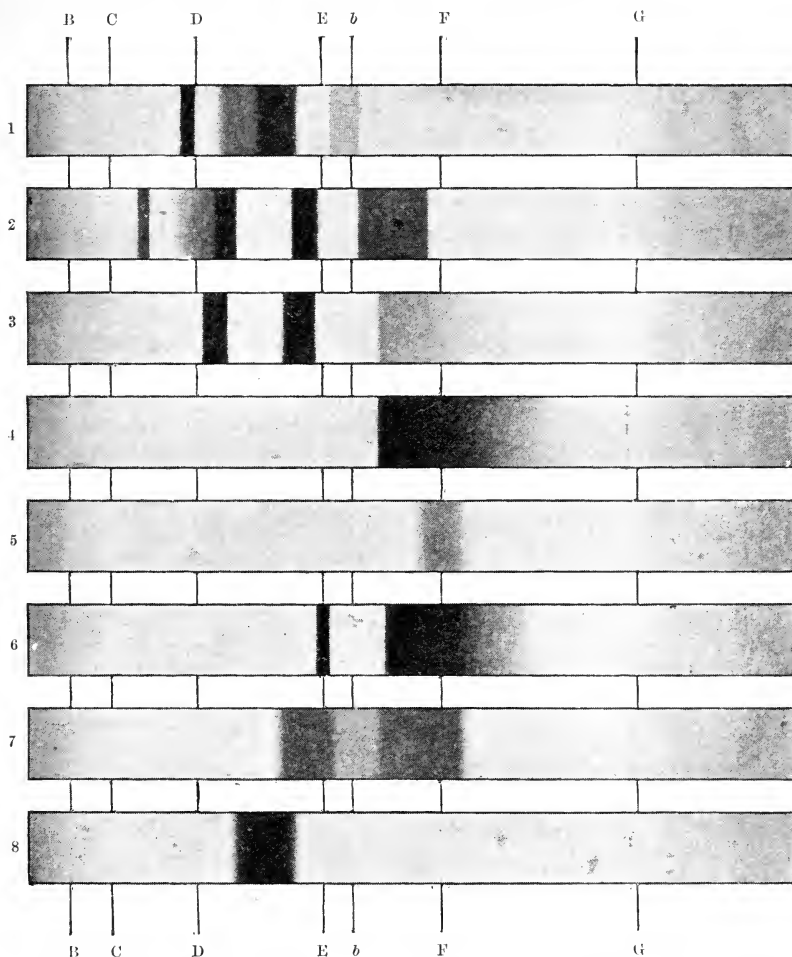
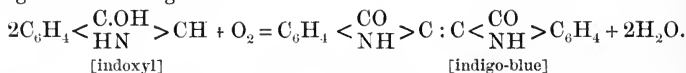

FIG. 63.—Chart of absorption spectra: 1, acid hæmatoporphyrin; 2, alkaline hæmatoporphyrin; 3, hæmatoporphyrin as found sometimes in urate sediments; 4, acid urobilin, concentrated; 5, acid urobilin, dilute; 6, the E band spectrum of urobilin; 7, uroerythrin; 8, uroresin concentrated—on dilution the band shrinks rapidly from redward end. (After F. G. Hopkins.)

When the urine is sufficiently rich in the pigment, the bands shown are those of alkaline hæmatoporphyrin (fig. 63, spectrum 2). On adding sulphuric acid the spectrum of acid hæmatoporphyrin is seen (fig. 63, spectrum 1). Occasionally urate sediments are pigmented with a form of the pigment which shows a two-banded spectrum, very like that of oxyhæmoglobin (fig. 63,

spectrum 3); by treatment with dilute mineral acids this changes immediately to the spectrum of acid hæmatoporphyrin.

5. **Chromogens in Urine.**—In addition to the chromogens of urobilin and hæmatoporphyrin alluded to in the foregoing paragraphs there are others, of which the following may be mentioned:—(a) *Indoxyl*.—The origin of this substance from indole is mentioned on p. 154. It is easily oxidised to indigo-blue or indigo-red.



Indigo-red is isomeric with indigo-blue, its structural formula being  $\text{C}_6\text{H}_4 < \begin{array}{c} \text{CO} \\ \text{NH} \end{array} > \text{C} : \text{C} < \begin{array}{c} \text{C.OH} \\ \text{C}_6\text{H}_4 \end{array} > \text{N}$ . It is very rare for the urine to be actually pigmented with indigo, for the urinary indoxyl is excreted as a conjugated sulphate which resists oxidation. When the urine is mixed with an equal volume of hydrochloric acid, indoxyl is liberated from the sulphate. A solution of a hypochlorite is then added drop by drop, when indigo-blue is formed, and on shaking the mixture with chloroform the indigo-blue passes into the chloroform. (Jaffé.) This test, however, is not a very good one, for the hypochlorite solution has always to be freshly prepared, and even then a small excess will cause the colour to disappear owing to oxidation of the indigo, and it is difficult to hit off the exact amount to give the reaction. A better test for indoxyl-sulphuric acid (indican) consists in adding 10 c.c. of a 20-per-cent. solution of lead acetate to 50 c.c. of urine, and filtering the mixture. The filtrate is shaken with an equal volume of hydrochloric acid (containing 0.2 to 0.4 per cent. of ferric chloride) and a few c.c. of chloroform. The indigo-blue passes into the chloroform (Obermayer.) (b) *Skatoxyl*.—When skatoxyl is given by the mouth it passes into the urine, and yields skatoxyl-red on oxidation. (c) *Uroroscin* is distinct from indigo-red. It is produced from its chromogen by the action of mineral acids. It frequently appears when urine is treated with strong hydrochloric acid and allowed to stand, but it appears more readily when an oxidising agent is added as well. It is readily soluble in amylic alcohol, but not in ether. The chromogen is precipitated by saturation with ammonium sulphate. The colour is destroyed by alkalis. It shows an absorption band between the D and E lines (fig. 63, spectrum 8).

6. **Pathological Pigments.**—The most frequently appearing of abnormal pigments are those of blood and bile. The urine may contain accidental pigments due to the use of drugs (rhubarb, senna, logwood, santonin); in carbolic acid poisoning pyrocatechin and hydrochinon are chiefly responsible for the greenish-brown colour of the urine, which increases on exposure to the air. The black or dark-brown pigment called melanin may pass into the urine in cases of melanotic sarcoma. For alcaptonuria see p. 169.



# APPENDIX

## HÆMACYTOMETERS

**Gowers's Hæmacytometer.**—The enumeration of the blood corpuscles is readily effected by the hæmacytometer of Gowers. This instrument consists of a glass slide (fig. 64, C), the centre of which is ruled into  $\frac{1}{10}$  millimetre squares and surrounded by a glass rim  $\frac{1}{2}$  millimetre thick. It is provided with measuring pipettes (A and B), a vessel (D) for mixing the blood with a saline solution (sulphate of soda of specific gravity 1015), a glass stirrer (E), and a guarded needle (F).

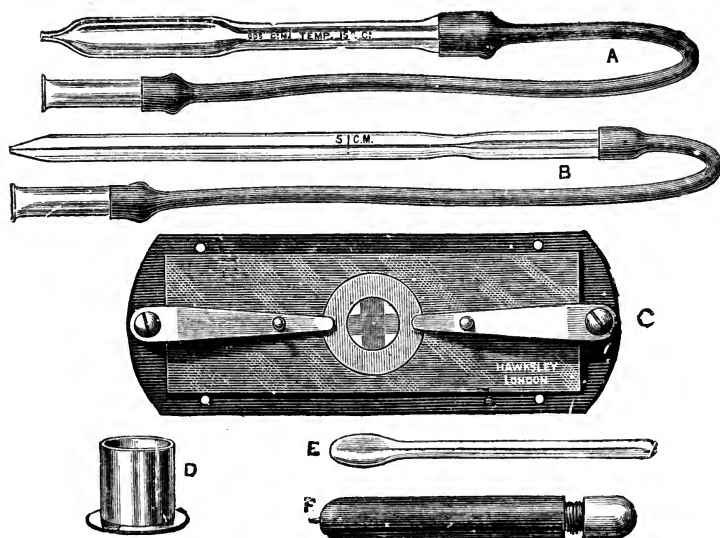

FIG. 64.—Hæmacytometer of Sir W. Gowers.

Nine hundred and ninety-five cubic millimetres of the saline solution are measured out by means of A, and then placed in the mixing jar; 5 cubic millimetres of blood are then drawn from a puncture in the finger by means of the pipette B, and blown into the solution. The two fluids are well mixed by the stirrer, and a small drop of this diluted mixture placed in the

centre of the slide C, a cover glass is gently laid on (so as to touch the drop, which thus forms a layer  $\frac{1}{2}$  millimetre thick between the slide and cover glass), and pressed down by two brass springs. In a few minutes the corpuscles have sunk to the bottom of the layer of fluid, and rest on the squares. The number on ten squares is then counted, and this multiplied by 10,000 gives the number in a cubic millimetre of blood. The average number of red corpuscles in each square ought therefore in normal human blood to be 45-50.

Differential counts to show the relative proportions of the varieties of leucocytes are made in appropriately stained specimens.

**Oliver's Hæmacytometer.**—The following method, devised by Dr. George

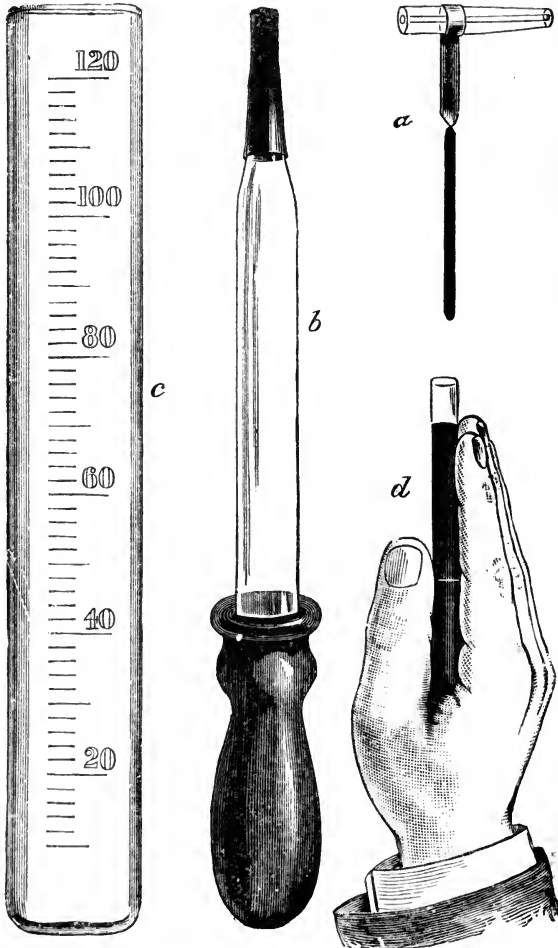

FIG. 65.—Oliver's hæmacytometer.

Oliver, is a ready way of determining the total number of corpuscles. It is, however, not possible to determine the relative proportion of red and white corpuscles by this means.

The finger is pricked, and the blood allowed to flow into the small capillary pipette (fig. 65, *a*) until it is full. This is washed out by the dropping tube *b* into a graduated flattened test-tube, *c*, with Hayem's fluid.<sup>1</sup> The graduations of the tube are so adjusted that with normal blood containing 5,000,000 coloured corpuscles per cubic millimetre, the light of a small wax candle placed at a distance of 9 feet from the eye in a dark room is just transmitted as a fine bright line when looked at through the tube held edgewise between the fingers (*d*) and filled up to the 100 mark of the graduation. If the number of corpuscles is less than normal, less of the diluting solution is required for the light to be transmitted; if above the normal, more of the Hayem's fluid must be added. The tube is graduated, so as to indicate in percentages the decrease or increase of corpuscles per cubic millimetre as compared with the normal standard of 100 per cent.

### HÆMOGLOBINOMETERS

**Gowers's Hæmoglobinometer.**—The apparatus consists of two glass tubes, C and D, of the same size. D contains glycerin jelly tinted with carmine to a standard colour—viz., that of normal blood diluted 100 times with distilled water. The finger is pricked and 20 cubic millimetres of blood are measured

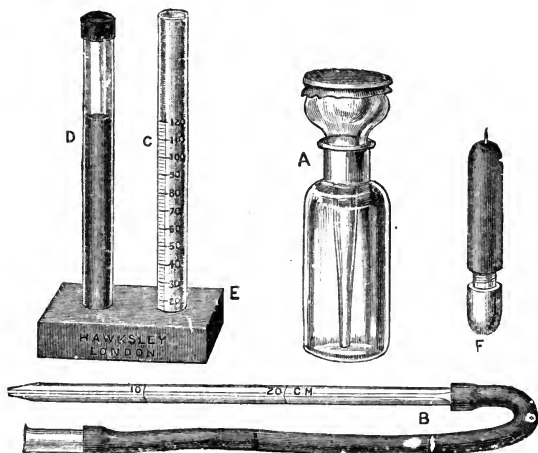

FIG. 66.—Hæmoglobinometer of Sir W. Gowers.

out by the capillary pipette, B. This is blown out into the tube C, and diluted with distilled water, added drop by drop from the pipette stopper of the bottle, A, until the tint of the diluted blood reaches the standard colour. The tube C is graduated into 100 parts. If the tint of the diluted blood is the

<sup>1</sup> Sodium sulphate 5 grammes, sodium chloride 1 gm., mercuric chloride 0.5 gm., distilled water 200 c.c.

same as the standard when the tube is filled up to the graduation 100, the quantity of oxyhæmoglobin in the blood is normal. If it has to be diluted more largely, the oxyhæmoglobin is in excess; if to a smaller extent, it is less than normal. If the blood has, for instance, to be diluted up to the graduation 50, the amount of hæmoglobin is only half what it ought to be—50 per cent. of the normal—and so for other percentages.

**Haldane's Hæmoglobinometer** is more frequently used. Instead of tinted gelatin, the standard of comparison is a sealed tube filled with a solution of carbonic oxide hæmoglobin of known strength. This keeps unchanged for years. A stream of coal gas is passed through the blood to be examined. This converts all the hæmoglobin present into carboxyhæmoglobin; this is then diluted with water to match the standard.

**Von Fleischl's Hæmometer.**—The apparatus (fig. 67) consists of a stand bearing a white reflecting surface (S) and a platform. Under the platform is

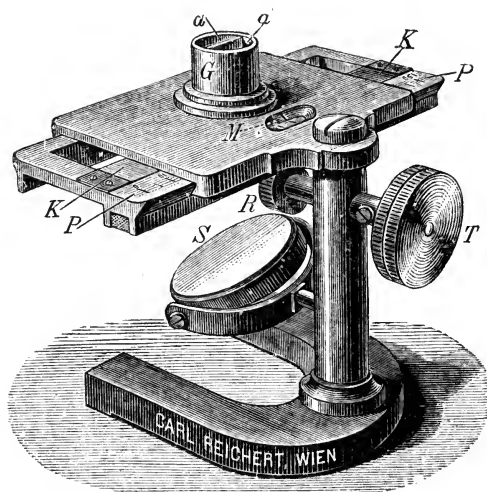

FIG. 67.—Von Fleischl's hæmometer.

a slot carrying a glass wedge stained red (K) and moved by a wheel (R). On the platform is a small cylindrical vessel divided vertically into two compartments, *a* and *a'*.

Fill with a pipette the compartment *a'* over the wedge with distilled water. Fill about a quarter of the other compartment (*a*) with water.

Prick the finger and fill the short capillary pipette provided with the instrument with blood. Dissolve this in the water in compartment *a*, and fill it up with distilled water. Having arranged the reflector (S) to throw *artificial* light vertically through both compartments, look down through them, and move the wedge of glass by the milled head (T) until the colour in the two is identical. Read off the scale, which is so constructed as to give the percentage of hæmoglobin.

**Oliver's Hæmoglobinometer.**—This method consists in comparing a speci-

men of blood, suitably diluted with water in a shallow white palette, with a number of standard tests very carefully prepared by the use of

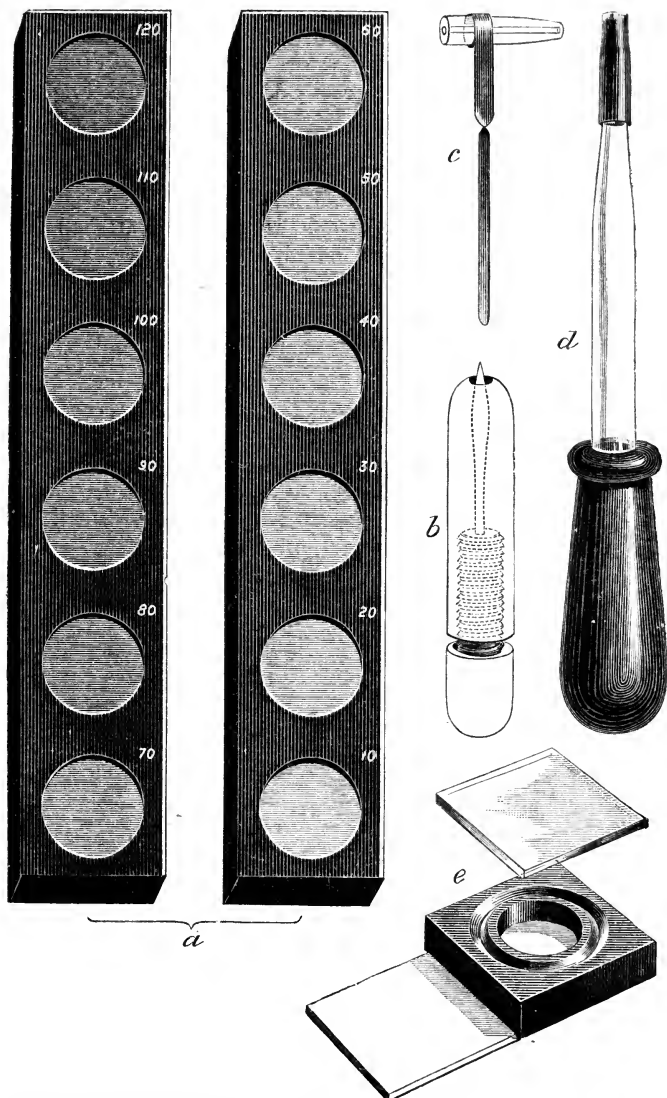

FIG. 68.— Oliver's hæmoglobinometer : *a*, standard gradations ; *b*, lancet ; *c*, capillary measuring pipette ; *d*, mixing pipette ; *e*, blood cell and cover glass.

Lovibond's coloured glasses. The capillary pipette *c* (fig. 68) is first filled with blood obtained by pricking the finger. This is washed with water

by the mixing pipette *d* into the blood cell *e*; the cell is then just filled with water, and the blood and water thoroughly mixed by the handle of *e* being used as a stirrer. The cover glass is then adjusted, when a small bubble should form, a clear sign that the cell has not been overfilled. The cell is then placed by the side of the standard gradations, and the eye quickly recognises its approximate position on the scale. The camera tube provided with the instrument will more accurately define it. Artificial light should be used.

If it is proved that the blood solution is matched in depth of colour by one of the standard grades, the observation is at an end; but if the tint is higher than one grade, but lower than another, the blood cell is placed opposite to the former, and riders (not shown in the illustration) are added to complete the observation. The standard gradations are marked in percentages, 100 per cent. being taken as normal.

'Worth' of the Corpuscles.—If the percentage of hæmoglobin is 100, and the percentage number of corpuscles is 100 also, then the quotient  $\frac{100}{100} = 1$  is taken as the normal. This varies in health from 0.95 to 1.05 in men, and from 0.9 to 1 in women. This quotient has been termed the 'worth' of the corpuscle.

**Specific Gravity of Blood.**—Of the numerous methods introduced for taking the specific gravity of fresh blood, that of Hammerschlag is the simplest. A drop of blood from the finger is placed in a mixture of chloroform and benzene. If the drop falls, add chloroform till it just begins to rise; if the drop rises, add benzene till it just begins to fall. The fluid will then be of the same specific gravity as the blood. Take the specific gravity of the mixture in the usual way with an accurate hydrometer.

Schmalz's capillary pycnometer is more accurate.

### POLARISATION OF LIGHT

If an object, such as a black dot on a piece of white paper, be looked at through a crystal of Iceland spar, two black dots will be seen; and if the crystal be rotated, one black dot will move round the other, which remains stationary. That is, each ray of light entering such a crystal is split into two rays, which travel through the crystal with different velocities, and consequently one is more refracted than the other. One ray travels just as it would through glass; this is the *ordinary ray*, the ray which gives the stationary image; the other ray gives the movable image when the crystal is rotated; the ordinary laws of refraction do not apply to it, and it is called the *extraordinary ray*. Both rays are of equal brilliancy. In one direction, however, that of the optic axis of the crystal, a ray of light is transmitted without double refraction.

Ordinary light, according to the wave theory, is due to vibrations occurring in all planes transversely to the direction of the propagation of the wave. Light is said to be plane polarised when the vibrations take place all in one plane. The two rays produced by double refraction are both polarised, one in one plane, the other in a plane at right angles to this one. Doubly refract-

ing bodies are called *anisotropic*; singly refracting bodies, *isotropic*. The effect of polarisation may be very roughly illustrated by a model.

If a string be stretched as in the figure, and then touched with the finger, it can be made to vibrate, and the vibrations will be free to occur from above down, or from side to side, or in any intermediate position. If, however, a disc with a vertical slit be placed on the course of the string, the vibrations will all be obliged to take place in a vertical plane, any side to side movement being stopped by the edges of the slit<sup>1</sup> (fig. 69).

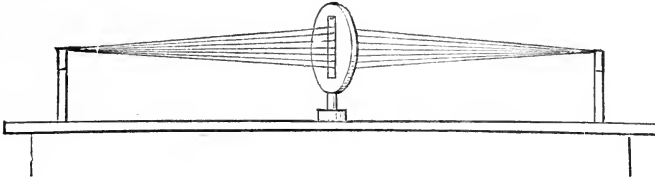

FIG. 69.

Light can be polarised not only by the action of crystals, but by reflection from a surface at an angle which varies for different substances (glass  $54^{\circ} 35'$ , water  $52^{\circ} 45'$ , diamond  $68^{\circ}$ , quartz  $57^{\circ} 32'$ , &c.). It is also found that certain non-crystalline substances, like muscle, cilia, &c., are doubly refracting.

**Nicol's Prism** is the *polariser* usually employed in polariscopes; it consists of a rhombohedron of Iceland spar divided into two by a section through its obtuse angles. The cut surfaces are polished and cemented together in their former position with Canada balsam. By this means the

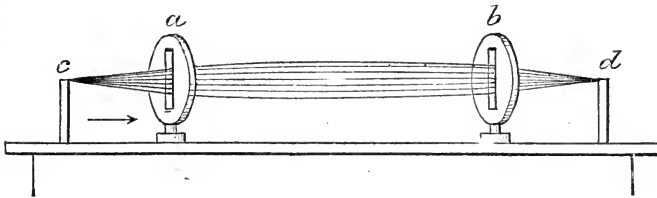

FIG. 70.

ordinary ray is totally reflected through the Canada balsam; the extraordinary ray passes on and emerges in a direction parallel to the entering ray. In this polarised ray there is nothing to render its peculiar condition visible to the naked eye; but if the eye is aided by a second Nicol's prism, which is called the *analyser*, it is possible to detect the fact that it is polarised.

This may be again illustrated by reference to our model (fig. 70).

Suppose that the string is made to vibrate, and that the waves travel in the direction of the arrow. From the fixed point *c* to the disc *a*, the string

<sup>1</sup> Such a model is, of course, imperfect; it does not, for instance, represent the splitting of the ray into two, and moreover the polarisation takes place on each side of the slit; whereas, in regard to light, it is only the rays on one side of a polariser, viz. those that have passed through it, which are polarised.

is theoretically free to vibrate in any plane;<sup>1</sup> but after passing through the vertical slit in *a*, the vibrations must all be vertical also; if a second similar disc *b* be placed further on, the vibrations will also pass on freely to the other extremity of the string *d*, if as in the figure (fig. 70) the slit in *b* be also placed vertically. If, however, *b* is so placed that its slit is horizontal (fig. 71) the vibrations will be extinguished on reaching *b*, and the string between *b* and *d* will be motionless.

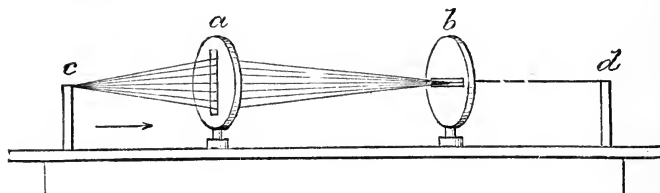

FIG. 71.

*c* here represents a source of light; the vibrations of the string represent the undulations which by the Nicol's prism *a* are polarised so as to occur in one plane only; if the second Nicol's prism or the analyser *b* is parallel to the first, the vibrations will pass on to the eye, which is represented by *d*; but if the planes of the two nicols are at right angles, the vibrations allowed to pass through the first are extinguished by the second, and so no light reaches the eye. In intermediate positions, *b* will allow only some of the light to pass through it. It must be clearly understood that a Nicol's prism contains no actual slits, but the arrangement of its molecules is such that their action on the particles of æther may be compared to the action of slits in a diaphragm to vibrations of more tangible materials than æther.

The **Polarising Microscope** consists of an ordinary microscope with certain additions; below the stage is the polarising nicol; in the eye-piece is the analysing nicol; the eye-piece is so arranged that it can be rotated; thus the directions of the two nicols can be made parallel, and then the field is bright; or crossed, and then the field is dark. The stage of the microscope is arranged so that it can also be rotated.

The polarising microscope is used to detect doubly-refracting substances. Let the two nicols be crossed, so that the field is dark; interpose between the two, that is, place upon the stage of the microscope a doubly-refracting plate of which the principal plane is parallel to the first prism or polariser; the ray from the first prism is unaffected by the plate, but will be extinguished by the second; the field therefore still remains dark. If the plate is parallel to the second nicol the field is also dark; but in any intermediate position the light will be transmitted by the second nicol. In other words, if between two crossed nicols, which consequently appear dark, a substance be interposed which in certain positions causes the darkness to give place to illumination, that substance is doubly refractive. How this takes place may be explained as follows:—

Let  $N_1N_1$  (fig. 72) represent the direction of the principal plane of the first nicol, and  $N_2N_2$  that of the second. They are at right angles, and so

<sup>1</sup> The imperfection of the model has been explained in the preceding footnote.



the ray transmitted by the first will be extinguished by the second. Let PP represent the principal plane of the interposed doubly-refractive plate. The extraordinary ray transmitted by  $N_1N_1$  vibrates in the plane  $N_1N_1$ , and falls obliquely on the plate PP; it is by this plate itself split into two rays, an ordinary and an extraordinary one, at right angles to one another, one vibrating in the plane PP, the other in the plane  $P^1P^1$ . These two rays meet the second nicol, which can only transmit vibrations in the plane  $N_2N_2$ . The vibrations in PP can be resolved into a vibration in  $N_1N_1$  and a vibration in  $N_2N_2$ ; the former is extinguished, the latter transmitted. Similarly the vibration in  $P^1P^1$  can be resolved into two sub-rays in  $N_1N_1$  and  $N_2N_2$  respectively, the latter only being transmitted. The illumination is thus due to two sub-rays, one of the vibrations in PP, the other of those in  $P^1P^1$  which have been made to vibrate in  $N_2N_2$ .

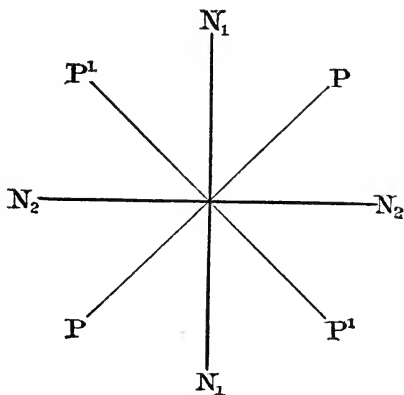

FIG. 72.

Now, although these two sub-rays vibrate in the same plane, they are of different velocities; hence the phases of the vibrations do not coincide, and thus the phenomena of interference are obtained. If we have two sets of vibrations fused, the crest of one wave may coincide with the crest of the other, in this case the wave will be higher; or the crest of one may coincide with the hollow of the other, that is, the undulation would be extinguished; in other intermediate cases, the movement would be interfered with, either helped or hindered, more or less. Interference in the case of many kinds of doubly-refracting substances (Iceland spar is in this an exception) shows itself in the extinction of certain rays of the white light, and the light seen through the second nicol is white light *minus* the extinguished rays; those extinguished and those transmitted will together form white light, and are thus complementary. Moreover, the rays extinguished in one position of the plate will be transmitted in one at right angles and *vice versa*; thus a crystal showing these phenomena of *pleochromatism*, as it is termed, will transmit one colour in one position, and the complementary colour in a position at right angles to the first; blue and yellow, and red and green, are the pairs of colours most frequently seen in this way.

**Rotation of the Plane of Polarisation.**—Certain crystals such as those of quartz, and certain fluids such as the essence of turpentine, aniseed, &c., and solutions of certain substances like sugar and albumin, have the power of rotating the plane of polarised light to the right or left. The polarisation of light that is produced by a quartz crystal is different from that produced by a rhombohedron of Iceland spar. The light that passes through the latter is plane polarised; the light that passes through the former (quartz) is circularly polarised, *i.e.* the two sub-rays are made up of vibrations

which occur not in a plane, but are curved. The two rays are circularly polarised in opposite directions, one describing circles to the left, the other to the right; these unite on issuing from the quartz plate; and the net result is a plane polarised ray with the plane rotated to right or left according as the right circularly polarised ray or the left proceeded through the quartz with the greater velocity. There are two kinds of quartz, one which rotates the plane to the right (dextro-rotatory), the other to the left (lævo-rotatory).

Gordon explains this by the following mechanical illustration. Ordinary light may be represented by a wheel travelling in the direction of its axle, and the vibrations composing it executed along any or all of its spokes (*a*). If the vibrations all take place in the same direction, *i.e.* along one spoke, and the spoke opposite to it (*b*), the light is said to be plane polarised. The two spokes as they travel along in the direction of the arrow will trace out a plane (see fig. 73) between *b* and *b'*. If this polarised beam be made to

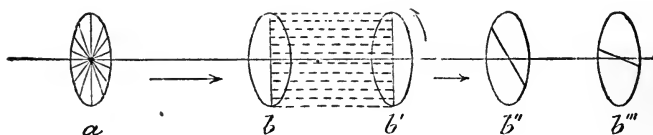

FIG. 73.

travel now through a solution of sugar, the net result is that the plane so traced out is twisted or rotated; the two spokes, as in *bb'*, do not trace out a plane, but we must consider that they rotate as they travel along, as though guided by a spiral or screw thread cut on the axis, so that after a certain distance the vibrations take place as in *b''*; later in *b'''*, and so on. This effect on polarised light is due to the molecules in solution, and the amount of rotation will depend on the strength of the solution, and on the length of the column of the solution through which the light passes, or, in the case of a quartz plate, on its thickness.

If a plate of quartz be interposed between two nicols, the light will not be extinguished in any position of the prisms, but will pass through various colours as rotation is continued. The rotation produced for different kinds of light being different, white light is split into its various constituent colours; and the angle of rotation that causes each colour to disappear is constant for a given thickness of quartz plate, being least for the red and greatest for the violet. These facts are made use of in the construction of polarimeters. Polarimeters are instruments for determining the strength of solutions of sugar, albumin, &c., by the direction and amount of rotation they produce on the plane of polarised light. They are often called saccharimeters, as they are specially useful in the estimation of sugar.

### POLARIMETERS

**Soleil's Saccharimeter.**—This instrument (see fig. 74) consists of a Nicol's prism, *d*, called the polariser: this polarises the light entering it, and the polarised beam then passes through a quartz plate (*b* in fig. 74), 3.75 mm.

thick, one half of which ( $d$  in fig. 75) is made out of dextro-rotatory, the other half ( $g$  in fig. 75) of lævo-rotatory quartz.

The light then passes through the tube containing the solution in the position of the dotted line in fig. 74, then through a quartz plate cut perpendicularly to its axis ( $q$  in fig. 75), then through an arrangement called a compensator ( $r$  in fig. 75), then through a second nicol called the analyser, and lastly through a telescope (L in fig. 75).

The compensator consists of two quartz prisms ( $RR'$ , fig. 75) cut perpendicularly to the axis, but of contrary rotation to the plate just in front of

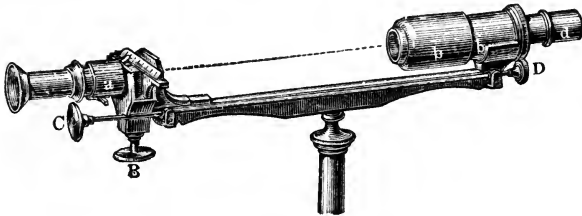

FIG. 74.—Soleil's saccharimeter.

them. These are wedge-shaped, and slide over each other, the sharp end of one being over the blunt end of the other. By a screw the wedges may be moved from each other, and this diminishes the thickness of quartz interposed; if moved towards each other the amount of quartz interposed is increased.

The effect of the quartz plate ( $d, g$ ) next to the polariser ( $i$  in fig. 75) is to give the polarised light a violet tint when the two nicols are parallel to each other. But if the nicols are not parallel, or if the plane of the polarised light has been rotated by a solution in the tube, one half the field will change

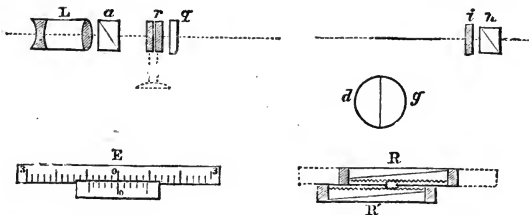

FIG. 75.—Diagram of optical arrangements in Soleil's saccharimeter.

in colour to the red end, the other to the violet end of the spectrum, because the two halves of the quartz act in the opposite way.

The instrument is first adjusted with the compensator at zero, and the nicols parallel, so that the whole field is of one colour. The tube containing the solution is then interposed; and if the solution is optically inactive the field is still uniformly violet. But if the solution is dextro-rotatory the two halves will have different tints; a certain thickness of the compensating quartz plate which is lævo-rotatory must be interposed to make the tint of the two halves of the field equal again; the thickness so interposed can be read off in amounts corresponding to degrees of a circle by means of a vernier

and scale (E in fig. 75) worked by the screw which moves the compensator. If the solution is lævo-rotatory, the screw must be turned in the opposite direction.

**Zeiss's polarimeter** is in principle much the same as Soleil's; the chief difference is that the rotation produced by the solution is corrected, not by a quartz compensator, but by actually rotating the analyser in the same direction, the amount of rotation being directly read off in degrees of a circle.

**Laurent's polarimeter** is a more valuable instrument. Instead of using daylight, or the light of a lamp, monochromatic light (a sodium flame pro-

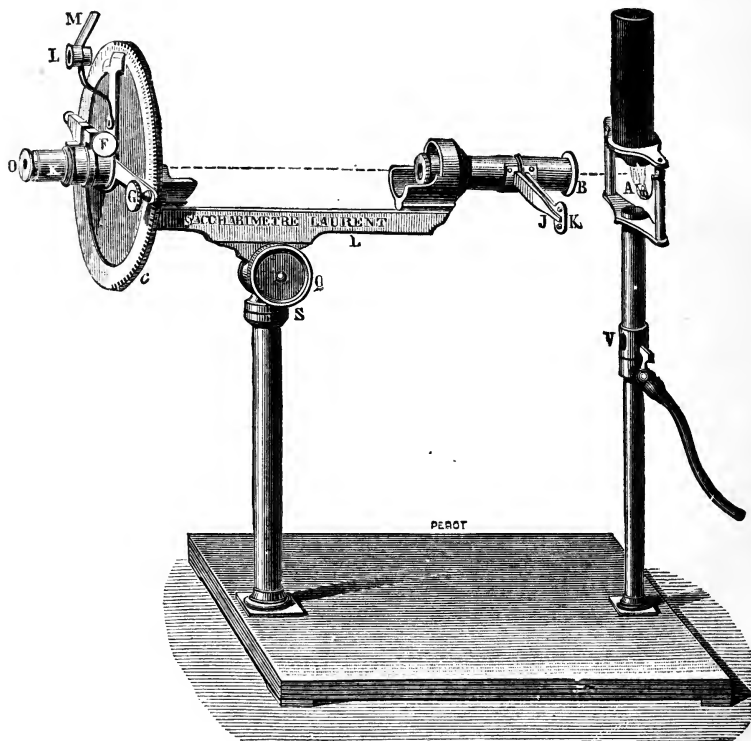

FIG. 76.—Laurent's polarimeter.

duced by volatilising common salt in a colourless gas flame) is employed; the amount of rotation varies for different colours; and observations are recorded as having been taken with light corresponding to the D or sodium line of the spectrum. The essentials of the instrument are, as before, a polariser, a tube for the solution, and an analyser. The polarised light before passing into the solution traverses a quartz plate, which, however, covers only half the field, and retards the rays passing through it by half a wave-length. In the  $0^\circ$  position the two halves of the field appear equally

illuminated: in any other position, or if rotation has been produced by the solution when the nicols have been set at zero, the two halves appear unequally illuminated. This is corrected by means of a rotation of the analyser that can be measured in degrees by a scale attached to it.

The **specific rotatory power** of any substance is the amount of rotation in degrees of a circle of the plane of polarised light produced by 1 gramme of the substance dissolved in 1 c.c. of liquid examined in a column 1 decimetre long.

If  $\alpha$  = rotation observed.

$w$  = weight in grammes of the substance per cubic centimetre.

$l$  = length of tube in decimetres.

$[\alpha]_D$  = specific rotation for light with wave-length corresponding to the D line (sodium flame).

$$\text{Then } [\alpha]_D = \pm \frac{\alpha}{wl}.$$

In this formula + indicates that the substance is dextro-rotatory, - that it is lævo-rotatory.

If, on the other hand,  $[\alpha]_D$  is known, and we wish to find the value of  $w$ , then

$$w = \frac{\alpha}{[\alpha]_D \times l}.$$

#### THE SPECTRO-POLARIMETER

This instrument is one in which a spectroscope and polarising apparatus are combined for the purpose of determining the concentration of substances

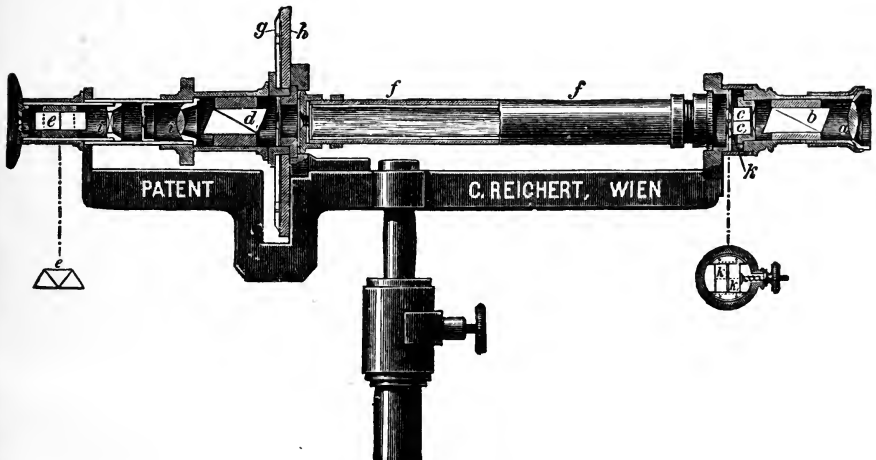

FIG. 77.—Spectro-polarimeter of v. Fleischl.

which rotate the plane of polarised light. It was invented by E. v. Fleischl for the estimation of sugar in diabetic urine. Its chief advantage is that no difficulty arises in forming a judgment as to the identity of two coloured

surfaces, as in Soleil's saccharimeter, or of two shades of the same colour, as in Laurent's instrument. The light enters at the right-hand end of the instrument, is polarised by the Nicol's prism *b*, and then passes through two quartz plates, *cc*, placed horizontally over each other. One of these plates is dextro-, the other lævo-rotatory, and they are of such a thickness (7.75 mm.) that the green rays between the E and *b* lines of the spectrum are circularly polarised through an angle of 90°, the one set passing off through the upper quartz to the left, the other through the lower to the right. The light then continues through a long tube, *ff*, which contains 15 c.c. of the solution under examination. It then passes through an analysing nicol *d*, and finally through a direct-vision spectroscope, *e*. On looking through the instrument, the tube *ff* being empty or filled with water or some other optically inert substance, two spectra are seen, one over the other, but each shows a dark band between E and *b* owing to the extinction of these rays by the circular polarisation, produced by the quartz. The analyser can be rotated: a vernier, *g*, is attached to, and moves with it, round a circular disc (seen in section at *h*) graduated in degrees. The two bands in the spectra coincide when the zeros of vernier and scale correspond. If now the tube *f* is filled with an optically active substance like sugar, the bands are shifted, one to the right, the other to the left, according to the direction of rotation of the substance in *f*. The rotation is corrected by rotating the analyser into such a position that the two bands exactly coincide once more as to vertical position. The number of degrees through which it is thus necessary to move the analyser measures the amount of rotation produced by the substance in *f*, and is a measure of the concentration of the solution. The degrees marked on the circular scale are not degrees of a circle, but an arbitrary degree of such a length that each corresponds to 1 per cent. of sugar in the given length of the column of fluid in *ff* (177.2 mm.).

#### RELATION BETWEEN CIRCULAR POLARISATION AND CHEMICAL CONSTITUTION

The first work in this direction was performed by Pasteur, and it was his publications on this subject that brought him into prominence. He found that racemic acid, which is optically inactive, can be decomposed into two isomerides, one of which is common tartaric acid which is dextro-rotatory, and the other tartaric acid differing from the common variety in being lævo-rotatory. The salts of tartaric acid usually exhibit hemihedral faces, while those of racemic acid are holohedral. Pasteur found that, although all the tartrate crystals were hemihedral, the hemihedral faces were situated on some crystals to the right, and on others to the left hand of the observer, so that one formed, as it were, the reflected image of the other. These crystals were separated, purified by recrystallisation, and those which exhibited dextro-hemihedry possessed dextro-rotatory power, while the others were lævo-rotatory. Pasteur further showed that if the mould *Penicillium glaucum* is grown in a solution of racemic acid, dextro-tartaric acid first disappears, and the lævo-acid alone remains. The subject remained in this condition for many years; it was, however, conjectured that probably there is some molecular condition corresponding to the naked-eye crystalline appearances which

produces the opposite optical effects of various substances. What this molecular structure is, was pointed out independently by two observers—Le Bel in Paris, and Van 't Hoff in Holland—who published their researches within a few days of each other. They pointed out that all optically active bodies contain one or more asymmetric carbon atoms, *i.e.* one or more atoms of carbon connected with four dissimilar groups of atoms, as in the following examples :—

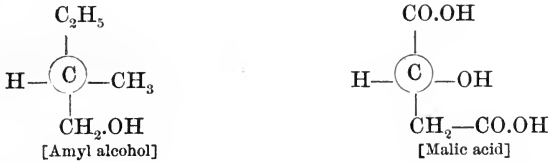

The question, however, remained—do all substances containing such atoms rotate the plane of polarised light? It was found that they do not; this is explained by Le Bel by supposing that these, like racemic acid, are compounds of two molecules—one dextro-, the other lævo-rotatory; that this



FIG. 78.

was the case was demonstrated by growing moulds, the fermenting action of which is to separate the two molecules in question. Then the other question—how is it that two isomerides, which in chemical characteristics, in graphic as well as empirical formulæ, are precisely alike, differ in optical properties?—is explained ingeniously by Van 't Hoff. He compares the carbon atom to a tetrahedron with its four dissimilar groups, A, B, C, D, at the four corners. The two tetrahedra represented in fig. 78 appear at first sight precisely alike; but if one be superimposed on the other, C in one and D in the other could never be made to coincide. This difference cannot be represented in any other graphic manner, and probably represents the difference in the way the atoms are grouped in the molecule of right- and left-handed substances respectively.

### MERCURIAL AIR-PUMPS

**Pfûger's Pump.**—*l* is a large glass bulb filled with mercury; from its lower end a straight glass tube, *m*, about 3 feet long, extends, which is connected by an india-rubber tube, *n*, with a reservoir of mercury, *o*, which can be raised or lowered as required, by a simple mechanical arrangement. From the upper end of the bulb, *l*, a vertical tube passes; above the stopcock, *k*, this has a horizontal branch, which can be closed by the stopcock, *f*. The vertical part is continued into the bent tube, which dips under mercury in the trough, *h*. A stopcock, *j*, is placed on the course of this tube. Beyond *f* the horizontal tube leads into a large double glass bulb, *a b*; a mercurial gauge, *e*, and a drying-tube, *d*, filled with pieces of pumice-stone moistened with sulphuric acid, are interposed. *a* is called the blood-bulb, and the

blood is brought into it by the tube *c*; the gases, as they come off, cause the blood to froth, and the bulb, *b*, is called the froth-chamber, as it intercepts the froth, preventing it from passing into the rest of the apparatus.

The pump is used in the following way: *l* is filled with mercury, the level in *l* and *o* being the same; *k* is closed; *o* is then lowered, and when it

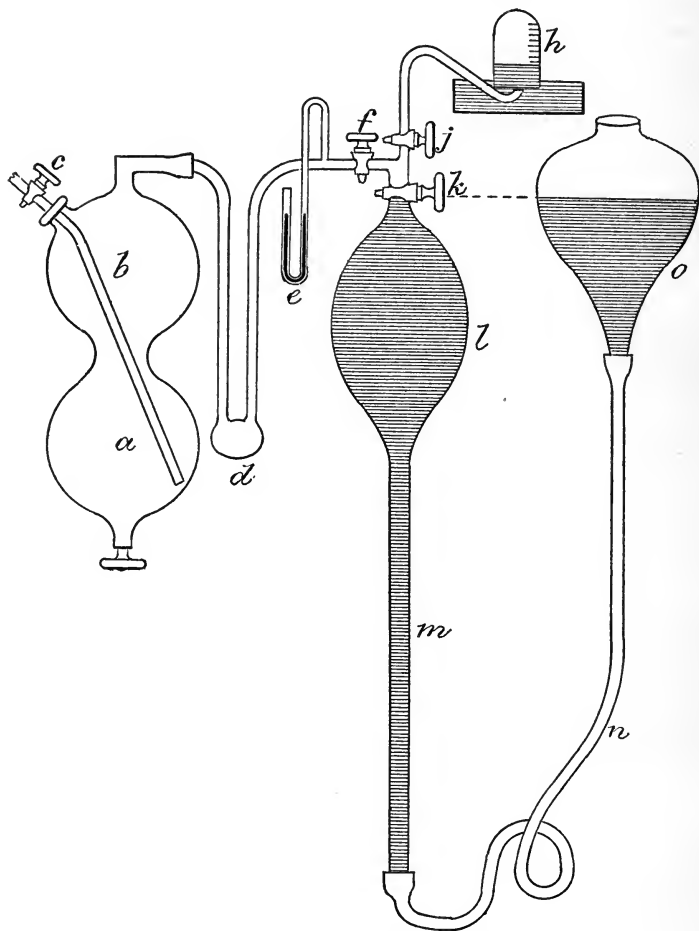

FIG. 79.—Diagram of Pflüger's pump.

is 30 inches lower than the stopcock, *k*, the mercury in *l* falls also, leaving that bulb empty: *j* being closed and *f* open, *k* is then opened, and the air in *a*, *b*, *d*, &c., rushes into the Torricellian vacuum in *l*; *f* is closed and *j* opened; the reservoir, *o*, is raised; the mercury in *l* rises also, pushing the air before it, and it bubbles out into the atmosphere through the mercury (the tube, *h*, is not at this stage in position). When *l* is full of mercury, *k* and *j* are once



more closed and *o* is again lowered; when *l* is thus rendered once more a vacuum, *k* and *f* are opened and more of the air remaining in *a*, *b*, *d*, &c. rushes into the vacuum; *f* is closed, *j* is opened, and this air is expelled as before. The process is repeated as often as is necessary to make *a*, *b*, *d*, &c. as complete a vacuum, as indicated by the mercury in the gauge, *e*, as is obtainable.

*a* being now empty, and the stopcock, *f*, closed, blood is introduced by the tube *c*; it froths and gives forth all its gases, especially if heated to 40–45° C. In the case of serum, acid has to be added to disengage the more firmly combined carbonic acid.<sup>1</sup> The bulb, *l*, is once more rendered a vacuum, and *k* and *f* are opened, *j* being closed. The gas from *a* and *b* rushes into the bulb *l*, being dried as it passes through *d*; *f* is then closed and *j* opened; the reservoir *o* is raised, and as the mercury in *l* rises simultaneously, it pushes the gases into the cylinder, *h*, which is filled with mercury and inverted over the end of the bent tube. This gas can be subsequently analysed. By alternately raising and lowering *o*, and regulating the stopcocks in the manner already described, all the gas from the quantity of blood used can be ultimately expelled into *h*.

A good grease for the stopcocks is a mixture of two parts of vaseline to one of white wax.

**Alvergniat's pump** has the advantage over Pflüger's of fewer connections, and all of these are surrounded by mercury, which effectually prevents leakage; it has the disadvantage of a rather small bulb in place of *l*, and thus it is more labour to obtain a vacuum.

**Leonard Hill's pump.**—This is a simpler instrument, and is sufficient for most purposes. It consists of three glass bulbs (B.B. in fig. 80), which we will call the *blood bulb*; this is closed above by a piece of tubing and a clip, *a*; this is connected by good india-rubber tubing to another bulb, *d*. Above *d*, however,

there is a stopcock with two ways cut through it: one by means of which B.B. and *d* may be connected, as in the figure; and another seen in section, which unites *d* to the tube *e*, when the stopcock is turned through a right angle. In intermediate positions the stopcock cuts off all communication from *d* to all parts of the apparatus above it; *d* is connected by tubing to a receiver, R, which can be raised or lowered at will. At first the whole apparatus is filled with mercury, R being raised. Then, *a* being closed, R is lowered, and when it is more than the height of the barometer (30 inches) below the top of B.B. the mercury falls and leaves the blood bulb empty; by lowering R still further, *d* can also be rendered a vacuum. A few drops of

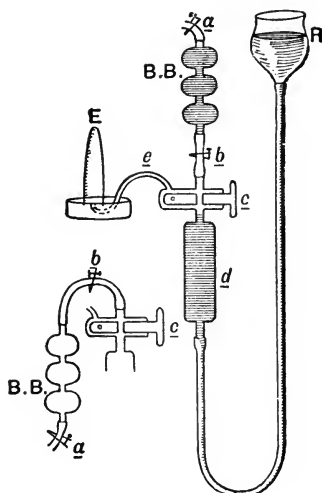

FIG. 80.—L. Hill's air-pump.

<sup>1</sup> Phosphoric acid is usually employed.

mercury should be left behind in B.B. B.B. is then detached from the rest of the apparatus and weighed, the clips, *a* and *b*, being tightly closed. Blood is then introduced into it by connecting the tube with the clip *a* on it to a cannula filled with blood inserted in an artery or vein of a living animal. Enough blood is withdrawn to fill about half of one of the bulbs. This is defibrinated by shaking it with a few drops of mercury left in the bulb. It is then weighed again; the increase of weight gives the amount of blood which is being investigated. B.B. is then once more attached to the rest of the apparatus, hanging downwards, as in the side drawing in fig. 80, and

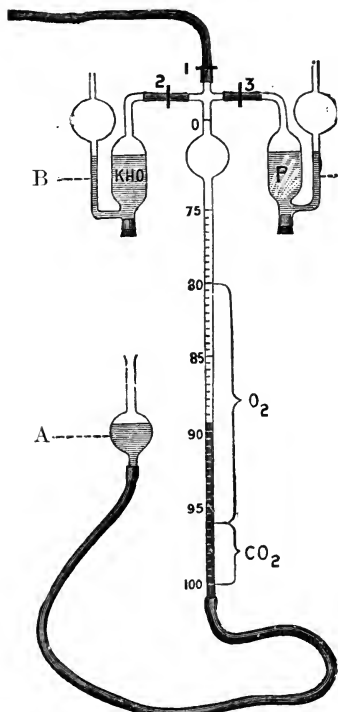

FIG. 81.—Waller's apparatus for gas analysis.

the blood gases boiled off; these pass into *d*, which has been made a vacuum; and then, by raising *R* again, the mercury rises in *d*, pushing the gases in front of it through the tube *e* (the stopcock being turned in the proper direction) into the eudiometer *E*, which has been filled with, and placed over, mercury. The gas can then be measured and analysed.

#### ANALYSIS OF GASES

Waller's modification of Zuntz's more complete apparatus will be found very useful in performing gas analysis, say of the expired air or blood gases: a 100 c.c. measuring tube graduated in tenths of a cubic centimetre between 75 and 100, a filling bulb and two gas pipettes are connected up as in the diagram.

It is first charged with acidulated water up to the zero mark by raising the filling bulb *A*, tap 1 being open. It is then filled with 100 c.c. of expired air, the filling bulb being lowered till the fluid in the tube has fallen to the 100 mark. Tap 1 is now closed. The amount of carbonic acid in the expired air is next ascertained; tap 2 is opened, and the air is expelled into the gas pipette *B*, containing strong caustic potash solution, by raising the filling bulb until the fluid has risen to the zero mark of the measuring tube. Tap 2 is closed, and the air left in the gas pipette for a few minutes, during which the carbonic acid is absorbed by the potash. Tap 2 is then opened and the air drawn back into the measuring tube by lowering the filling bulb. The volume of air (*minus* the carbonic acid) is read, the filling bulb being adjusted so that its contents are at the same level as the fluid in the measuring tube. The amount of oxygen is next ascertained in a precisely similar manner by sending the air into the other gas pipette, which contains sticks of phosphorus in water, and measuring the loss of volume (due to

absorption of oxygen) in the air when drawn back into the tube. The remaining gas is nitrogen.

### KJELDAHL'S METHOD OF ESTIMATING NITROGEN

This simple method can be used in connection with most substances of physiological importance. Briefly, it consists in converting all the nitrogen present into ammonia by means of sulphuric acid; then rendering alkaline with soda, and distilling over the ammonia into standard acid, the diminution in acidity of which measures the amount of ammonia present.

The following modification of the original method is used in this laboratory.

About 1 gramme of the substance under investigation (or in the case of urine when one wishes to make an estimation of total nitrogen, 5 or 10 c.c. of that fluid) is placed in a round bottomed Jena flask of about 250 c.c. capacity, and 20 c.c. of pure sulphuric acid added. Six grammes of potassium sulphate and about half a gramme of copper sulphate are also added. The flask should be provided with a loose balloon stopper, and arranged in a sloping direction over a small flame. The mixture is heated slowly until it boils. In about twenty minutes the fluid becomes nearly colourless; boiling is continued for another forty-five minutes. By this time all the nitrogen will be in combination as ammonia.

After cooling, the fluid is washed into a litre flask of Jena glass (fig. 82, A) and water added until the total volume of the fluid is about 400 c.c. Add then an excess of 40 per cent. caustic soda solution, a few pieces of granulated zinc to avoid bumping in the subsequent distillation, and immediately fit the glass tube B into the neck of the flask by means of a well-fitting rubber stopper. The other end of B leads into the flask C which contains a measured amount (50 or 100 c.c.) of standard sulphuric acid;  $\frac{1}{2}$  normal acid is a convenient strength to use. The bulb D shown in the figure guards against regurgitation, and the end of the tube should dip just below the surface of the acid in C. The mixture in the flask is now boiled for about half an hour when all the ammonia will have distilled over; the use of a condenser around the tube B is unnecessary. The acidity of the standard acid is then determined by titrating with standard alkali, a few drops of methyl orange being added to act as the indicator of the end of the reaction (this gives a pink colour with acid, yellow with alkali).

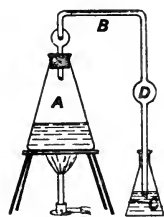

FIG. 82. — Kjeldahl's method: distilling apparatus.

*Example.*—Suppose 1 gramme of a nitrogenous substance is taken, and the ammonia distilled over into 100 c.c. of  $\frac{1}{2}$  normal sulphuric acid (= 20 c.c. normal acid). This is then titrated with a corresponding solution of soda, and it is found that the neutral point is reached when 60 c.c. of the soda solution have been added. The other 40 c.c. must therefore have been neutralised by the ammonia derived from the substance under investigation. This 40 c.c. of acid = 8 c.c. of normal acid = 8 c.c. of normal ammonia =  $8 \times 0.017 = 0.136$  gramme of ammonia. One gramme of the substance analysed, therefore, yields 0.136 gramme of ammonia, and this contains 0.112

gramme of nitrogen ; 100 grammes will therefore contain 11·2 grammes of nitrogen. If the strength of the acid is that just recommended, each c.c. corresponds to 0·0028092 of nitrogen.

### SOLUTIONS. DIFFUSION. DIALYSIS. OSMOSIS.

The investigations of physical chemists during recent years have given us new conceptions of the meaning of the words that stand at the head of this article. I propose to state what these new conceptions are, and briefly to indicate the bearing they have on the elucidation of physiological problems.

**Solutions.**—Water is the fluid in which soluble materials are usually dissolved, and at ordinary temperatures it is a fluid, the molecules of which are in constant movement ; the hotter the water the more active are the movements of its molecules, until, when at last it is converted into steam, the molecular movements become much more energetic. Perfectly pure water consists of molecules with the formula  $H_2O$ , and these molecules undergo practically no dissociation into their constituent atoms, and it is for this reason that pure water is not a conductor of electricity.

If a substance like sugar is dissolved in the water, the solution still remains incapable of conducting an electrical current. The sugar molecules in solution are still sugar molecules ; they do not undergo dissociation.

But if a substance like salt is dissolved in the water, the solution is then capable of conducting electrical currents, and the same is true for most acids, bases, and salts. These substances do undergo dissociation, and the simpler materials into which they are broken up in the water are called **ions**. Thus if sodium chloride is dissolved in water, a certain number of its molecules become dissociated into sodium ions, which are charged with positive electricity, and chlorine ions, which are charged with negative electricity. Similarly a solution of hydrochloric acid in water contains free hydrogen ions and free chlorine ions. Sulphuric acid is decomposed into hydrogen ions and ions of  $SO_4$ . The term ion is thus not equivalent to atom, for an ion may be a group of atoms, like  $SO_4$ , in the example just given.

Further, in the case of hydrochloric acid, the negative charge of the chlorine ion is equal to the positive charge of the hydrogen ion ; but in the case of the sulphuric acid, the negative charge of the  $SO_4$  ion is equal to the positive charge of two hydrogen ions. We can thus speak of monovalent, divalent, trivalent, &c. ions.

Ions charged with positive electricity are called *kat-ions* because they move towards the kathode or negative pole ; those which are charged with negative electricity are called *an-ions* because they move towards the anode or positive pole. The following are some examples of each class :—

**Kat-ions.** Monovalent :—H, Na, K,  $NH_4$ , &c.

Divalent : Ca, Ba, Fe (in ferrous salts), &c.

Trivalent : Al, Bi, Sb, Fe (in ferric salts), &c.

**An-ions.** Monovalent : Cl, Br, I, OH,  $NO_3$ , &c.

Divalent :—S, Se,  $SO_4$ , &c.

Roughly speaking, the greater the dilution the more nearly complete is the dissociation, and in a very dilute solution of such a substance as sodium

chloride we may consider that the number of ions is double the number of molecules of the salt present.

The ions liberated by the act of dissociation are, as we have seen, charged with electricity, and when an electrical current is led into such a solution it is conducted through the solution by the movement of the ions. Substances which exhibit the property of dissociation are known as electrolytes.

The conception of electrolytes, which we owe to Arrhenius, is extremely important in view of the question of osmotic pressure which we shall be considering immediately; because the act of dissociation increases the number of particles moving in the solution and so increases the osmotic pressure, for in this relation the ion plays the same part as a molecule.

The liquids of the body contain electrolytes in solution, and it is owing to this fact that they are able to conduct electrical currents.

Another physiological aspect of the subject is seen in a study of the action of mineral salts in solution on living organisms and parts of organisms. Many years ago Ringer showed that contractile tissues (heart, cilia, &c.) continue to manifest their activity in certain saline solutions. Indeed, as Howell puts it, the cause of such rhythmical action is the presence of these inorganic substances in the blood or lymph which usually bathes them. In the case of the heart, the sinus, or venous end of the heart, is peculiarly susceptible to the stimulus of the inorganic salts, and the rhythmical peristaltic waves so started travel thence over the rest of the heart muscle.

Loeb and his fellow workers have confirmed these statements, but interpret them now as ionic action. Contractile tissues will not contract in pure solutions of non-electrolytes (like sugar, urea, albumen). But different contractile tissues differ in the nature of the ions which are most favourable stimuli. Thus cardiac muscle, cilia, amœboid movement, karyokinesis, cell division are all alike in requiring a proper adjustment of ions in their surroundings if they are to continue to act, but the proportions must be different in individual cases. Ions affecting the rhythmical contractions may be divided into three classes: (1) Those which produce such contractions; of these the most efficacious is Na. (2) Those which retard rhythmical contractions; for instance, Ca and K. (3) Those which act catalytically, that is, they accelerate the action of Na, though they do not themselves produce rhythmical contractions directly: for instance, H and OH. In spite of the antagonistic effect of Ca, a certain amount of it must be present if contractions are to continue for any length of time. Ions produce rhythmical contraction only because they affect either the physical condition of the colloidal substances (protein, &c.) in protoplasm, or the rapidity of chemical processes.

Loeb has even gone so far as to consider that the process of fertilisation is mainly ionic action. He denies that the nuclein in the head of the spermatozoon is essential, but asserts that all the spermatozoon does is to act as the stimulus in the due adjustment of the proportions of the surrounding ions. He supports this view by numerous experiments on ova, in which, without the presence of spermatozoa, he has produced larvæ (generally imperfect ones, it is true) by merely altering the saline constituents of the fluid that bathes them. Whether such a notion will stand the test of further verifica-

tion must be left to the future. So also must the equally important idea that the basis of a nervous impulse is electrolytic action, though it receives support from Macdonald's recent investigations.

**Gramme-molecular Solutions.**—From the point of view of osmotic pressure a convenient unit is the gramme-molecule. A gramme-molecule of any substance is the quantity in grammes of that substance equal to its molecular weight. A gramme-molecular solution is one which contains a gramme-molecule of the substance per litre. Thus a gramme-molecular solution of sodium chloride is one which contains 58.5 grammes of sodium chloride ( $\text{Na} = 23.05$ ;  $\text{Cl} = 35.45$ ) in a litre. A gramme-molecular solution of grape sugar ( $\text{C}_6\text{H}_{12}\text{O}_6$ ) is one which contains 180 grammes of grape sugar in a litre. A gramme-molecule of hydrogen ( $\text{H}_2$ ) is 2 grammes by weight of hydrogen, and if this were compressed to the volume of a litre it would be comparable to a gramme-molecular solution. It therefore follows that a litre containing 2 grammes of hydrogen contains the same number of molecules of hydrogen in it, as a litre of a solution containing 58.5 grammes of sodium chloride, or one containing 180 grammes of grape sugar has in it of salt or sugar molecules respectively. To put it another way, the heavier the weight of a molecule of any substance the more of that substance must be dissolved in the litre to obtain its gramme-molecular solution. Or still another way: if solutions of various substances are made all of the same strength per cent., the solutions of the materials of small molecular weight will contain more molecules of those materials, than the solutions of the materials which have heavy molecules. We shall see that the calculation of osmotic pressure depends on these facts.

**Diffusion, Dialysis, Osmosis.**—If two gases are brought together within a closed space, a homogeneous mixture of the two is soon obtained. This is due to the movements of the gaseous molecules within the confining space and the process is called *diffusion*. In a similar way diffusion will effect in time a homogeneous mixture of two liquids or solutions. If water is carefully poured on to the surface of a solution of salt, the salt or its ions will soon be equally distributed throughout the whole. If a solution of albumin or any other *colloidal* substance is used instead of salt in the experiment, diffusion will be found to occur much more slowly. If, instead of pouring the water on to the surface of a solution of salt or sugar, the two are separated by a membrane made of such a material as parchment paper, a similar diffusion will occur, though more slowly than in cases where the membrane is absent. In time, the water on each side of the membrane will contain the same quantity of sugar or salt. Substances which pass through such membranes are called *crystalloids*. Substances which have such heavy molecules (starch, protein, &c.) that they will not pass through such membranes are called *colloids*. Diffusion of substances in solution in which we have to deal with an intervening membrane is usually called *dialysis*. The process of *filtration* (*i.e.* the passage of materials through the pores of a membrane under the influence of mechanical pressure) may be excluded in such experiments by placing the membrane (*M*) vertically as shown in the diagram (fig. 83), and the two fluids *A* and *B* on each side of it. Diffusion through a membrane is not limited to the molecules of water, but it may occur also in

the molecules of certain substances dissolved in the water. But very few or no membranes are equally permeable to water and to molecules of the substances dissolved in the water. If in the accompanying diagram the compartment *A* is filled with pure water, and *B* with a sodium chloride solution, the liquids in the two compartments will ultimately be found to be equal in bulk as they were at the start, and each will be a solution of salt of half the original strength of that in the compartment *B*. But at first the volume of the liquid in compartment *B* increases, because more water molecules pass into it from *A* than salt molecules pass from *B* into *A*. The term **osmosis** is generally limited to the stream of water molecules passing through a membrane, while the term **dialysis** is applied to the passage of the molecules in solution in the water. The osmotic stream of water is especially important, and in connection with this it is necessary to explain the term **osmotic pressure**. At first, then,

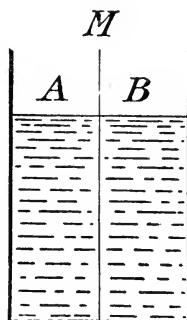

FIG. 83.

osmosis (the diffusion of water) is more rapid than the dialysis (the diffusion of the salt molecules or ions). The older explanation of this was that salt attracted the water, but we now express the fact differently by saying that the salt in solution exerts a certain osmotic pressure: the result of the osmotic pressure is that more water flows from the water side to the side of the solution than in the contrary direction. The osmotic pressure varies with the amount of substance in solution, and is also altered by variations of temperature, occurring more rapidly at high than at low temperatures.

If we imagine two masses of water separated by a permeable membrane, as many water molecules will pass through from one side as from the other, and so the volumes of the two masses of water will remain unchanged. If now we imagine the membrane *M* is not permeable except to water, and the compartment *A* contains water, and the compartment *B* contains a solution of salt or sugar; in these circumstances water will pass through into *B*, and the volume of *B* will increase in proportion to the osmotic pressure of the sugar or salt in solution in *B*, but no molecules of sugar or salt can get through into *A* from *B*, so the volume of fluid in *A* will continue to decrease, until at last a limit is reached. The determination of this limit, as measured by the height of a column of fluid or mercury which it will support, will give us a measurement of the osmotic pressure. Membranes of this nature are called **semi-permeable**. One of the best kinds of semi-permeable membrane is ferrocyanide of copper. This may be made by taking a cell of porous earthenware and washing it out first with copper sulphate and then with potassium ferrocyanide. An insoluble precipitate of copper ferrocyanide is thus deposited in the pores of the earthenware. If such a cell is filled with a 1-per-cent. solution of sodium chloride, water diffuses in till the pressure registered by a manometer connected to it registers the enormous height of 5,000 millimetres of mercury. Theoretically it is possible to measure osmotic pressure by a manometer in this way, but practically it is seldom done, and some of the indirect methods of measurement described later are used

instead. The reason for this is that it has been found difficult to construct a membrane which is absolutely semi-permeable.

Many explanations of the nature of osmotic pressure have been brought forward, but none is perfectly satisfactory. The following simple explanation is perhaps the best, and may be rendered most intelligible by an illustration. Suppose we have a solution of sugar separated by a semi-permeable membrane from water: that is, the membrane is permeable to water molecules, but not to sugar molecules. The streams of water from the two sides will then be unequal; on one side we have water molecules striking against the membrane in what we may call normal numbers, while on the other side both water molecules and sugar molecules are striking against it. On this side, therefore, the sugar molecules take up a certain amount of room, and do not allow the water molecules to get to the membrane; the membrane is, as it were, screened against the water by the sugar, therefore fewer water molecules will get through from the screened to the unscreened side than *vice versa*. This comes to the same thing as saying that the osmotic stream of water is greater from the unscreened water side to the screened sugar side than it is in the reverse direction. The more sugar molecules that are present, the greater will be their screening action, and thus we see that the osmotic pressure is proportional to the number of sugar molecules in the solution: that is, to the concentration of the solution.

Osmotic pressure is, in fact, equal to that which the dissolved substance would exert if it occupied the same space in the form of a gas (Van 't Hoff's hypothesis). The nature of the substance makes no difference; it is only the number of molecules which causes osmotic pressure to vary. The osmotic pressure, however, of substances like sodium chloride, which are electrolytes, is greater than what one would expect from the number of molecules present. This is because the molecules in solution are split into their constituent ions, and an ion plays the same part as a molecule, in questions of osmotic pressure. In dilute solutions of sodium chloride ionisation is more complete, and as the total number of ions is then nearly double the number of original molecules, the osmotic pressure is nearly double what would have been calculated from the number of molecules.

The analogy between osmotic pressure and the partial pressure of gases is complete, as may be seen from the following statements:—

1. At a constant temperature osmotic pressure is proportional to the concentration of the solution (Boyle-Mariotte's law for gases).
2. With constant concentration, the osmotic pressure rises with and is proportional to the temperature (Gay-Lussac's law for gases).
3. The osmotic pressure of a solution of different substances is equal to the sum of the pressures which the individual substances would exert if they were alone in the solution (Henry-Dalton's law for partial pressure of gases).
4. The osmotic pressure is independent of the nature of the substance in solution, and depends only on the number of molecules or ions in solution (Avogadro's law for gases).

**Calculation of Osmotic Pressure.**—We may best illustrate this by an example and to simplify matters we will take an example in the case of a non-electrolyte like sugar. We shall then not have to take into account any electrolytic



dissociation of the molecules into ions. We will suppose we want to calculate the osmotic pressure of a 1-per-cent. solution of cane sugar.

One gramme of hydrogen at atmospheric pressure and 0° C. occupies a volume of 11.2 litres; two grammes of hydrogen will therefore occupy a volume of 22.4 litres. A gramme-molecule of hydrogen—that is, 2 grammes of hydrogen—when brought to the volume of 1 litre will exert a gas pressure equal to that of 22.4 litres compressed to 1 litre—that is, a pressure of 22.4 atmospheres. A gramme-molecular solution of cane sugar, since it contains the same number of molecules in a litre, must therefore exert an osmotic pressure of 22.4 atmospheres also. A gramme-molecular solution of cane sugar ( $C_{12}H_{22}O_{11}$ ) contains 342 grammes of cane sugar in a litre. A 1-per-cent. solution of cane sugar contains only 10 grammes of cane sugar in a litre of water; hence the osmotic pressure of a 1-per-cent. solution of cane sugar is  $\frac{10}{342} \times 22.4$  atmospheres, or 0.65 of an atmosphere, which in terms of a column of mercury =  $760 \times 0.65 = 494$  mm.

It would not be possible to make such a calculation in the case of an electrolyte, because we should not know how many molecules had been ionised. In the liquids of the body, both electrolytes and non-electrolytes are present, and so a calculation is here also impossible.

We have seen the difficulty of directly measuring osmotic pressure by a manometer; we now see that mere arithmetic often fails us; and so we come to the question to which we have been leading up, viz. how osmotic pressure is actually determined.

**Determination of Osmotic Pressure by means of the Freezing-point.**—This is the method which is almost universally employed. A very simple apparatus (Beckmann's differential thermometer) is all that is necessary. The principle on which the method depends is the following:—The freezing-point of any substance in solution in water is lower than that of water; the lowering of the freezing-point is proportional to the molecular concentration of the dissolved substance, and that, as we have seen, is proportional to the osmotic pressure.

When a gramme-molecule of any substance is dissolved in a litre of water, the freezing-point is lowered by 1.87° C., and the osmotic pressure is, as we have seen, equal to 22.4 atmospheres: that is,  $22.4 \times 760 = 17,024$  mm. of mercury.

We can therefore calculate the osmotic pressure of any solution if we know the lowering of its freezing-point in degrees Centigrade; the lowering of the freezing-point is usually expressed by the Greek letter  $\Delta$ .

$$\text{Osmotic pressure} = \frac{\Delta}{1.87} \times 17,024.$$

For example, a 1-per-cent. solution of sugar would freeze at  $-0.052^\circ$  C.; its osmotic pressure is therefore  $\frac{0.052 \times 17,024}{1.87} = 473$  mm., a number approximately equal to that we obtained by calculation.

Mammalian blood serum gives  $\Delta = 0.56^\circ$  C. A 0.9-per-cent. solution of sodium chloride has the same  $\Delta$ ; hence serum and a 0.9-per-cent. solution of common salt have the same osmotic pressure, or are *isotonic*. The osmotic

pressure of blood serum is  $\frac{.56 \times 17,024}{1.87} = 5,000$  mm. of mercury approximately, or a pressure of nearly 7 atmospheres.

The osmotic pressure of solutions may also be compared by observing their effect on red corpuscles, or on vegetable cells such as those in *Trades-cantia*. If the solution is *hypertonic*, *i.e.* has a greater osmotic pressure than the cell contents, the protoplasm shrinks and loses water, or, if red corpuscles are used, they become crenated. If the solution is *hypotonic*, *e.g.* has a smaller osmotic pressure than the material within the cell-wall, no shrinking of the protoplasm in the vegetable cell occurs, and if red corpuscles are used they swell and liberate their pigment. *Isotonic* solutions produce neither of these effects, because they have the same molecular concentration and osmotic pressure as the material within the cell-wall.

**Physiological Applications.**—It will at once be seen how important all these considerations are from the physiological standpoint. In the body we have aqueous solutions of various substances separated from one another by membranes. Thus we have the endothelial walls of the capillaries separating the blood from the lymph; we have the epithelial walls of the kidney tubules separating the blood and lymph from the urine; we have similar epithelium in all secreting glands; and we have the wall of the alimentary canal separating the digested food from the blood-vessels and lacteals. In such important problems, then, as lymph-formation, the formation of urine and other excretions and secretions, and absorption of food, we have to take into account the laws which regulate the movements both of water and of substances which are held in solution by the water. In the body osmosis is not the only force at work, but we have also to consider filtration: that is, the forcible passage of materials through membranes, due to differences of mechanical pressure. Further complicating these two processes we have to take into account another force: namely, the secretory or selective activity of the living cells of which the membranes in question are composed. This is sometimes called by the name *vital action*, which is an unsatisfactory and unscientific expression. The laws which regulate filtration, imbibition, and osmosis are fairly well known and can be experimentally verified. But we have undoubtedly some other force, or some other manifestation of force, in the case of living membranes. It probably is some physical or chemical property of living matter which has not yet been brought into line with the known chemical and physical forces which operate in the inorganic world. We cannot deny its existence, for it sometimes operates so as to neutralise the known forces of osmosis and filtration.

The more one studies the question of lymph-formation, the more convinced one becomes that mere osmosis and filtration will not explain it entirely. The basis of the action is no doubt physical, but the living cells do not behave like the dead membranes of a dialyser; they have a selective action, picking out some substances and passing them through to the lymph, while they reject others.

The question of gaseous interchanges in the lungs has been another battlefield of a similar kind. Some maintain that all can be explained by the laws of diffusion of gases; others assert that the action is wholly

vital. Probably those are most correct who admit a certain amount of truth in both views; the main facts are explicable on a physical basis, but there are also some puzzling data which show that the pulmonary epithelium is able to exercise some other force as well, which interferes to some extent with the known physical process. Take again the case of absorption. The object of digestion is to render the food soluble and diffusible; it can hardly be supposed that this is useless; the readily diffusible substances will pass more easily through into the blood and lymph: but still, as Waymouth Reid has shown, if the living epithelium of the intestine is removed, absorption comes very nearly to a standstill, although from the purely physical standpoint removal of the thick columnar epithelium would increase the facilities for osmosis and filtration.

The osmotic pressure exerted by crystalloids is very considerable, but their ready diffusibility limits their influence on the flow of water in the body. Thus, if a strong solution of salt is injected into the blood, the first effect will be the setting up of an osmotic stream from the tissues to the blood. The salt, however, would soon diffuse out into the tissues, and would now exert osmotic pressure in the opposite direction. Moreover, both effects will be but temporary, because excess of salt is soon got rid of by the excretions.

**Osmotic Pressure of Proteins.**—It has been generally assumed that proteins, the most abundant and important constituents of the blood, exert little or no osmotic pressure. Starling, however, has claimed that they have a small osmotic pressure; if this is so, it is of importance, for proteins, unlike salt, do not diffuse readily, and their effect therefore remains as an almost permanent factor in the blood. Starling gives the osmotic pressure of the proteins of the blood-plasma as equal to 30 mm. of mercury. By others this is attributed to the inorganic salts with which proteins are always closely associated. Moore, for instance, finds that the purer a protein is, the less is its osmotic pressure; the same is true for other colloidal substances. It really does not matter much, if the osmotic force exists, whether it is due to the protein itself, or to the saline constituents which are almost an integral part of a protein. It is merely interesting from the theoretical point of view. We should from the theoretical standpoint find it difficult to imagine that a pure protein can exert more than a minimal osmotic pressure. It is made up of such huge molecules that, even when the proteins are present to the extent of 7 or 8 per cent., as they are in blood-plasma, there are comparatively few protein molecules in solution, and probably none in true solution. Still, by means of this weak but constant pressure it is possible to explain the fact that an isotonic or even a hypertonic solution of a diffusible crystalloid may be completely absorbed from the peritoneal cavity into the blood.

The functional activity of the tissue elements is accompanied by the breaking down of their protein constituents into such simple materials as urea (and its precursors), sulphates, and phosphates. These materials pass into the lymph, and increase its molecular concentration and its osmotic pressure; thus water is attracted (to use the older way of putting it) from the blood to the lymph, and so the volume of the lymph rises and its flow increases. On the other hand, as these substances accumulate in the lymph they will in

time attain there a greater concentration than in the blood, and so they will diffuse towards the blood, by which they are carried to the organs of excretion.

But, again, we have a difficulty with the proteins; they are most important for the nutrition of the tissues, but they are practically indiffusible. We must provisionally assume that their presence in the lymph is due to filtration from the blood. The plasma in the capillaries is under a somewhat higher pressure than the lymph in the tissues, and this tends to squeeze the constituents of the blood, including the proteins, through the capillary walls. I have, however, already indicated that the question of lymph-formation is one of the many physiological problems which await solution by the physiologists of the future.

# INDEX

In cases where several references are made to any subject, the figure in heavy type indicates where the principal matter in relation to the subject is to be found.

## A

- ABRIN, 123  
Absorption, **95**, 243; of carbohydrates, 96; of fats, 99; of proteins, 96  
Absorption bands, 117, 118, 119  
Absorption spectra of hæmoglobin and its derivatives, 119, 189; of myohæmatin, 199; of urinary pigments, 215  
Accessories of food, 60  
Acetic acid, 24, 25, 63  
Acetonæmia, 88  
Acetone, 88, 168; test for, 168  
Acetyl, 25  
Achroë-dextrin, **21**, 68, 179  
Acid-albumin, 29, 30, 48, 62, **75**, 79, 81, 172  
Acid hæmatin, 188  
Acid hæmatoporphyrin, 189, 215; absorption bands of, 189, 215  
Acid, lactic, *see* Lactic acid  
Acid sodium phosphate, 144  
Acid tide, 144  
Acids, vegetable, 4, 144  
Acrolein, 22, 24  
Acute yellow atrophy of liver, 147  
Adamkiewicz's reaction, 27, 34, 39  
Adenase, 161  
Adenine, 46, 159, **160**, 161  
Adipose tissue, 2, 23  
Aërobie micro-organisms, 66  
Aërotonometer, 132  
Agglutinating action, 124; agglutinins, 124  
Air, expired and inspired, 126; pumps, mercurial, 231  
Alanine, 31, 33  
Alanyl, 36  
Albumin, 4, 237; action of acids and alkalis on, 29, 30  
Albumin, acid-, 29, 30; alkali-, 29  
Albumin in urine, 166; estimation of, 166; tests for, 156  
Albuminate, 48  
Albuminoids, 43  
Albuminometer of Esbach, 166  
Albumins, 37, 41, **42**, 77, 171  
Albumose, 75  
Albumoses and peptone, separation of, 182; tests for, 182  
Alcapton, 169  
Alcaptonuria, 169  
Alcohol, action of, on proteins, 182  
Alcoholic fermentation, 56; of milk, 56  
Alcohols, 4, 14, 24, 25  
Aldehyde, 14, 24  
Aldoses, 15  
Aleurone grains, 38  
Alkali-albumin, 29, 30, **48**, 81, 172, 187  
Alkaline hæmatin, 188  
Alkaline hæmatoporphyrin, 215; absorption bands of, 189, 215  
Alkaline tide, 144  
Alkaloids, 60  
Alloxuric bases, 46  
Allyl alcohol, 24, 231  
Aluminium, 8  
Alvergniat's pump, 233  
Amboceptor, 124  
Amidulin, 20  
Amino-acetic acid, *see* Glycine  
Amino-acids, 31, 81, 85, 86, 97  
Amino-caproic acid, 31, 86  
Amino-ethyl-sulphonic acid, 91  
Amino-iso-butyl-acetic acid, 86  
Amino-oxy-purine, 159  
Amino-propionic acid, 31  
Amino-purine, 159  
Amino-pyrotartaric acid, 32  
Amino-succinamic acid, 32  
Amino-succinic acid, 32

Amino-valeric acid, 32  
 Ammonia, 34, 151  
 Ammoniacal odour of putrid urine, 146  
 Ammonio-magnesium phosphate, 156  
 Ammonium carbonate and carbamate as urea precursors, 150  
 Ammonium cyanate, 145  
 Ammonium sulphate, action of, on proteins, 27, 28, 40, 165, 182  
 Ammonium urate, 165  
 Amœboid movements, 237  
 Amyolytic ferments, 65, 68, 184  
 Amylopsin, 19, 65, 78, 80; action of, 82  
 Amyloses, 16, 65  
 Anaërobic micro-organisms, 66  
 Analyses of gases, 234  
 Animal starch, 21  
 Anions, 236  
 Anisotropic bodies, 223  
 Anti-bodies, 77  
 Antimony, 8  
 Antipepsin, 77, 105  
 Antiseptics, 63  
 Antithrombin, 105, 107  
 Antitoxic material, 121  
 Antitoxin, 123  
 Antitrypsin, 77, 105  
 Antivenin, 123  
 Apparatus necessary for practical work, 4, 5, 6  
 Appendix, 217  
 Aqueous vapour, tension of, 8  
 Arabinose, 178  
 Arginase, 150, 161  
 Arginine, 32, 33, 35, 41, 81, 150, 161  
 Aromatic amino-acids, 33  
 Aromatic series, 18  
 Arsenic, 8  
 Arterial blood, gases of, 127  
 Artificial gastric juice, 62  
 Asparagine, 32  
 Aspartic acid, 32, 81  
 Asphyxia, 128  
 Atmosphere, 126  
 Atomic weights, 8  
 Attraction sphere, 2  
 Atypical globulin, 198  
 Avogadro's law, 127, 240

## B

BACILLI, 65  
 Bacteria, 65  
 Bacterial action, 85  
 Bacterio-lysin, 122  
 Barcroft's apparatus for obtaining blood gases, 135  
 Barfoed's reagent, 178  
 Barium, 8

Bath, warm, 29  
 Baumann and Wolkow on alcapton, 169  
 Bausteine, 98  
 Beaumont, Dr., on gastric secretion, 70  
 Beef, 57; beef-tea, 59, 200  
 Beetroot, 18  
 Benger's liquor pancreaticus, 78, 186; liquor pepticus, 62  
 Benzene, 33  
 Benzoic acid, 162  
 Bernard, Claude, on glycogen of liver, 96; diabetic puncture, 88  
 Bile, 78, 89, 100; amount secreted, 90; secretion of, 89; circulation, 90; characters of, 90; constituents, 90; mucin of, 91; pigments, 79, 90, 95; salts of, 79, 91, 94; uses of, 93; actions of, 94; in urine, 169  
 Biliary fistula, 89  
 Bilirubin, 90, 91, 92, 93, 95, 213; of meconium, 95  
 Biliverdin, 91, 92, 95  
 Bismuth, 8  
 Biuret, 39, 77, 141; reaction, 27, 39, 183  
 Blood, 3, 101-126; coagulation of, 102, 104, 194; corpuscles, 103; detection of, 120, 121; gases of, 127; specific gravity of, 222; tests for, 120, 121; pigment, 111; biological test for, 121; plasma and serum of, 101, 108; in urine, 169; platelets, 103, 104, 108, 196  
 Blood bulb, 234  
 Blood clot, 103  
 Bohr on absorption of oxygen, 130; on tension of carbonic dioxide, 130  
 Bone, composition of, 43; marrow, 23  
 Boron, 8  
 Bowman's capsule, 143  
 Boyle-Mariotte's law for gases, 240  
 Bran, 58  
 Bread, 50, 52, 58; composition of, 59  
 Bright's disease, 168  
 Bromine, 8  
 Brown and Morris on digestion of starch, 68  
 Buchner on ferments, 66  
 Buffy coat, 103  
 Bunge on hæmatogens, 46; on milk, 53  
 Bush tea, 60  
 Butter, 49, 52  
 Butyric acid, 19, 24, 85  
 Butyrin, 55

## C

CADMIUM, 8  
 Caffeine, 60, 159  
 Calcium, 5, 8; phosphate, 49

- Calcium caseinogenate, 55, 181  
 Calcium oxalate in urine, 156, 162, 165 ; crystals, 164  
 Calcium salts, 3, 105 ; importance of, in coagulation of blood, 104, 105, 194 ; of milk, 55, 181  
 Cane sugar, 13, 16, 18, 74, 96, 171, 177, 178 ; urine, 18 ; tests for, 13, 18  
 Caproic acid, 24, 32  
 Caproin, 55  
 Carbamate, 150  
 Carbamide, 151. *See also* Urea  
 Carbohydrates, 4, 13-21, 176-179 ; absorption of, 96 ; classification of, 16 ; definition of, 14 ; tests for, 13-21, 171, 176, 177, 178, 179  
 Carbolio acid poisoning and urine, 216  
 Carbon, 3, 8 ; tests for, 3, 9  
 Carbonates in blood, 129, 130 ; in urine, 154  
 Carbonic acid in air, 126 ; in blood, 129, 130  
 Carbonic oxide hæmoglobin, 114, 120, 172, 188  
 Cardiac glands, 70 ; muscle, 237  
 Carmine-stained fibrin, 184  
 Cartilage, 44  
 Casein, 49, 54, 60, 172  
 Caseinogen, 10, 35, 49, 54, 55, 172, 181, 186  
 Caseinogenate of calcium, of sodium, of potassium, 55  
 Catalysing agents, 67, 82  
 Catalysts, 67  
 Cell, definition of, 2 ; diagram of, 45  
 Cells, differentiation of, 1  
 Cellulose, 16, 21, 85, 95  
 Centigrade scale, 7  
 Central cells of fundus glands, 70, 71, 72  
 Centrifugal machine, 195 -  
 Centrosome, 2  
 Cerebrin, 201  
 Cerebrosides, 201  
 Cerebrospinal fluid, 203 ; functions of, 203  
 Chemical physiology, 1  
 Chemical sediments of urine, 165  
 Chemical structure of protoplasm, 3  
 Chemistry of respiration, 126 ; of nerve degeneration, 201  
 Chittenden's views on diet, 52, 148  
 Chlorides of urine, 141, 153 ; estimation of, 205 ; tests for, 141  
 Chlorine, 3, 8  
 Chlorophyll, 95  
 Cholalic acid, 91, 94  
 Cholesterin, 3, 26, 56, 79, 90, 91, 93, 94, 95, 111, 201 ; crystals of, 93, 173 ; tests for, 93  
 Choletelin, 92  
 Choline, 26, 85, 201 ; tests for, 201, 202  
 Chondrin, 44  
 Chorda tympani, 68  
 Chromatin, 45  
 Chromogens in urine, 216  
 Chromo-proteins, 41, 44  
 Chyle, 99  
 Chyme, 89, 94  
 Cilia, 237  
 Ciliary movement, 237  
 Circular polarisation and chemical constitution, 230  
 'Circulating protein,' 148  
 Circulation of bile, 90  
 Cirrhosis of liver, 147  
 Citric acid, 54, 144  
 Clark's essence of rennet, 60  
 Cleavage, 30 ; products of digestion, 81, 97, 98  
 Clotting of blood, 102-108, 194-196  
 Clupeine, 42  
 Coagulated proteins, 43  
 Coagulation, 40  
 Coagulation of blood, 102-108, 194-196 ; of milk, 49, 54, 181 ; of muscle, 197-198 ; of proteins, 27  
 Coagulative ferments, 65  
 Cobalt sulphate, actions on proteins, 183  
 Cocaine, 60  
 Cocoa, 60, 159  
 Coffee, 60, 159  
 Coffin-lid crystals, 155, 157  
 Cola nut, 60  
 Collagen, 43, 81  
 Collimator, 116  
 Colloid carbohydrates, salting out of, 21  
 Colloidal solution, 36 ; substances, 237, 238  
 Colloids, 37, 38, 243  
 Colostrum, 4, 53  
 Colostrum corpuscles, 53  
 Commercial peptone, 37, 107  
 Complement, 124  
 Compounds found in the body, 4  
 Condiments, 60  
 Conjugated proteins, 41, 44  
 Cooking of food, 59  
 Copper, 3, 8  
 Cream, 49, 53  
 Creatine, 32, 60, 110, 152, 200 ; in muscle, 200  
 Creatinine, 30, 110, 142, 145, 148, 149, 152, 168, 174, 210 ; detection of, 142 ; estimation of, 211  
 Cresol, 66  
 Croft Hill on ferments, 66  
 Crypts of Lieberkühn, 84  
 Crystallin, 43

Crystalline lens, 43  
 Crystallisable proteins, 38, 112, 113, 187, 191  
 Crystallisation of egg albumin, 38, 180  
 Crystalloids, 38, 238  
 Crystals from blood, 112, 113, 187, 191  
 Curative inoculation, 121  
 Curd, 54, 181  
 Curds and whey, 54  
 Cyclopterine, 42  
 Cystin, 34, 35, 162, 163, 165; crystals of, 164  
 Cystinuria, 164  
 Cytosine, 34, 46

## D

DECALCIFIED blood, 101, 104, 194  
 Decalcified milk, 49, 181  
 Decomposition products of fats, 25  
 Density of water, 8  
 Dentine, composition of, 43  
 Deposits in urine, 162-165  
 Desiccator, 199  
 Deutero-albumose, 75, 77  
 Deutero-proteose, 81, 168, 172, 187  
 Dextrin, 13, 16, 21, 68, 171, 178; tests for, 21  
 Dextro-rotatory, 17; quartz, 226  
 Dextrose, 13, 16, 17, 88, 110, 168, 171, 177, 178; crystals, 17; in blood, 17, 110; in urine, 166, 168  
 Diabetes mellitus, 17, 87  
 Diabetic coma, 88  
 Diabetic urine, 88, 166, 168  
 Diacetin, 25  
 Dialyser, 37  
 Dialysis, 37, 38, 192, 236, 238, 239; of proteoses, 182; of serum, 192  
 Di-amino acids, 32, 34  
 Di-amino-caproic acid, 32  
 Di-amino-valeric acid, 32, 150  
 Diastase, 65  
 Diastatic ferments, 19, 68, 179  
 Diet, 51  
 Diet tables, 51  
 Dietary, 51  
 Diffusion, 130, 236, 238  
 Digestion, 184; gastric, 62, 70-77; intestinal, 84-86; pancreatic, 78-84; salivary, 62-70  
 Dimethylxanthine, 159  
 Dioxy-purine, 159  
 Dipeptide, 36  
 Diphtheria-toxin, 122  
 Direct-vision spectroscope, 117  
 Disaccharides, 16, 18, 66  
 Dissociation, 236, 237; of oxygen, 133  
 Disuse atrophy, 203

Divalent elements, 236  
 Dough, 58  
 Dripping, 59  
 Dropsical effusions, 45  
 Dulcite, 15  
 Dumb-bell crystals, 157  
 Dupré's urea apparatus, 141  
 Dysalbumose, 182

## E

ECK'S fistula, 149  
 Edestin, 35  
 Egg-albumin, 35, 43, 96; crystallisation of, 180  
 Egg-globulin, 27, 28  
 Eggs, 50, 56  
 Egg-white, 27, 28, 62, 78  
 Egg yolk, 44  
 Ehrlich's experiments with methylene blue, 128; hypothesis, 123  
 Elastic fibres, 44  
 Elastin, 44, 75, 81, 95  
 Elastoses, 75  
 Electrolytes, 237  
 Electrolytic action, 238  
 Elements found in the body, 3; symbols and atomic weights of, 8  
 Emulsification, 23, 25, 99  
 Emulsion, 82  
 Enamel, composition of, 43  
 Endogenous metabolism, 149; uric acid, 160  
 English system of weights and measures, 6, 7  
 Entero-kinase, 84, 105, 186  
 Envelope crystals, 156  
 Enzymes, 63, 66, 67, 68  
 Epidermis, 2  
 Epithelium of intestine, 98, 99  
 Epsom salts, 153  
 Erepsin, 97, 161  
 Erlenmeyer flask, 211  
 Erythro-dextrin, 21, 68, 179  
 Esbach's albuminometer, 5, 166: reagent, 5; tube, 166  
 Estimation of chlorides, 205; of creatinine, 211; of dextrose, 166, 167; of lactose, 19, 179; of maltose, 20, 179; of nitrogen, 235; of phosphates, 207; of sulphates, 208; of urea, 204; of uric acid, 210  
 Ethereal sulphates in urine, 153, 154; estimation of, 208  
 Ethyl alcohol, 24  
 Ethyl-diacetic acid, 88, 168  
 Eu-globulin, 193  
 Exogenous katabolism, 148  
 Exogenous uric acid, 160



Expired air, 126  
 External respiration, 126  
 Extirpation of pancreas, 87  
 Extractives of blood, 110; of muscle, 60  
 Extraordinary ray, 222

## F

FÆCES, 94  
 Fahrenheit scale, 7  
 Fatigue, 201  
 Fat, 2, 96; absorption of, 99; constitution, 24; decomposition products of, 25; melting point of, 23; tests for, 22; digestion of, 100  
 Fat-splitting ferment, 80  
 Fats, 4, 22-26, 78, 93; of milk, 55  
 Fatty acids, 22, 94, 100  
 Fehling's test, 13, 17, 19, 168; solution, 166  
 Ferment coagulation, 40  
 Ferment, invert, 84  
 Ferment of ferments, 84  
 Fermentation, 63  
 Fermentation test, 13, 169  
 Ferments, 63-67; of gastric juice, 65; of pancreatic juice, 65; of saliva, 65; of succus entericus, 65; organised, 64; unorganised, 65  
 Ferments, classification of, 64; diastatic, 19, 68, 179  
 Fertilisation, 237  
 Fibres, elastic, 44  
 Fibrin, 78, 101, 103, 106, 108, 184  
 Fibrin ferment, 40, 65, 101, 103, 104, 105, 106, 108, 109, 110; preparation of, 101  
 Fibrin filaments, 103  
 Fibrinogen, 43, 104, 106, 108, 109, 172  
 Fibrino-globulin, 104  
 Filtration, 236, 237  
 Fischer on proteins, 31  
 Fistula, gastric, 70  
 Fleischl's hæmometer, 220; spectropolarimeter, 229  
 Flour, 50, 57, 58  
 Fluorescent screens, 191  
 Fluorine, 3  
 Folin's method of estimating urea, 204  
 Foods, 49; cooking of, 59; accessories of, 60  
 Formaldehyde, 4; reaction, 27, 39  
 Formic acid, 24  
 Fractional heat coagulation of muscle proteins, 198; of serum proteins, 192, 193  
 Fraunhofer's lines, 102, 115, 119  
 Fredericq on tension of carbon dioxide, 130

Free hydrochloric acid in gastric juice, tests for, 185  
 Fundus glands, 70, 71, 72  
 Fürth on muscle plasma, 195

## G

GALACTOSE, 15, 16, 18, 178, 201  
 Gallstones, 93  
 Gammee on photographic spectra, 190  
 Garrod and Hopkins on urobilin and stercobilin, 213, 214  
 Garrod on urochrome, 213  
 Garrod's method of separating pigments from urine, 213  
 Gas, analysis of, 234  
 Gaseous interchange in lungs, 128, 129, 130  
 Gases in blood, 109, 127  
 Gastric digestion, 62  
 Gastric fistula, 70  
 Gastric juice, 70, 85, 185; action of, 75; composition of, 73; glands, 70, 71; properties of, 74; secretion of, 70  
 Gastrin, 84  
 Gay-Lussac's law, 240  
 Gelatin, 30, 35, 43, 44, 75, 173; tests for, 30  
 Gelatinisation, 30  
 Gelatines, 75  
 Germ theory of disease, 63  
 Gliadin, 35, 48, 58  
 Globin, 42, 113  
 Globulicidal power, 122  
 Globulin, 37, 41, 42, 75, 77, 123, 171, 200  
 Globulose, 75  
 Glossopharyngeal nerve, 67  
 Gluco-proteins, 41, 45  
 Glucosamine, 45  
 Glucose, 16, 65, 96, 177, 178  
 Glutamic-acid, 32, 35, 81  
 Gluten, 48, 50, 58  
 Gluten-fibrin, 58  
 Glyceric ethers, 24  
 Glycerides, 24  
 Glycerin, 25, 85, 100; tests for, 22  
 Glycerol, 25  
 Glycine, 31, 35, 41, 91, 94, 150  
 Glycocholate of soda, 90, 91  
 Glycocholic acid, 91; preparation of, 79  
 Glycocine, *see* Glycine  
 Glycogen, 14, 21, 65, 96, 161, 171, 176, 177; microscopical detection of, 177; preparation of, 176; tests for, 14, 21  
 Glycol, 15  
 Glycolysis, 88  
 Glycosuria, 88  
 Glycuronic acid, 4, 87, 88, 169, 178  
 Glycyl, 36

Glyoxylic acid, 4, 27  
 Gmelin's test, 79, 92, 169  
 Gnezda on biuret reaction, 183  
 Goblet cells, 45  
 Gold, 8  
 Gowers, Sir William, his hæmacytometer, 217; hæmoglobinometer, 219  
 Graham, Thomas, on colloids and crystalloids, 38  
 Gram-molecular solutions, 238  
 Granulose, 20  
 Grape-sugar, *see* Dextrose  
 Green vegetables, 61  
 Ground substance, 30  
 Grützner's method of comparing digestive power of solutions of pepsin, 184  
 Guanase, 161  
 Guanine, 47, 159, 160, 161  
 Guarana, 60  
 Gums, 95  
 Gunsberg's reagent, 185  
 Gürber on serum albumin crystals, 39

## H

HEMACYTOMETER of Sir William Gowers, 217; of Oliver, 218  
 Hæmatin, 95, 113, 213; acid, 188; alkaline, 188; iron free, 191; of food, 143  
 Hæmatogen, 46  
 Hæmatoidin, 114; crystals, 89  
 Hæmatoporphyrin, 113, 191, 214, 215, 216; absorption bands of, 189, 215  
 Hæmatoscope of Hermann, 117  
 Hæmin, 101, 113; crystals, 113; preparations of, 102, 113  
 Hæmochromogen, 190, 200  
 Hæmoglobin, 11, 38, 92, 95, 102, 112, 114, 188; composition of, 113; derivatives of, 188  
 Hæmoglobinometer of Sir William Gowers, 219; Haldane, 220; of Oliver, 220  
 Hæmoglobinuria, 122, 170  
 Hæmopyrrol, 93, 113, 114  
 Hæmolysins, 122  
 Hæmometer of von Fleischl, 220  
 Haldane on methæmoglobin, 120; on absorption of oxygen, 130; on oxygen tension, 134  
 Haldane's hæmoglobinometer, 220  
 Hamburger on digestive action of juices, 184  
 Hammarsten's method of precipitating serum globulin, 192  
 Hammerschlag's method of estimating the specific gravity of blood, 222  
 Haptophor group, 123  
 Hayem's fluid, 219

Hay's test for bile salts, 79, 169  
 Heart muscle, 199  
 Heat coagulation of proteins, 37, 192, 193, 198; of serum globulin and serum albumin, 192, 193  
 Heat rigor, 198  
 Heidenhain on secretion of gastric juice, 72; on pressure in bile duct, 89  
 Heller's nitric acid test, 166  
 Henry-Dalton Law, 240  
 Heptoses, 16  
 Hermann, hæmatoscope of, 117  
 Hetero-albumose, 75, 76, 182; proteose, 81  
 Hexone bases, 33, 84, 150  
 Hexoses, 16  
 Hill's air-pump, 233  
 Hill, Croft, on ferments, 66  
 Hippuric acid, 162, 173; tests for, 162  
 Hirudin, 107, 195  
 Histidine, 32, 33, 41  
 Histone of Kossel, 41, 42, 113  
 Hofmeister on crystallisation of egg albumin, 38  
 Homogentisinic acid, 169  
 Hopkins's method of estimating uric acid, 158, 210; on Adamkiewicz reaction, 27; on crystallisation of egg albumin, 39, 180; reaction for lactic acid, 185  
 Hoppe-Seyler on proteins, 30  
 Hot-air oven, 176  
 Howell on rhythmical action, 237  
 Hüfner's method of estimating urea, 141  
 Hyaline cartilage, 44  
 Hydrazone, 177  
 Hydrobilirubin, 92, 93, 94, 143  
 Hydrocele fluid, 108  
 Hydrochinon, 216  
 Hydrochloric acid, 70; formation of, 71; of gastric juice, 72, 73; tests for, 185; tests for cane sugar, 13  
 Hydrogen, 3, 8; tests for, 9  
 Hydrolysis, 19, 75  
 Hydrolytic ferments, 65  
 Hydrometer, 49, 53, 141  
 Hydroxybutyric acid, 88, 168  
 Hydroxyl, 24  
 Hypertonic solutions, 242  
 Hypobromite of soda, action of, on urea, 141, 146  
 Hypotonic solutions, 242  
 Hypoxanthine, 47, 60, 159, 160, 161

## I

IMMUNE body, 124  
 Immunity, 121, 123; side chain, theory of, 123

Indican, 154, 216  
 Indiffusibility of proteins, 38, 244  
 Indigo, 154; blue, 216; red, 216  
 Indole, 85, 95, 154  
 Indole-amino-propionic acid, 39  
 Indoxyl, 154, 216  
 Indoxyl sulphate of potassium, 154, 216  
 Infection, 122, 123  
 Infra-proteins, 47, 48, 171  
 Inoculation, curative, and protective, 121-126  
 Inorganic compounds, 4; salts, 4  
 Inosite, 14, 18; crystals, 18  
 Inspired air, 126  
 Internal respiration, 126  
 Internal secretion of pancreas, 88  
 Interstitial substance, 30, 45  
 Intestinal juice, 18, 84; digestion, 84  
 Intravascular coagulation, 103, 105, 196  
 Inversion, 17, 18, 84  
 Inversion of cane sugar, 18, 65  
 Inversive ferments, 65, 66  
 Invertin, 65, 84  
 Involuntary muscle, 198  
 Iodine, 3, 8, 11  
 Iodine test, 13, 14, 176, 179  
 Ionic action, 237  
 Ionisation, 73  
 Ions, 73, 236, 240  
 Iron, 3, 8, 112, 113; in milk, 53  
 Iron-free hæmatin, 191  
 Islets of Langerhans, 79, 87  
 Iso-cholesterin, 93  
 Isotonic solutions, 241  
 Isotropic bodies, 223

## J

JAFFÉ on test for indoxyl, 216  
 Jaundice, 169  
 Jelly, Whartonian, 30  
 Johnson, G. S., on creatinine, 152; on sugar in urine, 167  
 Juice, intestinal, 18, 84  
 Junkets, 60

## K

KARYOKINESIS, 237  
 Katabolites, 30, 148  
 Kations, 236  
 Kauder's method of precipitating serum globulin, 192  
 Kephalin, 201  
 Keratin, 2, 11, 35, 44, 95  
 Ketone, 14  
 Ketoses, 15  
 Kidney, 142  
 Kidneys removal of part of, 87; removal of both, 147

Kjeldahl's method of estimating nitrogen, 235  
 Kossel on protamines, 41; on histone, 113  
 Koumiss, 56, 60  
 Kühn on precipitation of pepsin, 74  
 Külz's method of extracting glycogen, 176

## L

LACTALBUMIN, 42, 54, 181; properties of, 54  
 Lacteals, 95, 99  
 Lactic acid, 4, 53, 56, 60, 95, 158, 185; Hopkins's reaction for, 185, 197; tests for, 185  
 Lactic acid fermentation, 19; in milk, 56; in muscle, 197; organisms, 19  
 Lacto-globulin, 181  
 Lactometer, 49  
 Lactose, 13, 16, 19, 49, 56, 65, 171, 177, 178; in urine, 168; tests for, 19, 177  
 Laky blood, 112  
 Lanoline, 93  
 Lard, 22  
 Lateritious deposit, 156  
 Laurent's polarimeter, 228  
 Lead, 3, 8  
 Lecithin, 3, 4, 10, 25, 26, 56, 85, 91, 93, 111, 155, 201  
 Leech extract, 107, 194  
 Lethal dose, 122  
 Leucine, 31, 80, 81, 84, 85, 86, 148, 165, 187; as a urea precursor, 150; tests for, 187  
 Leucine crystals, 86, 150; preparation of, 187  
 Leucocytes, 160, 161  
 Leucocythæmia, 160  
 Leucyl, 36  
 Levo-rotatory, 17; quartz, 226  
 Levulose, 16, 17, 171, 177; in blood, 17; in muscle, 17; in urine, 17; reactions of, 17  
 Lieberkühn's crypts, 84; jelly, 48  
 Liebermann's reaction, 79  
 Liebig's extract, 200  
 Lime water, 30  
 Lipochrome, 55, 56, 200; in muscle, 200  
 Lipolytic ferments, 65  
 Liquor pancreaticus, 78, 187; pepticus, 62  
 Lithates, *see* Urates, 156  
 Lithium, 3, 8  
 Litre, standard of capacity, 7  
 Liver, function of, in relation to urea, 147; uric acid, 158  
 Living test-tube experiment, 109

Loeb on ionic action, 237; on fertilisation, 237  
 Loewy's aërotonometer, 132  
 Lungs, 126  
 Lymph formation, 242  
 Lysine, 32, 33, 81

## M

McMunn on stercobilin, 95  
 McWilliam's test for proteins, 183  
 Magnesium, 3, 8  
 Magnesium phosphate, 165  
 Magnesium sulphate, action of, on proteins, 27, 40, 49  
 Malic acid, 231  
 Mallow, 18  
 Malpighian capillaries, 142  
 Malt upon starch, action of, 179; diastase, 179  
 Maltase, 65  
 Malting ferment, 179  
 Maltose, 13, 16, 19, 65, 66, 68, 78, 171, 177, 178, 179  
 Maly on the formation of hydrochloric acid, 72, 73  
 Mammary glands, 84, 88  
 Manganese, 3, 8  
 Mannite, 15  
 Mannose, 15  
 Marchi reaction, 202  
 Marsh gas, 65  
 'Mass Action,' 73  
 Measures of capacity, 7; of length, 7  
 Meat, 50, 52, 57; constituents of, 57  
 Meconium, 95  
 Melanin, 216  
 Mercurial air-pumps, 231  
 Mercury, 8  
 Metabolism, 2  
 Meta-proteins, *see* Infra-proteins  
 Methæmoglobin, 114, 119, 170, 172, 191; in urine, 170  
 Methane, 65, 85  
 Methyl-indole, 34  
 Methyl-glycine, 32  
 Methylene blue experiments, 128  
 Methyl-guanidine acetic acid, 32  
 Methyl-orange, 235  
 Metric system, 7  
 Mett's tubes, 184  
 Microchemical detection of glycogen, 177  
 Micrococcus urea, 66  
 Microspectroscope, 117  
 Milk, 23, 49, 50, 52, 53, 181; alcoholic fermentation of, 56; coagulation of, 54, 181; composition of, 54; fats of,

54; proteins of, 54; salts of, 56; souring of, 56; sugar, 56  
 Milk-curdling, ferment of pancreas, 80, 82; of stomach, 49, 54, 55  
 Milk-sugar, 19, 49, 56; crystals, 19, 96  
 Millon's reagent, 5, 27; test, 27; reaction, 39  
 Mineral compounds, 3  
 Mohr's method of estimating chlorides, 205  
 Monoatomic alcohols, 24  
 Monoacetin, 25  
 Monoamino-acids, 32, 34  
 Monoamino-caproic acid, 32  
 Monochromatic light, 228  
 Monosaccharides, 16, 17, 66  
 Monovalent, 236  
 Monoxypurine, 159  
 Moore and Rockwood on fat absorption, 100  
 Moore on osmotic pressure of proteins, 243  
 Moore's test for sugar, 13, 17  
 Mörner and Sjöqvist's method of estimating urea, 204  
 Morris and Brown on starch digestion, 68  
 Mucedin, 58  
 Mucic acid, 18, 178  
 Mucin, 2, 30, 45, 67, 68, 91, 94, 95, 173; in bile, 91; in saliva, 62, 67; in urine, 162; tests for, 62  
 Mucinogen, 67  
 Mucoids, 45  
 Mucous glands, structure of, 45, 69  
 Mucous membrane of frog's intestine, 99  
 Mucous salivary glands, 69  
 Mucus, 170  
 Munk on fat absorption, 100  
 Murex, 157  
 Murexide test, 156  
 Muscle, 199; clot, 198; pigments of, 199; plasma of, 197; extractives of, 200  
 Muscle, cardiac, 237  
 Muscle fibrin, 198  
 Muscle sugar, 18  
 Muscle tissue, 197  
 Muscles, pale and red, 199; involuntary, 198  
 Muscular movement, 2; exercise and carbonic acid, 136  
 Mutton, 57  
 Myogen, 198; myogen fibrin, 198  
 Myo-hæmatin, 199, 200; absorption spectrum of, 200  
 Myosin, 4, 57, 75, 197, 198; fibrin, 198  
 Myosinogen, 37, 198  
 Myxœdema, 87

## N

- NEGATIVE effect, 104  
 Nencki and Sieber on pigments, 113  
 Nencki's experiment on urea, 150  
 Nerve degeneration, chemistry of, 201  
 Nervous impulse, 238  
 Nervous tissue, 197, 200; composition of, 200  
 Neurokeratin, 44  
 Neutral fats, 23  
 Neutral salts, action of, on carbohydrates, 21; on proteins, 27, 28, 37, 43, 49, 77, 101, 102, 182, 192, 193  
 Nickel, 8  
 Nickel sulphate, action of, on proteins, 183  
 Nicol's prism, 223  
 Nissl's bodies, 201  
 Nitrate of urea, 146, 156  
 Nitric oxide hæmoglobin, 114, 120  
 Nitrogen, 3, 8; estimation of, 235; tests for, 9, 10  
 Nitrogenous food, 50, 51; glucosides, 201  
 Nitrous acid, action of, on urea, 146  
 Non-electrolytes, 237  
 Nuclease, 161  
 Nucleic acid, 45, 46; decomposition of, 47  
 Nuclein, 3, 45, 155, 160, 161  
 Nucleo-protein, 3, 10, 41, 45, 46, 91, 103, 105, 109, 173, 196, 200; in bile, 79, 91; decomposition of, 47; in muscle, 198; tests for, 79, 173  
 Nucleus, functions of, 2

## O

- OATMEAL, 52  
 Oleic acid, 24  
 Olein, 23, 55, 203  
 Olfactory nerve, 67  
 Oliver's hæmacytometer, 218; hæmoglobinometer, 220  
 Opsonins, 125  
 Orcin reaction, 178  
 Ordinary ray, 222  
 Organic compounds, 4  
 Organised ferments, 64  
 Ornithine, 32, 150, 161  
 Osazones, 177  
 Osborne, W. A., on coagulation of milk, 55  
 Osmic acid test, 22, 24  
 Osmium, 8  
 Osmosis, 38, 236, 239  
 Osmotic pressure, 238, 239, 243; calculation of, 240; of proteins, 243; determination of, by freezing point, 241; physiological application, 242

- Ossein, 43  
 Osteomalacia, 168  
 Ovarian cyst fluid, 45  
 Ovo-mucoid, 56  
 Oxalate of calcium, in milk, 47, 55; plasma, 106; in urine, 156, 164  
 Oxalate of urea, 146, 156  
 Oxidases, 66, 161  
 Oxygen, 3, 8; in blood, 128; tension, 137  
 Oxyhæmoglobin, 101, 102, 112, 113, 114, 169, 170, 172, 188, 191; crystals, 102, 112, 187; in muscle, 200; preparation of, 191  
 Oxyhæmoglobin pure, preparation of, 191  
 Oxyntic cells of fundus glands, 70, 72, 73  
 Oxyphenyl-alanine, 34

## P

- PALE muscle, 199  
 Palmitic acid, 24  
 Palmitin, 23, 55  
 Pancreas, extirpation of, 87; grafting the, 87; structure of, 79, 80  
 Pancreatic digestion, 78, 186, 187; secretion, 186  
 Pancreatic juice, 81, 85; action of, 78, 81; composition of, 80; secretion of, 83  
 Panum's method of precipitating serum globulin, 192  
 Paraglobulin, *see* Serum globulin  
 Para-mucin, 45  
 Paramyosinogen, 43, 197, 198  
 Parietal cells of fundus glands, 70, 71  
 Parotid gland, 67  
 Partial pressure of gases, 126-140  
 Pasteur on circular polarisation, 230  
 Pathological urine, 166; pigments of, 216; pigments, 216  
 Pavy on glycogenic function of liver 96, 176; an estimation of sugar, 167  
 Pavy's solution, 167  
 Pawlow on secretory nerve-fibres to the gastric glands, 74; to the pancreas, 83  
 Peas, 58  
 Pentoses, 16, 178  
 Pepsin, 65, 70, 72, 74, 81; solutions, activity of, 184; hydrochloric acid, 70, 74, 82  
 Pepsinogen, 72  
 Peptic digestion, 75, 185  
 Peptides, 86  
 Peptone, 28, 31, 37, 47, 65, 75, 76, 77, 85, 96, 107, 171, 187, 195; precipitation of, 76; in urine, 168; tests for, 27, 76

- Peptone blood, 195  
 Peptonuria, 168  
 Perfect foods, 50, 53  
 Pericardial fluids, 108  
 Pettenkofer's test for bile salts, 79, 91, 92, 169  
 Pflüger's mercurial air-pump, 231, 232  
 Phagocytes, 121, 122  
 Phenol, 66, 85, 95  
 Phenolphthalein, 22; phenyl-alanine, 33, 34, 98  
 Phenyl sulphate of potassium, 154  
 Phenyl-hydrazine test for sugar, 177  
 Phloretin, 88  
 Phloridzin, 88; diabetes, 88  
 Phloroglucin reaction, 178  
 Phosphates of urine, 141, 154, 156, 163; estimation of, 207; tests for, 141, 156, 163, 165  
 Phosphates, stellar, 155, 156, 164, 165  
 Phosphates, triple, 155, 156, 164, 165  
 Phospho-molybdic acid, 182  
 Phospho-proteins, 41, 44  
 Phosphorised fat, 201  
 Phosphorus, 3, 8, 11; tests for, 10  
 Phospho-tungstic acid, 182  
 Photographic spectra, 191  
 Physiological chemistry, 1  
 Physiological proximate principles, detection of, 171  
 Pickering on colour reactions of proteins, 183  
 Picramic acid, 17  
 Picric acid, 17; tests for sugar, 17, 167  
 Pigment of red corpuscles, 110-114; of muscle, 199; of urine, 213, 215  
 Pigments, pathological, 215  
 Pilocarpine, administration of, 80, 187  
 Piotrowski's reaction, 27, 41, 183  
 Plain muscle, 198, 199  
 Plasma, constituents of, 109; gases of, 109; proteins of, 109  
 Plasma of blood, 101, 103, 108, 109, 194; of muscle, 197  
 Plasmon, 186  
 Platinum, 8  
 Pleochromatism, 225  
 Poisonous alkaloids, 85  
 Polarimeters, 178, 226; of Laurent, 228; of Soleil, 227; of Zeiss, 228  
 Polarisation, circular, and chemical constitution, 230  
 Polarisation of light, 222  
 Polariscopes, 226  
 Polarised light, 222; action of carbohydrates on, 16, 17, 18, 19; of proteins, 39  
 Polarising microscope, 224  
 Polypeptides, 31, 36, 47  
 Polysaccharides, 16, 20  
 Pork, 57  
 Portal vein, 89  
 Positive phase, 104  
 Potash, method of extracting glycogen, 176; of showing zymogen granules, 187  
 Potassio-mercuric iodide, 182  
 Potassium, 3, 8  
 Potassium caseinogenate, 55  
 Potassium ferricyanide in preparation of methæmoglobin, 188  
 Potassium ferrocyanide in the estimation of phosphate, 207  
 Potassium permanganate in estimation of uric acid, 210, 211  
 Potassium sulphocyanide in saliva, 62, 68  
 Potatoes, 52  
 Precipitants of proteins, 39, 40, 182, 183  
 Precipitation, 40  
 Precipitin, 125  
 Prévost and Dumas on formation of urea, 147  
 Primary albumoses, 75; proteoses, 75  
 Principal cells of stomach, 70, 71  
 Prisms in direct-vision spectroscope, 117  
 Propionic acid, 24, 31, 33  
 Prosecretin, 83, 186  
 Prosthetic group, 44  
 Protagon, 201  
 Protamines, 41, 42  
 Protective inoculation, 121  
 Protein-hydrolysis, 47  
 Protein metabolism, 3  
 Proteins, 3, 9, 11, 27-48, 57, 68; 81, 85, 93, 96, 98, 123, 171, 238, 244; absorption of, 96, 97; classification of, 41; coagulated, 37; coagulation of, 37; colour reactions of, 27, 39; composition of, 3, 30; conjugated, 44; crystallisation of, 38; definition of, 30; digestion of, by gastric juice, 75; digestion of, by pancreatic juice, 81; heat coagulation of, 37; of blood plasma, 109; of milk, 54; of muscle, 197, 198; of serum, 109; osmotic pressure of, 243; in urine, 168; precipitants of, 27, 39, 40; sclero-, 43; simple solubilities of, 36; tests for, 14, 36, 182, 183  
 Protein-sparing food, 44  
 Proteolytic ferments, 74; enzymes, 74, 81, 161  
 Proteoses, 31, 37, 47, 65, 75, 76, 77, 79, 97, 107, 171, 172, 182, 195; in urine, 168  
 Prothrombin, 105  
 Proto-albumoses, 75, 76, 182  
 Protones, 41  
 Protoplasm, chemical structure of, 3; properties of, 2

Proximate principles, classification of, 4 ;  
of food, 50 ; scheme for detecting,  
171-174

Pseudo-globulin, 193, 198

Pseudo-mucin, 45

Ptomaines, 63

Ptyalin, 19, 65, 68, 69

Pulses, 58

Pumps, mercurial air-, 231-234

Purine bases, 44, 46, 47, 159, 161

Purpurate of ammonia, 156

Pus in urine, 170 ; tests for, 170

Putrefaction, 19, 66, 85

Pyloric glands, 70, 71

Pyrimidine bases, 34

Pyrocatechin, 216

Pyrolidine derivatives, 34

## Q

QUADRIURATES, 158

Quantitative estimation of albumin, 166 ;  
of chlorides, 205 ; of creatinine, 211 ;  
of dextrose, 167 ; of glycogen, 176,  
177 ; of lactose, 19, 179 ; of maltose,  
20, 179 ; of nitrogen, 235 ; of phos-  
phates, 209 ; of sulphates, 210 ; of  
sugar, 167 ; of urea, 205 ; of uric acid,  
210

## R

RANKE'S diet, 51

Reagents necessary for practical work,  
4, 5, 6

Réaumur's scale, 7

Receptor group, 123

Red blood corpuscles, 110 ; composition  
of, 110 ; pigment of, 110

Red muscle, 199

Reflex action, 67

Reid, Weymouth, on absorption, 243

Rennet, 40, 60, 65, 72

Rennin, 60, 72, 82

Reproduction, 2

Resins, 95

Respiration, chemical stimulus to, 138 ;  
chemistry of, 126 ; in excised tissues,  
138

Respiratory oxygen of hæmoglobin, 114

Respiratory pigments, 112

Respiratory quotient, 127

Reversible action, 66

Rhythmical contraction, 237

Ricin, 123

Rigor mortis, 198

Ringed amino-acids, 34

Ringer on contractile tissue, 237

Riva on urochrome, 143

Roberts, Sir William, on estimation of  
sugar in urine, 169

Rockwood and Moore on fat absorption,  
100

Rose's test for protein, 27, 41, 183

Rosenheim's formaldehyde reaction, 27

## S

SACCHARIC acid, 18

Saccharimeters, 230

Saccharoses, 16, 65, 84

St. Martin, Alexis, case of, 70

Salicyl-sulphonic acid, action of, on  
proteins, 183

Saliva, 30, 62, 67 ; action of, 68, 70 ;  
composition of, 67 ; secretion of, 67

Salivary corpuscles, 67 ; glands, 2, 67,  
69, 107

Salkowski's reaction for cholesterin, 79,  
93 ; method of estimating sulphates,  
209

Salmine, 42

Salted plasma, 101

Salted whey, 54

Salting-out of colloid carbohydrates, 21  
of proteins, 40, 55, 193

Salts of milk, 56

Saponification, 22, 82, 99

Sarcine, 159

Sarcolemma, 44

Sarco-lactic acid, 197

Sarcosine, 32

Schäfer on fat absorption, 98, 99

Schiff on bile circulation, 90, 94 test  
for uric acid, 156

Schizomycetes, forms of, 64

Schmalz's capillary picnometer, 222

Schmidt, Alexander, on precipitating  
serum globulin, 192 ; on salts of  
plasma, 110 ; on preparation of fibrin-  
ferment, 110

Schröder's work on urea, 150

Schütz's law, 184

Schwann, white substance of, 93

Sclero-proteins, 41, 43

Sebum, 93

Secretion, 83, 84, 89, 186

Secretion, internal, 87

Sediments in urine, 165

Semipermeable membranes, 239

Serine, 32

Serous glands, 69

Serum, 101, 103, 108, 192 ; albumin,  
35, 37, 42, 101, 109, 168 ; crystallisa-  
tion of, 38 ; gases of, 109 ; heat  
coagulation, 37, 42, 193

Serum, bactericidal, globulicidal, 124

Serum casein, 192

- Serum globulin, 35, 37, 42, 43, 101, 102, 109, 168; heat coagulation, 192, 193  
 Serum lutein, 101  
 Serum of blood, 101, 102; proteins of, 101, 102  
 Serum proteins, 109; separation of, 101  
 Sheep's wool-fat, 93  
 Shell of eggs, 56  
 Side-chain theory, 123  
 Silicon, 3, 8  
 Silver, 8  
 Silver nitrate method of estimating chlorides, 205  
 Skatole, 34, 85, 95  
 Skatoxyl, 216; red, 216  
 Skimmed milk, 49, 53  
 Smoky urine, 169  
 Snake venom, 64, 121, 122  
 Soap, 22, 25, 82, 90, 100  
 Sodium, 3, 8  
 Sodium bicarbonate in blood, 129, 130  
 Sodium chloride, 3; action on proteins, 109, 182; on nucleo-proteins, 46, 196  
 Sodium hypobromite, method of estimating urea, 141, 142  
 Sodium phosphate, 29, 30; acid, 144  
 Sodium sulphate plasma, 101, 104  
 Solar spectrum, 119, 189  
 Soleil's saccharimeter, 227  
 Soluble starch, 20  
 Solutions, 236  
 Sorbite, 15  
 Soret's band, 191  
 Soup, 60  
 Souring of milk, 56, 63  
 Specific gravity of blood, 222; of milk, 49, 53; of urine, 141, 144  
 Specific rotatory power, 229  
 Spectra, 189; of hæmoglobin and its derivatives, 189; photographic, of methæmoglobin, 190, 191; oxyhæmoglobin, and hæmoglobin, 190, 191; of urinary pigments, 215  
 Spectro-polarimeter, 229  
 Spectroscope, 115, 116, 117  
 Spectrum, 119, 189, 215  
 Spermatozoa, 41  
 Starch, 4, 13, 20, 65, 93, 95, 238; soluble, 21; action of malt on, 179; digestion of, 68, 70; test for, 20, 171  
 Starling and Bayliss on pancreatic secretion, 83  
 Starling on osmotic pressure of proteins, 243  
 Steapsin, 25, 65, 78, 80, 82, 85; action of, 78, 82  
 Stearic acid, 24  
 Stearin, 23, 55  
 Steatolytic ferments, 65  
 Stein's method of making oxyhæmoglobin crystals, 112  
 Stellar phosphates, 156  
 Stercobilin, 92, 94, 95, 143  
 Stewart, G. N., dietary, 51, 52  
 Stirling on preparation of pure oxyhæmoglobin, 191  
 Stokes's fluid, 115, 188  
 Stomach, glands of, 71, 72  
 Strontium, 8  
 Sturine, 42  
 Sublingual gland, 67  
 Submaxillary gland, 67, 68, 69  
 Succus entericus, 84  
 Sucroses, 16  
 Sudan III. stain, 24  
 Sugar, 4, 9, 13, 17-20, 87, 237; cane, 13, 18, 79; in blood, 110; in urine, 167, 168; in muscle, 18; tests for, 166, 174  
 Sugar-maple, 18  
 Sulphates of urine, 141, 153; estimation of, 208; tests for, 141  
 Sulphonal poisoning, 214  
 Sulphur, 3, 8; tests for, 10  
 Suprarenal gland, removal of, 87  
 Suspending medium, 23  
 Sweetbreads, 160  
 Swim-bladder of fishes, 131  
 Symbols and atomic weights, 8  
 Syntonin, 30, 48, 62, 75

## T

- TANNIN, 61, 182  
 Tapetum, 160  
 Tartaric acid, 144  
 Taurine, 91, 94  
 Tauro-carbamic acid, 94  
 Taurocholate of soda, 90, 91  
 Taurocholic acid, 91  
 Tchistovitch's experiment, 125  
 Tea, 60, 61, 159  
 Teichmann's crystals, 113  
 Tendo-mucoid, 45  
 Tendon, 30  
 Tension in fluids, measurement of, 132  
 Tension of aqueous vapour, 8; of gases, 128, 130, 131  
 Tension, relation of, to composition, 132  
 Testis, 196; removal of, 87  
 Tetrapeptides, 36  
 Tetroses, 16  
 Theine, 60  
 Theobromine, 60, 159  
 Theophylline, 159  
 Thermometric scales, 7  
 Thrombin, 104, 105, 106, 108  
 Thrombogen, 105, 106, 107, 108



- Thrombo-kinase, 105, 106, 107, 108, 196  
 Thrombosis, 105  
 Thudichum on urochrome, 213  
 Thymine, 34  
 Thymus, 159, 196  
 Thyroid gland, 87; removal of, 87  
 Tin, 8  
 Tissue-fibrinogens, 196  
 Tissue metabolism, 149  
 Tissue respiration, 126, 134, 136  
 Tomes on enamel, 43  
 Tooth, 43  
 Töpfer's test, 185  
 Torricellian vacuum, 114  
 Torula ureæ, 145  
 Torulæ, 63, 145  
 Toxins, 122, 123  
 Transitory glucosuria, 167  
 Triacetin, 25  
 Triatomic alcohol, 25  
 Trichloracetic acid as a precipitant of proteins, 183  
 Trimethyl-xanthine, 159  
 Triolein, 25  
 Trioses, 16  
 Trioxy-purine, 159  
 Tripalmitin, 25  
 Tripeptides, 36  
 Triple phosphate, 156, 165  
 Tristearin, 25  
 Trivalent elements, 236  
 Trommer's test, 13, 17, 18, 19, 20  
 Tropæolin test, 185  
 Trypsin, 65, 80, 81, 82, 84, 97; action of, 81  
 Trypsinogen, 80, 84, 186  
 Tryptophan, 33, 34, 35, 81, 187; test for, 187  
 Tungsten, 8  
 Tunicates, 21  
 Tyrosine, 33, 34, 35, 42, 80, 81, 84, 86, 165, 187; crystals, 86; in urine, 165; tests for, 187
- U
- UFFELMANN'S reaction, 185  
 Umbilical cord, 30  
 Uncrystallisable sugar, 17  
 Unorganised ferments, 64, 66, 68  
 Uracil, 46  
 Uræmia, 147  
 Uranium acetate in estimation of phosphates, 207  
 Uranium nitrate in estimation of phosphates, 207  
 Urate, acid ammonium, deposit of, 163; acid sodium, deposit of, 163  
 Urates, 156, 163, 165, 168, 214
- Urea, 4, 12, 30, 32, 87, 94, 97, 98, 110, 141, 145-151, 161, 173, 237; composition and compounds, 146; crystals of, 145; decomposition of, 66; estimation of, 204; mode and site of formation, 147; preparation of, 205; quantity excreted, 143; tests for, 141, 145; where formed, 147  
 Urea nitrate, 146, 156; preparation of, 156  
 Urea oxalate, 146, 156; preparation of, 156  
 Uric acid, 110, 145, 156, 157-161, 159, 160, 165, 173; crystals of, 157; estimation of, 158, 210; origin of, 158; preparation of, 157, 210; tests for, 156, 157  
 Uricolytic ferment, 161  
 Urina potus, 144  
 Urinary deposits, 162  
 Urine, 141; composition of, 144, 145, 173; inorganic constituents of, 153, 173; pigments of, 143, 213; tests for abnormal constituents of, 174; tests for constituents, 142, 156  
 Urinometer, 141, 144  
 Urobilin, 92, 93, 143, 169, 213, 214, 216; absorption bands of, 215  
 Urobilinogen, 143, 213  
 Urochrome, 143, 213; uro-erythrin, 156, 214; absorption bands of, 215  
 Urorosein, 216; absorption bands of, 215
- V
- VALERIC acid, 24, 32, 85  
 Van 't Hoff on polarisation of light, 231; hypothesis, 240  
 Vegetable acids, 4, 144; food, composition of, 58; parchment, 37  
 Vegetables, composition of, 58; green, 61  
 Velocity of chemical reactions, 67, 82  
 Venous blood, gases of, 127  
 Villus, section of, 98, 99  
 Vinegar, 63  
 Vital action, 242  
 Vitellin, 38, 44, 56, 58, 75  
 Vitellose, 75  
 Vitreous humour, 30  
 Voit's diet, 51, 146  
 Voluntary muscle, 199
- W
- WALLER'S modification of Zuntz's gas apparatus, 234  
 Warm bath, 29  
 Water in protoplasm, 3, 4; density of, 8

Wave theory of light, 222  
 Weights and measures, 6, 7  
 Whartonian jelly, 30  
 Whetstones, 156  
 Whey, 49, 54 ; salted, 49  
 Whey protein, 54  
 White blood corpuscles, 110, 196  
 White of egg, 3, 27, 29, 37, 38, 43, 45, 62, 78, 180  
 Whole flour, 57, 58  
 Widal's reaction, 124  
 Witte's peptone, 182  
 Wöhler, preparation of urea, 145  
 Wooldridge on tissue-fibrinogen, 46, 196  
 'Worth' of corpuscles, 222

## X

XANTHINE, 47, 80, 110, 159-161  
 Xanthine group, 46, 159

Xanthoproteic test, 27, 39  
 Xylose, 178

## Y

YEAST, action of, 17, 19, 66 ; cells, 63 ;  
 in bread-making, 58 ; in testing for  
 sugar, 169  
 Yellow lipochrome, 200  
 Yolk of eggs, 56

## Z

ZEIN, 35, 48  
 Zeiss's polarimeter, 228  
 Zinc, 8  
 Zuntz's gas apparatus, 234  
 Zymogen, 70, 72, 80, 105, 187 ; granules,  
 187

# A LIST OF WORKS ON MEDICINE, SURGERY AND GENERAL SCIENCE

## CONTENTS

	PAGE
BACTERIOLOGY ... ..	12
BIOLOGY ... ..	8
CHEMISTRY ... ..	14
HEALTH AND HYGIENE ... ..	11
MEDICINE ... ..	2
MISCELLANEOUS ... ..	13
OPTICS ... ..	13
PHOTOGRAPHY ... ..	13
PHYSIOLOGY ... ..	8
SURGERY ... ..	2
TEXT-BOOKS OF PHYSICAL CHEMISTRY ... ..	16
VETERINARY MEDICINE ... ..	8
ZOOLOGY ... ..	8

LONGMANS, GREEN, & CO.

39 PATERNOSTER ROW, LONDON, E.C.

91 AND 93 FIFTH AVENUE, NEW YORK

8 HORNBY ROAD, BOMBAY

303 BOWBAZAR STREET, CALCUTTA

## MEDICINE, SURGERY, ETC.

**ASHBY AND WRIGHT.** THE DISEASES OF CHILDREN, MEDICAL AND SURGICAL. By HENRY ASHBY, M.D. Lond., F.R.C.P., Physician to the Manchester Children's Hospital; Lecturer and Examiner in Diseases of Children in the Victoria University; and G. A. WRIGHT, B.A., M.B. Oxon., F.R.C.S. Eng., Surgeon to the Manchester Royal Infirmary; Consulting Surgeon to the Manchester Children's Hospital; Professor of Surgery in the Victoria University. With 15 Plates (1 Coloured) and 241 Illustrations in the Text. 8vo, 21s. net.

**BAIN.** A TEXT-BOOK OF MEDICAL PRACTICE FOR PRACTITIONERS AND STUDENTS. By Various Contributors. Edited by WILLIAM BAIN, M.D., M.R.C.P. With 75 Illustrations. Royal 8vo, 25s. net.

\* \* \* Apart from the practical character of the book, the special features are that the anatomy, histology, and physiology of each organ or system precede the description of its diseases, and that the various sections are contributed by general physicians and specialists.

**BAIN AND EDGEcombe.** THE PHYSIOLOGY AND THERAPEUTICS OF THE HARROGATE WATERS, BATHS, AND CLIMATE APPLIED TO THE TREATMENT OF CHRONIC DISEASE. By WILLIAM BAIN, M.D. Durh., M.R.C.P. Lond., and WILFRID EDGEcombe, M.D. Lond. 8vo, 7s. 6d. net.

**BENNETT.**—*WORKS* by Sir WILLIAM H. BENNETT, K.C.V.O., F.R.C.S., Surgeon to St. George's Hospital; Member of the Board of Examiners, Royal College of Surgeons of England.

RECURRENT EFFUSION INTO THE KNEE-JOINT AFTER INJURY, WITH ESPECIAL REFERENCE TO INTERNAL DERANGEMENT, COMMONLY CALLED SLIPPED CARTILAGE: an Analysis of 750 Cases. A Clinical Lecture delivered at St. George's Hospital. With 13 Illustrations. 8vo, 3s. 6d.

CLINICAL LECTURES ON VARICOSE VEINS OF THE LOWER EXTREMITIES. With 3 Plates. 8vo, 6s.

ON VARICOCELE: A PRACTICAL TREATISE. With 4 Tables and a Diagram. 8vo, 5s.

CLINICAL LECTURES ON ABDOMINAL HERNIA: chiefly in relation to Treatment, including the Radical Cure. With 12 Diagrams in the Text. 8vo, 8s. 6d.

ON VARIX, ITS CAUSES AND TREATMENT, WITH ESPECIAL REFERENCE TO THROMBOSIS: an Address delivered at the Inaugural Meeting of the Nottingham Medico-Chirurgical Society, Session 1898-9. 8vo, 3s. 6d.

**MEDICINE, SURGERY, ETC.—continued.**

**BENNETT.**—WORKS by Sir WILLIAM H. BENNETT—continued.

ON THE USE OF MASSAGE AND EARLY PASSIVE MOVEMENTS IN RECENT FRACTURES AND OTHER COMMON SURGICAL INJURIES: THE TREATMENT OF INTERNAL DERANGEMENTS OF THE KNEE-JOINT: THE MANAGEMENT OF STIFF JOINTS: Three Clinical Lectures delivered at St. George's Hospital. With 17 Illustrations. 8vo, 6s.

THE PRESENT POSITION OF THE TREATMENT OF SIMPLE FRACTURES OF THE LIMBS: an Address delivered in opening a Discussion at the Meeting of the British Medical Association held at Ipswich, August, 1900. To which is appended a Summary of the Opinions and Practice of about 300 Surgeons. 8vo, 2s. 6d.

**CABOT.** A GUIDE TO THE CLINICAL EXAMINATION OF THE BLOOD FOR DIAGNOSTIC PURPOSES. By RICHARD C. CABOT, M.D., Physician to Out-Patients, Massachusetts General Hospital. With 3 Coloured Plates and 28 Illus. in Text. 8vo, 16s.

**CHEYNE AND BURGHARD.** A MANUAL OF SURGICAL TREATMENT. By W. WATSON CHEYNE, C.B., M.B., F.R.C.S., F.R.S., Professor of Clinical Surgery in King's College, London; Surgeon to King's College Hospital, and the Children's Hospital, Paddington Green, etc.; and F. F. BURGHARD, M.D. and M.S. Lond., F.R.C.S., Teacher of Practical Surgery in King's College, London; Surgeon to King's College Hospital, and the Children's Hospital, Paddington Green, etc.

**PART I.** The treatment of General Surgical Diseases, including inflammation, suppuration, ulceration, gangrene, wounds and their complications, infective diseases and tumours; the administration of anæsthetics. With 66 Illustrations. Royal 8vo, 9s. net.

**PART II.** The treatment of the Surgical Affections of the Tissues, including the skin and subcutaneous tissues, the nails, the lymphatic vessels and glands, the fasciæ, bursæ, muscles, tendons and tendon-sheaths, nerves, arteries and veins; deformities. With 141 Illustrations. Royal 8vo, 12s. net.

**PART III.** The treatment of the Surgical Affections of the Bones. Amputations. With 100 Illustrations. Royal 8vo, 10s. 6d. net.

**PART IV.** The treatment of the Surgical Affections of the Joints (including excisions) and the spine. With 138 Illustrations. Royal 8vo, 12s. net.

**PART V.** The treatment of the Surgical Affections of the head, face, jaws, lips, larynx and trachea; and the Intrinsic Diseases of the nose, ear and larynx, by H. LAMBERT LACK, M.D. (Lond.), F.R.C.S., Surgeon to the Hospital for Diseases of the Throat, Golden Square, and to the Throat and Ear Department, the Children's Hospital, Paddington Green. With 145 Illustrations. Royal 8vo, 15s. net.

**PART VI.**—Section 1. The Surgical Affections of the tongue and floor of the mouth, the pharynx, neck, œsophagus, stomach and intestines. With an Appendix on the Examination of the Blood in Surgical Condition. By W. ESTE EMERY, M.D., D.Sc. (Lond.). With 124 Illustrations. Royal 8vo, 15s. net.  
Section 2. The Surgical Affections of the rectum, the liver, pancreas and spleen, and genito-urinary organs, the breast and the thorax. With 113 Illustrations. Royal 8vo, 18s. net.

MEDICINE, SURGERY, ETC.—*continued.*

**COATS.** A MANUAL OF PATHOLOGY. By JOSEPH COATS, M.D., late Professor of Pathology in the University of Glasgow. Revised throughout and Edited by LEWIS R. SUTHERLAND, M.D., Professor of Pathology, University of St. Andrews. With 729 Illustrations and 2 Coloured Plates. 8vo, 28s. net.

**COOKE.**—WORKS by THOMAS COOKE, F.R.C.S. Eng., B.A., B.Sc., M.D. Paris, late Senior Assistant Surgeon to the Westminster Hospital.

TABLETS OF ANATOMY. Being a Synopsis of demonstrations given in the Westminster Hospital Medical School. Eleventh Edition in three Parts, thoroughly brought up to date, and with over 700 Illustrations from all the best sources, British and Foreign. Post 4to. Part I. The Bones, 7s. 6d. net; Part II. Limbs, Abdomen, Pelvis, 10s. 6d. net; Part III. Head and Neck, Thorax, Brain, 10s. 6d. net.

APHORISMS IN APPLIED ANATOMY AND OPERATIVE SURGERY. Including 100 Typical *vivâ voce* Questions on Surface Marking, etc. Crown 8vo, 3s. 6d.

**DAKIN.** A HANDBOOK OF MIDWIFERY. By WILLIAM RADFORD DAKIN, M.D., F.R.C.P., Obstetric Physician and Lecturer on Midwifery at St. George's Hospital, Examiner in Midwifery and Diseases of Women on the Conjoint Board of the Royal Colleges of Physicians and Surgeons in England, etc. With 394 Illustrations. Large crown 8vo, 18s.

**DICKINSON.**—WORKS by W. HOWSHIP DICKINSON, M.D. Cantab., F.R.C.P., Consulting Physician to St. George's Hospital; Consulting Physician to the Hospital for Sick Children, etc.

ON RENAL AND URINARY AFFECTIONS. Complete in Three Parts, 8vo, with 12 Plates, and 122 Woodcuts. £3 4s. 6d.

THE TONGUE AS AN INDICATION OF DISEASE; being the Lumleian Lectures delivered at the Royal College of Physicians in March, 1888. 8vo, 7s. 6d.

OCCASIONAL PAPERS ON MEDICAL SUBJECTS, 1855-1896. 8vo, 12s.

**DOCKRELL.** AN ATLAS OF DERMATOLOGY: showing the Appearances, Clinical and Microscopical, Normal and Abnormal, of Conditions of the Skin. 60 Coloured Plates and Descriptive Letterpress. By MORGAN DOCKRELL, M.A., M.D. (Dub. Univ.), Senior Physician and Chesterfield Lecturer on Dermatology to St. John's Hospital for Diseases of the Skin. Fcp. folio, 50s. net.

\* \* \* The plate showing the clinical appearance of each disease appears on the same page with that displaying the microscopical. The descriptive letterpress in each case is as brief as possible.

**FOWLER AND GODLEE.** THE DISEASES OF THE LUNGS. By JAMES KINGSTON FOWLER, M.A., M.D., F.R.C.P., Physician to the Middlesex Hospital and to the Hospital for Consumption and Diseases of the Chest, Brompton, etc.; and RICKMAN JOHN GODLEE, M.S., F.R.C.S., Honorary Surgeon-in-Ordinary to His Majesty, Fellow and Professor of Clinical Surgery, University College, London, etc. With 160 Illustrations. 8vo, 25s.

**MEDICINE, SURGERY, ETC.—continued.**

**GARROD. THE ESSENTIALS OF MATERIA MEDICA AND THERAPEUTICS.**

By Sir ALFRED BARING GARROD, M.D., F.R.S., etc.; Consulting Physician to King's College Hospital; late Vice-President of the Royal College of Physicians. Fourteenth Edition, Revised and Edited, under the Supervision of the Author, by NESTOR TIRARD, M.D. Lond., F.R.C.P., Professor of Materia Medica and Therapeutics in King's College, London, etc. Crown 8vo, 12s. 6d.

**GOODSALL AND MILES. DISEASES OF THE ANUS AND RECTUM.**

By D. H. GOODSALL, F.R.C.S., late Senior Surgeon Metropolitan Hospital, Senior Surgeon St. Mark's Hospital; and W. ERNEST MILES, F.R.C.S., Assistant Surgeon to the Cancer Hospital, Surgeon (out-patients) to the Gordon Hospital, etc. (In Two Parts).

**PART I.**—Anatomy of the Ano-rectal Region—General Diagnosis—Abscess—Ano-rectal Fistula—Recto-urethral, Recto-vesical and Recto-vaginal Fistulae—Sinus over the Sacro-coccygeal Articulation—Fissure—Hæmorrhoids (External and Internal). With 91 Illustrations. 8vo, 7s. 6d. net.

**PART II.**—Prolapse of the Rectum—Invagination of the Rectum—Ulceration—Stricture of the Anus and of the Rectum—Malignant Growths of the Anus and Rectum—Benign Tumours of the Anus and Rectum—Foreign Bodies in the Rectum—Pruritus Ani—Syphilis of the Anus and Rectum. With 44 Illustrations. 8vo, 6s. net.

**GRAY. ANATOMY, DESCRIPTIVE AND SURGICAL.**

By HENRY GRAY, F.R.S., late Lecturer on Anatomy at St. George's Hospital Medical School. The Sixteenth Edition Enlarged, edited by T. PICKERING PICK, F.R.C.S., Consulting Surgeon to St. George's Hospital, etc., and by ROBERT HOWDEN, M.A., M.B., C.M., Professor of Anatomy in the University of Durham, etc. With 811 Illustrations, a large proportion of which are coloured, the Arteries being coloured red, the Veins blue, and the Nerves yellow. The attachments of the muscles to the bones, in the section on Osteology, are also shown in coloured outline. Royal 8vo, 32s. net.

**HARE. THE FOOD FACTOR IN DISEASE:**

Being an investigation into the humoral causation, meaning, mechanism and rational treatment, preventive and curative, of the Paroxysmal Neuroses (migraine, asthma, angina pectoris, epilepsy, etc.), bilious attacks, gout, catarrhal and other affections, high blood-pressure, circulatory, renal and other degenerations. By FRANCIS HARE, M.D., late Consulting Physician to the Brisbane General Hospital; Visiting Physician at the Diamantina Hospital for Chronic Diseases, Brisbane; Inspector-General of Hospitals for Queensland. 2 vols. Medium 8vo, 30s. net.

**LACK. THE DISEASES OF THE NOSE AND ITS ACCESSORY SINUSES.**

By H. LAMBERT LACK, M.D. Lond., F.R.C.S. Eng., Surgeon to the Throat Department, London Hospital; Surgeon to the Hospital for Diseases of the Throat, Golden Square; Lecturer on Diseases of the Throat, London Hospital Medical College (University of London). With 124 Illustrations. Medium 8vo, 25s.

**LANG. THE METHODICAL EXAMINATION OF THE**

**EYE.** Being Part I. of a Guide to the Practice of Ophthalmology for Students and Practitioners. By WILLIAM LANG, F.R.C.S. Eng., Surgeon to the Royal London Ophthalmic Hospital, Moorfields, etc. With 15 illustrations. Crown 8vo, 3s. 6d.

MEDICINE, SURGERY, ETC.—*continued.*

**LUFF.** TEXT-BOOK OF FORENSIC MEDICINE AND TOXICOLOGY. By ARTHUR P. LUFF, M.D., B.Sc. Lond., Physician in Charge of Out-Patients and Lecturer on Medical Jurisprudence and Toxicology in St. Mary's Hospital; Examiner in Forensic Medicine in the University of London; External Examiner in Forensic Medicine in the Victoria University; Official Analyst to the Home Office. With 13 full-page Plates (1 in colours) and 33 Illustrations in the Text. 2 vols., Crown 8vo, 24s.

**PROBYN-WILLIAMS.** A PRACTICAL GUIDE TO THE ADMINISTRATION OF ANÆSTHETICS. By R. J. PROBYN-WILLIAMS, M.D., Anæsthetist and Instructor in Anæsthetics at the London Hospital; Lecturer in Anæsthetics at the London Hospital Medical College, etc. With 34 Illustrations. Crown 8vo, 4s. 6d. net.

**QUAIN.** QUAIN'S (JONES) ELEMENTS OF ANATOMY. The Tenth Edition. Edited by EDWARD ALBERT SCHÄFER, F.R.S., Professor of Physiology in the University of Edinburgh; and GEORGE DANCER THANE, Professor of Anatomy in University College, London.

\* \* The several parts of this work form COMPLETE TEXT-BOOKS OF THEIR RESPECTIVE SUBJECTS. They can be obtained separately as follows:—

VOL. I., PART I. EMBRYOLOGY. By E. A. SCHÄFER, F.R.S. With 200 Illustrations. Royal 8vo, 9s.

VOL. I., PART II. GENERAL ANATOMY OR HISTOLOGY. By E. A. SCHÄFER, F.R.S. With 491 Illustrations. Royal 8vo, 12s. 6d.

VOL. II., PART I. OSTEOLOGY — ARTHROLOGY. By G. D. THANE. With 224 Illustrations. Royal 8vo, 11s.

VOL. II., PART II. MYOLOGY — ANGEIOLOGY. By G. D. THANE. With 199 Illustrations. Royal 8vo, 16s.

VOL. III., PART I. THE SPINAL CORD AND BRAIN. By E. A. SCHÄFER, F.R.S. With 139 Illustrations. Royal 8vo, 12s. 6d.

VOL. III., PART II. THE NERVES. By G. D. THANE. With 102 Illustrations. Royal 8vo, 9s.

VOL. III., PART III. THE ORGANS OF THE SENSES. By E. A. SCHÄFER, F.R.S. With 178 Illustrations. Royal 8vo, 9s.

VOL. III., PART IV. SPLANCHNOLOGY. By E. A. SCHÄFER, F.R.S., and JOHNSON SYMINGTON, M.D. With 337 Illustrations. Royal, 8vo, 16s.

APPENDIX. SUPERFICIAL AND SURGICAL ANATOMY. By Professor G. D. THANE and Professor R. J. GODLEE, M.S. With 29 Illustrations. Royal 8vo, 6s. 6d.



MEDICINE, SURGERY, ETC.—*continued.*

**QUAIN.** QUAIN'S (SIR RICHARD) DICTIONARY OF MEDICINE. By Various Writers. Edited by H. MONTAGUE MURRAY, M.D., F.R.C.P., Joint Lecturer on Medicine, Charing Cross Medical School, and Physician to Charing Cross Hospital, and to the Victoria Hospital for Children, Chelsea; Examiner in Medicine to the University of London. Assisted by JOHN HAROLD, M.B., B.Ch., B.A.O., Physician to St. John's and St. Elizabeth's Hospital, and Demonstrator of Medicine at Charing Cross Medical School, and W. CECIL BOSANQUET, M.A., M.D., F.R.C.P., Assistant Physician, Charing Cross Hospital, etc. Third and Cheaper Edition, largely Rewritten, and Revised throughout. With 21 Plates (14 in Colour) and numerous Illustrations in the Text. 8vo, 21s. net., buckram; 30s. net., half-morocco.

**SCHÄFER.** THE ESSENTIALS OF HISTOLOGY: Descriptive and Practical. For the Use of Students. By E. A. SCHÄFER, F.R.S., Professor of Physiology in the University of Edinburgh. With 553 Illustrations some of which are Coloured. 8vo, 10s. 6d. net.

**SMALE AND COLYER.** DISEASES AND INJURIES OF THE TEETH, including Pathology and Treatment. By MORTON SMALE, M.R.C.S., L.S.A., L.D.S., Dental Surgeon to St. Mary's Hospital, Consulting Dental Surgeon, Dental Hospital of London, etc.; and J. F. COLYER, L.R.C.P., M.R.C.S., L.D.S., Dental Surgeon to Charing Cross Hospital and to the Dental Hospital of London, Dean of the School, Dental Hospital of London. Second Edition Revised and Enlarged by J. F. COLYER. With 640 Illustrations. Large Crown 8vo, 21s. net.

**SMITH (H. F.).** THE HANDBOOK FOR MIDWIVES. By HENRY FLY SMITH, B.A., M.B. Oxon., M.R.C.S. Second Edition. With 41 Woodcuts. Crown 8vo, 5s.

**STEVENSON.** WOUNDS IN WAR: the Mechanism of their Production and their Treatment. By Surgeon-General W. F. STEVENSON, C.B. (Army Medical Staff), B.A., M.B., M.Ch. Dublin University; Professor of Military Surgery, Royal Army Medical College, London. With 127 Illustrations. 8vo, 15s. net.

**TAPPEINER.** INTRODUCTION TO CHEMICAL METHODS OF CLINICAL DIAGNOSIS. By Dr. H. TAPPEINER, Professor of Pharmacology and Principal of the Pharmacological Institute of the University of Munich. Translated from the Sixth German Edition, with an Appendix on Micro-Biological Methods of Diagnosis, by EDMOND J. McWEENEY, M.A., M.D. Royal Univ. of Ireland, L.R.C.P.I., etc. With 22 Illustrations. Crown 8vo, 3s. 6d.

## VETERINARY MEDICINE, ETC.

**FITZWYGRAM. HORSES AND STABLES.** By Lieutenant-General Sir F. FITZWYGRAM, Bart. With 56 pages of Illustrations. 8vo, 3s. net.

**HAYES. TRAINING AND HORSE MANAGEMENT IN INDIA.** With Hindustanee Vocabulary. By M. HORACE HAYES, F.R.C.V.S. (late Captain, "The Buffs"). With Portrait. Crown 8vo, 8s. net.

**STEEL.**—*WORKS* by JOHN HENRY STEEL, F.R.C.V.S., F.Z.S., A.V.D., late Professor of Veterinary Science and Principal of Bombay Veterinary College.

A TREATISE ON THE DISEASES OF THE DOG; being a Manual of Canine Pathology. Especially adapted for the use of Veterinary Practitioners and Students. With 88 Illustrations. 8vo, 10s. 6d.

A TREATISE ON THE DISEASES OF THE OX; being a Manual of Bovine Pathology. Especially adapted for the use of Veterinary Practitioners and Students. With 2 Plates and 117 Woodcuts. 8vo, 15s.

A TREATISE ON THE DISEASES OF THE SHEEP; being a Manual of Ovine Pathology for the use of Veterinary Practitioners and Students. With Coloured Plate and 99 Woodcuts. 8vo, 12s.

**YOUATT.**—*WORKS* by WILLIAM YOUATT.

THE HORSE. Revised and Enlarged by W. WATSON, M.R.C.V.S. With 52 Wood Engravings. 8vo, 7s. 6d.

THE DOG. Revised and Enlarged. With 33 Wood Engravings. 8vo, 6s.

## PHYSIOLOGY, BIOLOGY, ZOOLOGY, ETC.

**ASHBY. NOTES ON PHYSIOLOGY FOR THE USE OF STUDENTS PREPARING FOR EXAMINATION.** By HENRY ASHBY, M.D. (Lond), F.R.C.P., Physician to the General Hospital for Sick Children, Manchester; Lecturer and Examiner in Diseases of Children in the Victoria University. With 148 Illustrations. 18mo, 5s.

**BARNETT. THE MAKING OF THE BODY:** a Children's Book on Anatomy and Physiology. By Mrs. S. A. BARNETT. With 113 Illustrations. Crown 8vo, 1s. 9d.

**BEDDARD. ELEMENTARY PRACTICAL ZOOLOGY.** By FRANK E. BEDDARD, M.A. (Oxon.). With 93 Illustrations. Crown 8vo, 2s. 6d.

**BIDGOOD. A COURSE OF PRACTICAL ELEMENTARY BIOLOGY.** By JOHN BIDGOOD, B.Sc., F.L.S. With 226 Illustrations. Crown 8vo, 4s. 6d.

**PHYSIOLOGY, BIOLOGY, ZOOLOGY, ETC.—continued.**

**BOSE.**—*WORKS* by JAGADIS CHUNDER BOSE, M.A. (Cantab.), D.Sc. (Lond.), Professor, Presidency College, Calcutta.

RESPONSE IN THE LIVING AND NON-LIVING. With 117 Illustrations. 8vo, 10s. 6d.

PLANT RESPONSE AS A MEANS OF PHYSIOLOGICAL INVESTIGATION. With 278 Illustrations. 8vo, 21s.

ELECTRO-PHYSIOLOGY OF PLANTS. [In the press.

**BRODIE.** THE ESSENTIALS OF EXPERIMENTAL PHYSIOLOGY. For the use of Students. By T. G. BRODIE, M.D., Lecturer on Physiology, St. Thomas's Hospital Medical School. With 2 Plates and 177 Illustrations in the Text. Crown 8vo, 6s. 6d.

**CHAPMAN.** THE FORAMINIFERA: AN INTRODUCTION TO THE STUDY OF PROTOZOA. By FREDERICK CHAPMAN, A.L.S., F.R.M.S., formerly Assistant in the Geological Laboratory of the Royal College of Science; Palæontologist to the National Museum, Melbourne. With 14 Plates and 42 Illustrations in the Text. 8vo, 9s. net.

**FURNEAUX.** HUMAN PHYSIOLOGY. By W. FURNEAUX, F.R.G.S. With 223 Illustrations. Crown 8vo, 2s. 6d.

**HALLIBURTON.**—*WORKS* by W. D. HALLIBURTON, M.D., F.R.S., F.R.C.P., Professor of Physiology in King's College, London.

A TEXT-BOOK OF CHEMICAL PHYSIOLOGY AND PATHOLOGY. With 104 Illustrations. 8vo, 28s.

THE ESSENTIALS OF CHEMICAL PHYSIOLOGY. For the Use of Students. With 83 Illustrations. 8vo, 4s. 6d. net.

**HUDSON AND GOSSE.** THE ROTIFERA OR "WHEEL ANIMALCULES". By C. T. HUDSON, LL.D., and P. H. GOSSE, F.R.S. With 30 Coloured and 4 Uncoloured Plates. In 6 Parts. 4to, price 10s. 6d. each; Supplement, 12s. 6d. Complete in Two Volumes, with Supplement, 4to, £4 4s.

\* \* The Plates in the Supplement contain figures of almost all the Foreign Species, as well as of the British Species, that have been discovered since the original publication of Vols. I. and II.

**LLOYD.** THE TEACHING OF BIOLOGY IN THE SECONDARY SCHOOL. By FRANCIS E. LLOYD, A.M., and MAURICE A. BIGELOW, Ph.D., Professors in Teachers' College, Columbia University. Crown 8vo, 6s. net.

**MACALISTER.**—*WORKS* by ALEXANDER MACALISTER, M.D.

AN INTRODUCTION TO THE SYSTEMATIC ZOOLOGY AND MORPHOLOGY OF VERTEBRATE ANIMALS. With 41 Diagrams. 8vo, 10s. 6d.

ZOOLOGY OF THE INVERTEBRATE ANIMALS. With 77 Diagrams. Fcp. 8vo, 1s. 6d.

ZOOLOGY OF THE VERTEBRATE ANIMALS. With 59 Diagrams. Fcp. 8vo, 1s. 6d.

**PHYSIOLOGY, BIOLOGY, ZOOLOGY, ETC.—continued.**

**MACDOUGALL.**—WORKS by DANIEL TREMBLY MACDOUGALL, Ph.D.

TEXT-BOOK OF PLANT PHYSIOLOGY. With 159 Illustrations. 8vo, 7s. 6d. net.

ELEMENTARY PLANT PHYSIOLOGY. With 108 Illustrations. Crown 8vo, 3s.

**MOORE.** ELEMENTARY PHYSIOLOGY. By BENJAMIN MOORE, D.Sc., Professor of Biological Chemistry in the University of Liverpool. Crown 8vo, 3s. 6d.

**MORGAN.** ANIMAL BIOLOGY. An Elementary Text-Book. By C. LLOYD MORGAN, F.R.S., Principal of University College, Bristol. With numerous Illustrations. Crown 8vo, 8s. 6d.

**SCHÄFER.** DIRECTIONS FOR CLASS WORK IN PRACTICAL PHYSIOLOGY: Elementary Physiology of Muscle and Nerve and of the Vascular and Nervous Systems. By E. A. SCHÄFER, LL.D., F.R.S., Professor of Physiology in the University of Edinburgh. With 48 Diagrams. 8vo, 3s. net.

**THORNTON.**—WORKS by JOHN THORNTON, M.A.

HUMAN PHYSIOLOGY. With 284 Illustrations, some of which are Coloured. Crown 8vo, 6s.

ELEMENTARY BIOLOGY, Descriptive and Experimental. With numerous Illustrations. Crown 8vo, 3s. 6d.

ELEMENTARY PRACTICAL PHYSIOLOGY. With 178 Illustrations (6 of which are Coloured). Crown 8vo, 3s. 6d.

**WALLER.**—WORKS by AUGUSTUS D. WALLER, M.D., F.R.S., Hon. LL.D. Edin., Lecturer on Physiology at St. Mary's Hospital Medical School, London; late External Examiner at the Victorian University.

AN INTRODUCTION TO HUMAN PHYSIOLOGY. With 314 Illustrations. 8vo, 18s.

LECTURES ON PHYSIOLOGY.

FIRST SERIES.—On Animal Electricity. 8vo, 5s. net.

**WALLER AND SYMES.** EXERCISES IN PRACTICAL PHYSIOLOGY. By AUGUSTUS D. WALLER, M.D., F.R.S.

PART I.—Elementary Physiological Chemistry. 8vo, sewed, 1s. net.

PART II.—Exercises and Demonstrations in Chemical and Physical Physiology. By AUGUSTUS D. WALLER and W. LEGGE SYMES. 8vo, 2s. 6d. net.

PART III.—Physiology of the Nervous System, Electro-Physiology. By AUGUSTUS D. WALLER. With 60 Illustrations. 8vo, 2s. 6d. net.

## HEALTH AND HYGIENE, ETC.

**ASHBY.** HEALTH IN THE NURSERY. By HENRY ASHBY, M.D., F.R.C.P., Physician to the General Hospital for Sick Children, Manchester; Lecturer and Examiner in Diseases of Children in the Victoria University. With 25 Illustrations. Crown 8vo, 3s. net.

**BRODRIBB.** MANUAL OF HEALTH AND TEMPERANCE. By T. BRODRIBB, M.A. Compiled, Revised and Edited by the Rev. W. RUTHVEN PYM, M.A. Crown 8vo, 1s. 6d.

**BUCKTON.** HEALTH IN THE HOUSE. By Mrs. C. M. BUCKTON. With 41 Woodcuts and Diagrams. Crown 8vo, 2s.

**CORFIELD.** THE LAWS OF HEALTH. By W. H. CORFIELD, M.A., M.D. Fcp. 8vo, 1s. 6d.

**FURNEAUX.** ELEMENTARY PRACTICAL HYGIENE. Section I. By WILLIAM S. FURNEAUX. With 146 Illustrations. Crown 8vo 2s. 6d.

**NOTTER AND FIRTH.**—WORKS by J. L. NOTTER, M.A., M.D., and R. H. FIRTH, F.R.C.S.

HYGIENE. With 99 Illustrations. Crown 8vo, 4s. 6d.

PRACTICAL DOMESTIC HYGIENE. With 84 Illustrations. Crown 8vo, 2s. 6d.

**POORE.**—WORKS by GEORGE VIVIAN POORE, M.D., F.R.C.P.

THE EARTH IN RELATION TO THE PRESERVATION AND DESTRUCTION OF CONTAGIA: being the Milroy Lectures delivered at the Royal College of Physicians in 1899, together with other Papers on Sanitation. 13 Illustrations. Crown 8vo, 5s.

ESSAYS ON RURAL HYGIENE. With 12 Illustrations. Crown 8vo, 6s. 6d.

THE DWELLING HOUSE. With 36 Illustrations. Crown 8vo, 3s. 6d.

COLONIAL AND CAMP SANITATION. With 11 Illustrations. Crown 8vo, 2s. net.

**PORTER.** SCHOOL HYGIENE AND THE LAWS OF HEALTH: a Text-Book for Teachers and Students in Training. By CHARLES PORTER, M.D., B.Sc., M.R.C.P. (Edin.); of the Middle Temple, Barrister-at-Law; Assistant Medical Officer of Health, and Chief Sanitary Inspector, Leeds. With Illustrations. Crown 8vo, 3s. 6d.

**ROBINSON.** THE HEALTH OF OUR CHILDREN IN THE COLONIES: a Book for Mothers. By LILIAN AUSTEN ROBINSON, M.D. Crown 8vo, 2s. 6d. net.

## BACTERIOLOGY, ETC.

- CURTIS.** THE ESSENTIALS OF PRACTICAL BACTERIOLOGY: an Elementary Laboratory Work for Students and Practitioners. By H. J. CURTIS, B.S. and M.D. Lond., F.R.C.S., formerly Surgeon to the North-Eastern Hospital for Children; Assistant Surgeon, Royal Hospital for Children and Women, Waterloo Road; Surgical Registrar and Assistant to the Professor of Pathology, University College, London. With 133 Illustrations. 8vo, 9s.
- FRANKLAND.** MICRO-ORGANISMS IN WATER, THEIR SIGNIFICANCE, IDENTIFICATION AND REMOVAL. Together with an Account of the Bacteriological Methods Involved in their Investigation. Specially Designed for the Use of those connected with the Sanitary Aspects of Water Supply. By Professor PERCY FRANKLAND, Ph.D., B.Sc. Lond., F.R.S., Fellow of the Chemical Society; and Mrs. PERCY FRANKLAND, Joint Author of "Studies on Some New Micro-Organisms Obtained from Air". With 2 Plates and numerous Diagrams. 8vo, 16s. net.
- FRANKLAND.** BACTERIA IN DAILY LIFE. By Mrs. PERCY FRANKLAND, F.R.M.S. Crown 8vo, 5s. net.
- GOADBY.** THE MYCOLOGY OF THE MOUTH: A TEXT-BOOK OF ORAL BACTERIA. By KENNETH W. GOADBY, L.D.S. Eng., D.P.H. Camb., L.R.C.P., M.R.C.S., Bacteriologist and Lecturer on Bacteriology, National Dental Hospital, etc. With 82 Illustrations. 8vo, 8s. 6d. net.
- KLÖCKER.** FERMENTATION ORGANISMS. A Laboratory Handbook. By ALB. KLÖCKER, Assistant in the Carlsberg Laboratory, Copenhagen. Translated from the German by G. E. ALLAN, B.Sc., Lecturer in the University of Birmingham, and J. H. MILLAR, F.I.C., formerly Lecturer in the British School of Malting and Brewing, and revised by the Author. With 146 Illustrations. 8vo, 12s. net.
- PLIMMER.** THE CHEMICAL CHANGES AND PRODUCTS RESULTING FROM FERMENTATION. By R. H. ADERS PLIMMER, D.Sc. Lond. 8vo, 6s. net.

## OPTICS, PHOTOGRAPHY, ETC.

**ABNEY.** A TREATISE ON PHOTOGRAPHY. By Sir WILLIAM DE WIVELESLE ABNEY, K.C.B., F.R.S., Principal Assistant Secretary of the Secondary Department of the Board of Education. With 134 Illustrations. Crown 8vo, 5s.

**DRUDE.** THE THEORY OF OPTICS. By PAUL DRUDE, Professor of Physics at the University of Giessen. Translated from the German by C. RIBORG MANN and ROBERT A. MILLIKAN, Assistant Professors of Physics at the University of Chicago. With 110 Diagrams. 8vo, 15s. net.

**GLAZEBROOK.** PHYSICAL OPTICS. By R. T. GLAZEBROOK, M.A., F.R.S., Principal of University College, Liverpool. With 183 Woodcuts of Apparatus, etc. Crown 8vo, 6s.

**VANDERPOEL.** COLOUR PROBLEMS: A Practical Manual for the Lay Student of Colour. By EMILY NOYES VANDERPOEL. With 117 Plates in Colour. Square 8vo, 21s. net.

**WRIGHT.** OPTICAL PROJECTION: A Treatise on the Use of the Lantern in Exhibition and Scientific Demonstration. By LEWIS WRIGHT, Author of "Light: a Course of Experimental Optics". With 232 Illustrations. Crown 8vo, 6s.

## MISCELLANEOUS.

**INQUIRY (AN) INTO THE PHENOMENA ATTENDING DEATH BY DROWNING AND THE MEANS OF PROMOTING RESUSCITATION IN THE APPARENTLY DROWNED.** Report of a Committee appointed by the Royal Medical and Chirurgical Society. With 2 Diagrams and 26 Folding-out Plates. 8vo, 5s. net.

**HOBART.** THE MEDICAL LANGUAGE OF ST. LUKE. By the Rev. WILLIAM KIRK HOBART, LL.D. 8vo, 16s.

**PAGET.** MEMOIRS AND LETTERS OF SIR JAMES PAGET, Bart., F.R.S., D.C.L., late Sergeant-Surgeon to Her late Majesty Queen Victoria. Edited by STEPHEN PAGET, F.R.C.S. With Portrait. 8vo, 6s. net.

**POOLE.** COOKERY FOR THE DIABETIC. By W. H. and Mrs. POOLE. With Preface by Dr. PAVY. Fcap. 8vo, 2s. 6d.

## CHEMISTRY, ETC.

- ARMITAGE.** A HISTORY OF CHEMISTRY. By F. P. ARMITAGE, M.A., F.C.S., late Exhibitioner of Magdalen College, Oxford, Assistant Master at St. Paul's School. Crown 8vo, 6s.
- ARRHENIUS.** A TEXT-BOOK OF ELECTRO-CHEMISTRY. By SVANTE ARRHENIUS, Professor of Physics at the University of Stockholm. Translated from the German Edition by JOHN McCRAE, Ph.D. With 58 Illustrations. 8vo, 9s. 6d. net.
- CROOKES.** SELECT METHODS IN CHEMICAL ANALYSIS (chiefly inorganic). By Sir W. CROOKES, F.R.S. With 68 Illustrations. 8vo, 21s. net.
- FINDLAY.** PHYSICAL CHEMISTRY AND ITS APPLICATIONS IN MEDICAL AND BIOLOGICAL SCIENCE. Being a Course of Seven Lectures delivered in the University of Birmingham. By ALEX. FINDLAY, M.A., Ph.D., D.Sc., Lecturer on Physical Chemistry, University of Birmingham. Royal 8vo, 2s. net.
- GREGORY.** A SHORT INTRODUCTION TO THE THEORY OF ELECTROLYTIC DISSOCIATION. By J. C. GREGORY, B.Sc. (Lond.), A.I.C. Crown 8vo, 1s. 6d.
- MENDELÉEFF.** THE PRINCIPLES OF CHEMISTRY. By D. MENDELÉEFF. Translated from the Russian (Seventh Edition) by GEORGE KAMENSKY, A.R.S.M., of the Imperial Mint, St. Petersburg, and Edited by THOMAS H. POPE, B.Sc., F.I.C. With 110 Illustrations. 2 vols. 8vo, 32s. net
- MEYER.** OUTLINES OF THEORETICAL CHEMISTRY. By LOTHAR MEYER, Professor of Chemistry in the University of Tübingen. Translated by Professors P. PHILLIPS BEDSON, D.Sc., and W. CARLETON WILLIAMS, B.Sc. 8vo, 9s.
- MUIR.** A COURSE OF PRACTICAL CHEMISTRY. By M. M. P. MUIR, M.A., Fellow and Prælector in Chemistry of Gonville and Caius College, Cambridge. (3 Parts.)  
Part I. Elementary. Crown 8vo, 4s. 6d.  
Part II. Intermediate. Crown 8vo, 4s. 6d.
- NEWTN.**—WORKS by G. S. NEWTH, F.I.C., F.C.S., Demonstrator in the Royal College of Science, London.  
CHEMICAL LECTURE EXPERIMENTS. With 230 Illustrations. Crown 8vo, 6s.  
CHEMICAL ANALYSIS, QUANTITATIVE AND QUALITATIVE. With 102 Illustrations. Crown 8vo, 6s. 6d.  
SMALLER CHEMICAL ANALYSIS. Crown 8vo, 2s.  
A TEXT-BOOK OF INORGANIC CHEMISTRY. With 15 Illustrations. Crown 8vo, 6s. 6d.  
ELEMENTARY PRACTICAL CHEMISTRY. With 108 Illustrations and 254 Experiments. Crown 8vo, 2s. 6d.



CHEMISTRY, ETC.—*continued.*

**PERKIN.**—*WORKS* by F. MOLLWO PERKIN, Ph.D., Head of the Chemistry Department, Borough Polytechnic Institute, London.

QUALITATIVE CHEMICAL ANALYSIS (ORGANIC AND INORGANIC). With 15 Illustrations and Spectrum Plate. 8vo, 4s.

PRACTICAL METHODS OF ELECTRO-CHEMISTRY. 8vo, 6s. net. V344

**RADCLIFFE AND SINNATT.** A SYSTEMATIC COURSE OF PRACTICAL ORGANIC CHEMISTRY. By LIONEL GUY RADCLIFFE, F.C.S., Lecturer in Organic Chemistry, Municipal School of Technology, Manchester, with the assistance of FRANK STURDY SINNATT, F.C.S., Lecturer and Demonstrator in Chemistry, Municipal School of Technology, Manchester. 8vo, 4s. 6d.

**REYNOLDS.** EXPERIMENTAL CHEMISTRY for Junior Students. By J. EMERSON REYNOLDS, M.D., F.R.S., Professor of Chemistry, University of Dublin. Fcap. 8vo, with numerous Illustrations.

PART I.—*Introductory*, 1s. 6d. PART III.—*Metals and Allied Bodies*, 3s. 6d.

PART II.—*Non-Metals*, 2s. 6d. PART IV.—*Chemistry of Carbon Compounds*, 4s.

**SMITH AND HALL.** THE TEACHING OF CHEMISTRY AND PHYSICS IN THE SECONDARY SCHOOL. By ALEXANDER SMITH, B.Sc., Ph.D., Associate Professor of Chemistry in the University of Chicago, and EDWIN H. HALL, Ph.D., Professor of Physics in Harvard University. With 21 Woodcuts, Bibliographies, and Index. Crown 8vo, 6s. net.

**THORPE.** A DICTIONARY OF APPLIED CHEMISTRY. By T. E. THORPE, C.B., D.Sc. Viet., Ph.D., F.R.S., Principal of Government Laboratory, London. Assisted by Eminent Contributors. 3 vols. 8vo. Vols. I. and II., £2 2s. each; Vol. III., £3 3s.

**TILDEN.** A SHORT HISTORY OF THE PROGRESS OF SCIENTIFIC CHEMISTRY IN OUR OWN TIMES. By WILLIAM A. TILDEN, D.Sc. Lond., D.Sc. Dub., F.R.S., Fellow of the University of London, Professor of Chemistry in the Royal College of Science, London. Crown 8vo, 5s. net.

**WATTS (H.).** DICTIONARY OF CHEMISTRY. Revised and entirely Re-written by H. FORSTER MORLEY, M.A., D.Sc., Fellow of, and lately Assistant-Professor of Chemistry in, University College, London; and M. M. PATTISON MUIR, M.A., F.R.S.E., Fellow and Prælector in Chemistry of Gonville and Caius College, Cambridge. Assisted by Eminent Contributors. 4 vols. 8vo, £5 net.

**WESTON.** A SCHEME FOR THE DETECTION OF THE MORE COMMON CLASSES OF CARBON COMPOUNDS. By FRANK E. WESTON, B.Sc., London (First Class Honours), F.C.S., Lecturer in Chemistry at the Polytechnic, Regent Street, W. 8vo, 2s.

**CHEMISTRY, ETC.—continued.**

**WHITELEY.**—WORKS by R. L. Whiteley, F.I.C., Principal of the Municipal Science School, West Bromwich.

**CHEMICAL CALCULATIONS.** With Explanatory Notes, Problems, and Answers, specially adapted for use in Colleges and Science Schools. With a Preface by Professor F. CLOWES, D.Sc. (Lond.), F.I.C. Crown 8vo, 2s.

**ORGANIC CHEMISTRY:** the Fatty Compounds. With 45 Illustrations. Crown 8vo, 3s. 6d.

**TEXT-BOOKS OF PHYSICAL CHEMISTRY.**

Edited by Sir WILLIAM RAMSAY, K.C.B., F.R.S.

**THE PHASE RULE AND ITS APPLICATIONS.** By ALEX. FINDLAY, M.A., Ph.D., D.Sc., Lecturer and Demonstrator in Chemistry, University of Birmingham. With 134 Figures in the Text, together with an "Introduction to the Study of Physical Chemistry" by Sir WILLIAM RAMSAY, K.C.B., F.R.S., Editor of the Series. Crown 8vo, 5s.

**A PRACTICAL INTRODUCTION TO CHEMISTRY.** Intended to give a Practical acquaintance with the Elementary Facts and Principles of Chemistry. With 25 Illustrations. Crown 8vo, 2s.

**ELECTRO-CHEMISTRY. PART I.—GENERAL THEORY.** By R. A. LEHFELDT, D.Sc., Professor of Physics at the East London Technical College. Including a Chapter on the Relation of Chemical Constitution to Conductivity, by T. S. MOORE, B.A., B.Sc., Lecturer in the University of Birmingham. Crown 8vo, 5s.

**ELECTRO-CHEMISTRY. PART II.—APPLICATIONS TO ELECTROLYSIS, PRIMARY AND SECONDARY BATTERIES, ETC.** [*In preparation.*]

**CHEMICAL STATICS AND DYNAMICS, INCLUDING THE THEORIES OF CHEMICAL CHANGE, CATALYSIS, AND EXPLOSIONS.** By J. W. MELLOR, D.Sc. (N.Z.), B.Sc. (Vict.). Crown 8vo, 7s. 6d.

**SPECTROSCOPY.** By E. C. C. BALY, F.I.C., Lecturer on Spectroscopy and Assistant Professor of Chemistry, University College, London. With 163 Illustrations. Crown 8vo, 10s. 6d.

*The following Volumes are also in preparation :—*

**RELATIONS BETWEEN CHEMICAL CONSTITUTION AND PHYSICAL PROPERTIES.** By SAMUEL SMILES, D.Sc.

**STOICHIOMETRY.** By SYDNEY YOUNG, D.Sc., F.R.S.

**THERMODYNAMICS.** By F. G. DONNAN, M.A., Ph.D.



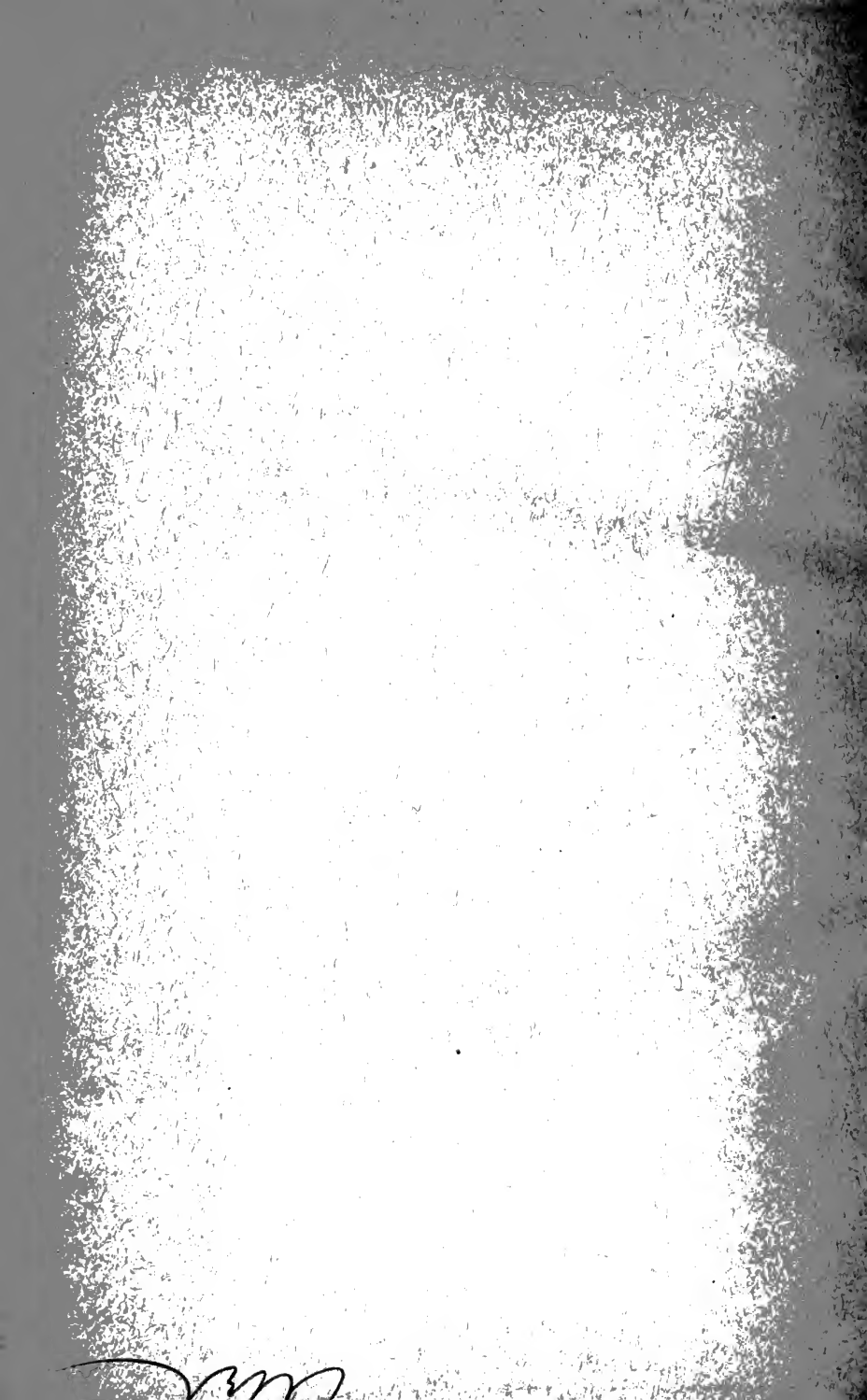



DATE DUE SLIP

UNIVERSITY OF CALIFORNIA MEDICAL SCHOOL LIBRARY

THIS BOOK IS DUE ON THE LAST DATE  
STAMPED BELOW

FEB 14 1925

JUL 27 1925

JUL 3 1926

MAY 13 1931

DEC 7 1938

11089

Library of the  
University of California Medical School and Hospitals

