

BOSTON UNIVERSITY
SARGENT COLLEGE OF PHYSICAL
EDUCATION 371.73
LIBRARY M 19

The Gift of *Mr. & Mrs. L. W. Sargent.*

EXERCISE

IN

EDUCATION AND MEDICINE

BY

R. TAIT McKENZIE, B. A., M. D.

Professor of Physical Education and Director of the Department, University of Pennsylvania; Fellow of the College of Physicians of Philadelphia and of the American Academy of Physical Education; President of the Society of Directors of Physical Education in Colleges; Sometime Lecturer in Anatomy and Medical Director of Physical Training at McGill University; Lecturer in Artistic Anatomy, Montreal Art Association, Harvard Summer School, and Olympic Lecture Course, St. Louis, 1904

WITH 346 ILLUSTRATIONS

PHILADELPHIA AND LONDON

W. B. SAUNDERS COMPANY

1909

Copyright, 1909, by W. B. Saunders Company

PRINTED IN AMERICA

PRESS OF
W. B. SAUNDERS COMPANY
PHILADELPHIA

“Man is the sum of his movements.”—F. H. ROBERTSON.

“That which those who winnow wheat do for it, gymnastic exercises accomplish in our bodies for us.”—SOLOX (*Dialogues of Lucian*).

“It is to be considered that some medicines may require exercise in order to enhance their virtues or remove some inconveniences attending their operation. Exercise, in such cases, is like the just and exact incubation to the egg; that which animates the drug and gives it power to produce the desired effect.”—FULLER.



PREFACE

THE following pages are addressed to students and practitioners of physical training; to teachers of the youth; to students of medicine and to its practitioners, with the purpose to give a comprehensive view of the space exercise should hold in a complete scheme of education and in the treatment of abnormal or diseased conditions.

The recognition of physical education by teachers has been retarded by dabblers and self-elected professors of one or other systems, whose extravagant claims have done much to obscure the real educational value of neuromuscular training; for the result of physiologic research in the growth and development of the nervous system is just beginning to be applied in the classification and design of exercise, to harmonize it with the conclusions of proved science.

Exercise has so many points of contact with education, it is so intricately related to mental, moral, and social training, each of which alone is so partial and incomplete, that the progressive educationalist is now compelled to study its bearing on all three.

It is of vital importance that the student of physical training should have a broad and catholic foundation on which to build the structure of his experience, and that he shall consider and balance the merits and limitations of systems and ideas coming from diverse lands. The normal schools and colleges of physical training are lengthening their courses and broadening their curriculum to meet this increasing need, and, with more thoroughly educated instructors, there will be less seen of a certain superciliousness with which the whole subject is regarded by some otherwise well-informed physicians.

The progress of medical science has been most notable in the great questions of national health and prosperity involved in the feeding, housing, and exercise of the people. School boards are appealing for medical inspection of the children to discover correctable defects and to prevent the spread of disease. The pernicious influence of indoor life on growth has been proved, and measures are now taken to remedy it by exercise and play; city slums are replaced by playgrounds, colleges and universities are placing on their curriculum instruction in physical education, both practical and theoretical, since the necessity for exact knowledge of the physical characteristics which differentiate the child from the youth, and both from the adult, has become patent to the thoughtful physician whose advice is so constantly asked.

Exercise and massage have been used as remedial agencies since the days of Æsculapius, but definite instruction in their use has seldom been given to medical students. Perhaps a certain laziness which is inherent in both patient and physician tempts to the administration of a pill or draught to purge the system of what should be used in normal muscular activity, but there is a wide dearth of knowledge among the profession of the scope and application of exercise in pathologic conditions, and the necessity of care in the choice and accuracy of the dosage will be emphasized throughout the second part of this book.

I have endeavored to acknowledge in the text the sources from which facts are culled, but I must especially acknowledge my indebtedness to the inspiring friendship of my colleague, Dudley A. Sargent, to E. M. Hartwell, from whose classic reports to the U. S. Bureau of Education, much of the historical data relating to gymnastic systems was obtained; also to Fred. E. Leonard, of Oberlin, whose historical researches on physical education have been mined with rich results. The studies of Luther Halsey Gulick, on the development of plays among children, and G. Stanley Hall's work on Adolescence have been most serviceable sources of inspiration, while the chapters on exercise for the blind, deaf, and mental defectives have been founded on the work of Edward Allen, Grace Green,

and Maurice Barr, in their respective specialties. In the section on medical treatment I have striven to credit other workers in the field with the contributions they have made, but much of it is my own experience, gathered from a special practice in the application of exercise.

I trust that this book may help to place before the profession this cinderella of the therapeutic family in her true character.

R. T. M.

PHILADELPHIA, PA.

July, 1900.

CONTENTS

PART I

EXERCISE IN EDUCATION

	PAGE
CHAPTER I	
THE DEFINITION AND CLASSIFICATION OF EXERCISES,	17
CHAPTER II	
THE PHYSIOLOGY OF EXERCISE,	20
CHAPTER III	
MASSAGE AND PASSIVE MOTIONS,	45
CHAPTER IV	
EXERCISE BY APPARATUS,	50
CHAPTER V	
THE GERMAN SYSTEM OF PHYSICAL TRAINING,	74
CHAPTER VI	
THE SWEDISH SYSTEM OF GYMNASIICS,	80
CHAPTER VII	
THE "SOFT BUSINESS OF JAPAN," THE "GOSPEL OF RELAXATION," AND THE "DOCTRINE OF CONTRACTION"	124
CHAPTER VIII	
AGE, SEX, AND OCCUPATION,	122
CHAPTER IX	
PLAYGROUNDS AND MUNICIPAL GYMNASIUMS,	137
CHAPTER X	
PHYSICAL EDUCATION IN SCHOOLS,	158
CHAPTER XI	
PHYSICAL EDUCATION IN THE COLLEGE AND UNIVERSITY,	174
CHAPTER XII	
THE PHYSICAL EDUCATION OF THE BLIND AND THE DEAF-MUTE,	194
CHAPTER XIII	
PHYSICAL EDUCATION OF MENTAL AND MORAL DEFECTIVES	210

PART II

EXERCISE IN MEDICINE

	PAGE
CHAPTER XIV	
THE APPLICATION OF EXERCISE TO PATHOLOGIC CONDITIONS,	222
CHAPTER XV	
FEET-FOOT AND ITS TREATMENT,	236
CHAPTER XVI	
THE CAUSE AND TREATMENT OF ROUND BACK, STOOPED AND UNEVEN SHOULDERS,	250
CHAPTER XVII	
SCOLIOSIS—ITS CAUSES, VARIETIES, DIAGNOSIS, AND PROGNOSIS,	271
CHAPTER XVIII	
THE TREATMENT OF SCOLIOSIS,	291
CHAPTER XIX	
EXERCISE AND ATHLETICS AS A FACTOR IN DISEASES OF THE CIRCULATION,	315
CHAPTER XX	
THE EXERCISE TREATMENT OF DISEASES OF THE CIRCULATION,	325
CHAPTER XXI	
OBESITY—ITS CAUSES AND TREATMENT,	346
CHAPTER XXII	
OTHER DISORDERS OF NUTRITION,	356
CHAPTER XXIII	
EXERCISE IN THE TREATMENT OF NERVOUS DISEASES,	370
CHAPTER XXIV	
THE TREATMENT OF LOCOMOTOR ATAXIA BY EXERCISE,	382
—————	
INDEX	395

EXERCISE IN EDUCATION AND MEDICINE

PART I

EXERCISE IN EDUCATION

CHAPTER I

THE DEFINITION AND CLASSIFICATION OF EXERCISES

THE term exercise, as here employed, comprises all movements, voluntary or passive, including manipulations by the hand of an operator or by a machine, designed to act on the muscles, the blood-vessels, the nervous system, the skin, and the abdominal organs.

This wideness of definition is necessary to cover its application and its efficacy as a medicinal agent.

It naturally falls into the two main divisions given by Plato—active and passive.

1. Active exercise requires a definite exertion of the will power, whether in its more complicated form of games and gymnastics, or in simple duplicate directed movements with assistance or resistance by the hands of an operator or by a machine.

2. Passive exercise does not require any exertion of will power. The various manipulations of massage, by means of the hands, or by the machines of Zander and others, by which contracted ligaments or muscles are stretched and nourished, local nutrition improved, nerves stimulated, and the abdominal organs affected, are restful rather than exhausting to an overwrought brain.

Active exercise may be subdivided into, first, those involving a single *effort* of one or more muscle groups, such as lifting a weight or performing a feat on the parallel bars; and, second,

exercises of *endurance*, consisting of motions rhythmically repeated without great muscular expenditure for each one, and depending for their effect upon continuous repetition.

Exercises of effort may be more or less violent in character or compound in motion, each one starting from and ending with rest. They are in endless variety, from simple movements of lifting and throwing, to the complicated combinations on the parallel bars and horizontal bar. In them the element of skill plays a leading rôle, and what would be a mild exercise for the expert may be a severe strain to the beginner, whose inaccuracy means the clumsy employment of many muscles that help little in its accomplishment, the contraction of some groups actually retarding success. Even in the accurate performance of an apparently simple movement, the distribution of muscular effort is wide, and increases tremendously with the difficulty of the feat. In pushing a heavy dumb-bell to arm's length above the shoulder, the extensors of the elbow-joint are the ones usually considered, but the entire muscular system shares in the effort. The grasping muscles of the hand are required, also the muscles that raise the shoulder and rotate the scapula. These are attached to the spine and ribs, which in turn must be supported by the pelvis, steadied on the hips, while the balance of the body is preserved by the muscles of the thigh and legs.

A single, simple effort, then, may give rise to fatigue of more than the muscles most obviously employed.

Education should be directed to teaching skill in the performance of such movements—skill that tends to economize the amount of effort required—for it is the common experience of shot-putters to find that their record performance is accomplished with the greatest ease, owing to the smooth, accurate application of group after group of muscles at the proper time; and the perfection of balance and speed of the body's movement.

However skilful the performer may be, the whole muscular system participates in any violent exercise of *effort*. During the intense concentration so necessary for success, the chest-walls are fixed; the glottis is closed, the lungs acting as an air cushion

for the surrounding cage of ribs and diaphragm; all the muscles of the trunk are steadied, and when the effort is made there is an explosive discharge of nervous energy, the intensity of which is mirrored in the muscular rigidity of the athlete's face.



Fig. 1. The typical face of violent effort seen in sprinting, hammer throwing, or spurt- ing in a distance race (modeled from life by the author).

The face of such a man will show a general converging of the lines to the root of the nose, with transverse wrinkles over the bridge. The frowning brows are drawn down and the eye is narrowed to a mere slit. The outer angle of the eye shows the "crow's feet" accompanying all violent action of the muscles that close it. The nose and upper lip have a snarling expression, the nostrils are distended, and the lower lip is drawn tightly across the clenched teeth, except at the angles of the mouth, where there are little pouches caused by the pulling of the platysma, which

stands out along the neck like cords. The general impression of the face is repulsive and corresponds closely to the face of *rage* as described by Darwin.¹ The lips, however, are more retracted than during the purely emotional state and the clenched teeth are exposed, presenting the appearance of one in readiness for tearing or seizing the enemy.



Fig. 2.—The expression of effort seen in throwing the hammer

In his drawing of *rage* Sir Charles Bell² shows a face corresponding closely in many respects to this one of strain.

The eyes are shut with force in all violent effort, such as shouting, sneezing, crying, or laughing, where the compression of the heart and lungs, by the muscular contraction of the chest-walls, drives up the blood-pressure to the point of seriously endangering the delicate vessels of the eye from overdilatation, the hammer-thrower or the sprinter would shut them if he could. Indeed, the hammer-thrower often does close his eyes at the moment of greatest effort. The great skin muscle of the neck, the platysma, springs

¹ "Expression of the Emotions in Man and Animals."

² "Expression of the Emotions."

into action wherever violent effort is performed, as in delivering a blow, and sometimes even in testing the grip by the dynamometer. It is the muscle of emphasis.

Games and feats of speed, in which many movements must be repeated as quickly as possible in a certain limited time, may well be classed as exercises of effort, since practically all the conditions of a single effort apply to them.

In a 100-yard dash, occupying about ten seconds, the concentration of attention is continued at its highest point throughout. The breath is held, and the whole muscular system is convulsed with supreme effort, while the blood-pressure rises, much as it does in the single effort of throwing the hammer or putting the shot. If, however, the rate be reduced and the runner be allowed twenty seconds or more to cover the 100 yards, the nervous tension disappears; the blood-pressure is but little affected; there is no nervous explosion, and the face remains calm and smiling.

The same exercise becomes, under these conditions, one of *mild* endurance; and the possibility of this transition in the same exercise from effort to endurance, or from endurance to effort, must be constantly borne in mind, much confusion having occurred by the careless use of these terms.

Feats of skill, such as juggling, are composed of isolated efforts which may be so mild in nature and so often repeated that they insensibly shade off into feats of endurance, especially when skill and practice render them automatic. The striking of a fortissimo chord on the piano is an exercise of effort. The practice of one scale for an hour would be an exercise of endurance, but the playing of the thirteenth rhapsody of Liszt, combines both effort and endurance.

The qualities cultivated by exercises of effort, whether of strength, skill, or speed, include mental concentration; the rapid response of the muscle to the will power; the ability to learn complicated coördinations and the knowledge of the easiest and most economic way of performing difficult movements. Their practice is followed by increase in the size of the muscles employed up to their physiologic limit. If carried past the limit of power, the

muscles will refuse to contract, or may actually tear, and if habitually overworked, they may atrophy, and become hard and fibrous, with weak, uncertain movements. When muscles are overdeveloped, they become parasites on the vitality, which is sapped in the struggle to provide for their nourishment. Exercises of effort do not cultivate constitutional vigor to the same extent as those of endurance.

In exercises of *endurance* the range and variety of movement are usually much more limited. They are confined to a few well-known varieties, such as walking, running, and rowing, and though each movement is well within one's power, the total amount of muscular work is great, but as the contraction and relaxation is comparatively slow, the poisonous waste matter producing fatigue is removed from the muscles as it accumulates. In exercises of *effort* there is no time for the scavengers to work, fatigue of the most active muscles setting in rapidly, while in exercises of endurance they can, at least, postpone its onset.

This class is, then, milder and more general in character. It deals with coördinations familiar from infancy. It is not necessary to concentrate the attention on every movement in walking, running, and rowing,—typical exercises of endurance,—in them the mind may be occupied with other thoughts. Breathing, which is a muscular action of endurance, is entirely automatic, but is not subject to the ordinary laws of fatigue.

The qualities cultivated by exercises of endurance are different from those required in effort. Skill is not prominent among them. Concentration is replaced by the attempt to liberate the attention, and the development of any one group of muscles is secondary to the indirect effect on the circulation and respiration in training them to remove the fatigue products of muscular contraction.

When carried to excess, exercises of endurance are accompanied by acute constitutional exhaustion, shown in breathlessness, from which recovery is rapid; by fatigue of the whole muscular system, from which a rest of a day or two is necessary, and by the chronic or nerve fatigue known as "staleness" among trainers, from which recovery may be a matter of weeks or even months.

Fatigue appears in one of these three ways.

If the exercise be sufficiently active, the amount of waste material suddenly thrown into the circulation is greater than can be eliminated by the lungs. The breathing becomes rapid and shallow, the pulse quick and fluttering, and the runner feels a sense of constriction around the chest; his head swims and throbs and his face takes on the anxious expression so eloquently telling of the thirst for air.

The face of the breathless man is unmistakable. The smoothness of the forehead is broken by wrinkles spreading out over the inner end of the updrawn eyebrows. The general direction of the eyebrows is just the reverse of that seen in violent effort. They are drawn upward and inward by what the French call "the muscle of pain," whose action is seen in the expression of grief, mental distress, anxiety, or bodily pain. The upper lids in breathlessness droop and half cover the eyeball, giving a look of great lassitude to the suffering expressed by this region. The nostrils are widely dilated, and the mouth gapes, with lips retracted in the mad struggle for air. The raised upper lip adds to the look of sorrow and pain, while the down-drawn mouth angle, the tongue closely pressed against the teeth, the sunken cheek, and the open



Fig. 3. —The typical face of breathlessness as seen in any race above 200 yards (modelled from life by the author).

mouth, all go to increase the exhausted, haggard look so characteristic of this state, in distinction to mere bodily pain or mental suffering. The general poise of the head is backward, the chin thrust forward, and the neck strained or convulsed.

With the reestablishment of equilibrium between the production of waste and its elimination, the urgency of breathlessness fades and the runner gets what is called his "second wind." The look of distress disappears from his face. The lungs regain fresh power to expand, the head becomes clear, and the muscles act with renewed vigor and elasticity.

He can now continue running until he feels the symptoms of general fatigue.

If the pace has been slow enough, the runner may escape the acute poisoning shown by breathlessness, but sooner or later the



Fig. 4.—The typical expression of breathlessness is seen in the last man.

products of tissue waste accumulate, the heart beats fast and weak, the nervous system is stupefied, and the muscles relax. This may, in extreme cases, end in death from overexhaustion, as has been reported in soldiers after long and forced marches.

The same condition may be studied in the face of the runner during a long distance race. After the urgency of breathlessness has passed, the expression of his face changes. The eyebrows show a slight frown, and the eyelids are heavy, as with sleep; the upper lip is still retracted from the teeth, giving a slight look of pain to the cheek, otherwise relaxed and flaccid. The mouth is half open, the jaw drops, and the lower lip hangs loosely over the parted teeth. The general expression is one of vacancy. As fatigue becomes more profound, his effort is centered in an endeavor to prevent the eyes from closing, as a consequence of the

increasing paralysis of the muscles of the upper eyelids. The long, doubly curved wrinkles across the forehead of this mask (Fig. 7), which shows advanced fatigue, or the last stage of exhaustion, are usually associated with the expression of surprise and astonishment, but here they illustrate the endeavor to raise the drooping eyelid. The nostrils are dilated, the lips are drawn downward and outward, the lower part of the face expressing the distress of failing respiration. The head is thrown backward and the chin thrust forward in the endeavor to balance the head without muscular effort. Both pose and facial expression are characteristic of the last effort to fight off collapse. When this last effort is exhausted, the muscles of expression cease to act, the circulation fails, the color becomes pale, the lips livid, and the runner falls in a faint.



Fig. 5.—The typical face of fatigue seen after acute breathlessness has passed off in a distance race (modeled from life by the author).

The effect of this general fatigue does not usually pass away for a day or two. The body temperature rises several degrees, the patient is tired, perhaps delirious, and his night is sleepless or disturbed by troubled dreams. The urine passed is of high specific gravity and contains albumin. The soreness and stiffness of the muscles and joints remain for several days, and gradually fade away as the constitution recovers its tone.

This may be said to represent the second form of general

fatigue—the subacute. The third or chronic form is found in men during a course of training in which the amount of endurance required daily is more than can be regained during the periods of rest. The exhaustion that finally comes on is slower, but more profound in its effects and more difficult to counteract, than either the acute form, corrected by a few minutes' rest, or the subacute form, which recovers in a couple of days. In this condition the temperature becomes subnormal, the weight goes down, the skin looks pale and flabby, the muscles lose their elasticity, the eye becomes dull and listless, interest in exercise ceases, every effort becomes a burden, and the patient sits without ambition or the power to rouse himself from his lethargy.



Fig. 6.—Both faces show the typical expression of fatigue.

Recovery from chronic fatigue, or *overtraining*, is a matter of weeks, and since the nervous system is profoundly affected, a change of air, surroundings, and occupation, with complete muscular rest, may be necessary.

It is a well-founded rule among trainers to give long distance runners a rest of two or three days before a race to recover completely from the fatigue of the last practice run.

Long distance running has been taken as the typical exercise of endurance, but just as we found that an exercise of effort might become one of endurance, so long distance running may vary sufficiently in its pace to make it an exercise in which effort plays a more important part than endurance. In a mile race the runner will carefully regulate his pace so that the waste matter of muscular

contraction can be eliminated almost as quickly as it is produced, and his resources husbanded for the moment when experience teaches him he can exert all his latent power in the final spurt. This is so timed that the finish line will find him completely breathless and exhausted.

A mile race is, then, an exercise of endurance throughout most of the distance, and at the finish an exercise of effort, the change showing by the expression of the face. It is in finding out the pace and the point at which effort must begin that the genius of the true athlete is seen or the skill of the trainer is shown.

Exercises of endurance, then, have much more profound influence on the general system than exercises of effort.

In the typical exercises of effort, such as feats of strength or skill, the resulting fatigue is principally a local one, and includes soreness of the muscles



Fig. 7.—The typical face of exhaustion seen just before collapse in a distance race (modeled from life by the author).

most strongly in action, which refuse to function when the effort becomes too great.

In exercises of endurance the constitutional fatigue is greater and powerfully affects the heart, lungs, general muscular and nervous systems.

Passive exercise finds its widest field of usefulness in conditions of fatigue, where the elimination of waste matter must be assisted,

and where nutrition of the part is impaired or destroyed. The patient remains inert and is acted upon by the operator or his mechanical substitute. Muscles can be improved in size, tone, and nutrition, ligaments stretched and strengthened, the general circulation quickened, and overloaded veins made to disgorge



Fig. 8.—The finish of a race, showing effort on the right, exhaustion in the center, and collapse on the left.

their blood. The digestive tract can be stimulated to more active habits, and overwrought nerves soothed and relieved of their hypersensibility.

The full and detailed description of the typical movements of massage will, however, require a chapter to itself.

CHAPTER II

THE PHYSIOLOGY OF EXERCISE

BODILY movements affect profoundly the motor apparatus, the vessels which supply it with nourishment in the form of blood and lymph, the storehouses of nutrition in the abdomen, and the controlling and directing mechanism of brain and nerve.

The impulse to contract a muscle begins at its motor center in the brain or spinal cord, and is carried to it by a motor nerve. Each muscle-cell shortens and thickens, scattering some of its substance into the lymph-space encircling it, and absorbing food consisting of carbohydrates and oxygen from this surrounding plasma.

By repeated contraction the cells increase in size and number, the perimysium is strengthened, the fibrous wall surrounding the bundle of cells is invigorated, and fresh power is imparted to the sheath inclosing the entire muscle. The result is an increase in bulk, in strength, and in elasticity. The tone of a healthy muscle keeps it in slight contraction even when at rest, so that antagonistic groups retain the inactive limb in normal position, but constant overaction and strengthening of one group of muscles increases this normal tension until the accustomed pose becomes habitual, as in the curved fingers or bent arms of the oarsman or weight lifter.

During contraction there may be actual rupture of the cell walls and exudation of blood and lymph. This is one of the two causes of muscle soreness found after severe straining exercise. The other cause is the presence of irritating waste matter imperfectly carried off by the blood-stream. This process of elimination is improved if the muscle be kept warm, but as muscular action generates heat, this usually regulates itself. When the limb is cold or inactive, the heat of the muscles must be enkindled by preliminary massage and light exercise before undertaking with safety any

severe athletic test. The lack of this precaution in cold weather is the cause of most ruptured muscles and tendon strains. Galen recognized this fact in the second century and writes: "If any one immediately after undressing proceed to the more violent movements before he has softened the whole body and thinned the excretions and opened the pores, he incurs the danger of breaking or spraining some of the solid parts, . . . but if beforehand you gradually warm and soften the solids and thin the fluids, and expand the pores, the person exercising will run no danger of breaking any part."

The overproduction of heat is fairly well equalized by evaporation through the skin and lungs, although general massage is followed by a slight rise in temperature, and there is always some fever attending and following a long distance race.

The effects of the three kinds of exercise described in the previous chapter on the structure and behavior of the muscle vary widely. Single and complete contraction, however mild the resistance, improves the nutrition if frequently repeated, as shown by an increase in size and efficiency. When, however, the tension is habitually excessive, minute ruptures occur in its substance and sheath, fibrous deposits are formed, and the muscle itself becomes shortened, hard, and inelastic. Even when at rest, the specialist on the horizontal bar will show the rounded shoulders, the bent arms, and curved fingers developed by too exclusive devotion to this exercise.

The number of muscles involved in a simple movement multiplies with the intensity of the effort. The trial of grasping power by the hand dynamometer is designed to test the flexors of the hand and forearm, but in the strife for additional force, muscular contraction spreads to the arm and shoulder and throughout the entire muscular system until its intensity is expressed by the face. If, however, skill is an important factor in the exercise, the emphasis on alacrity and accurate control cultivates in the muscle economy of effort and promptness in responding to the will. In other words, the latent period is shortened.

In exercises of endurance each movement is comparatively

mild, and there is less tendency to shortening and stiffening of the muscle so frequently found after extreme effort. Development is general rather than local, and long distance runners are not noted for the thickness of their calves.

General nutrition is best improved by the rhythmic self massage of movement. "Every muscle is a throbbing heart, squeezing its vessels empty while in motion and relaxing to allow them to fill up anew" (Weir Mitchell). The element of skill does not play an important part in such habitual or automatic movements as walking or running, so that their value in its promotion is comparatively slight.

Passive exercise improves the nourishment of the muscle-cell by forcing out the products of fatigue and keeping it bathed in a constantly renewed stream of arterial blood. This alone is sufficient to prevent wasting of substance in conditions where active movements are impossible, but it has little power to modify muscular strength or control.

It can be demonstrated that the amount of blood in the muscle, as in the heart, varies with its contraction and relaxation.

Mosso, of Turin, found that an arm inclosed in a water plethysmograph (Fig. 9) diminished in volume on contracting the flexors and immediately increased above its original volume when they were relaxed. He also found an increase in the amplitude of the pulsations of the whole arm during and after the contraction of the flexors. These experiments have been confirmed by Sir Lauder Brunton and other observers, and it may be considered as conclusively proved that the blood-vessels are substantially enlarged in the active muscle after contraction, and during the contraction itself the interchange of products between blood and muscle is also accelerated. Not only is this true, but the actual nourishing power of the blood is augmented by this heightened activity.

It has been proved by Hawk, in his interesting experiments on the blood-count of athletes in training¹ at the University of Pennsylvania, that various forms of active muscular exercise produce an average increase of 16.8 per cent. in the number of red corpus-

¹ "Am. Journal of Physiology," vol. x., No. viii.

cles, the greatest increase being 26.7 per cent. in a subject who had played water polo for a period of three minutes, the lowest increase being noticed after long runs and bicycling. When exercise is long continued, the rate of increase lessens and the number may even decrease in violent exercise sufficiently prolonged. This, he explains, is due to the passage into the circulating blood of a large number of cells lying inactive in various parts of the body until they are brought into service by the muscular exercise.

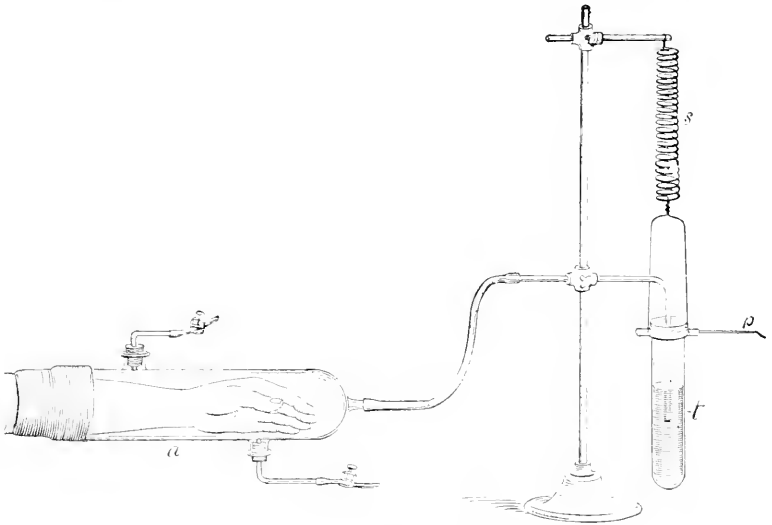

Fig. 6.—A schematic diagram of Mosso's pletysmograph for the arms: *a*, The glass cylinder for the arm, with rubber sleeve and two tubulatures for filling with warm water; *s*, the spiral spring swinging the test-tube, *t*. The spring is so calibrated that the level of the liquid in the test-tube above the arm remains unchanged as the tube is filled and emptied. The movements of the tube are recorded on a drum by the writing point, *p*. (Howell).

John K. Mitchell gives the same explanation¹ for a similar increase found after massage. This would also account for the fact that they decrease after prolonged exercise in which this reserve, as well as the original circulating proportion, is consumed in the furnace of muscular action. The specific gravity of the blood is heightened by evaporation from the lungs and this tends to mask the continual destruction of red cells in long tests of

¹ "Am. Journal of Medical Sciences," 1894, cvii.

endurance, and in every course of athletic training the blood is still further thickened by restricting the amount of fluid ingested to replace evaporation. In this way the oxygen carriers in the blood are relatively increased, as are the white cells that destroy tissue waste.

When exercise is sufficiently active, a larger blood supply is required and its purification must be thorough. The rate of the heart-beat and of the breathing is accelerated, the heart driving the blood into the arteries with a more powerful stroke. The poisonous refuse of tissue waste eliminated by the lungs consists principally of CO_2 , about 4 per cent, of which replaces an almost equal amount of oxygen absorbed at each breath. The respiratory center is also stimulated to increased activity by the circulation of lactic acid and acid phosphates in the blood as a result of muscular contraction.

An additional amount of CO_2 can be eliminated by using a larger surface of the lung tissue than is employed in ordinary life, without any great increase in the rate of breathing. Increased power of elimination can thus be acquired by practising movements of artificial or forced respiration which strengthen the accessory breathing muscles of the chest and stretch the thoracic cavity. It is, however, only with greater respiratory need that the absorption of oxygen takes place. To produce all the conditions necessary for an increase of respiratory power, active exercises causing actual tissue waste are thus required.

The onset of respiratory fatigue can be postponed by "*conditioning*" or decreasing the watery constituents of the blood through limiting the drink, as already referred to, and feeding with rich albuminous foods, both of which will increase the oxygen-carrying ability of the blood. To this is added muscular *training*, through exercises of endurance, to improve the quality of the tissues.

If the amount of muscular work be increased beyond the rate of elimination, acute general fatigue or breathlessness is inevitable, even in the man who has been put in the best *condition*. It is characterized by rapid, shallow breathing, a sort of respiratory madness, a fluttering pulse, and such symptoms as singing in the

ears, dizziness, and a feeling of suffocation, while accompanying the thirst for air is mental anxiety, confusion, and even unconsciousness. The facial expression of the breathless man has been already described.

This physical distress is preceded by a period of stimulation in which the eye becomes bright, the skin flushed, and a warm glow is felt from the dilatation of the capillaries. This dilatation of the capillaries is a sign of the increased power of the heart-beat,



Fig. 10.—Stanton's sphygmomanometer: 1, Leather cuff in place on the arm; 2, bulb grasped in hand for pumping air into the tube under the cuff to obliterate the pulse; 3, glass tube graduated to show the height of the column of mercury required (Da Costa).

which exalts the tension throughout the whole arterial system and drives the blood with quickened stream through vessels which at rest are almost empty.

Blood-pressure is also raised by any obstruction of its return to the right side of the heart. The causes of raising or lowering it will be considered more fully in an analysis of the influence of exercises of effort and endurance on the circulation.

The measurement, then, of arterial tension is exceedingly important. This is done by a sphygmomanometer, such as Stan-

ton's modification of the Riva-Rocci instrument. The brachial artery is compressed by strapping around the arm a leather collar four inches in width, beneath which is a rubber tube, the air being pumped into it until the radial pulse is obliterated. The amount of pressure required to do this is measured by the height of a column of mercury forced into a graduated upright glass tube (Fig. 10).

The normal systolic pressure, according to Janeway, who himself invented an instrument, is 145 millimeters. Anything under 100 he does not consider abnormal.

Sir Lauder Brunton's observations give 120 as normal for young adults, and from 115 to 140 for men in middle life. He considers anything above 150 as abnormal, although he notes having found men apparently in good health with a pressure of 180. He considers them, however, to be in a precarious condition.

A series of 500 observations taken with the Stanton machine, by Dr. A. E. Newton and myself on college students lying supine, shows an average of 135, which is lower than Janeway's and about the same as Sir Lauder Brunton's of normal young adults.

The observations of O. Z. Stephens,¹ in various positions, showed the following mean pressures: Standing, 131.6; sitting, 134; supine, 150.4; head down, 105.6; right lateral, 134.5; left lateral, 133.

In exercises of effort or speed, such as lifting a heavy weight, wrestling, throwing the hammer, or sprinting, the muscles of the chest-wall that assist in supporting the arm and shoulder come into energetic contraction, pressing on the elastic cushion of the lungs, so as to give the arm muscles a firm base of action. The teeth are clenched and the larynx is closed, corking up the air in the lungs, where it is still further compressed by the contraction of the abdominal muscles. Violent pressure on the thoracic contents is thus produced, and the ventricles of the heart empty more quickly and completely than is their habit. This is especially true of the left ventricle and the aorta. The coronary arteries, which give nour-

¹"Journal Am. Med. Assoc.," Oct. 1, 1914.

ishment to the heart, are compressed, and the circulation of the heart-muscle partially arrested, while the refilling of the thin-walled auricles is hindered. The blood in the arterial system is dammed back by the resistance in the engorged veins, and the superficial veins of the neck, temples, and forehead swell up like cords (see Fig. 1), and the complexion becomes first red and then dusky.

The blood-pressure mounted to over 200 mm. in a series of experiments by McCurdy¹ in a back and leg lift in which the effort was maximum, but the blood-pressure fell at once when the ob-

TABLE

The blood-pressure in eleven men before, during, and after lifting with maximum strength; the pulse rate¹ before and after the lift. Average of several observations made on each individual.

Name	Age	Weight in kilos.	Weight lifted in kilos.	Before lift.		During lift.	2-3 minutes after lift		No. of beats in digital artery between compression and disappearance of pulse.	Condition of arm.
				Pulse rate	Blood-pressure, mm. Hg.	Blood-pressure	Pulse rate.	Blood-pressure.		
Sk.	31	70	216	69	109	210	74	113	1-4	Moderate size, muscular
Ma.	23	64	115	53	100	165	94	107	1-4	Small, not muscular.
De.	30	60	121	75	93	146	76	95	1	Small, not muscular.
Na.	31	68	133	67	109	175	67	101	1-2	Large, muscular.
M.C.	33	75	170	78	124	173	81	125	1-2	Moderate size, muscular.
Ar.	24	75	178	77	117	207	80	117	1-3	Large, muscular.
St.	41	83	149	78	122	202	77	114	1-3	Large, muscular.
Hi.	25	60	155	84	100	154	80	107	1-2	Small, not muscular.
Be.	26	61	133	77	108	157	78	108	1	Moderate size, muscular
Me.	27	72	249	76	107	188	78	110	1-4	Large, muscular.
Ja.	26	75	152	73	127	197	74	130	1-2	Moderate size, muscular.

¹ The pulse rate was recorded in the recumbent as well as the standing position. It seemed necessary to give here only the figures for the standing position. The glottis was closed during each lift.

Fig. 11.—Summary of experiments made by J. H. McCurdy.

struction to the return flow was removed, equilibrium in the circulation being rapidly established, and little acceleration of the pulse-rate being noted (see Fig. 11), the disturbance above described varying directly with the severity and length of the effort. We find then the greatest strain on the heart and blood-vessels in exercises of strength and speed, more especially in all feats where the arms are used to lift or pull great weights, or to support the body, these movements involving as they do fixation of the chest-walls.

From the above it will be clear that exercises requiring sudden

¹ "Am. Journal of Physiology," Mar. 1, 1901.

and great muscular effort should be used with caution in those whose arteries have lost the first resiliency of youth, for in them damage may easily occur, although in youth no voluntary effort can be violent enough to burst a healthy vessel. Such exercises are a test of their quality rather than a means of systematically developing them, and no system of physical education composed exclusively of such exercises can lay just claim to completeness.

It is to exercises of endurance that we must look for the systematic development of strength and resistance in the heart and arteries. In mild, rhythmic movements the blood-pressure and

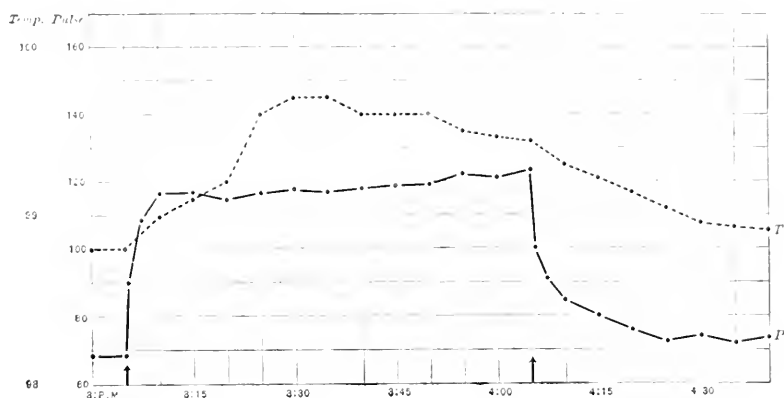

Fig. 12. Changes in pulse-rate and temperature of the body during a bicycle ride of one hour and during rest for the half-hour following. The solid line (*P*) indicates the pulse-rate, and the broken line (*T*), the temperature. Arrows indicate the beginning and end of the work (Wilbur P. Bowen).

temperature rise gradually and never attain a great height. They remain high after the exercise is finished, and then drop to sub-normal much more slowly than the pulse-rate. The pulse rate rises abruptly, remains high, and drops suddenly at the end of the exercise. During this period the circulation is carried on with increased force and rapidity, but without great overstrain (Fig. 12).

In Bowen's experiments on bicycle riding he found that speed had a much more potent influence than resistance in raising this rate.

Owing to the profound influence of exercise on constitutional vigor, it should be regulated with great care in relation to the age of the patient. According to Benke's statement, the volume of the heart in children is to the diameter of the arteries as 25 to 20, in adolescence it is 140 to 50, after full maturity, 290 to 61. During this period the volume of the heart is increased twelvefold, while the diameter of the arteries is increased only threefold.

If the length of the body be considered as 100, the heart volume would be from 40 to 50 in the child, while the heart of a mature person would be 190. The child's growth then would be in relation to and dependent upon this development of the heart, and upon the possibility of increased pressure of the blood in the arteries caused by their proportionate narrowing.

"Athletic training is mainly heart training."¹ Exercises of endurance distribute the activity widely, and gradually approach the maximum without interfering mechanically with the respiratory movements. They do not require supreme efforts, but they accelerate the activity of the heart and lungs, at least so long as the exercise lasts. The aggregate of work done is very much greater than in exercises of strength. Such exercises must, however, be active enough to provide for the free circulation of the lymph, which is carried on mainly by the massage of muscular contraction. If a walk be listless enough, there may not be sufficient movement of the muscles to thwart the pernicious influence of gravity acting on the column of blood contained in the veins of the belly, thighs, and legs, and the vessel walls may still become permanently stretched and varicose.

Massage mechanically excites the vessels to action, empties the lymph-spaces, and hastens the circulation. It usually raises the general body temperature² as well as the part manipulated, and through these means it removes fatigue products, increasing the muscle irritability lost from overwork or disease.

Many movements may be chosen because of the automatic massage given to the larger vessels by the action of the limbs as

¹ Roy and Adami, "British Medical and Surgical Journal," 1888, No. 1450.

² Weir Mitchell, "Fat and Blood,"

well as the muscles. Eversion and extension of the thigh stretches the deep fascia and presses on the crural vein underlying it. If the thigh be turned inward and flexed, the fascia relaxes, drawing the vein wall connected with it upward, and thus mechanically enlarging it. If the thigh be now completely flexed and inverted, pressure is again exerted on the vein. The rhythmic repetition of these motions of the thigh pumps the blood toward the heart, the valves of the veins allowing it to flow in that direction only. This process is continually at work in such movements as climbing, rowing, sliding, skating, and swimming.

The muscles are the slaves of the nerve-centers, and in fatigue the will tires long before the contracting power of the muscle is lost, for if the motor nerve to the fatigued muscle be cut, feeble contractions can be strengthened by artificial impulses of electricity.

Fundamental movements, such as breathing, eating, speaking, and walking, become, through constant repetition, automatic early in development, and the management of them is turned over to lower centers in the hind brain and cord, so that the motor area of the highly developed cortex may be devoted to those accessory coördinations that are never automatic and need long training to become habitual—such as piano-playing or juggling.

The acquirement of skill is, then, a training of the nerve rather than of muscle, if it is permissible to speak of them separately in this connection.

The simplest movement means not only a nerve impulse to the acting muscle, but a wave of impulses to the accessory and antagonistic groups which must control and steady the movement. If the movement is unfamiliar, this contraction will be jerky and inaccurate instead of unerring and graceful, or, in other words, physiologically economical. Many useless muscles will be employed, and the expense in nervous energy will be out of proportion to the result. The first attempt at comparatively simple actions rapidly exhausts the attention. The apparently aimless and uncertain movements of a child learning to walk illustrate the amount of concentration at first required in what afterward becomes automatic.

Exercises of skill cultivate habits of economy in the expenditure

of nerve force, and we instinctively admire a difficult exercise performed with thrifty ease just as we unconsciously censure the nervous prodigality of the unskilful tyro. The distracting influence of mental excitement or worry is seen in the broken shoe-lace of the hurried man and the failure of the nervous pianist before a critical audience.

When a certain degree of skill or coördination is learned, the interest passes on to what is more difficult, and this is one reason why any course in physical training should begin with simple and easily learned coördinations, progressing to those more difficult and complicated feats that serve to keep alive the attention and interest of the pupils.

Exercise should also be designed to develop and educate movements that are peculiar to the limb, the lower limb for support, locomotion, and leaping; the upper limb for grasping, striking, throwing, and catching. It is because this great principle is so much neglected that the interest is difficult to maintain in formal gymnastics. In free play this takes care of itself.

Exercises of strength and skill train that alertness of mind so necessary in ordinary life. They shorten the period between thought and action, and give that condition known as "presence of mind." This cannot be done without a corresponding mental strain. The man who is held alert too long on the starting line before a race, tense and straining for the signal, finds such a rapid exhaustion of his powers of concentration that in a second or two the strain becomes intolerable. The alertness required at first in learning to box, rapidly exhausts the nervous system, and it is only when the movements of countering, ducking, and side-stepping become habitual that the exercise can be continued for any length of time. Football is a game of the same nature, and "getting the jump" on an opponent is a matter of mental concentration and alertness rather than of actual strength. Much of the exhaustion of a game is due to this brain-fag, for the actual playing time in an hour's game is only four or five minutes at the most.

In gymnastic exercises imitation is a *cheap* form of instruction from the standpoint of nervous expenditure, because the pupil

learns more easily through the eye than by translating a verbal command into a picture of the movement, while exercises by command are much more exhausting to the attention of the pupil, but they have thus an additional educational value. This is the question upon which most of the wars between rival systems of gymnastics have been fought.

Exercises of endurance, which are simple, habitual, or even automatic, do not require great nervous concentration. A man can walk or run and have his mind on other things, but when they are carried to the point of acute fatigue, the phenomena of breathlessness, already described, takes place. If the exercise be continued after breathlessness has disappeared, the runner soon begins to notice a sensation of lassitude creeping over him, shown by an increasing lethargy and paralysis of the will power. His muscles become slower and slower in their response to his will; each effort requires a greater concentration of his attention. This lassitude gradually deepens; group after group of muscles refuse to perform their work, until he staggers along with relaxed grip, yielding ankle, fallen jaw, and drooping eyelids—drunk with the poisons of fatigue.

Repeated attacks of fatigue produce that chronic poisoning referred to in the last chapter as *staleness* or *overtraining*, which is, above all, a slow poisoning of the nervous system, just as sub-acute fatigue was a general intoxication by the products of muscle waste, and acute fatigue—an intoxication of the breathing apparatus.

The rôle of passive exercise is one of relief to the nervous system, for the nutrition of muscles may be maintained without the expense of nervous force required to make them contract, and massage acts on the central system through the nerves of sense, stimulating or soothing, according to the nature and amount of the manipulation.

The absorption of carbohydrates and proteins by muscular action causes a hunger for food, just as the using of oxygen produces a hunger for air. With the supply of food the muscles increase in size and strength, and the amount remaining unused is

excreted or stored up in the tissues as fat. If training be severe, this natural horde of fat is speedily expended, and a man in fine athletic condition is always below his normal in fatty tissue. Athletic training aims to produce a *machine* to run, leap, fight, or row, and fat would only be an encumbrance, so that a man in fine athletic form would not be in the best condition to resist the siege of an exhausting infection, like typhoid fever or pneumonia, where the stored-up fat of the normal individual becomes his most valuable asset. The loss of weight during athletic exercise may be from five to eight pounds in less than half an hour, a loss which is continued after exercise is stopped if no food or drink is taken. In a series of observations made on foot-ball players during practice at the University of Pennsylvania I found that the loss averaged about three pounds, the highest being 5.1 pounds and the lowest .8 pounds, the weights being taken immediately before and after exercise. The men were then wrapped in blankets or allowed to sit around for an hour, and showed a further loss of one-half pound, the greatest loss being .9 pounds and the smallest nothing. In no case was any gain found.¹

It has already been shown that the first two organs to act in the elimination of the poisons of muscular waste are the lungs and the skin, the former giving off heat, CO₂, and water vapor, and the latter, water, urea, and other constituents of minor importance, in addition to neutralizing the heat produced by muscular action through evaporation. This loss of weight from the skin and lungs goes on even during sleep, as shown by the delicate balance used by Warren P. Lombard in his experiments² (Fig. 13).

From 107 observations on healthy men averaging 64.5 kilos in weight he concludes that the loss of weight is 0.602 gm. a minute, of which .525 is from the air passages and .166 or about 24 per cent. is from the skin. The elimination by the skin alone was obtained by holding the breath in expiration.

¹For the carrying out of these experiments I am indebted to my assistant, W. J. Cromie.

²Reported at the Siebenter Internationaler Physiologen-Congress, Heidelberg, 1907.

The effect of CO_2 has been graphically shown by Lee in his work on the action of fatigue products on muscular contraction.

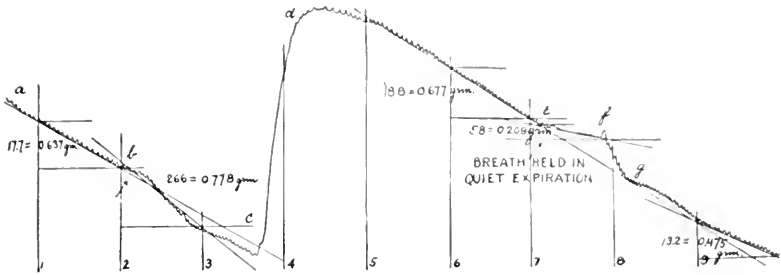

Fig. 13.—Curve of loss of weight of F. M. A. (aged 20, weight 72 kilos), 5.30 P. M., May 24, 1900. Room temperature, 24.5° C.; hygrometer, 55 degrees. The small oscillations were caused by the respirations. Time is marked in minutes at the bottom of the curve: *a-b*, subject asleep; *b-c*, waking curve; at *c*, 4 grams added; *d-e*, waking curve; at *e*, breath held in quiet expiration; at *f*, a large inspiration when subject begins to breathe; *f-g*, curve shows rapid loss of weight following the holding of the breath. At *b*, he was partly asleep, eyes closed, lids twitching. He was told to open his eyes and did so. He was not startled and was not seen to make any other movement (Warren P. Lombard).

In Fig. 14 the preliminary stimulation of the poison, already referred to, is seen in the higher curve of contraction found in the poisoned muscle at the lower part of the diagram. This

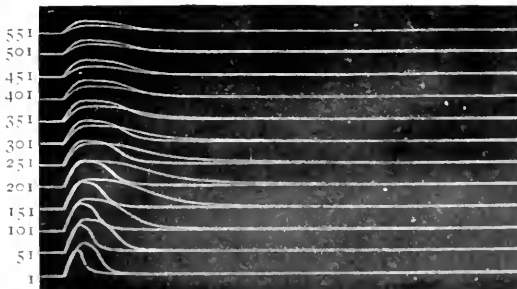

Fig. 14.—Record of fatigue of companion gastrocnemius muscles of the frog, one normal, the other under the influence of carbon dioxide. The longer, or, in the lower contractions, the lower curves, are those of the poisoned muscle. Every fifth contraction is recorded (Frederic S. Lee).

stimulation soon gives place to the slow and lowered line of the upper part of the diagram.

It still remains to speak of the function of the kidneys. Before and after the Marathon race, of twenty-four miles, at St. Louis, 1904, the temperature of twelve contestants was taken (per rectum),¹ showing a rise of from 2 to $3\frac{2}{3}$ degrees. This rise, also noted by Bowen (Fig. 12), is, I believe, constant, although it may not show if the mouth temperature be taken. The fever is accompanied by nephritis lasting several days, seen in the presence of albuminous urine containing casts. The other products of muscular action removed by the kidneys are water, uric acid, urea, oxalates, lithates, and numerous other substances. These show as reddish deposits (principally uric acid) in the urine, especially of those not habituated to fatigue, but quickly disappear with improved *condition*.

In the understanding of the place occupied by *conditioning* and elimination we have not advanced much, even in phraseology, on Hippocrates, who wrote that "The untrained have moist flesh, and when they exert themselves, the body becomes heated and they yield the product of liquefaction in abundance. Of this, whatever is sweated or purged away with the breath, causes no trouble except to so much of the body as has undergone the unusual depletion; but whatever remains causes trouble, not only to the unduly depleted part of the body, but also to whatever part receives the liquid in question, which is not akin to the body, but hostile."

¹Notes taken by Dr. Luther Halsey Gulick, Joseph E. Raycroft, R. Tait McKenzie.

CHAPTER III

MASSAGE AND PASSIVE MOTIONS

THE word massage (Greek, *massain*, to knead) is applied to the systematic manipulation of the body surface by the hands in movements of stroking, pinching, kneading, and striking. Passive motion consists in the flexion, extension, and other movements of joints and limbs by an operator or machine, without the cooperation or resistance of the patient. Both have been widely used since the beginning of history. Travelers have brought accounts of their employment in Turkey, Africa, Siberia, Lapland, Japan, China, and the islands of the Pacific. The *lomi lomi* of the Sandwich Islanders is spoken of with enthusiasm for its power of relieving the stiffness and soreness of fatigue, and procuring rest and sleep. The process is described as varied among kneading, squeezing, and rubbing, now one and now the other, each region being manipulated in turn, beginning with the head and working down slowly over the whole body, until in half an hour the weariness has quite disappeared, giving place to a most refreshing sense of ease and comfort.

The history of massage has been checkered. The priests of Egypt used friction and kneading for rheumatic pains and neuralgia, and the priestly caste of India have always known and practised it. The Greeks had a class of "podotribes," or physicians, who acquired great skill in the manipulation of the body, just as at the present time the call of the blind masseur is a familiar sound in the streets of Tokyo. The Romans followed the Greeks, from whom so many of their customs were borrowed, but with them it often became a means of escaping the more rigorous forms of exercise and of removing the effects of overeating and drinking, the forenoon of the luxurious patrician being devoted to the bath and general massage. It has had its eras of popularity and its

seasons of neglect, popularity usually due to the personality and skill of an operator, or school of operators, and neglect following its indiscriminate use by unskilled persons. In the middle of the last century Beveridges' rubbers were well known in Edinburgh, and their success carried it from that medical center throughout Europe. It then declined, but has been revived on a more solid and scientific basis by Fox, Norström, Graham, and especially by Mezger, of Amsterdam, whose classification is the one habitually followed to the present day. It is universally employed by athletic trainers to aid the elasticity and power of an athlete's muscles before a contest and to remove the fatigue following exertion.

In medicine a great impetus was given to its employment by Ling and his disciples in Sweden, and it now forms part of the Swedish system of remedial gymnastics.

Its recognition as a therapeutic agent has been delayed by the failure to distinguish between *true* massage and unskilled rubbing, which merely requires muscular strength, a certain manual dexterity, and good will. To be a successful masseur one must possess these qualities before beginning the training necessary to learn its possibilities, but its practice should be preceded by an intimate and special knowledge of anatomy, the disposition and thickness of muscle groups, their septa, the point where muscle changes to tendon, the situation and course of the veins and arteries, and their anastomoses, the location of the nerve-supply, the movements of a limb, and the changes about the joint caused by movement, the situation and extent of synovial cavities and tendon-sheaths. This knowledge should be practical and continually confirmed or corrected when the parts are at rest and at work. In addition to this there must be that touch, firm, insistent, yet gentle, that adapts itself to the hills and hollows of the body surface as if by instinct, and a buoyant constitutional vigor to withstand the exhausting character of its practice. It is for the reasons above enumerated that the practice of true massage is limited to the few that are willing and able to devote the time and study necessary for the thorough acquirement of its technic.

The action of massage upon muscles in repose has been thoroughly studied by Mosso and Maggiora, of Turin, who chose for their experiments the fatigue curves of the right and left middle fingers in maximum voluntary flexion every two seconds with a weight of three kilos.¹ These records were taken at eight and eleven in the morning and at two and five in the afternoon, without massage, and the following day under the same conditions after a friction and kneading of three minutes. The average of the results proved that the muscles did twice as much work after the

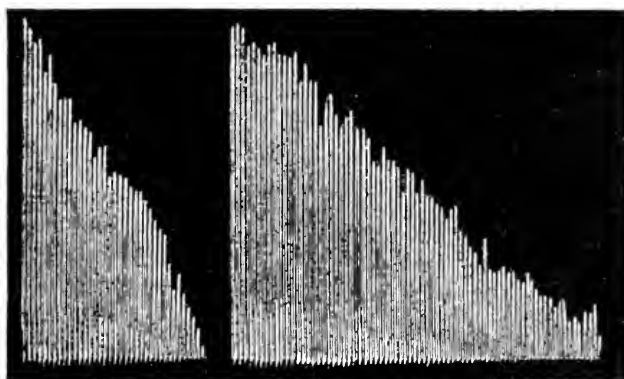

Fig. 15.

Fig. 16.

Fig. 15.—Normal voluntary curve of fatigue of the flexor muscles of the middle finger of the left hand, with a weight of 3 kilos and rhythm of two seconds.

Fig. 16.—Curve of the same muscles with the same weight and rhythm, after massage for three minutes (after Maggiora).

massage (Figs. 16 and 18). Maggiora also discovered that extension of the period of massage did not produce any greater results in the capacity for work, five minutes obtaining all the needful effect. His experiments on the comparative value of the various manipulations proved that little difference existed in the effect of friction and percussion. There was a greater increase of working capacity after the use of pétrissage than from either of the other movements, but the best results were obtained by alternating all three. The effect of massage upon the muscles

¹ Graham, "Recent Developments in Massage."

weakened by fasting was such as to restore them temporarily to their normal condition. It also restored a normal fatigue curve that was reduced and shortened by a wakeful night (Figs. 19 and 20). After an intense, prolonged intellectual strain of five hours in the final examination of medical students, Maggiora's fatigue curve was one-fifth of the normal. An hour later, after ten minutes of massage, the fatigue curve was almost completely restored. Perhaps the most interesting results

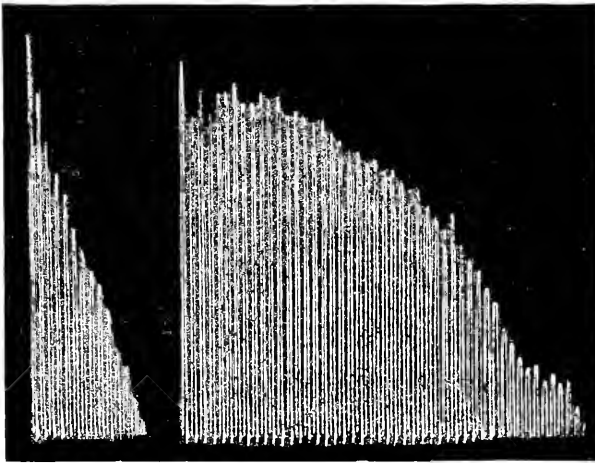

Fig. 17.

Fig. 18.

Fig. 17.—Fatigue curve of flexors of right middle finger after a walk of ten miles.

Fig. 18.—Shows the influence of massage for ten minutes upon the same muscles already indirectly weakened by walking. Weight, 3 kilos; rhythm, two seconds (Maggiora).

obtained were in his studies of artificial anemia of the muscles. After compressing the brachial artery, the finger could contract only 11 times in comparison to 265 times under normal conditions. While the arterial current was still shut off, three minutes of vigorous massage was given, after which the finger could contract only nine times, proving that massage had no effect when the blood-supply was intercepted. From these experiments it is evident that massage essentially affects the local circulation by bringing a greater quantity of nutrition to the muscles, and re-

moving the poisonous products loosened by their action. Its action in improving muscle tone, in postponing the onset of fatigue, and hastening recovery from it, has long been recognized by athletic trainers. In preparing athletes for a contest, general massage is always given by friction, kneading, pinching, and stroking, lubricating the surface with some oily liniment. After a hard race or other contest, it is a matter of common knowledge among trainers that a five-minute treatment will

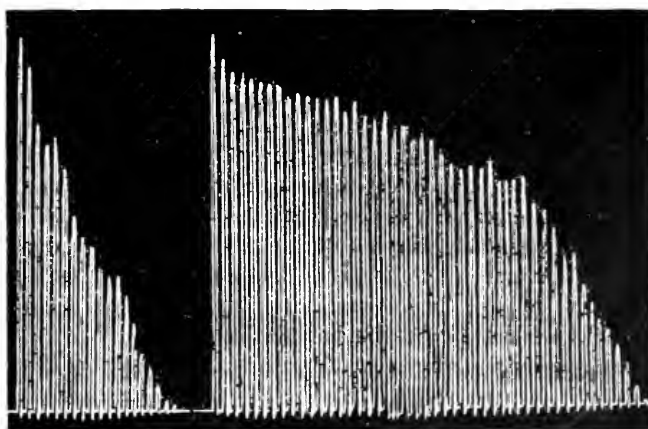

Fig. 19.

Fig. 20.

Fig. 19.—Fatigue curve of flexor muscles of middle finger of right hand after being awake one night.

Fig. 20.—Shows the effect of ten minutes' massage upon the same muscles (Maggiore).

enable an athlete to repeat or continue a performance otherwise impossible.

Massage differs radically from active exercise in its capacity to feed muscular tissue without fatiguing or even employing the will power of the patient. It is the most economic form of exercise on the nervous system, and yet its potency is shown by the increase of red blood-corpuscles and hemoglobin, and by the exalted rate and force of the heart-beat without a corresponding change in the arterial tension. It accomplishes these results by decreasing resistance in the peripheral vessels, by the removal of the poisons of oxidation, and by mechanically moving the blood-

current forward in the lymph-spaces and venous channels. It thus stimulates the circulation, respiration, nutrition, and excretion.

Mezger gives the best classification of procedures, describing four principal manipulations:

1. **Stroking (effleurage)**, in which the hand is passed lightly over the skin, with pressure from the periphery to the center, following the course of the venous circulation and the long direction of the muscles from their insertion to their origin. It may be per-

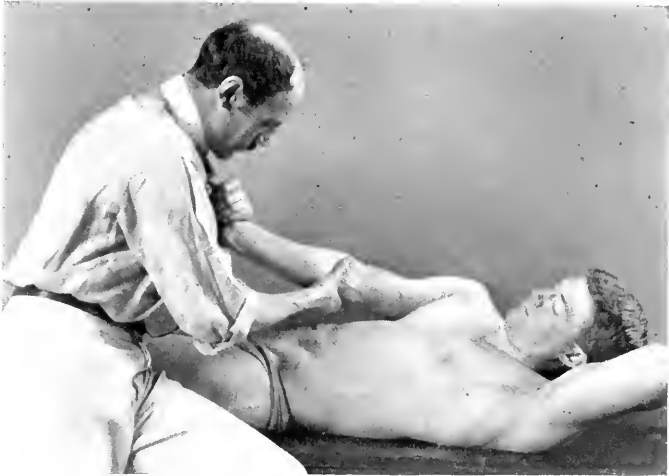

Fig. 21.—Effleurage of the forearm. Note the distention of the veins above the hand that is passing upward.

formed by stroking with the palm of one or both hands, with the thumb or tips of the fingers. The two hands are used upon the large fleshy parts of the thighs and buttocks, or upon the chest, back, and neck. The thumb is used on small muscles hemmed in by bones, such as the interossei of the hand or foot, or the anterior muscles of the leg. The tips of the fingers are used around the joints of the knee, ankle, elbow, or wrist, the fingers adapting themselves to the shape of the part worked upon. The strength of the manipulations varies from the slightest touch upon a region sensitive to pressure, to the firm pressure with one hand

upon the other, over such large masses as the erector spinae. Inflammatory products are loosened, passed into the circulation, and rapidly absorbed, while the engorged veins and lymph-channels are unloaded (Fig. 21). This form is the first employed in sprains and freshly inflamed synovial membranes, and in all chronic cases where the tissues are matted and sodden, requiring the absorption of an exudate.

2. **Friction**, a firm, deep circular movement performed by the thumb, tips of the fingers, or by one hand open or clenched. The thumb is employed on the small surfaces of the face or extremi-



Fig. 22 Friction of the erector spinae.

ties. Friction by the tips of the fingers is used around joints, the fleshy part of the thigh, the arm, and the lumbar region requiring the entire hand. The friction should proceed in the same general direction as the stroking movements, which should always follow it. The products of fatigue congregating in the deep muscular tissue are thus thrown into the circulation, the gentle manipulations of stroking readily carrying them into the superficial veins. This affects all deeply seated structures embedded in muscular masses, and should be used along the sciatic nerve in the treatment of sciatica and over the abdomen to unload the colon.

3. **Pétrissage, pinching, or grasping** is performed by picking up the skin and subcutaneous tissue between the thumb and fingers, and manipulating it with an amount of force not sufficient to cause pain. In this movement the skin moves with the hand of the operator, and the underlying structures are thus massaged by it under the pressure of the fingers. It is most advantageously done by the thumb opposed to the first finger, by the fingers opposed to the palm of the hand, or by the two hands opposed to one another. The thumb and fingers are used to reach individual muscles and small groups, such as the muscles of the hand, foot, forearm, and upper arm. The larger muscle masses

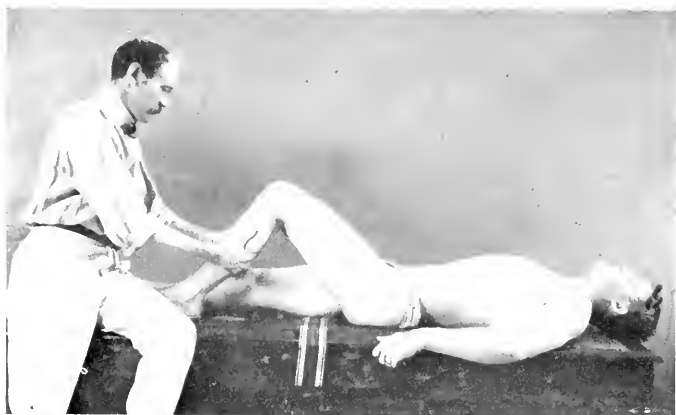

Fig. 23. —Pétrissage of the calf muscles.

of the thigh and calf require the use of the fingers opposed to the thumb and hand (Fig. 23), or both hands, the muscle being rolled beneath them and pressed against the bone. This has the same effect as friction on the deep structures, and is better for sensitive, easily irritated surfaces, the skin moving with the hand like a glove. The movement should always be gradual, proceeding from the periphery inward. It is the favorite means used to improve muscular nutrition in conditions of fatigue, in atrophy, in obesity, or other forms of muscular degeneration.

4. **Striking (Tapotement or Percussion)**.—This manipulation comes under many names, such as clapping, beating, knocking, or

hacking. It is done for small surfaces by patting with the open hand, or by slapping with the palm cupped to leave a layer of compressed air between the hand and the surface to be manipulated, a movement that is familiar to every frequenter of the Turkish bath. Its action on the skin, superficial nerves, and vessels is stimulating. Hacking is performed with the ulnar border of the hand, and is used along such nerve trunks as the sciatic or the spinal nerves (Fig. 24). Where the bone lies close to the skin, at the ankle- or knee-joints or in manipulations of the scalp, this



Fig. 24. Tapotement of the back with the ulnar surface of the hand.

movement should be performed by the tips of the fingers, but over the fleshy regions of the thigh and buttocks the clenched hand may be used. Each blow stimulates the nerve powerfully and causes involuntary contraction of the muscle. When the blow is heavy and rapidly repeated, it may even produce local anaesthesia. The blows should be quick and sharp, but not strong enough to bruise the muscle and produce after-soreness. It is commonly used in cases of paralysis, neuralgia, and neuritis.

A fifth manipulation might be added—that of **shaking** or **vibration**. Shaking involves movement of the whole body or region to be treated, while vibration is a lesser motion in which the body or region remains at rest, while the surface and structures

immediately beneath it are affected. The term "tremble pressing" accurately describes it. These manipulations are so difficult to perform skilfully and so exhausting to the operator that machines were designed by Zander to replace the inaccurate and rapidly tiring human hand. They will be fully described in the chapter on Apparatus.

General massage is best given at an hour midway between meals, and never immediately after eating. The order in which the manipulations are given is as follows: The parts are first lubricated with cocoa-butter or vaselin, to avoid the irritation which may follow the friction of a hairy surface. The operator starts with the feet, and gently but firmly pinches up the skin and subcutaneous tissue, rolling it between the fingers and thumb until both surfaces of each foot have been covered. With the thumbs and fingers, the small muscles of the foot are kneaded, special attention being devoted to the interosseous groups, which require slow deep pressure from the thumbs. Care should be taken to avoid bruising of muscle and skin against the underlying bones. The foot is then grasped and all the natural movements of the toes and ankle are rehearsed. Next the region of the ankle is dealt with in the same fashion, and stroking movements are made from the toes to the leg, to empty the superficial veins of the foot. The leg is next treated by circular friction with the fingers, by deeper grasping of the areolar tissue, and last by industrious and deep pinching of the larger muscular masses, which for this purpose are put in a position of complete relaxation (Fig. 23). For the large muscles of the calf and thigh both hands act, the one contracting while the other lessens its grip. The firm muscles in the front of the leg are rolled under the cushions of the fingertips. At brief intervals upward stroking is given from ankle to knee, to favor the flow of venous blood-currents. The same process is carried on for the hands and the arms. Especial care is now given to the muscles of the loins, back, and neck, which are subjected to frictions, kneading, and striking with the ulnar border of the open hand (Fig. 24), followed by upward stroking of the loins and back, the same manipulation being directed downward and

outward from the head to the shoulders. The abdomen is then treated by pinching the skin and underlying tissue, deeply grasping the entire muscular walls with both hands, pinching and rolling them. Massage of this region concludes with deep kneading by the heel of the hand in a succession of rapid, deep movements passing clockwise in the direction of the colon. The chest is then manipulated upward from the sternum along the line of the pectoral muscles by pinching and kneading of the muscle masses of each side. The face is not usually treated in general massage, but the sides of the neck are gently stroked from above downward along the course of the internal jugular veins. Each part operated upon should be carefully covered after treatment.

Weir Mitchell, in his treatment of neurasthenia by rest, overfeeding, and general massage, found a constant rise of temperature after each treatment, and noted a rapid improvement in the tone and reaction of the whole muscular system.

The usual fault in giving massage is that too much is given at one time—Maggiora's experiments prove that the maximum effect on a part is obtained in five minutes. Another mistake is in employing too heavy a hand; a patient should never feel bruised or exhausted, although a pleasant lassitude is one of the most valuable effects.

Massage should be avoided in certain skin affections, as eczema, acne, and other skin eruptions, in wounds, burns, and erysipelas, in tumors and purulent inflammations, and in acute disease of the bone tissue. It should not be used in the acute stages of severe constitutional or local diseases, where complete rest is necessary; and it should be allowed only with great precaution in pregnancy and in the presence of renal disease. Its place in the treatment of sprains, fractures, and other surgical conditions, and its value in medicine will be considered more fully in the appropriate places.

CHAPTER IV

EXERCISE BY APPARATUS

THE application of exercise and massage by mechanical means has been considered from two points of view—firstly, from the

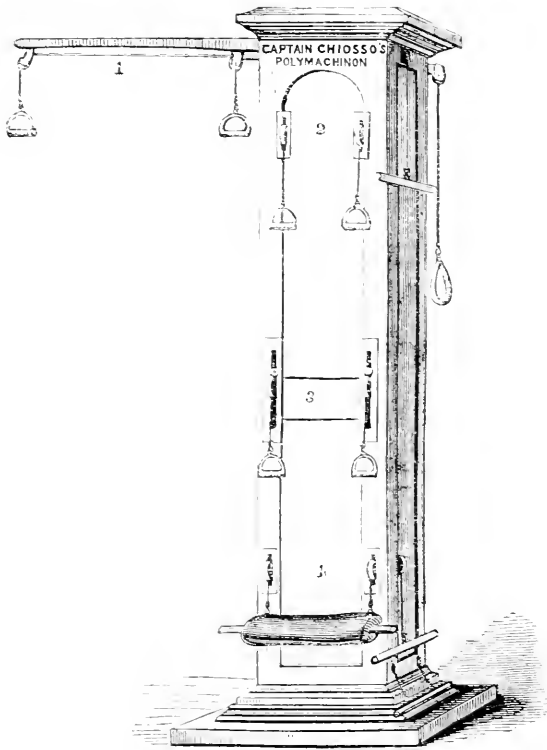

Fig. 25.—The polymachinon of Captain Chiosso. An early attempt at a universal exerciser, employing the pully-weight principle.

standpoint of the physical educator, who would obtain rapid development of the entire muscular system by specially designed ap-

paratus, and, secondly, by the physician who wishes to prescribe and control the dosage of exercise in the treatment of disease.

Both have recognized the law of the "physiological load," which affirms that a certain resistance is required before a muscle can make its maximum contraction. This load is increased if the movements are to be few in number and slow in rhythm, and decreased for frequent rapidly repeated motions; but some exterior resistance is necessary; weight must be lifted or moved if the best qualities of the muscle are to be developed.

Many so-called *free* exercises, such as deep knee-bending, use the body weight for resistance.

Dumb-bells have been used since the time of the Greeks for the purpose of shortening the period required to develop a muscular group. Their application is crude and limited, however, in comparison to the accuracy and versatility of machines employing the principle of the lever or the pulley weight. The direction of a dumb-bell's pull is always downward, whereas, with the shoulder attachment of the pulley-weight, the drag is lateral, and the high attachment of the pulley reverses the direction of the force of gravity. By changing the position of the pulley it is thus possible to isolate the action of all the important muscle groups.

We have records of Captain Chiosso, as early as 1820, at work in London, on a machine which he finally perfected and called the *polymachinon*, a portable, closet-like instrument of ropes, weights, and pulleys. Among the advantages claimed for it were its convenient size, "the space required for it being of so little import that it may, with ease, be employed in an ordinary room," and its beauty of line, "the elegant and ornamental structure of the

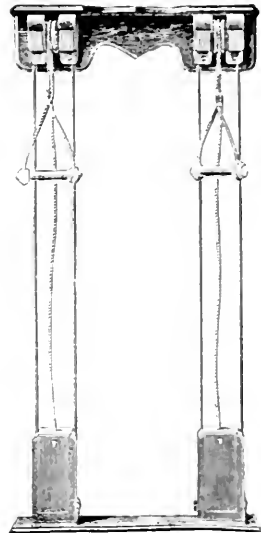

Fig. 2.—Dr. Sargent's latest design for the pulley-weight, with adjustable weights and wooden boxes.

whole fits it for a prominent position in the dining-room, library, or boudoir."

In spite of these advantages it did not make a permanent impression as an exerciser, an article of furniture, or as a means of treating the dozen maladies for which it was claimed to be most beneficial.



Fig. 27.—The perfected pulley-weight machine (Narragansett Co.), with weights attached by moving a foot lever. Single.

Other machines, designed on this principle, have been constructed and used for the last fifty years, but the improvement of their design, their systematic application to gymnastic training, and their wide employment in physical education are undoubtedly due to the efforts of Dr. Dudley A. Sargent, of Harvard, who has perfected the numerous developing appliances that are known by his name, and every gymnasium is now supplied with a more or less complete set.

In its simplest form, the pulley-weight shows one pulley attached to the wall at the shoulder level, over which runs a rope with a handle at one end. The other end of the rope is fastened to a weight carrier, steadied by guiding rods, which may be loaded with iron plates (Fig. 27). This rope may be compounded by means of another pulley attached to the weight carrier, so that its excursion is half that of the arm (Fig. 28, A).

In this way the height to which the weight is lifted is halved, allowing twice the range of movement with the same length of guiding rod.

A further elaboration of the pulley-weight uses a floor attachment, the rope turning about the pulley at the level of the floor, making a downward resistance (Fig. 28, B).

A third variation, called the intercostal attachment, uses

the overhead pulley, which draws the arms upward (Fig. 28, C). In the triplicate machines all three varieties are used at will (Fig. 28).

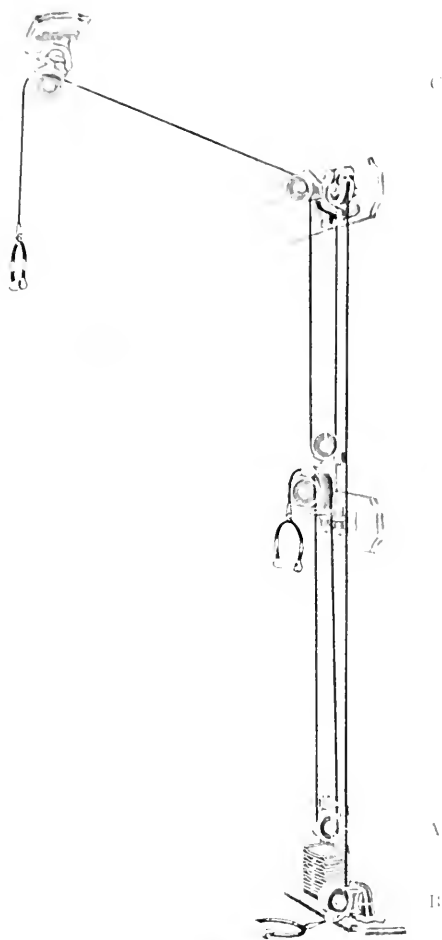

FIG. 28.—Triplex pulley, weight (Narragansett Co.)

Attachments are designed for the head, by which the muscles of the neck may be developed; also for the foot, to exercise the muscles of the leg and thigh.

The quarter-circle is a modification of the regular pulley weight

machine for keeping the trunk overextended during the arm movements.

Pulley-weight machines have been designed by Dr. Sargent for strengthening the flexors of the fingers (Fig. 30), and for the pronation and supination of the forearm.

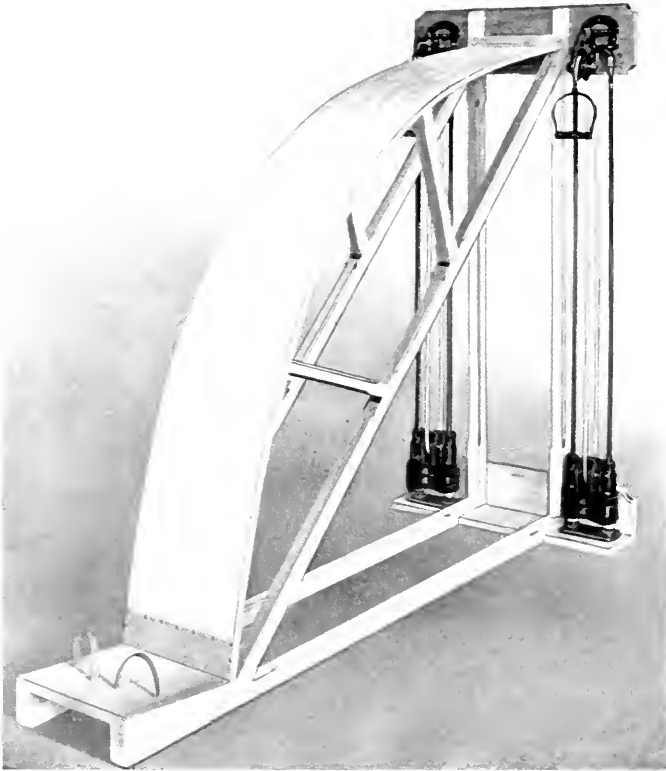

Fig. 29. Quarter-circle (Spalding).

Others are used for practising the movements of pushing downward on the parallel bars (Fig. 31) and chinning the horizontal bar. In these machines, the bars are set on sliding rods and balanced by counter-weights, while the resistance may be increased with the strength of the user. They are designed for the man who is

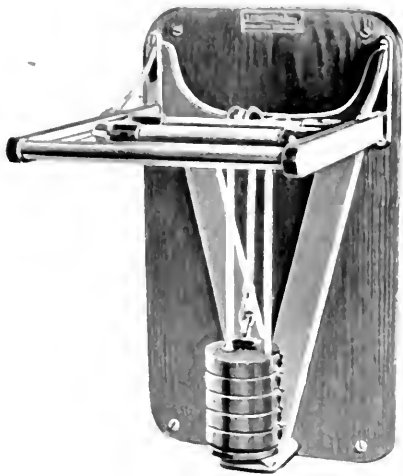

Fig. 30.—Finger machine to develop flexors of the fingers and grasping. [Pat. U. S. 1,011,222.]

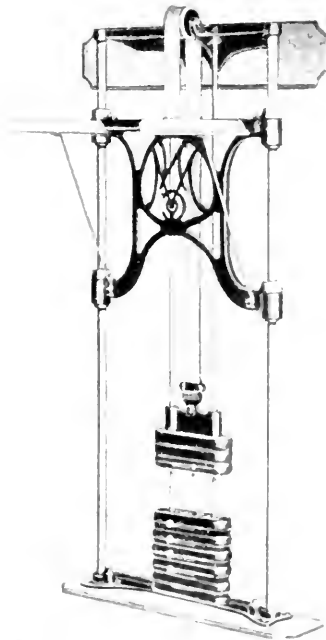

Fig. 31.—Traveling parallel. Narragansett Co., invented by D. A. S. U. S. 1,061,000, for training purposes.

too weak to engage in the heavy exercises on the parallel and horizontal bars, and, by their assistance, he is enabled to develop gradually strength sufficient for the usual feats.

An ingenious application of the pulley-weight principle is shown in an invention by George E. Goldie, in which the body-weight replaces the conventional iron plates. The gymnast lies upon a padded table running on a sliding frame. Four handles are attached to cords, at the top and bottom, so that resistance



Fig. 32.—Goldie's exerciser in use. By grasping the handles beside the feet a change in action is obtained. One upper and one lower handle may also be used together, and the resistance increased by hooking the frame to a higher rung (Spalding).

may be obtained from above or below. The upper end of the frame is raised and hooked over the rung of a ladder, fixed to the wall. Tension on any of the handles draws the table up the inclined frame, so that the body-weight is the resistant force. This resistance may be made as slight as desired by having the frame attached to the lowest rung, and may be rapidly augmented by increasing the angle of the incline. Nearly all the single movements and combinations of the pulley-weight machines may be obtained by the use of the upper or lower pair of handles, alternately or together.

All movements on the pulley-weights must be of the simplest character and slow in rhythm. Unless the movement is slower than the falling of the weight, a jerky, inefficient action is produced. They need but little coördination, and may be repeated indefinitely without great mental exhaustion. The repeated contracting and relaxing pumps the blood through the muscles, which rapidly increase in size, but if the entire muscular system be developed to its physiologic limit, a very considerable drain on the vitality is



Fig. 33.—Extreme muscular development without a corresponding increase in heart and lung power. This man could not float in sea water and died prematurely.



Fig. 34.—The nautical wheel in action.

inevitable. A man may have powerful muscular development without a capacity for prolonged exertion (Fig. 33). These exercises should then be combined with others requiring skill and endurance.

The simplicity of the movements is such that they are easily

mastered, and the interest in them soon flags. It needs a strong determination, buoyed with the hope of increased strength, to continue their use. In order to help the imagination, as well as to form a preliminary training for special sports, apparatus has been designed to imitate the movements of paddling, rowing, sculling, and bicycling, using the principle of the pulley-weight or lever. Others employ friction to give resistance to the stroke of the oar or the turn of the wheel (Fig. 34).

In the inomotor Dr. Sargent has devised a machine capable of developing all the muscular system, while allowing the exclusive use of selected muscle groups. For this purpose he uses the principle of the lever as applied to rowing and bicycling. The machine

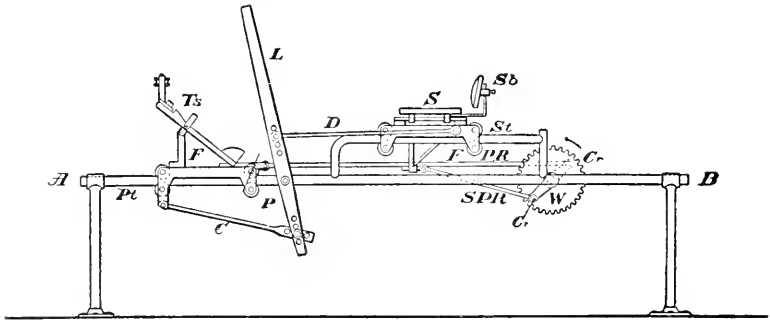

Fig. 35. —The Sargent inomotor.

consists of a pair of levers, connected, by four adjustable rods, to a sliding seat and foot-rest, which are, in turn, joined by rods to a clutch gear or sprocket wheel.

In the diagram *A-B* is the framework of steel tubing, *L* the hand lever pivoted at *P*, *F* the traveling foot-rest running on the track, *Pt*; *S*, the traveling seat, moving on the track, *St*. *W* is the gear or sprocket wheel, connected to foot-rest and seat by rods *FPR* and *SPR*. The hand lever is connected with the foot-rest by rod *C*, and with the seat frame by rod *D*. The other important parts are the toe straps, *Ts*, and seat back, *Sb*.

After taking his seat, the operator grasps the handles and pulls. As he braces his feet the foot-rest moves forward, turning the wheel *W*. At the same time the seat is forced backward by

straightening the thighs, and also serves to turn the wheel through its connecting rod, *SPR*. When extension is complete, the second half of the movement begins, and the wheel is turned by shoving on the handles and pulling the foot-rest and seat toward one another by flexing the legs. The power thus obtained may be applied to large flywheels, as in the illustration (Fig. 36), or the machine may be mounted on rollers geared down so that it moves only a few inches for every stroke. In this way the interest of a long race may be obtained in a small room. The levers are

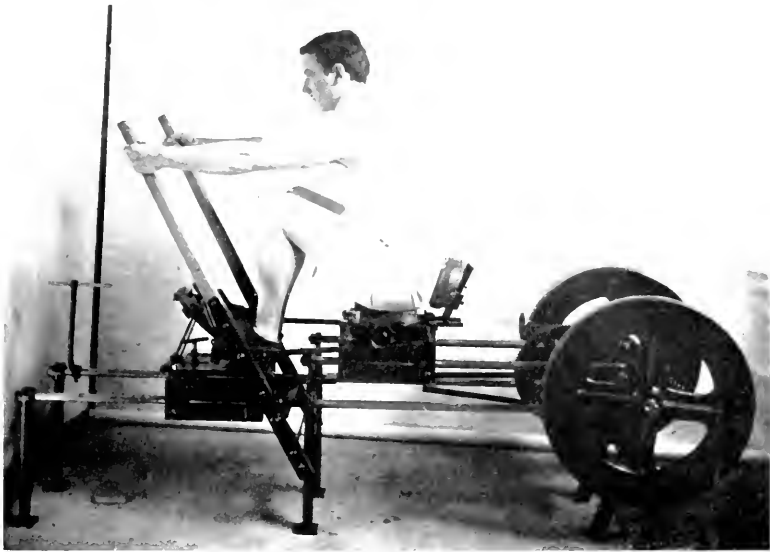

Fig. 36.—The Sargent inomotor with flywheel in place.

placed eighteen inches apart, allowing the free use of the chest-walls in breathing, and so avoiding the rapid onset of breathlessness. If desired, work and rest may alternate in opposing groups, development of any desired specialization being thus obtained. The general exercise is always sufficiently active to give valuable training for the heart and lungs.

It is capable of infinite variety in its construction and application, either as a stationary piece of developing apparatus, or as a means for propulsion on land or water.

The use of mechanical means for the treatment of disease was first systematized and employed in a complete way by Dr. Gustave Zander, of Stockholm, about 1857. He there established and directed the first Zander institute, and has been actively engaged in the practice of medicomechanical gymnastics, lecturing on the subject at the medical school of Stockholm until his recent retirement, when he was succeeded by his eldest son.

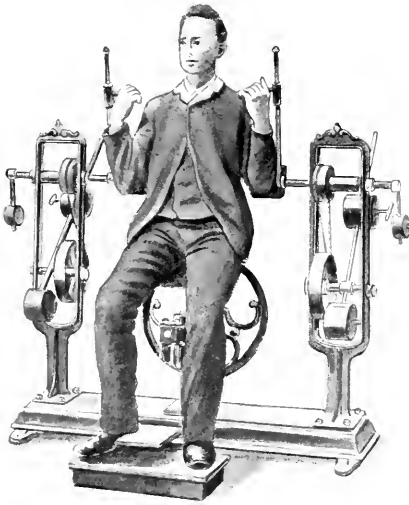

Fig. 37.—Machine for flexion and extension of the forearms.

Zander has devised nearly one hundred machines to give his exercises and manipulations, and his system of mechanotherapy has enjoyed a wide popularity in Europe, and has a considerable following in America. Zander institutes are found in Boston, Baltimore, Philadelphia, St. Louis, San Francisco, and elsewhere, while over seventy sanatoria are supplied with some of his apparatus. The machines are in three series:

First Series.—Apparatus set in motion by the muscular power of the patient.

Second Series.—Apparatus set in motion by means of some motor.

Third Series.—Apparatus exercising, by the weight of the patient's body or by mechanical arrangements, a corrective pressure or tension. They are classified, according to their physiologic effects, into four sections:

1. *Apparatus for Active Movements.*—To exercise and develop—(a) Arms; (b) legs; (c) trunk, and (d) balance. These machines are 38 in number. A typical example is Fig. 37, for forearm

flexion. Its action may be reversed and used to exercise forearm extension. A number of other machines are made reversible, a necessary economy that is at once apparent.

In the balance machine the patient sits astride a saddle-shaped seat, grasping a fixed handle-bar. A rolling rotary movement is given the seat by motor power, and to preserve the

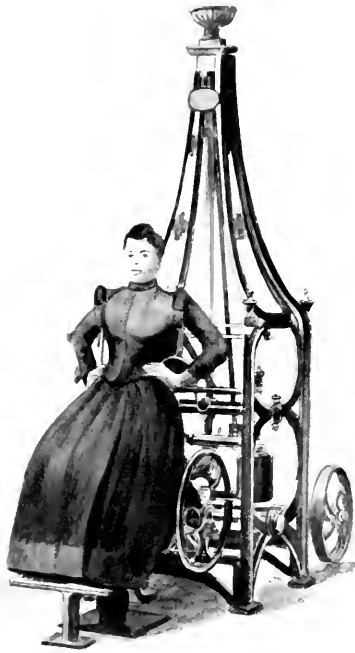

Fig. 38. "The Tower," for respiratory movements. The shoulders are held firmly, while pressure is applied to the back.

equilibrium the patient must use all the muscles of the loins and abdomen in turn.

2. *Apparatus for Passive Movements.*—To manipulate the hands and fingers, for chest dilatation, trunk rotation, and pelvis elevation. The machine for chest dilatation merits more than passing notice. It is called the "Tower" (Fig. 38), and the movement is performed by two crutch-like appliances passing beneath the arm-pits, and retracting both shoulders, while the

chest is thrust forward rhythmically by a cushion applied against the back of the patient, as shown in the illustration. The rate is set to correspond with normal respiration, and the thoracic walls are expanded and stretched by its use.

3. *Apparatus for Mechanical Operations, including Vibration, Percussion, Kneading, and Friction.*—Vibration is given to the whole body by the jolting movement of a saddle-shaped seat



Fig. 30. "The "horse," to give vibration of the whole body (sitting saddleways).

(Fig. 39), and the Zander vibrator is adjusted to give about 500 strokes a minute to the feet, legs, chest, or abdomen.

Four machines are devoted to percussion: Fig. 40 is provided with four beaters for tapotement along the spine. This machine has been called the "digitalis of the medical gymnast," from its action in slowing the heart-beat.

One machine is devoted to kneading the abdomen and six to friction of the arm, fingers, leg, foot, back, and abdomen.

4. The *orthopedic apparatus* are eleven in number, and are designed for suspension, rotation, and lateral pressure.

A complete outfit requires at least 3000 square feet of space, with consulting and resting rooms, and a gas engine or other motor.

The resistance is supplied by a weight and lever instead of a pulley-weight in all the machines requiring voluntary action from the patient. This can be augmented by moving and clamping the weight at any point of the graduated scale marked on the lever.



Fig. 10.—Zander's back percussor.

They are arranged to comply with Schwann's law of muscular contraction, which states that with increasing contraction the muscle is able to accomplish less work. The resistance is then made to diminish during the latter half of the movement, a principle neglected in all machines whose resistance is furnished by friction or elastic traction. In the machine for developing flexor power of the leg upon the thigh the greatest resistance occurs when the

leg is bent about 30 degrees from complete extension, this being estimated as the point of greatest power in the knee flexors.

Many objections to the use of duplicate movements may be overcome by employing these machines; the amount of resistance is always constant, and can be diminished or increased as desired, according to the strength of the patient. The dose can be accurately prescribed, and the uncertainty of the human hand, governed as it must be by the operator's varying physical condition, can be eliminated. The amount of resistance forms a curve, the

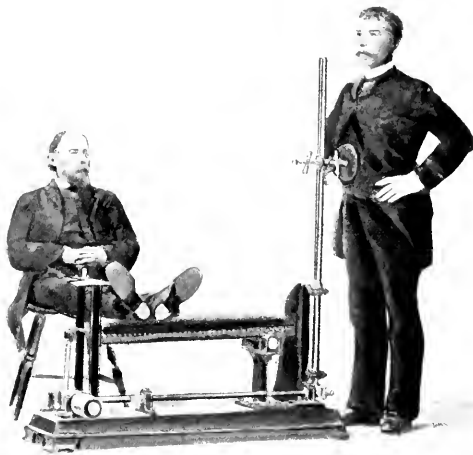

Fig. 41.—The Zander vibrator.

apex of which is at the point of greatest physiologic efficiency, thus making it more scientific in its application than the varying hand of the operator.

A number of similar machines were designed by C. F. Taylor (1869), and numerous modifications have been made to simplify the somewhat cumbersome mechanism of the originals.

The Zander vibrator gives a rate of from 500 to 900 strokes to the minute, but more recent machines carry the rate as high as 2000 to 5000 strokes.

There are three types of vibrator now in use: the rigid arm vibrator, of which the Zander machine is an example; the flexible

shaft vibrator, and the portable vibrator, attachable to an electric-light plug.

A good machine should be readily adjustable in rate and length of stroke, and should be capable of giving percussion and a rotary, boring motion. The weight of the vibrator has been much discussed, but Eberhart, of Chicago, happily compares them to various sized hammers: "If one wishes to drive a small nail, he could do so with either a sledge hammer, an ordinary hammer, or a tack hammer. The sledge hammer would drive it at one blow, but there would be much superfluous power; the ordinary hammer would drive it in four or five strokes; the tack hammer would possibly require a dozen blows. The final result would be the driving of the nail."

Mechanotherapy has obtained its greatest hold in America through the vibratory treatment. The power of properly applied vibratory movements to quiet pain, to make a rapid and excited heart beat slow and steady, and to reach, through the spinal nerves, the deep-seated organs presided over by the sympathetic nervous system, is well established.

Three points must be carefully considered in the application of this treatment: (1) The length of the stroke; (2) its rate; (3) the amount of pressure. All three can be varied within very wide limits, and modified in their effects by the applicator used, the chief attachments for a well-designed machine being a rubber brush, a ball of hard rubber, and a second ball of soft rubber for the throat and for the large muscle masses, like the erector spinae; a hollow rubber ball for the treatment of the eye; a flat disc, a vacuum cup, and special vibratodes of hard and soft rubber for rectum and vagina. The late Maurice F. Pilgrim, in his little work on vibratory stimulation, classifies the movements into: (1) Stimulation; (2) vibratory stimulation; and (3) vibration.

Stimulation is produced by a medium stroke and light pressure, with the brush attachment, for increasing the blood-supply to a region, improving its nutrition and tone. To produce mild stimulation, an application should last from three to seven seconds.

Vibratory stimulation is applied by the rubber ball with a

medium stroke and deep pressure, the treatment lasting from eight to twelve seconds over one spot. This is recommended for cases in which the viscera are to be reached by acting on the spinal nerve-roots.

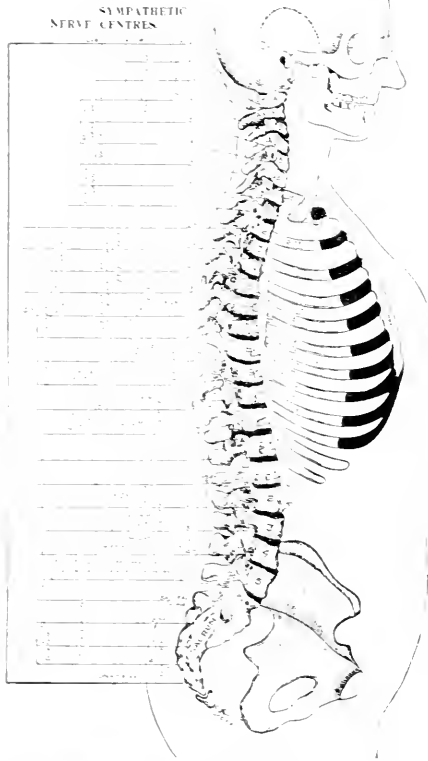

Fig. 42.—Diagram showing areas in the spinal cord from which the nerves controlling the various organs and parts of the body are given off. The red lines in the table indicate vasomotor areas. Stimulation of the centers, indicated in the diagram, will affect the organs controlled by them, see table at the left of the diagram. Pilgrim.

Vibration is produced by a heavy stroke and deep pressure with the hard-ball attachment. It should not be given for more than fifteen or twenty seconds, and is used to inhibit a nerve that is giving pain. Pilgrim especially warns operators against overstimulation, which, while not permanently harmful, is never considered desirable.

The general theory on which this mechanical treatment is based is that all functions and organs of the body are controlled by certain nerves or nerve-centers located in the spinal cord above the origin of the nerve-roots. This "pain organ" Witmer shows sensitiveness when any disturbance of function exists, and painful points are found on pressing over the exit of the controlling nerves from the spinal canal. When the nerve is vibrated, the painful point tends to disappear, and coincidentally restoration

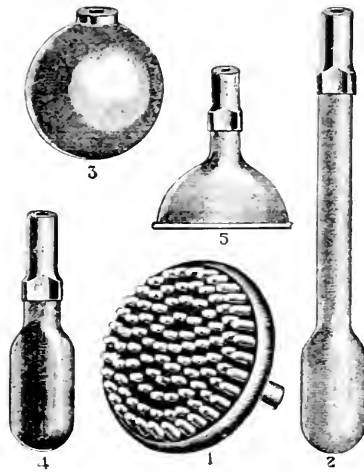

Fig. 43. Various attachments recommended for use in the application of mechanical vibratory stimulation to the various organs and cavities of the body. Pilgrim: 1, Rubber brush; 2, rectal and vaginal attachment (rubber); 3, rubber ball; 4, throat attachment (rubber); 5, eye-cup (rubber).

to normal action may be expected. The areas of the spinal cord containing the origin of the nerves that supply the various organs are shown in Fig. 42.

Case reports show a wide application, and evidences are accumulating to prove the usefulness of the Zander machine and the more modern vibrators in conditions where this form of massage is successfully employed. Their accuracy and control, compared with the administration of friction and vibration by the hand, need not be dwelt upon.

CHAPTER V

THE GERMAN SYSTEM OF PHYSICAL TRAINING

It is to Germany that modern physical education must look for one of the most powerful influences in its development and the somewhat acrimonious discussions that fill gymnastic literature, between its supporters and the followers of Ling, the Swede, have done much to clarify the principles on which the German system is based.

It is necessary here to review briefly the origin and growth of German gymnastics and their introduction to America.

To Basedow belongs the honor of first combining physical and mental education in the general training of the European youth. In 1774 he founded, at Dessau, the "Philanthropinum," to realize Rousseau's method of nature, "so that the training of the mind and body shall serve to assist each other." He employed the knightly exercises of riding, fencing, vaulting, and dancing in educating the sons of the burghers. He also drew his exercises from popular German sports, rowing, swimming, skating, and games of ball, and copied from the gymnastics of the Greeks, notably the "Pentathlon," which consisted of running, jumping, climbing, balancing, and carrying heavy weights.

Among his disciples were Salzman and Guts-Muths, Jahn and Spiess in Germany, Pestalozzi and Fellenberg in Switzerland, Nachtgall in Denmark, and Ling in Sweden.

Salzman, one of Basedow's assistants at Dessau, established a school at Schnepfenthal, near Gotha, in 1784, and here Guts-Muths received his inspiration. As he himself writes:

"I entered, when still a youth, the school of Schnepfenthal,

and thereupon Salzman, its head, conducted me to a place, saying, 'Here are our gymnastics; within this little space we amuse ourselves daily with five exercises, though they are still in their rudiments.'"

It was here that he wrote his first book, entitled "Gymnastics for the Young" (in 1793), the first German manual of gymnastics. He afterward wrote a book on plays and games, which is still a classic, as well as a third on manual training.

Many private and a few public teachers began to introduce gymnastics into their schools, and in 1799 Nachtegall established a private gymnastic institute in Copenhagen, at which Ling had his first lessons in gymnastics. Guts-Muths had two distinct aims, which may be stated in his own words as "(1) Work in the garb of youthful play, and (2) a system of exercise having bodily perfection as their aim."

The first of these principles appealed particularly to Jahn, while Ling worked more in the spirit of the second.

Friedrich Ludwig Jahn was born in 1778, in the village of Lanz. He was a man of aggressive, restless, and self-sufficient disposition, quick witted, but capricious in his reading. His career as a student was wild and irregular, and, owing to quarrels with the members of the student societies at Halle, he became a wanderer from university to university. From Halle he went to Jena, where he was forced to leave the university and become a private tutor, directing his pupils' studies and partaking in their sports. His first publication, on the promotion of patriotism, appeared in 1800, and showed his tendency to engage in popular agitation. For the next ten years he roved about, working at his book on German nationality. In this book he extolled the value of bodily exercise, and seized upon the idea of making physical training a dominant force in national regeneration.

In the spring of 1811 he opened his first "Turnplatz" in a pine forest on the outskirts of Berlin. Friesen, whose untimely death by assassination he deeply lamented, and others of his admirers and pupils, aided in its management. From the first, vigorous and war-like games were assigned a leading rôle, and

special costumes were adopted. Their badge bore the word "Turnkunst," and the figures "9-919-1519-1811."

9
919
Turnkunst
1519
1811

These figures served as reminders of Hermann's rout of the Roman legions, under Varus, 9 A. D., the introduction of tournaments into Germany, 919 A. D., the last of the German tournaments, 1519 A. D., and the revival of "Turnen," or turning, in 1811.

In a year the number of turners rose to 500. Jahn and Friesen organized a German union, hostile to all foreign rulers, and extended it to the students of various German universities. In the war of liberation members of this union were the first men enrolled in the famous free corps of cavalry, where Jahn commanded a company recruited by himself.

In the five years preceding 1816 he labored incessantly, writing and publishing his book, "Die deutsche Turnkunst," which sums up his aims and accomplishment. In speaking of the beginning of his work he says: "Love to my fatherland and my own inclinations made me a teacher of youth. During the beautiful spring of 1810 a few of my pupils began to go out with me into the woods and fields on the holiday afternoon of Wednesday and Saturday. The number increased at the various sports and exercises. Thus we went on until the dog-days, when the number was very large, but soon fell off again. But there was left a select number and nucleus who held together even during the winter, with whom the first turning ground was opened in the spring of 1811 in the Hasenheide."

In this work he pays willing tribute to Guts-Muths, the main source of his inspiration.

In 1819 plans were perfected for establishing turning grounds throughout Prussia in connection with the schools, but because

of a murder committed by one of the turners, to which political significance was attached, the student societies and Turnverein were put under the ban as being hot beds of liberalism. Jahn was arrested, as well as Francis Lieber, a youth of nineteen, one of his oldest and most favorite pupils. Lieber was exiled, and chose the United States for his new home in 1827. He came with a recommendation from Jahn for the express purpose of taking charge of a gymnasium in Boston, where he also established a swimming school.

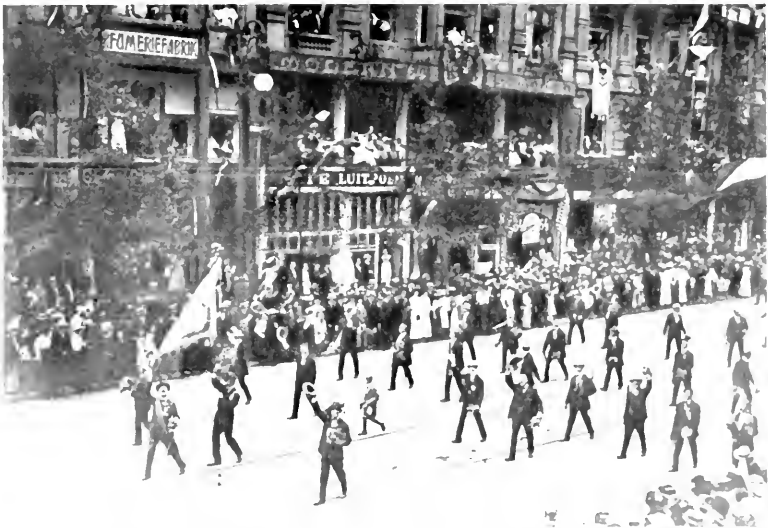

Fig. 44. People throwing flowers to the American Turners at the parade which opened the Turnfest of 1908, in Frankfurt.

Jahn's case dragged on for nearly six years, but he was acquitted in 1825, although with certain restrictions. In 1840 he was finally released and awarded the iron cross in recognition of his service during the war of liberation. Though he issued many pamphlets showing his continued interest in turning, his declining years were passed in poverty and obscurity. His last publication appeared in 1848, entitled "Schwanenrede" (swan song), closing with these words:

"Germany's unity was the dream of my awakening life, the

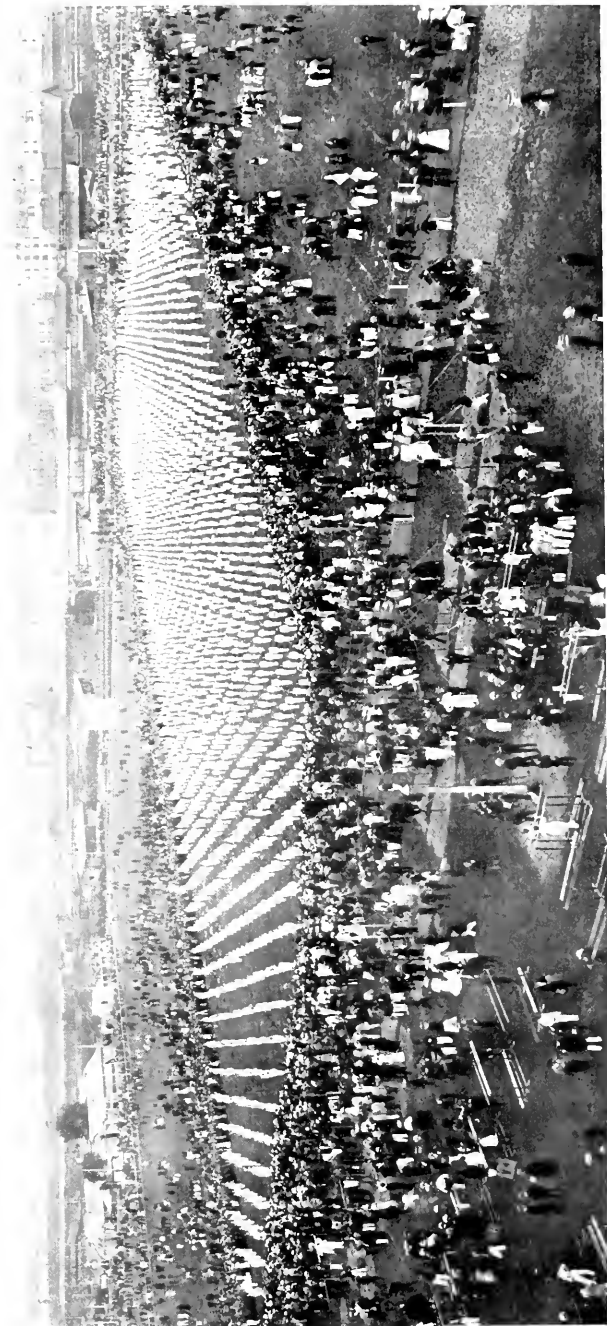

Fig. 45.—A section of 5000 turners practicing for the mass drill at the Turnfest of 1908, Frankfort

morning glow of my youth, the sunshine of my manhood, and is now the evening star which guides me to eternal rest."

The formation of gymnastic societies, however, continued to grow, and Turnfests were celebrated, until in 1861 nearly 6000 turners took part in the festivals.

At present it is as common to find a Turnverein among German colonists and peoples of German extraction as cricket and athletic sports among Englishmen living abroad.

The Turnfest at Frankfort, held in July, 1908, had 30,000 turners in line, drawn from every land to which there has been German immigration. America's numbers exceeded that of any nation outside of Germany. The hold of turning upon the German people was evident by the enthusiasm displayed during the parade of the visiting turners on the opening day. Flowers and wreaths were showered upon them by the spectators along the route.

The exercises, which continued for six days, opened by a mass drill of about 20,000 men. The illustration shows about 5000 men rehearsing for this event. Although all the societies, drawn from distant lands, had never performed together before, the exhibitions were faultless. On succeeding days group competitions and drills were given by children (Fig. 46) and by picked squads representing their societies, with individual and group competitions on the horse, horizontal and parallel bars, running, and vaulting. Prizes in the form of wreaths and diplomas were given to the successful societies and competitors.

The turners place great emphasis on mass work, and the social side has not been neglected. They have long ceased, however, to be political clubs, holding themselves entirely aloof from the consideration of party questions.

They are divided into two main sections: boys from seven to sixteen years and men. Classes are subdivided in squads, each squad being led by a "foreturner," whose business it is to make the members of his squad as expert as possible, and, above all, to secure to each an erect form and aggressive carriage of the body.

The introduction of the German gymnastics into the school

system was the work of Adolph Spiess, a Hessian, born in 1810. He was influenced by Pestalozzi, and trained in the methods of Guts-Muths. In 1829 he became acquainted with Jahn, and in the following year, while still a student, formed a class of boys at Giessen, and made a beginning by teaching what is known as common exercises, the simultaneous performance of movements in response to the word of command, either with or without the aid of apparatus. He is sometimes called the creator of gymnastics for



Fig. 40.—A mass drill of school-children at the Turnfest, Frankfort, 1908.

girls. These gymnastics he introduced into the public schools of Burgdorf, in Switzerland, where he became acquainted with Froebel. They include free gymnastics, dumb-bell drills, exercises on the suspended ladder, and see-saw, besides running, jumping, and swinging.

In 1848 he returned to Germany, and at Darmstadt carried on special normal classes to train assistants for his work, until his death in 1858. He was highly successful in teaching gymnastics to the girls of his schools.

He applied his principle of common or class exercises to the apparatus work, as well as to the free movements, and made use of music for all suitable rhythmic combinations. His distinctive work was to systematize German gymnastics and to adapt them to pedagogic purposes and methods.

The problem of training teachers was early recognized, and the Royal Central Gymnastic Institute was finally opened in Berlin, under the joint control of the ministers of war and education, after two unsuccessful attempts. Captain H. Rothstein, of the Prussian army, was placed at its head. Rothstein was a warm partizan of the Swedish system of gymnastics as developed by Ling and his followers, in distinction to the Jahn-Eiselen system, and early antagonized the turners by banishing the horizontal bar and parallel bars from the institute. This act gave rise to a long and bitter controversy in which gymnasts, medical men, and university professors took an active part, notably Professor Virchow and Du Bois-Réymond, who savagely defended the German system and the bars, declaring that if the parallel bars had not already been invented, they would be a necessity. In 1862 a commission of the most eminent medical men declared that the bar exercises, from a medical point of view, should not be excluded. As a result of this Rothstein left the Central Institute, and died in 1865.

Gymnastic instruction in the elementary schools was made obligatory in 1862 in many of the cities of Germany, and is taught by teachers specially educated for this duty, there being now more than 1500 trained teachers in Berlin alone.

The exercises are carefully adapted to the age and sex of the pupils. The youngest pupils—from six to ten—engage in a great variety of simple games, easy, free movements, marching, jumping, and climbing exercises, and the fundamental exercises on the gymnastic machines. These exercises grow more complicated and difficult for advancing age, and the expertness of the boys in the upper classes is often quite astonishing, fencing being taught in the upper schools. Singing is almost always combined with gymnastic instruction.

Outdoor games have been accorded a place in the German system from the first, but interest in them has increased to an extraordinary degree from the year 1891, when the Central Committee for the Promotion of Youthful and Popular Sports in Germany was organized under the presidency of Baron E. von Schenkendorff. Facilities for school games have been provided, and provision has also been made for their management and maintenance. The movement resulting in the American Playground Association may be traced to the labors of this committee and its distinguished president.



Fig. 47.—Typical pose in German wand drill.

The introduction of German gymnastics in America began with the arrival of Dr. Follen, a German exile, at Harvard, in 1826. The Boston Gymnasium in Washington Gardens seems to have been the first public gymnasium of any note in the United States.

In 1827 Dr. Francis Lieber, already referred to, succeeded Follen. Gymnastic grounds were established at Yale, Williams, Amherst, and Brown about the same time, while a dozen or more schools followed suit. This movement, how-

ever, was short-lived, and closed about 1830, when both Dr. Follen and Lieber left the field and followed other pursuits.

The subsequent history of German gymnastics in America is that of the growth of German immigration and the establishment of the Turngemeinden in large American cities, such as St. Louis, Milwaukee, Philadelphia, and Cincinnati. The Normal College of the North American Gymnastic Union, established in 1861, and now conducted at Indianapolis, is employing educated

teachers trained in this system by courses extending from one to four years, and the official organ of the movement, a monthly, called "Mind and Body," carries on an active campaign to introduce physical training into the school system, and disseminate knowledge on the subject.

William A. Stecher, its editor and director of physical education in the schools of Philadelphia, divides the German system into six large groups or classes:



Fig. 48.—Typical swing and balance exercise on the parallel bars.

1. Tactics, embracing marching in all its forms.
2. Free exercises, embracing all forms with hand apparatus, like short and long wands, dumb-bells, rings, and clubs.
3. Dancing steps, principally for girls, including all the movements from the simple gallop to the most complicated forms executed by expert dancers.
4. Apparatus work on the horizontal bar, parallel bars, long

and side horse, buck, suspended rings, ladder, poles, rope, round swing, see-saw, balance board, swinging board, pulley-weights, storming board, and vaulting table.

5. Track and field work, such as high, broad, and deep jumping, hop, step, and jump, running, hopping, putting the shot or stone, throwing the javelin or discus, lifting and putting up of iron weights and stones, pole-vaulting, swimming, skating, fencing, boxing, wrestling, and shooting.

6. Games and plays, the enumeration of which would take too long. The first collection of games was published by Guts-Muths in 1793.



Fig. 49.—Typical circling exercise on horizontal bar.

The exercises for children are divided into six or eight grades, to correspond with the number of years in the common or grammar schools.

Inclusive as it is of almost all forms of indoor and outdoor activity, the characteristic apparatus that will always be associated with German gymnastics, because invented and most largely used by them, are the *parallel bars*, where the typical exercises are those in which the weight is supported by the arms in vaulting and balancing. The *horizontal bar*, the glorified limb of a tree, in which the weight is also supported by the arms in circles

and levers; and the *vaulting horse*, borrowed from the days of chivalry, on which circles, vaults, and pirouettes are practised and carried to a high point of development, the weight being again supported by the arms.

Exercise on these machines emphasizes the development of the muscles of the shoulder-girdle by the almost constant use of the arms in supporting the body weight, and in this, together with the large use of music to govern the rate and rhythm of the free



Fig. 50.—Typical vaulting exercise on German horse.

exercises done in classes, lies the main difference between the gymnastics that are known as "German" and those derived from other sources. Singing and turning are inseparable, especially with the children, and the system has become more cosmopolitan of late years to fit the local conditions and national temperament in America. They now may be said to include everything except the medical application of exercise and massage, which has been left entirely in the hands of the Swedes.

CHAPTER VI

THE SWEDISH SYSTEM OF GYMNASTICS

THE Swedish system of gymnastics had its first impulse from patriotism, as was the case with the German, but in the hands of its scholarly founder it became much more finished as a gymnastic system, and comprises recreative and school gymnastics, military gymnastics, and, most distinctive of all, medical gymnastics, or the application of movement to the treatment of disease.

Peter Henry Ling, its founder, was born in 1776, two years before the birth of Jahn, in Småland, one of the southern provinces of Sweden. A dreamy, imaginative boy, he entered the Latin school at Wexio, where he distinguished himself in his classical course by his mental ability, strong individuality, unyielding will, and reckless enterprise. He was suspended or expelled from this school, along with some companions, on account of a breach of discipline. Leaving Wexio on foot, he seems to have wandered for some years in Sweden, Denmark, Germany, France, and even England, acquiring the languages of the countries in which he sojourned, and we find him, in 1801, enrolled as a volunteer in the naval defense of Copenhagen against the English. Here he remained for ten years, becoming a skilled fencer under the instruction of Montrichard, a French refugee, from whom he obtained a diploma endorsing his ability to give instruction in the art. While there he visited and attended the gymnasium of Nachtegall, and recognized the national importance of the new art, striving to classify and develop its practice according to anatomic laws and to give it the precision of mathematics.

In the fall of 1804 he returned to Sweden, to act as a substitute for the aged fencing master of the University of Lund, whom he soon succeeded. He also taught gymnastics and riding,

and applied himself diligently to the study of anatomy and physiology, putting his conclusions into practice in the system of fencing taught to his pupils. The new exercise became popular, and it was not long before interest in it and in his gymnastics spread beyond Lund. Invitations to introduce the *double art* were received from Gothenburg, Malmö, and Christianstead, where he gave instruction during the summer vacations in the arts of swimming, fencing, the saber, and gymnastics.

The eight years of his stay in Lund were also fertile in literary activity, for it was then that he first began to know and love the Scandinavian mythology, and to compose patriotic poems in French, German, Danish, and Swedish. About this time he also wrote "Agned," a tragedy in five acts, which was presented on the stage at Stockholm. One of his poems, "Gyfle," deals with the loss of Finland, which the Swedes bitterly deplored. These plays and poems show the intensity of his patriotism and his desire to see his countrymen strong in body and soul, with power to meet her enemies. Fervid patriotism was the inspiring motive of his poems and his gymnastics alike, though in the latter he saw a practical means of restoring the health as well as of developing the physique of the race to defend the fatherland. During these eight years he thought out the principles upon which his later work was based, seeking, first, to understand the human body and discover its needs, and then to select and apply his exercises intelligently with these needs in view.

He conceived the idea of opening in Stockholm a central institute based on the one already in operation in Denmark for the training of teachers of gymnastics for the army and school. He took as his pattern the institute of Nachtegall, in Copenhagen. His plan was successfully carried out, and the school was opened in 1814, in the northern suburb, Normaln, on the site occupied ever since. Here he equipped the necessary rooms, gymnasium, fencing hall, and offices, in some old buildings which had once belonged to a cannon factory. By increased grants from the Government he was soon furnished with an assistant, and two others were added from time to time, until, in 1830, he had three.

Ling believed that gymnastics had a rightful place in education, medicine, and national defense, and almost from the start instruction was given in these three branches. In spite of a good deal of jealousy and opposition he continued to teach fencing and gymnastics to the Swedish army, under the sympathetic encouragement of Bernadotte, who afterward reigned as Charles XIV. When it was shown that the French and Prussian soldiers were being drilled in bayonet fencing, his method of teaching this exercise was investigated and chosen in preference to all others, and it became an established part of their regular training.

In 1836 he published a manual of bayonet fencing for use in the army, and another of gymnastics, in which he found it necessary to limit the exercises to simple forms that required little or no apparatus.

He commenced the development of medical gymnastics after the first year of the Institute in Stockholm, against bitter opposition on the part of conservative physicians.

His school gymnastics comprised only a few stretching movements, sometimes assisted or resisted by another pupil, but with little apparatus, the Swedish educational gymnastics in its present form being a comparatively recent growth.

During all this time his literary activity was intense, and always in the realms of mythology and the ancient legendary history of the Scandinavian race. His literary labors were rewarded by membership in the Swedish Academy, where he also received the grand prize. The title of professor was conferred upon him, and he was decorated with the Order of the North Star. His collected writings fill three large volumes, of which only about 350 pages have to do with gymnastics.

From his first marriage he had one surviving daughter, Jetta, and by his second wife, three of his seven children became teachers of gymnastics—Hjalmar, Hildur, and Wendla, the first two at the Central Institute. In 1839, after some years of impaired health, he died and was succeeded at the Central Institute by Branting and Georgii, who, in company with Dr. Liedbeck, one of his pupils, and husband of his daughter Jetta, arranged his literary

remains for publication. The year after his death they published his principles of gymnastics in the incomplete and often fragmentary form in which he left them, a treatise begun as far back as 1831. This book, after an opening section devoted to the laws of the human organism, takes up in order the principles of educational, military, medical, and esthetic gymnastics, and closes with a few pages of miscellaneous suggestions and comment.

Ling's system was constructed in the light of the physiology of his day, which often sounds fantastic in the presence of modern discoveries. His physiology with regard to the nature of life, the laws of organic unity, and the relation of parts seems quaint to modern thinkers, and is not easily translated into the scientific terms of to-day. His work relating to gymnastics is, however, of a thoroughly practical nature, and he must have been a most inspiring teacher. He never completely expressed his scheme of esthetic gymnastics, and the school gymnastics were the life-work of his son Hjalmar.

Immediately after his death Branting was appointed director, a position he retained for twenty-three years. A student of the largest medical college in Sweden, a fluent linguist, and a wide traveler, he devoted himself with marked enthusiasm to medical gymnastics in accordance with the theories of his predecessor, and brought that department to a high degree of perfection. He insisted that the beneficial effects of exercises were due not alone to changes produced in the muscular system, but mainly to the influence exerted upon the nerves and blood-vessels—a novel view at that time. He also worked out a terminology which, with a few changes, is still employed in Sweden. At this period the work of the institute began to awaken the attention of other countries. Two Prussian army officers, Lieutenant Rothstein and Tschow, were sent from Germany to Stockholm to take the regular course of instruction, and Rothstein afterward wrote extensively on the Ling system. His connection with the Berlin Central Institute has already been alluded to in the previous chapter. He endeavored to model it on the pattern of the Swedish school, but without its department of medical gymnastics.

Many other foreigners came for visits of varying duration—physicians especially were attracted, among them Dr. Matthias Roth, of London, the father of Bernard Roth, F. R. C. S., whose work on scoliosis is referred to elsewhere.

Among the teachers at the Central Institute were Karl August Georgii (1808–81), a lieutenant in the army, who became head teacher in 1839, giving instruction in anatomy and the three branches of practical gymnastics. He published a treatise on the Ling method of *kinesitherapy* and physical education. Three years later he removed to London, where for twenty-eight years he had a private institute, teaching fencing and school gymnastics in addition to his medical work. Here he published, among other things, a biographic sketch of Ling, the "new movement cure," and a book on rational gymnastics. Branting's successor was Colonel Gustave Nyblaeus (1816–1902), under whose directorship the course was increased from one year to two years, and practical gymnastics finally reorganized, with its three sections, educational, medical, and military, each having a head teacher and a second teacher.

John Hartelius (1818–96), a graduate of the institute, who afterward completed a course in medicine, took charge of the medical gymnastics in 1864. During his term he wrote, besides small manuals on anatomy, physiology, histology, and hygiene, a larger work on medical gymnastics, which was translated widely. He also founded and edited the "Tidschrift i Gymnastics," a semi-annual magazine devoted to gymnastics, contributing many articles on his own and related subjects.

To Hjalmar Frederick Ling (1820–86) Swedish educational gymnastics is largely indebted for its present form, and the school gymnasium for the nature and arrangements of the equipment now in use. At first a pupil of his father, he afterward attended Claude Bernard's lectures on experimental physiology at the Hôtel Dieu, in Paris, and lived for a year in Berlin, whither he went to introduce the Swedish method of medical gymnastics. After his return to Stockholm, in 1864, he was assigned the section of school gymnastics. His task was to devise new forms of apparatus

adapted to the need of the school, and to so arrange them that large numbers could exercise at the same time. He largely increased the number of useful exercises, and brought them within the reach of every pupil. He is the originator of the grouping of exercises known as the "day's order," which is so characteristic of the Swedish system. Familiar with the whole range of gymnastic literature, he was an industrious compiler, and left behind a carefully arranged collection of nearly 2000 pen drawings of positions and movements used in gymnastics, all made by his own hand. He died in 1886.

Hjalmar Ling's successor was Lars Mauritz Törngren (1887). A third year was now added to the course. His writings included a manual of gymnastics for the navy and a book on school gymnastics. The second teacher in the section on school gymnastics, Major Karl Sillow, has been very active and successful in the work of his department, and has made further improvements in the construction and arrangement of apparatus. Hartelius was succeeded in 1887 by Robert Murray, also a regularly trained physician, in the section of medical gymnastics, and Colonel Victor Gustave Balck about the same time assumed control of the section on military gymnastics. The latter has been an ardent advocate of outdoor and other sports for the young, and has been active in organizing societies for their cultivation, editing a series of a dozen illustrated volumes devoted to a description of their various forms. He founded, in 1881, the "Sporting Times," and has been the most enthusiastic promoter of those popular gymnastic societies that have spread the fame of Swedish gymnastics to other countries, accompanying squads of his fellow-countrymen to exhibitions in Brussels, Paris, London, Copenhagen, and Berlin. He was a member of the committee appointed to prepare the new hand-book of gymnastics for the Swedish army and navy.

The Swedish gymnastics were introduced into the United States by the late Baron Nils Posse through the instrumentality of Mrs. Mary Hemenway, and Boston has been the center from which their influence has spread. A most active propaganda was

started by Baron Posse, who lectured and wrote widely on the subject, and as a result the Boston Normal School of Gymnastics was founded in 1889 by Mrs. Mary Hemenway, to provide



Fig. 51.—Drill in the movements of fencing (Boston Normal School of Gymnastics).

the means whereby those masters and submasters who desired it might make a thorough study of the Ling system for the benefit



Fig. 52.—A Swedish drill (Boston Normal School of Gymnastics).

of the schools. This resulted in the introduction of the Swedish system of gymnastics in the Boston public schools in 1890, under the direction of Hartwig Nissen. After two years' service, Baron

Posse resigned and was succeeded by Claes Enebuske, he himself founding a normal school, the Posse Gymnasium, which is still carried on by the Baroness in Boston. Both schools give a two-year course in both theory and practice, and include a wide range of subjects in their curriculum. By a recent arrangement the Boston Normal School became a department of Wellesley College, thus giving greater facilities for the teaching of outdoor sports which have become an important part of the practical work of physical training. Its director is Amy Morris Homans.

Although Swedish gymnastics have been considerably modified by Ling's successors, and particularly by his son, the development has closely followed the lines marked out by its originator.



Fig. 53. — A game of field hockey (Boston Normal School of Gymnastics).

His military and medical gymnastics were his most important complete accomplishment. He classified movements into groups, as they were directed to the muscles of the trunk, head, arm, or leg, making use of a table which was the forerunner of the present "day's order." His first table consists of three order leg movements, afterward increased to five; then follows, sixth, a leg movement; seventh, an arm movement; eighth and ninth, leg movements; tenth and eleventh, arm movements—all of a respiratory nature. His tables also show a forecast of the progression which is the other characteristic of the Swedish system.

His long experience in training military cadets strongly influenced the character of his theories. E. M. Hartwell justly observes

that Swedish gymnastics still bear witness to their semimilitary origin. Ling's peculiar aims are more completely reflected and his methods more fully embodied in the physical training of recruits and soldiers than in any other department of Swedish gymnastics. The military element in Sweden has in turn served to add dignity to physical training as a profession, and to raise the intellectual and social standing of gymnastic instructors.

The three distinguishing points of the Swedish system of educational gymnastics are:

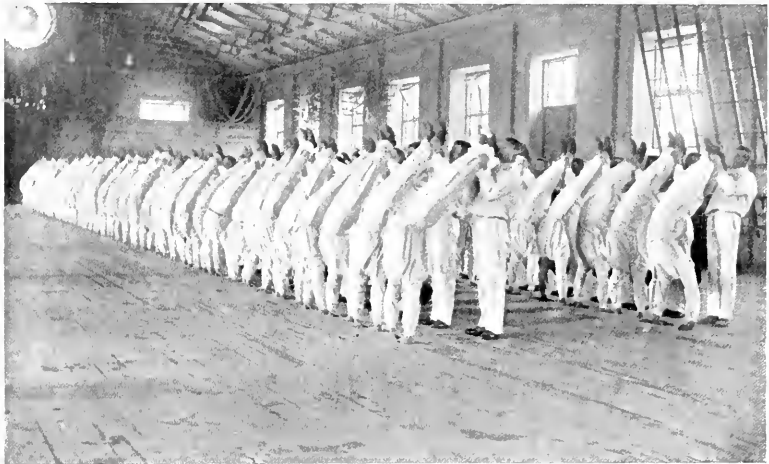

Fig. 54.—The Royal Guard of Sweden at work in the gymnasium (Lefebure).

1. The day's order.
2. Gymnastic progression.
3. The use of the word of command for movements instead of imitation.

The exercises of the day's order are always arranged under the following ten classes, each of which can be made more difficult or complicated, as is deemed advisable by the progress of the pupil. The order is:

1. Introductory exercises, class formations, facings, and marching steps (Fig. 55).

2. Arch flexions, consisting of backward flexions of the trunk, executed by the arching of the spine, done either with or without apparatus (Fig. 56).

3. Heaving movements, designed to cultivate elasticity of the chest and increase respiratory power. Usually exercises of hanging and climbing (Fig. 57).



Fig. 55.—Introductory exercise position, neck firm.



Fig. 56.—Arch flexion at the stall bars.

4. Balance movements, or exercises of equilibrium, requiring high coördination, rather than force, and especially directed to improve the posture of the body (Fig. 58).

5. Shoulder-blade movements, exercises for the arms, usually done in some position producing isolation of the chest and head, the object being to raise and widen the chest (Fig. 59).

6. Abdominal exercises, bringing into play the muscles of the abdomen, and by that means acting upon the digestive organs and improving the natural support of the viscera (Fig. 60).



Fig. 57.—Heaving movement on ropes.



Fig. 58.—Balancing exercise.



Fig. 59. —Shoulder-blade movement.

7. Lateral trunk movements, consisting of rotation, sidewise flexion of the trunk, and exercises derived from these types (Fig. 60).



Fig. 60. —Abdominal exercise on stall bar.

8. Leg movements, for the purpose of relieving the engorged veins of the fatigued legs (Fig. 62).

9. Leaping and vaulting over a string or Swedish horse (Fig. 63).

10. Respiratory exercises, accompanied by movements to assist respiratory activity. They are designed to restore normal



Fig. 61.—Lateral trunk movement.

respiration after the more active work that has gone before (Figs. 64, 65).

This order may be slightly varied by introducing, after the balancing exercises, marching and running, or by introducing a series of heaving movements after the lateral trunk movements, thus increasing the groups in a day's order to twelve.

The order of exercises is the basis of the Swedish method, and may be depicted graphically by the following diagram, repre-



Fig. 62.—Leg movements.



Fig. 63.—Leaping exercise.

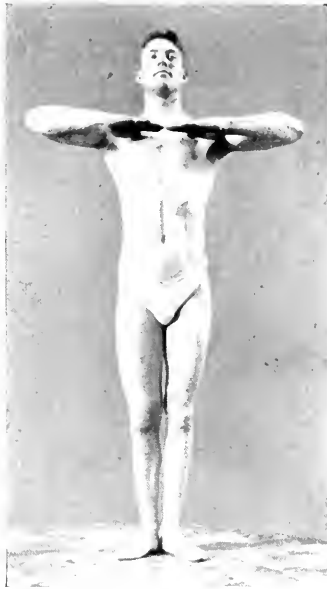

Fig. 64.—Respiratory exercise No. 1.



Fig. 65.—Respiratory exercise No. 2.

senting a forty-minute lesson period, the height of the curve showing the intensity of the effect on the circulation and respiration. The height of the line for the abdominal exercises is probably insufficient in this diagram (Fig. 66).

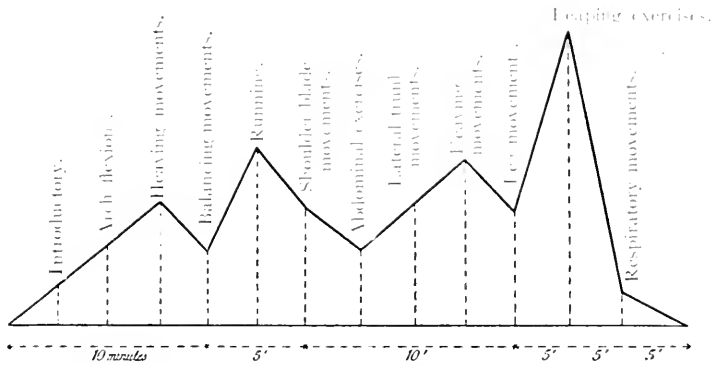

Fig. 66. —Diagram of the day's order, showing the time devoted to each division and the amount of effort required for each (Lefebure).

The apparatus used differs in certain important respects from that of the Germans. The parallel bars, horizontal bar, and spring-board are eschewed, while the horse is modified in form; instead of these are introduced stall bars, boom, climbing ladders, and poles, while much use is made of the inclined rope and the balancing board. The exercise table or plinth (Fig. 67), used in medical gymnastics, is either flat or adjustable to different angles.

Ling intended that his system of gymnastics should form a complete method of physical education, designed to develop all the bodily powers, but he did not live to complete his intention. In the fragmentary state in which his plans were left, and in which they have remained in the hands of his followers, Swedish gymnastics as a complete system are open to the criticism that insufficient emphasis is laid upon endurance, and excessive emphasis laid on the constant voluntary attention of the pupil. Their accuracy makes them peculiarly efficient in correcting the tendency of school children to assume abnormal and hurtful postures, and the stress laid upon the proper carriage and movements of the

trunk undoubtedly serve as an antidote to the evil effects of the school desk.

Swedish gymnastics are educational because they are progressive, definitely arranged according to a fixed law, and require a prompt response to the word of command. To be called a complete system, however, they must include the free outdoor sports and games, on which so much emphasis has been laid by Colonel Balck, who, recognizing this lack, has done much to correct it.



Fig. 67.—Gymnasium plinth (Narragansett Co.).

In many cases the gymnastic lesson of the Swedish school is now replaced by an hour of skating, long walks, or gymnastic games and dancing, and in the training-schools for teachers the introduction of dancing steps and other movements to music, which may be termed esthetic, is not regarded with the horror that it would have excited a few years ago. It may be looked upon as the modern development of esthetic gymnastics, which Ling had in mind but never worked out.

The military gymnastics need not be dwelt upon here, as they consist largely of fencing with the foil and saber, riding, and other

military exercises, which are not exclusively Swedish in character, but the medical gymnastics, which are so widespread in their application, deserve a more careful consideration.

Classification and practice of the movements of massage, described in another chapter, have been largely the work of Swedish practitioners, and all the duplicate movements were described and named by Ling with extreme exactness, so that a prescription of exercise may be written with clearness and accuracy.

All movements have a commencing, intermittent, and terminating position, the fundamental positions being standing,



Fig. 68.—Dancing steps to music (Boston Normal School of Gymnastics).

sitting, lying, and kneeling. In standing there are derivative positions of the legs, like flexed standing, or of the arms, like yard standing, or the hips firm position, or of the trunk, like curved standing. The similar derivative positions are described for sitting, kneeling, and lying.

As these are usually self-explanatory and are employed in describing prescriptions in the section on Medicine, no further explanation need be made here.

CHAPTER VII

THE "SOFT BUSINESS OF JAPAN," THE "GOSPEL OF RELAXATION," AND THE "DOCTRINE OF CONTRACTION"

THE rise of Japan to the position of a world's power has brought prominently to the attention of western readers an oriental exercise which has been elevated to the dignity of a system by some writers. It is known as *jiu jitsu*, or, in its more modern form, *jiudo*.

The origin dates back about four centuries, when a certain Akiyama went from Japan to China to study medicine. While there, he saw a way of fighting called *hakuda*, consisting of various methods of striking and seizing. This he learned; also twenty-eight ways of recovering a man from apparent death (*kuatsu*). He began to teach it on his return to Japan, but with so little success that he went for help to the Tenjin shrine, and there worshiped for one hundred days. One day, while out walking, during a snow-storm, he observed a willow, its branches covered with snow. Unlike the pine, which stood erect and broke before the violence of the storm, the willow yielded to the weight on its branches, but did not break. Reflecting upon this principle, he began work and invented over 300 different holds, naming his school Yoshin-Riu, or the spirit of the willow tree.

Jiu jitsu is the art of fighting without weapons, and was the exclusive possession, until about forty years ago, of the Samauri, or swordsmen, of Japan. While it is probably Chinese in origin, it was developed in Japan, where it was practised by the Samauri for the defense of an unarmed man against a man of stronger physique, or one armed with a sword, club, or spear. Its object is to place the antagonist at one's mercy by the mere pressure of

the finger or hand, to throw him by first disturbing his equilibrium, and then yielding suddenly to his struggle to regain it. It also enables one to place his opponent's joints in such a position that they may be broken by his struggle to free himself. It includes

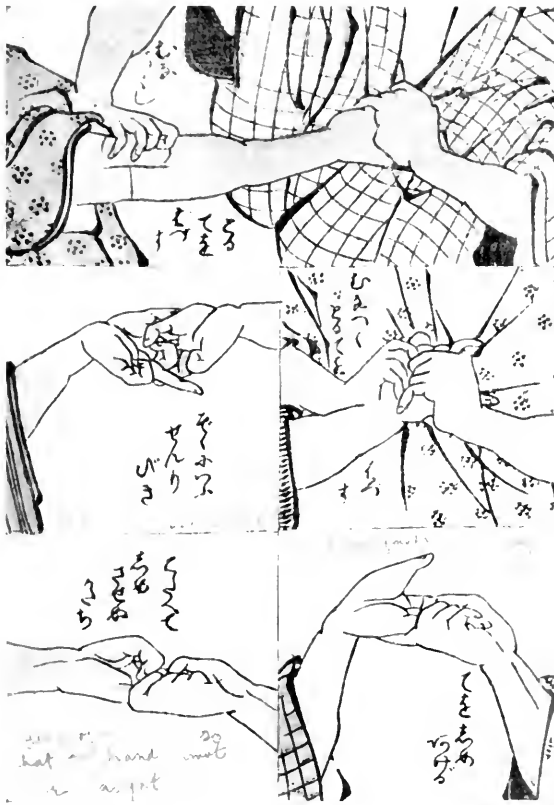

Fig. 60. —Page from a sketch-book of Hokusai (1760-1840) showing: 1, Defense against a man who seizes your (Keiko-gi) garment by wrist and elbow hold; 2, bending the second finger; 3, wrist hold with both hands; 4, finger hold, beginning; 5, finger hold, finish.

numerous methods of taking strangling holds about the neck by the hands alone or by grasping the jacket. Some of these holds are shown in the sketch-books of Hokusai as early as 1750.

The art was jealously guarded by the Samauri, and marvelous

tales were told of their prowess in it, but since the abolishment of feudalism, forty years ago, the secrets have become common property. It is now taught widely in Japan, and is part of the physical training of the cadets in the naval and military academies under the more modern name of jiu-do. Its real merits have been



Fig. 70.—Page from Hokusai's sketch-book illustrating jiu-jitsu.

much obscured by the extravagant claims made for it and the exploitation it has received in America.

One of the principal secrets of the art was "kuatsu," or bringing back to life. An illustration (Fig. 71) from an old book on the subject will serve to show the principle on which this part of the

art was based. The spots on the back mark the joints of the vertebrae. The point of the middle finger of the right hand is placed on the uppermost one, and the heel of the hand is struck smartly against the lowest, the left hand being placed on the breast. "Thus," the description goes on to say, "you can bring him back to life." This is evidently intended for a man who has been choked, and is strangely like the procedure of slapping on the back for a similar condition, so familiar to the Caucasian eye.

Other illustrations show the knee in the hollow of the back, the hands brought under the opponent's arms, with directions to press on the chest and shove with the knee. This and many others show varieties of artificial respiration, but none seem more efficient than Howard's, Sylvester's, or Schaeffer's methods, as taught to all medical students. Another procedure in the art is the pressing on painful points. This was spoken of as the "fatal touch" in the years when the secret belonged to the Samauri alone.

In Fig. 72 the black spots show the situation of these "fatal" points, and pressure is made with the point of the thumb or finger, and in most cases is intensely painful. The circle on the back of the figure marks the spot in which the knee should be placed in the practice of resuscitation.

In the practice of jiu jitsu blows were delivered by the ulnar border of the open hand across the larynx, also gouging, kicking in the face or groin, stepping on the arm or leg of a prostrate foe so as to break it, and other foul tactics forbidden in boxing and wrestling. It was never considered from the standpoint of play, but as the last resort of a disarmed man whose life was threatened.

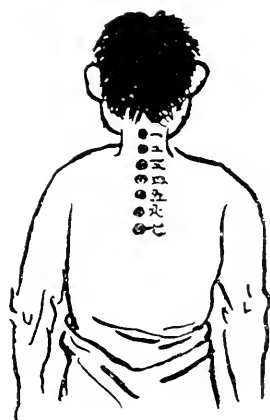

Fig. 71. Katsu (make alive). When a man is killed by the collar or strangle hold, put your left hand on his breast and middle finger of right on first joint of the neck, and with the heel of the hand hit the seventh joint of the same. Thus you can bring him back to life.

In its modern form these dangerous blows and holds have been, for the most part, eliminated, and in the best known school of jiu-do, that of Kano, in Tokyo, it is studied not only as a physical exercise, but as a moral and intellectual training.

The course is divided into two parts, called "grades" and "undergrades"; the undergrades are divided into three: A, B, C. There are ten grades, proceeding according to the degree of training. The teaching in all the higher grades is devoted chiefly to mental training and emotional control. Every afternoon many hundreds of boys and young men, mostly between ten and twenty

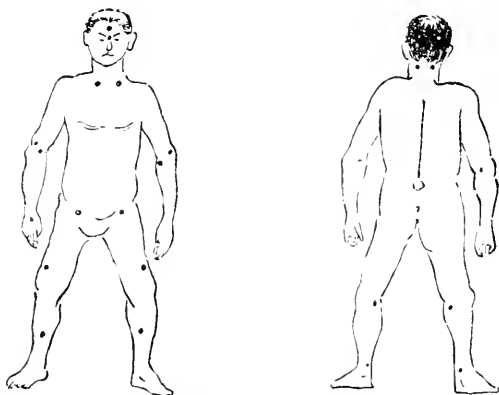

Fig. 72.—Diagram of the painful spots or "fatal touches" (from an old Japanese work on the subject).

years of age, gather from all parts of Tokyo for practice in the spacious hall of the school, its floor spread with thick mats of woven grass.

The constables of the police department are trained in the system, and there are now over thirty places where jiu-do can be learned in Tokyo.

The art was introduced to America by J. J. O'Brien, who became interested in it as inspector of police at Nagasaki, studied it, and finally came to America to give public exhibitions and private lessons. He modified it considerably, adapting holds to European clothing that had been originally designed for the

Japanese jacket and belt, and using defensive holds against a man armed with a pistol, as the Japanese used it against the swordsman (Fig. 73).

In most of the holds and grips the strong and weak positions of the joints have been most cunningly considered. If we imagine the wrist cut across the middle, to show the position of the tendons, it will be seen that, on the back, they are scattered and placed flat against the bones, while on the palm they spring out against the



Fig. 73.—Jiu jitsu applied to a man armed with a sword. Breaking the elbow and taking the sword from him.

ligament, holding them in their sheath (Fig. 74). The difference in the strength between flexion and extension is almost as 2 : 1, and when the hand has been strongly flexed, even that small power of extension is greatly reduced.

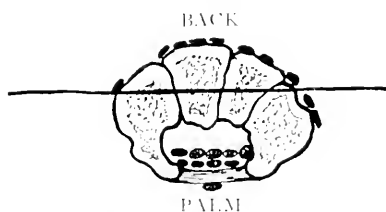

Fig. 74. Cross-section of the wrist, showing position of tendons and bones.

The object of many of their holds is to force the hand quickly into this position of extreme flexion, where it is comparatively easy to keep it, and where slight additional pressure produces great pain (Fig. 75).



Fig. 75.—The wrist hold and fall (taken from an old Japanese book). The defense given is a kick in the face, delivered when rolling over.

Another favorite joint on which they work is the elbow. The power is applied in one of three ways. The joint, being a hinge that locks when the arm is straight, the forearm and



Fig. 76.—The elbow hold.

arm thus become a long rigid lever, with its weak point at the

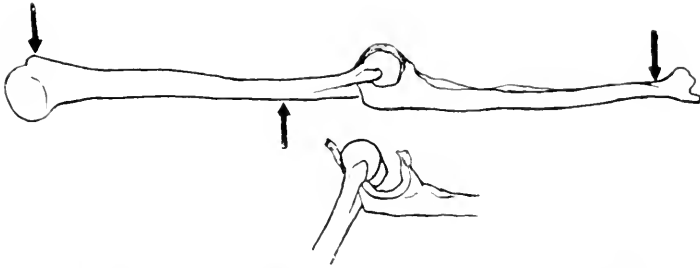

FIG. 77. Rupture of the anterior ligament following elbow lock.

center (Fig. 76). If pressure be applied downward, at the wrist and shoulder of the extended arm, with counterpressure up-



Fig. 78.—This hold is got by grasping the enemy's right hand with the left from the front, lifting the hand and spinning under the arm to the position shown in the illustration. This hold is not shown in Japanese books, but was developed from them by J. J. O'Brien.

ward just above the elbow, the anterior ligament will tear and the joint become disabled. In most of their holds on this joint

the man's own weight is used as the downward force at the shoulder (Fig. 77).

In another lock the arm is turned so that the bones of the forearm cross into extreme pronation. Power is then applied,

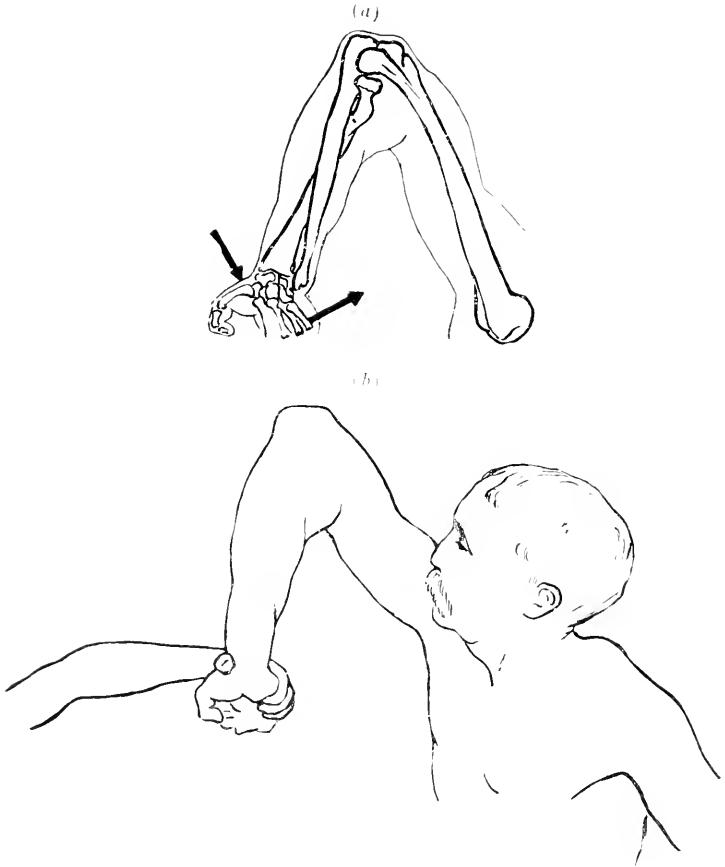

Fig. 79.—*a*, Position of the bones, showing the crossing of the radius and ulna and the direction of the twist; *b*, position of the arm when the hold is well taken.

so that the radius is wrenched out of its socket, or the wrist ligaments torn and the arm rendered useless (Figs. 78 and 79, *a*, *b*).

The principles of these holds are comparatively few and simple, but their applications are many and difficult to acquire,

even imperfectly. The holds are so arranged as to pass from one into another almost automatically, so that if one is successfully resisted, the opponent usually struggles into a worse one. They are difficult, and even dangerous, to demonstrate with one who is unacquainted with their possibilities, because a novice may continue to struggle when he should yield, and so do himself serious injury. It is most unlikely that a small, puny man could, by this means, become invincible when pitted against a powerful, active athlete, but with anything like equal conditions, it is a most valuable means of defense.

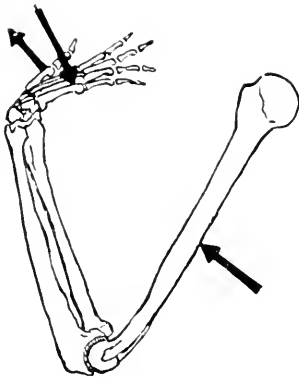

Fig. 80. Position of the bones in Fig. 81. The power applied on the hand and upper arm prevents straightening of the elbow.



Fig. 81.—This hold begins by grasping the left wrist and hand of the enemy with your right and bending the wrist into flexion. To escape the pain he instinctively bends his elbow and so jumps into the hold, as shown in the illustration. This hold was also worked out by O'Brien along Japanese lines.

In its old form it has no place in our calendar of exercises or sports, for it was not a game, but rather a way of equalizing an apparent disadvantage in fighting, and it could not be classed among the forms of exercise to be taught in a school or college, unless as an accomplishment or for purely military purposes, like the French Savate (foot boxing), which is combined with the bayonet exercise in the military school at Joinville.

In its modern form, as developed by Kano and his pupils, these dangerous locks are barred, and trips and throws are almost exclusively employed, great emphasis being laid on ways of falling, so as to prevent injury from shock of the hard floor or mat. It thus becomes like a combination of collar and elbow wrestling and tumbling, and, as such, is a distinct addition to our repertoire of exercises.

It is not probable that any great or permanent influence will be exercised by jiu-do on the methods of physical training in America, foreign as it is in origin and aim to Anglo-Saxon ideals. Physical education has, however, received distinct contributions from other lands besides Germany and Sweden, which have appealed to the national temperament and have become absorbed, modifying its development to a marked degree. Many of these systems or, as Hartwell terms them, "systemettes" have had a more or less ephemeral existence, and the main object of some of them has been other than the development of the body by muscular exercise.

THE DELSARTE SYSTEM

Perhaps the best known of these lesser systems is one that has been both exploited and maligned, under the name of François Delsarte, a Frenchman, born at Solesme, in 1811. At the age of twelve he was sent to Paris to study painting on china, but his tastes carried him in other directions, and he became, in 1825, a pupil of the conservatory, a government institution for instruction in acting, music, and the ballet. Here he lost his singing voice, and, finding himself incapacitated for the stage, he resigned that career to study and teach elocution and dramatic art.

After many years of thought and observation he succeeded in formulating what he termed the laws of esthetic science, which had, he claimed, the precision of mathematics. Like all enthusiasts, he remained, until his death, in 1871, on the eve of a series of discoveries which he felt would revolutionize dramatic expression.

He never published an adequate account of his researches, but his scattered and fragmentary notes were collected by Alfred

Giraudet, of the Grand Opera, Paris, his favorite pupil, and by his daughter, Marie (Madame Geraldyn), whose tour in America will be referred to later.

Delsarte believed that the perfect reproduction of the characteristic posture will produce the emotion depicted by the actor, and much of his work may be described as an attempt to classify and make scientific the empiric rules of the pantomime. Positions of the fingers, hands, and legs are named and classified, and the expressions of the mouth, nose, and eyebrows are discussed in a way that recalls the quaint studies on physiognomy by Levator.

Gesture as a form of language was his constant study. He writes: "When a man says to you, in interjective form, 'I love, I suffer, I am delighted, etc.,' do not believe him if his shoulder remains in a normal attitude. Do not believe him no matter what expression his face may assume. Do not believe him — he lies; his shoulder denies his words. That negative form betrays his thoughts."

The system designed by him, and carried on by his immediate followers, analyzed form, poise, and gesture in relation to emotion, but much of his writing shows the enthusiast and the dreamer. His theories were made practical by his strong personal magnetism and the social gifts that made him a welcome guest at more than one royal table.

He himself did not elaborate any system of gymnastics to develop the body, but he did teach a few principles and exercises necessary for stage falling and other maneuvers in acting.

The work of Delsarte was brought to the attention of Americans by his most ardent disciple, Steele Mackaye, who planned to bring his master to America to lecture on and demonstrate his ideas. Unfortunately, the Franco-Prussian war intervened and he died during the Commune.

His teachings were made into a system of physical culture, the motto of which was "relaxation," by Mackaye, Genevieve Stebbins, Emily Bishop, Anna Payson Call, and others, and when his daughter, Marie, was induced to make a tour in America, she found her father's theories so distorted and mis-

CRITERION OF THE HAND.









		SPECIES.		
		1	3	2
GENUS	I	<p>1-II. Ecc.-conc.</p>  <p>Convulsive.</p>	<p>3-II Norm.-conc.</p>  <p>Tonic or power.</p>	<p>2-II. Conc.-conc.</p>  <p>Conflict.</p>
	III	<p>1-III. Ecc.-norm.</p>  <p>Expansive.</p>	<p>3-III. Norm.-norm.</p>  <p>Abandon.</p>	<p>2-III. Conc.-norm.</p>  <p>Prostration.</p>
	II	<p>1-I Ecc.-ecc.</p>  <p>Exasperation.</p>	<p>3-I. Norm.-ecc.</p>  <p>Exaltation</p>	<p>2-I. Conc.-ecc.</p>  <p>Retraction</p>

Fig. 82.—Delsarte system of oratory (E. S. Werner).

RECAPITULATION.

II	$\left. \begin{array}{l} 2 \\ 3 \\ 1 \end{array} \right\}$	Concentro-concentric.	Conflict.
		Normo-concentric.	Tonic or power.
		Eccentro-concentric.	Convulsive.
III	$\left. \begin{array}{l} 2 \\ 3 \\ 1 \end{array} \right\}$	Concentro-normal.	Prostration.
		Normo-normal.	Abandon.
		Eccentro-normal.	Expansion.
I	$\left. \begin{array}{l} 2 \\ 3 \\ 1 \end{array} \right\}$	Concentro-eccentric.	Retraction.
		Normo-eccentric.	Exaltation.
		Eccentro-eccentric.	Exasperation.

represented that she refused to identify his name with the movement, and confined her attention to giving semiprivate lectures

and parlor entertainments in elocution and the interpretation of Lafontaine's fables according to the rules taught by him.

In its Americanized form, the so-called Delsarte method had a great vogue in schools for young ladies and in society, and it is largely through the writings of Genevieve Stebbins, Anna Payson Call, and Mrs. Bishop that it has been called "the doctrine of limpness." Here is a typical exercise from Emily Bishop's book, "Americanized Delsarte Culture":

"Hold some thought of tranquillity, sitting erect, so that the feet easily rest upon the ground. Look steadily at some point in the ceiling, and take five slow deep breaths. Let the eyelids droop heavily and the head sink gently, the chin resting upon the chest. The back relaxes as far as possible, vertebra by vertebra. Last of all, the hip-joint relaxes, causing the head to sway forward until it reposes in the lap. In returning to the original position reverse the order of action. The hip-joint acts first, the motion creeps up the back, until the spinal column regains its double curve, which lifts itself to its normal poise, after which the eyelids languidly open, as they do in babies when a little one seems unwilling to surrender to heavy drowsiness.

"This exercise secures a threefold benefit: It develops singleness of attention; it partially stupefies the brain, and directly soothes the nerves. Affect the spinal column in any way, and the entire nervous system sympathizes. When accurately done, it

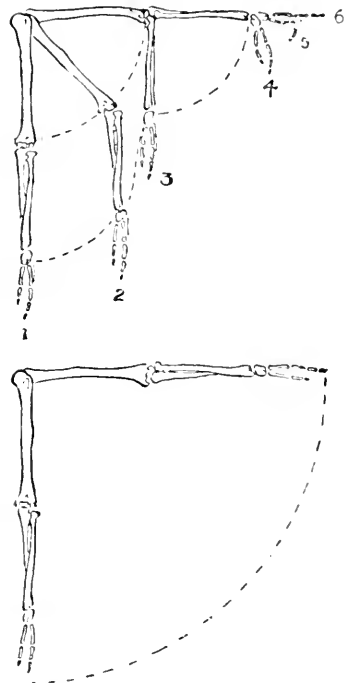

Fig. 82. The right and wrong ways of raising an arm according to the Delsartian teaching of relaxation (Cassell's "Physical Educator").

always produces a sensation of sleepiness. It is, however, difficult to get the controlled even motion that is essential to tranquillize the nerves. This usually requires considerable practice under the direct attention of a teacher. Such an exercise should occupy from three to five minutes. From three to five repetitions should produce drowsiness sufficient to make one unreservedly relax and sleep."

Anna Payson Call, who also preaches the gospel of relaxation, emphasizes self-suggestion to overcome the chronic condition of nervous tension so frequent among American women, and it is this thought that has been a real contribution to physical education.

Delsarte may be said to have been the greatest influence in directing attention to economy of muscular action in expressing thought, and his principles continually crop out in such schemes of gymnastics as that of C. W. Emerson, given in connection with his school of oratory. While he has a comparatively small number of exercises, without apparatus, he insists on their continual repetition, with the purpose of perfecting each one. The points upon which he chiefly insists are the active position of the thorax, the spine erect, and the abdomen drawn in. He speaks much of the poise and balance and graceful control of the limbs.

The benefit of such exercises is not to be questioned, particularly in slight cases of prolapse of the viscera, where the chest is collapsed and the abdomen protrudes.

THE DOCTRINE OF CONTRACTION

As if to offset this "gospel of relaxation," a number of systems have sprung up, built on the doctrine of intense simultaneous contraction of as many muscles as possible in performing a simple movement.

Sandow endeavored to found a system for complete development on this doctrine, using the spring dumb-bell (Fig. 84), an instrument of his own invention, which required continuous contraction of the grasping muscles to compress the spiral springs separating the two halves of the handle.

Macdonald Smith, in England, has his system of "full con-

tractions" for rapid development of the entire muscular system, but it is in connection with the "correspondence schools" of "physiologic exercises," whose alluring promises and attractively illustrated advertisements have decorated the magazines for the past few years, that the doctrine of contraction has had its widest publicity. In a circular sent by one the writer begins by stating that "all movable parts of the body have muscles to move them one way, and also have muscles to move them back again," so that by using one muscle or group to resist the action of its antagonist, the same development can be reached as by the use of weights. It is claimed that the alternate contractions and relaxations help

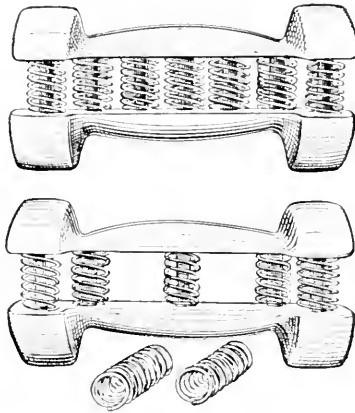

Fig. 84.—Sandow's spring dumb-bell.

the venous circulation, and instead of obstructing the circulation of the capillaries, would accelerate the blood in its course toward the heart. The use of one muscle to antagonize another is the principle upon which this and other systems are built.

A typical exercise would be the simple flexion and extension of the arm, during which the attention is concentrated on the flexors of the arm (Fig. 85). The fist is tightly clenched, and the arm is slowly flexed with intense resistance from the lengthening triceps, so that during the movement the entire arm is in a state of tension. To increase the effect the subject stands with knees everted and slightly bent, and the muscles of the thighs in vigorous contraction.

The exercises are never complicated or elaborate. They are usually simple, definite, clearly described, and illustrated. Although there is little originality in their design, there is a novelty in the manner of their statement that appeals to the uninformed and partly informed with the force of a new truth.

The advantage of such movements to a business man who is not ambitious to excel in games or sports, but who wishes to get



Fig. 85. Flexion of arms with resistance of the extensors and contraction of the thigh and leg muscles.

his necessary exercise in "tabloid" form, is evident, and it is to him that such a proposition makes its appeal. Great numbers can be treated at their homes, through written directions sent by mail, and ephemeral institutions are formed in the business sections of cities and filled with patients by a personal canvass from office to office. Twenty minutes daily of this intense work, involving the large muscle groups of the legs, trunk, and shoulders, powerfully stimulate the heart and respiration, draw the blood out

to the extremities, and cause profuse perspiration. When followed by a shower-bath and a rub-down, it produces the same good effect, both physically and psychically, that would be derived from an equal amount of other exercise. Increased strength of a certain kind is sure to follow such a course, a strength to grip or to lift, and the drudgery of it is not without its good points. These exercises will quickly develop the muscles, and they interest for a time many who would not otherwise take any form of exercise. Their utility to cultivate the qualities most useful for the habitual muscular movements of every-day life, and their ability to give all-around development, is another matter. In this respect they do not stand the test well. In such a course there are no movements requiring fine or complicated coördination, and there are none that aim at the acquirement of skill or dexterity. For a man who wishes to excel in playing a game like golf, tennis, or any other game requiring lithe, graceful, and accurate motion, these exercises are not only valueless, but detrimental. They make him muscularly self-conscious, and break up that fine adjustment of coördination so necessary for quick, strong, unerring movements. They ignore the law of muscular relaxation and economy of energy essential to the precise and graceful accomplishment of any muscular act, and they overlook the importance of the free and far extension of the extremities characteristic of such actions as throwing, thrusting, and striking, so necessary to counteract the constant posture of flexion produced by sedentary occupations. The strain put upon the circulation by this excessive contraction is also great, and may overstrain a heart organically weak or encumbered by deposits of fat.

CHAPTER VIII

AGE, SEX, AND OCCUPATION

GROWTH and development are directed by the play instinct, an automatic system of physical education. While the man-made systems that have just been described can be successfully brought into requisition at the later stages of a child's progress to maturity, they are comparatively insignificant and his neuromuscular development is principally due to spontaneous exercises of his own creation.

To be effective, physical education must travel along the same road as that naturally used by the growing boy or girl, unhampered by artificial conditions.

The first movements of the infant consist of spontaneous kicking and squirming, with aimless motions of the arms, hands, and head. As he progresses, more complicated movements are introduced—the picking up and dropping of objects, digging and piling up sand, and playing with blocks and other toys. Movements of equilibrium—creeping, learning to walk and jump—are soon followed by the boy's interest in throwing and cutting with a knife.

About the age of seven, catching and all games of ball begin to engage his attention, with individual games like tag, hide-and-seek, leap-frog, and other tests in which his awakening powers are tried, but it is not until the age of twelve that the boy begins to find his medium in the competitive games—those games demanding the sacrifice of the individual to the team.

This law is graphically shown by Dr. Luther Halsey Gulick in the accompanying chart, in which the plays of the Anglo-Saxon boy are tabulated.

His life is divided into three periods—from birth to seven, from seven to twelve, and from twelve to maturity. The spaces inclosed by the curved lines include the games that are acquired at each stage, and also those that are retained to a more advanced age. These lines must not be considered as final, since, in many

individuals, the beginning of interest in any play may be earlier or later than the time stated, and in all children they begin gradually and shade off just as gradually. As age progresses they drift from plays that center in the individual to plays in which he considers himself related to others. Growth is accompanied by

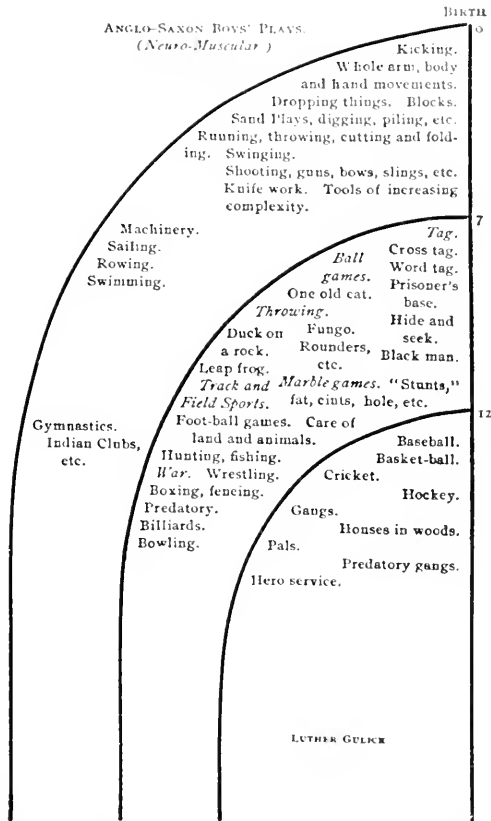

Fig. 86. —Luther Gulick's table, showing the age at which various games and sports begin, are most popular, and wane in interest among boys.

an increased complexity in the movements required, and in the third division, beginning approximately at the age of twelve, the start of what is termed the "gang" instinct is seen—boys conducting their sports in groups and teams, team work being the keynote of this group, as individual excellence was of the preceding,

It must not be forgotten, however, that the games acquired in the second period also persist, and often dominate the boy throughout his entire growth. Gulick has pointed out that savages who have reached the stage of coöperation required for fighting under a chief in organized tribes are really doing what the Anglo-Saxon boy does at the age of twelve. All the higher forms of sport involving team-work and specialization are merely a physical expression of the law of evolution that governs the business and social life of a civilized community.

In outlining a course of physical education the first consideration must always be given to this law of physical evolution. The formal gymnastics have no place among the young child's physical exercises, but his natural plays and games are developed and used educationally for his physical welfare.

Froebel recognized this fundamental law and developed it into his kindergarten.

Until the age of twelve there is but little difference in the spontaneous play of boys and girls, but with the consciousness of sex and the accelerated growth of puberty their interests rapidly diverge. Girls retain their individualism, and do not come under the domination of the "gang" instinct to the same extent as boys. Their interest turns to more feminine accomplishments, requiring grace and lightness, and much pleasure is found in dancing in all its forms and in games in which rhythmic movement is prominent.

It is not until a comparatively mature age physically that the more formal gymnastics can be introduced and their correction applied to the confinement of school, shop, or home life. The games accompanying them must also be chosen with reference to the natural desires found in normal children of that age.

During adolescence, sports and games play so large a part in physical development that a definite classification of the outstanding effects of the most familiar of them is given in the table (pp. 126, 127) for guidance in their selection.

It is impossible to give any great degree of exactness to such a table without cumbering it with wearisome explanations. In a familiar exercise like walking the change in speed from three to

five miles an hour will elevate an automatic, listless occupation into a vigorous exercise, employing many new muscle groups and stimulating the heart, lungs, and skin, while the change from a smooth level road to the broken ground of a mountain side may be dangerous for one who might walk at moderate speed on level ground.

The muscles employed are named approximately according to the intensity and the duration of their action; the notes in the column marked "demand on the nervous system" refer to the concentration required, its degree varying with the difficulty of the movement. The "influence on respiration and circulation" of an exercise is indicated by the onset of breathlessness and increase in the blood-pressure and pulse-rate during its practice.

The chief characteristics cultivated by the constant repetition necessary for success in such games come in the fourth column, and the age limits within which they should be contained are placed in the last but one. The time of life for beginning and leaving off any exercise must vary greatly with the individual, but the ages mentioned are not far out for the average man. The upper age limit in all cases is placed at sixty. If, by that time, a man has not determined what form of exercise is most suitable for his condition and constitution, he is not likely to be capable of receiving guidance from this chart.

Striking examples are continually quoted of exceptional men who have long passed the "dead" line and are still active in such sports as cricket, baseball, and boxing. If indulgence in a sport has been continued with regularity, a man's own feelings as to when it must be abandoned are better indications than any fixed rule. It is dangerous, however, for any elderly gymnast to attempt his youthful feats after a long interval of idleness and disuse. However long he may have lain fallow, he is often unwilling to accept the limitations of his years. This danger was once strikingly illustrated to me on the person of an authority on gymnastics who, in attempting a simple feat with which he had been familiar, strained the muscles of his neck so badly that he was incapacitated for several weeks.

CLASSIFICATION OF ATHLETIC GAMES AND EXERCISES.

Exercise.	Chief regions of the body used.	Demand on nerve control.	Influence on pulse, blood-pressure, and respiration.	Physical characteristics cultivated.	Best age for practice.	Remarks.
Baseball.	Right or left forearm, shoulder, and the whole muscular system to a lesser degree.	Great.	Moderate.	Accuracy, speed, and agility.	12-30.	Amount of exercise depends on the position played; pitcher has his pitching arm constantly over-worked.
Bowling.	Right forearm, arm, shoulder, and back.	Great.	Slight.	Accuracy and strength.	14-60.	
Boxing.	All of forearm, arms, shoulders, chest, back, and thighs.	Extreme.	Great.	Alertness, agility, strength.	10-40.	
Cricket.	The whole muscular system moderately; right or left forearm, arm, and shoulders.	Great.	Moderate.	Accuracy, speed, and agility.	12-60.	Depends on position played; exercise obtained by bowler is different from that of the fielder.
Cross-country running.	Thighs and legs.	Slight.	Extreme.	Endurance, speed, and strength.	18-25.	A severe test of the heart.
Dancing.	Thighs and legs.	Extreme.	Great.	Endurance and agility.	14-40.	Clug and soft shoe exercise only the legs, but many acrobatic postural and esthetic dances bring in the trunk and arms.
Football (soccer).	Thighs and legs.	Moderate.	Great.	Agility, speed, and strength.	12-35.	In this game the ball is not touched by the hands, but is kicked by the feet and butted by the head only.
Football (Rugby).	The whole muscular system.	Extreme.	Great.	Accuracy, endurance, speed, and agility.	10-30.	The most severe field game on the heart and lungs.
Golf.	The whole muscular system moderately.	Extreme.	Slight.	Accuracy.	12-60.	The walking interrupted by the strokes of the game make it peculiarly valuable for those living a sedentary indoor life.
Hammer-throwing.	Shoulders and back, also arms and thighs to a lesser degree.	Extreme.	Slight.	Accuracy and strength.	10-50.	A difficult feat of co-ordination as now practised, i. e., from a 7-foot circle.
Hand-ball.	The whole muscular system, particularly the back.	Great.	Extreme.	Accuracy, speed, and agility.	12-40.	
Hockey.	The whole muscular system, especially the back and right (or left) forearm.	Extreme.	Extreme.	Speed, agility, accuracy, and endurance.	12-25.	An extreme test on the heart and lungs.
Hurdling.	The whole muscular system, especially the abdominals, thighs, hamstrings, and calves.	Extreme.	Great.	Speed, agility, and endurance.	16-25.	The high hurdles (3 ft. 6 in.) require great accuracy.
Jumping (high).	Thighs, lower back, and shoulders.	Extreme.	Slight.	Agility and speed.	14-25.	Jumping without a run cultivates agility only.
Jumping (broad).	Thighs, calves, back, and shoulders.	Great.	Slight.	Agility and speed.	14-25.	
Lacrosse.	All the muscles of the legs and arms.	Great.	Extreme.	Speed, endurance, agility, and accuracy.	12-30.	A running game.

Exercise	Chief regions of the body used.	Demand on nerve control.	Influence on pulse, blood-pressure, and respiration.	Physical characteristics cultivated.	Best age for practice.	Remarks.
Mountain-climbing.	Thighs, legs, and back.	Slight.	Extreme.	Endurance.	16-40.	A severe test on the heart and lungs, particularly in high altitudes.
Pole vaulting.	Forearm, arms, shoulders, abdomen, thighs, and legs.	Extreme.	Slight.	Agility and strength.	14-25.	
⊗ Riding (horseback).	Back, abdomen, and thighs.	Slight.	Slight.	Balance.	14-60.	The mechanical shaking has a distinct therapeutic effect.
Polopony.	Right or left arm, back, abdomen, and legs.	Extreme.	Great.	Accuracy, balance, and strength.	16-32.	
Running, 100-200 yds.	Whole muscular system, especially the thighs and calves.	Extreme.	Great.	Speed and alertness.	12-30.	A typical exercise of effort.
Running 440-1000 yds.	The whole muscular system except the arms.	Great.	Extreme.	Speed and endurance.	17-25.	A severe test on the heart and lungs.
Distance running (1 mile and upward).	Thighs and calves.	Moderate.	Extreme.	Endurance.	17-25.	A severe test on the heart and lungs.
Koing.	Back, forearm, arm flexors, shoulder muscles, and thighs.	Slight.	Extreme.	Strength and endurance.	16-40.	Thighs are practically unused, except with the sliding seat.
Shooting (hunting).	The whole muscular system, especially the thighs, legs, and back.	Slight.	Moderate.	Endurance.	16-60.	Value depends on tramping over irregular ground and open air.
Target.	The whole muscular system, very moderately. Arm flexors and all of forearm.	Extreme.	Slight.	Accuracy.	14-60.	
Shot-putting.	Right (or left) forearm, triceps, shoulders, back, and thighs.	Great.	Slight.	Strength, speed, and agility.	16-30.	
Swimming.	The whole muscular system.	Moderate.	Great.	Endurance and strength.	12-60.	Racing and diving are extreme tests on the heart and lungs. Swimming for distance at a moderate speed is a test of endurance and stamina.
Tennis.	The whole muscular system, especially right (or left) forearm and arm.	Great.	Moderate.	Accuracy, speed, agility, and endurance.	14-40.	Tennis elbow is caused by constant repetition of back-hand stroke, producing strain of pronator radii teres muscle.
Walking.	Thighs, legs, and back.	Slight.	Moderate.	Endurance.	16-60.	Two to four miles an hour is mild exercise. Four to six miles may be exhausting, if kept up very long or if road is rough.
Water polo.	Whole muscular system.	Extreme.	Extreme.	Endurance, strength, and agility.	16-25.	An extreme test of the heart.
Wrestling.	Whole muscular system, especially neck, back, arms, shoulders, and abdomen.	Extreme.	Great.	Strength, endurance, agility, and speed.	16-40.	

From the standpoint of therapeutic effect, or even of rapid development, most athletic games are inaccurate and wasteful of time. For these purposes they do not compare with the accurate movements of formal gymnastics. During a baseball game an outfielder may spend four-eighths of his time standing with his hands on his hips, another three-eighths sitting on the bench, and the remaining one-eighth at the bat, on the bases, or in the practice of throwing the ball. For an expenditure of two hours or more he gets nothing but fresh air and a little exercise for his right arm and shoulder. In a game of foot-ball the time occupied in actual play is only four or five minutes, the rest of the time being spent in discussion, disentangling the team after a play, and in preparing for the next play, the exhaustion following a game being largely nervous.

Games and gymnastic exercises especially designed for a specific purpose can be applied to remedy defects or weakness more quickly and surely than sports whose object is recreation alone. No game growing up in a community of children could teach alertness like Dr. Sargent's "curtain ball," a game in which two courts are separated by a curtain eight feet high, each side attempting to throw a basket-ball so as to touch the floor of its opponent's court and at the same time defend its own from a similar fate.

Gymnastic apparatus was originally made to imitate the tools and appliances of the outdoor world. The horizontal bar was at first the branch of a tree, the climbing pole a mast, and the ropes its rigging. The wooden horse of the gymnasium dates from the days of chivalry, but the agile and complicated movements that give it interest and value would be impossible on its living prototype. Many of the exercises on the horse would indicate that it also represents a log on which to balance and from which to leap.

In the following table the main characteristics of the more familiar pieces of gymnastic apparatus are classified as they were in athletic games.

CLASSIFICATION OF GYMNASTIC APPARATUS, EXERCISES, AND GAMES.

Exercises.	Chief regions of the body used.	Demand on nervous control and coordination.	Influence on blood-pressure, pulse, and respiration.	Physical qualities cultivated.	Approximate age limit.	Remarks.
Basket-ball.	The whole muscular system, especially legs, thighs, and lower trunk.	Extreme.	Extreme.	Agility, accuracy, and endurance.	16-30.	An extreme test on the heart.
Bom (Swedish).	Flexors of fingers, wrist, and forearm; flexors of arm, all of shoulder, and abdomen.	Moderate.	Slight.	Strength and balance.	17-47.	
Buck.	All of forearm, arm, and shoulders; thighs, and legs.	Moderate.	Slight.	Agility, balance, accuracy, and precision.	17-47.	Thighs and legs exercised principally during approach and finish of movement.
Flying rings.	Flexors of hand, wrist, forearm, arm, shoulders, and abdominals.	Great.	Moderate.	Strength, rhythm, and balance.	16-30.	
Horizontal bar.	Flexors of fingers, wrist, forearm, arm, pectorals, latissimus dorsi, and abdominal muscles.	Extreme.	Moderate.	Strength, balance, and rhythm.	16-30.	
Horse (long).	All of forearm, arm, shoulders, abdomen, thighs, and legs.	Moderate.	Moderate.	Agility, balance, and strength.	14-30.	These exercises are vaulting and leaping, and so develop thighs and legs more than side horse.
Horse (side).	All of forearm, arm, shoulders, abdomen, thighs, and legs.	Extreme.	Slight.	Balance, accuracy, rhythm, agility, and strength.	12-40.	Thighs and legs developed in the approach and finish, but much less than arms and shoulders.
Ladders.	Flexors of fingers, wrist, forearm, arm, pectorals, and latissimus dorsi.	Slight.	Slight.	Strength.	14-63.	
Medicine ball.	All of forearm, arm, shoulders, back, abdomen, and chest.	Slight.	Slight.	Strength and accuracy.	14-50.	An excellent exercise for developing all muscles above the pelvis.
Parallel bars.	All of forearm, arm, shoulders, pectorals, abdomen, and latissimus dorsi.	Great.	Moderate.	Strength, balance, accuracy, and rhythm.	16-30.	Influence on coordination depends greatly on the intricacy of the exercises practised.
Spring-boards.	All of thighs, legs, and lower back.	Great.	Moderate.	Agility and accuracy.	12-47.	
Trapeze.	Flexors of hand, wrist, forearm, and arm; all of shoulders, the abdominals, and latissimus dorsi.	Extreme.	Moderate.	Balance, strength, and accuracy.	12-47.	One set of exercises are for equilibrium only, another are like the typical horizontal bar exercises in their effect.
Tumbling.	The whole muscular system, especially legs, back, and neck.	Extreme.	Great.	Rhythm, agility, strength, balance, and accuracy.	14-30.	One of the best all-around exercises.

Here, again, it must be borne in mind that, in addition to the circles on the horizontal bar, the swinging exercises on the flying rings, vaults on the horse, and balancing exercises on the parallel bars, the same exercise may be interchangeable from one piece to another.

For the healthy boy or girl of eighteen or thereabouts the best development would be obtained by a judicious mixture of gymnastic and athletic exercise in the open air.

A course should be designed so as to employ all the activities of the muscular system—strength, accuracy, speed, agility, and endurance—as naturally as possible.

A period of gymnastic exercise should begin with a ten-minute drill, including movements for both arms and legs, with special emphasis on correct carriage of the body and on deep breathing. This should be followed by exercises in rope climbing, on the parallel bars, horizontal bar, or flying rings, in which the arms are used; following this, exercises of agility, like vaulting over bars or the German horse, and simple ground tumbling. Each lesson should conclude with running or with a gymnastic running game of sufficient speed to test the endurance. The period should occupy one-half to three-quarters of an hour, and should be repeated at least three times a week. If alternated with walks or out-of-door games, the maximum development and general education of the physical powers should be obtained. The mental exhilaration arising from the emulation and competition that is found in a large class is an influence by no means to be neglected, especially in the young, although exercise will have its effect whether this be present or not, just as surely as iron or castor oil.

For those of mature age and a sedentary life, exercise should be directed principally to the muscles of the arms and trunk, care being taken not to overtax the circulation. Such exercises as throwing the medicine ball,—a large ball weighing from seven to twelve pounds,—hand-ball, and other ball games, combined with simple apparatus work, are usually effective and interesting. If combined with the fresh air obtained in a game like golf, tennis, or a brisk walk in the country once or twice a week, the result

would be increased efficiency in business and a general feeling of well being. For those of advancing years the necessity for exercise becomes less urgent, and the individual usually develops some plan to suit his own case.

In a lecture given at the age of eighty-three Sir Hermann Weber spoke as follows on his method of using exercise for the prolongation of life:

"I have mostly commenced," he said, "with moderately deep inspirations and expirations, continued during three to five minutes, once or twice a day, and have gradually increased the exercises to ten minutes or a quarter of an hour. The depth of each inspiration and expiration and the duration of holding the breath are likewise to be only gradually increased. At the beginning, a quarter of a minute for every inspiration or expiration ought to be sufficient. If this is well borne, each act may be gradually prolonged in duration, so that in the majority of cases each inspiration and each expiration may be brought up to a minute. All the movements are to be made slowly, not rapidly. I usually advise to inspire in an upright position, with raised arms and closed mouth; to bend down the body during the expiration, so that the fingers touch the ground or the toes. By degrees one can do several up and down movements during every inspiration, and bend and raise the body several times during the expiration. By this alternate bending and raising of the body we can gently strengthen the lumbar muscles, and, through this, successfully combat the tendency to lumbago.

"Another useful combination with the respiratory exercises is the turning of the body around the axis of the spinal column alternately, with deep inspirations, from left to right, and with expirations, from right to left, the arms being half raised. By this movement we bring into action some of the muscles of the spine which are apt to be only imperfectly used by most persons in advanced years, and the stiffness of the neck and spine, and the tendency to stooping, so common in old persons, can be to some degree corrected by this kind of movement. If commenced in good time and practised regularly and thoroughly, swinging the

arms around the shoulder-joint is likewise useful, and other combinations with muscle and joint movements will occur, but they should have accustomed themselves to these respiratory movements. The latter ought always to have our principal attention, since to them the beneficial effect on the heart and lungs is mainly due. In addition to the influence on the circulation, the respiratory movements keep up the nutrition and efficiency of the lungs, which undergo in old age a kind of atrophy. The walls of the smallest divisions and air-cells become thinner, and a kind of senile emphysema is developed, which, by this exercise, is to some degree prevented.

“Another important influence consists in maintaining the elasticity of the chest-walls, which are apt to become stiff in old age, and thus to interfere with free movements of the lungs and the pleura. If, for some reason, the erect position should be inconvenient, respiratory movements can be made also in the horizontal and sitting positions.”

In addition to these exercises, taken regularly every morning, he strongly advises a walk lasting from a half to three hours, part to be taken in the morning and part later in the day, and once a week he recommends a day of more prolonged exercise, and a holiday once or twice a year spent in a walking or climbing tour of three or four weeks.

Occupation should have equal weight with age in choosing exercise. In the natural occupations of man, like farming, fishing, and lumbering, a great deal of muscular exertion in the open air is required, and the need for it is thus naturally provided for. During the last hundred years, however, the proportion of city dwellers has risen from 2 to nearly 60 per cent., and the artificial and confining conditions of a crowded city life must be faced. The segregation of masses of people limits the amount of space and air for each, and the necessity of further economizing energy by the use of machinery reduces muscular activity to a minimum. This applies especially to the most “civilized” part of a civilized community, so that there has arisen a whole series of defects and diseases due to this suppression of the

natural muscular activity, or to its concentration on a few movements.

School-children are taken for five hours a day from their natural occupation of outdoor play and confined more or less strictly to a sitting or standing position, making their bodies fertile soil for the growth and development of postural defects. It is necessary, then, that exercise in the open air for city children of the school age should be obtained, by playgrounds, situated in the more congested districts.

The construction of roof-gardens, recreation piers, and other open-air breathing spaces is also directed by this same need, and the gymnastic exercises for school-children described in detail in a subsequent chapter are designed primarily for correcting the physical deterioration inevitably associated with confined school life.

The difference between the physical life of a factory employee who tends a machine, and of a man whose active life is spent on the farm or in a lumber camp, is at once apparent, but even among business men the effect of underexercise and overeating is familiar to the physician, whom he consults for his constipation, biliousness, and headache, while the increase in nervous disorders in both men and women of a highly civilized community shows the disastrous effects of city life on the overstimulated nervous system. Among the influences that help to produce these conditions are the ease of intercommunication by mail, telephone, and telegraph. By these means alone a man may double or treble the amount of business done before their use, but at an added nervous expenditure. The constant harrowing of the emotions by the press, with its daily tale of horror, is a morbid addition to his load.

Those who live the confined indoor life of the office or study, overtaxing the brain and slighting the muscular system, would derive benefit from any exercise sufficiently vigorous to stimulate the circulation and the skin. It is to such men that the correspondence schools described in the previous chapter are most alluring, with their promises of incredible results from the modest expenditure of a few moments daily, while the secrecy with which

they are shrouded and the high price demanded for instructions add not a little to their allurements.

The design of a short course of exercises without apparatus for the average business man of mature age and sound constitution has been undertaken by Dr. Luther Gulick, in his "Ten Minutes' Exercise for the Busy Man," and by J. P. Muller, of Klampenborg, Denmark, in his "Fifteen Minutes' Work a Day for Health's Sake," where the first eight movements terminate in a bath and are followed by ten exercises in self-massage, and the following list has been compiled and found of proved value by the author, for those to whom the more interesting and varied but time-consuming exercises and games are prohibited by circumstances. These exercises may be done in the morning on rising or late in the afternoon, before dinner, and should occupy about fifteen minutes.

They aim to stretch the thorax and expand the lungs, to give the heart some vigorous work, and to agitate and massage the abdominal organs, but one should begin gradually, take long rests, and use few movements at first.



Fig. 87.



Fig. 88.

Exercise 1.—Position: Standing; arms at sides, chin to neck, abdomen in, and chest carried well forward without contracting the shoulder muscles.

Movement: Arms forward raise, palms down, upward stretch, rise on tip-toe (Fig. 87), inhale. Sideways lower, palms back, keeping arms straight, slowly exhale and lower heels. *Repeat twenty times.*

Exercise 2.—Position: Standing, arms behind back, hands resting in small of back, fingers interlocked, with palms facing backward (Fig. 88).

Movements: Straighten arms, turning palms in, then down and then out, keeping fingers interlocked. Roll shoulders and

arms into supination; extend neck (Fig. 89). Hold this position for a moment and then reverse slowly back to starting position.

Note.—When the fingers cannot be kept in this position, start by holding a loop of cord in the hands instead of interlocking the fingers. *Repeat twenty times.*



Fig. 89.



Fig. 90.

Exercise 3.—Position: Lying on back, hands on hips.

Movements: Raise each thigh alternately with bent knee till it touches the abdomen. Clasp hands around leg, and press in on the abdomen (Fig. 90). Relax. *Repeat twenty times.*

Exercise 4.—Position: Standing, hands behind head.

Movements: Bend sideways to right, then forward, then to left (Fig. 91), and then backward, circling five times each way. Keep feet together and the knees straight. Get far down on each side. *Repeat twenty times.*



Fig. 91.

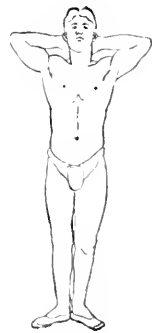

Fig. 92.

Exercise 5.—Position: Standing, hands clasped behind head (Fig. 92).

Movement: Force the head and elbows back strongly. Relax, letting the elbows come forward. *Repeat twenty times.*

Exercise 6.—Legs thirty inches apart, arms at sides.

Movement: Raise arms above head, bend forward and touch

floor with both hands (Fig. 93). Rise slowly and bring hands to position. *Repeat twenty times.*

Exercise 7.—Position: Arms forward (Fig. 94), then out and then up, stationary run.

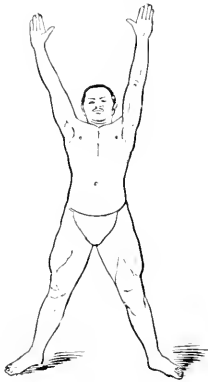

Fig. 93.

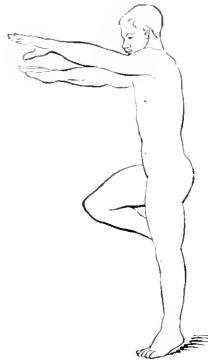

Fig. 94.—Stationary running.



Fig. 95.

Movement: At the rate of fifteen steps in five seconds. Take fifty steps for each position of the arms.

Exercise 8.—Position: Standing, hands clasped across abdomen.

Movement: Inhale, pressing in abdominal wall (Fig. 95). Exhale, relaxing abdomen. *Repeat twenty times.*

Exercise 9.—Position: Sitting on stool or on side of bed, hands clasped behind the back.

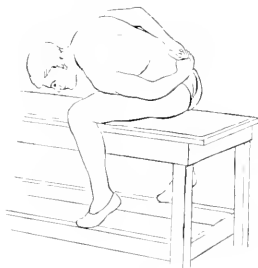

Fig. 96.

Movement: Trunk rolling, forward to right; backward and then to left (Fig. 96); then up to starting position. *Repeat twenty times.*

Exercise 10.—Position: Standing.

Movement: Arms sideways, raise, upward stretch, inhale. Forward bend (Fig. 97) and rise. Arms sideways lower. Exhale.

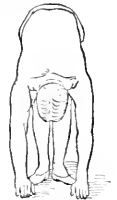

Fig. 97.

To Finish.—Wring out a Turkish towel in cold water. Take it by both ends and rub hard back, chest, abdomen, and thighs.

CHAPTER IX

PLAYGROUNDS AND MUNICIPAL GYMNASIUMS

THE segregation of city life, with its attending evils, weighs most heavily on the children of all but the very rich, and the survival of a strong and healthy race depends on providing breathing spaces and free play for them.

Most cities have grown up without having borne this in mind, and city councils are now confronted with the need for buying and equipping playgrounds in the densely populated wards, where land is most difficult to obtain.

In some cases ground is not to be bought, but, as Joseph Lee puts it, "There is just as much of the earth's surface as there was before, only it is a little higher up," and the roofs have become a ground for play.

In New York, according to the statistics of 1900, about 2700 persons lived on one city block, in about 1500 rooms, 400 of which had no windows and no outside doors. The committee on playground organization made a map of the city, showing the parks and playgrounds by green squares. Then they called in police captains from different districts, and asked them to point out the parts where restless boys gave the most trouble. In every case they put their fingers on the spot where there were no playgrounds, parks, or trees. The committee then put a red sign on each of these troublesome places. Other policemen, who said that the boys gave them no trouble, pointed to their districts, which were always close to the parks. The committee next stuck pins in the map to show where the schools were and where the children were thickest. This map was sent to the Mayor, and with it a copy of the State law, which reads: "Hereafter no school-houses shall be constructed in the city of New York without playgrounds to be used with the same."

Wherever the pins were thickest on the map, showing the most children, the red signs were thickest too, and it has since been proved that the putting of green spots into these regions will drive the red spots out.



Fig. 68.—City conditions showing need of playgrounds (Playgrounds Association of Philadelphia).

This was a graphic method of showing the influence of play on juvenile crime, so much of which is due to lack of a proper outlet for the natural impulses and instincts of the healthy child.

So long as the surroundings are normal for the best development of a child's neuromuscular system, the choice of play and its conduct may be left to the natural instincts of the child, but in a city these normal instincts are thwarted, and if exercised at all, his games of ball or tag, his hunting and fighting games, bring him into conflict with the police, and land him in the juvenile court, accused of such crimes as destruction of property, disorderly conduct, and burglary.

One of the strongest pleas for the establishment of playgrounds is made from this social side rather than from that of physical education proper. It was proved that juvenile crime decreased over 60 per cent. in each district



Fig. 99. A typical east side street in New York city.

where the right to play and a place to play was given to the children.



Fig. 100. An improvised shower-bath (Playgrounds Association of Philadelphia).

In the poor and crowded districts of the city the condition of the homes is such as to make free play impossible; the children have not even room or opportunity to run or bathe, and the city must provide them with both.

The necessity of teaching the language and the ideals of their adopted country to the hordes of foreigners who yearly immigrate to such cities as Chicago or New York make the playgrounds and

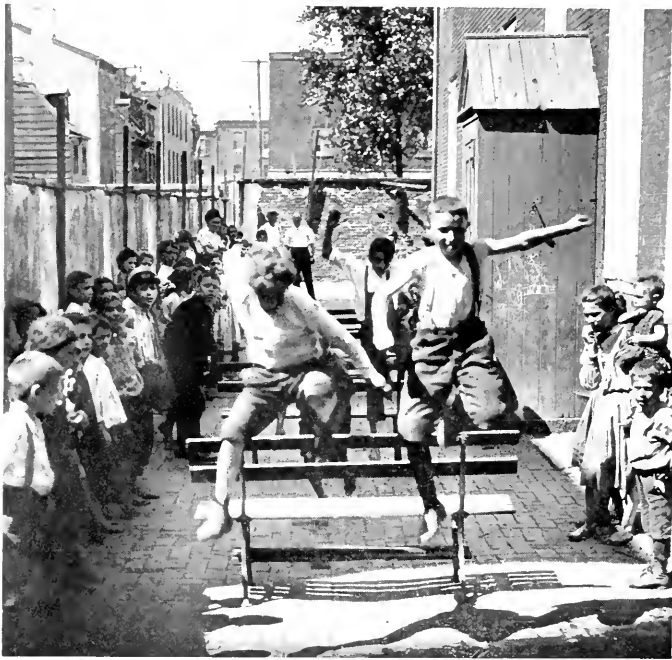

Fig. 101.—A hurdle race under difficulties.

municipal gymnasiums a most valuable means of education, and the experience of Chicago among the Bohemians, Lithuanians, and Poles has been such as thoroughly to justify the large annual expenditure.

The introduction of playgrounds in American cities has usually been the voluntary labor of private committees, coöperating with the school boards, obtaining the use of certain school yards and open spaces by donation or purchase, equipping them, and

demonstrating their usefulness to the city, and so bringing on the council the influence of the people directly benefited, and finally

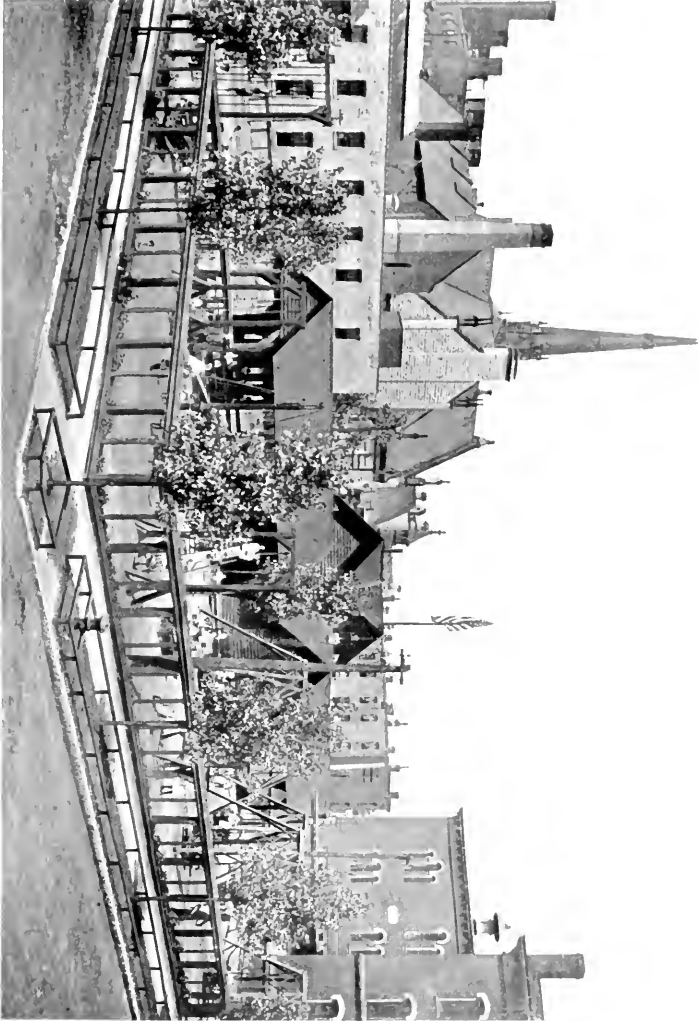

Fig. 192.—A model playground in Chicago under the special Park Commission, illustrating "Type I."

securing purchase of the ground and permanent supervision by the municipality.

Playgrounds should be of three distinct types—small, medium, and large.

Type I.—Numerous small pieces of ground are usually obtainable by utilizing vacant lots. These can be transformed into playgrounds for small children of both sexes, and should be equipped with a few small swings, see-saws, a sand pile under a canvas awning, toilet facilities, and a shelter for rainy weather. If possible, a shallow wading pool with sand or concrete bottom should be provided.

The expense of such an equipment need not exceed fifty dollars, distributed somewhat as follows:



Fig. 103.—Construction of a swing for little children in the playground.

1. Ten-foot double swing frame with triangular ends, braced, and two swings—ten to twenty-five dollars.

2. Children's six-foot swings, with canvas scups for little children to swing or sleep in, well protected from the sun—ten to thirty-five dollars. (See Fig. 103.)

3. Two or three see-saws with 14-foot boards, at five to ten dollars each.

4. Sand-box, varying in size and shape according to the space, filled by one or two loads of fine white sand—five to fourteen dollars.

5. Awning for protection against the midday sun and shelter for rainy weather—ten to sixty dollars.

There should also be connection with the water-supply of the city.

Much of the equipment is frequently obtained from interested supporters of the movement.

The back yard may be turned into a playground of this kind, as has been done in Philadelphia by Dr. Talcott Williams and others. The arrangement of apparatus would be as in Fig. 104.

Individuality will naturally be shown in the equipment of these small playgrounds, but they should be scattered about at

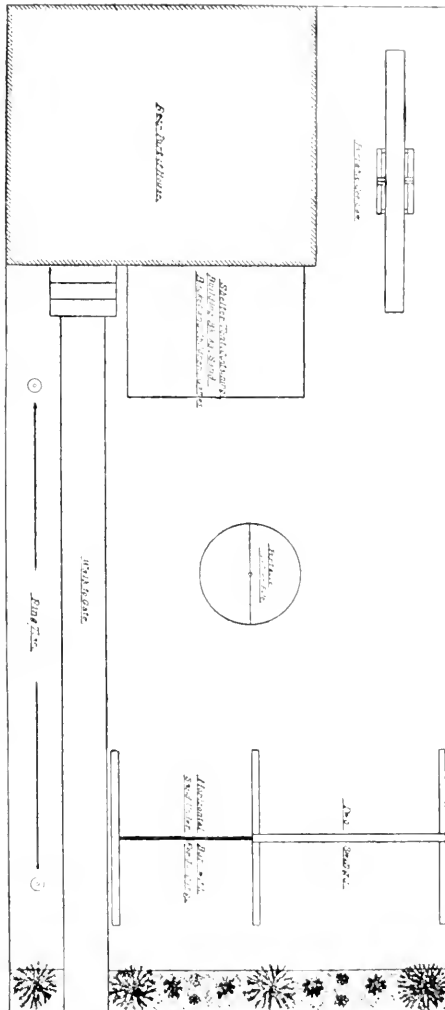

Fig. 104.—Private house playground (Elizabeth Rafter).

distances of not more than three or four blocks from the homes of the children who have to use them. Small children cannot go more than a few hundred yards to their playgrounds, and for

that reason the city parks are unavailable except on a holiday or other great occasion.

Type II.—The second type of playground should consist of a piece of ground, from two to ten acres, with a more substantial shelter, containing toilet-rooms, shower-baths, and an office for the supervisor. The ground itself should be provided with a wading pool, a sand pile, or court for young children, and a swimming pool for those who are older.

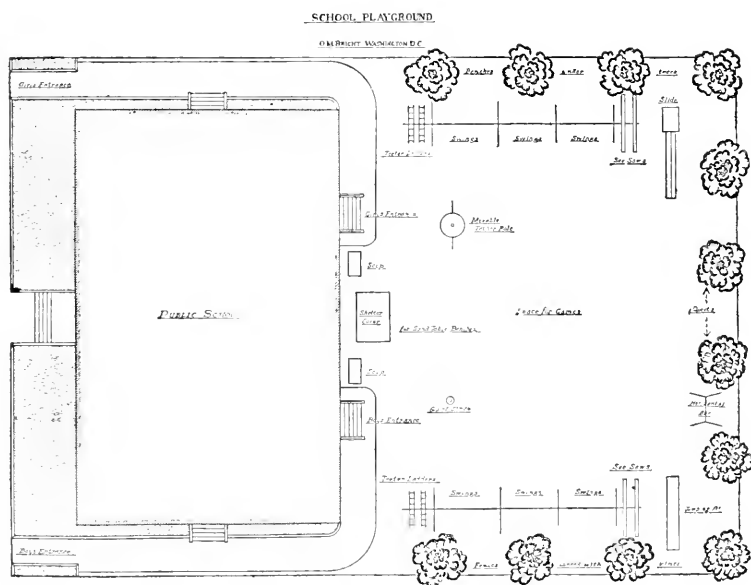

Fig. 105.—Type I of playground (Elizabeth Rafter).

The sand pile here may be extended to the dignity of a garden or court, fenced in, and provided with simple toys, buckets, shovels, and building blocks. These are frequently carried off, but this was prevented in one playground by an effective checking system. The child wanting a pail or shovel deposited his hat, which was returned when he returned the tools. The sand should be exposed to the sun and rain, and great care should be exercised to prevent the spread of communicable diseases through this medium.



Fig. 106. —A wading pool in Fairmount Park.

The center of the field should be supplied with fixed apparatus (Fig. 108). This consists of a framework of iron upon which are



Fig. 107. —Sand pile, Waterview Park, Germantown, Pa.

suspended ladders, rings, and ropes, as well as permanent sets of parallel bars and horses of varying heights, jump stands, giant strides, merry-go-rounds, circle bars, and slides. Where the ground



Fig. 108.—An up-to-date playground equipment for second type of playground.

is large enough, there should be a running track surrounding the field. These playgrounds are necessarily fewer in number than

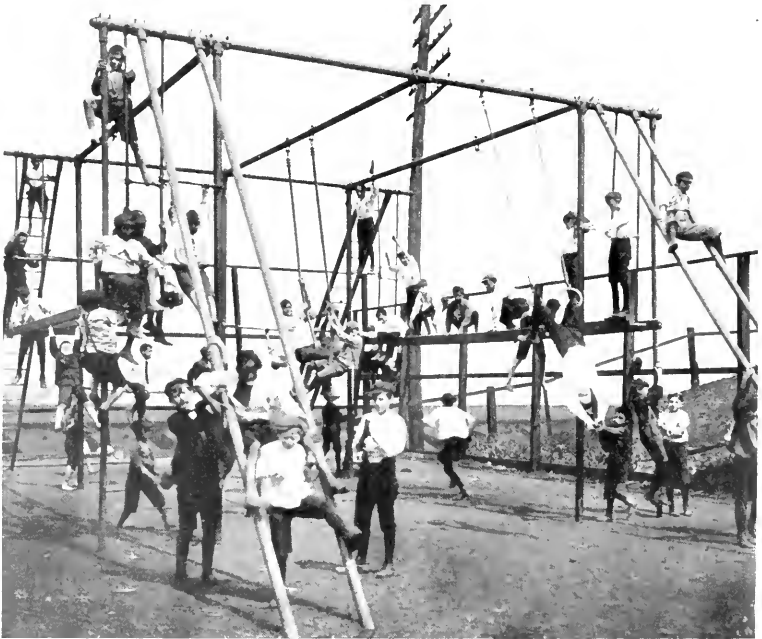

Fig. 100.—Apparatus in use (Gymnasium, Washington Park, Pittsburgh).

the first, but should not be more than half a mile apart in the crowded sections of the city. They are intended for boys and

girls from twelve to eighteen years of age, with special quarters for younger children.¹

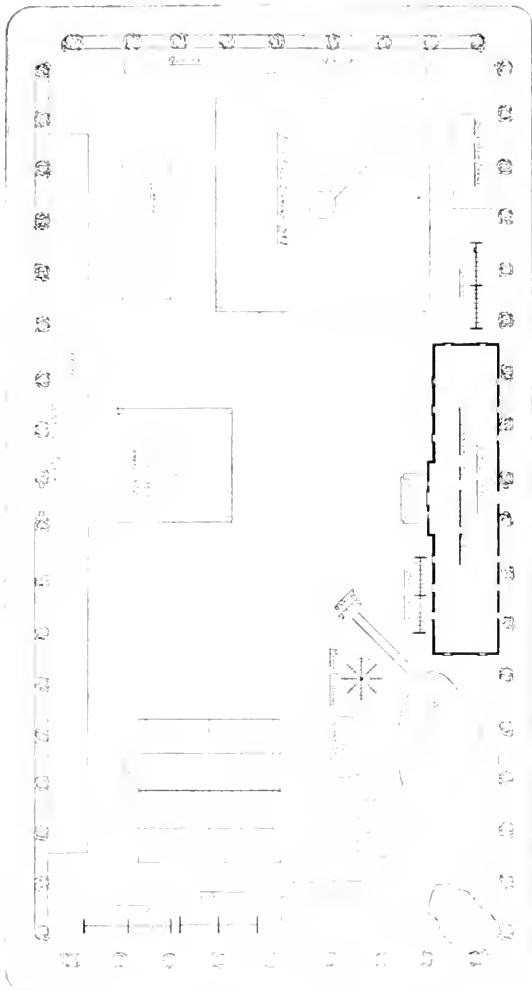

Fig. 100.—Starr Garden, Philadelphia, Type II of playground. An ideal playground except for the absence of a swimming pool (Playgrounds Association of Philadelphia).

¹The school yard may be turned into an ideal playground of this type, because the schools are placed where the children are thickest. They belong to the

Type III.—The third type of playground should be found in the outskirts of the city, usually connected with the park system. These playing fields, like Boston Common or Belmont Plateau in Philadelphia, should be of such size as to allow of two baseball

MUNICIPAL PARK PLAYGROUND

200' Feet Long by 300' Wide

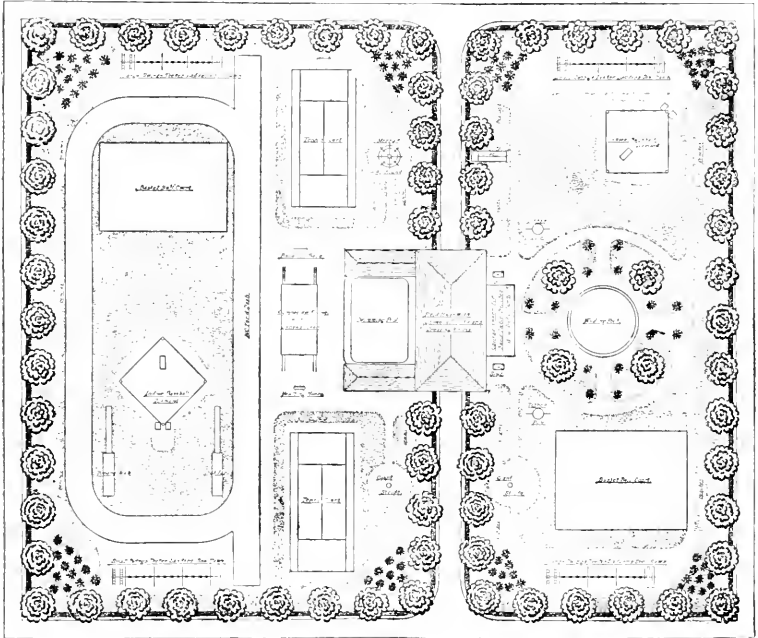

Fig. 111.—Large municipal playground plan (Elizabeth Rafter).

diamonds or foot-ball fields, a quarter-mile running track, the outdoor apparatus described in the second type, and a large gymnasium hall and dressing rooms.

municipality and have the necessary conveniences already installed, with the possibility of using the basement in rainy weather. The yards are already enclosed and the janitors can look after the apparatus when the ground is not in use by the children, thus preventing the wanton destruction of property that is so frequent. The field apparatus can also be used all year and not in the summer only, and the cost of administration is thus greatly lessened.

If the school yards are used, boards of education are encouraged to buy neighboring property to enlarge them, as has already been done in Philadelphia and elsewhere, and both municipality and school board profit from the combination.

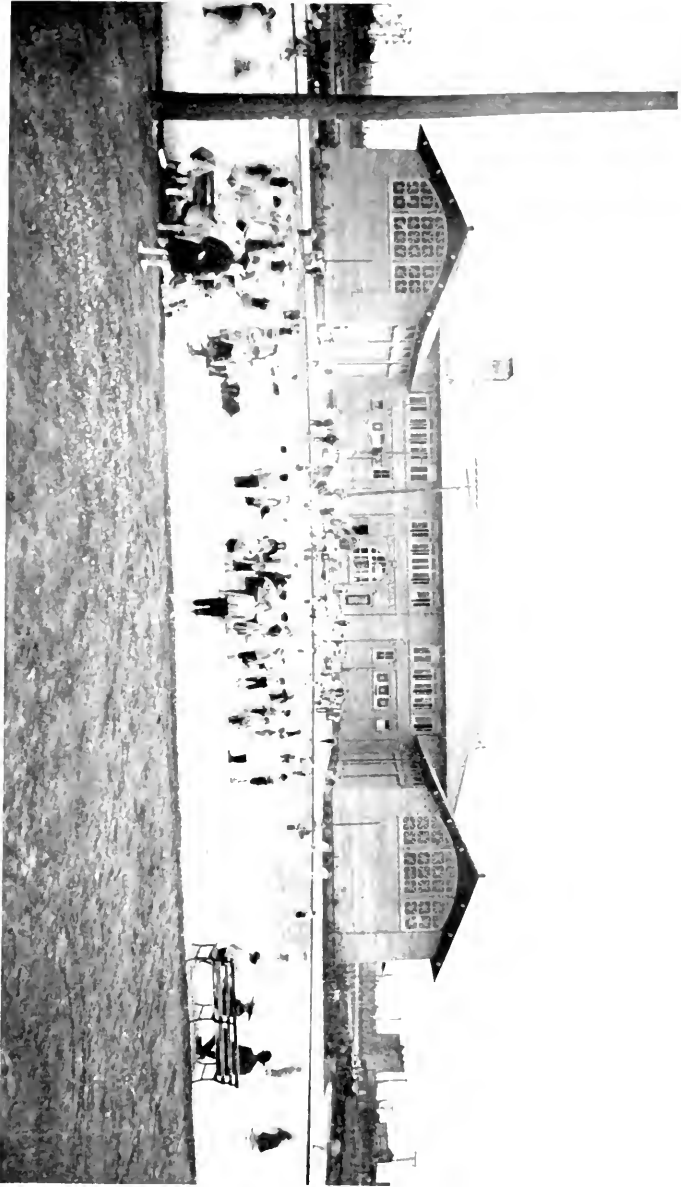

Fig. 112. Hamilton Park Recreation Center, the Playground. Chicago spent \$4,000,000 in 1905 in south side neighborhood centers. This is one of a number of neighborhood houses, costing about \$75,000 each. The wading pool for summer has, in winter, a skating pond in winter.

In the building there should be shower baths, and close by a swimming pool with deep and shallow divisions, and also a wading pool for the small children and girls. In some cities, notably in Chicago, this type of playground has been made a social center, the permanent building containing a large auditorium for lectures and various social gatherings of the people of the quarter. Every attempt is made to encourage these gatherings, as well as the specific physical training for which these playgrounds were originally designed.

Play in itself is essentially neither good nor bad, but it has great possibilities for good in the hands of a capable director, and the profession of playground supervisor is a distinct specialty in physical education, requiring unusual natural gifts and careful preparation.

The supervisor of the smaller playgrounds for young children should be familiar with kindergarten methods: she should teach them the simple kindergarten games and direct them in their play in the sand heap, having story-telling hours and other occupations most interesting to children of that age. This may well be combined with visiting the children's homes and tactfully instilling in the parent's minds the importance of cleanliness and personal hygiene.

The larger playgrounds require a man to give at regular hours a definite amount of gymnastic exercise in the form of marches, setting-up drills, and apparatus work. He should organize gymnastic and athletic games, of which there are many specially designed to be played by a large number of players in a small space. DeGroot's playground ball is popular with the boys of Chicago, and ideally suited for these conditions. He should also organize among the boys athletic contests and games extending to interplayground contests, in which loyalty to their section or even to their city is taught, and the spirit of fair play and clean sport is instilled in their youthful minds.

A period of exercise should begin with marching, light setting-up movements, and then exercises on the fixed apparatus, in which the possibilities of each piece are shown. As a rule, less emphasis

is laid on the form in which a feat is accomplished than indoors. The apparatus is considered much more casually.

This should be followed by an athletic game or contest, like the wheelbarrow race, run by two boys, one grasping the ankles

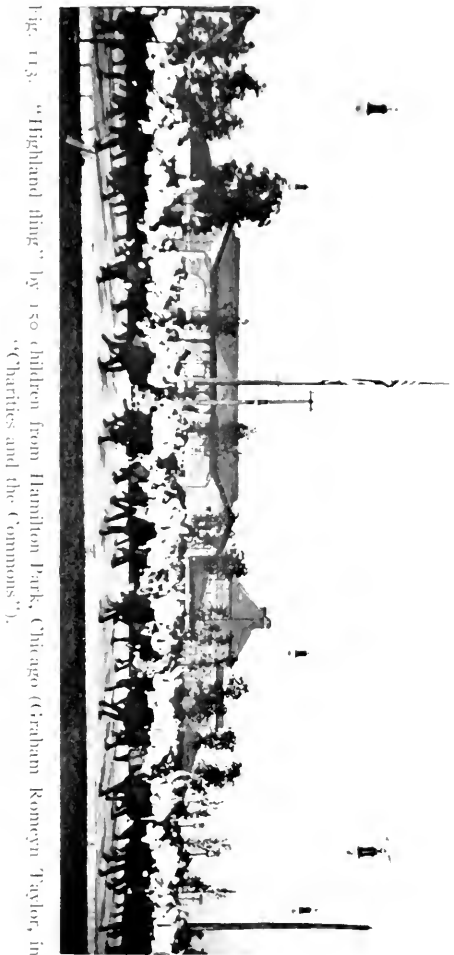

Fig. 113. "Highland fling" by 150 children from Hamilton Park, Chicago (Frederic Remond Taylor, in "Barflies and the Commons").

of his companion, who runs forward on his hands; the three legged race; obstacle races; relays; jumping and vaulting, and one of the many games with the basket-ball or medicine ball.

The wading pool can be systematically used for games of tag, leap-frog, tub-racing, and the like, the children, of course, being suitably dressed or, rather, undressed. Of these sports children never tire and the spectators are entertained not a little.

Many children learn to swim instinctively or are taught by companions, but the teaching of swimming should be part of the playground activity, and games of water polo and water basket-ball, as designed by Dr. A. E. Garland, of Boston, are much in vogue.

Certain days should be set apart for girls if they cannot have their own pool, but the playground instruction for them would differ in certain important particulars from the course most suitable for boys.

The round games are always popular with them, especially singing and marching, the salute to the flag, and, above all, dancing.

Most of the European races are rich in folk-dancing, and the exhibitions of these dances of Scotland, Sweden, Russia, Spain, and Bohemia at the playground congresses have always attracted deep interest. From such sources American folk-dancing is being evolved. The *contra dances* of America, English in origin, are widely used as quadrilles, and the Sir Roger de Coverly, or Virginia reel, with modern embellishments, is always popular. Dancing has almost entirely replaced athletic contests in the girl's branch of the Public School Athletic League of New York, with the greatest advantage.

Here, again, is shown the necessity for special training of teachers who are to take up this profession of playground supervisor.

Where playgrounds cannot be otherwise obtained, the school playgrounds are used with great advantage, both for the first and second grades, as already described, and the regular school-teachers are frequently employed as supervisors after a course of training to fit them for this specialty.

The need for playgrounds and breathing spaces in the crowded wards of the great cities jumps to the eye, but it also exists in the country village, the town, and in those parts of a city where poverty is unknown. While the usual attack on the problem is made by

the establishment of playgrounds first, and gymnasiums and baths afterward, the provision of systematic exercise for city residents has been approached in the reverse way, in at least one city, where the slum is non-existent and the community is prosperous and wealthy.

The city of Brookline, Massachusetts, began the campaign for good health and sanitation by building a municipal bath-house equipped with showers, dressing-rooms, and a large swimming



Fig. 114. The main exercise hall of the Brookline municipal gymnasium and baths.

pool. Free instruction in swimming was given to residents of the town in the large pool, and in a smaller pool constructed for the purpose of accommodating the younger children.

Closely following this bath-house a large gymnasium was built by the municipality, and put under the control of a committee of citizens who are held responsible for its management, the appropriation for its maintenance being granted by the city council.

The gymnasium building contains two exercise halls, one, 100 feet in length by 71 feet in width, with a ridge roof, lighted by

windows and skylight, making a height of forty-five feet in the center.

This hall is equipped with a complete outfit of gymnastic apparatus, and contains a running track, also used as a gallery for spectators at the exhibitions. The climbing and fixed apparatus are in sets of four, arranged so that the floor may be rapidly cleared.

A small gymnasium, 74 feet by 34 feet, having a height of 22 feet, is equipped with Swedish apparatus, and is used for the overflow from the children's classes.



Fig. 115.—The small exercise hall of the Brookline municipal gymnasium and baths.

There are special rooms on the fourth floor and in the basement for private instruction and for games and corrective apparatus.

All the regular classes in the gymnasium are free to residents of Brookline and non-residents are admitted on the payment of a fee. Preliminary medical examination, while not obligatory, is strongly recommended.

The schedule of classes in the annual report of Mr. J. Leonard Mason, the director, shows the scope and variety of a week's work:

MONDAY.	
Women's afternoon class	3:45
Men's afternoon class	5:45
Men's evening class	8:15
TUESDAY.	
Women's morning class	10:30
Girls under fourteen years, afternoon class	2:45
Girls over fourteen years, afternoon class	3:45
Men's afternoon class	5:45
Women's evening class	8:15
WEDNESDAY.	
Public school teachers' class	3:00
Boys under fourteen years, afternoon class	2:30
Boys over fourteen years, afternoon class	3:45
Young men's evening class	8:15
THURSDAY.	
Women's morning class	10:30
Women's afternoon class	3:45
Men's afternoon class	5:45
Men's evening class	8:15
FRIDAY.	
Girls under fourteen years, afternoon class	2:45
Girls over fourteen years, afternoon class	3:45
Women's evening class	8:15
SATURDAY.	
Corrective gymnastics	9:35
Children under ten years class	12:30
Boys under fourteen years class	2:30
Boys over fourteen years class	4:15
Young men's evening class	8:00

Children from six to ten are given marching, plays, and games, to music, under a woman instructor, and are trained in the simplest free exercises, using the larger muscle groups. Boys of fourteen have more complicated drills, with much exercise in tumbling, climbing, and gymnastic games, but little of the heavy work characteristic of the German gymnastics. For girls of the same age dancing steps to the music of a piano are extensively employed. Girls from fourteen to sixteen are taken as a separate class. Though they have passed the doll stage and are not interested in the childish plays, they have not yet learned to care for the rugged games used by older girls.

This age division has not been found necessary among the boys, according to Mr. Mason.

Women from twenty-five to sixty have their classes in the morning, and begin their lesson with marching, setting-up movements, and the light, graceful calisthenics requiring skill; women of this age are fond of balancing movements and of dancing, the slower rhythmic movements and relaxing exercises being used with great advantage. Violent exercises of jumping and vaulting, in which the body may be jarred, are avoided. The women's classes are very popular, and have a distinct social value, which their members heartily appreciate. The afternoon class for women is attended by many school-teachers who are mentally tired from their day's teaching. For them the exercises are rhythmic and given by imitation, all exercises requiring close attention by word of command are avoided.

The working-girls and women come in the evening, and require more strenuous work. They are fond of the apparatus and social dancing with music.

In addition to what may be called the routine work of the gymnasium, an opportunity is given for the practice of swimming, wrestling, fencing, and gymnastics, and clubs for their promotion are organized.

The senior boys take up the heavier apparatus work and indoor athletics, while the girls are instructed in athletics, modified and reduced, some little apparatus work, and dancing. The strenuous competitive games like basket-ball are not encouraged, although they are permitted.

Business and professional men, varying in age from thirty to sixty years, do not tolerate work in which close continual attention is required. Music is thus of special value to accompany the setting-up exercise with which their class begins, and simple rhythmic dancing steps to music are very popular with them. The movements of boxing and games, like indoor baseball, also appeal to them strongly, and a favorite exercise is found in the medicine ball games, which invigorate the muscles of the arm and trunk overstrained or unused by many business and working men.

In a town like Brookline, of less than 30,000 people, the average weekly attendance at the gymnasium during the first year was 1473, of which over 800 were girls and women.

An outgrowth of the movement for play has been the establishment of summer camps for city children, frequently started by private benefactors, newspapers, or charitable organizations. In them provision is made for physical training, and the days are spent in roaming the woods and hills or on the water. Large numbers of poor children are thus given the advantage of country



Fig. 116. Morning gymnastics at camp Toumsch (Dr. Orton's camp).

air and surroundings in the hot weather that is so fatal to the children of the city.

The Young Men's Christian Associations have been particularly active in providing camps for their members, where they may live under canvas for July and August, and private camps have been established by Dr. George W. Orton, Dr. George L. Meylan, and others in the mountains of Maine, New Hampshire, and elsewhere.

In 1907 more than 25,000 boys were spending their holidays in this way.

In addition to this over 5000 boys who were unable to afford the moderate expense were housed in the settlement camps.

The first girls' camp was started in 1903, and four years later there were at least thirty such camps in operation.

CHAPTER X

PHYSICAL EDUCATION IN SCHOOLS

MORE than 23 per cent. of the total population of America spends from three to five hours a day in school, and with the extension of the public-school system the responsibility of educational boards increases correspondingly toward the growing number of children under their care.

The normal life of a child during its waking hours is one of muscular activity, but if discipline is to be maintained in the school-room, the teacher must inevitably suppress a greater part of this restlessness so fundamentally related to growth.

The lessening of natural movements by school limitations during the years of growth is harmful not only because muscular exercise is decreased, but because nervous tension and strain are more than correspondingly increased. This tension should be repeatedly relaxed by periods of physical exercise designed with three objects in mind—first, to correct the physical faults and deformities fostered by the sitting posture; second, to recreate the mind and body of the child, and, third, to develop his physique along natural and normal lines.

In the building of schools the sanitary engineer should see that every school-room has 15 square feet of floor space and 300 cubic feet of air for each pupil, and a system of ventilation capable of supplying him with 30 cubic feet of pure air every minute. It is his duty to see that the light is abundant, the window area about one-fifth of the floor space, and arranged to come from behind or over the left shoulder, and not reflected directly from the paper on the desk into the eyes; that the desks are designed to fit not only the child of normal size for his grade, but also those who are abnormally large or small. C. L. Scudder, in his investi-

gation of school-seating, in Boston, found girls differing seven years in age and nearly twenty-two inches in height sitting at desks and seats of exactly the same size, and discovered gross misfitting of the desks in nearly every room he examined. In most schools there are still found seats so high that the pupil cannot touch the floor with his heels, desks of such height that the book is forced close to the eyes and myopia encouraged. Again, there are found desks so low that the round shoulders, the drooping heads, and the flat chests of their occupants are sadly noticeable.

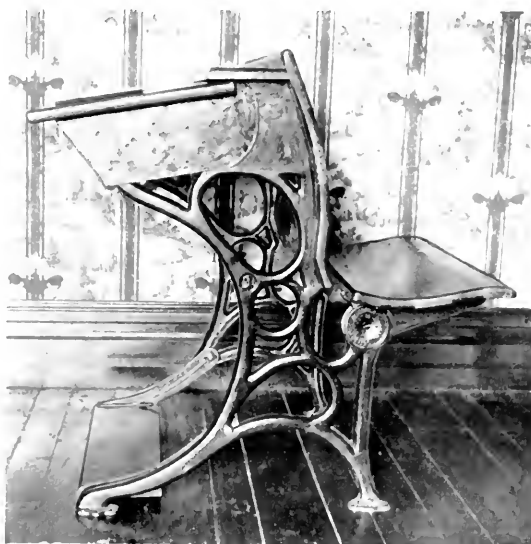

Fig. 117. The Garber desk, adjustable by the pupil.

The relation of the seat height to the desk height should be such as to permit the elbows to rest on the desk without stooping forward or unduly raising the shoulders, and the desk edge should overlap the front edge of the seat. In a carefully appointed school-room at least one row of seats and desks should be made adjustable in order to fit pupils that are not of the regular grade size. By this is avoided the unsuccessful and burdensome method of having all the school furniture made adjustable, which adds an additional weight to the teacher's already overloaded shoulders and is gen-

erally neglected. Most of the difficulty in seating pupils can be overcome by a self-adjusting desk and foot-rest like that invented by J. P. Garber, of Philadelphia, which can be changed to fit by the pupil himself with little noise or loss of time, the two great objections to adjustable furniture (Figs. 117, 118).

A perfect fitting seat and desk can guarantee only that the child shall be in the correct sitting position occasionally throughout the school day, for, however well the desks may fit, pupils rapidly slump unless study periods are repeatedly interrupted by opportunities for movement and exercise. The upper part of the body

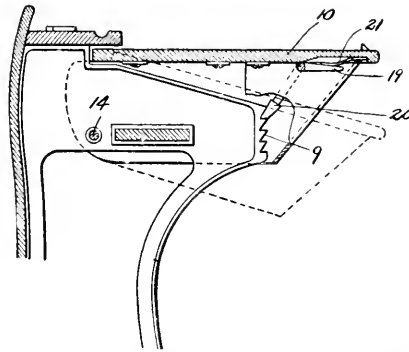

Fig. 118.—Showing mechanism for adjustment of the Garber desk: 10, Adjustable top; 14, pivot of attachment for adjustable portion of top; 16, lever pressed up by fingers to overcome the spring 21 and release the rod 22 from the serrations 20, allowing the desk to be raised or lowered at will.

leans forward upon or against the desk, constricting the chest, crowding the abdominal organs, and impeding the venous circulation. The weight is supported by the arms, and the head, neck, and spine hang by the muscles of the shoulder-blades in abnormal curves. To relieve this overstrain of the back and shoulder muscles the pupil changes to a pose resting the entire weight of the trunk on the shoulder-blades and lower end of the spine (Fig. 119). The back sags down in a single long curve, the chest contracts, the breathing is impeded, and the circulation made sluggish. This position stretches the muscles and ligaments of the spine, rounds the back and shoulders, and shoves forward the chin.

The correct sitting posture is one in which the pupil sits erect, the pelvis resting equally on the seat, with the arms beside the hips and the head poised so as to bring the center of gravity within a line joining the seat bones. This posture is economic in muscular energy, and most conducive to correct carriage, but the demands of school life do not permit the pupil to keep it long. Reading, writing, and drawing are exercises that require deviations from the ideal, and if we add to these requirements ill-fitting desks and long periods of sitting in which bad posture becomes habitual, the mischievous result cannot long be in doubt.



Fig. 110.—Faulty posture (Shaw).

The work of the school-day should be arranged with these things in mind.

The first year of the child's school-life should not have more than one-third of the time in confinement at the desk (Shaw). Short periods of sitting, followed by double that time spent in muscular activity out of the seat, should be the rule. This activity may in most cases consist of movements correlated with intellectual exercise. In the kindergarten the exercise is admirably combined with mental culture by the teaching of imitative games in which the large muscle groups are exercised in hopping, jumping, and run-

ning, and in imitating with the arms the flight of birds and insects. The circulation is stimulated, and postural faults are prevented, while at the same time the child is taught valuable lessons in natural history, in which his interest never flags. The names of these games are suggestive of the action: "The windmill's fans around they go" (Blow). "Mow, mow the oats" (Hofer).



Fig. 120.—A kindergarten game in the school yard.

"Little ball pass along" (Jenks and Walker). They may be divided into:

1. Games of pursuit—"Chasing the squirrel."
2. Imitation games—"Shall we show you how the farmer?" (Blow).
3. Rhythmic and dancing games—"Tick tock" (Hubbard).
4. Marching games—"Left, left, listen to the music" (Gaynor).
5. Ball games—"In my hand a ball I hold" (Jenks and Walker).

They are always accompanied by music, and most of them can be carried on to the primary schools.

In the succeeding years of the elementary school the proportion of time spent at the desk may be gradually lengthened, but short periods of respite from sitting should be frequent and devoted to brisk physical exercise. In the last year of the elementary school course there should be four stated periods of three minutes each during the morning and three during the afternoon session, devoted to exercise, corrective in character, and designed to bring



Fig. 121. A recess game at the Thompson Street School, Philadelphia.

into use muscles inactive or overstrained at the desk. In addition to this there should be a recess in both morning and afternoon session of not less than fifteen minutes, so that the school room may be thoroughly aired. All the pupils, if the weather and climate permit, should go out of doors and engage in spontaneous play, where they can run, shout, and give vent to their pent up animal spirits, quicken their circulation, and relieve the nervous tension caused by keeping still, and so rest and invigorate all their nervous and muscular system. In many cases, however, particularly in America, children seem to have lost the knowledge of

games and play and have to be taught them. This is attributed by Gulick to the lack of play traditions found in the mixed and constantly shifting population of American cities, where two generations of children seldom grow up in the same place to pass down their customs and play rules to their successors.

Special games have been designed and collected by E. H. Arnold, of the Boston Normal School, and others, adapted from old and popular children's plays for the use of the many children who have to occupy the confined space of the playground. These

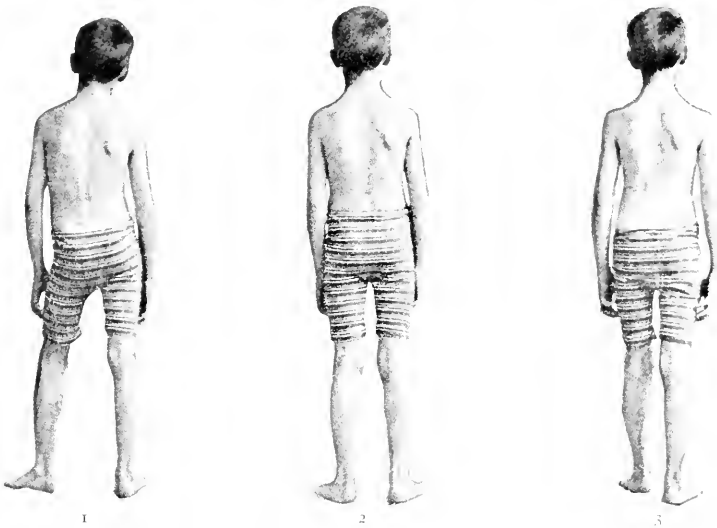

Fig. 122.—Mosher's postures in standing.

games should be taught and practised during the recess period, although it is not so much the number of games that is necessary, but the time and space to play a few good ones.

The school-day of children in the higher grades should have two five-minute periods of exercise in addition to the purely corrective work of the three-minute periods, and the games of the recess above described. These exercises should be designed to promote quick, strong muscular control; to expand and enlarge the chest for deep breathing; to bring the blood out into the extremities; and to teach the proper carriage of the body. In

teaching the correct standing posture, the teacher should be on the watch for the most frequent of all defects, that position where the weight is habitually borne on the right leg, the left being inactive and placed out to the side (Fig. 122, 1).

It is not possible for a child to remain long at rest with the weight equally on both feet (Fig. 122, 2), and since the tension on both legs is the same, the child rapidly tires. The best position to teach is that recommended by Dr. Mosher (Fig. 122, 3), in which one foot is placed slightly in advance of the other, changing the feet as the weight-bearing leg tires.

The school-room has been the battle-ground on which the Germans and Swedes have fought the most vigorous campaign in favor of their respective systems. Both have a place in the day's work. The more purely corrective exercises, done to word of command and designed to prevent or remedy flat chest, round shoulders, and faulty standing positions, are founded more or less upon the Swedish system, while rhythmic exercises, done to music and the teaching of movements by imitation, are more characteristic of the Germans. Excellent systems of graded work in the school-room, in which both these ideas are used, have been arranged for the public schools of New York, Philadelphia, and Cleveland. In Cleveland the day's order of the Swedish system is closely followed for the corrective exercises. A lesson begins with—

1. Order movements, to enlist the attention: right and left face, etc.
2. Movements to expand the chest: backward bendings or arch flexions.
3. Breathing exercises.
4. Balance movements for coördination, like toe-standing and walking.
5. Back, including shoulder-blade, movements for the spine and general carriage of the body.
6. Abdominal movements for the abdominal muscles.
7. Bending and twisting movements for the lateral muscles of trunk and spine.

8. Breathing movements.

9. Jumping movements, like the fall-outs, and springing movements, the most violent of the series, and repeated to the point of breathlessness.



Fig. 123. —Method of using the school furniture to replace gymnastic apparatus in Philadelphia schools. The "dip" between the seats.

10. Slow, deep respiratory movements, to calm the respiration and circulation and prepare for rest.

Practically no apparatus is used, except the school seats and desks, and the alternate rows of pupils, who act as living supports in duplicate movements (Figs. 123 and 124).



Fig. 124. —"Follow your leader" through the seats and aisles of the school-room. The alternate files in the picture should be reversed, and the game continues till the players are back to their own desk.

In the Philadelphia schools recreation drills are used in addition to the more corrective work, and sometimes the children are allowed to run freely in the school yard for one minute, or to take jumping and vaulting exercises, with the desks as apparatus.

Rhythmical exercises to music or gymnastic games are also employed, but all gymnastic work in the school room should always be short, light, and corrective in character, and must stop short of perspiration.

Every school should be provided with a gymnasium large enough to allow vigorous work for an entire class, or for several classes together. Here the dressing-rooms and lockers for each sex permit a complete change of clothing, with the liberal use of the shower-bath and swimming pool. The school gymnasium should be in a separate building, if possible, but when this is not feasible, the upper floor should be used in preference to the basement, because of the impurity of the ground air. The ventilation should be abundant, with forced draft, and the ceiling should be at least twenty feet high. A gallery containing a running track should surround the room, and vaulting bars, ladders, and suspended parallels may be attached beneath to it. The vaulting horses, jumping standards, parallel and horizontal bars should be in groups of from four to six, to facilitate the handling of large classes, and these should be set in the floor sockets, easily removable, so that the floor may be cleared for mass drills, marching exercises, and games. Around the walls, chest weights and other developing appliances should be set, with the bom and stall bars and the dumb-bells, clubs, bar-bells, and wands. There should be an abundant supply of mats. A schedule of hours should be made for the use of the room by boys' and girls' classes. The equipment must vary widely with the conditions, and a reliable firm of gymnasium outfitters should always be consulted for the design and instalment of the apparatus.

If there is a gymnasium, there need be little or no equipment in the playground, which must provide 30 square feet of space for each pupil (Burnham), or a plot 300 feet by 100 feet for a school of 1000 pupils; but if not, the apparatus should be like that of a playground of the first or second class, already described.

For outdoor exercise the need of playgrounds about the school buildings becomes more and more urgent; and in Philadelphia and New York the roof itself is used, caged in by wire netting. These

roof playgrounds give the only opportunity a child may have for engaging in outdoor athletics, and in New York city, where the population is so dense, it has made possible the formation of the public School Athletic League, which is now over half a million strong.

The Public School Athletic League of the city of New York was founded in 1903 by Dr. Luther Halsey Gulick, then Superintendent of Physical Education. He brought to the attention of the Board of Education the deplorable physical condition of the children attending the public schools, most of them living in many-storied tenements, each with a population as great as a



Fig. 125. A roof playground in a crowded section of New York (Playgrounds Association of New York).

small village, with no playgrounds but the crowded streets and congested sidewalks. It was estimated that in the tenement district of the east side, Manhattan, there was a child for each running twenty-four inches of the street, which was emphasized as just the space required for a grave. The committee of the board approved the scheme, and incorporated the league. The organization was perfected by the election, as officers, of men influential in the political and financial world, and by securing the cooperation of teachers and principals.

The first athletic meeting was held at Madison Square Garden before much opportunity had been given for work among the boys,

and brought out 1500 entries. Since then the league has given over 600 athletic meetings in one year, at many of which over 1000 competitors took part; and now a single school may hold a meeting with 700 competitors, the games covering all kinds of athletic competition. Running and relay racing constitute a majority of the events, not only because of their value as exercise, but because they enable a large number of boys to be handled rapidly.



Fig. 126. Argument in favor of weight classes—the small boy is the older by three months (Handbook Public School Athletic League, N. Y.).

Boys were classified by weight instead of age, the scales being set at the weight limit, and the boy who raises the bar on the scales is ineligible. This is quick and conclusive, and prevents all possibility of discussion. There are also contests in high jumping, pole-vaulting, putting the shot, basket-ball, soccer foot-ball, cross-country running, swimming in the public baths, ice and roller skating, and shooting. Baseball is perhaps the most popular, and in 1907 there were 106 baseball teams competing against each

other in the league. Valuable trophies and medals have been secured for competition, and many other devices are used for extending the exercise to as many boys as possible.

Prize buttons were given to all boys who achieved a certain standard of merit. To win the button he must chin the bar, run a certain distance, and jump a certain height, according to his age or weight. The standards have been set as follows: For elementary school boys under thirteen years, 60-yard dash, $8\frac{3}{4}$ seconds; chinning the bar, 4 times; standing broad jump, 5 feet 9 inches. For all other elementary school boys: 60-yard dash indoors, 8 seconds; 100-yard dash outdoors, 14 seconds; chinning the bar, 6 times; standing broad jump, 6 feet 6 inches. For high school boys: 220-yard run, 28 seconds; chinning the bar, 9 times; running high jump, 4 feet 4 inches. This has been extended to class competition, where all boys in the class compete to make an average.

The league aids in the maintenance of discipline by requiring a certificate from the principal stating that the boy had reached the passing mark in his studies and deportment, before allowing him to compete either for a button or other prize.

In the first contest for the button only three or four out of a school of 500 could pass the test, but with practice 1162 boys qualified in 1904, and two years later this number had more than doubled.

Teachers have been astonished, as well as pleased, with the improvement in discipline among these young and ambitious athletes, and this alone has insured their active coöperation, as well as the enthusiastic support of the boys.

Systematic instruction in military rifle shooting has been made possible by the invention of the subtarget machine. It consists of a standard, with an ordinary Krag military rifle attached to a mechanism on top. This is so adjusted that when aim is taken with the rifle at a target across the room and the trigger pulled, the machine registers upon a miniature target the exact relative place that would have been hit if the gun were loaded. As there is no danger connected with it, the practice is rapid and economical, the mechanism being easily set up in any school-room. The

instructor standing at the boy's side is able to follow the manner in which he is aiming and to correct his defects. Instruction in the holding and sighting of the rifle is given, and annual interschool contests are held, ending in a final contest among the winning schools at Creedmoor, with the actual rifle, at distances of from 100 to 400 yards. The boys thus have an



Fig. 127.—Subtarget gun machine for rifle practice in high schools (Handbook of Public School Athletic League, N. Y.).

opportunity for acquiring the knowledge of wind, atmosphere, and light, necessary for good shooting in the field. This has been made part of the program for the School Athletic League, and has been a source of keen interest to the boys, many of whom have acquired great skill. Upon attaining a certain degree of efficiency each competitor is given a badge. The national importance of having an army of boys graduated every year, each one knowing

the feel of a rifle in his hand, and having a knowledge of its use,—a knowledge that never leaves him,—need not be dwelt upon here.

The Athletic League has extended its work by the formation of the girl's branch. Voluntary classes in gymnastics, games, and dancing have been introduced among the girls attending the public schools, from which teachers are by no means excluded, many of them attending and in turn leading classes of their own. Exercises most popular and generally practised by the girls are the peasant dances of Sweden, Scotland, Ireland, and Spain, involving much gymnastic work and developing strength, agility, and grace.



Fig. 128.—Relay race, Girls' Branch Public Schools Athletic League.

Games adapted for indoor and outdoor spaces are practised, and relay races between classes and schools have become a favorite feature.

Owing to the difficulty in finding a spacious ground for their athletic competitions, the Public School Athletic League has been the means of drawing attention to the need of good playgrounds in New York city. Largely through the influence of its officers, \$400,000 were appropriated by the city for the purchasing and equipping of four athletic fields. Because of the enormous cost of land, it was impossible to procure sites on Manhattan Island, so that one was built in Astoria, one at Crotona Park, another at Stapleton,

Staten Island, and the fourth in south Brooklyn. These fields are equipped with running tracks, grand-stands, and dressing rooms; but if adequate provision had been made as the city was built, it would not have been necessary to go so far afield.

Leagues similar in object and character have since then been formed in Newark, Chicago, and Cleveland. In Newark, where the work is particularly active, a medical examination of all contestants is required, about 80 boys being found physically unfit out of 2000 competitors.



Fig. 120.—Field day for school children, Franklin Field, Philadelphia, June 27, 1908 (Playgrounds Association of Philadelphia).

The Playgrounds Association of Philadelphia has an athletic committee to organize the athletic interests of the schools, both public and parochial, and the first field day was held in June, 1908, with 5000 children of both sexes taking part. It differs from the leagues of New York, Newark, and Cleveland by laying more stress on interschool competition in drills and games, where as many as 400 pupils from one school took part in a drill in competition with groups of 50 to 100 from smaller institutions. In addition to this there were group contests, relay races, and individual events.

CHAPTER XI

PHYSICAL EDUCATION IN THE COLLEGE AND UNIVERSITY

THE university is the culmination of the educational system, but there is a distinct break between it and the school. Most school children go into the business or trade they are to practice for the rest of their lives when they leave school, and many men enter college who have had but a meagre experience of school life, and the struggle for a college education is so intense that the exhausting work of preparation is frequently stamped on the physique of the matriculant.

The long hours of school-work, the nervous exhaustion of teaching, the nights spent in study, and the days in office, factory, or shop—all leave their imprint so deeply that the knowledge of, and even the desire for, a larger and fuller physical life may be stamped out or atrophied in the very youths whose success in after-life depends on the conservation and development of their physical powers.

Physical education for college students must then include personal hygiene and the correction of remediable defects, the education of their physical powers to the highest point of efficiency, and the cultivation of those social qualities that can be taught through the agency of athletic activity better than by any other means.

The necessity for physical training to go hand in hand with the other courses of the college curriculum has always been recognized by advanced thinkers in the realm of college education.

Benjamin Franklin, in writing his pamphlet, in 1749, that led to the founding of an academy for the education of the youth, now the University of Pennsylvania, expressly states that "To keep them in health and to strengthen and render active their bodies, they be frequently exercised in running, leaping, wrestling, and swimming"; and nearly forty years later Thomas Jefferson wrote

to Peter Carr concerning his studies: "Give about two hours of every day to exercise, for health must not be sacrificed to learning."

In drafting the plans for the University of Virginia he did not forget the place of exercise, but advocated military drill and maneuvers as the best for the conditions then existing.

The wave of interest in German gymnastics reached America about 1825, as already described in a previous chapter, and resulted in the establishment of gymnastics as part of the regular instruction at the Round Hill School, Northampton, Mass., and at Harvard College, the catalogues of 1827-28 containing the name of Dr. Charles Follen, "Superintendent of the Gymnasium," and instructor in German. These exercises were also introduced into Brown, Williams, and Yale, as well as many secondary schools.

The German pioneers soon found that their status in America was not considered equal to the teachers of more purely intellectual subjects, and soon tired of teaching boys to turn somersaults, when the rewards for more intellectual work were so much greater and more congenial.

In 1860 the first chair of Physical Education and Hygiene in an American college was established at Amherst. Its occupant, Dr. Hooker, was soon succeeded by Dr. Edward Hitchcock, who still retains the professorship, and whose measurements and vital statistics are the longest continuous series of observations on college men. His conclusions, as embodied in charts and reports, show a consistent improvement in the student's health from the freshman to the senior year under his system of exercise, as well as an increase in muscular development.

In 1879 Dr. Dudley A. Sargent was given the direction of the new Hemenway Gymnasium at Harvard, and he at once began the patient accumulation of vital statistics, now reduced to chart form and available for comparison.

Over thirty colleges and universities have established more or less complete departments of physical education, in which a definite amount of exercise is required of from one to four classes.

The division of physical culture and athletics was founded in Chicago in 1892, and in 1904 the Bartlett Gymnasium was

opened. This was a radical departure for a large university because there was a definite undergraduate requirement, and provision was made for adequate supervision and control, financial and otherwise, of university athletics. This made possible the ideal relationship between physical training proper and competitive athletics, each having its place in the complete system of physical education.

The Department of Physical Education as reorganized in 1904 at the University of Pennsylvania requires from the four undergraduate years, and from the primary years in the professional schools, except those holding a bachelor's degree, a minimum of two periods of exercise a week, and lectures on the application of exercise to disease are given in the medical course.

A wide option is allowed, and equivalent credit is given for attendance at the gymnastic classes or during active membership on the foot-ball squad, crew, baseball, track, or swimming teams, and in the fencing, wrestling, or boxing clubs.

In the College of the City of New York the requirement is much more exacting, and in nineteen of the leading universities this department is now on an equal basis with the others, the theory of hygiene and physical training forming one of the college courses in many of them.

A university course in physical education should begin with a careful examination, to find the exact physical condition of the student and so to give an intelligent foundation on which to base advice and instruction. He should be measured and his strength tested, to see how he compares with his fellows in proportions and power. His posture and development should be noted, and his heart and lungs examined for any latent weakness or disease. The acuteness of his sight and hearing should be carefully calculated, for he must know if there be any serious obstruction of the two most important avenues by which his knowledge is to come to him. And, finally, his ability to accomplish certain muscular feats that cover the main activities of the body should be ascertained.

An analysis of the examination cards of 1000 freshmen showed that over 30 per cent. had lived a sedentary and confined life.

while more than 60 per cent. showed some marked physical defect; the broken down arch of the foot; the flat chest and

UNIVERSITY OF PENNSYLVANIA
DEPARTMENT OF PHYSICAL EDUCATION

HISTORY BLANK to be filled by the student and brought by him to Dr. McKenzie's office in the Gymnasium. The information contained in these answers will be considered strictly confidential. ANSWER EVERY QUESTION.

Date October 26 1918
Name in full Dr. C. D. H.
Age 20 Sex Male Ethnic Irish & American first
If present age 43 If present age and sex of father 39 Consumption
If present age Deceased If present age and sex of mother 33
Is your family of father or mother family in general healthy? father's
Have your father, mother, sisters or brothers, brothers or girls been afflicted by any of the following diseases?
Consumption? Yes Rheumatism? No Disease of kidneys? No
Heart disease? No Cancer? No Disease of digestive or urinary system? No
Name the forms of manual work or regular exercise or sports to which you have been accustomed? Out door
golf
Have you ever had any of the following conditions?
In what form, if any, do you use tobacco? No
What is your daily average? 0 At what age did you begin? 0
Do you use alcohol in any form? No To what extent do you? 0

(PRINT)

What illness have you had in bed for two weeks or more? Pneumonia 12 yrs ago
Have you any remaining effect from a previous illness, accident or operation? No
Are your appetite and digest good? Yes Are you troubled with indigestion? No
Are you troubled with constipation? No Diarrhea? No
Have you ever had any disorder of the kidneys, bladder or prostatic system? No
Are you subject to dizziness in the head? No Tinnitus? No Deafness? No
Have you any obstruction in either nostril? No
Do you ever feel lightheaded from your hands or feet? Yes
Have you ever fainted? Yes State your dates March 22nd 1918
Do you suffer from sleeplessness? No How long? 2 hrs
Do you wear glasses? Yes Have you ever had any eye disease? Yes
Have you ever had purulent or ichthyoid discharge from the ears or any trouble with your teeth?
Write here any form hearing, vision or past or present teeth that may not have been included in the preceding questions.

Fig. 147. History blank filled by the student.

protruding abdomen of the anemic school-boy, with his round shoulders, protruding chin, and flabby muscles, or the drooping shoulder and the curved spine, or the dull hearing and faulty

sight that had been the unsuspected cause of headaches, nervous irritability, and exhaustion.

It is the province of the department of physical education to bring this defective physique up to its normal level.

No. 4553

UNIVERSITY OF PENNSYLVANIA
DEPARTMENT OF PHYSICAL EDUCATION

MEDICAL EXAMINATION

Date 10.1.08

General Posture good Shoulders sq. right Spine straight

Chest flat Abdomen round

LEGS—R. OK L. OK Feet—R. OK L. OK

Conditions of Skin some Fat none

Veins OK Muscles firm

Muscular Development of Neck good Back good

Abdomen good Chest good Arms good

Forearms good Thighs good Calves good

Heart OK

Pulse Rate, Reclining 72 Standing 84

Blood Pressure, Systolic 90 Diastolic 135

Lungs OK

Urine (when required) Sp Gr Reaction Albumen Sugar

External Condition of Ears OK Hearing: R. 8 L. 8

Remarks:
Resumed March 24, 1899. Complains of
constant irritation in throat and
coughing after running. In his
track work heart OK

Fig. 131.—Form for medical examination.

The main work of the director must, however, be devoted to the average man, coming from the farm, the office, the factory, the shop, or the school, with no athletic ambitions, but wanting to make every moment of his time count. The college must provide him with enough exercise of the right sort to put and keep him at the highest level of physical efficiency to get the

most good from his lectures and laboratory work, without involving too great an inroad upon his limited time.

No. 4550		MEASUREMENTS AND TESTS		Name
Date	10/08	Date		A. M. H.
Age	17	North-Forearm, L.	272	
Weight	619	Upper Arm, L. Bicep	275	
Height	1703	Thigh, R.	374	
Body Length, episternal	130	Calf, L.	353	
Breadth of Shoulder, to olecranon	415	Thigh, L.	373	
Breadth of Chest, normal	280	Calf, R.	350	
" " Waist	267	Lung Capacity	350	
" " Hip	317	Strength of Legs	224	
Breadth of Chest, normal	133	" " Back	165	
" " Abd. men, normal	140	" " Arm Flexion	135	
North-Neck	540	" " Extremities	150	
" Chest, normal, white nipple line	415	Chest, R.	43	
" Lower Chest, expanded	413	Chest, L.	44	
" " " expanded	471	Trunk Strength	677	
Waist	750	Index: Weight-Height = $\frac{W}{H^2}$		
Hip	900	" " " " = $\frac{W}{H^3}$		
Forearm, R.	212	" " Strength: Weight = $\frac{W}{W}$		
Upper Arm, R. Bicep	294			

Fig. 132.—Measurement form.

The athletes must also be provided for in the scheme, although they number less than 10 per cent. of the total enrolment

Date	Nov 16. 1908	Class	'12	Dept.	Art.
Name	G. C. F.				
Examination of Eyes:	R.		L.		
External Condition	Conjunct. sl. injected		no.		
Muscular Balance	kw hyperopia		Esophoria 1/2°		
Vision	6/22		6/22		
Accommodation	(7 0.50) 10-140 cm		(7 0.50) 10-30 cm		
Ophthalmoscope	Myopia -1.0		Myopia act 1.0		
Remarks:	locating -S. 2.5 D from optician past 2 years. headache & blurring of vision after work				

Fig. 133.—Form of eye examination, U. of P.

of the college, for the severity of competition in intercollegiate athletics and the high standard of merit required for success separates them almost into a special class.

The average weight of a foot-ball player on a college team is about 174 pounds—35 pounds more than the average man. The oarsman weighs about 164 pounds, or 25 pounds more than the ordinary student, whose height he also exceeds by about three inches. The light, routine exercise sufficient for the average student is not enough for them, and yet, while facilities should be given them for practising their chosen sport, the necessity of advice and direction, and in some cases restriction, has time and again been tragically shown.



Fig. 134.—Exercise to develop the abdominal muscles on the Swedish stall bars, U. of P. gymnasium.

All three classes of men, the defective, the normal, and the athletic, should be included in the plan of a complete department of physical training.

For specific defects, prescribed exercises are required.

Recently, a young man came to college, having been rejected at West Point because of flat-foot and lateral curvature. A six months' course of prescribed exercise, lasting about half an hour daily, and carried out faithfully, enabled him to pass the required physical examination easily. Another freshman entering on the study of architecture complained that he could not study on account of frequent headaches, especially after reading and drafting. His eye examination showed less than half the normal acuity, unsuspected and, of course, uncorrected by glasses.

Hundreds of such cases come under the medical examiner's eye each year, and proper advice at the beginning of his course will prevent the appalling waste of time and energy inevitable for the man who struggles along with these handicaps uncorrected. Constant personal counsel about exercise and other questions of hygiene go far to add to the comfort and efficiency of these students.

A course of exercise of progressing difficulty should be carefully designed and graded for the average man, who is neither subnormal, like the defective, nor supernormal, like the athlete; who has neither the desire nor the ability to represent his university upon the track or field, but who wishes to be at his highest point of physical vigor throughout his college course.

A fixed requirement is essential, with credits on the basis of laboratory work because a course of exercise requires guidance quite as much as the other subjects of the college curriculum, and the student's attitude will naturally be antagonistic to required work of any kind unless credit be given for the time taken from those studies which he thinks have a more direct bearing on his lifework.

Two objects must be kept in view in planning such a course: first, the correction of those bad physical habits that come with the student's sedentary life; and, second, the systematic education of those bodily powers that will be most useful to him during his college life and after graduation.

The sudden change from the active outdoor life of the country-bred boy to the confinement of college work is not unattended with dangers to health, as shown by the tendency to constipation and other disturbances of digestion, headaches, and the other common ills for which the college medical examiner is continually consulted. The long hours spent in the lecture rooms, not always too well ventilated, or bent over the laboratory table, must also be corrected by exercises that will strengthen the tired back and stimulate the sluggish heart and inactive digestion, that will draw the blood from the tired brain and congested abdominal organs into the pulsating muscles and expanded lungs, and

the means used must at the same time be such as to give a real education to his physical powers.

A successful course must develop those racially old coördinations that have given man his supremacy over the brute creation, and civilized man his superiority over the savage, for, contrary to popular opinion, the civilized nations are as dominant physically as they are intellectually.

It is by the cultivation of the great fundamental and vital activities that civilized man has asserted and maintained his superiority over more primitive races, and the rehearsal of these activities must form the basis of a course in physical education if it is to be interesting to the student and sound from the standpoint of the pedagogue. These are the exercises of *locomotion*, running, jumping, climbing, and swimming; of *fighting*, throwing, catching, dodging; striking, and wrestling, and of *coöperation* under a leader in group games where men are organized in teams, individual excellence being sacrificed to the common good.

The cultivation of physical intelligence can never lose its value, no matter how artificial may be the conditions of the community in which he lives. It is what teaches a man to escape injury in the many emergencies of daily life; it saves what would be a broken arm or a sprained wrist in one who had not learned how to keep his feet on the slippery pavement or how to fall without hurting himself, and many costly lives are lost annually through inability to swim, jump, climb, or dodge. These fundamental actions of locomotion and fighting form the basis of all games that have survived to the present time, but exercise for the college student must be put in such form as to get the greatest possible result for the time expended. Games must be modified and intensified to fit the conditions of college life. It takes a field 110 feet by 60 feet to accommodate 22 men in foot-ball, 24 in lacrosse, or 18 in baseball, but 1000 men can be exercised in the same space in similar movements by arranging them for class work, and the course can be progressive and logical from the teaching standpoint at the same time.

In the illustration (Fig. 135) a class of nearly 500 students is

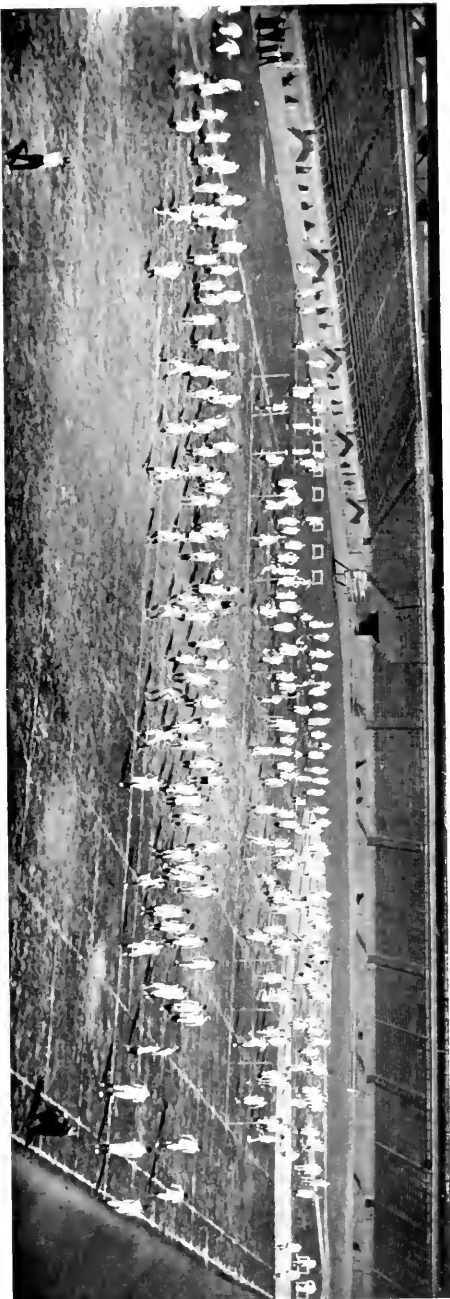

Fig. 133. Class instruction in athletics on Franklin Field. In the foreground a rank of sixteen have just put the shot, and are running to roll it back, after which they will wheel right and left in eights to the sides. Behind this squad another is taking the high jump, and in the rear a third rank, three standing broad jumps. At the sides and facing in the opposite direction are ranks of eight sprinting and hurdling. After clearing the hurdles they wheel right and left to the rear of the broad jumpers in a rank of sixteen.



Fig. 130.—Boxing drill outdoors.

seen engaged in athletic exercise on Franklin Field. Each man in turn sprints 30 yards, clears a hurdle, takes a standing broad jump, a running high jump, and puts the 12-pound shot, a short pause taking place between each act. The signal is given by a whistle, and at each signal nearly 100 men perform one of these feats.

Class work should be made progressive in difficulty, each movement leading into the next.

In teaching a movement like rope climbing, the student should be first examined and marked as to his ability to climb a rope by his arms. If he cannot do so at all (about 40 per cent.), he should begin by pulling his weight up once by both arms and dropping to the floor. He should then learn to jump and catch the rope, pulling his weight up several times, afterward learning to catch the rope with the arms and legs and climb by the use of both, and so on until he is able to climb with ease by using the arms and legs or arms alone; to carry the rope up with him; to tie a loop in which he can rest, or to descend with one arm disabled or carrying a bundle. He is then reexamined and passed in that method of locomotion.

The same method of teaching should be employed in swimming—a most important exercise—which includes, in addition to the various strokes, instruction in life saving and resuscitation of the apparently drowned. Boxing can be analyzed for class purposes and taught as a class drill. The position of defense, the leads, left and right, and guards, first simple, then in combinations, of increasing complexity, with and without foot work, until a good knowledge is obtained of this method of defense. The rudiments of wrestling should also be taught in the form of a gymnastic drill (Fig. 137), and gymnastic games should be freely used to train



Fig. 137. Wrestling used as a class exercise (U. of P. gymnasium): The chancery hold.

every man to know his powers and limitations in all the activities of running, leaping, and climbing, while no course would be complete that failed to recognize the educational value, physical, mental, and ethical, of those athletic sports that cultivate courage, pluck, and tenacity of purpose.

Where possible, all such exercise should be conducted in the open air, or, failing that, a spacious, well-ventilated, and well-lighted gymnasium.¹

¹ The gymnasium should be provided with several exercise rooms to accommodate the many activities that would otherwise clash, but where this is not possible, much may be done by the use of nets (Fig. 138), by which a large hall may be divided into courts, and basket-ball, wrestling, and gymnastics may be practised without interference or danger, and the entire floor may be supervised by one man. Separate rooms are necessary for fencing and boxing, and

A year's course of exercise will, of necessity, vary considerably with the special conditions to be found in the college or university, but the following plan, which is in use at the University of Pennsylvania, will be found to contain the main essentials of progression.

October: Physical examinations and examination of eyes, instruction in swimming to first year men; prescription and demon-

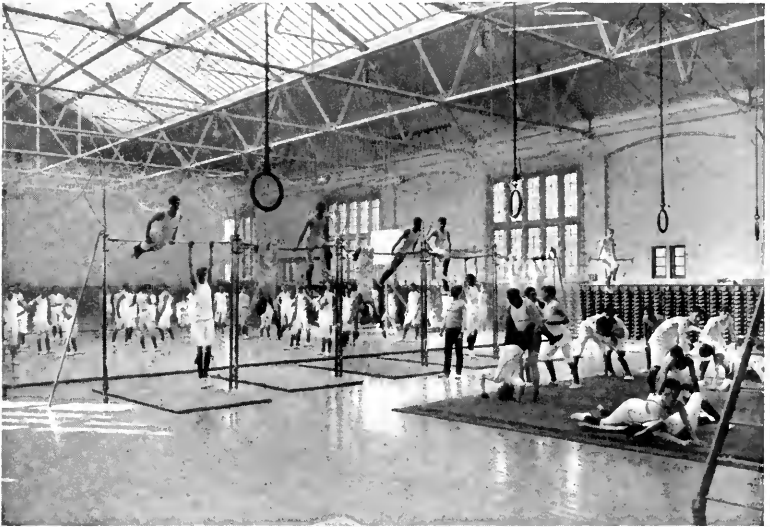

Fig. 138.—Gymnasium floor divided into three courts by nets, thus permitting basket-ball in the central court and wrestling and gymnastics at the two ends. This allows of supervision of the whole floor by one man (University of Pennsylvania).

stration of special exercises for round or uneven shoulders, constipation, flat-foot, weakness of abdominal walls, etc., given by the instructors on the gymnasium floor.

November 1-25: Class work in the gymnasium. Marching for the indoor preliminary practice of the crew (Fig. 140), hockey team, or baseball team. Corrective exercises are also better done apart from the noise and confusion of the main exercise hall with its constant succession of classes.

In the practical management of classes the advantage of having the apparatus in sets of six (Fig. 130) is great. By this means the largest class may be so divided as to prevent the waste of time that occurs when a long line of men must wait their turn to perform their exercise on a single horse or pair of bars.

tactics, quick time and double time; free setting-up exercises; gymnastic games.

November 25-December 1: Examination on first arrangement of apparatus; low horizontals, climbing ropes, flying rings, and vaulting horse. Men are graded as a result of this examination into first, second, third (or leaders), and fourth (gymnastic team) grades.

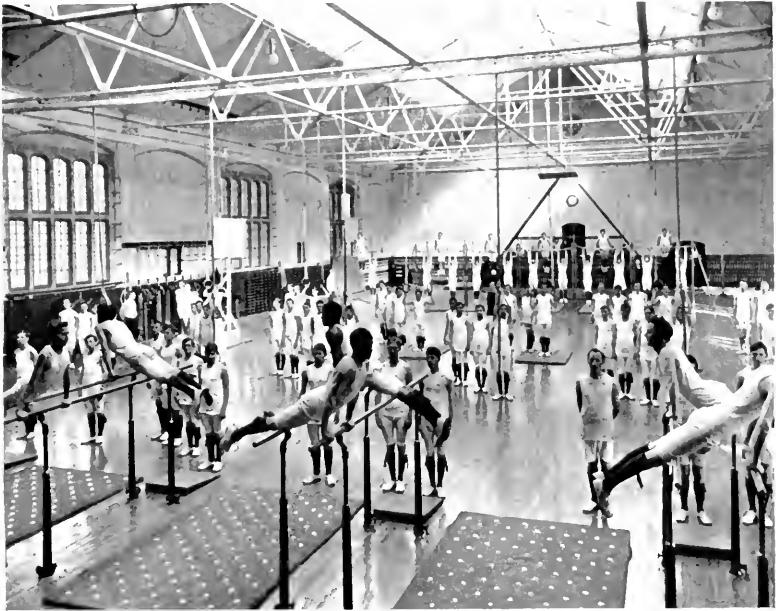

Fig. 130.—Gymnasium floor, showing apparatus in place for class work. Beginning with the background they are horizontal bars, flying rings, climbing ropes, and parallel bars arranged in gangs of six. The parallel bars are placed in floor sockets and can be replaced by the buck or long side horse (University of Pennsylvania).

December 1-January 27: First arrangement of apparatus, about ten consecutive lessons on each piece, progressing in difficulty. Drill with wooden dumb-bells. Re-examination.

February 1-March 4: Second arrangement of apparatus. High horizontal bar, tumbling, buck, long horse, and parallel bars, class drill with wooden wands or Indian clubs, preceded and followed by examination and regrading. Indoor exhibition.

March 4-April 1: Third arrangement of apparatus. Pyramid

building, boxing, or wrestling; drill with iron dumb-bells or steel wands; dancing steps. University circus given by the leader's corps.

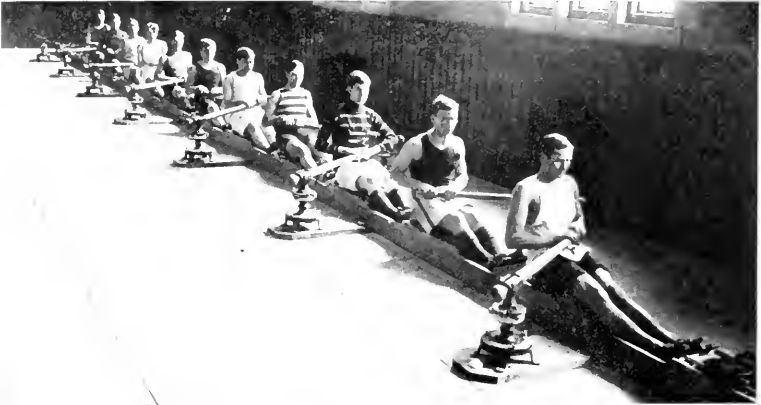

Fig. 142. Indoor practice for crew candidates during the winter in preparation for actual rowing on the river.



Fig. 141.—The building of pyramids as a class exercise, U. of P. gymnasium.

April 1–May 5: Athletic sports indoors or on Franklin Field when possible. The start in sprinting; hurdling; broad and high jumping; putting the shot; running and dancing steps. Outdoor exhibition of the united classes.

May 5 June 1: Physical examination of the graduating class.
 It is found that, after two or three years of the regular educa-



Fig. 142. A class drill in free movements and elementary dancing steps, U. of P. gymnasium.

tional classes, men take up specialties and devote themselves to advanced boxing, wrestling, fencing, or swimming, or join the crew, football, or baseball squad. A certain standard of excellence is required to get credit for these specialties, however, and many try for the teams, and, failing, drop back into the class work.

The following table shows the distribution of men in the different sports and in the gymnastic classes at Pennsylvania:

APPROXIMATE DISTRIBUTION OF MEN DOING REQUIRED WORK IN DIFFERENT FORMS OF EXERCISE DURING A COLLEGE YEAR AT PENNSYLVANIA.

Prescription work for defects or disability.....			300
Regular gymnastic classes.....			1000
Reporting for baseball.....	120	Retained on baseball squad.....	72
" " basket-ball.....	70	" " basket-ball team.....	16
" " boxing.....	14	" " boxing team.....	11
" " crew.....	71	" " crew.....	46
" " fencing.....	32	" " fencing team.....	8
" " football.....	123	" " football squad.....	77
" " gun club.....	7	" " gun team.....	7
" " gymnastic team.....	16	" " gymnastic team.....	0
" " soccer.....	42	" " soccer.....	18
" " swimming.....	90	" " swimming.....	28
" " track.....	283	" " track.....	66
" " wrestling.....	83	" " wrestling.....	12
Total.....	660	Total.....	368
			960
Grand total.....			2368

The actual conduct of competitive athletic sports may, to a great extent, be left in the hands of the students themselves as a part of their social training, but the university should require two things: a careful examination of the physical condition of competitors before allowing them to enter their name on the squad; and a rigid standard of scholarship for all who are to represent the institution in an intercollegiate contest.

The number of men who are prevented, by a preliminary medical examination from endangering health or life, shows the value of this precaution wherever the more violent forms of athletics are practised, and men sometimes present themselves as candidates for athletic teams who have unsuspected organic lesions of the heart, dangerous hernias, or incipient tuberculosis, men who have no place in the exhausting struggle of a game of football, a boat-race, or a half-mile run, but to whom regular judicious light exercise would have the greatest value.

The medical examiner should, of course, have complete authority to decide on the best course to pursue in each case, and he will usually find, with added experience, that he may permit many a man to engage in vigorous sports, with advantage to his health, whose condition would be condemned by one who went entirely by the standard text-books. This question will be more fully discussed in the chapter on Disorders of the Circulation.

The question of scholastic and amateur standing is scarcely within the scope of this chapter, but some universities require even a higher standard among their athletes than in the general student body, and the tendency of most academic councils is in the direction of greater stringency in the requirements and a more rigid enforcement of the regulations.

In rough games like football there will always be accidents to deplore. The chance of a twisted ankle or knee, or even a broken collar-bone or arm or leg, is one of the things that make such games attractive to the healthy young man, but if we put against these accidents the escapes that every old player of forty can recall from an injury that a clumsy slow movement would have precipitated, the balance will surely be on the other side, and the

permanent disability from accident is almost negligible in men who, properly examined, and found to be sound, are sent into a contest in good physical condition by an adequate course of training.

Practically all colleges and universities that have such a department organized give some instruction in the theory of physical training and personal hygiene, their courses forming part of the regular teaching, either elective or compulsory, as the special conditions seem to indicate, and the application of exercise and massage in medicine and surgery now has a recognized place in every well-equipped medical curriculum.

A summer course, lasting six weeks, for students and teachers of physical training has been given for the last twenty years at Harvard. It began with a one-season course, and now extends over three summers, and includes both theory and practice, and summer courses are also given at Columbia University, the College of the City of New York, and at Chautauqua. Owing to the imperfect and superficial training received by most teachers of this subject, these summer schools are most valuable and deservedly popular.

In addition to the supervision of the health and the teaching of the students, a department of physical education has unusual opportunities to promote original research in the problems of psychology, physiology, and anatomy that confront it, and the association of other departments in solving them should not be neglected.

The taking of certain measurements from time to time is useful to stimulate in the student a pardonable pride in his expanding chest and swelling biceps, but it is also of use to determine the proportions of the average student and his variations from this average.

Hitchcock, Seaver, and especially Sargent have done pioneer work on this subject.

Dr. Sargent's complete set of charts, containing the principal measurements of students for each year, from sixteen to twenty-five, and selections from his statistics for the youth and maiden

of twenty-one, have been embodied in two life-size statues, modelled by Henry H. Kitson, showing the medium measurements for that age.



FIG. 143.—The ideal college athlete.
(Copyright, R. Tait McKenzie.)

The variations from that type have been noted by Paul C. Phillips in his observations of sprinters,¹ by the author in

¹ "Outing," May, 1903.

speed skaters,¹ and by Dr. Sargent in his "Physical Proportions of the Typical Man" and "Physical Characteristics of the Athlete."²

The search for a physical ideal was undertaken by the Society of Directors of Physical Education in Colleges, who, in 1902, commissioned the modelling of a statuette embodying the average measurements and proportions of the pick of the student body, selected by taking the best fifty men in the all-around strength test for a period of eight years. These four hundred sets of measurements of Harvard students, supplied by Dr. Sargent, were used to determine the proportions of the "ideal college athlete" (Fig. 143), who is represented as placing in his right hand the spring dynamometer with which he is about to test his grasping muscles.

This youth may be said to embody the proportions and girths of the physically ideal American student of twenty-two.

With a height of 5 feet 9 inches, he carries a weight of 150 pounds. The girth of his neck, knee, and calf are the same, with the upper arm $1\frac{1}{2}$ inches less. The girth of his thigh is $\frac{1}{2}$ inch less than that of his head. His expanded chest is 40 inches and the girth of his waist is 10 inches less. His hip-girth is almost the same as his unexpanded chest, while the breadth of his waist barely exceeds the length of his foot, and the stretch of his arms measures 2 inches more than his height.

¹ "Popular Science Monthly," December, 1905.

² "Scribners," July and November, 1887.

CHAPTER XII

THE PHYSICAL EDUCATION OF THE BLIND AND THE DEAF-MUTE

HAVING described the physical education of the normal child from infancy to maturity, there remains only a description of the modifications required for the training of those unfortunates to whose minds the avenues of sight and hearing are closed; and of those others whose minds are dulled or who have already taken the first steps in the path that leads to the penitentiary or the mad-house.

Since the world of the blind is limited by the horizon made by the reach of his arms, his supremacy within this circle must be supreme.

Physical education does him a triple service by increasing the courage and confidence which he so sadly lacks by developing his muscular powers and by fortifying his body against those infirmities to which enforced idleness and a sedentary habit render him peculiarly prone.

It is within comparatively recent years that the physical education of the blind has been studied with care, and that methods have been adapted to their possibilities and limitations.

The most striking characteristic of the blind child is a certain timidity or fear of appearing at a disadvantage before others, especially in making an unaccustomed movement, so that the only exercise they undertake voluntarily is walking backward and forward in some confined place with which they are familiar. They are liable to sit still for long periods of time, and usually develop certain rhythmic habit movements of the head and hands, difficult to repress and correct.

They must either *feel* or *hear* a movement in order to learn it,

for they have not the mirror of their companions from which to correct faults in their own posture or action.

In the measurement of boys at the Overbrook School for the Blind it was found that their height, weight, and lung development were under the average of normal boys of the same age, as shown in the Sargent charts (Allen). The blind boy has thus even a greater need for physical training than the boy who can see.

In many blind children exercise must begin with the simplest acts, such as dressing and undressing, which have been neglected in many homes where the blind child is waited on and not trained in movements that make for accuracy and tidiness.

A course must pay special attention to the improvement of posture in walking, standing, and sitting, for the blind walk with the head inclined forward, the chest contracted, and usually come down hard upon their heels at each step, and it must embrace free movements for the chest, arms, and shoulders, including all possi-

FIG. 14. The playground of the Pennsylvania Institution for the Instruction of the Blind, Overbrook, Pa., showing the arrangement of brick walks in front of the rows of trees to warn the pupils of their whereabouts and prevent accidents.



ble games and other forms of reaction that can be conducted with safety and abandon.

The chief difficulty in a course is the cultivation of that physical confidence necessary for success in active sports like running, jumping, and gymnastics.

Various devices are required in the construction of the gymnasium and field to prevent accidents and to foster freedom of movement. The gymnasium hall should be constructed with a wooden floor, surrounded by a band of cement seven feet wide,

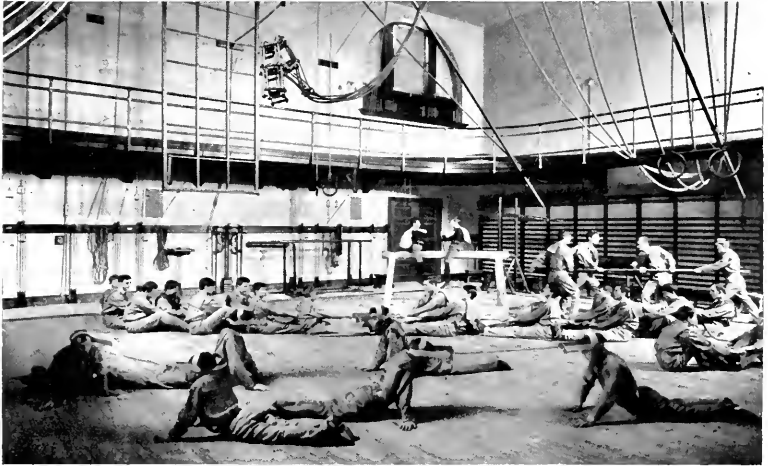

FIG. 145.—The cock-fight and other gymnastic games. The band of concrete at the edge of the floor is also shown. (Pennsylvania Institution for the Instruction of the Blind, Overbrook, Pa.)

on which all the heavy apparatus should be placed when not in use (Fig. 145). In this way a blind person is made aware of his approach to the wall, and of the presence of danger, when walking, running, dancing, or skating. A running track should have a hand-rail of convenient height to serve as a guide, and in the play-fields the presence of trees should be shown by having a brick walk about ten feet in front of or around them, so that the child may run and play with perfect freedom and confidence until warned of the approach to danger by the bricks under foot (Fig. 144).

Outdoor apparatus should also be fixed, the child soon learning their place, and avoiding the collisions that would inevitably occur if their position were a matter of conjecture.

Physical education for the blind should be compulsory at all institutions as it is at Overbrook, Pa., the classes being small and arranged in the order of their age, and with some partially blind pupils mixed with the totally blind to act as leaders. The formation of a class in the gymnasium need not differ very much from that of children with sight, except that in lining up they should keep in touch with one another by each pupil placing the



Fig. 146.—Method of alignment in a class of the blind in Sweden (Lefebure).

hand on the shoulder of the one in front, or, where a class is formed up in ranks, by placing the right hand on the companion's shoulder and the left hand on the waist, as is done in Sweden (Fig. 146).

When a number are lined up in single file a regular class formation can be obtained without difficulty by giving the order "right turn," and counting off, and this can easily be reversed to the original line-up when the exercises are over.

Gymnastic apparatus work may be used with considerable advantage, but the leader should be able to see a little, and members of the class must learn the movement by passing the hand

over the leader while he is doing it. By this means a wide range of work can be done on the horse and parallel bars, and such exercises as falling, rolling, and simple tumbling may be extensively developed, but the Swedish system of gymnastics, in which the exercise is performed in response to command, must be used sparingly, because of the great and rapid mental exhaustion produced in blind children.

Formal gymnastics and apparatus work should play, however, a comparatively small rôle in their day's exercise, and games should



Fig. 147.—100-yard dash. Start, showing handles and cables to direct their course. Overbrook record, 10½ seconds (Pennsylvania Institution for the Instruction of the Blind, Overbrook, Pa.).

be freely interspersed when symptoms of exhaustion appear. Among the most popular games are the cock-fight, and a game invented at Overbrook by Lindblad, called the Japanese torpedo, in which a small bag of sand covered by emery cloth is attached to a long string, and swung around in a circle by one pupil while the others jump over it as it passes, being guided by the sound of the emery cloth on the floor.

Running, roller-skating, and dancing can also be practised if

comparatively few skaters or dancers are allowed on the floor at one time, and all are required to circle in one direction only, the presence of the concrete margin on the floor being sufficient protection when heavy apparatus is carefully put back in its place against the wall after class use. Another protection against running into the wall is the changed resonance due to the presence of the running track, a phenomenon which the blind use continually for their protection.



Fig. 148.—100-yard dash. Finish. The racers are able to give unhampered attention to speed by means of the device shown above. Upon the wire cables, stretched the full length of the track, are rings to which are attached short chains and handles. The racers hold these handles and run the course with perfect freedom. They are warned of the end of the track by the fringe of cords like that used on railroads to notify brakemen on top of freight cars of "low bridges" (Pennsylvania Institution for the Instruction of the Blind, Overbrook, Pa.).

Among the outdoor sports walking is almost the only one blind children will voluntarily undertake, although they can be taught almost all the field sports, with but few restrictions.

Clarence E. Van de Walker, the instructor at Overbrook, writes on this subject:

"To me, watching and directing this work from day to day, the sight of strong, active boys learning to run in much the same

way that a baby learns to walk, and experiencing about the same difficulties, was both amusing and pathetic; but the smile and shout of triumph which burst forth simultaneously from the boy who had succeeded in really running were ample proof of his delight to



Fig. 140.—Blind boy preparing to jump.

discover that he possessed a power dormant so long that he doubted its existence."

Foot-racing was practically impossible until the invention of a method in one of the institutions of Edinburgh, by which a three-stranded cable as light as was consistent with strength was stretched breast high between well-guyed end-posts 110 yards apart. The

runner holds in one hand a wooden handle attached by a short flexible chain to the long wire. As he runs the ring slips along and the feeling and sound enable him to hold his course. At the end of the 100 yards a cord is stretched across, about seven feet high, from which hangs a fringe of hammock twine long enough to strike the runner in the face as he passes. This fringe covers the two parallel lanes, so that competitors may run in pairs, and prevents those accidents that were at best too frequent in the open field.



Fig. 150.—Putting the shot (12 lbs.). Overbrook record, 35 ft. 1½ in. (Pennsylvania Institution for the Instruction of the Blind, Overbrook, Pa.).

Even the running broad jump may be practised, the measurement being made from the starting foot instead of from a fixed board.

Other popular field sports are putting the shot, throwing the discus, and throwing the hammer—with a stiff wooden handle and thrown from a stand.

A strange phenomenon for the psychologist is the popularity of a modified form of baseball, in which, at a signal, the pitcher throws the ball, the batter strikes, and the catcher catches. As a rule, no one accomplishes anything but the pitcher, and yet boys



Fig. 151.—The swimming pool (Pennsylvania Institution for the Instruction of the Blind, Overbrook, Pa.).



Fig. 152.—Trolley coasting on the athletic field (Pennsylvania Institution for the Instruction of the Blind, Overbrook, Pa.).



Fig. 133.—Ring game. Kindergarten building in the background (Pennsylvania Institution for the Instruction of the Blind, Overbrook, Pa. .)



Fig. 134.—A game of "blind man's bluff" in the girls cloister (Pennsylvania Institution for the Instruction of the Blind, Overbrook, Pa. .)

will play this for hours at a time. Football is also played by choosing sides and kicking the ball back and forth until the goal line of

one side is crossed. This is also popular, and can best be done by choosing one, at least, on each side who has partial sight.

Swimming is an excellent exercise for the arms and shoulders, and is practised with success among the blind.



Fig. 155.—Rocking-boat (Pennsylvania Institution for the Instruction of the Blind, Overbrook, Pa.).

Athletic sports are quite as popular among the girls as they are among the boys. They enjoy jumping and running, and athletic and gymnastic apparatus, like the trolley-coaster, swings, and seesaws, should be provided for them in the gymnasium and out-of-

doors, while the rocking boat is safe and an endless source of pleasure to the younger children.

The Deaf-mute.—A system of physical training designed for deaf-mutes must take into consideration the peculiarities incident to deafness that divide them from the rest of humanity into a class by themselves. And it must also bear in mind the fact that in almost every respect they resemble other children. A deaf child thinks in gesture and pictures, and so expresses his thoughts, but his verbal memory is undeveloped. His chest and all the apparatus of articulation are, in consequence, under the average, and



Fig. 130.—Deaf-mutes playing basket-ball.

they are peculiarly liable to disorders of the respiratory tract accompanying this underdevelopment.

In girls of sixteen one series of observations by Miss Grace Green showed an average lung capacity of 118.3 cubic inches, as compared with 130 cubic inches of the normal girl of the same age.

Their powers of coördination, particularly of equilibrium, are not up to the normal, and they have a peculiar characteristic slouch of the figure and a shuffling gait.

Physical education would then include and emphasize the teaching of articulation, which is an art by itself; the develop-

ment of the respiratory system; the cultivation of balance and the correction of postural defects.]

The education of the deaf is carried on better in an institution than at home, and as the great majority of such cases come from the poorer classes, and have to be made as efficient as possible as wage-earners, I shall write more particularly of institutional work.

No formal drill should be given to the very youngest pupils, who have no "*language*," but games and free play seem to suit them best. To the class next youngest, whose *language* is limited, work should be given by word of command, followed by the execution of the movement, which the children imitate. In this way the movement of the lips is associated with the exercise, and the child is trained to read the lips in such wise as to learn the response to the command without further demonstration.

The teaching of lip-reading is part of the instruction in every institution for deaf-mutes.

The last census of the United States shows that of 89,287 deaf, only 13,986 could read the lips, and speech-reading was confined almost entirely to the totally deaf, since the partially deaf or those who have acquired deafness in later life do not learn it, but depend on the use of some device like the ear-trumpet in preference.

About 39 per cent. of the totally deaf have been taught lip-reading at institutions like Mount Airy, Pa., and elsewhere, and as every means is taken to practise the children in this art, physical training gives valuable opportunities.

In the more advanced grades, as their language becomes better, the significance of the command is apprehended and its full meaning realized. Exercise by word of command is then of double value for deaf-mutes, since it teaches lip-reading and trains their verbal memory. There are two things to be remembered, however, in teaching a class of deaf children. The teacher must always be in front of the class, on a platform elevated at least one foot above the floor, so that each pupil may have a clear view of her mouth without having to lose the correct attitude in standing. Commands for marching and turning movements must always bring the class

back to a position facing the platform, as the pupils have only the teacher's face to depend upon for direction. Her face should be well lighted, and the commands should be given with full force, so that the natural facial expression may be maintained. This, while an advantage, is not essential, as I have repeatedly seen a class respond promptly and accurately to a command given by the lips only without any sound.

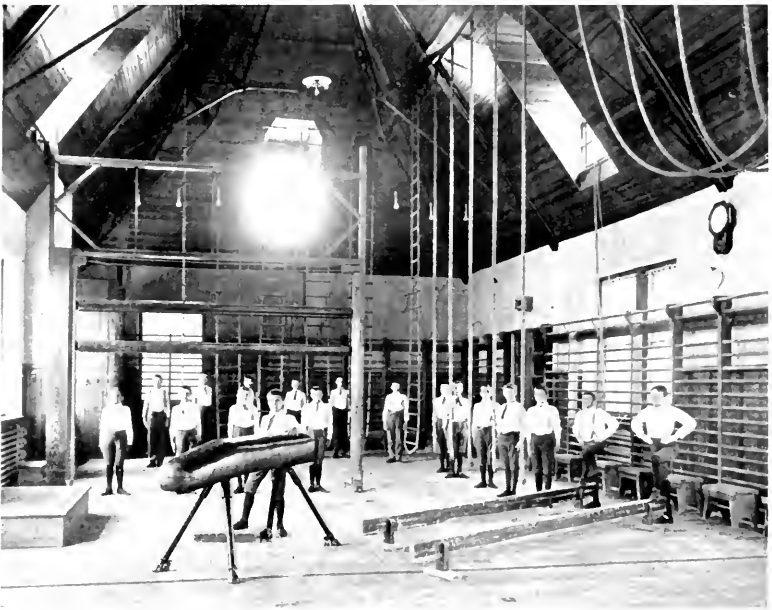

Fig. 157. The gymnasium at Mount Airy, showing the balance boards for teaching equilibrium, in the foreground.

The shuffling gait and bad posture are corrected by setting-up exercises, taken in the standing and sitting positions. Close attention should be given to the correct carriage of the head and shoulders; to the rhythm and length of the stride; to the position of the feet and the distribution of the body weight.)

Balance movements are most useful for encouraging a better equilibrium and improving the manner of walking, requiring, as they do, a high degree of coördination. Whether a lack of coör-

dination and equilibrium is or is not a direct result of deafness is not proved, although in many cases it would appear to be the case.

In a series of experiments conducted by Miss Grace Green, at Mount Airy, 60 pupils were chosen from the intermediate department of the institution on account of their untrained sense of equilibrium. From this number 16 were excluded, classed as semideaf. Of those remaining, 27 were congenitally deaf and 17 were semimutes. Of the 27 congenitally deaf, 20 could sustain equilibrium with little difficulty and 7 could not, while of the 17 semimute, only 2 were able to keep in balance.

It is also worthy of note that of the 44 cases, 32 were unable to maintain equilibrium on the balance beam or board.

These experiments emphasize the importance of balance exercises in the training of the deaf, for they rapidly respond to systematic training.

Deaf-mutes do not compare favorably with hearing people in the matter of longevity. They die in a larger proportion from diseases due to bad feeding, poor housing, and unsanitary conditions. Mouth-breathing is exceedingly common among them, and there is a high mortality, due to chronic affections of the respiratory tract. Great emphasis should thus be laid upon good food, warm clothing, the cultivation of speech, and the use of respiratory exercises, both free and by the aid of apparatus.

It is to be remembered that one of the chief characteristics of the deaf is the lack of speech. The hearing child who is laughing, singing, and shouting in his play all day is unconsciously giving to the lungs one of the most healthful exercises. The power of speech is a great incentive to the use of the lungs, and the acquirement of speech, one of the first things that should be taught the deaf child, can be greatly aided by exercises of deep breathing, together with movements of the arms, chest, abdomen, and lateral trunk, with special training in tone production and control of the respiration. The patient is thus given increased power to resist disease, and acquires better speech through this development of the entire respiratory tract.

Miss Green has shown at Mount Airy a rapid and gratifying

increase in the chest capacity of the girls of that institution under the influence of physical training and instruction in articulation. Her pupils showed an average lung capacity of 118.3 cubic inches on entrance, in comparison with the average 130.3 for normal girls of the same age. With training the average was raised to 139.6 cubic inches from one season's work.

Games and play are used freely, both to relieve the tedium of the more formal gymnastic work and to give that development which can be produced by free play alone. They differ little from the plays of the normal child, and should be designed so as to involve the actions of large muscle groups, training the children in alertness, decision, and accuracy.

For boys and young men all the games and sports of the normal child are available, and it is not uncommon to see the football or basket-ball team of such an institution taking its place with that of a preparatory school or college of the same size, although the silence with which they play forms a striking contrast to the noise of their opponents.

CHAPTER XIII

PHYSICAL EDUCATION OF MENTAL AND MORAL DEFECTIVES

It is during the early years of school life that the condition known as mental dulness, backwardness, arrested development, or feeble-mindedness develops sufficiently to be capable of definite diagnosis. It is there also that the first steps can be taken to correct mental sluggishness and to train the neuromuscular system of these atypical children.

The backward child is always much older and bigger than the children of his class, hopelessly behind in his standing, usually remaining two or three years in the one grade, and sometimes promoted only when the desks and seats of the room have become too small for him.

Any child that is not able to profit by the ordinary methods of instruction given to the other children of his age should be considered backward or defective, and all such cases should be carefully observed, and a record of their habits and mental characteristics should be made in coöperation with the medical inspector, or, if necessary, with an expert on mental conditions. A thorough examination should be made of the special senses and throat; adenoid growths where found should be removed, and defective vision or hearing corrected. The removal of these remediable obstructions is frequently sufficient to permit the backward child rapidly to regain his normal grade standing.

Mental dulness may be due also to physical weakness following severe illness, or to other curable conditions that may not have been recognized by the parent or family physician. Again, certain children in good physical health develop slowly at certain stages, afterward catching up with their fellows. This may be due to a

period of rapid physical growth, and should be carefully distinguished from the more serious conditions. Teachers all recognize a class of children who remain distinctly backward for several years. When they wake up, as they eventually do, they frequently show unusual ability. When these cases are accounted for, and their types of temporary slowness or abnormality noted, there still remains a group of pupils who, while not actually idiotic, are so deficient mentally as to be entirely incapable of profiting by ordinary school methods.

In the examination of 100,000 London school-children, Dr. Francis Warner, in 1890, showed over 1 per cent. of actual mental defectives, and similar investigations show that this ratio holds good in America.

The symptoms of mental deficiency are characteristic. Backward children are fatigued by any mental effort and lose interest quickly. They are not observant, are not able to discriminate quickly and accurately color, form, or size. They may be unduly idle and listless or overexcitable. They are often disobedient, wilful, and liable to attacks of stubbornness and bad temper. They are untidy in their personal habits (Fernald), awkward in their gait, movement, and attitude. In grasping, they are either feeble or they may clutch the object and seem to be unable to let it go. Incoördination is plainly shown in drawing and writing, in the lack of skill and dexterity in simple gymnastics, and in the lack of initiative and spontaneity. They do not show the strength, vigor, alertness, and courage of normal childhood.

When a diagnosis has been made, the parents should be frankly and tactfully taken into the teacher's confidence, the use of opprobrious terms to express mental defectiveness being carefully avoided. The parent should be impressed with the fact that the child is not doing well at school and that for his own sake he should have special attention to prevent him from going backward, as well as to train to the best advantage such powers as he has.

Slight cases of backwardness may be taught in classes composed of children who show about the same degree of retardation, while pronounced and incurable cases are much better safe-

guarded in an institution where they can be more closely observed and protected.

The physical education would then vary with the degree of the defect and with the amount of control exercised by the teacher.

In a school system special classes should be provided for them, and teachers should be specially prepared to take charge of these atypical pupils. Public schools for them have been in successful operation in Germany, Norway, Sweden, Denmark, France, Switzerland, and England. In London alone there are more than 60 classes, and such classes are also in successful operation in Philadelphia, Providence, Boston, Chicago, and elsewhere.

Backward children are segregated for their own benefit, and also for the benefit of the other pupils of the school whom they would hold back. The classes should be small—not over 15 in number—and great attention should be paid to improving the child's surroundings in the home as well. His physical condition should be kept as favorable as possible by nourishing food, regular outdoor exercise, bathing, ample sleep, and careful attention to bodily functions and habits. The mental awakening resulting from an improved state of nutrition and bodily vigor alone is often striking. The education of the special senses and the training of the voluntary muscles to prompt and accurate response must precede and prepare the way for the more purely intellectual training. The unseeing eye, the unhearing ear, and the other obstructed avenues of approach to the central intelligence must be opened up by a series of carefully arranged "sensorial" gymnastics. The ultimate aim of these exercises is to train the child to acquire knowledge from his sensations. Next in importance comes the discipline of the muscles, not only for muscular growth and practical coördination, but particularly with reference to the well-recognized relation of thought to muscular movement, motor training being one of the most potent factors to arouse the feeble powers of voluntary attention, observation, and comprehension. This motor education should begin with the common games and occupations of normal childhood. The child should be taught to throw and catch a ball,

to kick a foot ball, to jump and run, and, in fact, to perform larger movements calling for the natural use of the various muscle groups, progressing with an eye to the normal evolution of the play instinct as described in the chapter on Age and Occupation.

Music and rhythmic marching are preferable to more formal gymnastics, involving close and continued attention, prompt obedience, and accurate motor response. These qualities must be cultivated by the simplest movements at first or the good effect will be lost. Gymnastics by commands would at first be entirely beyond most of these children, whose attention would quickly lag and whose coöperation and interest it would be impossible to maintain.

What has been said of general motor training applies with special force to the training of the finer coördinations of hand and forearm. This can best be done by kindergarten methods and by manual occupations, such as Sloyd, basketry, and weaving. Indeed, there are no other means of influencing so profoundly the mental growth of the defective. Instruction must always begin on a very low plane and progress at best will be slower than in the normal child. At an early age much of this neuromuscular training by gymnastics may be directed to the various handicrafts and simple manual labor which will enable many of these children, especially in institutions, to become self-supporting in after-life, who would otherwise become a burden on the community. Under this course of education some children develop up to the grade classes and return to them, completing a fairly satisfactory school course. When, however, the degree is extreme and the condition is congenital or the result of disease or injury, these brain abnormalities remain permanent conditions, and no really feeble-minded person was or can be entirely cured (Fernald).

It is always a question of how much improvement is possible in each individual case. Many of them may be trained to be at least self-supporting, if not self-controlling, but the greater number need oversight and supervision as long as they live. A large proportion become public charges, and it is important that they be kept in institutions as they approach adult life, that they may not

have an opportunity to yield to the physical temptations to which they are so peculiarly susceptible, and so propagate their own kind.

Cases of gross defect are always better treated in institutions than at the school or in their own homes, but even in aggravated cases much can be done by motor training to improve their bodily habits and to increase their range of usefulness, making them more observant and appreciative of their surroundings. According to Barr's experience, the best results are obtained from military drill, games, and gymnastics, with manual training varying in difficulty with the grade of backwardness, the relationship of the grades in mental defectives being somewhat like the successive ages in children so far as their helplessness is concerned. The lower grades are like the youngest children, but their physical conformation does not correspond with their mental backwardness.

The more educational movements should be directed, first, to the posture and gait of the patients. Their most characteristic defect is the shambling walk, with dragging feet and slouching figure. This may be corrected by running to command up or down hill, by walking contests on tip-toe indoors or out-of-doors.

Such exercises, briskly carried out, awaken the attention and make a good break in a long occupation period.

The use of a springboard, supplementing walking drills, develops elasticity in the dragging step. Stooping may be corrected by balancing a book or basket on the head, and the poise and ease of bearing thus improved. The placing of a ladder horizontally on the floor is a valuable way of correcting a slouching gait. The child steps between the rounds, and must raise the foot well at every step. The stepping on bricks placed at regular distances is another device for the same purpose.

Military drill has a peculiar educational value for a defective (Barr). The boy learns a certain standard of precision, attention, and readiness of movement. The emulation brought about in these movements is important. The stimulation of his ambition to attain to the power of the others; to present arms in order that he may not disturb the general movement of the squad, is also one of the most important means of character building.

This discipline is also obtained by gymnastic exercises in which prompt obedience to command is insisted upon. These drills should be practised only for a few minutes at a time, and varied in difficulty to suit the grade of the class. The training for skill and coördination of the arms and hands (Fig. 158) may be accomplished by the horizontal and parallel bars and the use of ladders for climbing.

One of the most defective coördinations in the atypical child is found in the power of grasping. The weak and nervous fingers



Fig. 158.—Defective class. Nine to fifteen years. First grade work. Sideward bending, showing the poor coördination in the carriage of the head and arms (Krogh).

of the untrained imbecile can retain nothing within its grasp, or the nervous clutch, unconscious of its violence, is equally expressive of mental incapacity.

It is necessary, then, to train this coördination by simple and strong exercises of hanging and climbing, catching and throwing, before giving to the child a hammer, a saw, or a chisel. The throwing and catching of balls, from the baseball to the medicine ball, are useful, as are the simpler exercises on the bars and rings.

In high-grade defectives this power of regulating the grasp is better controlled, but it may be still further trained by weaving,

club-swinging, or blackboard drawing with both hands, after the system of J. Liberty Tadd.

Active sports are to be warmly encouraged, the exhilaration to the onlookers as well as to the participants being a good antidote to the lethargy and the timidity of the feeble-minded. The circulation is stimulated thereby, and the muscles, which are inclined to be flabby and cold, are improved in nutrition.

Dancing is an amusement in which most of these children delight, and many excel, and its good effect is evident at once. Running, racing, swimming, leaping, vaulting, quoits, tennis,



Fig. 150.—Crippled and defective children gardening (Playgrounds Association of Philadelphia).

croquet, are all most suitable, while football, baseball, and basketball are frequently well played and eagerly discussed by children even of a very low grade, but lack of initiative is the outstanding characteristic of the great mass of incapables.

During a recent visit to an institution for the feeble-minded a group of boys were seen working in the field. Their attention being attracted, they all stopped, some with bent back about to lift a shovelful of earth, others in various stages of arrested movement. Thus they remained until called back to their work by the shout of the foreman. This mental apathy expressed by

sluggish physical movement is present in nearly all low grades of intelligence, and can only be reached by such means as have been described.

The other type of mental defectives shows an abnormal excitability, seen in restlessness, insubordination, and truancy, and it is these children that so frequently find their way into the Juvenile Court, the reformatory, and the jail.

Blunted intellect and moral failure, as a rule, go hand in hand, and it is a mistake to suppose that the criminal child or man is naturally bright. If apparently bright, it is usually in a narrow line and self-repeating—more allied to animal cunning than to intellectual power. He is vacillating, without fixed purpose or aim, incapable of pursuing a consistent plan, and of a rudimentary or atypical mental development.

Physical training, then, is specially indicated in the case of the youthful delinquent who so often enters the school for delinquents poorly nourished, anemic, with muscles soft and flabby, from a life passed in the dark and unsanitary tenement house, homeless on the street, or uncared for in the village. Along with this common city type there will also be found in the Juvenile Court or special training school the apathetic dullard, stupid and shambling, whose every motion expresses mental lethargy and physical incapacity. As a rule, these cases detest exercise or anything that disturbs their stupor, and for them discipline must be Spartan in character, for exercises need not be agreeable to be beneficial, as has been well insisted upon by Sargent and is daily proved in the reformatories.

A course of physical training for such children acts beneficially in three ways: By awakening the brain activity of those who are mentally defective; by bettering the badly nourished and flabby muscular system by developing the heart and lung power; and by demanding alert and prompt response to command, a most important lesson, to be taught so well in no other way.

The course of training for the incorrigible youth or young criminal would begin with military drill, in which the boys are formed into companies with sub-officers selected from their own

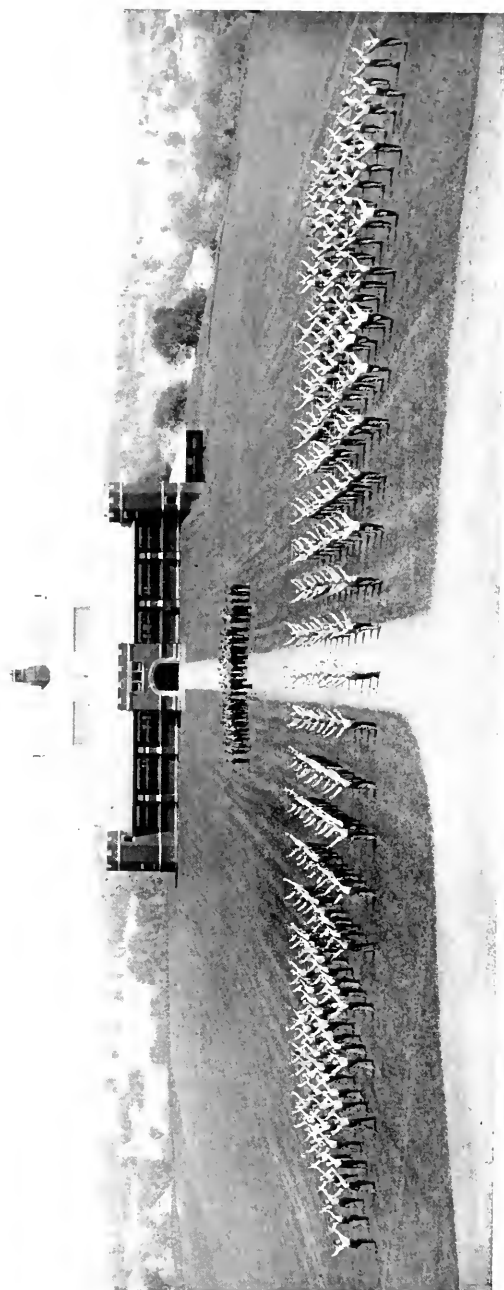

Fig. 100.—Free gymnastics by the boys at Glen Mills. The band and gymnasium in the background.

number. These companies are taught the usual evolutions of marching, countermarching, and the manual of arms. The authority of the officers selected from among the boys should cease with the end of each drill, and promotions should be made with the greatest care. There is always a temptation to bully if the giving of this temporary authority is not rigidly guarded. The perfection to which the military drill can be carried is shown by the attainment of the boys in the industrial school at Glen Mills, whose evolutions on the field would do credit to regular soldiers.

The second means of training is by gymnastic exercises, and those in use at Glen Mills are semimilitary and founded on the German plan, rather than the Swedish. The boys are lined up and marched to the gymnasium, which has a concrete floor. Coats, hats, shoes, and stockings are removed, and a brisk drill is given either with wands or dumb-bells. This is followed by a five-minute period of free play, in which the noise of the boys is in marked contrast to the comparative silence of the class work. Following this is apparatus work on the parallels, horse, and horizontal bar, class leaders being promoted from among the boys. After another period of free play the lesson ends by gymnastic games. The boys are then lined up, shoes and stockings are put on, and they are marched back to their various occupations.

The third means of training is by outdoor sports and games, in which great freedom of organization and conduct is allowed, although strict supervision is still kept and the boys are punished for misbehavior by being made to stand along the side line of the playground with the back to it for periods of five or ten minutes. If the offense is a severe one, the salutary exercise of continuous, slow, deep knee-bending is added during their period of punishment. Competitive games with outside institutions are arranged, and track and field sports are freely indulged in, giving good opportunities for moral and ethical training, which are not neglected. The results have been so satisfactory that physical training is now established on an equal footing with industrial training and school of letters work in the regular days' curriculum of these incorrigible boys.

Physical training has a marked effect on the physique, mentality, and conduct of criminals who have attained their full growth, as proved by the experiments of Hamilton D. Wey, at the Elmira State Penitentiary. His description of the criminal is illuminating:

"The average youthful criminal, as encountered in the prisons of the State, is an abnormal production, physically, mentally, and morally. Generally under weight, with repulsive features in some one or more lines, and asymmetric head; he is coarse in fiber and heavy in his movements. His mind, while not diseased, is undeveloped, or it may be abnormally developed in certain directions, the smartness resulting therefrom partaking of low cunning and centering about self. He is deficient in stability and will power, and incapable of prolonged mental effort and application. His intellect travels in a rut and fails him in an emergency. His moral nature shares in the imperfections of his physical and mental state. He does not possess the power to discriminate between right and wrong, or if so, it is in favor of himself and avails nothing to society. It is easier for him to incline to evil rather than to good, to the animal, rather than to the intellectual, and in this he is true to himself. His is a perverted moral nature—a blunted mind and a crude body."

It is to physical training that we must look for the awakening of those powers that can be directed by firm discipline to the physical, mental, and moral betterment of these derelicts.

During a period of sixteen months a class of 43 dullards was given a course of physical training at Elmira. This comprised baths at frequent intervals, in conjunction with passive exercise, kneading the muscles, working the joints, and general friction by a professional trainer; and a manual drill in calisthenics to supplement the shop work, from which they were excused, although their school work was taken as usual. They were put on a specially nourishing diet. The physical exercise lasted for about two hours a day. They began with the ordinary marching, and in time were taught other evolutions, although the teaching of keeping step was a matter of weeks. When they could do this well, they were given setting-up movements and exercises with dumb-bells up to three

pounds in weight. The first experiment lasted from June until November, and showed a net average gain of 1.23 pounds a man. Various skin diseases disappeared, the muscular condition and the carriage improved, and the response to command became much more rapid and accurate. The whole expression of the face improved, the dull, stolid look assumed a more intelligent expression, and the eye gained in brightness and vivacity.

A mental awakening accompanied this, and their progress in school rapidly showed the effects. During the five months they were under observation their average marking in school was 74.16 per cent., as against 45.2 per cent. for five months immediately preceding their course of special training.

This improvement was continued to a remarkable degree, and the stimulation of the physical powers in the case of three of the class impressed their mental organization to a degree that it enabled them to earn their release on parole, whereas if left to themselves their minds would never have been so quickened.

To train these dullard's legs and arms to act with precision and in unison was more than the mere rehearsal of mechanical movements. It was *mental* as well as physical training, and Dr. Wey is of the opinion that in the prisons and reformatories of the country "there is a class of youthful felons who can thus be reached in their growth period and improved primarily through the training of the body, the cultivation of the head following in good time. If penal institutions in their educational work could more often look upon bodily training as a powerful agent for the physical, mental, and moral reformation of their charges, more men would be released at the expiration of their time competent to maintain themselves honestly."

This result is only to be obtained by careful physical training with an educational purpose, for, as F. H. Nibecker, the superintendent of Glen Mills School, so well puts it, "Hard work of any particular kind is not complete exercise, nor is it equivalent to physical training, by which the perception is quickened and mental training results, quite as pronounced in effect as from efforts that have mental training more directly in view."

PART II
EXERCISE IN MEDICINE

CHAPTER XIV

**THE APPLICATION OF EXERCISE TO PATHOLOGIC
CONDITIONS**

THE efficacy of both active and passive exercises in the treatment of pathologic conditions depends on their power to change anatomic structure and to stimulate physiologic function. This anatomic and physiologic effect is very differently expressed in exploits of endurance, in feats of strength and skill, and in the passive procedures of manipulation and massage.

Exercises of strength, requiring little coördination, rapidly add to the bulk of the muscle tissue, but it is the nervous system that receives the accurate training in exercises of skill, while the muscle girth is increased but slightly; and mild automatic exercises of endurance train the heart and expand the lungs more surely than do supreme efforts of strength or the cultivation of skilful muscular control.

Passive exercise has an almost purely mechanical effect on the muscle tissue and circulation obtained without the mental concentration or the taxing of the heart and lungs, required to educate or reëducate atrophied and undeveloped coördinations and to increase the powers of endurance, and so must be considered somewhat as a stimulant by which the nutrition of the part is maintained or improved through its blood-supply.

In a sprained or disabled joint the circulation is subnormal and the process of repair is delayed on account of the enforced immobility of a structure whose natural function is movement. Massage is the most valuable means of hastening recovery in such cases, being widely employed by all nations, from the Turks and

the Africans to the Siberians and the Laplanders. In an old sprain the tissues are matted together; the surface of the skin is dry and harsh, bluish, livid, and shrunken in appearance. The stagnant blood circulating slowly through the obstructed and narrowed vessels is unable to give the tissues sufficient nutrition or to remove the accumulated débris of a month's inaction. Manipulation and massage act upon the muscles, nerves, blood vessels, and skin, and the circulation at once renews its power. With the application of friction and kneading the life of the part is quickened, the veins and absorbents are emptied first, and the fluid contained is driven on toward the heart; the pressure falls in the smaller vessels and tiny irregular lymph-spaces, extending through the tissues in all directions. Their contents are driven into the emptied veins, the circulation becomes more rapid, metabolism is carried on with greater energy, the tissues become full and sensitive to the touch, and the parts regain the even, rounded contour of active health. The skin loses its harshness, becoming soft and pliable, and after a single application the muscles are capable of working with less fatigue, while the joints become pliant and the ligaments relaxed.

In the chapter on Massage it was shown that a muscle exhausted by lifting a heavy weight does not at once regain its power if merely allowed to rest. If it be treated by massage for the same length of time, its strength returns, so that it is able to repeat the effort with less fatigue. The normal irritability of the muscle is temporarily restored, as shown by its sensitiveness to electric stimuli. Adhesions are permanently stretched or broken down, and the encumbering waste materials thrown into the circulation, while the effect upon the nervous system is indicated by the disappearance of the pain and sense of insecurity.

The swelling and tension so characteristic of a recent sprain can be quickly absorbed by gentle and careful massage, accompanied by elastic pressure and the application of heat between the treatments. The tension disappears as the fluid is carried off, the temperature falls, and the pain caused by pressure on the sensory nerves is relieved. Extravasated blood is broken up, and the adhesions usually found between torn and mangled surfaces are prevented, although time is always needed firmly to repair struc-

tures that have been actually lacerated. In older cases, where the synovial membranes have lost their resiliency from long-continued distention, where the tissues are sodden and edematous, and the effusion dense and firm, massage can be used with greater freedom to disperse the chronic congestion and raise the tone of the tissues. This improvement is often surprising in its rapidity. The joint that has remained for weeks cold and inactive, incapable of performing its proper movements, the seat of constant wearing pain, recovers its flexibility, loses its pain, and allows itself to be handled and used with freedom. Manipulating the joint, moving it throughout the greatest extent of its normal range, should be added to massage in recent cases as well as those of long standing. Few minor operations give such instantaneous and striking relief when used with care and judgment. These movements stretch or snap small adhesions that limit the excursion of the joint or press upon nerve-endings, causing acute pain.

If the sprain be recent, adhesions are prevented altogether, but if they have already formed, they may thus be stretched slowly and gradually by repeated gentle movements or may be actually torn, with instantaneous relief to the patient. It is in these manipulations that bone-setters have acquired their reputation for supernatural skill, and many miraculous instances are recorded of the immediate recovery of long disabled joints. After perfect freedom of movement has been obtained, the voluntary power is sometimes slow in returning and the recovery must be completed by active voluntary exercise in accordance with the natural movements of the joint.

A muscle that is repeatedly exercised in movements of full contraction against resistance gradually pulls its origin and insertion nearer by its inherent elasticity, even when at rest. It is this quality of muscular tissue that gives the characteristic semiflexed pose to the hand and arm of the weight-lifter or oarsman. It is also this quality that is of assistance in the treatment of the many faults of posture caused by the overstretching of weakened muscles and ligaments, and the consequent overdevelopment and shortening of their antagonists.

The whole struggle of man is to establish and maintain the

upright posture by the constant extension of the body, and to do this he must overcome the tendency to flexion caused by gravity and occupation, for the entire range of postural defects, such as flat foot, round shoulders, flat chest, irregular development, and fatigue scoliosis, are essentially *occupation disorders*, associated with the maintenance of the erect position, first, of the muscular system; second, of the ligaments; and, finally, in severe cases, of the bones themselves. These defects are caused most frequently by long-continued faulty positions in the growing child, and it is to the development of the weakened and overstrained muscles, to the stretching of contracted ligaments, and to the reëducation of proper sitting and standing positions that we must look for the greatest curative effects in these disorders.

Exercises of strength are to be chosen for the correction of postural faults, and their selection must be carefully made, for the weakened groups must be isolated for action, so that general fatigue may not supervene before the full therapeutic effect is obtained.

In certain disorders of the general circulation, with symptoms of heart weakness, like breathlessness and œdema, complicated by obesity, typical exercises of endurance, such as walking and hill-climbing, have been used with success by Oertel and others in Sweden, Germany, and America, while the more specialized exercises of strength, in the form of simple gymnastics, duplicate resisted movements, and the passive manipulations of massage, have been used successfully even in cases showing loss of compensation.

The treatment of obesity, even when complicated by weakness of the circulatory apparatus, requires, in addition to the regulation of diet, gymnastic exercises of strength, employing the great muscles of the trunk and legs, combined with exercises of endurance, such as walking and hill-climbing. Massage alone does not seem to have much effect in reducing weight. Von Noorden cites the case of a very obese subject whose arm was treated by vigorous massage for a prolonged period, without obtaining any reduction in its size. The value of massage, however, is incontestable in

many disorders of the digestive tract, like chronic and nervous gastritis and in constipation, where it can be applied directly over the colon throughout its entire course. Its local application to rheumatic joints and muscles is a valuable means of treatment in certain forms of torticollis, lumbago, and low forms of chronic arthritis, but most general disorders of nutrition, like gout and diabetes, require exercises of endurance, like walking and riding, with the necessary restrictions to prevent overexertion.

For the myriad derangements and diseases of the nervous system exercise in some of its many forms is constantly employed. In paralysis massage preserves the nutrition of the muscles and prevents contractures by kneading and stretching. Percussion and vibration over nerve-trunks act as a counterirritant, and even as an anesthetic to relieve the pain of neuralgia, while the headache of cerebral congestion may frequently be removed by stripping the great veins of the neck.

Exercises of skill have had triumphant demonstrations in reëducating the impaired coördination of tabetic patients, in correcting the incoherent speech of the stammerer, and in quieting the disordered movements of the unwilling worshippers of St. Vitus.

The tonic effect of active exercise on the system has been referred to frequently and will be referred to again from time to time, but there is one condition where it must be used with the greatest caution.

In anemia the blood is so deficient in oxygen and in red corpuscles that even the easier activities of the muscles require an activity of the heart out of proportion to the effect. This increased action soon reaches its highest possible limit, and the patient has to sit down, breathless and exhausted. Because of this difficulty in supplying a sufficient amount of oxygen anemics should be forbidden all exercise requiring prolonged or severe exertion, and the tonicity of the blood and percentage of hemoglobin must be increased by rest, overfeeding, and the administration of iron and arsenic. It is only in the form of massage that exercise may be safely applied, and then chiefly to prevent the evils arising from overfeeding and rest in bed.

The increased blood-count found by John K. Mitchell, after massage in these cases,¹ is probably to be explained on the same grounds as the experiments of Hawke, described in Chapter II, as loosening the blood-cells already in existence, and throwing them into the circulation, rather than as an actual increase in their number.

In the treatment of pulmonary tuberculosis the place of exercise has been well defined by Kinghorn,² who, after speaking of the open-air treatment and the treatment by rest, advises the patient to begin with walking, at first on level ground, for ten or fifteen minutes, every second day for several weeks, then every day for several weeks, and at last twice a day. He quotes the rule of Brehmer: "The healthy man sits down because he is tired; the consumptive should sit down so as not to become tired." Patients should be told that all overexertion is poison, and that their feelings should be their guides at all times. The acceleration of the pulse, perspiration, palpitation, rise of temperature, feelings of weakness, discomfort, and headache, are all signs that he has overstepped his limit.

When the patient stands these little walks without harm; when the weight increases or holds its own, the exercise may be extended under careful supervision, but mountain-climbing should never be permitted.

In cases where no lesion can be found, but where the tendency is shown by the history of exposure to infection, by family history, or by the formation of the chest, much good may be expected from open-air exercise, accompanied by training of the respiratory powers. Deep breathing is a muscular act capable of education, and the capacity of the lungs or mobility of the thoracic walls can be increased, as well as the strength of any other part of the muscular system, while the general circulation, the skin, the appetite, and the digestion all share in the heightened activity, and healthful sleep is insured by the resultant moderate fatigue.

Exercise for this purpose should be general and special. Singing and elocution lessons are valuable, and the practice on a wind

¹ Solis Cohen, "Physiologic Therapeutics," vol. vii. — "Montreal Med. Jour."

instrument has been recommended. Running and climbing are of the greatest value for increasing the breathing capacity if kept within the limits of fatigue. All exercises should be prescribed in writing, with the most minute directions as to time, frequency, and severity, and a record of the patient's weight should be kept, and frequent examinations made to determine his progress, a loss of weight being followed by a reduction of exercise.

Daily supervised exercises are necessary to increase rapidly the power of chest expansion and vital capacity. They should be directed to a training in the best methods of breathing, to the stretching and developing of the chest and abdominal walls, and should be preceded and followed by accurate measurements and spirometer records. They should include both active, duplicate, and passive movements, but it must be remembered that, however deep the respiratory movement may be, the amount of oxygen absorbed is only in proportion to the need of the body. The oxygen in the blood remains measurably constant, and the only way to increase its absorption by the tissues is to do work that causes the breaking down of oxygen compounds. Deep breathing would result naturally from more demand, but it would not create this demand. Its rôle will be to strengthen the intrinsic and accessory muscles of respiration; to teach the coördination necessary for deep breathing, and to massage the abdominal contents by wider excursions of the diaphragm.

Deep breathing alone repeated a number of times during the day is useful, and its practice should be made part of every day's régime.

The normal respiratory act is a composite of two distinct types of breathing—thoracic and abdominal. The thoracic type predominates almost to the suppression of the other among all, irrespective of sex, who wear constricting clothing about the waist-line, and the first care must be to reëstablish control of the diaphragm and abdominal walls. The following exercises should be practised before a mirror:

Exercise 1.—Patient standing. Place the hands across the abdomen. Inhale deeply. Exhale by pressing on the abdominal

wall, keeping the thorax fixed in the position of inspiration (Fig. 161). Repeat this movement five times slowly with the thoracic



Fig. 161.



Fig. 162. — Inhalation — abdominal. The abdomen is protruded without expanding the thorax.



Fig. 163. — Exhalation — abdominal. The abdomen is indrawn and the breath expelled without contracting the chest.

wall fixed, using the movement of the abdominal walls only. Rest. After a little practice this movement should be done with the hands at the sides.

Exercise II.—Patient standing. Place the hands across the abdomen. Inhale forcibly by pushing out the abdominal walls, keeping the thoracic wall fixed as in expiration. Exhale by drawing in the abdomen.

Repeat five times slowly. Rest. As soon as control has been obtained, practise this exercise with the hands placed behind the back (Figs. 162 and 163).

Exercise III.—Patient standing with the hands across the



Fig. 164.



Fig. 165.

abdomen. Inhale forcibly, using the thorax only, without movement of the abdominal wall. Repeat five times slowly and rest.

As soon as control of the abdominal walls has been obtained, do this exercise with the hands behind the back (Figs. 166 and 167).

Thoracic breathing can be forced still further, and the walls of the chest stretched by using the arms in the following exercise:



Fig. 166.—Thoracic breathing—inhala-
tion.



Fig. 167.—Thoracic breathing—exhala-
tion. The girth of the abdomen remains
unchanged.

Exercise IV.—Patient standing with the arms at the sides. Raise both arms forward (Fig. 164) until they are above the head.



Fig. 168.

inhaling. Hold the breath and stretch upward. Rise on tip-toes (Fig. 165). Lower the arms sideways, pressing backward and exhaling (Fig. 168). Repeat twenty times at the rate of about five to the minute.

Patients will sometimes have a feeling of dizziness and may even stagger and fall at the sudden change of the blood-pressure in the head, but this need cause no alarm.

Exercise V.—Patient standing with the arms at the sides. Raise both arms sideways, pressing back and inhaling (Fig. 169) until they are above the head. Hold the breath and bend forward, keeping the knees straight until the hands touch the floor (Fig. 170). Rise,



Fig. 169.



Fig. 170.

keeping the arms above the head. Lower the arms sideways, pressing backward and exhaling.

Repeat twenty times at the rate of five to the minute.

This exercise compresses the air in the lungs and forces it into the cells that are little used in ordinary breathing.

The following duplicate and passive movements may be employed for increasing the chest mobility and improving the respiration.

Exercise VI.—The patient lying supine on a plinth, with the feet fixed, the arms bent, and the palms up. The surgeon grasps the hand, palm to palm (Fig. 171), and pulls upward, to full extension of the arms, the patient resisting (Fig. 172). The

patient then pulls downward and forward to the first position, the surgeon resisting.



Fig. 171. Artificial respiration. Surgeon pulling up and patient resisting.



Fig. 172. Stretching of the thorax by traction on the arms in the movement of artificial respiration.

Inhale as the arms go up and exhale as they come down.

Exercise VII.—The patient lying supine on a plinth, the lower part of the thorax supported by a roller four inches high, the arms

behind the head, and the chest expanded in inhalation. The surgeon presses on both sides of the lower thorax, directing the patient to exhale (Fig. 173).

Repeat twenty times at the rate of about ten to the minute.

A valuable exercise is that given by Zander's machine, known as the "tower," in which pressure is placed on the back by a



Fig. 173.

cushioned pad and the shoulders are drawn upward and backward rhythmically with the respiration. (See Fig. 38, p. 67.)

Butler, of Brooklyn, has reported many cases of incipient phthisis in which deep breathing has been used as an accessory to overfeeding and rest, with marked improvement in weight and general health; but if the tubercular process is active in the lung, deep breathing will only irritate and aggravate what nature attempts to splint by limiting the movement over the affected area, and in some cases a hemorrhage may be brought on.

In the application of exercise every attendant condition should be made as favorable as possible at all times, to get the best therapeutic results. Fresh air should be supplied in abundance, and treatment should be given in the open air or a well-ventilated room. Many of the disorders of the respiratory tract are due to the impurity, rather than to the temperature, of the air breathed. Regularity

and persistence on the part of the patient are absolutely necessary, and the benefit from half an hour's exercise repeated daily is incomparably greater and surer than an equivalent amount taken at long, irregular intervals. The necessity of constant individual supervision is also recognized by all who have had experience in the giving of treatment by exercise. Every movement should be pushed to its utmost limit of efficiency. Many reported failures can be traced to the lack of intelligent personal direction. It is not sufficient to give the patient a vague outline of a course and leave its carrying out entirely to an assistant, however well trained, for in no department of medicine does the personality of the surgeon count for more. His presence should be an inspiration to his patient, and he should himself insist upon accuracy and precision throughout each movement, however simple it may seem to the casual observer.

CHAPTER XV

FLAT-FOOT AND ITS TREATMENT

THE advantage of the upright position is somewhat offset by the frequency of deformities due to a yielding of the structures concerned with support. The body may yield at the spine, which becomes bent and distorted; at the knee-joints, which knock together (*genu valgus*); or at the arch of the foot, which becomes broken down and flattened, causing the deformity known as *pes planus*, flat-foot, everted foot, or pronated foot.

The bony structure of the foot is arranged in the form of two arches, anteroposterior and lateral. The anteroposterior arch

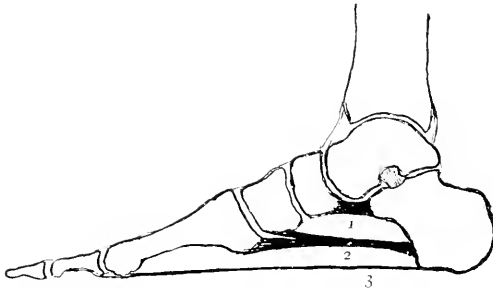

Fig. 174.—Anteroposterior arch: 1, Short plantar ligament; 2, long plantar ligament; 3, plantar fascia.

(Fig. 174) is formed by the *os calcis*, the *scaphoid*, the three *cuneiform* bones, and the *metatarsals*, with the *astragalus* as a keystone. It is supported by the ligaments extending between the adjacent bones like ties, but more especially by the short plantar ligament (Fig. 174, 1) binding from the *os calcis* to the *navicular*. This powerful ligament completes the socket formed

by the navicular and the os calcis, into which fits the head of the astragalus, or keystone of the arch. The other main ligament of support is the long plantar (Fig. 174, 2), which extends from the body of the os calcis to the proximal, and indirectly to the distal, end of the metatarsal bones, through its connection with the tendon-sheaths. These may be termed the first line of defense in preserving the anteroposterior arch.

The second line of defense consists in some of the short muscles of the foot—the flexor brevis digitorum (Fig. 175, 3) and the



Fig. 175. The superficial muscles of the foot: 1, Abductor minimi digiti; 2, abductor hallucis; 3, flexor brevis digitorum; 4, tendon of flexor longus hallucis (Richer).

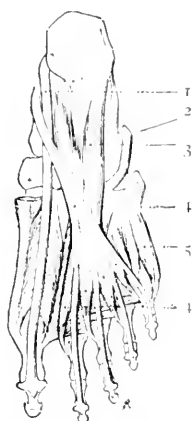

Fig. 176.—Second layer of muscles of foot: 1, Tendon of flexor longus hallucis; 2, tendon of peroneus longus; 3, accessorius; 4, tendon of the flexor longus digitorum and lumbricales; 5, flexor brevis minimi digiti (Richer).

flexor brevis hallucis (Fig. 177, 3)—assisted by the tendons of the flexor longus hallucis (Fig. 175, 4), the flexor longus digitorum (Fig. 176, 4), and of the tibialis posticus, passing around the inner malleolus, and binding together by its expanded tendon all the bones of the tarsus except the astragalus. The tibialis anticus (Fig. 178, 1) also helps by lifting the proximal end of the first metatarsal bone. These muscles, by their action, all tend to lift the inner side of the foot and draw together the limbs of the anteroposterior arch, like the string of a bow.

The lateral arch of the foot (Fig. 179) is imperfect, in that its support is at the outer side only, the weight being borne by the



Fig. 177.—Deep layer of muscles of the foot: 1, Peroneus longus; 2, interossei; 3, flexor brevis hallucis; 4, 5, adductor hallucis (Richer).

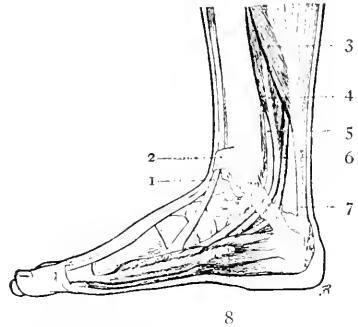

Fig. 178.—The tendons that support the arch: 1, Tibialis anticus passing under annular ligament (2); 3, soleus; 4, flexor longus digitorum; 5, tibialis posticus; 6, flexor longus hallucis; 7, tendo Achilles; 8, abductor hallucis (Richer).

os calcis, the cuboid, and the fifth metatarsal. The arch rises upward and inward, and its free, unsupported edge is represented by the astragalus, the navicular, the internal cuneiform, and the first metatarsal. The lateral arch is supported principally by the tendon of the peroneus longus (Figs. 177, 1; 176, 2), crossing the foot diagonally from the cuboid to the internal cuneiform, and by the ligaments binding together the adjacent bones; it also receives some support from the tibialis anticus.

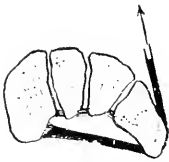

Fig. 179.—Lateral arch. Pull of peroneus longus.

The body weight is transmitted through the tibia to the astragalus. This pressure on the keystone tends to spread the members of the arch, and, in so doing, to stretch the long and short plantar ligaments. As the structures yield the inner side of the foot comes down, and the lateral arch shares in the flattening process. It is,

however, the unsupported part of the arch that is chiefly affected, and the flattened instep also projects inward, causing the inner line of the foot to bulge at its center, the outline becoming convex instead of straight or concave. Pressure is thus put on surfaces of the bone that are not accustomed to it, and severe crippling pain is one of the most common results, while corns and callosities



Fig. 180. —Direction of the body weight on the unsupported part of the lateral arch.



Fig. 181. —Transferring the direction of the body weight to the outer side, or supported part of the arch, by raising the inner side of the shoe.

add their discomfort to the unnatural pressure and friction of the abnormal position.

A typical case of flat-foot would then show a turning-out of the line of the heel, a convexity of the inner contour of the foot, and a concavity of its outer margin. A tracing of the foot would show no instep (Fig. 183). While this deformity is sometimes caused by paralysis of the posterior tibial group of muscles, or by the peroneal group, and is also the result of traumatism in broad

jumpers, whose arch is broken down by the shock of landing on hard ground, still the great majority of cases are what might be termed static, and are found in nurses, clerks, waiters, barbers, motormen, and all others whose long hours of continual standing keep the muscles and ligaments of the foot constantly upon the strain. It is also frequently found in the very fat, whose excessive weight is too much for their ligaments.



Fig. 182.—Flat-foot (Fowler).

It is a comparatively frequent condition, and is usually associated with other deformities of the apparatus concerned in support.

Bernard Roth, in his series of 1000 cases of scoliosis, found it in 76 per cent. of them. In an examination of 1000 supposedly normal students I have found it in 217 cases. Among men

applying for military service in the United States, about 3.4 per cent. are rejected for this cause. These figures, however, do not include men who are suffering from flat-foot, but who are rejected for some major trouble. An applicant suffering from hernia and flat-foot would be rejected, but the cause of his rejection would be given as hernia. Lovett has found many cases among hospital nurses, who are peculiarly susceptible to it.



Fig. 183.—Print of a normal foot-sole (A) and of a flat-foot sole (B) (Albert).

The symptoms are very varied. A considerable degree of flat-foot may be present without causing much irritation, and

again great pain may be caused by comparatively slight degree. Painful points are found at the calcaneonavicular ligament, the anterior end of the os calcis, at the attachment of the short plantar ligament, and at the base of the first metatarsal, while there may be shooting pains up the calf of the leg. The heels, as seen from the back, are characteristic, the line of the tendo Achilles, with the ball of the heel, usually making a sharp turn outward (Fig. 184). This is emphasized when the weight is borne on the foot. It may very often be detected by examining the shoe only, the flat-footed patient tending to wear down the inner side of the heel and sole.



Fig. 184. —Showing one of the first signs of flat-foot. The outward deflection of the lower end of the tendo Achilles when weight is put on the foot. (E. H. Ochsner).

A patient should be examined with the foot uncovered, walking backward and forward in order that the foot may be seen in action from all positions. The inner line of the foot, and the extent to which the instep is destroyed, should be noted.

Cases are best recorded by making a print of the weight-bearing foot as follows: Prepare a solution of perchlorid of iron in glycerin. By means of a brush or cotton-wool wrapped on a small stick paint the sole of the foot with this solution, place the patient's foot on a sheet of paper, having him put the full weight down upon it. Brush the resulting print with a solution of tannic acid, and the tracing becomes black and legible, and forms a convenient means of following the progress of treatment.

The appearance of the foot is not the only thing to be considered, for the arch of a baby's foot has an appearance of flatness, because the pad of fat which occupies the arch is not absorbed until the child has begun to walk.

Flat-foot is liable to be confused with tenosynovitis, the pains from corns and callosities, and with neuralgia of the metatarsus or the tendo Achilles. The most frequent mistake in diagnosis is rheumatism, which seldom affects the foot alone, although I have seen it in one case in which the diagnosis of rheumatism was confirmed by its subsequent appearance in other joints.

Although not a fatal disease, it is the cause of great pain and discomfort, and sometimes the patient becomes chair or bedridden.

Treatment must both support the arch and correct the deformity, so that no treatment is complete which does not develop the structures involved in the normal preservation of the arch.

The market is flooded with patent devices for the support of the broken-down arch, but no mechanical treatment should be employed unless it accurately fits the particular case. More harm than good has been done by the use of ill-fitting and imperfectly supporting foot-plates. A foot-plate or bandage of any kind must be looked upon in the light of a splint, to be discontinued as soon as possible, and to be used only in conjunction with other means of treatment.

In most cases treatment by exercise should be begun by manipulation, stretching, and massaging the foot; but where the pain is too severe, it may be necessary to give the foot a complete rest for two weeks or more by incasing it in a plaster bandage. When tenderness is sufficiently lessened, the following manipulations and active exercises may be started:

Exercise I.—Patient sitting, leg extended and supported just above the ankle. Grasp the right foot just above the ankle with the left hand. Place the right hand on the sole of the foot. With the thumb pointing toward the toes grasp the foot firmly, circumduct the foot slowly in the following order: (1) Extension; (2) inversion; (3) flexion; (4) eversion.

This should be done with as much force as can be used without producing pain, and repeated up to about thirty times. Each part of the movement should be separated from the next by a distinct pause. When this has been learned, it may be replaced by the active movement.



Fig. 185.—Extension of the foot.



Fig. 186.—Inversion of the foot.



Fig. 187.—Flexion of the foot.

Exercise II. Foot in the same position. Circumduction in the same order without assistance. Repeat fifty times.

The operator should supervise this movement and encourage the patient to make the extension and inversion as complete as



Fig. 188.—Eversion of the foot.

possible, so that the long and short flexors and tibial muscles may have complete contractions at each movement (Figs. 185-188).



Fig. 189.



Fig. 190.

Exercise III.—Patient standing with toes in and heels out, and about twelve inches apart (Fig. 189). Rise on the toes and press out slowly (Fig. 190). Repeat fifty times.

Exercise IV. Patient standing, feet parallel and six inches apart. Raise the inner side of the foot, throwing the weight on the outer border. Repeat fifty times.

This transfers the weight from the ligamentous support to the bony ridge of the outer edge of the foot (see Figs. 180 and 181) and should be followed by—

Exercise V.—Patient standing, feet parallel, weight resting on the outer side of the foot (Fig. 191). Walk forward and backward fifty steps, keeping the feet parallel.

This exercise is also valuable in throwing the weight of the body on the solid part of the lateral arch, and is one that is often instinctively taken by patients to relieve the intolerable pain caused by the overstretching of the ligaments.

Exercise VI.—Raise the heel one inch from the ground and walk without bringing the heel down at all, as if the heel were painful.

This exercise may be practised indefinitely, the patient walking for 100 yards without letting down the right heel, and then the next 100 yards without letting down the left, or raising the heels when crossing the street, or other plans that will readily suggest themselves. A little practice will enable him to walk in this way without limping or otherwise attracting attention.

These exercises should be repeated daily, and in slight cases should be carried on for at least three months, whereas in severe cases it should be kept up as a daily routine for at least one year. In favorable cases this may be all that is required (Figs. 192-195), but usually it will have to be combined with some form of specially designed shoe, with strapping or other mechanical support to retain the gain and to prevent the original cause of the deformity from undoing the corrective work of the exercises.



Fig. 191. Walking on the outer sides of the feet.

The shoe should present a straight inner line, allowing perfect freedom to the toes, and high heels should be avoided. An



Fig. 102.—M. March 6.



Fig. 103.—M. April 3. After one month's exercise only.

excellent shoe has been devised by Small, of Boston, in which the rigid shank from the heel to the sole of the shoe is replaced by one that is flexible, allowing free movement to the whole foot and yet

giving adequate support. The inner side of the heel and sole may be thickened, or a cork insole may be made to lift the inner side



Fig. 104.—A. M. November 1. Before beginning treatment.



Fig. 105.—A. M. March 10. After exercise treatment for five months.

of the foot. This places the thrust of the body weight outward toward the supported side of the foot-arch, and lessens the strain on the ligaments.



Fig. 106.—Whitman's plate to support the arch of the foot in flat-foot (Fowler).

Among the many plates designed for the foot, undoubtedly the best is the one described by Royal Whitman (Fig. 106). A

plaster cast of the foot is taken, and an iron plate is fitted to it, with bearing points at the head of the first metatarsal, under the heel, and behind the fifth metatarsal bone. From these bearing points the plate fits into the arch of the instep, and may be trimmed to suit the convenience of the wearer. It is easily removable from the shoe, and does not press upon the foot except when it is bearing the body weight.

A bandage which has proved exceedingly useful in the hands of Ochsner is described by him as follows:

"I first select a good make of zinc oxid adhesive plaster in 12-inch rolls. After measuring the patient's leg I mark off the adhesive strips according to the size of the extremity. For the purpose of strapping a male patient of ordinary size I mark off

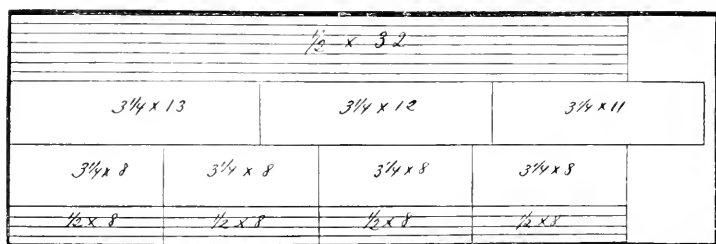

Fig. 107.—Showing how the zinc oxid plaster is marked off preparatory to cutting strips for strapping an adult male patient's foot (E. H. Ochsner).

7 strips $\frac{1}{2}$ inch wide by 32 inches long, with a cross line at its middle; 16 strips $\frac{1}{2}$ inch wide and 18 inches long; 1 piece $3\frac{1}{4}$ inches by 13 inches; 1 piece $3\frac{1}{4}$ inches by 12 inches; 1 piece $3\frac{1}{4}$ by 11; and 4 pieces $3\frac{1}{4}$ inches by 8 (Fig. 107). I do this as a matter of convenience, and in order to prevent the unnecessary handling of adhesive plaster after the facing is once removed.

The heel of the patient's foot is now placed on the chair, with the knee flexed, and a short hard roller bandage is looped around the foot. I direct the patient to draw the foot upward, thus placing the foot at a little less than a right angle to the leg, moderately inverted and adducted, the patient holding the bandage himself.

I now put the middle of the $32 \times \frac{1}{2}$ inch strip over the bottom of the heel, about one inch from its posterior border, one half up the

outer surface of the leg, without tension, and the other up the inner surface of the leg, as tight as I can. I then place one of the shorter narrow strips on the inner surface of the foot, parallel with the sole, and on the outer surface. The remaining narrow strips are placed in the same manner, each one slightly overlapping its predecessor. When these are all in place, I cover them with the 7 remaining strips, beginning at the upper part of the leg, as illustrated in Fig. 198. These strips will remain in place and be effective from four to eight weeks, when they may be removed with benzine. The foot is washed with soap and warm water, carefully dried, and it is again restrapped the following day. A foot may require from two to ten strappings, and the relief is almost immediate. This strapping tends to supinate the foot and relieve the pain by relaxing the muscles and supporting the ligaments."

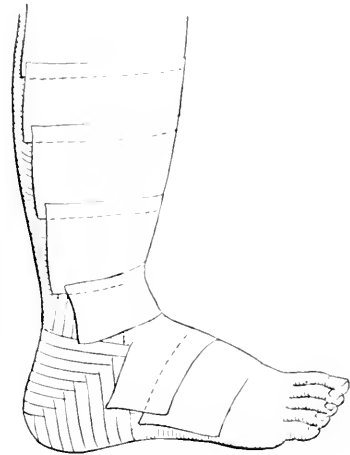

Fig. 198.—Showing arrangement of the $3\frac{1}{2}$ -inch strips over the narrower strips (E. H. Ochsner).

I have quoted this at length, because the best results can be obtained by a combination of this treatment with exercise. From the perishable character of the plaster, one is less apt to depend upon it alone, as is so frequently done with the metal flat foot supports, while the danger of injury to the foot from bruising and formation of callosities arising from the use of plates unskillfully applied is completely avoided.

A flat-foot plate or bandage must, as already emphasized, be regarded in the same light as a crutch or cane would be for a joint unable to bear the strain of use, and it is to be discarded when the normal strength has returned and undue irritability has disappeared.

To continue the support after the indications for its use have disappeared is to hamper the normal functioning of the muscles and ligaments of the foot and leg.

CHAPTER XVI

THE CAUSE AND TREATMENT OF ROUND BACK, STOOPED, AND UNEVEN SHOULDERS

If an infant be placed upon its back, it will lie with a straight spine and thighs flexed to nearly 90 degrees. If it be placed in a sitting posture, the thighs remain flexed, but the spine shows a single convex backward curve, involving its entire length, but with the assumption of the standing posture, the right angle between the trunk and thighs must be extended to a straight line, and this is effected by a compromise between the lumbar spine and the hip-joint, both yielding part of the way.

When the hip-joint is extended, the iliopsoas muscle is stretched, though this extension is not sufficient to preserve the straight spine of the sitting posture. A sharp, forward curve develops in the lumbar region. The anterior vertebral ligaments are stretched, the intervertebral discs thicken anteriorly, and the erector spinæ muscle becomes active and powerful. This curve, which is very marked in young children, gives them their characteristic "pot-bellied" appearance, and is accompanied by a localization of the compensating backward curve to the dorsal region, and by the formation of a third in the cervical region, showing the same forward convexity as the lumbar curve. These three curves are physiologic, and are always found in the adult normal spine, and it is their exaggeration or imperfect development that will be considered in this chapter.

The shoulder-girdle is constructed to permit the widest range of movement with the utmost lightness of structure, but the pelvic girdle, whose chief office is that of support, is firm and arch-like, with powerful ligaments, heavy bones, and scarcely perceptible movement, while the entire weight of the head, neck,

upper extremities, and shoulders hangs upon the flexible and growing spine during the standing and sitting positions, and the muscles that steady the spinal column rapidly become fatigued when thus kept on the strain, and allow the shoulders to droop forward, bending the neck and back with them. The resulting deformity is called stoop shoulders, slant shoulders, round back, faulty attitude, kyphosis, or bowed back, and when the deviation is to the side, either right or left, it is known as scoliosis or lateral curvature.

The condition of round shoulders can be determined only after the normal standing attitude is clearly defined in the mind, and deviations from this normal attitude can then be noted and accurately described. Anteroposterior deformities may be classified as round back, round hollow back, and forward displacement of the shoulders (Lovett).

In the normal standing position a plumb-line will touch the sacrum and the dorsal spine at its greatest projection. This, however, does not give the attitude of the head, which is most important. This can be obtained by taking an upright rod, such as is used for measuring the height. On this is a sliding horizontal arm at right angles to it. On this arm, six inches from the back surface of the upright rod, another horizontal rod is attached, eighteen inches in length, and extending at right angles to the arm. The back surface of the upright rod is taken as the perpendicular plane from which distances are to be noted, and the measurements are made from the second horizontal rod, which is always six inches away from the plane of the upright. Any point more than six inches from the sliding horizontal arm is in front of the perpendicular plane agreed on, and any point less than six inches is behind it. To obtain the measurements, the following points are marked with a flesh-pencil: (1) The external malleolus; (2) the head of the fibula; (3) the great trochanter; (4) the fourth lumbar spine; (5) the seventh dorsal spine; (6) the spine of the vertebra prominens; and (7) the middle of the mastoid process. These points having been marked, the patient stands with the malleolus opposite the upright, and each of these points from the horizontal arm is rapidly noted from above downward. The

height of each of these points is then noted, and from this data the posture can be graphically shown.

A composite of 72 normal boys (Greenwood) between the ages of fifteen and nineteen years shows the following tracing (Fig. 200).

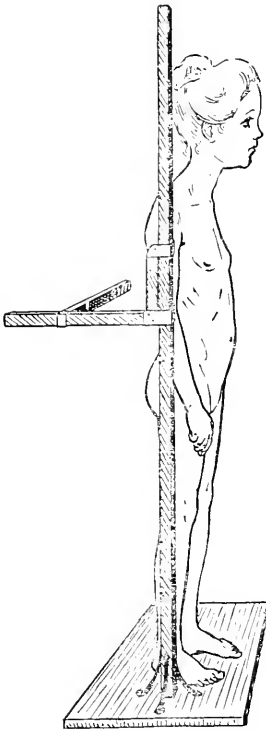

Fig. 160. Lovett's apparatus for measuring variations from normal attitude in the anteroposterior plane.

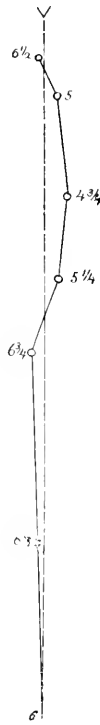

Fig. 200.—Composite curve of seventy-two normal boys (Greenwood).



Fig. 201.—Curve of young adult female of good carriage (Lovett).

By means of this standard we are enabled to divide faulty attitudes into—(1) Round back, showing a general curve backward, with little lordosis. (2) Round hollow back, with the backward projection greatest in the middorsal region, and with pronounced lordosis, the forward projection of the head bringing

the upper three measurements almost in line. (3) Forward displacement of the shoulders, the scapulae and clavicles being displaced independently of the condition of the spine. This condition may exist either with or without a rounded back. A graphic tracing of these curves may also be obtained by the pantograph method described in the following chapter.



Fig. 202. -Making a tracing of the antero-posterior curves of the spine by the pantograph method.

From the standpoint of treatment these deformities may be classified into flexible and resistant.

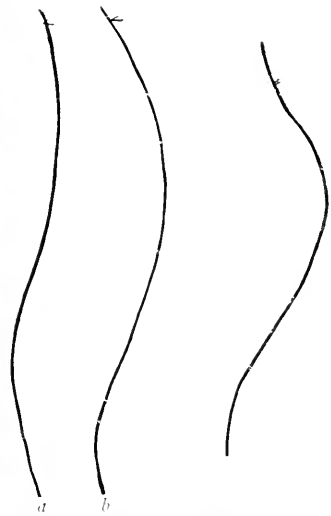

Fig. 203. -Anteroposterior tracings of the spine: *a*, Correct posture; *b*, first type of round back; *c*, extreme resistant round back in a young girl.

During the years of growth posture will usually take care of itself if constant change be allowed, for change is instinctive and automatic in the child, and his varied activities may be trusted to lead him along normal lines. If, from inherent weakness or the confinement of school life without the relief of games and

play, this normal development be hindered, the spine is one of the first parts of the anatomy to reveal it.

The causes of round shoulders are, then, those general conditions that produce muscular or constitutional weakness, like rapid growth, overwork, bad air in schools or home, acute illness, myopia uncorrected by glasses, poor hygiene at home, or general lack of exercise, and, secondly, occupations that demand long-continued flexion during the period of growth. Among these may be mentioned the use of ill-fitting school furniture, long-continued writing and drafting or work with the microscope; in fact, the requirement of any fixed position for more than a few minutes at a time in a young child. His restlessness in school is his only means of protest, and is the object of much misapplied correction by those school-teachers who believe that quietness and goodness are synonymous. The third cause, more direct than either of the others, is the wearing of clothing supported by suspenders bearing on the points of the shoulders, tending to pull them downward and forward or even to produce a painful deformity of the scapula.

An examination of the back should begin by testing the spine's range of movement, forward, backward, and lateral. The patient should then take his habitual standing position, which he should retain until his self-consciousness abates. The overcorrected standing posture should then be tried. This may be done by having him force the chest forward and upward to touch the surgeon's hand, held just far enough in front of and parallel to the chest-wall to bring the contour of the thorax directly above that of the abdomen. This maneuver should always be done before a mirror, that the patient may associate the sensation with the picture of the correct posture, and it will take time and patience on the part of both. He should then be taught to take several long breaths without relaxing the pose. If the child be placed face downward, with the arms at right angles to the body, flexibility of the shoulders can be tested by attempting to force them back of the middle line of the body. They should then be lifted upward beside the head and forced backward. During these movements the whole spine should be narrowly observed,

as in resistant cases the arms cannot be brought behind or even up to the median plane of the body. It can only be simulated by hollowing the lower part of the back and protruding the abdomen, flattening the chest, and projecting the chin. In non-resistant cases there is usually a general relaxation of the ligaments, as shown in hyperextension of the elbows and knees, as well as of the spinal ligaments, and if the patient can voluntarily assume a correct position, the case may be pronounced non-resistant. In resistant round shoulders and forward displacement, however, there is always more or less structural change, involving a forward curvature of the upper part of the scapula, a shortening of the coraco-acromial ligament, or, according to Fitz, a tightness of the serratus magnus muscles, associated with weakness of the rhomboids and trapezius.

It is a very frequent deformity among school-children, and it occurs in almost 20 per cent. of university students uncomplicated with other postural defects. Where a greater deviation is present, such as lateral curvature, a note is usually made of the scoliosis only, so that its occurrence is more frequent than these figures would indicate.

It is frequently discovered in girls about the age of puberty, when especial attention is apt to be paid to their figure and carriage.



Fig. 204.—Showing a common under-waist with the straps bearing upon the outer part or movable part of the shoulders (Goldthwait).

Round shoulders are not likely to be outgrown, and patients usually become permanently and structurally set in the faulty position, with flattened chest-walls and distorted figure.

By adequate treatment all cases are capable of improvement, and almost all, except the most resistant, are capable of complete cure. Before beginning treatment it is important to differentiate between the flexible and the resistant cases and between both and arthritis, where pain is usually a prominent symptom. An irritated spine must also be excluded, as well as the early stage of

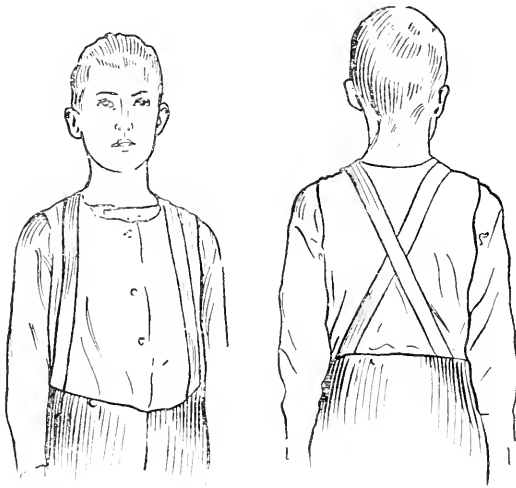

Fig. 205.—Correct support of clothing. The weight comes on the root of the neck instead of the shoulder tips (Goldthwait).

Pott's disease, so that any case of sore spine before being treated by exercise should undergo a rigid examination, and be kept for some time under careful observation.

Treatment may be divided into—(1) Hygienic; (2) exercise; (3) stretching.

(1) *Hygienic*.—The patient should have the best available surroundings as to light, air, and food, because, as a rule, they are underdeveloped muscularly and have not the constitutional resistance nor the will-power of the average child. The muscle

fatigue that comes on from the strained, fixed positions among school-children must be avoided by every available means. School furniture should be adjusted to prevent undue flexion of the back and forward bending of the head during reading and writing. Errors of refraction should be corrected. The clothing should be examined, and when found to be supported from the tip of the shoulders, the garments should be altered to bring the pressure in toward the root of the neck, instead of out on the shoulders.



Fig. 256.—Correct standing posture. Fig. 257.—Incorrect standing posture.

(2) *Exercise.* In the treatment by exercise, expansion of the lungs by deep breathing to round out the flattened chest should be emphasized. These exercises have been described in Chapter XIV. The correct standing position and carriage of the body should be continually and persistently insisted upon. This must not be done by contracting the retractors of the shoulders, but rather by bringing in the chin and forcing the thorax forward and upward (Fig. 256), as already described. The muscles of the

upper back must be strengthened to carry out their function of support, and the abdominal muscles must be developed and trained to overcome the weak and relaxed carriage of the protuberant belly. The following exercises would constitute a daily prescription:

Exercise I.—Patient standing in his habitual faulty position (Fig. 208). Place the hand about one inch in front of the sternum, and tell him to raise the chest and shove it forward to touch the



Fig. 208.—Diagram showing the relation of the head, thorax, and pelvis in the incorrect standing position.



Fig. 200.—Diagram showing the relation of the head, thorax, and pelvis in the correct standing position.

hand without swaying the body. In doing this at first he will try to draw the shoulders back, contracting the trapezius and rhomboids. This fault must be overcome at the very beginning, and the shoulder muscles must be kept relaxed. Gradually increase the distance to which he can bring the chest forward, repeating it again and again until he can take the position without difficulty and without contracting the muscles of the back. While in this position make him breathe deeply five times and then relax. This should be done before a mirror, so that he will recognize the

feeling of the correct posture and associate it with the proper attitude, as seen in the glass. He should then try to take it without looking at the mirror. This posture should be drilled into him until it becomes habitual, and until he can maintain it without discomfort.

R. J. Roberts, of Boston, is accustomed to tell his young men to press the back of their neck against their collar-button, considering this as the keynote of the position. In whatever way it



Fig. 210.



Fig. 211.

is accomplished, the object is to get the proper relation between the thorax and the pelvis.

After repeating Exercise 1 twenty times take Exercise 2.

Exercise II.— Arms forward raise, upward stretch, rise on tip-toe, inhale. Sideways lower, slowly press the arms back. Exhale (Figs. 164, 165-168).

This exercise, when done correctly, expands the chest, bringing in all the extensors of the back and the levators of the shoulders.

Exercise III.—Patient standing, arms down and back, fingers interlocked and palms outward (Fig. 210). Extend the neck, roll the shoulders back and forearms into supination, the palms being first in, then down, and then out (Fig. 211). Reverse to starting position and relax.

This exercise is particularly valuable for projecting the chest forward, stretching the shortened ligaments, and drawing in the abdomen. Care should be taken to have the chin pressed backward when the arms are brought downward and turned outward. In resistant cases, where this exercise cannot be done with the fingers interlocked, a handkerchief tied in a loop may be substituted and held in the fingers. (See Fig. 270.)

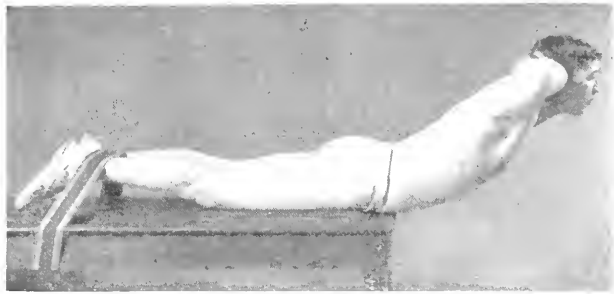

FIG. 212.

Exercise IV.—Patient standing with the arms at the sides. Arms sideways, raise, upward stretch, inhale, forward bend, and rise. Arms sideways lower. Exhale. (See Figs. 160 and 170.)

In this exercise the lungs are filled when the chest is in the most favorable position for expansion. The breath is retained when the trunk is flexed, forcing the air into the cells of the lungs under pressure. The bending and rising bring into powerful action the extensors of the back and neck and the retractors of the shoulders.

Exercise V.—Patient lying prone upon a couch with the feet strapped or fixed by an assistant. Hands clasped behind the head. Raise the head and extend the spine, pressing the elbows backward (Fig. 212). Relax.

This exercise is a severe one on the extensors of the back and the retractors of the shoulders.

Exercise VI. Patient lying in a prone position, arms at the sides. Raise the head (Fig. 214), bringing the arms forward (Fig. 215). Imitate the breast stroke in swimming (Fig. 216).

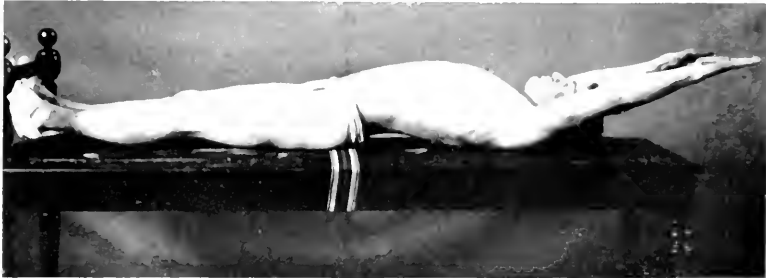

Fig. 213.—Deep breathing exercise—introduced between two extension movements.

In this exercise the erector spinae is kept in static contraction, while the retractors of the shoulder are alternately contracted and relaxed.



Fig. 214.

Stretching exercises that require the services of an assistant or a machine designed for the purpose should be associated with these voluntary movements. Sylvester's method of artificial respiration (Figs. 171 and 172) may be employed with good effect, the upper dorsal region being supported by a hard pillow, the

surgeon pulling at the end of the upper movement, stretching the thorax to its utmost. The intercostal machine (Fig. 217) is invaluable for securing the same kind of movement. Zander's machine, the "tower" (Fig. 38, p. 67), straps the shoulder backward



Fig. 215.

and forces forward the rest of the body, imitating closely the movement and rhythm of ordinary respiration. The quarter-circle (Fig. 29, p. 60) is another gymnastic machine designed to give breathing exercises, with the body held in an overcorrected



Fig. 216.

position. Taylor's "spinal assistant" (Fig. 218) produces the same effect by suspending the weight from the arms with accented pressure on the dorsal region, either from behind, forward, or laterally, as shown in the illustration.

G. W. Fitz, as a result of an exhaustive investigation, came to the conclusion that the pectoral muscles were not guilty of causing round shoulders, as had been previously supposed, and condemns those stretching movements in which the body-weight is carried by the hands as having but little effect on the serratus magnus, which he considers to be the muscle chiefly at fault.



Fig. 217.—Triplicate chest weight, overhead or intercostal attachment.

The main value of these stretching movements is, however, on the ligaments, rather than on the muscles.

In slight cases of round shoulders the strapping described by Goldthwait, to draw the shoulders backward, is of real value. It is composed of firm webbing, one inch wide, carried as a loop around each shoulder, the bands crossing in the back and being attached to the belt of an ordinary stocking supporter. The attachment of the shoulder strap to the belt should be at the side,

directly over the stocking straps, and the belt should be worn about the hips and not about the waist, as is usual. The straps should be sewed where they cross at the back, over the angles of the scapulae, but should not be sewed where they cross in the mid-line. This allows body movements, both to the side and forward, without straining upon the straps or changing the position of the belt level.

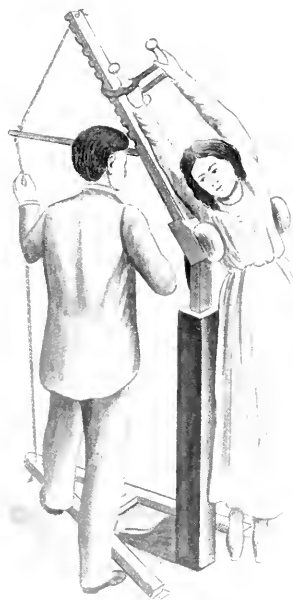

Fig. 218.—Taylor's spinal assistant for suspension and lateral pressure

For more resistant cases, where very active stretching is necessary, Lovett's apparatus is the best. It consists of an oblong gas-pipe frame. Hinged to this, near the middle, is another section of gas-pipe of the same shape and size as the upper half of the frame. To this movable section is fastened at right angles a gas-pipe bridge rising about eighteen inches above it and movable on it (Fig. 216). When prepared for use, two strips of webbing lying one over the other run from each of the two buckles at the

bottom end of the frame. The lower pair are tightly drawn and run through buckles at the upper end of the movable section. The upper two are loosely fastened to the bridge. The patient is laid face downward on the webbing strips, protected by a piece of sheet-wadding if uncomfortable. The thighs are flexed and

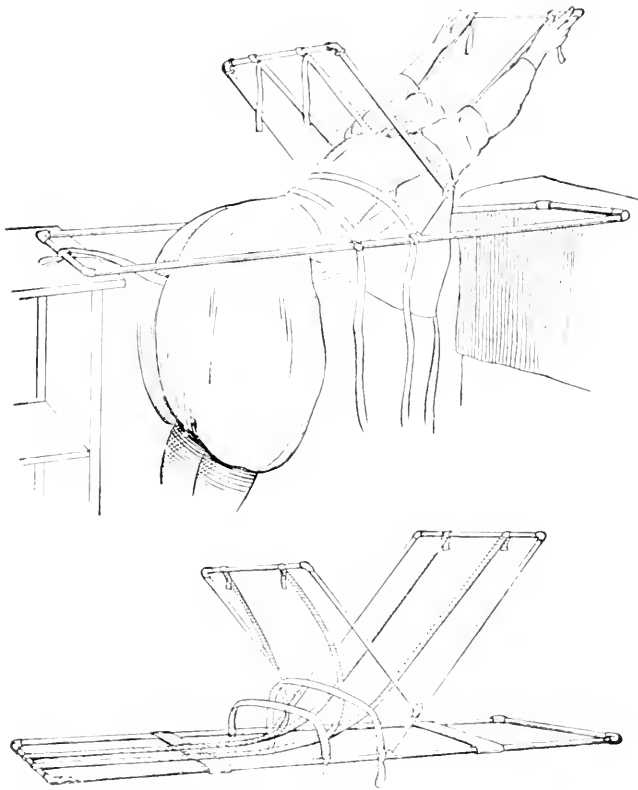

Fig. 210. —Apparatus for stretching round shoulders (modified from Lovett)

the feet rest on the floor, so that the lumbar spine is flattened. Two pieces of webbing are placed over the middorsal region from side to side, tied to the lower non movable frame on each side, thus furnishing the resistance for the straightening of the spine when the upper end of the movable frame is raised, carrying with

it the head and upper chest. After the patient is in place, the upper part of the frame is lifted, the amount of force permissible being not beyond the point of mild discomfort. Several stretchings are made of a few seconds each, the movable part of the frame being let down to rest the patient.

Flexible round shoulders in most cases yield to exercise alone, extending over a period of three to six months of daily treatment, but it may be advisable to maintain the improvement for a time by means of some such simple brace as the one described by Goldthwait, although fixation without exercise is irrational and leaves the condition worse than it found it. Some resistant cases will require stretching by the Lovett apparatus and fixation in the corrected position, combined with vigorous development of the muscles of the back and prolonged training in the corrected standing position.

Occasional cases in which there is structural deformity have been treated by cutting the coraco-acromial ligament, or an operation on the deformed scapula, as described by Goldthwait, but such cases are the exception and need not enter into the discussion.

After active treatment has ceased, the patient should be kept under supervision, reporting progress at least once a month for two years.

It is the rule, rather than the exception, to find associated with round shoulders some inequality in their height. In 1000 consecutive examinations of supposedly normal young men, the right shoulder was low in 140 cases and the left low in 20 cases, and tailors tell me that it is almost the rule to put extra padding in the right shoulder of coats for the sake of appearance.

The causes of an irregularity varying from three-fourths to two inches are sometimes difficult to disentangle, but the carrying of weights, like school-books, and bad habits in sitting and standing are among the most potent. The position of the child sitting at the school desk during writing favors it, since the left arm and shoulder are supported and the right lowered. Habitual standing with the weight on the right leg contributes to a good many cases.

as will be seen in the description of scoliosis, but weights carried in the hand or pressure on the right shoulder are the most direct, and it is a common thing to see this deformity in soldiers after carrying the rifle and bandolier during long marches. Fig. 220 shows a man, otherwise powerful, symmetric and well developed, who acquired it in two years' active military service in South Africa, during which he had to make long marches with his rifle and cartridge belt pressing down on the right shoulder.

The great specialization of some games in which the right arm is almost exclusively used is blamed for many cases. Fencing, baseball pitching, and putting the shot are ready examples.

In response to an inquiry sent to 21 men who had the left lowered only, 3 acknowledged to left-handedness.

The patient placed before a mirror can almost always assume the correct standing posture by voluntary muscular effort, but to him it does not feel normal or natural, and he quickly relapses if left to himself.

In all straight and symmetric exercises the weaker side will get more work than the stronger, so that movements described for flat chest and round shoulders, all of which bring in equally the muscles of both sides, would be of some value in these cases. It is necessary, in addition to this, to develop the upper part of the trapezius, the rhomboids, and the deltoid of the lowered side, and the latissimus dorsi and inferior part of the pectorals on the opposite side, and for this purpose the following exercises should be given for a lowered right shoulder:

Exercise I. Position, standing, arms down at the side. Right arm forward raise; inhale (Fig. 221); rise on the tip toes; stretch;



Fig. 222. Lowering of the right shoulder from carrying a rifle and pressure of a bandolier for two years.

sideways lower; exhale. The left arm should be shoved downward while the right arm is raised.

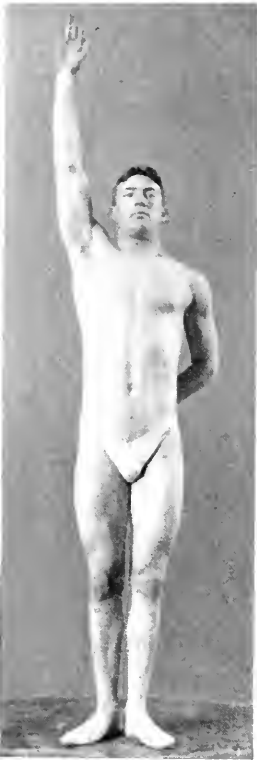

Fig. 221.

This exercise brings into action the upper part of the trapezius, deltoid, rhomboids, and serratus magnus of the right side, and the latissimus dorsi and lower part of the pectoralis major on the left.

Exercise II.—Position, standing, arms down. Right arm sideways raise; inhale; forward bend (Fig. 222); upward stretch; arm sideways lower; exhale.



Fig. 222.

This exercise has the same effect as the first, with the additional advantage of stretching the right side of the trunk more than the left, as the body is bent forward.

Exercise III.—Position, prone, lying on plinth, right arm elevated, left arm forced downward. Extend the neck and back; relax (Fig. 224).

Exercise IV.—Position, back to the chest weight, floor attachment; raise and lower the right arm (Fig. 223). This brings into action the right deltoid; the upper part of the trapezius; the rhomboids, and the serratus magnus of the right side.



Fig. 223.

Exercise V.—Shrugging the right shoulder while holding a dumb-bell of 40 or 50 pounds (Figs. 225 and 226) has the contrary



Fig. 224.

effect from continually holding the weight and keeping the muscles in tension. The intermittent contraction and relaxation of the muscles tend to strengthen and develop them, and so make them

shorter when at rest, while continuous tension rapidly stretches them and destroys their tonicity.

The putting up of a light dumb-bell, five or ten pounds, from the floor to arms' length above the head, is another valuable exercise (Fig. 227).

The nautical wheel (Fig. 34, p. 63) turned counter-clockwise also will help to raise a lowered right shoulder.



Fig. 225.



Fig. 226.



Fig. 227.

Hanging exercises, in which the weight is borne by the right arm with counter-pressure on the left side, are of slight assistance in stretching the latissimus dorsi on the right side, but do not affect the upper part of the trapezius or the serratus magnus, both of which are relaxed in this position.

The prognosis is good in all cases if these exercises be followed persistently and faithfully in the form of a daily prescription for three to six months. Most of the failures are caused by the carelessness of both surgeon and patient and by the readiness of the tailor to act as their accomplice.

CHAPTER XVII

SCOLIOSIS—ITS CAUSES, VARIETIES, DIAGNOSIS, AND PROGNOSIS

WHEN the child begins to walk, the general direction of the infantile spine is changed, as described in the previous chapter, and the three normal forward and backward curves soon develop. Not only may there be undue exaggeration or suppression of these curves, as already shown, but during growth lateral deviations may also occur to overstretch the supporting muscles and ligaments, and even to distort the vertebrae themselves while in their plastic state.

The integrity of the spine is protected against the onset of deformity by three lines of defense of increasing strength: (1) the muscles forming an advanced mobile series of outposts brought into service, in relays, powerfully but intermittently; (2) the ligaments more resistant, but less mobile, requiring long-continued and persistent attacks to overcome their normal protective action; (3) the bones, which may be compared to the citadel, yielding to the influence of deformity only after the other two lines of defense have long since been carried. When they have adapted themselves to the deformity and have become set in their distortion, treatment can hope to be, at best, only cosmetic in character, to conceal the deformity rather than to correct it.

The muscles acting upon the spinal column fall naturally into three groups: (1) The anterovertebral, consisting of the psoas in the lumbar region, the three scaleni, the longus colli, and the sternomastoid in the cervical; (2) the spinoscapular in two layers; the trapezius and latissimus dorsi superficially, and the rhomboids and levator anguli scapulae beneath them; (3) the spinal, consisting of the two posterior serrati, superior and inferior, and the

erector spine mass, thick and fleshy in the lumbar and cervical regions, but thin and tendinous in the dorsal.

Some of the deeper muscles well developed in the cervical and lumbar regions become ligamentous in the dorsal, illustrating the



Fig. 228.—The anterovertebral muscles, showing the iliopsoas and quadratus lumborum in the lumbar region, and in the cervical the longus colli, the scalenus anticus medius and posticus on the right, and the sternomastoid on the left.

principle of regression, and this is significant of the relative amount of movement in the three regions.

Movements of the spine are flexion, extension, side bending, and torsion.

Flexion takes place mostly in the lumbar and cervical regions, the dorsal backward convex curve being accentuated but slightly.

Extension is almost entirely in the lumbar and cervical regions, even in backward contortionists, who can place the head on the hips, the dorsal region remaining comparatively fixed (Fig. 231). In side bending from the flexed position of the spine the lumbar



Fig. 220.—The superficial and deep layers of the spinoscapular muscles; on the right the latissimus dorsi and trapezius, on the left the rhomboideus major and minor and the levator anguli scapulae.

region is locked, and the movement is in the dorsal region more than lower down. It is accompanied by rotation of the bodies of the dorsal vertebrae to the convex side of the lateral curve. Side bending from the position of extreme extension takes place in the lumbar region almost entirely, the dorsal vertebrae being locked.

Rotation of the bodies of the lumbar vertebrae is to the concave side of the lateral curve.

Torsion in the erect position is greatest in the cervical region, gradually disappearing through the dorsal. In the lumbar region

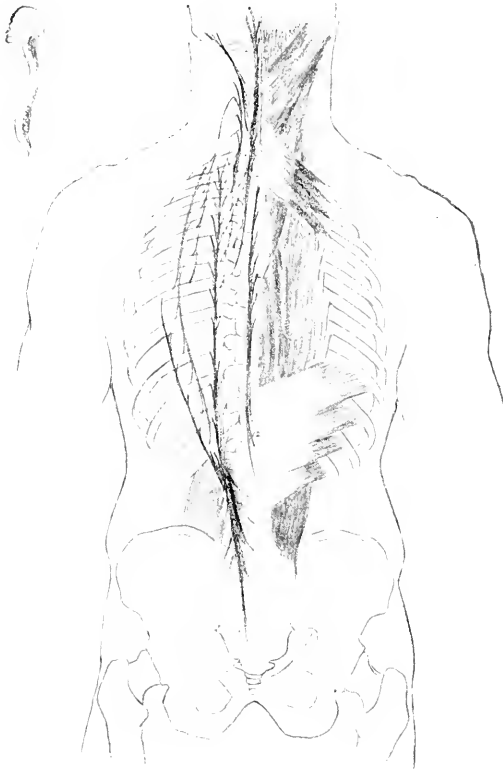

FIG. 230.—The erector spinae covered by the serrati postici, superior and inferior. On the left the attachments are shown diagrammatically

it is diminished by flexion or extension and is slight, even in the erect position.

The most freely movable regions are most abundantly provided with muscles, and it is to the analysis and application of their action that treatment of deviations by exercise must be directed.

The frequency of scoliosis among children and youths may be gathered from the fact that in an examination of 122 high-school boys entered for an athletic meet I found it in 32 cases, or 19 per cent. In an examination of 446 athletic college students it was found in 19 per cent. In another series of 200 college students it was well marked in over 8 per cent., and slight in an additional 16 per cent. In a girls' high-school, out of 160 examinations, it was found in 31 cases, or 19 per cent., accompanied by severe backache in 17 cases. The figures of other observers, like Guillam, Krug, Hagman, Kalback, Schotter, Eulenberg, Roth, and Whitman, give an average of about 27 per cent. among school-children



Fig. 231. -In overextension of the spine the bending takes place principally at the neck and loins (Dwight).

and place the period of greatest frequency between the ages of seven and fourteen.

The causes of scoliosis are both congenital and acquired. Among them may be mentioned wry-neck, defective hearing and vision, asymmetry (Figs. 232 and 233) or faulty development of the bones, like rickets, dislocation of the hip, arthritis, and uneven development of the lower extremities from joint disease or other causes. Astigmatism has been given a large place in the causation of scoliosis by Gould, who has well described the tilting of the head in such cases, particularly when reading or writ-

ing. His experience has been confirmed in case reports quoted by Rogers.¹

"Case I.—October 7, 1901, H. H., aged seventeen, Ameri-

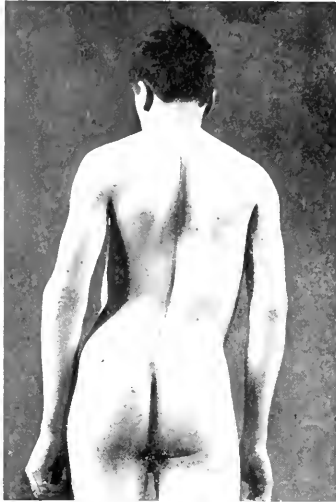

Fig. 232.—Lateral curvature from uneven extremities and deformed pelvis. The black spots mark the posterior superior spine of the ilium.

can school-girl, complained of pain through eyes and head, extending down the back, and aggravated by study. Some months previously her physician noticed a lateral curvature of the spine, and an attempt had been made to correct this deformity by the daily use of calisthenics. She was wearing glasses given her by an optician, O. D. - 0.50 C. 90 - O. S. + 0.75 C. 90°, and with them got 0.7 vision,



Fig. 233.—The result of raising the foot three inches to bring the spines of the ilium to the same level

¹ "Journal of the American Medical Association," July 20, 1907.

but there was noted at once a tendency to tilt the head to one side when using them. After examination under a mydriatic she was ordered O. D. + 1.0 () 0.50 C. 75°; O. S. + 0.50 () 1.0 C. 100° for constant wear.

“April 19, 1902: The patient had improved greatly, the asthenopia was gone, and the spinal defect was not noticeable.



Fig. 234.—Showing tilting of head due to astigmatism and producing spinal deformity (Gould).

The gymnastic exercise had, however, been continued, and the beneficial result was attributed to this alone.”

It is to bad posture, long continued, in standing, sitting, and

lying, joined with the carrying of weights in the hands or suspended from the shoulder, that we must look for the origin of the vast majority of cases, which may be classed under the general heading of the *scoliosis of fatigue*.

A frequent fault in the standing posture is the habitual employment of one leg, usually the right one, as a base, the other foot being used as a prop (Fig. 235). This pro-



Fig. 235.—Lowering of the right shoulder from resting the weight on the right leg. One way in which a C curve begins.



Fig. 236.—Pose from an antique statue of a boy illustrating the attitude of rest with the weight on the right foot. The right hip projected and right shoulder lowered, forming a C curve.

duces a C-shaped curve with marked lowering of the right shoulder and prominence of the right hip. Many children assume this position, in which the strain is borne by the ligaments of the hip and spine for long periods, and feel uncomfortable when the weight is transferred to the other foot.

Such cases are nearly always accompanied by rounding of the shoulders, flattening of the chest, protrusion of the abdomen, and rotation of the vertebrae, all signs of muscular fatigue and ligamentous strain.

The sitting posture is beset with possibilities for deformity. The common habit of sitting with one foot tucked up on the seat is responsible for some cases, but, above all, the compulsory holding of any fixed position for long periods of time. We know that if we hold the arm out at right angles the pain and fatigue soon become intolerable, and few can stand the strain so long as five minutes. The greatest strain falls upon the deltoid, which has no relief from continuous action. The same condition occurs in the back and shoulders of the school-child forced to remain sitting for any unusual length of time.

The complicated system of spinal muscles, by working in relays, postpones fatigue very considerably, the slightest change of movement bringing into action a new set and relieving the tired ones, and this constant desire for rest by movement is the most striking quality of all young animal life.

With the beginning of school-life the child is made to sit from three to six hours with but momentary rests at long intervals, and the resultant restlessness must be suppressed by the teacher for the sake of discipline. The rapid fatigue of the undeveloped muscles and the irregular compression of the growing bones go far to fix the faulty posture, especially in those who are weak and delicate. The process of collapse and tiring of the spinal muscles during writing is well described by Fahrner:

“Before writing begins children sit perfectly upright with both scapulae thrown back equally. As soon as writing begins all children move their heads slightly forward and to the left. Soon head after head drops from the rapid fatigue of the neck muscles. In a short time the back also collapses, so as to hang from the shoulder-blades supported by the upper arm. Then two distinct types of posture are seen. Those writing on the upper part of the page support themselves upon the desk, and the rounded back curves forward. The eyes are three or four inches distant from

the desk, and the support is from three points—the left elbow, the chest, and the right forearm slightly. When at the bottom of the paper, they lose their third support and have the left elbow alone. Add to this a twisting or skewing of the back toward the right. The head is bent toward the left shoulder, and the eyes brought within six inches of the paper. The onset of this deformity is hastened by mental fatigue, which is faithfully reflected in the posture, the face, and the general listlessness of the child.”

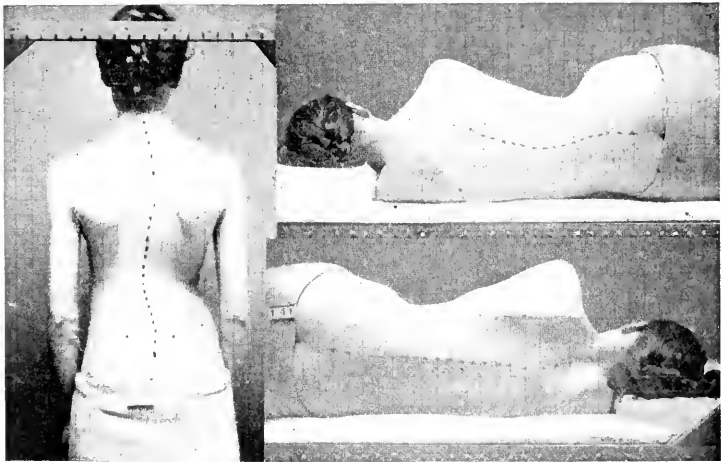

Fig. 237.—A double curvature encouraged by bed-posture, as seen in the upper picture, and corrected by turning over on the other side (Fitz).

The influence of a bad sleeping posture in the causation of curvature has been well pointed out by G. W. Fitz, Boston (Fig. 237). The hips and shoulders, being the broadest part of the trunk, serve as points of support, and leave the middle portion of the body suspended between them, and as the period of sleep occupies one-half to one-third of the child's growing time, this influence is of importance. Observations on the attitude of 320 healthy sleeping children (156 boys and 164 girls), made by Dr. E. G. Brackett, showed that about 20 per cent. more lie on the right than on the left side, while more lie on the back than on

either side. These figures were confirmed by Hare, but the greater frequency of the lying position on the right side is partly explained by the fact that the boys observed were all required to lie upon the right side when they went to bed to prevent conversation. Two hours later they had turned on the face, the back, or the left side.

As will be seen by the illustration a patient with left convex curve in the lower dorsal region should not lie habitually upon the left side.



Fig. 238.—Straight spine with even support of the pelvis.



Fig. 239.—S curve caused by uneven support of the pelvis in a normal individual.

Curvature may begin at either end of the spinal column, the most flexible parts being in the lumbar and cervical regions. If it begins in the cervical region, from torticollis or from eye defects, as pointed out by Gould, other curves will be secondary, while if the curvature begins in the lumbar region, from unequal support of the pelvis, either in sitting or standing, the dorsal curvature will again be secondary. An S-shaped curve can be produced experimentally by raising the left side of the seat to tilt the pelvis, making a lumbar curve with the convexity to the right, and a compensating curve in the opposite direction (Figs. 238, 239).

Scoliosis is frequently found in more than one member of a family, in twins or sisters, in mother and daughter, or aunt and niece, so that such facts should be obtained at the examination as well as the susceptibility to illness and fatigue, rapidity or retardation of growth, and time of dentition. Signs of rickets, like bowlegs, the "rosary," or the characteristic shape of the head, should be well noted, and the history of any severe constitutional diseases, as well as the general habits of life, such as the length of the school hours, the amount and nature of exercise, and the standing and sleeping posture. The mother should be asked how the curvature was noticed, for it is frequently discovered first by the dressmaker in some casual way, such as the slipping of the clothing, inequality of the two sides of the skirt, or unevenness of the shoulders, and in all such cases it has probably existed for a long time unrecognized. The patient should then be stripped, the length of the legs measured, the presence or absence of flat-foot should be observed, as well as any marks on the body from pressure or faulty support of the clothing. The spinous processes should then be marked by a flesh pencil, and the levels of the shoulders and inferior angles of the scapulae should be noted, while the patient stands in a natural position with the heels together. Slight projection of one hip can be quickly detected by noticing the variation in the size and shape of the space between the arm and side, seen from behind, as pointed out by Jakob Bolin. Flexibility should be tested by having the patient bend to either side and then forward, with the knees straight, the Adams' position, which best displays any rotation; and the examiner's hands may pass up and down the sides of the spine to feel any irregularity. The habitual posture should then be found, and the patient placed in the best possible position, which should be the keynote for future treatment, as Bernard Roth has so well insisted.

Before beginning a course of treatment the extent of the curvature should be recorded if we are to follow the effects of treatment. This record must show the difference in the height of the acromia and inferior angles of the scapulae, the deviation of the spinous processes from the straight line, the difference in outline

and level of the hips and iliac crests, and, again, the picture will not be complete unless rotation of the vertebrae is shown in both the dorsal and lumbar regions, and, if necessary, the condition of the anterior and posterior curves.

For this purpose photographs are much employed, but the most vital objection to their use as routine practice is their expense, both in time and money, the difficulty of getting them, and their liability to mislead the observer by imperfections or changes in the lighting of the figure at different times. Spellissy has devised a uniform photographic method which would be of value if the following conditions were observed: (1) A standard focal length of lens; (2) a standard focus and distance of subject from lens front; (3) a standard direction of lighting for recording purposes; (4) a standard size of image and of division of chart for comparative illustrations, and (5) a standard series of poses in faulty, habitual, and corrected posture. Plumb-lines are sometimes used, and deviations from them are noted at different levels. The shoulder-levels have been measured from the ground, and various other isolated facts have been taken, but these methods are all imperfect, cumbersome, and lack the uniformity necessary for comparison one with the other.

Bernard Roth's plan of recording rotation by molding a flexible strip of pure tin across the back at the desired level, and making a tracing from this upon paper, is easy and accurate.

Fitz describes a method of photographing the patient behind a screen, consisting of a rectangular frame with threads strung vertically and horizontally, cutting the entire surface into squares of one inch. A rapid method of recording the deviation is by attaching a strip of adhesive plaster to the spine and marking the position of the spinous processes on it.

The most accurate and convenient instruments are those employing the pantograph method, of which the most elaborate is that of Schulthess, which gives a life-sized tracing of all the contours. Its size and expense, however, make its general introduction impossible (Fig. 240).

An attempt has been made to fulfil these conditions in an

instrument which I have employed for some years. It consists of a horizontal iron stand into which a rigid upright rod is firmly screwed. To this rod two jointed arms are attached by movable collars clamped by thumb-screws. The lower arm passes behind the patient and fixes the hips by means of clamps, preventing any sideways movement. The upper arm passes in front of the

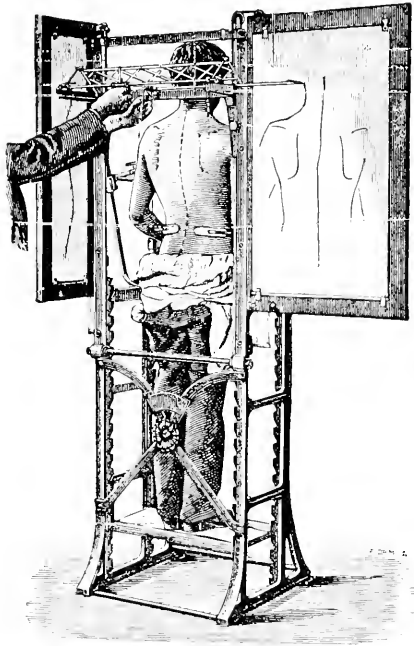

Fig. 240.—Schulthess apparatus for recording lateral curvature (Lüning and Schulthess).

patient and fixes the shoulders. To the collar of the upper arm a plate is hinged for the attachment of the pantograph, set to make the tracing in the proportion of 1 to 4. Ruled paper is stretched over the plate and held by clips behind. The pointer should be adjustable in length, short for the tracing of the spine and scapulae; and capable of being lengthened for tracing the outline of the shoulders and hips.

To take a tracing the spinous processes are first marked with a flesh-pencil. The patient is placed on the stand with the heels together, the hips are clamped at the level at the trochanters, and the shoulder arm adjusted and clamped after the patient has settled into the habitual position. The line of the spine is followed by the short pointer (Fig. 241), the gluteal cleft and the points of the

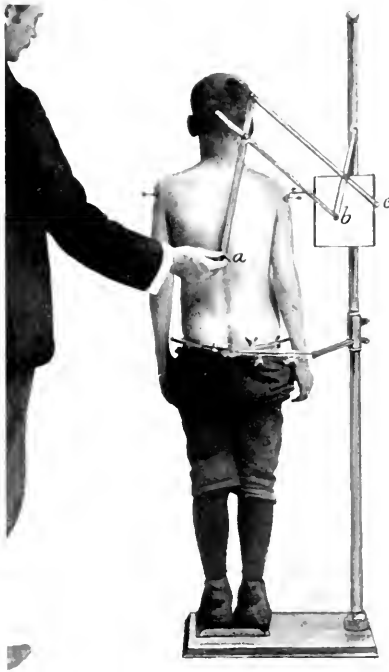

Fig. 241.—Making a tracing of the lateral deviation by the author's scoliometer: *a*, Pointer which follows the line of the spinous processes and tips of the scapula; *b*, pencil recording the tracing on paper to the scale of 1 to 4; *e*, fixed point of the pantograph.

scapulae marked; then an outline of the shoulders and hips is rapidly traced by lengthening the pointer to touch the most prominent parts. Cross-sections may be taken to show rotation by passing the end of the pantograph across the back, at the desired level, the patient bending forward (Fig. 242). A tracing of this kind gives an accurate map of the back, showing the difference in levels, deviation, and rotation,

their extent being to scale, and estimated by counting the squares on the ruled paper.

These tracings should be repeated from month to month throughout a course of treatment.

Diagnosis.—Scoliosis must be carefully distinguished from Pott's disease or tuberculosis, symptoms of which are spasm of

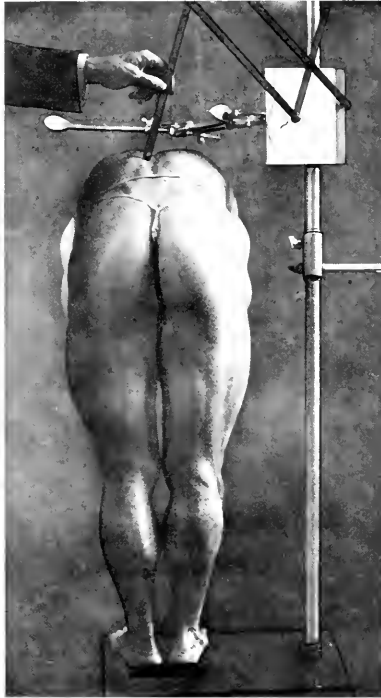

Fig. 242.—Making a tracing of the rotation at the lumbar region.

the muscles and loss of mobility in the spine, with pain on motion or jar, pains in the chest and abdomen, fever, and impairment of the general health. Lateral deviations occur in the course of this disease, but it is usually a leaning of the body to one side rather sharply, instead of a true gradual curve. In later stages a knuckle of bone develops at the seat of the disease, but the danger of mistaking it lies before this has developed.

In rickets the malformations of the various bones may usually be discovered by examination and measurement, and the other constitutional symptoms are characteristic, the curves of the spine being generally rather sharp, and often accompanied by great thoracic deformity.



Fig. 243.—Case of tubercular spondylitis simulating scoliosis, showing lateral and rotary deformity. The onset was very rapid and the rigidity great. The diagnosis was not made until treatment by exercises had increased the deformity and rigidity. The deformity was gradually corrected under treatment by immobilization (Kidlon and Jones).

In infantile paralysis there is a manifest loss of power in the affected muscles, which renders its diagnosis comparatively easy, especially by the aid of electricity. In these cases the deformity usually becomes great, and the condition is resistant of treatment. Curvatures resulting from pleurisy and empyema are always toward the convex healthy side of the chest (Fig. 244), and are easily distinguished by the history and appearance.

The most frequent form of scoliosis is the total C-shaped curve involving the entire back (Fig. 245).

In his series of 1000 consecutive cases, taken from a large private practice, Bernard Roth found 523 presenting this type; 320 presented a right dorsal and left lumbar (Fig. 246); 72 of his cases showed a total right curvature, while 33 might be classed as irregular. This is substantially the same proportion as in



Fig. 244.—Tracing of scoliosis due to collapse of right side after empyema and resection of ribs.



Fig. 245.—C curve in a young woman.

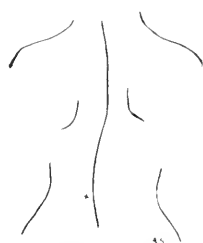

Fig. 246.—Tracing of typical Z-shaped curve.

Scholder's examinations of school-children at Laussane. His entire table is as follows:

Among 571 school-children with lateral curvature, out of 2134 children examined, 60.3 per cent. showed curves convex to the left, 21.1 per cent. showed a right convex curvature, and 8.5 per cent. showed compound convex curves. His totals are:

	<i>Left Convex.</i>	<i>Right Convex.</i>	<i>Total.</i>
Total scoliosis.....	48.1 per cent.	7.8 per cent.	56.0 per cent.
Dorsal scoliosis.....	8.4 "	4.3 "	12.7 "
Lumbar scoliosis.....	11.8 "	8.5 "	20.3 "
Combined scoliosis.....	8.5 "	8.5 "

The total curve is most commonly found in school-children, and is followed by the right dorsal and left lumbar. Transitional cases are nearly always preceded or accompanied by round shoulders, flat chest, and protruding abdomen, and by general carelessness in carrying the body weight when standing at rest, as in Fig. 235. This alone would tend to produce a well-marked total curve with the convexity to the left. As this posture becomes

fixed the bodies of the lumbar vertebrae rotate to the left, and this part of the curve tends to become more pronounced and localized, a compensating curve developing in the opposite direction in the dorsal region. This process, happily, may be arrested at any stage of its course.

Curvatures beginning at the upper end of the spinal column are usually caused in school-children by uncorrected astigmatism and by faulty positions in sitting and in writing, where the head is tilted to the left and twisted to the right, as in facing a strong wind. This causes a rotation of the bodies of the cervical vertebrae to the right, carrying with it the bodies of the dorsal vertebrae, producing the characteristic right dorsal curvature, with rotation to the right, and followed by a left convex lumbar, the level of the greatest deviation in these cases being usually from the sixth to the eighth dorsal.

In total curvatures the deviation is greatest lower down—about the ninth or tenth dorsal, or even at the twelfth. In curvatures beginning from some distortion of the pelvis or irregularity in its support, the curvature is usually situated low down in the lumbar region (Fig. 247).

Symptoms.—The symptoms, apart from the deformity, may not be very prominent in slight cases. The dressmaker conspires to conceal it by making one side of the skirt longer or by changing on one side the distance of the arm-hole to the waist-band, but patients usually have a feeling of one-sidedness. They are often observed to have a distinct limp and a very considerable number, especially young women, complain of backache, more or less severe, sometimes bilateral, and sometimes on one side only, usually situated in either the lumbar region or about the point of the scapulae. In severe cases there may be pressure upon the nerve-roots, causing pain. The early onset of fatigue, with shortness of breath, is common on account of the diminished capacity of the

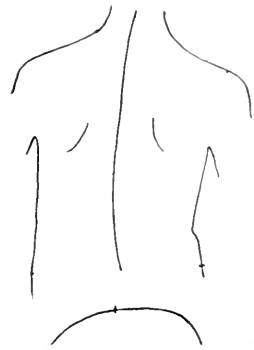

FIG. 247. Tracing illustrating a C curve as a result of uneven extremities.

lungs and interference with the heart action, but these symptoms are peculiar to the more aggravated cases. As the deformity tends to increase during the growing period, these symptoms may not become insistent until the approach to adult life, when the patient is prone to develop phthisis or to have disturbance of the digestion, impairment of the general vigor, and slow increase of asymmetry, with increasing pain in the back, as senile atrophy of the intervertebral discs progresses.

Prognosis.—Total functional curves may continue as such throughout life, increasing slightly, although, as a rule, they change to structural curves and become compound in form as they progress. Some permanent deformity is certain in all cases where

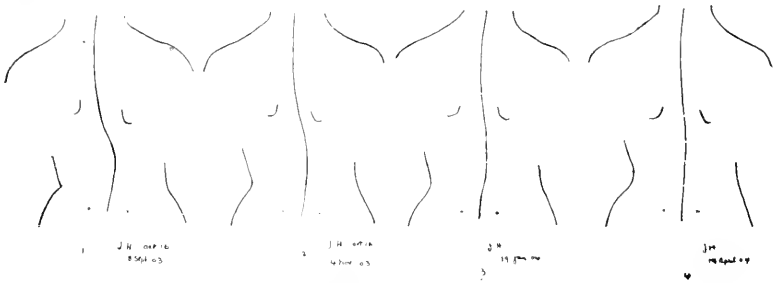

Fig. 248.—Course of the S curve under treatment.

the vertebrae have become distorted and a functional curve has become structural.

By treatment all but structural cases should be capable of permanent cure, and even they should be in every case greatly improved, the deformity masked, and the general health and efficiency retained. This applies more especially to children who have not yet acquired their full growth. When full growth has been attained, before the case comes under observation, complete cure is not to be hoped for, and the only thing to be expected is some improvement in the general condition and a variable diminution of the deformity. Cases due to infantile paralysis or to the collapse of one side of the chest, from empyema, are peculiarly resistant and must be treated with great caution. Cases due to rickets are also resistant, although most of them are capable of considerable improvement.

CHAPTER XVIII

THE TREATMENT OF SCOLIOSIS

THE treatment of scoliosis falls naturally into two divisions: (1) The reformation of the physical habits and improvement of the general condition; (2) the correction of the deformity by exercise, stretching, and support.

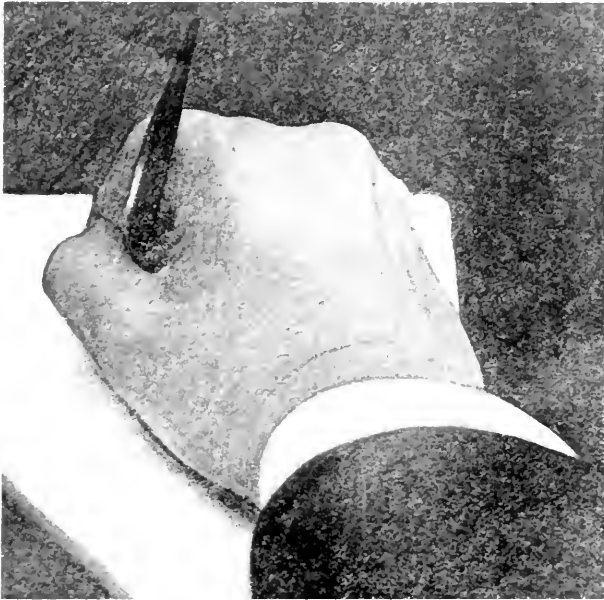

Fig. 240.—The hand in the writing posture as usually ordered, but not practised, because to the writer the writing field is hidden by the thumb, finger, and holder (Gould).

Correct standing posture must be taught by the aid of a mirror, as described in the chapter on Round Shoulders. This must be insisted upon in season and out of season until it can be maintained without fatigue.

Astigmatism should be at once corrected where it is the cause of tilting of the head, and the habits of school life should be carefully regulated.

The writing posture has been much maligned, and even with well-fitting seats and desks the present writing position is such as to favor the formation of fatigue scoliosis to a marked extent. Slanting script has been blamed as an encourager of postural

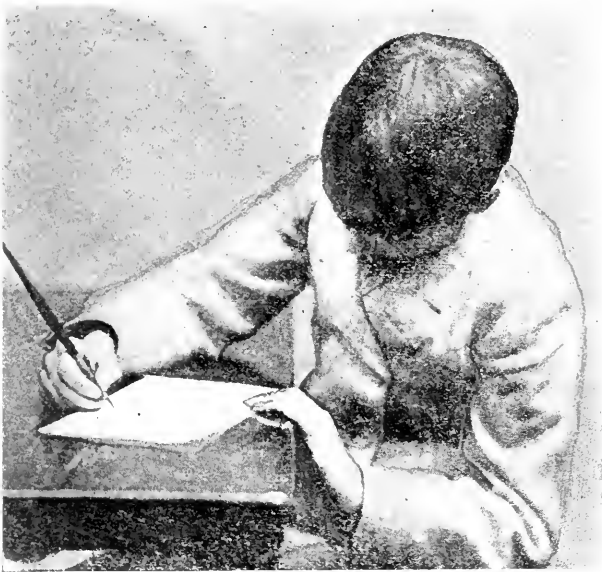

Fig. 250.—Change of posture of body and head, the paper shown, and the pen-holder angled in order to bring the writing field into view (Gould).

defects, but the directions given for the correct writing position are impossible from a practical standpoint, as has been demonstrated by Gould, who shows that the hand in the writing posture, as usually ordered, lies between the eye and the writing field, which is hidden by the thumb and finger and the pen-holder (Fig. 249). As a consequence, the pupil turns the paper to the left, and the pen to the right, accompanying this by twisting of the head further to the left, with the chin tilted to the right (Fig. 250).

If the paper, instead of being placed in front of the pupil, be

placed to the right of the body line, these difficulties are overcome, and the child obtains a clear view of the writing field—the only possible deformity then being a forward bending of the head. This, he thinks, can be avoided by tilting the desk-top to an angle of 45 degrees, a suggestion probably impossible in most schools under present conditions, but the shifting of the writing paper is easy of adoption, and covers the most serious objection to the present writing position.

The rule for the construction of a well-fitting desk is so simple that there seems no excuse for neglecting it.

The height of the seat from the floor should be such that in sitting the feet rest easily on the floor or on a foot-rest. The slope of the seat should be backward and downward, in the proportion of one in twelve, the depth being about two-thirds the length of the thighs and the width that of the buttocks. Making it concave adds to the comfort. The back of the seat should have a slope backward of about one in twelve from a vertical line, and the back support should come to the middle of the shoulders and touch the small of the back. The height of the desk should be such that the back edge allows fair room to rest the forearm naturally with the elbow at the side, and the slope should be about one to six forward and upward, the edge overlapping the front edge of the seat by about one inch. The desk may well be made adjustable for

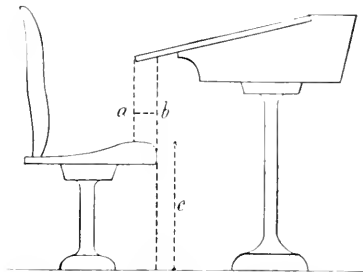

Fig. 251.—To show the measurements required in determining desk proportions, $a-b$ is the distance which is here minus, because the edge of the desk overlaps the front of the seat.

distance (Fig. 251, $a-b$), so as to allow freedom in getting in and out, by pushing the desk-tid forward. These points are covered in the Garber adjustable desk, described in the chapter on Schools, but no matter how well fitting the school furniture may be, unless there is constant change allowed, scoliosis is sure to develop in some growing children.

Poor lighting of the school-room is a third source from which scoliosis begins. If the pupil cannot see clearly, he bends forward or screws his back, and the same effect is produced if he sits in his own light. A well-designed school-room should have windows placed high enough to let the light fall over the left shoulder, and never directly from in front or behind.

The raising of one side of the seat will reverse a beginning curvature (Figs. 238 and 239), and this may be used as an auxiliary means of treatment by placing the patient upon such a seat from a half to one hour daily. Where one leg is short, the foot should be raised by wearing an insole of cork in the boot; and a child who habitually rests with the weight on the right leg, as in Fig. 235, should be trained to reverse the resting posture by using his left leg as the habitual base of support.

The main corrective treatment of scoliosis must, however, be by active exercise and stretching, and the muscles must be developed and trained to maintain the correct posture with ease. Treatment must be thorough and regular, extending from half to one hour daily for six months at least; and even after an apparent cure has been obtained, the patient should be kept under close observation for at least two years, to check the first signs of relapse.

As most children suffering from scoliosis are below the normal in strength and resistance, it is essential that exercise should not be pushed beyond the point of general fatigue, and the greatest care should be taken to limit the number of muscle groups exercised to those more directly affected, so that the resulting fatigue may be localized to them and not spread over the whole muscular system, for most of the discredit under which the exercise treatment of scoliosis has labored has been due to the inaccuracy of the exercises.

Every course should begin with what is known as "straight work," such as is described for round shoulders, in which the muscles on both sides are equally employed, with special emphasis laid upon chest development, but in a few weeks one-sided movements should be introduced in appropriate cases, such as are described for the raising of the right shoulder, and, gradually,

stretching movements should be taught, like those pictured in Figs. 172 and 263 (pp. 233 and 302), the right or left foot only being used, and the surgeon grasping the left or right hand, and so producing a diagonal tension on the spine. All free movements should be done in the keynote position, which is found experimentally by holding the arms so as to give the greatest correction of the curvature. This may be with the right arm up and the left arm out, or with the right arm up and the left arm down,



Fig. 252.—A girl aged 7 years with severe osseous lateral curvature of the spine, in the "habitual" posture (Bernard Roth).



Fig. 253.—Girl aged 7 years, with severe osseous lateral curvature of the spine, when placed in the "keynote" posture (Bernard Roth).

or with both arms above the head, or the right arm extended and the left down. It must be found after repeated trials for each individual case.

In applying asymmetric exercises it is to be remembered that the most freely movable regions of the spine are the most abundantly provided with muscles, and a brief analysis of their action and the means of isolating their play under normal conditions will

be of assistance before describing the special exercises employed when their action is disturbed by scoliosis.

In the lumbar region the psoas takes its origin from the bodies of all the lumbar and the twelfth dorsal vertebrae, passing downward and out of the pelvis to be inserted into the small trochanter of the femur (Fig. 254). The femur can be used as a lever to pull on the bodies of the vertebrae by means of the psoas. As rotation of the lumbar spine takes place about the articular facets, acting as a pivot, and behind the origin of the psoas, the right psoas could thus be made to pull the bodies of the lumbar vertebrae over to the right, and would tend to unwind a rotation to the left. The problem is to put into action

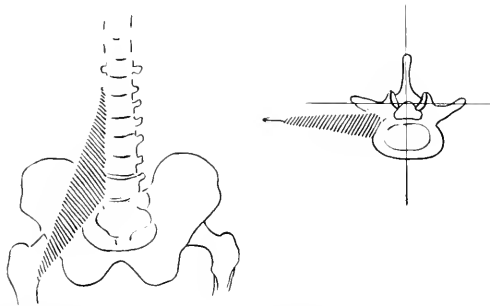

Fig. 254.—Direction of the pull of the psoas on the lumbar spine.

the right psoas muscle without involving too many additional muscle groups. If we flex one or both thighs, the abdominal muscles do most of the work. If, however, the right thigh only be flexed, and the left heel pressed backward against the table, the patient being recumbent, the abdominal muscles may be relaxed, and a comparative isolation of the right psoas obtained with a little practice (Fig. 255).

The intrinsic muscles of the back, known collectively as the erector spinae mass, including the multifidus and other short deep slips, are most complicated in their distribution, this very complexity being useful in that its strands may be employed in relays, the tired fibers being replaced by fresh parts, and the onset of fatigue accordingly postponed.

As a mass it takes its origin from the posterior aspect of the sacrum, from the iliac crest, the lumbar spines, and the transverse processes. It is very thick and fleshy in the lumbar region, where its two main divisions are defined, the outer tendons going to the six lower ribs, just outside their angles, and prolonged upward by the accessorius and the cervicalis ascendens, the inner division, more thick and fleshy, going to rib and transverse process throughout the entire dorsal region, with an additional bundle going from the second lumbar spine to the first dorsal (Fig. 230). The deeper layers of this inner division fill the hollow between the transverse and spinous processes, the general direction being forward and inward, while in the lumbar region muscular slips go



Fig. 255.—Raising right foot with weight attached.

between adjacent transverse processes, as well as between the spines.

The general action of this muscular mass is to bend the spine like a bow-string and to pull down the ribs on the active side, at the same time increasing lordosis. The quadratus lumborum is a depressor of the last rib, and acts with the erector spinae of the same side.

The lumbar and lower dorsal portions of the erector spinae are isolated in action alternately in the act of walking, as can be readily demonstrated by placing the hands over the loins and feeling them spring into action at each step (Fig. 250). Support of the weight on the right leg involves a contraction of the left lumbar erector spinae. Support of the weight on the right arm and the

feet, as in the diagram (Fig. 257), brings into action the right erector spinae, but if the support be at the hips, the action is reversed except in the cervical region (Fig. 256).

In the dorsal region the muscles are much thinner, more tendonous, and the intertransversales and interspinales degenerate into ligamentous bands, and the dorsal spine is much less directly affected by muscular action than either the lumbar or

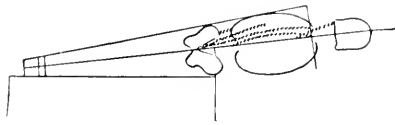

Fig. 256.—Left erector spinae in action during support at hip.

cervical, but the ribs can be employed as levers, and the thoracic cage, with its muscular attachments, can be made an active means for correcting deviation and rotation.

In movements where the humerus is fixed and the spinoscapular muscles contracted, the spinous processes are pulled over to the active side by the trapezius, the latissimus dorsi, and the rhom-

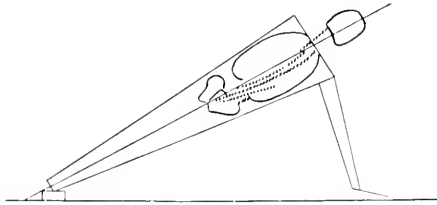

Fig. 257.—Action of right erector spinae in dorsal crossing to left side during support at feet and shoulders.

boids. If the pectorals of the opposite side be contracted, an additional torsion is exerted on the dorsal spine.

The dorsal region can be reached through the action of the respiratory muscles. The upper ribs being first fixed in forced inspiration by the scaleni, serratus posticus superior, and the sternomastoid, the thorax is flexed toward the side, showing the convexity, forcing out the walls of the collapsed side, and so lessening the rotation of the ribs and deviation of the spine.

In the cervical region the erect spine is extended by the splenius capitis and colli, by the complexus, and by the reappearance of the intertransversales and interspinales, as muscles after their ligamentous degeneration along the dorsal spine, besides the obliques



Fig. 258.—Erector spinae in action during forward bending.



Fig. 259.—Left erector spinae in action during support on right leg in standing or walking.

and recti of the suboccipital triangle, all forming the thick, fleshy mass of the back of the neck. Movement here is very free in all directions, most notably rotation or torsion, which takes place largely at the first two cervical joints through the action of the

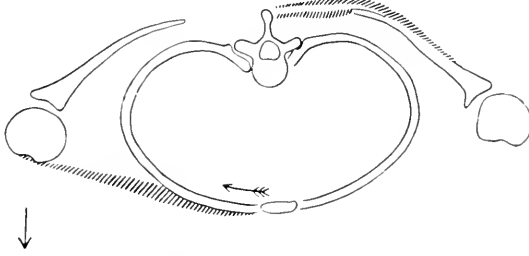

Fig. 260.—Torsion of thorax by muscular action.

inferior obliques and the more superficial muscles, which are all directly accessible to exercise.

A muscle can be developed only by active contraction and relaxation. Continuous tension quickly tires and lowers its tone.

as has been already stated, so that in prescribing exercise it is necessary to distinguish between those given for the purpose of increasing muscular tissue and power, which should be comparatively quick and frequently repeated, and those which aim at the stretching of muscles and ligaments, which should be slow and long maintained.

In describing the gymnastic treatment of scoliosis the curves will be considered in the order of their frequency, and without attempting to give an exhaustive list of all possible exercises, those that are described will be arranged in the form of prescriptions for typical cases and illustrated by case reports.

All exercises and stretching movements should be given daily, with a period of rest after three or four movements; they should be so alternated and combined that no two employing the same muscles in the same way should follow one another and so cause excessive fatigue.

The most frequent deformity is a total left scoliosis or C-shaped curve, and the following prescription of exercise would be indicated:

Exercise I.—Patient standing in the correct position, hands at the side.

Raise the right arm forward and upward; inhale; upward stretch; rise on tip-toes and raise the left foot sideways; upward stretch; lower the arm and foot to the standing position.

This movement will develop the upper part of the trapezius, rhomboids, and deltoid of the right side, raising the shoulder and stretching the thorax. At the same time the uneven support brings into strong action the lower part of the left erector spine.

Exercise II.—Position standing, fingers interlocked behind the back.

Movement: Roll the shoulders backward, supinating the arms (Figs. 210 and 211), and then bend the body to the left.

This exercise stretches all the anterior muscles and ligaments of the shoulder-girdle, improves its flexibility, and reverses the curve.

Exercise III.—Position standing, left foot forward in lunging position, hands on hips.

Movements: Raise the right arm sideways; inhale; upward stretch; forward bend until the right hand touches the floor in front of the left foot; upward stretch; exhale. This may be varied by bending from the standing position and raising the left arm (Fig. 202).



Fig. 201.



Fig. 202.

This movement, besides developing the upper right shoulder muscles, improves the lung power by filling the lungs in their most favorable position and compressing the air in the downward bending movement. The right side of the thorax is stretched during the forward bending movement, and the left latissimus dorsi is contracted by pressing downward on the left hip with the left hand.

Exercise IV.—Patient supine on the plinth, with the right knee over the end, the left arm behind the back, and the right hand grasped by the surgeon.

Movement: Starting with the elbow at the side, the surgeon pulls the arm up slowly sideways, the patient resisting. When

fully extended above the head, the surgeon exerts as much tension as possible, counting five. The patient then draws the arm down to the starting position, the surgeon resisting.



Fig. 263.—Stretching of right side.

In this stretching movement the two points at which the stretching power is applied are the right hip and the right shoulder, so that this tension will reverse the curve and stretch the right side of the trunk.

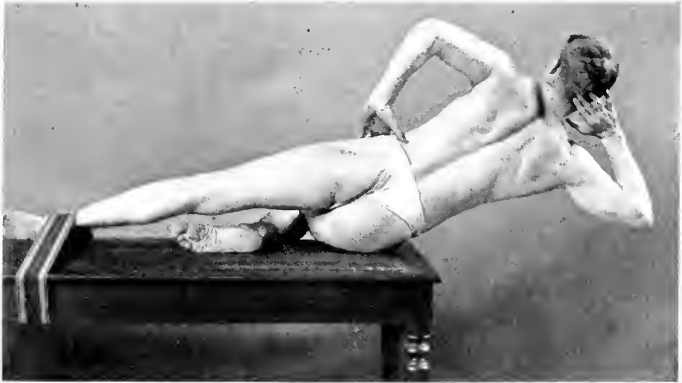

Fig. 264.

Each of these exercises should be repeated at least twenty times, and should be followed by a short rest, after which the following should be given:

Exercise V.—Patient lying on the right side with the legs strapped to the plinth, the right hand supporting the head and the left hand on the hip.

Movement: Side flexion of the trunk (Fig. 264).

In this exercise it will be necessary for the surgeon to assist most patients at first and to urge them to bring the body as high as possible. The entire erector spinae mass on the left side is powerfully employed, and the effect may be still further increased by placing both hands behind the head.

Exercise VI.—Patient lying prone with both feet strapped to the plinth, right arm extended upward.



Fig. 265.

Movement: Trunk extension, forcing the right arm forward and the left arm backward (Fig. 265).

Exercise VII.—Patient lying supine.

Movement: Raise the right arm forward, upward stretch, inhaling slowly; lower to the side, exhaling.

This should be repeated at the rate of twelve to the minute, and the maximum amount of chest expansion secured at each repetition.

Exercise VIII.—Patient lying prone, the left foot only fastened.

Movement: Trunk extension with the movement of swimming, as in Figs. 214-216. This should begin by repeating the swimming

movement five times, followed by a rest. Gradually patients will be able to go up to twenty or thirty times without resting.

These exercises should be followed by a rest.

Exercise IX.—Suspension, with lateral traction. The patient puts the head in a Sayre sling and grasps the cord preparatory to self-suspension. A band of webbing is placed about the point



Fig. 266.—Self suspension with pressure on the left side to correct rotation.

of the greatest deviation on the left side, usually about the tenth dorsal (Fig. 266).

Movement: The patient, pulling on the cord, raises herself from the ground, while the surgeon, by means of a cord and pulley, draws her sideways, stretching the right side. Repeat ten times.

This should be followed by a rest.

Exercise X.—Right hand on the back of the head, left hand on the hip.

Movement: Side-bending to the left.

The treatment should end by deep, firm stroking from above downward, about ten or twelve times on each side, using one hand to press upon the other.

The following is a typical case report:

V. O., aged twenty-one. Consulted me April 20th. At the age of eight years she fell down stairs, and was confined to bed for three months. She states that since then she has been suffering from pains in the back at the point of the right scapula, burning or boring in character, much worse after sitting still for any length of time. Has been unable to attend school or do any work on account of pain and fatigue.

Examination.—Ill nourished and anemic; flat chest; prominent abdomen; projecting chin; round shoulders. Right scapula one and one-half inches lower than the left (Fig. 268). Total left scoliosis, with deviation greatest about the ninth dorsal. Rotation slight, flexibility good, the iliac crests even in height. Patient winces on pressure over the point of the left scapula and left lumbar region.



Fig. 267.

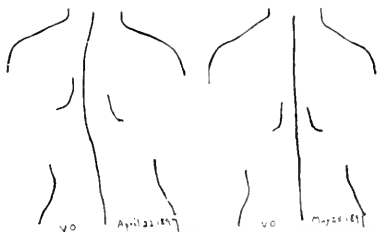

Fig. 268.—Tracings taken at the beginning and after one month's treatment by rest and exercise only.

Prescription of exercises such as described, with one hour's rest daily, recumbent, in the afternoon.

May 28th: She has been at work daily for one month. Right shoulder still lower, but the improvement very marked and the spine almost straight (Fig. 268). Occasional pains, not constant in location or duration, probably hysterical in character. General condition much improved. To continue daily work at home for one month.



Fig. 269.



Fig. 270.

June 30th: Improvement retained. Can attend to social duties without any discomfort. The salutary effect of the exercises on the general condition of this young woman was most marked.

In a right dorsal and left lumbar curvature (Fig. 246) the following prescription would be applicable:

Exercise I.—Position standing, hands on the hips.

Movement: Raise the left arm and left leg sideways; inhale and upward stretch; sideways lower; exhale (Fig. 269).

In this the left side of the thorax, which is contracted by the rotation of the ribs on the right, will be stretched, and the left lumbar curve will be reversed by the tilting of the pelvis and the contraction of the left erector spine mass in the lumbar region.

Exercise II.—Patient standing, with the fingers interlocked. Rolling of the shoulders into supination, with forward bending and twisting to the right (Fig. 270).

In the flexed position of the spine side-bending is accompanied by rotation, chiefly in the cervical and upper dorsal spine, so that this exercise will have little effect on the lumbar curve, the lumbar vertebrae being locked in the flexion of the spine.



Fig. 271.

Exercise III.—Patient standing, hands at the sides.

Movement: Forward lunge with the left foot, the right hand on the hip. Raise the left arm sideways; inhale; forward bend, touching the floor; rise; exhale; come back to the standing position (Fig. 271).

Exercise IV.—Patient lying supine on the plinth. Raise the right foot twelve inches from the plinth, pressing back with the left heel, hands on the hips.

The tension on the right foot should be increased by placing shot-bags across the ankle, starting with a weight of five pounds, and increasing it to ten or fifteen as the strength allows (Fig. 255, p. 297). The patient should be carefully instructed to relax the abdominal muscles so that the strain may fall upon the right psoas, which will pull the bodies of the lumbar vertebrae over to the right and so unwind a lumbar rotation to the left.

Exercise V.—Patient prone, the right foot fixed, the left arm up, and the right arm down.

Movement: Trunk extension, with the stretching of the right arm backward and the left arm forward (Fig. 272).



Fig. 272.

Exercise VI.—Patient supine, right knee over the end, as in Fig. 263, but right arm behind the back, left arm grasped by the surgeon.

Movement: The left arm is pulled upward and strong tension is put upon it by the surgeon. The patient then pulls the arm forward and downward, the surgeon resisting. In this way the rotation is unwound by the diagonal tension running from the right hip to the left shoulder, reversing the curves.

Exercise VII.—Patient lying on the right side, as in Fig. 264, but the right hand on the hip, the left hand behind the head.

Movement: Side flexion to the left.

This exercise is aimed at the lumbar curve, which will be reversed by the side-bending to the left in the extended position of the spine, essentially a motion of the lumbar region, the bodies of the vertebrae turning toward the concavity of the curve.

Exercise VIII. Patient recumbent, supine.

Raise the left arm and the right leg; inhale; lower; slowly exhale.

This should be followed by a short rest.

Exercise IX.—Suspension by the Sayre sling.

Movement: Side traction, pressure being placed on the left lumbar region. Repeat from ten to twenty times.

Exercise X.—Arms behind the head; side flexion to the right (Fig. 327).

This should be followed by kneading and stroking, as previously described.

In a left dorsal and right lumbar curve (Fig. 275) practically the same exercises may be used, except that in every case the opposite leg and arm are employed.

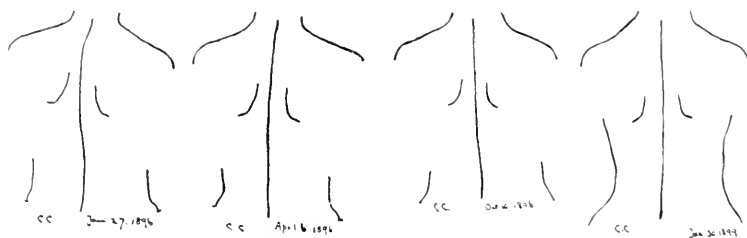

Fig. 273. Four tracings illustrating the progress of an S curve under treatment for three years.

C. C., aged thirteen. Consulted me January 27, 1896.

Examination showed the right scapula low, left dorsal and right lumbar curves with rotation, round shoulders, flat chest, protruding abdomen and chin, and general relaxation of the ligaments.

General health has not been very good. Two sisters had already been treated for spinal curvature.

The indications here would be to develop the erector spinae and extensors of the neck, to expand the chest, and develop the abdominal muscles and raise the right shoulder, reversing the curves.

The best possible position was one in which the right arm was raised and the left stretched horizontally out at the side.

After daily treatment, lasting over two months, the second tracing was obtained, the lumbar curvature being practically



Fig. 274.—Movement for left dorsal and right lumbar curve.

corrected, although there was still a dorsal curvature with the right scapula low.

She reported twice a week for two months, taking a modified daily prescription at home. She then left the city for the summer,

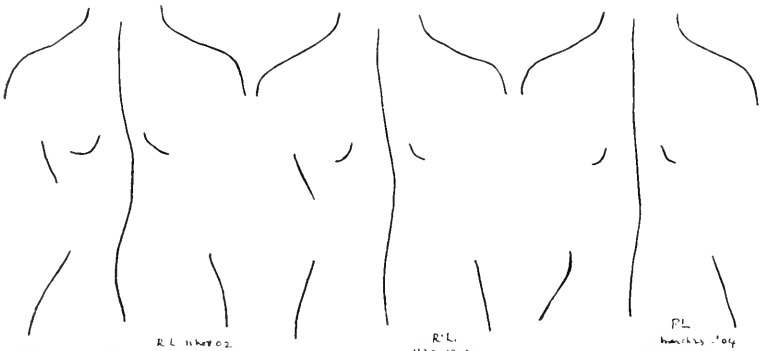

Fig. 275.—Course of triple curve under treatment: Left lumbar, right dorsal, and left cervical.

and the following October a third tracing was taken, showing that the improvement was retained. During that winter she reported once a week and continued her exercise at home.

Three years later a fourth tracing was taken, showing that the correct position had been maintained.

It will be noticed from the tracing that the patient has developed from a child of thirteen to a young woman of sixteen (Fig. 275).

Curves due to infantile paralysis will require long continued treatment, especially where they are severe and structural, localized and fixed. In some of these cases the best that can be hoped for from gymnastics is to develop the general muscular system, and to form compensating curves above and below the primary curve, thus giving a general appearance of symmetry to the outline of the back.

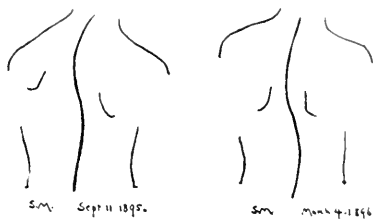

FIG. 276.

S. M., aged nine years. Consulted me in September. Six years ago he had left hemiplegia lasting six months, which, to all appearances, gradually passed away. About two years ago he noticed while walking that the left shoulder protruded (Fig. 276, 1).

Examination showed a left lateral curvature high in the dorsal region. Marked rotation, some pain over the convexity, and diminished flexibility. Slight compensating curves in the lower dorsal and lumbar region were present.

After two months of daily exercise and stretching, a second tracing was taken, showing the development of the compensating curve and the lowering and partial replacing of the left scapula. The improvement continued from September until March, when a third tracing was taken, showing a lowering of the scapula at the expense of an increase of the lumbar curve (Fig. 276, 2). This was the extent of the improvement obtained, but the general appearance of the back, especially when dressed, was very much better, and the muscular development and general efficiency greatly improved.

Where the curvature is due to inequality of the extremities, as in the tracing, this must be corrected by raising the heel of the

shortened side, which is sometimes all that is necessary (Figs. 232 and 233, p. 276, and Fig. 247, p. 289).

One of the most important points in the treatment of all these cases is the development of the thorax, and it is remarkable how much improvement can be obtained in this direction by respiratory and stretching exercises.

One case, S. R., aged eighteen years, came with persistent wearing pain in the back, round shoulders, and lateral curvature. There was a strong family history of tuberculosis.

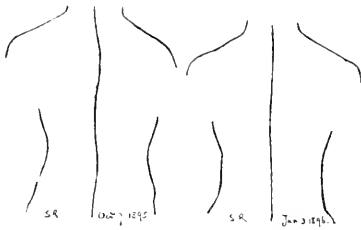

Fig. 277.—Tracings at the beginning and after three months of daily treatment for chest expansion and curvature.

On October 7th her lung capacity, tested by the spirometer, showed 80 cubic inches.

November 28th, after a little over one month of steady work, it was 110, and on January 3d, 125. The pains in the back had disappeared, the curvature was corrected, and her general health excellent (Fig. 277).

Here was an increase in lung capacity of 45 cubic inches in three months. While such a result is unusual, still, after going over thirty consecutive cases, I find an average gain of 21 cubic inches, and among these were several that have increased from 30 to 35 cubic inches in less than three months by daily work.

In structural cases, where the treatment by gymnastics and posture is insufficient, stretching and retaining apparatus are necessary.

Among the simplest is the following (Figs. 278 and 279):

“The patient lies face downward, with the knees flexed, on a board three feet wide and four feet long. Assuming the case to be a right dorsal curve, a broad canvas strap is passed around the left upper thorax, over and under the patient, and fastened to a cleat on the right side of the board. This furnishes a point of resistance against the left side of the upper thorax at the level of the axilla. A broad canvas strap is then passed around the left

side of the pelvis, above and below, and is fastened to a cleat on the right side of the board. This furnishes a point of pressure against the left side at the level of the pelvis. A broad canvas

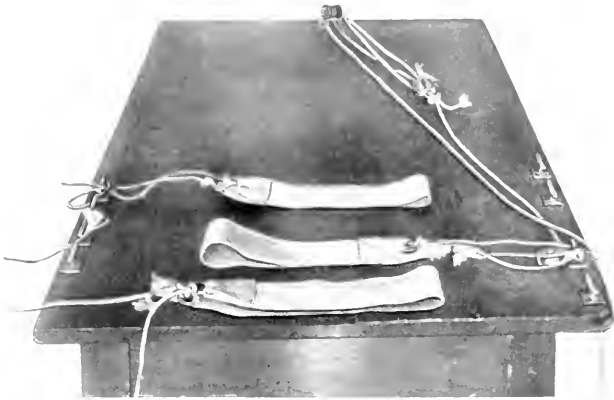

Fig. 278. —Stretching board with loops, ready for application to a *left* dorsal curve (Lovett).

strap is then placed around the thorax on the right side at the level of the greatest point of the curve. Its upper end is fastened to a



Fig. 279. —Stretching board with loops, applied to a patient with *right* dorsal curve (Lovett).

cleat at the left side of the board; its lower end, passing beneath the thorax, is fastened by a string into a pulley attached to a cleat at the left side of the board. By means of this pulley any reason-

able degree of force may be exerted against the right side of the thorax, pulling it to the left and at the same time reducing the rotation, because its upper end is fastened, its lower end moving toward the pulley. The efficiency of this apparatus is greater than the same movement done during suspension, because stretching is done more easily when the spinal muscles are relaxed. Patients should be stretched up to the point of mild discomfort daily, and kept in the corrected position for fifteen or twenty minutes.

The application of apparatus in severe cases for retaining the improvement obtained by gymnastics and stretching need not be

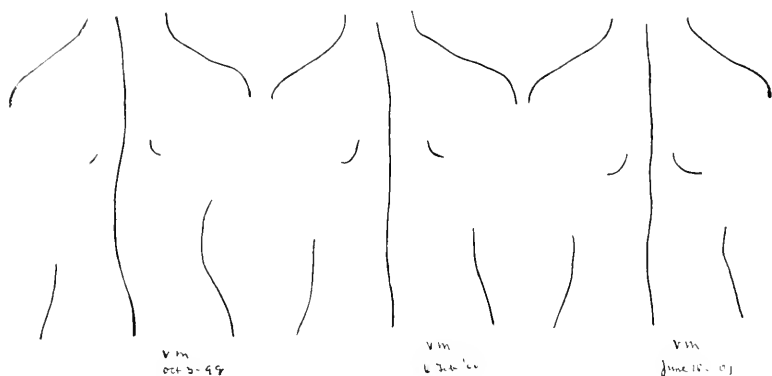

Fig. 280.—Course of triple curve under treatment by exercise and stretching only.

taken up here in detail. The steel brace and the plaster jacket both have their advocates, but they should be applied only to retain the child in the best possible position during the growing period, and all apparatus should be easily removable, so as to permit of daily exercises, which should be persisted in for months or even years if one is to expect a permanent result.

Improvement or cure should not be considered permanent until the correct position is maintained without apparatus from month to month, as shown by repeated records.

CHAPTER XIX

EXERCISE AND ATHLETICS AS A FACTOR IN DISEASES OF THE CIRCULATION

To exercise has been assigned the rôle of cause, as well as cure, in most of the disorders peculiar to the circulatory system.

The heart is a muscle capable of development and liable to overwork, and the arterial system shares intimately in changes taking place in the central organ of the circulation.

The heart may suffer from—

1. Acute or chronic overstrain, characterized by dilatation, hypertrophy, and leakage at the valves.

2. The accumulation of fat in the walls or in the pericardium.

3. A slow hardening and degeneration of the heart wall, and a lessening resiliency of the arteries, with increased blood-pressure, known as arterial sclerosis, in the production of which prolonged muscular overstrain has been given an important place by some authors.

4. Anginal attacks, accompanying dilatation and caused by bodily or mental overexertion, frequently associated with arterio-sclerosis.

5. Actual distortion of the valves, due to inflammatory action accompanying acute rheumatism, chorea, and certain other acute diseases.

In the fifth class the valves may become crumpled and the orifice reduced in size, causing stenosis, or the flaps may fail to meet, the blood-stream leaking back when the contraction is over; sometimes both conditions may exist in the one valve.

In the order of their seriousness valvular defects may be classified as: First and least dangerous, stenosis of the aortic valve (Fig. 281), overcome by a compensating thickening of the

left ventricular wall; second, mitral insufficiency (Fig. 282), the

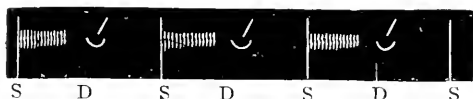

Fig. 281.—Endocardial heart-murmur. Stenosis of the aorta. A systolic murmur in the right second intercostal space (Vierordt and Stuart).

blood regurgitating into the right ventricle through an imperfect closure of the valve between it and the lesser circulation in the

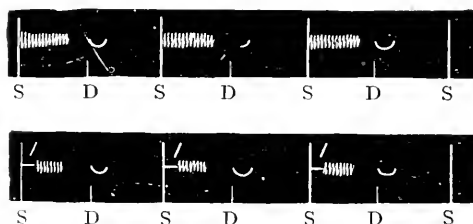

Fig. 282.—Endocardial heart-murmur. Mitral insufficiency. A systolic murmur at the apex of the heart (Vierordt and Stuart).

lungs; third, stenosis, or narrowing of the mitral valve (Fig. 283), followed by an increase in wall thickness and dangerous dilata-



Fig. 283.—Endocardial heart-murmur. Mitral stenosis. A diastolic murmur at the apex, the first sound valvular or approximately so, if the second sound is heard at all (Vierordt and Stuart).

tion of the right ventricle; and last, insufficiency of the aortic valves (Fig. 284), which throws such an increased burden on

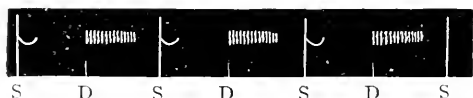

Fig. 284.—Endocardial heart-murmur. Aortic insufficiency. A diastolic murmur at right second intercostal space or, better, lower down to the left of this over the sternum (Vierordt and Stuart).

the left ventricle that any overstrain is liable to be suddenly fatal. This last condition is the usual consequence of the first,

since the hypertrophy resulting from aortic stenosis soon gives place to dilatation of the aortic orifice and consequent regurgitation of blood into the left ventricle.

In the physiology of exercise it was explained that by exercises of effort the blood-pressure was suddenly raised to nearly double the normal, falling quickly to its normal level with the cessation of the action (McCurdy).

In the experiments of Bowen,¹ on exercises of speed and endurance, the rise of the blood-pressure followed the rise of pulse-rate, gradually declining until the end of the test, when it fell to subnormal and slowly recovered. Accompanying tests of either effort or endurance, there is always a temporary dilatation of the heart, which must not be looked upon as an evil. The heart tends to dilate, as pointed out by Roy and Adami, as a matter of economy, whenever its work is increased. This economy results, first, from the fact that any muscle works at an advantage when somewhat elongated, and, second, because the volume of the spherical mass changes faster than its surface. From this it is clear that, as the heart dilates, the volume of blood pumped out by each contraction of the heart muscle increases faster than the stretching of its walls, whose inherent elasticity also tends to preserve their integrity. It is only when the dilatation becomes excessive and is accompanied by greatly increased blood-pressure that harm results. This dilatation of the heart, due to the necessity of increased muscular action, is physiologic, and it is only when other symptoms are present that the heart is really overstrained. The difference between one acute overstrain and the continuous overtaking of the circulatory apparatus must also be borne in mind, as the second condition can only be the result of the accumulation of repeated single overstrainings.

The investigations of Theodore Schott are pertinent to this question. He selected wrestling as his exercise—an exercise of effort in which the entire muscular system takes part, but which combines endurance if carried on for any length of time. The results on the heart action are shown in the six pulse-tracings.

¹"*Amer. Jour. Phys.*," vol. xi, No. 1.

The dilatation of the heart, both to right and to left, was from one to two centimeters or more. With the advent of cyanosis he also discovered a great lowering of the blood-pressure. He affirms that all symptoms gradually disappear in a healthy man, and that the severest exercise, even if accompanied by compression of the abdomen by means of a belt, has but a temporary

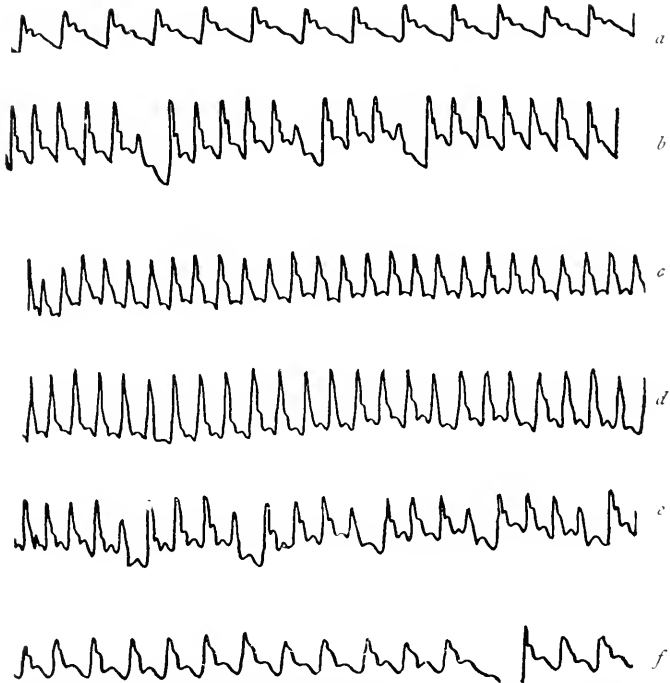

Fig. 285.—*a*, 4 : 33 P. M. Before wrestling. *b*, 4 : 45 P. M. After three rounds of severe wrestling. *c*, 4 : 55 P. M. Continued wrestling. *d*, 4 : 56 P. M. Renewed wrestling. *e*, 5 : 22 P. M. After severe wrestling with tightened belt. *f*, 5 : 42 P. M. After twenty minutes' rest, showing approach to normal action (Schott).

effect, and he concludes that all symptoms of heart insufficiency disappear in a few minutes, and that acute overstraining of the heart, when it does occur in healthy individuals, tends to disappear readily and naturally, the time required depending on the elasticity of the tissues. With older persons, when the heart-walls have lost a considerable part of their elasticity and the arterial

walls have acquired a certain degree of rigidity, overstraining may produce permanent deterioration by breaking up the elastic fibers and causing the characteristic lesions of arteriosclerosis described later on in this chapter.

Stengel noticed that a systolic murmur appeared in three out of nine men just beginning fall practice in foot-ball. This was developed on slight exertion and disappeared in the course of training.

I have repeatedly seen it persist through a course of training without further symptoms or bad results. Darling reports a similar case in an oarsman on the Harvard crew. Two half-mile runners, not in condition, showed a marked enlargement and murmur, with thrills at the apex immediately after running, and a certain hypertrophy is almost always found in athletes who are in condition, but even with the heart thus fortified an unusually heavy strain may cause an acute dilatation, especially if accompanied by great mental excitement.

One case reported by Stengel was that of a young man, sound and in condition. He had been repeatedly examined within a day or two of the injury. In the course of a very trying foot-ball game, physically and mentally, he collapsed suddenly. When seen, he was bleeding at the nose, cyanosed, with weak, fluttering pulse, both sides of the heart enlarged—three-fourths to one inch each way. He was completely prostrated, and did not gain control of himself for several hours. He then became rapidly better, and in a few days seemed quite well. After ten days' rest he resumed practice and regular play without any apparent evil consequences. He has engaged in athletics more or less actively ever since, and is now, twelve years afterward, in excellent health.

This is the most severe case of dilatation of which I have any personal knowledge, although frequently I have found a dilatation lasting a day or two, which is always relieved by rest without apparent after-effects.

Clifford-Abbutt, in writing of his observations on Cambridge students, says:

“The dilatation is, I think, concerned in second wind. The

healthy heart increases its output, the lungs expand, resistance falls, the right ventricle pulls itself together, and second wind is established. This process, trying enough to an unsound or defective heart or to elderly men, is perhaps never injurious to the healthy heart in young adults. I have many times seen undergraduates and others look ghastly at the end of a long spurt of exercises, but never saw a sound young man the worse for temporary distress of this kind. If, as in a few cases that I have seen again and again in growing youths, dilatation of the heart occurs leading to cyanosis, the attending confusion or vertigo is generally sufficient of itself to stop the exercise in time."

With the statement I can most cordially agree, and if permanent or rapidly fatal injury ever occurs, it must be in the notoriously unfit or in those whose age should have led them to choose more sober pursuits.

The presence of a murmur without other symptoms is so common as to be almost habitual in the young. It is most frequently found over the pulmonary valves, but when at the apex, is not necessarily due to mitral regurgitation. The marked acceleration of the onset of fatigue and the slow recovery in the untrained or the overtrained man is familiar to all who have seen such cases after violent and prolonged exertion, but the ultimate recovery of the sound heart from such exertion may be said to be universal.

Blake and Larabee, in their observations on long-distance runners, averaging about twenty years of age and covering three Marathon races of 24 miles each, write:

"So far as observed, no permanent injury of any kind has resulted from any participation in these races."

Simple or single overstrain and acute dilatation of the heart may then be said to have no immediate after-effects on the healthy young adult: The remote after-effects of strenuous exercise has also been studied by Morgan and Meylan, the material for their observations being university oarsmen, members of the university crews of Oxford, Cambridge, and Harvard. A crew man is required to row repeatedly a distance of four miles at top speed, the posture

of rowing being such as to impede the full freedom of the lungs and the heart's action, while the movement is of such intensity and so quickly repeated as to prevent recovery from the resulting breathlessness. This exercise combines in an intense degree the extremes of effort and endurance.

In his book, called "University Oars," E. H. Morgan took the contestants of the interuniversity boat races between Oxford and Cambridge, from 1820-60, as his field, and in his investigation by mail, received letters from 151 of the 255 survivors, and from relatives of the defunct, making a total of 204 reports received. Of these, 7 either speak of themselves as probably injured, or were so described by their relatives, sometimes with considerable reservation.

On tabulating the crews with reference to expectation of life when compared with Dr. Farr's English Life Tables, which places the expectation of a man of twenty at forty years, he found that the expectation of the crews, allowing the normal expectation of their age for the survivors, was forty-two years instead of forty. Of the 39 deaths, he found that 11 died of fever, 7 of consumption, 2 from other forms of chest disease, 6 from accident, 3 from heart disease, 1 from Bright's disease, and 8 from various causes not connected with athletics. Of the 7 dying from consumption, it was found that nearly all had a strong personal or family history. They show about the average mortality from diseases of the circulatory apparatus, as well as from consumption, as disclosed by the Registrar-General's report, and it must be remembered that they rowed without preliminary *medical* examination. There were no sudden deaths nor rapidly fatal heart cases.

In America a similar but much more complete set of observations were taken on Harvard oarsmen by Dr. George L. Meylan, of Columbia, who interviewed every survivor personally where possible, or had the reports made out by their medical attendants. He found that 152 men had rowed from 1852-92, of whom 123 still survived (November 1, 1902), thus allowing eleven years to elapse after the last race observed to give time for any evil effects to show. He interviewed 76 men personally, and sent to all a

questionnaire that was most admirable in its completeness. In longevity, the first crew (1852) showed an increase of 1.6 years per man compared with the selected lives of the insurance tables, in which a man of twenty has an expectation of 42.2 years. His results were interfered with by a number of deaths of men in their prime during the Civil War. By allowing, for those killed in battle, the ordinary life expectation of men of their age, the advantage would be increased to 5.39 years per man. Of the 32 deceased oarsmen, only 2 died of heart disease, 1 of consumption, 2 of Bright's disease, 8 were killed in the Civil War and by accident, 3 died of pneumonia, 2 of apoplexy, 1 of dissipation, 1 of paresis, 1 of cancer, and 10 of unknown causes. In neither of the 2 cases of heart disease was rowing given as the cause. The after-health was most satisfactory in 68, good in 36, and poor in 1. Only 2 believed that rowing had injured them, one claiming to have dyspepsia, and the other an enlarged heart, which, however, had caused him no inconvenience since he left college. These results would seem to prove conclusively that rowing is not a serious factor in the production of early death from arteriosclerosis or other circulatory disorders; but it must be remembered that these were lives doubly selected—first, for constitutional vigor, and, secondly, for muscular strength. The rôle of muscular overwork in the production of arteriosclerosis must, then, be looked for rather among those in whom it is carried on for long hours under unsanitary conditions, like the miners observed by Peacock, and in those whose advancing age and hardening tissues do not permit of the rapid recovery from overstretching that is found in the normal healthy youth. This obscure and ill-understood disease is ascribed to habitual overstrain of the heart, either from the excessive use of alcohol, overeating, continued mental strain, or from prolonged muscular overwork. It was first described by Peacock, about thirty-five years ago, as a result of observations made by him on Cornwall miners, who are especially subject to continual severe muscular strain. His observations have been confirmed later by the investigations of Myers, Clifford-Albutt, DaCosta, and others.

Arteriosclerosis is characterized by hypertrophy of the heart, high tension of the pulse, rigidity of the walls of the blood vessels, and the formation of calcareous deposits in the artery walls. The process seems to begin by a breaking up of the elastic fibers of the vessel walls and the formation of scar tissue, which finally becomes calcareous. In the condition of atheroma the artery becomes hard and feels like a string of beads under the finger. The cause of this lowered nutrition in the vessel walls has been ascribed by Sir Lauder Brunton to the diminished pulsation of the vessel-wall, caused by the high tension and the loss of the normal massage, which produced in them a constant interchange of the lymph in the encircling sheath. Each time that the artery



Fig. 286. —Diagram of the effect of the arterial pulse in aiding the circulation in the veins and self-massage of the artery: *A* is the artery, *V* the vein, and *S* the fibrous sheath which incloses them both, and also a lymph-space, which is shaded in the diagram. *A* shows the artery contracted during cardiac diastole with the vein distended with blood, and the space with lymph; *A'* is the artery distended with blood by the cardiac systole, which at the same time drives the venous blood along and empties the lymphatic space (Sir Lauder Brunton).

is dilated by the blood forced into it by the heart-beat the lymph is driven out of this sheath, while with the following contraction of the artery more fluid again flows in (Fig. 286). It is evident, he says, that if the difference between the size of the artery in expansion and contraction is great, there will be a correspondingly free circulation of lymph in the sheath of the vessels, but if the difference is very small, the movement of the lymph will be slow and imperfect, the oscillation of the vessel being diminished; and it is a fact that continued high tension within the arteries leads to arteriosclerosis, to degeneration of the vessels, fibrosis, and atheroma, with increased liability to rupture, causing apoplexy, or to cardiac hypertrophy and subsequent degeneration.

Prolonged muscular overwork may act as a cause of this condition by throwing into the circulation the products of muscular

waste, particularly hypoxanthin, which itself, when injected into the vessels experimentally, will produce abnormally high tension and atheroma, but the continual presence of a systolic pressure of over 150 millimeters of mercury, as measured on the Stanton machine described in Chapter II., must always be regarded with suspicion. When the diastolic pressure is difficult to obtain, by reason of the smallness of the oscillation, the suspicion of arteriosclerosis will be strengthened, and if the radial pulse cannot be entirely obliterated by pressure of the finger, it will be confirmed.

CHAPTER XX

THE EXERCISE TREATMENT OF DISEASES OF THE CIRCULATION

THE aim of exercise is to reduce a high pulse-rate by flushing the peripheral vessels; to postpone the onset of breathlessness by deepening the respiration and improving the muscular tone of the heart; to remove the incumbering fat which muffles its movements; and to prevent palpitation by acting both directly and indirectly on the cardiac nerves.

For this purpose exercises of effort and of endurance each have had their advocates.

Exercises of endurance, like walking and hill climbing, have had their chief supporters in the persons of Stokes, of Dublin, and Oertel, of Munich.

Exercises of effort have been employed from the time of Ling to the present, with such advocates as Bezly Thorne (London), Heineman, and the Schotts, at Bad Nauheim. They have always been confined to single efforts of the most simple kind, with rests between them, accompanied by massage and combined with regulation of diet and the administration of simple or carbonated brine baths.

It is in the method of giving and the dosage of exercise that authorities differ. Wide recommends kneading, rolling, and respiratory movements. He uses abdominal massage, which, according to Levin's researches, can reduce an overexcited heart rate, while Schott and others claim that abdominal massage should be prohibited because it tends to inhibit the heart's action and so prevent aëration of the blood.

All movements of the extremities, especially the legs, draw the blood out from the heart and abdomen and act as depletive influences. The back trembling given by Zander's machine (Fig.

40) has a powerful influence in reducing a rapid pulse, as have vibrations given along the back, from the first to the fourth dorsal. These procedures have the added advantages of being applicable to a patient who is bed-ridden, and to whom movements of the arms and legs must be given with the greatest caution. In slighter cases, particularly those in which the heart's action is impeded by deposits of fat, the endurance required for Oertel's Terrain Cure may be called upon. Sir William Stokes, as early as 1854, wrote of the necessity for such patients to "pursue a system of graduated muscular exercises" for the symptoms of breathlessness. He states: "This treatment by muscular exercise is obviously more proper in younger persons than in those advanced in life. The symptoms of debility of the heart are often removable by a regulated course of gymnastics or by pedestrian exercise, even in mountainous countries, such as Switzerland or the Highlands of Scotland or Ireland."

While the Swedes and the brothers Schott have since then emphasized the gymnastic side of this treatment, the "pedestrian exercise" has been developed by Oertel into a system in which he combined walking and hill-climbing with restriction of fluids. To the treatment by exercise he adds the drying out of the tissues. He made his patients walk on mountainous roads of different steepness for a period strictly regulated, gradually increasing the time and steepness of the road. It is a form of athletic training beginning very cautiously, and based on the principle that function makes structure, although in these pathologic conditions it must be kept strictly within the limits of resistance by the watchfulness of a physician. His system was founded on the result of treatment in his own case. He had kyphosis from a fall when a child, rickets, and a hereditary tendency to obesity which became so marked when he was thirty years of age that the onset of dyspnea, cyanosis, edema of the legs, and a diminution of the urine caused him to give up his practice. In 1875 he left for a mountainous district, and spent there the month of August, where he first experimented with his ideas, against the advice of his attendants, for at that time absolute rest was enjoined for such cases.

The account of this first month is interesting. The first and second days he made short excursions in the morning and afternoon on level ground, and climbed a hill 100 meters high. Breathlessness and palpitation made him stop after taking about twenty steps on level ground and after ten in going up hill, while the heat and effort made him perspire profusely. The third day he climbed a hill 157 meters high. When suffocation seemed inevitable, he rested and found relief in taking forced breathing while resting.



Fig. 287.—Oertel's pulse tracing before beginning treatment (Lagrange).

This excursion lasted six hours, and he lost much weight from perspiration, but that night he had neither irregularity nor palpitation.

In the second week he could climb a hill 527 meters high, but it took him four hours—twice the time for an ordinary person. He had to stop and rest 150 times. He had no evil effects that night. Owing to the profuse perspiration, he had great thirst, which he relieved by gargling cold water, but he did not drink any more than usual.

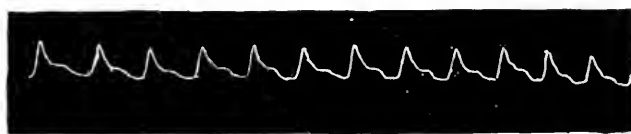

Fig. 288.—Oertel's pulse tracing after six weeks' treatment (Lagrange).

After four weeks he began to take longer excursions and found that he could endure them with comparative ease, and, although breathlessness came on more quickly than it should, the normal action of the heart was rapidly reestablished by resting.

In six weeks' time he returned to Munich and again took up practice, having reduced his weight eight kilos. His pulse remained normal in ordinary walking (Fig. 288), and he could go up two

flights of stairs without breathlessness. This improvement was kept up by periods of training and rest for eighteen years, when Lagrange saw him and reported him in excellent health.

Shortly after his return to Munich he began to establish his cure. The one at Reichenhall is typical, and a map shows the details (Plate 1). The course was regulated with care and minuteness. The paths were marked with stations, benches were placed for resting, and the trees beside the road had bands or flags of red, purple, green, or yellow, the colors representing the degree of its slant. The exercise was thus prescribed in degrees of increasing distance and steepness.

The range of the Oertel cure is strictly limited. It is, first of all, a preventive measure, and can be employed with advantage to improve the general nutrition and to prevent fatty infiltration from becoming localized in the heart. Even in cases where this has already occurred it is still of great value, as it also is where the compensation has been already established by milder means.

Where compensation is broken down, and where the patient is compelled to remain in bed, massage and the milder treatment by gymnastics, which are under more accurate control, have better results. They act more directly upon the peripheral circulation by unloading the engorged veins without unduly overworking the heart itself, and such a course may serve as a good preparation for the Oertel treatment, where it would have been dangerous to begin with it.

The application of massage and gymnastics has been taught and employed since the time of Ling, but it has been most carefully studied and perfected by Auguste and Theodor Schott at Bad Nauheim. The treatment consists of regulated movements of the body, beginning at the extremities and employing the large muscle masses, combined with massage and the systematic use of carbonated brine baths, such as are found at the Nauheim springs. The effect of the baths is to stimulate and flush the skin, and so reduce the frequency of the pulse and increase its force. They can be prepared artificially.

PLATE I.

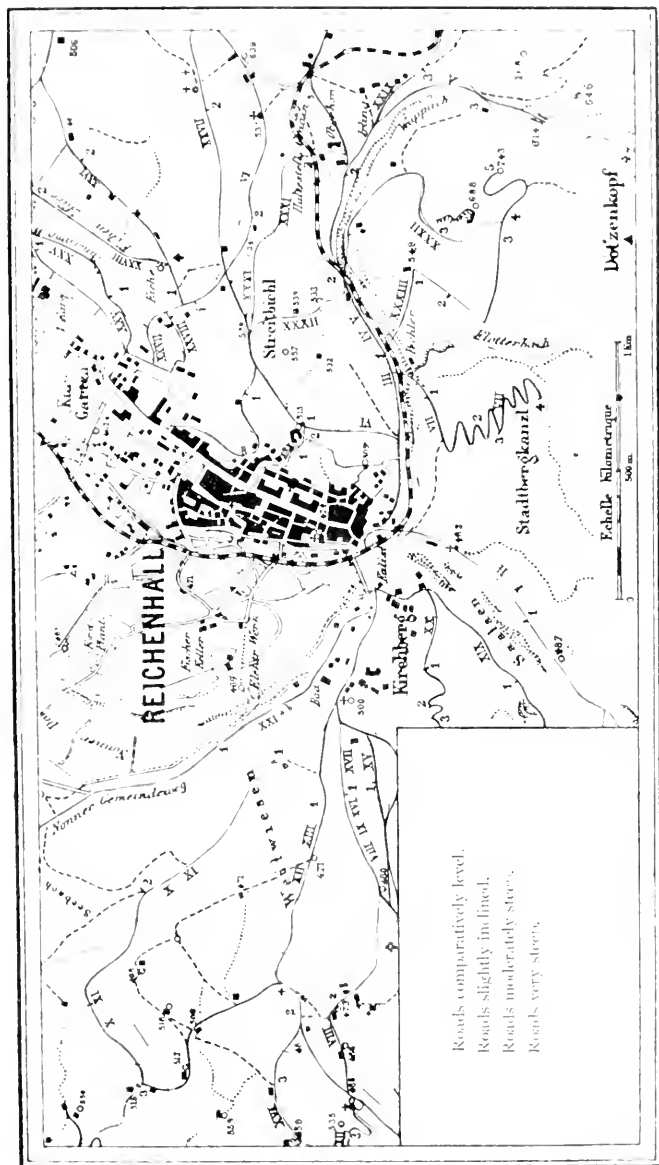

Red, roads comparatively level; purple, roads slightly inclined; green, roads moderately steep; yellow, roads very steep (Aarrange).

The exercises are all duplicate movements, and each one must be slowly and evenly made, with a definite, firm effort on the part of the patient. A short interval should be left between them to enjoin slow and regular breathing and to prevent the possibility of heart-strain. The patient should be constantly warned of the danger of holding his breath during the effort, for by this act an undue and unnecessary strain is put on the heart-walls already impaired by disease. The exercises should stop short of perspiration and palpitation, and the operator should be on the lookout for dilatation of the nostrils, drawing down of the corners of the mouth, duskiness or pallor of the cheeks and lips, yawning, sweating, or palpitation.

The pulse should be frequently examined during treatment, and examination before and after treatment should show a constant reduction in the dulness over both the heart and the liver, accompanied by a sense of general relief and freedom lasting several hours. The pulse is increased in volume as its rate is reduced, and the breathing is made slower and deeper. The color of the lips and face is improved, and the size of the liver, when congested, is notably diminished. Marked diuresis usually follows after a few days' exercise.

The movements cover in regular order, first, the muscles of the arms and forearms; then those of the trunk, thighs, and legs, exercising mildly every important group in the body by single contractions.

The following is the order of the exercises given by Bezly Thorne, in his book on the "Schott Methods of Treatment." For further instruction in the position of the operator's hands and other particulars, the reader is referred to the illustrations. All the movements are done with resistance from the patient. This resistance must be made very mild at the beginning of the treatment, the tendency being to employ too much force. As the patient shows capacity for enduring the fatigue the amount of resistance may be gradually increased, but treatment should, if anything, err on the side of safety, especially if any signs of distress are noticed.

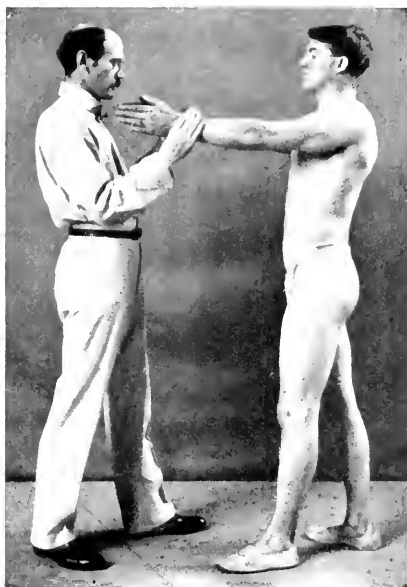

Fig. 289.

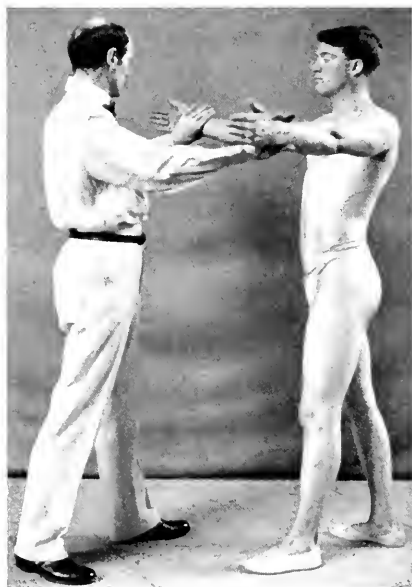

Fig. 290.

Figs. 289, 290.—*Exercise I.* Spread the arms (Fig. 289) until they are in line at the level of the shoulders. Bring them together (Fig. 290).



Fig. 201.



Fig. 202.

Figs. 201, 202.—*Exercise II.* Flex the forearm (Fig. 201). Extend the forearm (Fig. 202).



Fig. 203.



Fig. 204.

Figs. 203, 204.—*Exercise III.* Raise the arm sideways palms upward (Fig. 203), until the thumb's touch above the head. Sideways lower (Fig. 204).



Fig. 205.

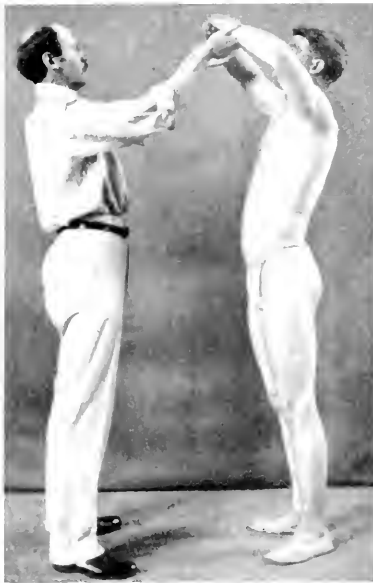

Fig. 206.

Figs. 205, 206.—*Exercise IV.* Press together the knuckles of both hands with the fingers flexed at the second joint. Raise the arms (Fig. 205) above the head. Lower the arms (Fig. 206) to the starting point, in front of the abdomen.

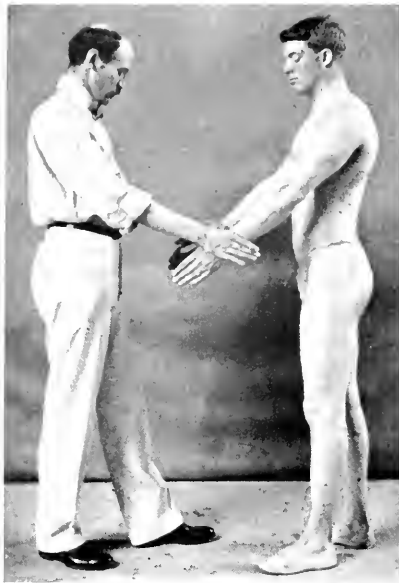

Fig. 207.

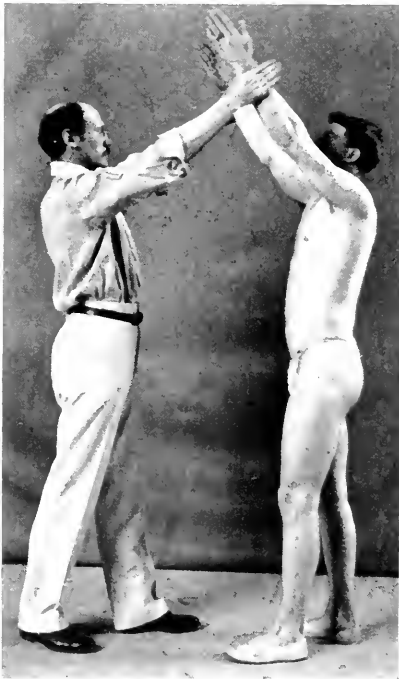

Fig. 208.

Figs. 207, 208.—*Exercise V.* Arms forward raise (Fig. 207) until vertically above the head. Forward lower (Fig. 208).



Fig. 299.



Fig. 300.

Figs. 299, 300.—*Exercise VI.* Forward flexion of the trunk (Fig. 299). Extension (Fig. 300).



Fig. 301.

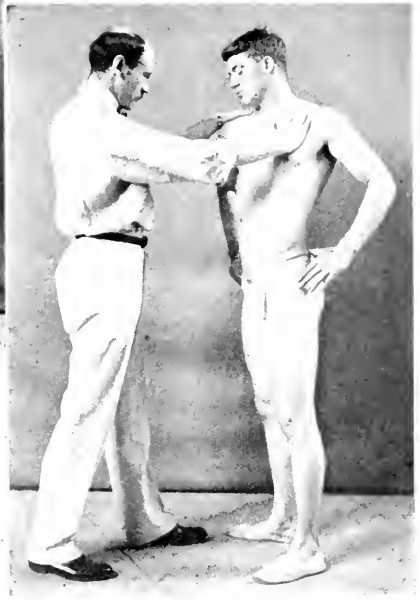

Fig. 302.

Figs. 301, 302.—*Exercise VII.* Trunk rotation. The operator must change his position from Fig. 301 to Fig. 302, as the patient turns, keeping up even resistance throughout the entire movement, and passing partially around him.

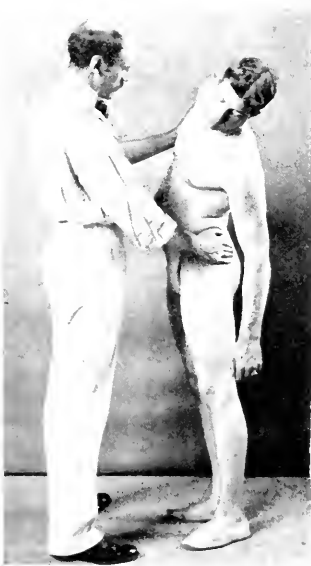

Fig. 303.—*Exercise VIII.* Flex the trunk to the right and to the left alternately. Straighten.

Exercise IX. This movement is identical with Exercise II (Figs. 201, 202), except that the fists are clenched.

Exercise X.—This movement is the same as Exercise IX, except that the arm is at the side.



Fig. 305.—*Exercise XII.* Push both arms backward; draw them forward.



Fig. 304.—*Exercise XI.* Rotate the arm forward, upward, backward, and downward.



Fig. 306.

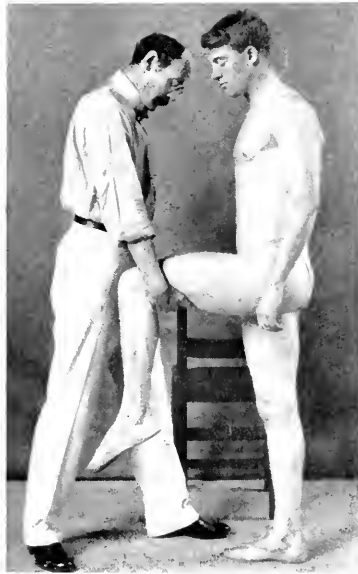

Fig. 307.

Figs. 306, 307.—*Exercise XIII.* Flex the thigh, with knee bent (Fig. 306). Relax. Extend the thigh (Fig. 307).



Fig. 308.



Fig. 309.

Figs. 308, 309.—*Exercise XIV.* Extend the leg and bring the straight leg forward (Fig. 308). Draw the leg backward (Fig. 309).



Fig. 310.



Fig. 311.

Figs. 310, 311.—*Exercise XV.* Flex the leg and thigh (Fig. 310). Extend the leg (Fig. 311).



Fig. 312.—*Exercise XVI.* Abduct the leg. Adduct the leg.

Exercise XVII.—Arms extended horizontally. Rotate forward and backward with resistance.



Fig. 313.—*Exercise XVIII.* Extend the hand. Flex the hand.



Fig. 314.—*Exercise XIX.* Flex the foot. Extend the foot.

This completes the full set of exercises. Many patients at first are unable to complete the entire series. The resistance should not be very great in the beginning, and should be increased



Fig. 315.

only as the patient shows the capacity to endure it. The rate should be slow and uniform, and abundant rest given between each exercise until the individual's powers and limitations have been gauged. Most of them may be done in bed if necessary.

Some form of artificial respiration has been used by others, and may be profitably added to any treatment of these conditions, either in the forms already described or in the chest-raising or shoulder-raising (Fig. 315) described by Satterthwaite,¹ in which the patient inhales as the operator lifts, and exhales as the operator relaxes. This is repeated eight to sixteen times, with one or two natural respirations between each movement. Satterthwaite has further modified the technic of the Schott treatment by arranging the exercises in series of progressing difficulty, which he names schemes I, II, and III, including massage of the thigh and back.

The following is a brief outline of the course of exercise carried on for the first two weeks:

SCHEME NO. I

1. Chest lifting, lying or sitting	2 minutes.
Intermission.....	1 minute.
2. Foot and leg massage.....	2 minutes.
Intermission.....	1 minute.
3. Forearm flexion and extension.....	1 "
Intermission.....	1 "
4. Hand and forearm massage.....	2 minutes.
Intermission.....	1 minute.
5. Leg and thigh flexion and extension.....	2 minutes.
Intermission.....	1 minute.
6. Arm and shoulder massage.....	2 minutes.
Intermission.....	1 minute.
7. Thigh flexion and extension.....	2 minutes.
Intermission.....	1 minute.
8. Chest percussion.....	2 minutes.
Intermission.....	1 minute.
9. Trunk flexion and extension.....	2 minutes.
Intermission.....	1 minute.
10. Thigh and back massage.....	2 minutes.
Total length of séance.....	28 minutes.

¹"Intern. Clinics," vol. i., thirteenth series.

This is increased in severity and the order slightly changed in Scheme No. II, which is carried on for the third and fourth weeks:

SCHEME NO. II

1. Chest lifting, lying or sitting.....	2 minutes.
Intermission.....	1 minute.
2. Foot and leg massage.....	2 minutes.
Intermission.....	1 minute.
3. Forearm flexion and extension.....	2 minutes.
Intermission.....	1 minute.
4. Hand and forearm massage.....	2 minutes.
Intermission.....	1 minute.
5. Leg abduction and adduction.....	3 minutes.
Intermission.....	1 minute.
6. Arm and shoulder massage.....	2 minutes.
Intermission.....	1 minute.
7. Trunk rotation.....	3 minutes.
Intermission.....	1 minute.
8. Chest percussion.....	2 minutes.
Intermission.....	1 minute.
9. Arm separation.....	3 minutes.
Intermission.....	1 minute.
10. Thigh and back massage.....	3 minutes.
Total duration of séance.....	33 minutes.

SCHEME NO. III

1. Chest lifting.....	2 minutes.
Intermission.....	1 minute.
2. Foot and leg massage.....	2 minutes.
Intermission.....	1 minute.
3. Quarter circling (forward and backward).....	4 minutes.
Intermission.....	1 minute.
4. Hand and forearm massage.....	2 minutes.
Intermission.....	1 minute.
5. Head rotation or flexion.....	3 minutes.
Intermission.....	1 minute.
6. Arm and shoulder massage.....	2 minutes.
Intermission.....	1 minute.
7. Trunk twisting.....	4 minutes.
Intermission.....	1 minute.
8. Chest percussion.....	2 minutes.
Intermission.....	1 minute.
9. Trunk flexion (laterally).....	4 minutes.
Intermission.....	1 minute.
10. Thigh and back massage.....	3 minutes.
Total duration of séance.....	37 minutes.

For the fifth and sixth weeks a further change in the series is made, and some new exercises are introduced that might not be well borne at the beginning of the course, particularly quarter circling and head rotation.

It will be noticed that in this final series the exercises involve newer and larger groups of muscles, and that all the great muscles of the body have been exercised. The duration of the séance is also longer, and more force should be applied. The movements should be very slow, and the intermission should be carefully observed, the fault of the operator being usually in shortening the intermission, increasing the amount, and using undue force. The patient should also be urged to breathe freely and naturally, and the operator should be on the lookout for irregular breathing, pallor, blueness of the lips or face, or any sign of personal discomfort or disturbance on the part of the patient. Upon the appearance of any of these signs exercise must be suspended, since they indicate that there has been undue resistance or that the movement has been too rapid or the intervals of rest curtailed. Heineman, of Nauheim, was strongly of the opinion that no exercise should be used in which the hands are brought above the level of the shoulders, on account of the increased work required of the heart in raising the column of blood to this unaccustomed height. With this opinion Satterthwaite agrees. Good results may be expected from exercise in almost all disorders of the circulatory system except arteriosclerosis.

The exercise treatment is unusually successful in conditions of heart weakness complicated by obesity, where improvement should be noted from the first. It is of undoubted value in most valvular disease, with signs of failing compensation, the dilatation of the peripheral vessels resulting from the exercises being followed by an improvement in the strength of the pulse and a lowering of the rate, an improvement that may be maintained for years. In most cases the patients may return to their ordinary occupations and duties, and if signs of relapse begin to appear, the taking of a course is sufficient to reëstablish the equilibrium until the heart shares in the inevitable degeneration of advanced old age.

CHAPTER XXI

OBESITY: ITS CAUSES AND TREATMENT

THE excessive accumulation of fat must be considered as a symptom rather than as a disease. It is due to overnutrition, to underoxidation, or to a combination of both acting together.

When the allurements of the table are too great for the body's needs, the surplus is stored up as fat in the tissues least disturbed by muscular action, and local deposits are made in the region of the abdomen and hips or in a general layer throughout the subcutaneous tissue of the entire body.

Heredity has a marked influence in this fat-making tendency, about 60 per cent. of cases reported by Anders having this history, while its association with gout, that other disorder of overfeeding and underexercising, was found in 43 per cent. of his cases.¹

The normal oxidation of the ingested food may be hindered by a sedentary life involving little tissue waste from muscular exercise, or by the mental and physical torpor and habitual inactivity of the too ardent pupils of Silenus, whose fat is also protected from combustion by the rapidly oxidizing alcohol, which retards all tissue waste, and so favors increase in bulk. It may also be hindered by lack of the proper functioning of the thyroid gland.

Fat is a cheaper form of tissue than muscle, requiring as it does a less abundant blood-supply, and its presence should be considered as an evidence of lowered nutrition.

As the amount of fat increases the desire for exercise diminishes, and the capacity for activity is lessened, because of the speedy exhaustion that follows any unusual muscular work.

Local obesity is frequently found about the waist-line, the deposits occurring in the abdominal walls and in the mesentery and omentum. This, when excessive, gives rise to a pronounced

¹ See "System of Medicine," Osler and McCrae, vol. i, 846.

deformity, simulating tumors, pregnancy, or dropsy. In those who do a good deal of walking the legs may remain comparatively normal in size, while the abdomen is pendulous.

Deposits of fat are common in the regions of the neck, giving rise to the double or triple chin, and in women, especially, it tends



Fig. 316.—General deposit of fat in a young man.



Fig. 317.—Excessive deposit of fat about the hips only (Moore).

to accumulate about the hips and buttocks, the Hottentot Venus being distinguished by the size of her buttocks, due to the excessive accumulation of fat in that region.

The local deposit becomes more dangerous when it is in the pericardium and about the heart-wall, but this seldom occurs unassociated with general obesity.

When the obesity is general in its distribution, it may be slight, moderate, or excessive. The degrees have been admirably characterized by a German writer as the enviable, the comical, and the pitiable stages, the first presenting itself as a pleasing rotundity, the second as a jovial "embonpoint" of the Falstaff type, and the third as a sad, unwieldy, and disgusting deformity.

While the first of these forms requires no definite treatment except the employment of every effort to prevent its further development, particularly if complications are present, the second or third form calls urgently for reduction by diet and exercise.

The prognosis in any particular case depends on the reaction of the circulation to exercise. If the onset of breathlessness, palpitation, irregularity, and thready pulse is rapid or extreme, the "outlook is gloomy" (Anders). If, on the other hand, the perspiration is profuse, the general condition and color remain good, and the pulse strong and regular after exertion, much may be expected from a reduction course.

Most of the causes of death in obese cases are due directly or indirectly to affections of the circulatory system, and its condition must be the keynote for treatment, as was recognized by Oertel in his "terrain cure," described in the previous chapter.

The fact that obesity is frequently but a symptom emphasizes the necessity for a preliminary examination to determine the presence of any of the many complications that are usually associated with it. In this examination habits of life, particularly with reference to diet and exercise, should be noted fully and accurately; the pulse should be examined carefully—lying down, standing; before and after light exercise, like forward bending, stationary running or hopping; the blood-pressure should be estimated and a blood-count made to determine the presence of anemia. The lungs should also be examined for bronchitis, and a series of physical measurements taken, including the weight and girths.

In all diseases that impose increased work on the heart, like arteriosclerosis or emphysema, there is hypertrophy, with danger of dilatation and insufficiency, especially when the body is encumbered by excessive fat. The reduction of this fat constitutes one

of the most valuable means in the treatment of most circulatory diseases, unless they are so far advanced as to render restoration of the heart to its functional activity impossible. Cases in which slight disorders of the circulatory apparatus are present give the most satisfactory results, while, even in advanced cases, improvement can be obtained by beginning gradually and watching the heart condition carefully. When complicated by diseases of the kidneys, like atrophic nephritis, obesity is a real menace, and the reduction is not contraindicated, but advised (Von Noorden).

Chronic bronchitis is a frequent complication of obesity, and the removal of superfluous fat will enable the patient to breathe more deeply, encouraging a free circulation of blood through the lungs, so that such cases sometimes heal under this treatment alone.

Chronic articular rheumatism favors obesity by preventing the patient from moving freely, particularly if the regions of the legs or pelvis are affected. Anders found it in 35.5 per cent. of his cases. The same may be said of gout, the reduction treatment of which, through diet and exercise, is of the first importance. Most gouty middle-aged men present a history of violent indulgence in physical exercise during youth, followed by a luxurious and inactive later life, with overfeeding and excessive indulgence in alcoholic liquors.

In diabetes a reduction cure should never be undertaken, especially if the obesity be only slight or moderate, although in cases where it is excessive, accompanied by heart symptoms, the patient should, where possible, be relieved of any excessive fat. Only in this way can the heart be protected from excessive strain, but it should be used with the greatest caution.

In selecting cases for the reduction cure three considerations should be held in mind: first, the amount of inconvenience the obesity causes; second, the presence and extent of the complications referred to above; and third, the age and general nutrition of the patient.

When obesity is moderate or extreme, the physician may be consulted from vanity, which may thus become one of the most powerful

levers in his hands to insure the thorough and complete carrying out of the irksome rules that the patient must follow if the desired result is to be obtained. This seemingly trivial consideration is one on which the success of the treatment often hinges in the ease-loving, luxurious class from which so many of these patients come. In young and sound adults active courses of five weeks or more may be repeatedly undertaken with safety, allowing intervals during which the loss of weight is merely maintained. In those of advancing age, where the obesity is extreme and the vital energies are beginning to fail, a reduction cure would only accelerate decay and lead to rapid loss in strength and functional power, with the continual added risk of heart failure.

Reduction cures may be divided into three classes or degrees of rapidity:

1. The first degree, in which the loss is very slow, the patient losing two or three pounds a month. It applies to those with an enviable amount of fat which shows a tendency to increase. It does not require great sacrifice from the patient, who must alter her diet by the reduction of fat, starchy, and sweet foods, restrict or abandon alcoholic beverages, take only foods of small caloric value, and engage in regular active physical exercise.

2. The second degree, in which loss should be from five to ten pounds a month, applies to strong, plethoric subjects, who can safely indulge in active exercise. The diet is more strict, and the exercises more varied. It is especially valuable for individuals in whom complicating disorders of the heart, arteries, bronchi, or digestive apparatus render it impossible to take from the start the more rapid or—

3. The third degree of the reduction cure, which should be carefully supervised and may be carried out at an institution with advantage. As much as thirty pounds a month can be lost with safety, but five or six weeks is the longest time during which it should be put in force. In most cases it will be necessary to carry it on for four to six weeks and then have a month or two of less strenuous exercise and regimen, repeating the course thus intermittently until the desired loss of flesh has been attained.

The reduction treatment falls under the three heads of diet, exercise, and drug therapy.

In diet the caloric requirements are reduced to four-fifths of the normal in the first course described, in the second to three-fifths, and in the third to two-fifths. This is obtained by substituting for more nourishing food such articles as bouillon, coffee, or fruits, which have small caloric value. Lean meats should be given preference. Cheese often serves a useful purpose, particularly in small quantities, as it is very filling. Milk is a useful addition to the bill of fare, buttermilk being still more useful. Among vegetables, those varieties that grow under ground, as well as those that grow in a pod, should be restricted, because they contain a large amount of carbohydrates. All the other vegetables are exceedingly useful articles of diet if they possess small caloric value in proportion to their bulk, and consequently fill the stomach rapidly, producing a sense of satiety. They also act favorably on the function of the bowels. Fruits of all kinds, with the exception of bananas, sweet grapes, figs, dates, and raisins, are permitted without reserve, as they have a low caloric value, are filling, and act well upon the digestive apparatus. Bread is satisfying to the eye without possessing great caloric value.

The intake of liquids must be strictly limited. The weight of an obese subject is rapidly reduced by restricting the liquids to a minimum. This loss of weight is particularly apparent during the first four or five days of a cure, being due to a direct loss of water from the tissues by the air-passages, skin, and kidneys, and to the fact that one is inclined to eat less when not drinking freely. It also causes absorption by failing to restore the amount lost by perspiration. This rapid initial loss is of great value to the physician in giving a patient confidence in the method employed. She is put in the right frame of mind to persevere in carrying out the distasteful but stringent rules that must be enforced. Occasionally an initial rise in weight is noticed during the first few days on account of the increased metabolism and improved nutrition following unaccustomed exercise.

Boxers and jockeys who have to reduce their weight rapidly

to a set figure, much below their normal, accomplish it by profuse sweating and abstaining from liquids. When excessive, this is most exhausting to the system, and in making matches or contests, it is frequently stipulated that the man be weighed six or eight hours before a fight, so that this abnormal loss of weight may be regained in part and the strength restored by eating, and drinking copiously of fluids before the beginning of the contest. From five to ten pounds may thus be gained in a few hours. Losses of weight up to fourteen pounds in an hour and a half have been reported during foot-ball games in men at the beginning of training by A. A. Stagg, of Chicago University, and James Naismith, of the University of Kansas, entirely and rapidly regained after eating and drinking.

The patient's general mode of life must be regulated, always a difficult feat to accomplish. Habits of ease and indolence should be replaced by greater general activity, and interest in outdoor games, like golf and walking excursions, should be created to impel her to take a large amount of general exercise.

The influence of massage is very problematic, according to Von Noorden's experiment, referred to in Chapter III., and it is to the more active forms of exercise we must go for the best results.

When the accumulation of fat is unevenly distributed, a daily prescription of ten exercises should be given, to include the entire muscular system, but with emphasis on the regions where the deposit is thickest, for fat tends to accumulate in the subcutaneous tissue covering the groups that are dormant, like the abdominals or muscles of the neck. Such exercises have been shown in Figs. 34, 91, 161, 169, 170, 327, 328, and 329.

When the omentum, mesentery, and abdominal walls are excessively overburdened, the exercises shown in Figs. 91, 327, 328, and 329 are of special value. To these may be added the three following, and selection made from them all to suit the special case:

Exercise I.—Patient lying supine, arms above the head, grasping a support. Raise both feet twelve inches without bending

the knees. Alternately raise and lower the feet (Fig. 318) ten times without touching the table. The extent of the raising and lowering should not be more than twelve inches.



Fig. 318.

This brings the abdominal muscles into action, and should be repeated with rests up to thirty times.

Exercise II.—Patient lying supine, hands on the hips. Raise the head and shoulders until the feet can be seen. Twist to the right, to the left, and slowly return to the starting position (Fig. 320). This may be used as an introductory exercise to the next, in which the same muscles are employed with greater vigor.



Fig. 319.

Exercise III.—Patient lying supine with the feet fixed and hands clasped behind the head. Raise the body to the upright position, and slowly lower to the starting-point (Fig. 310). This

may be accentuated by having the trunk overextended, as in Fig. 320, which is a form of the same exercise which can be rendered more difficult by having the arms behind the head as shown in the position of Fig. 319.

A prescription should begin with the lightest exercise, and the dosage should be increased rapidly in length and severity according to the muscular strength and the condition of the pulse.

After each of the first two or three treatments massage is of distinct value in relieving the muscular soreness, but it seems to have no direct effect in reducing the weight.



Fig. 320.

Accompanying this gymnastic treatment, regulated walking, at first on level ground, and then up an increasingly steep incline, is of the utmost value, beginning with a climb sufficient to produce moderate breathlessness, and increasing the length and steepness as the patient's ability improves. This is the Oertel "terrain cure," as described fully in the previous chapter.

The elimination of fluids may be increased by the use of such aperient waters as those of Kissingen or Vichy, which are used on alternate days, one glass every morning before breakfast or at night.

The principal medicinal agent employed in reduction cures is extract of thyroid gland, given in doses up to five grains three times a day, and stopped promptly if any sign of heart distress or weakness appears.

A daily treatment, such as outlined above, accompanied by proper regulation of the diet, should steadily and consistently bring down the weight in moderate and even extreme cases of obesity.

In one of my patients, a young lady aged twenty, it was reduced by these means from 208 pounds to 167 pounds in a period of four months, which included several weeks lost by interruptions. By a very much modified home prescription this improvement was maintained at the last examination, taken six months afterward.

The most remarkable case of reduction reported is that of George Cheyne, born in Scotland in 1671. By the time he was thirty his excesses in eating and drinking had brought his weight up to more than thirty-two stone (448 pounds), and made him very short breasted, lethargic, and listless. He dieted on milk and vegetables, exercised freely, and so reduced himself to almost one-third (150 pounds). He recovered his strength, and lived to the age of seventy-two, writing an essay on health and long life.

During a reduction cure the heart should be carefully examined from time to time, and the work decreased if signs of palpitation or edema of the extremities are found. Sometimes, when loss of weight is rapid and obtained by means of drugs and diet alone, without care to improve the muscle tone and so to support the viscera, certain complications arise (constipation, hernia, and gastropnoxis), particularly in middle-aged and flabby women. Displacement of the kidneys and uterus may also be traced to the rapid absorption of the surrounding fat, and symptoms caused by such ptoses have in rare cases been found to be more troublesome than the obesity itself.

CHAPTER XXII

OTHER DISORDERS OF NUTRITION

GOUT, DIABETES, RHEUMATISM, GASTRITIS, CONSTIPATION, AND HERNIA

GOUT

THE rôle of exercise in the prevention and treatment of gout occupies an important place in every discussion of this disease.

Like obesity, with which it is so often associated, gout is usually a disease of overnutrition and underelimination, and the indications would be to decrease the intake and increase the excretion of waste by all the avenues.

The rules for diet are still the subject of dispute, but all writers agree that exercise is of great value in reducing the weight of the gouty patient when obese, and of increasing the activity of the skin and lungs.

The nature and dosage of the exercise must be regulated according to the condition of the patient.

In young and vigorous subjects, almost any of the active athletic sports appropriate to their age may be engaged in (These are enumerated in the Table of Sports, in Chapter VIII.)

The great majority of patients will require exercises of endurance, like walking, which should be regulated in distance and speed. Golf has a peculiar value, from the fascination it possesses for individuals of all ages, a point not to be lost sight of in the management of self-indulgent cases. Horseback-riding has the added advantage of vigorous massage, especially if the horse be trotted, and if the ravenous appetite resulting from the open-air exercise be kept within the limits of discretion.

For those who are unable to take more active exercise a course of gymnastics, including duplicate passive manipulation and

general massage, is highly beneficial, increasing the elimination without undue fatigue.

It must not be forgotten that a debauch of exercise in a valetudinarian may precipitate an acute attack by throwing into the circulation suddenly the fatigue products and causing an acute poisoning, so that great care should be observed to begin gradually and increase the amount as the system accommodates itself to the necessity for more active excretion.

Most of the health resorts to which gouty patients flock acquire and retain their reputation because of the healthy and moderate regimen, purgative waters, and regular habits that are required of patients taking the cure.

DIABETES

In the hygienic treatment of diabetes exercise has an important place, since muscular action favors the combustion of sugar, from whatever source it may be derived, and among diabetics the presence of constipation favors the onset of coma.

When present, constipation should be corrected by local and general massage daily, and by the simpler forms of free or duplicate movements.

Professor Finkler, of Bonn, tried general muscle kneading in fourteen diabetics daily, a twenty-minute treatment being given at first, afterward increased to twice a day. They remained on a mixed diet. There was a constant diminution in urine, decrease in thirst, increase in the body weight, and return of perspiration.

When the patient is sufficiently strong, he should be made to live as much as possible out-of-doors in a dry, warm climate, and a daily task should be set for him. The exercise should be gentle in character and carried out systematically. Gardening and walking, golf, or tennis should be the forms selected, but the patient should be warned to stop within the limits of fatigue.

A course can be carried on to the best advantage in a sanatorium, where the conveniences for bathing and massage are found, and where the habits of life can be regulated with greater hope of success.

RHEUMATISM

The manifestations of rheumatism, whether they appear in the muscles or in the joints, may often be treated by vibration and massage, with very considerable success.

In muscular rheumatism the sternomastoid, the erector spine muscles, and the lumbar fascia are favorite sites for the attack. There is probably a coagulation of the semifluid muscular substance, with adhesions and retention of waste-products, of which uric acid is the worst, causing pressure upon and irritation of the nerve-filaments, and spasm of the muscles.

The pain of this condition is exceedingly acute, and requires rest and counterirritation.

Vibration may be applied to inhibit the pain, by using the ball attachment, a medium stroke, and deep pressure several times a day over the spinal centers governing these parts, and the soft brush and rapid stroke over the affected parts themselves several times a day if the pain is acute. Massage is also useful, after the acuteness has abated, in soothing the irritation by gentle stroking and friction, increasing in force with the improved toleration of the subject. The evils resulting from forced inaction in patients who are suffering from muscular rheumatism, either in the lumbar region or elsewhere, is counterbalanced better by general massage than in any other way. The movements used vary from gentle stroking to deep kneading of the muscle masses, with manipulation to extend the stiffened joints gradually, but without causing severe persistent pain.

Arthritis deformans is an incurable disease, but the inevitable progress of deformity can be held back and great comfort can be given to the patient by vibration, massage, and manipulation.

Ankylosis may be prevented by checking the formation of adhesions, and the stretching and breaking down of those already formed, while atrophy of the muscles, always a pronounced symptom, may be delayed.

Douglas Graham reports most encouraging results in a number of cases treated by himself, five out of six showing marked improvement. His mode of procedure was deep manipulation without

friction, passive motion as far as the pain would allow, and sometimes farther, and resistive movements as soon as they could be done. He disregards pain if it rapidly disappears after the treatment; if it persists, treatment must be suspended.

He recommends kneading, with one hand, to break up indurations or disperse effusions, while the other pushes along the circulation in the veins and lymphatics above the joint.

Massage would not be used, of course, when the disease is very active.¹

Graham quotes the case of Admiral Henry, who was a sufferer from this affliction for twenty-eight years. In 1810, at the age of seventy-nine, he was quite crippled, but by means of various instruments, made of bone, polished smooth, and hammers covered with cork, he persevered in the use of deep friction and percussion night and morning for three years. At the end of this time, it is said, he had completely succeeded in removing the swellings and restoring the use of his limbs. At the age of ninety-one he wrote to a friend: "I never was better, and at present am likely to continue so. I step up and down stairs with an ease that surprises myself. My digestion is excellent, and every food agrees with me. I can walk three miles without stopping." Unfortunately, such a case is so exceptional as to have been passed down as one of the modern miracles.

GASTRITIS

Among the most amenable of the disturbances of nutrition to treatment by exercise are constipation and certain cases of chronic gastritis and diarrhea. Much attention has already been called to the inevitable disturbances of the digestive organs found in those leading a sedentary life, especially if they are gormandizers. But there is a class of cases in which the gastric disturbances are due to nervous causes much more than to indiscretion at the table. In advising massage or active movements for cases of chronic gastritis, great care should be taken, as in diabetes, to stop the exercise before reaching the point of exhaustion, and mild exercises

¹ Graham, "Massage," 412.

of endurance, like walking, in addition to massage of the abdominal walls, should be the forms recommended.

In nervous dyspepsia, which is so frequently a symptom of neurasthenia or hysteria, the rest cure of Weir Mitchell, with careful regulation of the diet, massage, and light resistive exercises, leading on to more active movements, should be given. In all such cases of gastritis massage should be given about two hours after a meal, and should include pressure and kneading of the hypochondriac and epigastric regions, from left to right and downward.

These movements give immediate relief in some cases. They force the stomach-contents into the duodenum, stimulate the action of the liver, and alternately compress and relax the gall-bladder. They should be followed by kneading along the course of the colon, and vibratory massage over the spine, from the fourth to the tenth dorsal, whenever tender points can be made out. The relief from the feeling of oppression and the more distressing nervous symptoms so frequently present in these conditions is often rapid and complete.

CONSTIPATION

Constipation may be due to constitutional peculiarities, to sedentary habits, to certain diseases, such as anemia or neurasthenia, chronic affections of the liver and stomach, or the abuse of purgatives. A general atony of the intestines accompanies weakness of the abdominal muscles in obesity and debility, and lassitude, headache, and mental depression are the most frequent symptoms which attend it; but persistent constipation may exist for weeks without other symptoms. Individuals differ greatly in this respect. A careful inquiry into the probable causes should be made in all cases of constipation. Some change in diet or occupation may be responsible, as is so frequently found among college students after leaving home. About 12 per cent. of college students complain of constipation in their preliminary physical examination, and most satisfactory results have been obtained by having them follow a list of five simple exercises for the abdominal muscles, which are repeated daily twenty times each.

When the causes are complicated and the condition persistent, all the resources of exercise should be brought to bear on the case, as well as the regulation of the diet and the drinking freely of mineral waters or other light laxatives.

The application should be in the form of massage, vibration, duplicate and active movements, and the cultivation of regular and systematic habits. The massage should be very deep and slow, following the course of the colon, beginning in the right iliac region, passing upward to the ribs, across the abdomen, just above the umbilicus, and down the left side, terminating in deep, slow, circular movements in the left iliac region, over the sigmoid flexure and the rectum (Fig. 321). These kneading movements should



Fig. 321. Deep rotating pressure massage (Gant).

be done very slowly, with firm, deep, and insistent pressure, the knees of the patient being drawn up and the abdominal walls relaxed.

This part of the treatment should last at least ten minutes daily.

A cannon-ball covered with chamois leather has been used for the same purpose, and most sanatoriums have the Zander machine, on which the patient lies face downward, the abdomen resting on

a loose leather diaphragm, beneath which a ball, set in motion by a motor, follows the course of the colon, giving continuous upward pressure. These movements are not so effective, however, as the trained human hand. The administration of vibrations along both sides of the spine, from the first to the fourth lumbar, will alone give immediate relief in some cases. Massage alone is scarcely ever sufficient in the treatment of constipation, according to Bolin, and certain active movements are necessary to supplement the more passive forms.

Among the exercises that have proved of value may be cited the turning of the nautical wheel (Fig. 34) and the trunk rotation described in Exercises I and II for abdominal weakness (Figs. 326, 327, 328).

Two exercises may be described that act directly by pressure on the abdominal contents:

Exercise I.—Patient lying supine on a couch, arms at the sides. Raise the right leg with knee bent. Clasp the hands over it and press it in against the abdominal wall. Repeat with the left (Plate II, Fig. 1). Repeat twenty times.

Exercise II.—Patient sitting astride a plinth, arms behind the back. Trunk circumduction bending well forward to the right, then forward and to the left (Plate II, Fig. 2). Repeat twenty times.

Circumduction of the pelvis is given most effectively by Zander's "camel," the patient sitting on an eccentrically moving saddle, or on the "horse," which is a substitute in movement for the trot, and riding on horseback itself is to be strongly recommended when available.

The effects of treatment should be noticed from the first, and relief is usually immediate and made permanent by continuing the improved physical habits.

HERNIA

Weakness of the abdominal muscles and fascia is responsible not only for many of the more chronic affections of the gastrointestinal tract, due to insufficient support or to lack of the normal massage, which the diaphragm and the abdominal walls should

PLATE II

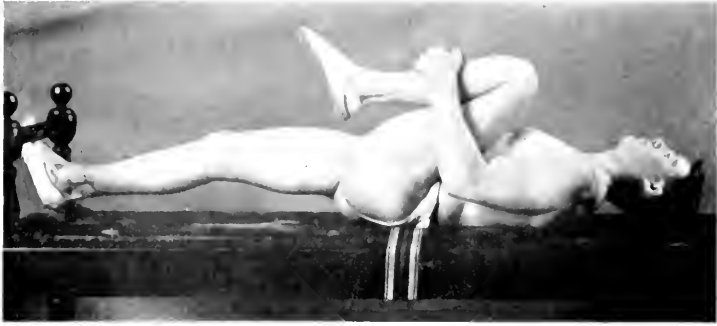

FIG. 1.



FIG. 2.

give to them, as already described, but the relaxation of the openings through which the blood vessels and other structures pass out of the cavity, leads to actual hernia of the viscera.

When hernia takes place at the umbilicus, there is a stretching of the fibrous tissue alone. When it takes place at the femoral ring, it is merely a dilatation of the innermost compartment of the femoral sheath. Inguinal hernia, which is very much the most common form, is, however, in part due to a stretching and spreading apart of muscle and tendon, and exercise may be of marked assistance in strengthening and closing the internal and external

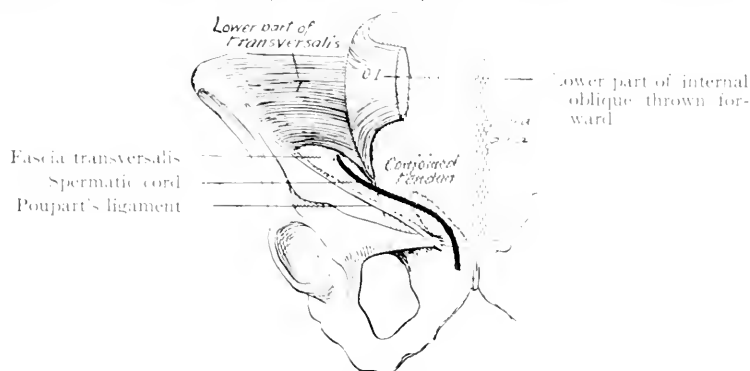

Fig. 322. Deep layer, showing internal ring and transversalis muscle. The dotted line shows the attachment of internal oblique.

abdominal rings, and so helping to guard against its advent or prevent its return.

A careful diagnosis is essential to exclude femoral hernia, and certain cases in which the bowel does not enter the internal ring, but breaks through the conjoined tendon directly beneath the external ring.

The internal abdominal ring is found just beneath the crescentic arch of the inferior border of the transversalis muscle. It is at this point that the vas deferens in the male and the round ligament in the female enters the abdominal wall. The transversalis takes its origin from the outer third of Poupart's ligament. The internal oblique has its origin from the outer half, so that its lower fibers cover the internal abdominal ring as by a lid, and the

development of this muscle has a distinct influence on the ring's integrity. The external abdominal ring is a slit between the tendinous pillars of the external oblique, and every contraction of

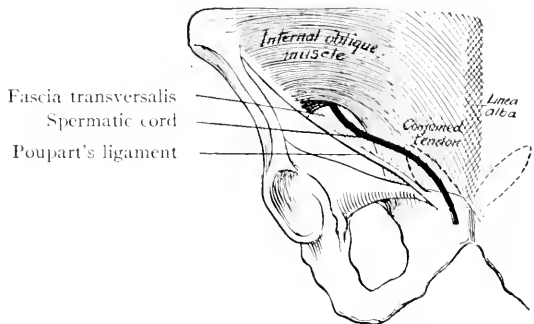

Fig. 323.—Attachment of internal oblique, showing the covering of the cord.

this muscle pulls these pillars together, closing it. This action of the muscle serves as an automatic protector of the opening during active exercise.

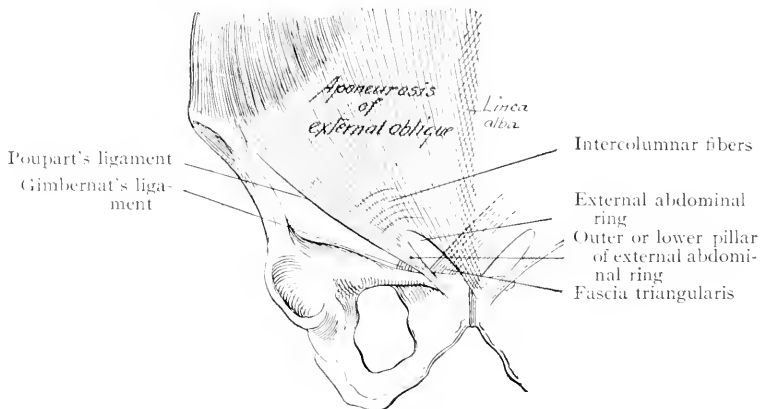

Fig. 324.—Superficial layer and external abdominal ring.

The inguinal canal, which is normally collapsed, is bounded, then, superficially from without inward, first, by the external and internal oblique; second, by the external oblique alone. Hernia may enter the canal at the internal ring, or break in through

the fascia that guards its center or inner end, tearing ahead of it or pushing aside the weakened conjoined tendon of the transversalis and internal oblique; but in all cases it makes its exit by spreading apart the columns of the external abdominal ring.

In threatened or actual inguinal hernia much can be done by strengthening the external and internal oblique and the transversalis muscles by active movements. The most suitable cases for this treatment are in children and adolescents, where the condition is not congenital and where natural growth assists in the process of repair, although good results have been obtained up to fifty years of age, either where hernia is actually present or where there seem to be the premonitory symptoms. One is frequently consulted for a dull, aching pain either in one or both inguinal regions, particularly after some unusual muscular strain or fatigue, by patients who, on examination, show unusually dilated external

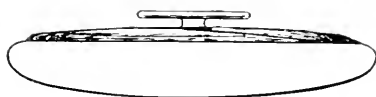

Fig. 325. Seaver's flat truss pad.

rings. There is tenderness and a distinct impulse on coughing, but no actual hernia. Others, again, in whom hernia is present complain of no inconvenience from it.

One man played foot-ball for years with an enormous scrotal hernia, which he did not even support. He then went to Cuba, did a great deal of horseback-riding and other violent exercise, during which it disappeared, is now quite sound, with no return for five years and no necessity for wearing a truss. This is, however, far from being a typical case, for strangulation may occur at any time, and forms a constant menace.

All hernias should, of course, be reduced and retained, preferably, by a truss that does not present a convexity of surface great enough to enter and spread the abdominal ring. The flat pad described by Jay W. Seaver (Fig. 325) is comfortable to the patient, can be kept clean at all times, and can be worn in the water without damage. It is especially suitable for young men. It con-

sists of a small steel band, covered with vulcanized rubber, and a hollow rubber pad two inches in diameter as the support.

In a recent hernia, where pain is present, the patient should remain quiet for a week or two, to get accustomed to the feel of the truss, and should then begin a course of light work for the abdominal muscles, as well as more general exercise for the whole muscular system. These exercises should be done daily and should be increased in number, complexity, and resistance.

Great stress should be laid on teaching control of the abdominal muscles by forced breathing and abdominal exercises. The extent to which specialization and rhythmic contraction of these muscles can be carried is shown in the movements of the Oriental *danse du Ventre*. As the strength and control of the abdominal muscle increases, the work is intensified and extended. Seaver allows his patients the most trying gymnastic feats, such as the layout on the horizontal bar. The movements must be varied. Such a movement as lying on the back and raising both legs to a perpendicular position does not produce the desired result, as the strain falls chiefly on the rectus abdominis and psoas muscles.

The most effective movements are those in which flexion of the trunk is accompanied by side-twisting. Great stress should be laid on the deepening and raising of the chest, thus drawing up the abdominal contents, and relieving the downward thrust of the thorax and upper abdominal structures.

During exercise the abdominal rings should be protected by the truss or by the finger placed so as to keep up a continuous pressure.

A day's work should begin with Exercises Nos. I, II, and IV, recommended for the development of thoracic and abdominal breathing, and then the following movements should be introduced:

Exercise I.—Patient lying on the back, one hand behind the neck. The other placed so that the middle finger covers the inguinal canal and external ring (Fig. 326). Raise the head and shoulders, twisting to the right for a hernia of the left side. Repeat twenty times without holding the breath. In a double hernia both hands should cover the abdominal ring and the twisting should be to alternate sides.



Fig. 320.

Exercise II.—Patient standing, hands clasped behind the head. Trunk circumduction to the right (Fig. 327), backward (Fig. 328),



Fig. 327.



Fig. 328.

to the left and forward (Fig. 320). Repeat five times and reverse up to twenty times. The breath should not be held

during this exercise and the hernia should be kept up by the truss.

This movement brings into action all the abdominal muscles, and keeps the chest in the best possible position.



Fig. 320.

Exercise III.—Patient seated, facing stall bars, feet fixed, hands on the hips, with fingers over the ring. Backward bending and twisting to the right and to the left alternately, without holding the breath. Repeat twenty times.

This brings in all the abdominal muscles, the lateral twisting especially causing a powerful action of the obliques. It may be modified by placing the hands behind the head (Fig. 330) after the muscles have been developed enough to stand it, the truss being in place.

The nautical wheel is a valuable piece of apparatus in the treatment of this condition (Fig. 34), as are all the lateral trunk movements of the Swedish gymnastics.

Massage with the finger-tips, consisting of kneading and pétrissage, should be used over the abdominal rings at the end of each treatment, to stimulate the local circulation and promote their contraction.

Under this developmental treatment, Seaver reports that over 70 per cent. of his cases have been relieved of the necessity of wearing a truss of any kind, and my experience would confirm his observations.

I have also seen the greatest benefit resulting from it in men up to fifty-five years of age, the general improvement in tone of the abdominal muscles and relief from the constant pain and dragging



Fig. 339.

sensation being complete, while the muscles acquire an alertness in contraction that prevents their being taken by surprise by an unexpected movement or strain.

It is frequently due to the sluggish and ineffective action of these neglected muscles that hernia is allowed in the first place, and their education and development form the best protection against its return.

CHAPTER XXIII

EXERCISE IN THE TREATMENT OF NERVOUS DISEASES

MASSAGE, mechanical vibration, and active exercise influence disorders of the nervous system through their power to control pain, to improve the nutrition of the affected region or the general health of the patient, and to reëducate disordered or impaired coördination.

INFLAMMATORY CONDITIONS OF NERVES

In acute inflammation of the mucous membranes of the throat and lungs or of the abdominal organs, points painful to pressure are found along the spine, at the level from which the sympathetic nerve-supply of those areas or organs is derived.

According to Lightner Witmer,¹ the evidence seems to point to certain tracts in the spinal cord possessing a specific pain function. These are situated a short distance above the segment of the cord that receives the peripheral nerves. The viscera refer their pain to this pain-organ of the spinal cord through the sympathetic nerves, which communicate with the spinal nerves before entering the cord itself.

The application of massage or vibration over these painful points, which mark the posterior primary divisions of the cervical or dorsal nerves, is generally followed by temporary relief of the symptoms. This pain-organ is anesthetized, or at least for the time being its capacity for feeling pain is exhausted. The points at which this stimulation should be applied and its amount and nature have already been described in the chapter on Mechanical Massage.

¹"Twentieth Century Practice of Medicine," xi, 1905, 45.

Vibration over the lower lumbar and sacral regions for inflammation of the sciatic nerve is frequently followed by immediate relaxation of muscular spasm.

In sciatic neuritis this treatment has been used with great success, either in the form of vibrations, as described above, or after the method of A. Symonds Eccles, who starts with two daily treatments of five or ten minutes after the first few days of the disease, gradually increasing them to twenty minutes each. He uses friction and kneading directly along the course of the nerve and its branches, beginning at the heel and working upward.

Before giving a prognosis or undertaking treatment the diagnosis between neuritis and rheumatism should be made.

Muscular rheumatism is aggravated by motion and relieved by rest and warmth, whereas in a true neuritis the pain is worse at night, while the patient is warm and at rest, and wears off when he is up and moving about.

The relief from discomfort and the freedom of motion experienced after each massage are great, although they may be but temporary, and repeated massage extending throughout the necessarily slow recovery increases materially the patient's comfort. In the later stages, when the pain is almost gone and stimulation is well borne, hacking movements and deep vibration are added. Passive movements, in which the thigh is flexed, the knee-joint being kept in extension, stretch the nerve and frequently give relief; and, finally, toward the end of the treatment, active movements are of value in counteracting the atrophy that results from inaction and the disease itself.

Graham deprecates the use of massage over the sciatic nerve, and confines his manipulations to the muscle masses of the front and sides of the thigh, with gentle stroking only on the posterior aspect of the limb. Where hacking and percussion are used, the movements should be gentle, and any increase in the pain after massage should be a sign to desist.

Massage is not well borne in brachial neuritis, especially during the acuteness of the attack, and absolute rest is then essential.

Only in the later stages may it be employed, and then with precautions to avoid a reawakening of the inflammatory process.

Balfour, of Edinburgh, employed percussion and compression for neuralgia in 1819.

Eccles reports relief by local massage of intercostal neuralgia and neuralgia of the cervicobrachial nerves. In the trifacial and occipital forms relief is sometimes afforded by gentle percussion and kneading of the scalp and face over the seat of pain.

The improvement in the circulation and the elevation of the subnormal local temperature by the warmth of the hand during massage are doubtless contributory causes to the relief of these symptoms.

Nerve excitation and vibration for the relief of pain by means of percussion became of great interest and importance as a result of Dr. J. Mortimer Granville's experiments in London.

Acute pain he likened to a high note in music, produced by rapid vibrations. Dull aching pain he likened to low notes, caused by slow vibrations. He attempted to bring discord into the rhythm of morbid vibrations, and so relieve or cure the neuralgia by his instrument, the "percutor," in which the rate of blows could be changed at will, and the modern vibrator is but a modification of his instrument.

OCCUPATION NEUROSES

Scrivener's palsy has become comparatively rare with the increased use of the typewriter, but exhaustion neuroses are frequent among piano-players and violinists, baseball-pitchers, and telegraph operators.

While no morbid anatomic change can be made out, this trouble appears to be the result of an exhaustion or overexcitability of the centers controlling the muscular movements most involved. The symptoms are cramps and spasms of the muscles, weakness and debility, extending even to paralysis, tremors, a feeling of great tiredness, with acute shooting pains, and sometimes a subacute neuritis, with pain, numbness, or tingling in the fingers. These conditions run at best a chronic course, which can be greatly

shortened if perfect rest from the habitual movement and daily massage and manipulation, with simple gymnastics, be applied.

In one of my cases, a violinist, a nervous girl of fourteen, with fatigue pains coming on rapidly and numbness of the third and fourth fingers of the left hand, a daily course of massage, consisting of friction and kneading of the fingers and small muscles of the hand, forearm, arm, and shoulder, accompanied by manipulation of the joints separately and a few simple gymnastic exercises for the fingers separately and together, brought about a complete recovery in about two months, enabling her to resume her study. This is an unusually favorable result, and under the best of conditions the tendency to relapse must be kept in mind.

INFANTILE PARALYSIS

The onset of this disease is usually without warning, beginning with vomiting and fever, and the paralysis may often be found the next morning, but usually comes on from two to four days afterward. Sometimes it is not noted for a week or ten days. It is accompanied by rapid wasting of the muscles, which, however, may be obscured by the presence of fat. Sooner or later contractures develop, causing eversion or inversion of the foot, overextension or flexion at the ankle, while dangle foot is present after complete paralysis of all the muscles.

There may be overextension of the knees or relaxation of the abdominal walls, simulating hernia; the scapulae may be winged as a result of paralysis of the serratus, and the unbalanced actions of the arm and hand muscles may produce marked deformities.

The paralysis is characteristically random in its distribution (Gowers), but the following table shows the most frequent combinations of regions involved.

TABLE SHOWING DISTRIBUTION OF PARALYSIS

	Duchenne.	Seeligmuller.	Sinkler.	Starr.	MacPhail.	Total
Both legs	0	14	107	40	45	215
Right leg	25	15	63	20	9	132
Left leg	7	27	62	27	20	143
Right arm	5	9	5	7	4	30
Left arm	5	4	8	4	2	23
Both arms	2	1	1	2	2	8
All extremities	5	2	35	5	4	51
Arm and leg, same side	1	2	20	4	11	44
Arm and leg, opposite side	1	2	1	4	0	8
Trunk	1	0	22	3	0	26
Three extremities	0	0	10	2	2	14
Total	62	75	340	118	99	694

The groups involved may be discovered by the wasting, by electric stimulation, and by careful examination of the actions that are imperfect or absent. The voluntary movement present must be estimated with great accuracy, and the difficulty of this has been insisted upon by Beevor, in his Croonian Lectures on Muscular Movements (1903).



Fig. 331.—Incorrect position for testing the action of the triceps.



Fig. 332.—Correct position for testing the action of the triceps.

Among the fallacies that may occur are the confusing of the action of gravity for muscular action. A slow relaxation of the active biceps may be confounded with contraction of the triceps

when the bent arm is slowly straightened when hanging at the side, whereas if the arm be first flexed and the elbow be held at the level of the shoulder and the patient told to extend it, he will be unable to do so (Figs. 331 and 332).

Another error that must be guarded against is the crediting of a muscle with contractile power when the movement is the



Fig. 333.—Correct position for testing the action of the flexors of the elbow. The swinging of the arm is thus prevented.

result of the action of accessory muscles. In flexing the arm where the biceps is affected, the contraction of the supinator longus and brachialis anticus may disguise the true lesion. The habit that patients acquire of jerking the arm or leg upward or forward, and so simulating the movement of muscles which are actually inert, must also be detected (Fig. 333).

These fallacies should be demonstrated to patients in order that they may not be deceived as to the actual condition present.

The outlook for complete recovery of a group long paralyzed is bad, but a gradual restoration of power may go on throughout several years, and Jacob Bolin reports the return of contractility after ten or twelve years. If these cases are neglected, however, the atrophy becomes extreme, the growth of the bones is retarded, and unopposed active muscles contract and produce deformities.

Treatment may be begun as soon as the child can bear friction of the affected part.

It should consist of massage of the affected region from the periphery to the center, friction with deep kneading, and stroking to increase the circulation, which is always defective, as shown by the constant subnormal temperature.

A splint may be necessary to prevent overstretching of the paralyzed muscles from the unopposed action of their uninjured antagonists. Whenever any voluntary action remains in the affected muscles, it should be carefully fostered by gymnastic exercises, to train the patient's will-power and concentration.

Every means must be used to maintain the nutrition of the muscles, so that recovery of the injured centers in the cord may find well-nourished muscular tissue on which to act. Flannel bandages or a covering of rabbit skin should be kept on the limb, so that its temperature may be continually kept equal to or above its fellow, and the muscles, bones, and joints given the increased blood-supply.

The technic of massage may be taught to the mother or nurse, to be continued daily at home, in addition to the less effective stimulation by electricity, and it should be persisted in throughout the entire period of growth, where necessary, accompanied by frequent examinations and measurements.

NEURASTHENIA

Hysteria and neurasthenia require massage and resistance movements for their complete management. In Weir Mitchell's treatment for these affections he first counteracts the evil effects

on the digestion of overfeeding and continual rest in bed by massage and gymnastic movements, to reaccustom the patient gradually to the muscular tasks of daily life.

His custom is to begin with a general massage after the first few days of milk diet, the hour chosen being midway between two meals, the patient remaining in bed. The operator starts with the feet, continues the manipulations up each leg, then to the muscles of the loins, spine, abdomen, and chest. The order of movements is described in the chapter on Massage. The entire treatment lasts about half an hour, and is gradually increased up to one hour, followed by an hour of rest. This is continued for at least six weeks, and then half an hour is devoted to massage and the other half to movements of flexion and extension of the limbs and trunk, with resistance. In the less severe cases confidence is put in the more active forms of exercise. One young man referred to me by him began by wrestling exercises in which at first he did little more than gently resist the various positions, locks, and throws. The resistance gradually increased in force and duration until, at the end of three months, he had gained sixteen pounds in weight and had improved so much in strength, courage, and vigor that he was sent home cured. Other cases derive the greatest benefit from an active outdoor life, in which camping, swimming, walking, riding, and wrestling form a great part of the day's program.

Exercise should be made as simple and interesting as possible, the object being to improve the nutrition to the utmost without unduly exhausting the attention or overtaxing the coördination. For this reason exercise demanding skill and concentration, like fencing, should be avoided.

STAMMERING

Exercises of skill are employed almost exclusively to correct such disordered coördinations as stammering and stuttering, where the utterance of intelligible speech is hindered or prevented by convulsive and disorderly contraction of the muscles of respiration, phonation, or articulation.

Stammering occurs in about 1 per cent. of school children. Although accurate statistics are hard to get, the Germans show about 1.22 per cent. in the schools, whereas Hartwell's statistics show about 0.78 per cent. among the children of Boston.

Stammering is exceedingly contagious in a class, and rapidly spreads among school-children, making schools, according to Melville Bell, veritable nurseries of stuttering.

It has been attributed to the forcing of their education before the brain is sufficiently developed to govern the power of vocal utterance, so that a course of treatment would begin with gymnastic exercises, such as described in Chapter XIV, for the breathing muscles, the first to function in the development of the child, while, later on, the muscles of phonation, and, lastly, those of



Fig. 334.—The points of contact between the tongue and palate in the formation of the sounds L, R, and K (G. Hudson Makuen).

articulation, are trained. Treatment would thus be based on the preliminary development of the fundamental and intermediate mechanisms, ending with the finest and most specialized coördinations.

Audible speech is caused by the blast of air driven from the lungs by the muscles of expiration through the slit of the glottis, bounded by the vocal cords, whose approximation is varied by the laryngeal muscles, into the mouth, where it is formed and modified by the muscles of the palate, tongue, and lips. The complete production of speech, then, is effected by a coördination of muscles in the chest, throat, and mouth respectively.

Hudson Makuen lays special emphasis on the difference between ordinary passive breathing and the breathing of voice production, or "artistic breathing," the function of passive breath-

ing being simply to aerate the blood and eliminate waste matter, while breathing for voice production is to set the machinery of the voice in motion and to control this motion as a definite voluntary muscular process.

The first muscular act in breathing for voice production is a slight inhalation, putting the respiratory muscles and the thorax into an active position. He finds that nearly all speech defectives fail at this point.

When this is done properly, the column of breath raised upon the diaphragm is ready for its impact against the vocal cords—an impact which must be made with the greatest nicety and control. This movement of expiration for voice production he attributes to the depression of the lower ribs by the diaphragm—a muscle of

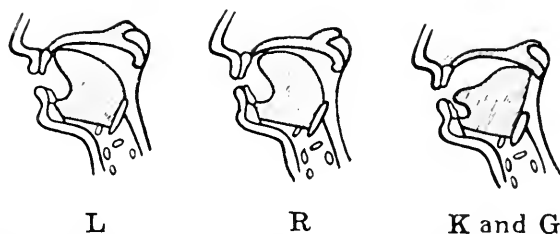

Fig. 107. The position of the tongue in producing the sounds L, R, and K (G). Hudson Makuen.

inspiration in ordinary respiration, whereas in the "artistic" breathing needful in voice production it becomes a muscle of expiration, not only by preventing the pulling up of the ribs, but by pulling them downward and inward. Proper coordination of the intercostal and abdominal muscles in addition to this action of the diaphragm is, of course, essential to the production of good tone.

Treatment of stammering would then be begun by the training of this respiratory coordination by itself, which is done by articulating a series of syllables, using for each a single expiratory effort. The muscles that control the vocal cords are also trained by exercises; and the coordination between the muscles of expiration and the laryngeal muscles are then trained to act together, since many stammerers vocalize at the wrong time, there being no column of air ready when the cords are in the right position, or vice versa.

The pharynx, the palate, the tongue, and the lips, organs of articulation which mold the voice into speech, are also controlled by voluntary muscles. Where there is any organic defect in them, such as shortening of the muscular fibers, cleft palate, or harelip, this must be corrected, and the rest becomes a purely educational process.

Care must be taken to distinguish between lack of development, faulty habits, and disease in the speech center of the brain, for in the last class of cases the outlook is hopeless.

The entire treatment of functional stammering and stuttering is based on the physical training and coördination of the mechanisms of speech, the proper use of the muscles of respiration with reference to voice production, the training of the vocal muscles, and the education of the muscles of articulation.

Exercises are given to instruct the patient in the elementary sounds of the language, how to shape the lips, or where the tongue is to be placed, and this training requires patience and perseverance until the defect is finally overcome.

The success that has attended Makuen's clinic on speech defectives is in great part due to the care with which the breathing and vocal exercises are graded, and the excellence of his discipline in enforcing their accurate, thorough, and persistent practice.

The high-pitched, falsetto, or cunuchoid voice, which occasionally occurs in men otherwise normal, can be corrected, according to E. E. Clark,¹ by a course of vocal gymnastics and singing exercises, beginning with a note of high pitch and then singing down the scale until the lowest possible note on the register is reached. The voice is then kept at this pitch, and the low notes are repeated ten or fifteen times. The patient is then taught to read aloud in the deep tone secured by singing his way down the scale. Makuen secures the same result by training the patient to lower the position of the larynx during phonation.

CHOREA

Chorea is a disturbance of coördination characterized by irregular involuntary contraction of the muscles, accompanied by

¹ "Medical Fortnightly," St. Louis.

psychic disturbances, found mostly in young children, the proportion of girls to boys being 3 to 1.

It occurs especially in abnormally bright, active-minded children, who are forced ahead of their grade in school, and are subject to the excitement of competition for prizes. While there are no constant anatomic changes found in the nervous system after death, the tendency to endocarditis is such that in 110 cases of autopsy the effects were noted in nearly 100.

The duration of an attack is very variable—from two to three weeks to the same number of months—with an average of about eight or ten weeks.

Because of this great liability to endocarditis the heart should be carefully examined in all cases. The presence of a murmur alone does not indicate endocarditis, since the disease occurs most frequently in nervous young girls in whom heart murmurs are almost the rule. If the apex is in the normal position and the area of dulness is not increased vertically or to the right of the sternum, there is probably no serious valvular disease.

The treatment of the acute attack consists of rest, isolation, and tonics. Where the jerky movements have abated, the application of general massage is of value, and the importance of gymnastic exercise cannot be overestimated during convalescence.

When the acuteness of the attack has subsided, the treatment should be begun with massage for the first few days, followed by simple, slow, resisted movements, and later on by rhythmic exercises sufficiently active to tire the muscular system moderately. This should be done with the patient by herself if possible, and any excitement or competition of class drills should be sedulously avoided.

The keynote of such treatment is the rhythmic repetition of simple movements to overcome the irregularity of the twitchings, and great strain or fatigue on the attention of the patient should be eschewed.

The practice of simple dancing exercises to music is of the utmost service, emphasizing the rhythm and taking away the mental strain necessary to follow movements done to command.

CHAPTER XXIV

THE TREATMENT OF LOCOMOTOR ATAXIA BY EXERCISE

LOCOMOTOR ataxia, or tabes dorsalis, is a degeneration of the posterior roots and columns of the spinal cord, produced by exposure to cold, syphilis, or some other acute poisoning of the nerve tissue.

In reading the literature of the subject one is struck by the multitude of theories and the inadequacy of any one of them to explain many of the symptoms.

The hypothesis that is of most interest in connection with the application of exercise is that of Edinger, called the "exhaustion theory," in which he believes that the cells of the body are normally in a state of equilibrium, one with the other, so that if a cell becomes weakened by disease, other cells lying beneath it will crush it out in their growth. Again, when the amount of work required from a group of cells is too great, even if their vitality be perfectly normal, they may succumb simply from their inability to recuperate and regain the loss of tissue due to their excessive activity. A similar condition is found in occupation palsies. The nutrition of the cells may be impaired through toxins circulating in the blood, especially if they have a selective action on certain parts of the nervous system; and nearly 90 per cent. of tabetic patients show a history of syphilis.

The exhaustion theory would help to explain the frequency of the first appearance of ataxia in the lower extremities, the neurons governing them being constantly employed in the maintenance of equilibrium.

Cases may be cited where ataxia has first appeared in the arms, owing to overfunctioning. One case reported by Mott occurred

in a mounted policeman in whom the symptoms started in the arm with which he held his horse's reins.

In tabes the sensory nerves are also affected, and the eyes show a characteristic optic atrophy with the Argyll Robertson pupil. Men being more exposed to these fatigue influences than women, we would expect to find its frequency greater among them; and the proportion is actually about 10 to 1, and James Stewart has noted its frequency among lumbermen who have lived a hard life in the logging camps during the winter and spring months.

The motor symptoms are first noticed as increased clumsiness, especially in the dark, or difficulty in maintaining the equilibrium when washing the face with the eyes shut (Osler). When the patient stands with feet together and eyes closed, he sways and



Fig. 336.—Hypotonia of the muscles of the pelvis and spinal column (Frenkel).

may even fall if the surgeon does not steady him (Romberg's symptom). On turning quickly he is apt to fall. He leans upon a stick in walking, the eyes fixed on the ground, the body thrown forward, and the legs wide apart. The leg is thrown out violently; the foot is raised too high and is brought down with a stamping movement on the heel. In the arms it may be first noticed, through his difficulty in buttoning his collar or in other simple acts.

With comparatively advanced ataxic symptoms he shows little alteration in the size, strength, or nourishment of the muscular system. There is, however, always present in a typical case, along with certain sensory disturbances, hypotonia, or lack of muscular tone, which allows the stretching of muscles and joints far beyond their normal range of movement (Frenkel). This may be associated with flabbiness of the muscles, but it has no connec-

tion with their actual strength, which is seldom impaired.¹ The ataxic symptoms may be classified as—(a) Abnormally rapid movements; (b) exaggerated muscular exertion in performing simple actions; (c) prolonged contraction, continuing after the movement has been completed, and (d) jerky staccato progression.

While ataxia is the only symptom that can be reached by exercise, it is frequently sufficient to keep a patient bedridden when his other symptoms are not severe enough to interfere with his regular course of life.

The exercise treatment is based on the possibility of educating the impaired central nervous system, and reëstablishing the lost or enfeebled coördination and sensibility. The symptoms against which it is directed is a motor disturbance, which has its origin not in a diminution of the muscle's motor power, but in a loss of sensibility in them, and it is based on the capacity of the neuromuscular system for education so long as the motor apparatus itself is intact. It consists in relearning the ordinary movements, lost in consequence of a partial or total loss of sensibility, a task which in principle is identical with the acquisition by a healthy person of a complicated feat involving a nice adjustment of muscular action, such as juggling or balancing. Reliance must then be placed mainly on exercises of skill, alternating with passive movements and massage, as a relief to improve the nourishment of the muscles without continuing the demand on the rapidly tiring will-power.

The exercise treatment of ataxia has been popular for many years in Sweden, and was used forty years ago in America by Dr. Weir Mitchell, but many of the devices employed have been invented by Frenkel, of Heiden, and are for the first time described in his work on tabetic ataxia, from which some of the accompanying illustrations are taken.

In attempting the simple movement of rising from a chair the tabetic patient usually forgets to draw the feet backward, and so finds himself unable to rise without assistance. He has thus to learn this simple coördination over again.

¹ Frenkel, p. 46.

Movements of walking forward, backward, and to the side, with steps of measured distance, should next be practised. For this purpose the floor may be painted with black lines or with foot-prints at measured distances (Fig. 337). If lines be drawn zigzag on the floor, their continual change of direction makes this walking exercise much more exacting to the patient, and an irregular pattern on a carpet has been used for this purpose.



Fig. 337.

When these simple movements have been mastered, walking up and down stairs with the use of a bannister should be practised. A special stairway designed by von Leyden has two bannisters, and the steps are cut so that the foot must be placed down accurately at each step (Fig. 338).

The greatest precautions must be taken to prevent the patient from falling in this exercise and so becoming timid or discouraged. A belt with a handle or strap attachment should be placed about



Fig. 338.—Dr. von Leyden's stairway used for exercises to re-educate the lost coordination in locomotor ataxia cases (Pennsylvania Orthopaedic Institute and School of Mechano-Therapy (Inc.), Phila.). (Courtesy of Mr. Max J. Walter.)



Fig. 339.

the waist, and an attendant should always be ready to catch him if he shows signs of losing his balance. Exercise of the lower

extremities can be carried on in bed, where the disease is too far advanced to permit of walking or standing. He is told to touch the great toe of one foot with the heel of the other (Fig. 339), then



Fig. 340.

to run the heel upward along the front of the shin to the knee (Fig. 340), and back again. Another exercise is the placing of

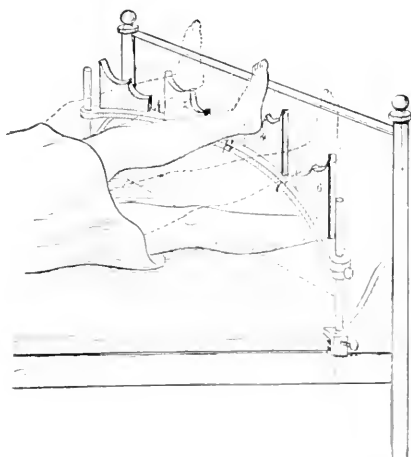

Fig. 341.—Notched board (Frankel).

the heel of either foot in notches cut in a board, as shown in the illustration (Fig. 341). If the patient be seated in front of a set

of movable pins, he can exercise by kicking them in turn, the attendant naming the one that he must touch with his foot (Fig. 342).

Simple movements such as these will cause rapid exhaustion, and the pulse-rate must be carefully watched, and the exercise stopped short of fatigue.



Fig. 342.—Dr. von Leyden's ten-pin arrangement used for the re-education of lost co-ordination in locomotor ataxia cases (Pennsylvania Orthopaedic Institute and School of Mechano-Therapy (Inc.), Phila.). (Courtesy of Mr. Max J. Walter.)

The upper extremity may be trained by taking a wooden block about eighteen inches long and triangular in section, so prepared that one edge remains sharp, a second beveled off, while the third has a curved groove. The block is placed on a table in front of the patient, in a position indicated by the drawing (Fig. 343), with the grooved edge up. He is requested to draw the point of a stout pencil or pointer along the groove from the farther end of the block toward him, at the same time holding

his fingers and wrist-joint perfectly stiff. The object of the exercise is to teach him to keep his arm raised in a definite position, and to make simple excursions in the horizontal plane.

This exercise is by no means easy, especially when the pencil has to be held with the slightest force. At first it will often leave the groove, but with practice its progress becomes more steady, although scarcely ever free from wobbling.

It is usually a great surprise to a patient on his first examination to find that he is unable to place his finger to his nose

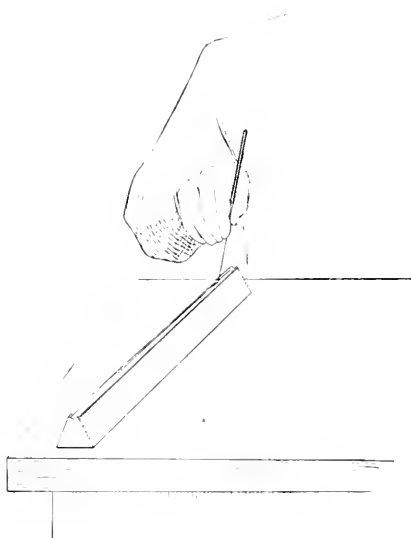

Fig. 343. Triangle block for the hand coördination (Frenkel).

with the eyes closed. This simple exercise may be practised and varied in numerous ways. Frenkel uses a perforated board (Fig. 344), the tip of the forefinger being placed in the numbered hole called out by the attendant. It can be made more difficult by having him insert pegs into the holes.

When this coördination is sufficiently improved, he may advance to the catching of colored balls swung from a horizontal bar and caught on the swing (Fig. 345); and he may be set to copying diagrams with a pencil. As soon as he shows signs of

flagging interest, his task should be replaced by another set of exercises.

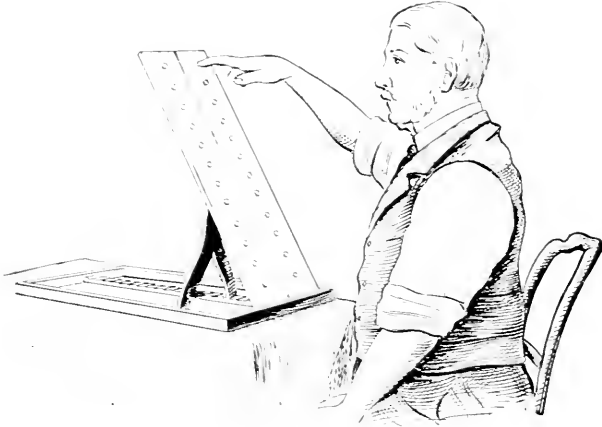

Fig. 344.—Perforated board (Frenkel).

Along with these set exercises he should be trained in the useful operations of dressing and undressing himself, helping

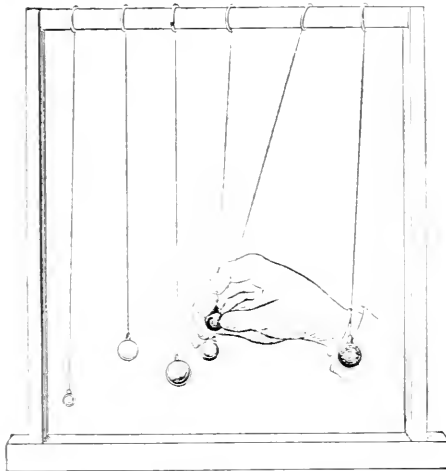

Fig. 345.—Colored balls swinging (Frenkel).

himself at the table, using pen and ink, and other procedures that come up in the course of the day.

The exercises are useful only when the attention is fully concentrated on them. This necessity for concentration and the excessive muscular exertion required to perform simple acts, the fear of accidents, and the annoyance which he feels, especially at the beginning of the treatment because his limbs will not obey orders, all combine to produce rapid and profound fatigue, and the practice of any movement should not be continued for longer than three or four minutes. In severe cases, where nutrition is impaired, one-half to one minute will be quite sufficient until he has become strong enough to bear the strain of longer-continued practice and no new exercises should be begun until there is complete recovery from the excitement and fatigue of the previous one.

Tabetic patients have more or less completely lost the sense of fatigue, consequently in determining whether he is tired or not signs of inattention and the rapid action of the heart will be the most reliable guides. The pulse usually rises to 120, or even to 100, beats a minute, in direct proportion to the difficulty of the movement. It should be the routine practice, therefore, to examine the pulse at the beginning of the treatment and frequently throughout it, and to interrupt the work by a period of rest as soon as the pulse-beats exceed 150.

The interval of rest should last until the heart-rate approaches normal again, although in most cases the pulse will remain a trifle above its usual rate. If it becomes unduly frequent after slight exertion, it is a sure sign of tabetic cachexia, and such patients must be treated with the greatest caution.

The exercises are for coördination and not to increase the muscular power, therefore no exercise requiring much expenditure of strength is of proportional value as a training in coördination, and so must be considered harmful.

Two periods of exercise a day are the average rule for practice. To go beyond that is to go into the danger zone, unless each séance be made short, and the patient is robust and determined to make rapid progress. In this case three periods may be given. In the morning he takes the movements designed for the recumbent position, which are the easiest. In the afternoon he may have dif-

teen minutes of walking exercise, with frequent rests. If the amount be properly regulated, each successive exercise should be followed by an increase in control, so that at the end of a period he should feel more fresh and vigorous than before starting. It is wise in some cases to substitute for one period a general massage or electric treatment, which has the great advantage of resting the patient's will and attention and improving the nutrition.

The unfailing certainty of the improvement and the fact that it is the improvement of a symptom caused by an organic lesion attaches unusual interest to this treatment. The hypotonia and sensory symptoms remain practically unaffected, although very frequently they seem to improve, probably because the patient's mind is diverted from them and directed to the acquirement of muscular skill; the improvement in muscular control, however, may remain for years.

The ideal result would be the restoration of the normal accuracy, control, and velocity of the movements, a result which Frenkel claims to have achieved in many cases. The restoration in locomotion is, however, generally sufficient to enable the patient to resume his usual business or profession, and this is all that may be expected.

In one case coming under my own observation, treated by John K. Mitchell at the Orthopedic Hospital in Philadelphia, and not by any means an unusual one, a miner from California who came bedridden and accompanied by an attendant improved to such an extent that he was enabled to travel across the continent by himself and resume the active management of his mines. Such a result is so frequent as to be almost the rule.

The improvement is more or less lasting as the patient's occupation does or does not entail constant overstrain. If the ataxia does increase again, a course of exercise will once more bring it under control.

In giving a forecast of the progress to be expected in any case the natural disposition, the alertness, and the ability for muscular exercise must be found out and given full weight by the surgeon. The more skilful patients will make more rapid progress, and the best results are obtained among those who have

been accustomed to work demanding dexterity, or who have been successful devotees of athletic sports, men who have lived a good deal in their muscles, and who have at one time had the muscular sense well developed.

Another important factor is the patient's personal courage. Apprehensive or cowardly patients will not risk the slightest movement without support or attention, and will have to practise for a long time before much definite improvement can be noticed. The longer and more thoroughly a course is continued, the more certain and lasting will be the improvement, and the closer will the patient approach to the normal in motor capacity and accuracy of movements.

INDEX

- ABDOMINAL control, exercises for, 220
Accidents in athletics, 100
Activity of child, 158
Adami on dilatation of heart, 317
Adam's position, 282
Age limit in games, 125
Amberst, Dr. E. Hitchcock at, 175
 German gymnastics at, 82
 physical education at, 175
Anatomy in jiu jitsu, 109-112
 of hernia, 303
Anders on obesity, 340
Anemia, exercise in, 220
Apparatus employing friction, 64
 Goldthwait's, for round shoulders, 203
 gymnastic, origin of, 128
 physiological classification, 120
 Lovett's, for stretching round shoulders, 204, 205
 school furniture as, 106
 Swedish, 101
Argyll-Robertson pupil in ataxia, 383
Arnold, E. H., on games, 104
Arterial tension, measurement of, 34
Arteriosclerosis, causes of, 322
 definition of, 323
 diagnosis of, 324
 in Cornwall miners, 322
 Peacock on, 322
Articulation, teaching of, 205
Artificial respiration, 233
 Sylvester on, 204
Astigmatism in scoliosis, Rogers on, 270
Ataxia, Argyll-Robertson's pupil in, 383
 exercises for, 385
 treatment of, 384
 Frenkel on, 384
 John K. Mitchell on, 302
Ataxia, prognosis of, 302
 rapid fatigue in, 301
 Romberg's symptom of, 383
 Stewart on, 383
 symptoms of, 383
Athletes, examination of, 100
 scholarships of, 100
 Stengel on heart-murmurs in, 310
Athletic League in N. Y. Public School, 168
 in public school, efficiency tests in, 170
 sports, conduct of, 100
 training, aims of, 42
 dangers of, 42
Athletics, accidents in, 100
 class, 184
 for blind, 105
 specialization in, 180
Automatism in exercise, 41
BACK, examination of, 254
Balck, Colonel Victor Gustave, 91, 102
Balfour on neuralgia, 372
Barr, Maurice E., on mental defectives, 214
Bartlett gymnasium, Chicago, 175
Basedow, 74
Bed-posture, Brackett on, 280
 Fitz on, 280
Beevor on tests for paralysis, 374
Bell, Sir Charles, 20
Benke on heart growth, 38
Bernadotte, sympathy with Ling, 88
Bernard, Claude, lectures of, 60
Beveridge's rubbers, 66
Bezly Thorne on exercise for heart, 325-320

- Bicycling, effect on blood, 32
- Bishop, Emily, on Delsarte, 115-117
- Blake on marathon races, 320
- Blind, athletics for, 201
- compulsory exercise for, 107
 - exercise for, 105
 - games for, 108
 - gymnasium construction for, 105
 - measurements of, 105
 - physical education for, 105
 - limitations of, 104
 - recreation for, 107
 - Van de Walker on, 100
- Blood-count, J. K. Mitchell on, 227
- of athletes, 31
- Blood-pressure, Bowen on, 317
- Brunton on, 35
 - during effort, 20
 - effort on, 35
 - exercises of endurance on, 37
 - Janeway on, 35
 - McCurdy on, 30
 - Stephens on, 35
 - variations of, 35
- Bolin, Jakob, on constipation, 362
- on examination for scoliosis, 282
 - on paralysis, 376
- Bowen on blood-pressure, 317
- on pulse-rate and temperature in exercise, 37
- Brackett on bed-posture, 280
- Branting, 88-90
- Breathlessness, facial expression of, 23
- head poise in, 24
- Brehmer's rule, 227
- Brookline, municipal baths of, 153
- gymnasium of, 153, 156
- Brown University, German gymnastics at, 82
- Brunton on blood-pressure, 35
- on high tension in arteries, 323
 - on muscular contraction, 31
- Burgdorf, Spiess at, 80
- Butler on deep breathing, 234
- CALL, Anna Payson, on Delsarte, 115-117, 118
- Case-reports on scoliosis, 305
- Central Institute, founding of, 87, 90
- Chautauqua, summer school at, 101
- Chest expansion, exercises for, 228
- Cheyne, case-report of, 355
- Chiasso, Captain, on polymachinon, 56, 57
- Chicago University, physical education at, 176
- Child, normal activity of, 158
- Chorea, 380
- treatment of, 381
- Circulation, influence of games on, 126, 127
- City homes, condition of, 140
- Clark, E. E., on falsetto voice, 380
- Class work, exhilaration from, 130
- progression in, 189
- Clifford-Albutt on heart-strain, 310
- College gymnasium, equipment of, 185
- life, physical effects of, 181
 - of City of New York, physical education at, 176
 - yearly course in exercise, 186
- Columbia University, summer school at, 101
- Concentration of attention, 21
- Conditioning, effects on fatigue, 33
- Constipation, Bolin on, 362
- exercise for, 301
 - frequency of, 360
 - massage in, 226
 - Zander on, 362
- Copenhagen, 75
- Cornwall miners, arteriosclerosis in, 322
- Correspondence schools of exercise, 110
- advantages of, 120
 - dangers of, 121
- Crime, juvenile, 138
- Criminals, characteristics of, 217-220
- Wey on, 220
- Curtain ball, Sargent's, 128
- Curves of normal spine, 250
- DAILY exercise, Gulick on, 134
- set of free exercises, 134
- Darmstadt normal school, 80

- Darwin, 20
- Day's order, Ling's, 93
origin of, 91
- Deaf-mutes, balance movements for, 207
exercise for, 206
games for, 209
longevity of, 208
measurements of, 205-209
physical peculiarities of, 205
- Deep breathing, Butler on, 234
exercises for, 228
- Deformed scapula, Goldthwait on, 266
- Deformities of foot, 230
- Delinquents, military drill for, 217
physical education for, 217
- Delsarte, Anna Payson Call on, 115, 117, 118
Bishop on, 115-117
Gerald on, 115
Giraudet on, 115
life of, 114, 115
Stebbins on, 115-117
sayings of, 115
Steele Mackaye on, 115
system of, 115
- Dessau, 74
- Developing apparatus, Goldie's, 62
Sargent's, 60, 61
- Diabetes, exercise for, 357
Finkler on, 357
- Diagnosis of arteriosclerosis, 324
of flat-foot, 242
- Dilatation of heart, 317
Roy and Adami on, 317
- Du Bois-Réymond, 81
- Dullards, improvement of, 221
physical training for, 220
- Dumb-bell, Sandow's spring, 118, 119
- Dumb-bells used by Greeks, 57
- Dyspepsia, exercise in, 300
nervous Weir Mitchell on, 300
- EBERTHART on vibrators, 71
- Eccles on massage in sciatica, 371
on neuralgia, 372
- Edinger's theory of locomotor ataxia, 382
- Education of immigrants by playgrounds, 140
- Efficurage, description of, 50
- Effort, blood-pressure during, 20
economy in, 30
effect on muscles, 21, 22
exercises of, 18
muscle rupture from, 30
on blood-pressure, 35
qualities cultivated by, 21
- Elmira State Penitentiary, 220
- Emerson, C. W., exercises of, 118
- Endurance, exercises of, 18
- Enbuske, Claes, 93
- Equipment of college gymnasium, 185
of large playground, 150
of school gymnasiums, 197
of small playground, 142
- Erector spinae, action of, 207
- Evolution in play, 124
- Examination for scoliosis, 282
Bolin on, 282
of athletes, 100
of back, 254
of flat-foot, 241
of obesity, 348
physical, of students, 176
- Exercise, active, 17
automatism in, 41
class credit for, 181
correspondence schools of, 110
daily, Gulick on, 134
definition of, 17
for ataxia, 385, 380
for blind, 105, 107
for constipation, 361
for deaf-mutes, 206
for diabetes, 357
for gout, 350
for heart, Bezly Thorne on, 325-320
Heineman on, 325, 345
weakness, 225
for hernia, 306
for scoliosis, 204
for sedentary occupations, 134
for tuberculosis, 227
free, daily set of, 134

- Exercise in anemia, 226
 in college, Benjamin Franklin on, 174
 Jefferson on, 174
 in dyspepsia, 360
 in gastritis, 359
 in morning, 134
 in old age, 130
 in pathological conditions, 222
 instruction in theory of, 191
 of endurance for gout, 226
 passive, 17, 27
 effects of, 28
 in fatigue, 27
 on atrophy, 31
 periods in school, 194
 prescription for scoliosis, 300
 tonic effect of, 226
 yearly course, in college, 186
- Exercises for abdominal control, 220
 for chest expansion, 228
 for flat-foot, 292
 for heart, Satterthwaite on, 343
 for nervous diseases, 226
 for obesity, 352
 for round shoulders, 257
 gymnastic, physiological classification,
 129
 of deep breathing, 228
 of effort, 18
 of endurance, 18
 description of, 22
 effects of, 31
 excess in, 22
 fatigue products in, 22
 on blood-pressure, 37
 on heart, 38
 qualities cultivated by, 22
 of skill, 18
 school, 81
- Exhaustion, 26
 from alertness, 40
- Expectation of life, Farr's tables on, 321
- Eye examinations of students, 170
- FACIAL expression as index, 21
 of breathlessness, 23
 of effort, 19
- Facial expression of fatigue, 24
 of rage, 20
 of strain, 20
- Fahrner on fatigue at school, 279
- Farr's tables of expectation of life, 321
- Fatal touch, Japanese 107
- Fatigue, acute, 23, 33
 chronic, 26
 facial expression of, 24
 fever, 44
 general, 24
 effects of, 25
 in ataxia, 391
 massage in, 49, 223
 passive exercises for, 27
 poise of head in, 25
 products, intoxication by, 41
 Lee on, 43
 relative, 39
 scoliosis of, 278
 subacute, 26
 temperature in, 26
- Faulty attitude, varieties of, 252
- Feeble-mindedness, physical signs of, 210
- Fellenberg, 74
- Fernald, 211-213
- Finkler on diabetes, 357
- Finsen, 75, 76
- Fitz, George W., on round shoulders, 255
 on bed-posture in scoliosis, 280
 on round shoulders, 263
 method of measurement in scoliosis,
 283
- Flat-foot, cause of, 238
 diagnosis of, 242
 examination of, 241
 exercises for, 242
 frequency of, 240
 Ochsner's bandage for, 248
 record of, 241
 Roth on, 246
 shoe for, 246
 symptoms of, 239, 240
 treatment of, 242
 Whitman's foot-plate for, 247
- Folk-dancing in playgrounds, 152
- Follen at Harvard, 82, 175

- Food and muscular waste, 41
- Foot, deformities of, 236
lateral arch of, 238
structure of, 236
- Foot-ball players, weight of, 180
- Frankfort, turnfest at, 79
- Franklin, Benjamin, on exercise in college, 174
Field, 184
- Frenkel on ataxia, 384
- Friction, description of, 51
- Froebel, So., 124
- GALEN on massage, 30
- Games, age limit in, 125
classification of, 126, 127
collections of, 164
for blind, 168
for deaf-mutes, 209
gymnastic, 128
in recess, 163
influence on circulation, 126, 127
muscles used in, 126, 127
nerve control required in, 126, 127
popularity of children's, 122
therapeutic effects of, 128
- Gang instinct in boys, 123
- Garber's adjustable desk, 160
- Garland, 152
- Gastritis, exercise in, 359
massage in, 226
- Georgii, 88-90
- Geraldly on Delsarte, 115
- German gymnastics, first manual of, 75
in America, 82
system, history of, 74
peculiarities of, 84
Stecher's classification, 83
- Giessen, Spiess' work at, 80
- Giraulet on Delsarte, 115
- Glen Mills, school at, 218, 219
- Goldie's exerciser, 62
- Goldthwait on deformed scapula, 266
on round shoulders, 255, 256
- Goldthwait's apparatus for round shoulders, 263
- Gould on causation of scoliosis, 275-277
- Gould on writing position, 202
- Gout, exercise for, 356
treatment of, 226
- Graham, Douglas, on rheumatism, 358
on sciatica, 371
- Granville J. Mortimer's theory of pain, 372
- Granville's percutor, 372
- Green, Grace, 208
on deaf girls, 205
- Greenwood on normal posture, 252
- Gulick on athletic league, 168
on daily exercise, 134
on games, 122, 123
on play traditions, 164
- Guts-Muths, 74, 75, 80
- Gymnasium construction for blind, 195
first public, 82
- Gymnasium-school, equipment of, 167
- Gymnastic apparatus, classification of, 120
for mental defectives, 212
formal, in child-training, 124
in playgrounds, 150
institute in Berlin, 81
lesson, arrangement of, 130
medical, beginnings of, 88
school, beginnings of, 88
Swedish medical, 103
- HARTIUS, 90
- Hartwell, 93
- Harvard, Follen at, 175
- Hawk on blood-count, 31
- Heart, Bezly Thorne on exercise for, 325-329
dilatation of, 317
diseases of, 315
action of exercise in, 325
Wide on massage for, 325
exercises of endurance on, 38
Satterthwaite on, 313
growth, Benke on, 38
Heineman on exercise for, 325-345
murmurs in athletes, Stengel on, 319
of oarsmen, 320
overstrain of, 317

- Heart, prognosis of exercise treatment for, 345
 strain, Clifford-Albutt on, 319
 Schott on, 317
 valvular defects of, 315
 weakness, exercise for, 225
- Heat, regulation of, 29, 30
- Heineman on heart exercise, 325-345
- Hemenway Gymnasium, 175
 Mrs. Mary, 62
- Henry, Admiral, case-report of, 359
- Hermann, rout of, 76
- Hernia, 362
 anatomy of, 363
 diagnosis of, 363
 exercise for, 366
 Seaver's truss for, 365
 support for, 365
- High tension, Brunton on, 323
- Hippocrates on conditioning, 44
- Hitchcock at Amherst, 175
 on measurements, 101
- Hokusai, sketches of, 105
- Homans, Miss Amy M., 93
- Hooker at Amherst, 175
- Horizontal bar controversy, 81
- IDEAL college athlete, 103
- Indianapolis, college at, 82
- Inomotor, Sargent's, 64
- Intoxication of fatigue-products, 41
- JAHN, 74-77, 80
- Janeway on blood-pressure, 35
- Jefferson on exercise in college, 174
- Jiu jitsu, dangers of, 113
 introduction in America, 108
 knowledge of anatomy in, 100-112
 modifications of, 108
 O'Brien on, 108, 111, 113
 origin of, 104
 secrets of, 106
- Judo, 104
- Juggling, physiology of, 21
- KANO school in Tokyo, 108
- Keynote position, Roth's, 282, 295
- Kidneys, action of, in elimination, 44
- Kindergarten, games of, 161
- Kinghorn on phthisis, 227
- Kitson, H. H., 192
- Kuatsu, art of, 104, 106, 107
- LAGRANGE, 328
- Larabee on Marathon runners, 320
- Latent period, 30
- Lee, F. S., on fatigue-products, 43
 J. E., 137
- Lefebure on day's order, 101
- Lever, principle of, 69
- Lieber, 77-82
- Liedbeck, 88
- Ling, Hjalmar Frederick, 90
 honors awarded to, 88
 literary activity of, 87, 88
 on massage, 40
 Peter Henry, 74, 81, 86
 life of, 86
 physiology of, 80
- Lip reading, teaching of, 206
- Locomotor ataxia, definition of, 382
 Edinger's theory of, 382
- Lombard on weight loss, 42, 43
- Longevity of oarsmen, Meylan on, 321
- Lovett's apparatus in round shoulders, 261, 265
 measurement of round shoulders, 251
- Lund, University of, 86, 87
- Lung capacity, rapid increase of, 312
- MACDONALD Smith on full contraction, 117, 118
- Machine, McKenzie's, for scoliosis measurement, 284, 285
- Maggiore, experiment of, on massage, 47-49
- Makuen on artistic breathing, 378
- Marathon race, 44
 Blake and Larabee on, 320
- Mason, J. L., 154-156
- Massage, action on muscles, 47
 as stimulant, 222
 automatic, 30
 classification of, 5

- Massage**, definition of, 45
 derivation of, 45
 duration of, 55
 effects of, 38
 for fatigue, 40
 for heart disease, Wide, 325
 for muscle wasting, 31
 for obesity, 225
 for rheumatism, 358
 general, 54
 history of, 45
 for constipation, 226
 for fatigue, 222
 for gastritis, 226
 in Greece, 45
 in Japan, 45
 on nervous system, 41
 for neuritis, 371
 for obesity, 352
 for rheumatism, 226, 358
 for sciatica, 371
 for sprains, 222
 Ling on, 46
 Maggiora's experiments on, 47-49
 mechanical effects of, 49
 Mezgar on, 49
 precautions in, 55
 requirements of, 49
 McCurdy on blood-pressure, 36
 McKenzie's machine for measurement of scoliosis, 284, 285
Measurement, Fitz's method, in scoliosis, 283
 McKenzie's method in scoliosis, 284, 285
 of blind, 105
 of deaf-mutes, 205-209
 Roth's method, in scoliosis, 283
 Schulthess' machine for, 283, 284
 Spellissy's method, in scoliosis, 283
Mechanotherapy in America, 71
Medical gymnastics, supervision in, 235
 Swedish, 103
 Melville Bell on stammering, 378
Mental defectives, Barr on, 214
 diagnosis for, 212
 gymnastics for, 212
 habits of, 211
 management of, 211
 military drill for, 214
 proportions of, 210
 schools for, 212
 Tadd on, 216
 Warner on, 211
 Meylan, Geo. L., 157
 on longevity of oarsmen, 321
 Mezgar on massage, 49
Military drill for delinquents, 217
 for mental defectives, 214
 gymnastics, Swedish, 64
Mind and body, 83
 Mitchell on ataxia, 302
 on blood changes from massage, 32
 on blood-count, 227
 Montrichard, 86
 Morgan on survival of oarsmen, 321
 Mosher on standing posture, 165
 Mosso's plethysmograph, 31, 32
 Mount Airy, 208
 institution for deaf-mutes, 266
Movements, automatic, 39
 brain, control of, 39
 necessity for natural, 40
 spontaneous, in infants, 122
 Muller on fifteen minutes daily exercise, 134
 Murray, 61
Muscles, action of massage on, 47
 of spine, 274
 overdevelopment of, 22
 ruptured, cause of, 30
 from effort, 30
 soreness, cause of, 20
 tonus, 29
 used in games, 126, 127
Muscle-wasting, massage for, 31
Muscular action, isolation in treatment of scoliosis, 269
 contraction, Brunton on, 31
 description of, 29
 effects of, 29
 NACHIGALL, 74, 75, 86, 87
 Nephritis from fatigue, 44

- Nervous diseases, exercises for, 226
 dyspepsia, Weir Mitchell on, 360
- Neuralgia, Balfour on, 372
 Eccles on, 372
- Neurasthenia, treatment of, 376
 Weir Mitchell on, 376
- Neuritis, massage in, 371
- Neuroses of occupation, 372
 treatment of, 373
- New York City, overcrowding in, 137
- Newark Athletic League, 173
- Newton on blood-pressure, 35
- Nibecker, 221
- Nissen, 92
- Nyblaeus, Col. Gustave, 90
- OARSMEN**, hearts of, 320
 Meylan on longevity of, 321
 Morgan on survival of, 321
 mortality of, 321
 weight of, 180
- Obesity, causes of, 346
 complications of, 340
 degrees of, 308
 diet in, 351
 examination of, 348
 exercises for, 352
 Anders on, 346
 local, 346
 massage in, 225
 prognosis in, 348, 355
 rapid reduction of, 352
 reduction cures for, 350
 thyroid extract in, 354
 treatment of, 225
 Von Noorden on massage for, 352
- O'Brien, J. J., on jiu jitsu, 108, 111, 113
- Occupation disorders, 225
 evil effects of, 133
 neuroses of, 373
- Ochsner's bandage for flat-foot, 248
- Oertel's cure, 325, 326
 at Reichenhall, 328
 limitations of, 328
 experiments, 327
- Old age, exercise in, 130
- Orton, George, 157
- Overcrowding in New York City, 137
- Overtraining, effects of, 26
- PAIN** organ, 73
- Pantograph, tracings by, 253
- Parallel bars controversy, 81
- Paralysis, Beevor's tests for, 374
 Bolin on, 376
 infantile, 373
 regions involved, 374
 prognosis of, 370
 treatment of, 370
- Pathological conditions, exercise in, 222
- Peacock on arteriosclerosis, 322
- Pelvic girdle, structure of, 250
- Pentathlon, 74
- Percussion, 52
- Percutor, Granville's, 372
- Pestalozzi, 70, 80
- Petrissage, description of, 52
- Philadelphia Playgrounds Association, 173
- Philanthropinum, 74
- Phillips on sprinters, 102
- Phthisis, Kinghorn on, 227
- Physical education at Amherst, 175
 at Chicago University, 176
 at College of New York, 176
 at Harvard, 175
 at University of Pennsylvania, 176
 for blind, 105
 fundamental principles of, 182
 research in, 191
 ideal, 103
 intelligence, value of, 182
 limitations of blind, 194
 peculiarities of deaf-mutes, 205
 training for delinquents, 217
 for dulness, 220
- Physiological load, law of, 57
- Piano playing, 21
- Pilgrim on vibration, 71-73
- Platysma, action of, 10, 20
- Play, evolution in, 124
- Playground Association, American, 82
 German, 82

- Playground Committee, New York, work of, 137
 effect on emigrants, 140
 equipment of, large, 150
 private house, 143
 small, 142
 folk-dancing in, 152
 gymnastics in, 150
 how founded, 140
 plan of, 148
 Philadelphia, 173
 public school, 144, 147, 152
 roof, 167
 round games in, 152
 supervision of, 150
 swimming in, 152
 types of, 141
- Plethysmograph, Mosso's, 31, 32
- Polymachion, Chiasso's, 59, 57
- Posse, 91, 93
 gymnasium, 93
- Posture, correct sitting, 161
 standing, 165
 defects of, 225
 exercise for, 224
 faulty, varieties of, 252
 in school, 160
 normal, Greenwood on, 252
 standing, change of spine in, 250
 Mosher on, 165
 Roberts on, 250
 spinal curve in, 250
- Presence of mind, 40
- Prognosis in ataxia, 302
 in exercise treatment for heart, 345
 in obesity, 348, 355
 in paralysis, 379
 in round shoulders, 256
- Prolongation of life, Weber on, 131
- Psoas, isolation of, 209
- Public School Athletic League, girl's
 branch, 172
 grounds of, 172
- Pulley-weights, dangers of, 93
 description of, 58, 62
 limitations of, 63
 Pulley-weights, principle of, 57, 58
 Pulse rate in exercise, Bowen on, 37
 Zander on reducing, 325
- QUARTER CIRCLE, 59, 60
- Rwat, facial expression of, 20
- Record of flat foot, 241
- Reichenhall, Oertell's cure at, 328
- Research in physical education, 191
- Respiration, artificial, 233
 Japanese, 167
 chemistry of, 33
- Rheumatism, Douglas Graham on, 358
 massage in, 226, 358
 vibration for, 358
- Rifle shooting in schools, 170
- Riva-Rocci sphygmomanometer, 35
- Roberts on standing posture, 250
- Rogers on astigmatism in scoliosis, 276
- Romberg's symptom of ataxia, 383
- Roth, Bernard, 90
 on flat-foot, 240
 on method of measurement in scoliosis, 283
 Matthias, 90
- Roth's keynote position, 282, 295
- Rothstein, 81, 80
- Round back, tracings of, 253
 shoulders, causes of, 254
 definition of, 251
 diagnosis of, 256
 exercises for, 257
 Fitz on, 255, 263
 frequency of, 255
 Goldthwait on, 255, 256
 Goldthwait's apparatus for, 263
 Lovett's apparatus for, 264, 265
 measurement of, 251
 prognosis of, 256
 treatment of, 256
 Zander's tower for, 262
- Rousseau, 74
- Roy and Adami on dilatation of heart, 317
- Running, change of pace in, 27
 long-distance, 26

- SALZMAN, 74
- Samauri, order of, 104, 105
- Sandow's spring dumb-bell, 118, 119
- Sandpile, care of, 144
- Sargent, Dudley A., at Harvard, 175
 on curtain ball, 128
 on developing apparatus, 60, 61
 on inomotor, 64
 on measurements, 191, 193
 on pulley weights, 57-61
- Satterthwaite's exercises for heart, 343
- Sayre's sling, 304
- Schnepfenthal, school of, 74
- Schoolboys, examination of, 173
- School, rules for construction of desk,
 293
 for mental defectives, 212
 furniture, adjustable, 150
 as apparatus, 166
 rules for, 150
 gymnasium, equipment of, 167
 house, construction of, 158
 life and scoliosis, 279
 posture in, 160
 recess, 163
 room, graded work in, 165
 lighting of, 204
 fatigue, Fahrner on, 279
 seating, Scudler on, 158
- Schott on heart-strain, 317
 treatment at Bad Nauheim, 328
 description of, 328
- Schulthess' machine for measurement of
 scoliosis, 283, 284
- Schwannrede, Jahn's, 77
- Schwann's law of muscular contraction,
 69
- Sciatica, Eccles on massage for, 371
 Graham on, 371
 vibration for, 371
- Scoliosis and school-life, 279
 bed-posture in, 280
 Bolin on examination, 282
 case-reports, 305
 causes of, 275
 development of thorax in, 312
 diagnosis of, 286
- Scoliosis, examination for, 282
 exercise for, 294
 experimental, 281
 Fitz's method of measurement, 283
 frequency of, 274
 Gould on causation of, 275-277
 isolation of muscular action in treat-
 ment of, 296
 measurement of, 283
 of fatigue, 278
 prescription of exercise for, 300
 prognosis of, 290
 Roth's method for measurement of,
 283
 Roger's on astigmatism in, 276
 Schulthess' machine for measurement,
 283, 284
 Spellissy's method of measurement,
 283
 symptoms of, 289
 treatment of, 291
 varieties of, 288
- Scudler on school seating, 158
- Seaver on measurements, 191
- Seaver's truss for hernia, 305
- Second wind, 24
- Sedentary occupations, exercise for, 134
- Self-massage on nutrition, 31
- Sex, in play, 124
- Shaking, description of, 53
- Shaw on school day, 161
- Shoulder-girdle, structure of, 250
- Shoulders, forward displacement of, 253
 uneven, 266
 causes of, 267
 prognosis of, 270
 treatment of, 267
- Sillow, 61
- Singing with gymnastics, 81
- Skill, exercises of, 18
 progression in, 40
- Small shoe for flat-foot, 246
- Social center, Chicago, 150
- Speech, mechanism of, 378
- Speed-skaters, measurements of, 193
- Spellissy's photographic method for
 measurement in scoliosis, 283

- Sphygmomanometer, Stanton's, 34
- Spieß, 74, 80
- Spinal assistant, Taylor's, 262, 264
 curve change in standing posture, 25
- Spine, infantile, shape of, 250
 movements of, 272
 muscles of, 271
 normal, curves of, 252
- Sporting Times, founding of, 91
- Sports, analysis for class use, 185
- Sprains, massage in, 222
- Sprinters, Phillips on, 102
- Stagg on weight reduction, 352
- Stairway, Von Leyden's, 385, 386
- Staleness, 22, 41
- Stammering, 377
 Bell on, 378
 frequency of, 378
 treatment of, 379
- Standing attitude, normal, 251, 252
- Stanton's sphygmomanometer, 34
- Starr Garden Playground, plan of, 147
- Stebbens on Delsarte, 115-117
- Stecher, Wm. A., 83
- Steele Mackaye on Delsarte, 115
- Stengel, heart-murmurs in athletes, 310
- Stephens on blood-pressure, 35
- Stewart on ataxia, 383
- Stokes, 325, 326
- Strain, facial expression of, 20
- Striking, 52
- Stroking, description of, 50
- Students, eye examinations of, 170
 physical defects in, 177
 excess of, 170
- Subtarget machine, 170
- Summer camps for city children, 157
 Y. M. C. A., 157
 schools, 161
 at Chatauqua, 161
 at College of City of New York, 161
- Supervision in medical gymnastics, 233
- Sylvester on artificial respiration, 261
- Symptoms of flat-foot, 230, 240
- Swedish apparatus, 121
 gymnastics introduced in United States, 61
- Swedish gymnastics, imitations of, 100
 military, 94
 medical gymnastics, 1-3
 system, characteristics of, 94
- Swimming in playgrounds, 152
- TADD on drawing for defectives, 219
- Tapotement, description of, 52
- Taylor on developing apparatus, 70
- Taylor's "spinal assistant," 262, 264
- Tchow, 80
- Temperature during exercise, Bowen on, 37
 rise of, in muscular action, 29
- Tendon, strain of, 30
- Therapeutic effects of games, 128 ✓
- Thorax, corsion of, 209
- Thyroid extract in obesity, 354
- "Tidskrift i Gymnastik," 90
- Torngren, 61
- Tournaments, dates of, 76
- Treatment of round shoulders, 250
 of scoliosis, 261
 of uneven shoulders, 270
- Tremble-pressing, description of, 54
- Tuberculosis, exercise for, 227
- Turnfest at Frankfort, 70
- Turngemeinden in America, 82
- Turning in German Universities, 76
- Turnkunst, badge of, 76
- Turnplatz, first, 75
- Turnvereine, descriptions of, 70
- UNIVERSITY oars, Morgan on, 321
 of Pennsylvania, 31, 42
 physical education at, 170
- Urbanization of population, 132
- VALVULAR defects of heart, 315
- Van de Walker on the blind, 109
- Vibration, 53
 application of, 71
 for rheumatism, 358
 for sciatica, 371
 Pilgrim on, 71, 73
 theory of, 73

- Vibrators, Eberhart on, 71
 modifications of, 70
 Zander's, 70
- Virchow, 81
- Von Leyden's stairway, 385, 386
- Von Noorden, 225
 on massage in obesity, 352
- Von Schenkendorff, 82
- WADING pool, 152
- Walking, rate of, 124, 125
- Warner on mental defectives, 211
- Washington Gardens, gymnasium at, 82
- Water-polo, effect on blood, 32
- Weber on prolongation of life, 131
- Weight, loss of, 42
 Lombard on, 42, 43
 of foot-ball players, 180
 of oarsmen, 180
 reduction, dangers of, 355
 Stagg on, 352
- Weir Mitchell, 31, 55
 on nervous dyspepsia, 360
 on neurasthenia, 370
- Wellesley and Boston Normal School, 03
- Wey on criminals, 220
- Wide on massage for heart disease, 325
- Williams College, 142
 German gymnastics at, 82
- Whitman's foot-plate for flat-foot, 247
- Witmer on pain organ, 73, 370
- Writing position, 160
 Gould's, 292
- YALE University, German gymnastics
 at, 82
- Yoshin-Riu, 104
- ZANDER, 17, 54
 history of, 66
 institutes, 66
 machines, 66-70
 advantages of, 70
 on constipation, 362
 on reducing pulse-rate, 325
- Zander's tower, 234
 for round shoulders, 262
 vibrator, 70

Done
Loaned

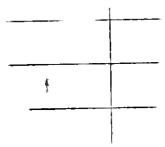

BOSTON UNIVERSITY
1 1719 01579 4789

DO NOT REMOVE

CHARGE SLIP FROM THIS POCKET
IF SLIP IS LOST PLEASE RETURN BOOK
DIRECTLY TO A CIRCULATION STAFF MEMBER

